

Contents

Chapter 1: The Orientation and History of the Fire Service	1
Chapter 2: Fire Fighter Safety	4
Chapter 3: Personal Protective Equipment and Self-Contained Breathing Apparatus	7
Chapter 4: Fire Service Communications	11
Chapter 5: Incident Command System	14
Chapter 6: Fire Behavior	16
Chapter 7: Building Construction	19
Chapter 8: Portable Fire Extinguishers	21
Chapter 9: Fire Fighter Tools and Equipment	27
Chapter 10: Ropes and Knots	30
Chapter 11: Response and Size-Up	38
Chapter 12: Forcible Entry	41
Chapter 13: Ladders	45
Chapter 14: Search and Rescue	53
Chapter 15: Ventilation	58
Chapter 16: Water Supply	67
Chapter 17: Fire Attack and Foam	74
Chapter 18: Fire Fighter Survival	79
Chapter 19: Salvage and Overhaul	83
Chapter 20: Fire Fighter Rehabilitation	87
Chapter 21: Wildland and Ground Fires	90
Chapter 22: Fire Suppression	93
Chapter 23: Preincident Planning	100
Chapter 24: Fire and Emergency Medical Care	105
Chapter 25: Emergency Medical Care	108
Chapter 26: Vehicle Rescue and Extrication	114
Chapter 27: Assisting Special Rescue Teams	119
Chapter 28: Hazardous Materials: Overview	123
Chapter 29: Hazardous Materials: Properties and Effects	126
Chapter 30: Hazardous Materials: Recognizing and Identifying the Hazards	130
Chapter 31: Hazardous Materials: Implementing a Response	134
Chapter 32: Hazardous Materials: Personal Protective Equipment, Scene Safety, and Scene Control	136
Chapter 33: Hazardous Materials: Response Priorities and Actions	141
Chapter 34: Hazardous Materials: Decontamination Techniques	144
Chapter 35: Terrorism Awareness	148
Chapter 36: Fire Prevention and Public Education	151
Chapter 37: Fire Detection, Protection and Suppression Systems	156
Chapter 38: Fire Cause Determination	159

Answer Key

Photo composite of flames: © Photos.com

Chapter 1: The Orientation and History of the Fire Service

Matching

1. B (page 16)
2. D (page 5)
3. J (page 14)
4. H (page 11)
5. F (page 16)
6. G (page 5)
7. I (page 6)
8. A (page 11)
9. E (page 6)
10. C (page 12)

Multiple Choice

1. C (page 8)
2. D (page 8)
3. D (page 18)
4. C (page 11)
5. A (page 11)
6. C (page 12)
7. A (page 17)
8. B (page 11)
9. D (page 16)
10. A (page 12)
11. C (page 12)
12. B (page 13)
13. C (page 14)
14. C (page 17)
15. C (page 16)
16. D (page 8)
17. A (page 17)
18. A (page 10)
19. A (page 13)
20. C (page 11)

Vocabulary

1. **Safety officer:** The safety officer watches the overall operation for unsafe practices. He or she has the authority to halt any firefighting activity. (page 6)
2. **Paramedic:** A Paramedic has completed the highest level of training in EMS. These personnel have extensive training in advanced life support, including IV therapy, administering drugs, cardiac monitoring, inserting advanced airways, manual defibrillation, and other advanced assessment and treatment skills. (page 7)
3. **Incident commander (IC):** The incident commander is the individual responsible for the management of all incident operations. This position focuses on the overall strategy of the incident and is often assumed by the battalion/district chief. (page 6)
4. **Company officer:** The company officer is usually a lieutenant or captain in charge of a team of fire fighters, both on the scene and at the station. The company officer is responsible for firefighting strategy, safety of personnel, and the overall activities of the fire fighters or their apparatus. (page 6)
5. **Training officer:** The training officer is responsible for updating the training of current fire fighters and for training new fire fighters. He or she must be aware of the most current techniques of firefighting and EMS. (page 6)

Fill-in

1. geographic (page 11)
2. incident command system (page 7)
3. Standard operating procedures (SOPs) (page 8)
4. thatched roofs, wood chimneys (page 13)
5. Emergency Medical Services (page 7)
6. Benjamin Franklin (page 13)
7. fire hydrants (page 16)
8. Romans (page 16)
9. public call boxes (page 16)

True/False

- | | |
|------------------|-----------------|
| 1. T (page 11) | 6. F (page 12) |
| 2. T (page 13) | 7. F (page 11) |
| 3. F (page 13) | 8. F (page 7) |
| 4. F (pages 5–6) | 9. T (page 18) |
| 5. T (page 13) | 10. T (page 14) |

Short Answer

- Companies common to most fire departments include (*Students should include five of the following*): (1) *Engine company*: An engine company is responsible for securing a water source, deploying handlines, conducting search-and-rescue operations, and putting water on the fire. (2) *Truck company*: A truck company specializes in forcible entry, ventilation, roof operations, search-and-rescue operations above the fire, and deployment of ground ladders. They are also called ladder companies. (3) *Rescue company*: A rescue company usually is responsible for rescuing victims from fires, confined spaces, trenches, and high-angle situations. (4) *Brush company*: A brush company is dispatched to woodland and brush fires that larger engines cannot reach. (5) *Hazardous materials company*: A hazardous materials company responds to and controls scenes involving spilled or leaking hazardous materials. (6) *Emergency Medical Services (EMS) company*: An EMS company responds to and assists in transporting medical and trauma patients to medical facilities for further treatment. EMS personnel often have medications, defibrillators, and other equipment that can stabilize a critical patient during transport. (pages 8–10)
- Regulations* are developed by various government or government-authorized organizations to implement a law that has been passed by a government body. *Policies* are developed to provide definite guidelines for present and future actions. Fire department policies outline what is expected in stated conditions. Policies often require personnel to make judgments and to determine the best course of action within the stated policy. *Standard operating procedures (SOPs)* provide specific information on the actions that should be taken to accomplish a certain task. SOPs provide a uniform way to deal with emergency situations. They are vital because they enable everyone in the department to function properly and know what is expected for each task. (page 8)
- The four basic management principles utilized in most fire departments are: (1) Unity of command; (2) Span of control; (3) Division of labor; (4) Discipline (page 12)
- Common and/or specialist positions a fire fighter may assume in his or her career as a fire fighter include (*Students should include ten of the following*): (1) *Fire fighter*: The fire fighter may be assigned any task from placing hose lines to extinguishing fires. Generally, the fire fighter is not responsible for any command functions and does not supervise other personnel, except on a temporary basis when promoted to an acting officer. (2) *Driver/operator*: Often called an engineer or a technician, the driver is responsible for getting the fire apparatus to the scene safely, as well as setting up and running the pump once it arrives on the scene. (3) *Company officer*: This is usually a lieutenant or captain in charge of a team of fire fighters. This person is in charge of the company both on scene and at the station. The company officer is responsible for initial firefighting strategy, personnel safety, and the overall activities of the fire fighters on their apparatus. Once command is established, the company officer focuses on tactics. (4) *Safety officer*: The safety officer responds to scenes and watches the overall operation for unsafe practices. He or she has the authority to stop any firefighting activity until it can be done safely and correctly. (5) *Training officer*: The training officer is responsible for updating the training of current employees and for training new fire fighters. (6) *Incident commander*: The incident commander is the individual responsible for the management of all incident operations. (7) *Fire marshal/fire inspector/fire investigator*: Fire marshals inspect businesses and enforce public safety laws and fire codes. They may respond to fire scenes to help investigate the cause of a fire. (8) *Fire and life safety education specialist*: This person educates the public about fire safety and injury prevention, and presents juvenile fire safety programs. (9) *911 dispatcher/telecommunicator*: From the communications center, the dispatcher takes the calls from the public, sends appropriate units to the scene, assists callers with emergency medical information, and assists the incident commander with needed resources. (10) *Fire apparatus maintenance personnel*: Apparatus mechanics repair, service, and keep fire and EMS vehicles ready to respond to emergencies. (11) *Fire police*: Fire police are usually fire fighters who control traffic and secure the scene from public access. Many fire police are sworn peace officers as well as fire fighters. (12) *Information management*: “Info techs” are fire fighters or civilians who take care of a department’s computer and networking systems. (13) *Public information officer*: The public information officer serves as a liaison between the incident commander and the news media. (14) *Fire protection engineer*: The fire protection engineer

Fire Alarms

1. During this course of study, you will need to practice and work hard. Do your best. Five guidelines will help to keep you on target to become a proud and accomplished fire fighter: (1) *Be safe*. Safety should always be uppermost in your mind. Keep yourself safe. Keep your teammates safe. Keep the public you serve safe. (2) *Follow orders*. Your supervisors have more training and experience than you do. If you can be counted on to follow orders, you will become a dependable member of the team. (3) *Work as a team*. Fighting fires requires the coordinated efforts of each department member. Teamwork is essential to success. (4) *Think!* Lives will depend on the choices you make. Put your brain in gear. Think about what you are studying. (5) *Follow the Golden Rule*. Treat each person, patient, or victim as an important person or as a member of your family. Everyone is an important person or family member to someone and deserves your best efforts.
2. Every member of the fire service will interact with the public. People may visit the fire station, requesting a tour or asking questions on specific fire safety issues. Fire fighters should be prepared to assist these visitors and use these opportunities to provide them with additional fire safety information. Use every contact with the public to deliver positive public relations and an educational message. Inform and encourage the use of wearing a helmet and explain the benefits.



Fire Fighter II in Action

1. Answers will vary.

Chapter 2: Fire Fighter Safety

Matching

- | | |
|----------------|----------------|
| 1. F (page 35) | 5. A (page 28) |
| 2. H (page 38) | 6. D (page 27) |
| 3. E (page 30) | 7. C (page 35) |
| 4. B (page 35) | 8. G (page 36) |

Multiple Choice

- | | |
|----------------|---|
| 1. B (page 36) | 8. B (page 27) |
| 2. D (page 37) | 9. D (page 27) |
| 3. A (page 30) | 10. B (page 28) |
| 4. C (page 31) | 11. A (page 28) |
| 5. B (page 35) | 12. D (page 29) |
| 6. C (page 38) |  13. C (page 31) |
| 7. D (page 27) |  14. A (page 29) |

Vocabulary

1. **Personnel accountability system:** A method of tracking the identity, assignment, and location of fire fighters operating at an incident scene. (page 35)
2. **Standard operating procedures (SOPs):** Written rules, policies, regulations, and procedures enforced to structure the normal operations of most fire departments. (page 27)
3. **Employee assistance program (EAP):** Fire service programs that provide confidential help to fire fighters with personal issues. (page 30)
4. **The 16 Firefighter Life Safety Initiatives:** In an effort to do more to prevent line-of-duty deaths and injuries, the National Fallen Firefighters Foundation has developed a fire fighter safety initiative called Everyone Goes

Home. The goal of this program is to raise awareness of life safety issues, improve safety practices, and allow everyone to return home at the end of their shift. In particular, the Everyone Goes Home program has developed “The 16 Firefighter Life Safety Initiatives,” which describe steps that need to be taken to change the current culture of the fire service to help make it a safer place for all. (page 29)

5. **Incident safety officer:** A designated individual who oversees safety practices at an emergency scene and during training. Safety officers have the authority to stop any activity that is deemed unsafe. (page 28)
6. **Buddy system:** A system in which two fire fighters always work as a team for safety purposes. (page 35)

Fill-in

- | | |
|--|---|
| 1. Vehicle (page 27) | 6. Near-Miss Reporting System (page 28) |
| 2. National Fallen Firefighters Foundation (page 28) | 7. an hour (page 28) |
| 3. Employee assistance programs (page 30) | 8. Heart disease (page 29) |
| 4. safety (page 28) | 9. freelancing (page 28) |
| 5. Safe driving practices (page 32) | 10. traffic regulations (page 31) |

True/False

- | | |
|----------------|-----------------|
| 1. F (page 30) | 6. F (page 35) |
| 2. T (page 30) | 7. T (page 31) |
| 3. F (page 28) | 8. T (page 31) |
| 4. T (page 28) | 9. T (page 35) |
| 5. T (page 35) | 10. F (page 36) |

Short Answer

1. The nine Guidelines for Safe Emergency Vehicle Response are (*Students should include five of the following*): (1) Drive defensively. (2) Follow agency policies in regard to posted speed limits. (3) Always maintain a safe distance. Use the “four-second rule”: Stay at least four seconds behind another vehicle in the same lane. (4) Maintain an open space or cushion in the lane next to you as an escape route in case the vehicle in front of you stops suddenly. (5) Always assume that other drivers will not hear your siren or see your emergency lights. (6) Select the shortest and least congested route to the scene at the time of dispatch. (7) Visually clear all directions of an intersection before proceeding. (8) Go with the flow of traffic. (9) Watch carefully for bystanders and pedestrians. They may not move out of your way or could move the wrong way. (page 33)
2. The purpose of a critical incident stress debriefing (CISD) is to provide a forum for firefighting and EMS personnel to discuss the anxieties, stress, and emotions triggered by a difficult call. (page 38)
3. Guidelines to stay safe, both on and off the job are: (1) You are personally responsible for safety. Keep yourself safe. Keep your teammates safe. Keep citizens—your customers—safe. (2) Work as a team. The safety of the entire firefighting unit depends on the efforts of each unit. Become a dependable member of the team. (3) Follow orders. Freelancing can endanger other fire fighters as well as yourself. (4) Think! Before you act, think about what you are doing. Many people are depending on you. (page 38)
4. The four major components of a successful safety program are: (1) Standards and procedures; (2) Personnel; (3) Training; (4) Equipment (page 27)
5. Three groups that fire fighters must always consider when ensuring safety at the scene are: (1) Their personal safety; (2) The safety of other team members; (3) The safety of everyone present at an emergency scene (page 27)

Word Fun

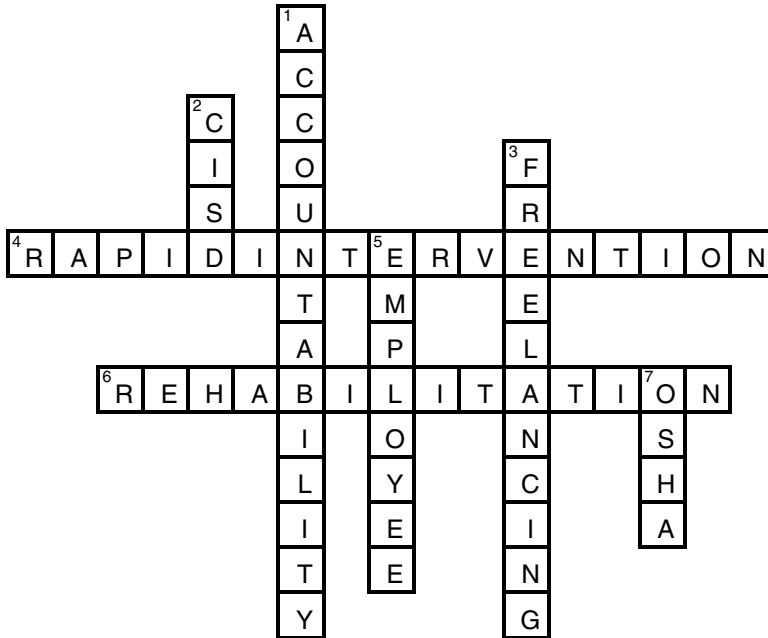

Fire Alarms

1. The National Fire Protection Association (NFPA) reports that each year, on average, 80 to 100 fire fighters are killed in the line of duty in the United States. These deaths occur at emergency incident scenes, in fire stations, during training, and while responding to or returning from emergency situations.

Approximately the same number of fire fighter deaths occurs on the fire ground or emergency scene as during training or while performing other nonemergency duties. Approximately one-fourth of all deaths occur while fire fighters are responding to or returning from alarms. Heart attack and stroke are the most common causes of fire fighter death due to injury.

Vehicle collisions are a major cause of fire fighter fatalities. For every 1000 emergency responses, it is estimated that one vehicle collision involving an emergency vehicle occurs. One study found that 39 percent of the fire fighters who died in those incidents were not using seat belts. Fire fighters should never overlook basic safety procedures, such as always fastening seat belts.

The NFPA estimates that 71,875 fire fighters were injured in the line of duty in 2010. Fewer than half of these injuries occurred while fighting fires. The most common injuries were strains, sprains, and soft-tissue injuries. Burns accounted for only 10 percent of the total injuries. Smoke and inhalation injuries accounted for 5 percent of all fire-ground injuries.



Fire Fighter II in Action

1. Answers will vary.

Chapter 3: Personal Protective Equipment and Self-Contained Breathing Apparatus

Matching

1. F (page 49)
2. D (page 78)
3. I (page 45)
4. A (page 46)
5. J (page 54)
6. B (page 51)
7. C (page 51)
8. E (page 78)
9. G (page 56)
10. H (page 61)

Multiple Choice

1. C (page 60)
2. A (page 46)
3. A (page 58)
4. C (page 56)
5. B (page 59)
6. C (page 70)
7. D (page 51)
8. C (page 46)
9. B (page 61)
10. A (page 56)
11. C (page 64)
12. A (page 55)
13. A (page 61)
14. B (page 75)
15. A (page 56)
16. D (page 54)
17. B (page 46)
18. D (page 59)
19. B (page 59)
20. D (page 55)

Vocabulary

- 1. Smoke Particles:** Smoke particles consist of unburned, partially burned, and completely burned substances. These particles are lifted in the thermal column produced by the fire and are usually readily visible. The completely burned particles are primarily ash; the unburned and partially burned smoke particles can include a variety of substances. The concentration of unburned or partially burned particles depends on the amount of oxygen that was available to fuel the fire.

Many smoke particles are so small that they can pass through the natural protective mechanisms of the respiratory system and enter the lungs. Some are toxic to the body and can result in severe injuries or death if they are inhaled. These particles also can prove extremely irritating to the eyes and digestive system. (page 55)
- 2. Oxygen deficiency:** Normal outside or room air contains approximately 21 percent oxygen. A decrease in the amount of oxygen in the air, however, may drastically affect an individual's ability to function. An atmosphere with an oxygen concentration of 19.5 percent or less is considered oxygen deficient. If the oxygen level drops below 17 percent, people can experience disorientation, an inability to control their muscles, and irrational thinking, which can make escaping a fire much more difficult.

During compartment fires, oxygen deficiency occurs in two ways. First, the fire consumes large quantities of the available oxygen, thereby decreasing the concentration of oxygen in the atmosphere. Second, the fire produces large quantities of other gases, which decrease the oxygen concentration by displacing the oxygen that would otherwise be present inside the compartment. (page 56)
- 3. National Institute for Occupational Safety and Health (NIOSH):** In the United States, the National Institute for Occupational Safety and Health (NIOSH) sets the design, testing, and certification requirements for SCBA. NIOSH is a federal agency that researches, develops, and implements occupational safety and health programs. It also investigates fire fighter fatalities and serious injuries and makes recommendations on how to prevent accidents from recurring. (page 57)

4. **Immediately dangerous to life and health (IDLH):** Any condition that would pose an immediate or delayed threat to life, cause irreversible adverse health effects, or interfere with an individual's ability to escape unaided from a hazardous environment. (page 54)
5. **Supplied-air respirator:** A supplied-air respirator (SAR) uses an external source for the breathing air. In this type of device, a hose line is connected to a breathing-air compressor or to compressed air cylinders located outside the hazardous area. The user breathes air through the line and exhales through a one-way valve, just as with an open-circuit SCBA. Although SARs are commonly used in industrial settings, they are not used by fire fighters for structural firefighting. Hazardous materials teams and confined-space rescue teams sometimes use SARs for specialized operations. Some fire service SCBA units can be adapted for use as SARs. (page 56)
6. **End-of-service-time indicator (EOSTI):** NFPA standards require that SCBA include an end-of-service-time indicator (EOSTI), or low-air alarm. This warning device tells the user that the end of the breathing air supply is approaching. NFPA 1500 requires that an exit strategy be practiced when the SCBA cylinder reaches a level of 600 liters or more. This alarm may take the form of a bell or whistle, a vibration, or a flashing LED. SCBAs are required to have two types of low-air alarms that operate independently of each other and activate different senses. (page 60)
7. **Hydrostatic testing:** The U.S. Department of Transportation requires hydrostatic testing for SCBA cylinders on a periodic basis and limits the number of years that a cylinder can be used; for example, composite-fiber overwrapped cylinders must be replaced after 15 years. Hydrostatic testing seeks to identify any defects or damage that might render the cylinder unsafe. Any cylinder that fails a hydrostatic test should be immediately taken out of service and cannot be used. (page 75)
8. **Cascade system:** Cascade systems have several large storage cylinders of compressed breathing air connected by a high-pressure manifold system. The empty SCBA cylinder is connected to the cascade system, and compressed air is transferred from the storage tanks to the cylinder. (page 78)

Fill-in

- | | |
|--|--|
| 1. supplied air respirator (SAR) (page 56) | 6. incomplete combustion (page 55) |
| 2. full turnout gear (page 54) | 7. hand light (page 49) |
| 3. open-circuit (page 56) | 8. oxygen deficient (page 56) |
| 4. carcinogens (page 51) | 9. personal protective equipment (PPE) (page 44) |
| 5. Donning (page 51) | 10. 15 years (page 74) |

True/False

- | | |
|----------------|-----------------|
| 1. T (page 50) | 6. T (page 54) |
| 2. F (page 75) | 7. T (page 55) |
| 3. T (page 75) | 8. T (page 55) |
| 4. T (page 55) | 9. F (page 56) |
| 5. T (page 54) | 10. F (page 60) |

Short Answer

1. The six types of protection provided by PPE are: (1) Provides thermal protection; (2) Repels water; (3) Provides impact protection; (4) Protects against cuts and abrasions; (5) Furnishes padding against injury; (6) Provides respiratory protection. (page 45)
2. Three types of flame-resistant material commonly used in the construction of firefighting PPE are: (1) Nomex®; (2) PBI®; (3) Kevlar® (page 46)
3. Reasons why fire fighters need respiratory protection during fire incidents include: (1) Smoke; (2) Toxic gases; (3) Oxygen deficiency (pages 55–56)

4. The physiological effects of reduced oxygen concentrations are: (1) 21 percent: Normal breathing air; (2) 17 percent: Judgment and coordination impaired, lack of muscle control; (3) 12 percent: Headache, dizziness, nausea, fatigue; (4) 9 percent: Unconsciousness; (5) 6 percent: Respiratory arrest, cardiac arrest, death (page 56)
5. Five limitations of PPE are: (1) Not easy to don; (2) Heavy; (3) Difficult for the body to cool itself; (4) Limits mobility; (5) Decreases normal sensory ability (page 50)

Word Fun

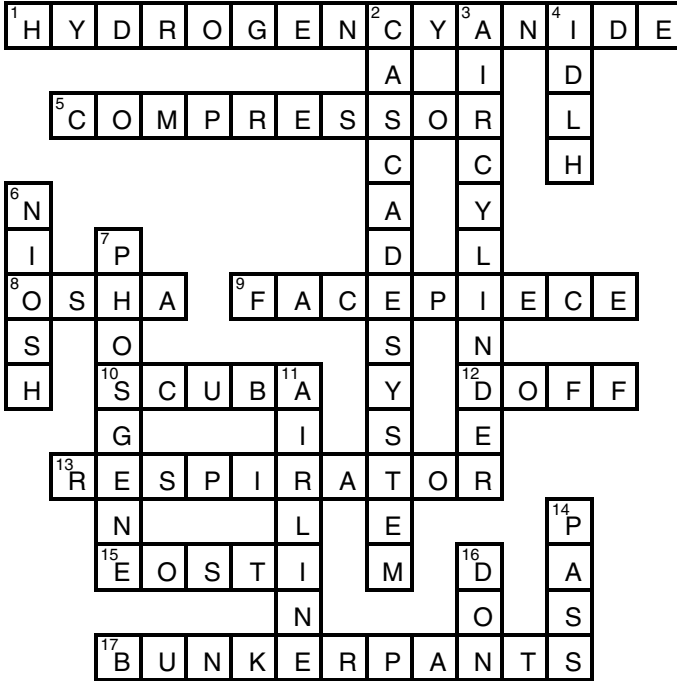

Fire Alarms

1. Turn on the red-colored emergency bypass valve on your SCBA regulator. This releases a constant flow of breathing air into the face piece. The emergency bypass mode uses more air, but it enables fire fighters to exit a hazardous environment if the regulator stops operating. A fire fighter who must use the emergency bypass mode must leave the hazardous area IMMEDIATELY.
2. PPE that has been badly soiled by exposure to smoke, other products of combustion, melted tar, petroleum products, or other contaminants needs to be cleaned as soon as possible. Cleaning instructions are listed on the tag attached to the garment. Follow the manufacturer’s cleaning instructions. Failure to do so may reduce the effectiveness of the garment and create an unsafe situation for the wearer. Some fire departments have special washing machines that are approved for cleaning PPE. Other departments contract with an outside firm to clean and repair PPE. In either case, the manufacturer’s instructions for cleaning and maintaining the garment must be followed.

Fire Fighter II in Action

1. Answers will vary.
2. Answers will vary.

Skill Drills

Skill Drill 3-1: Donning Personal Protective Clothing

(page 52)



© Jones & Bartlett Learning. Photographed by Glen E. Ellman.

1. Place your equipment in a logical order for donning.



© Jones & Bartlett Learning. Photographed by Glen E. Ellman.

2. Place your protective hood over your head and down around your neck.



© Jones & Bartlett Learning. Photographed by Glen E. Ellman.

3. Put on your boots and pull up your bunker pants. Place the suspenders over your shoulders and secure the front of the pants.



© Jones & Bartlett Learning. Photographed by Glen E. Ellman.

4. Put on your turnout coat and close the front of the coat.



© Jones & Bartlett Learning. Photographed by Glen E. Ellman.

5. Place your helmet on your head and adjust the chin strap securely. Turn up your coat collar and secure it in front.



© Jones & Bartlett Learning. Photographed by Glen E. Ellman.

6. Put on your gloves.



© Jones & Bartlett Learning. Photographed by Glen E. Ellman.

7. Have your partner check your clothing.

Chapter 4: Fire Service Communications

Matching

- | | |
|-----------------|--|
| 1. B (page 109) | 6. J (page 98) |
| 2. F (page 94) | 7. E (page 105) |
| 3. C (page 94) | 8. I (page 106) |
| 4. A (page 103) | 9. H (page 105) |
| 5. G (page 106) |  10. D (page 109) |

Multiple Choice

- | | |
|-----------------|--|
| 1. A (page 96) | 11. B (page 102) |
| 2. A (page 96) | 12. D (page 98) |
| 3. D (page 103) | 13. D (page 108) |
| 4. B (page 97) | 14. C (page 107) |
| 5. D (page 111) | 15. B (page 107) |
| 6. B (page 92) | 16. A (page 106) |
| 7. C (page 108) | 17. D (page 100) |
| 8. D (page 96) |  18. C (page 109) |
| 9. C (page 94) |  19. A (page 109) |
| 10. A (page 97) | |

Vocabulary

- Automatic location identification:** A system that queries a database to show the location of the telephone, the caller's name, and other details. (page 99)
- Run cards:** Documentation that lists units in the proper order of response, based on response distance or estimated response time. (page 100)
- TDD/TTY/text phone:** Special devices that display text rather than transmitting audio. (page 97)
- Ten-codes:** A system of coded messages that begin with the number 10. (page 107)
- Time marks:** Set intervals at which the communications center prompts the incident commander (IC) to report. (page 109)
- Activity logging system:** A system that keeps a detailed record of every incident and activity that occurs. (page 94)
- Computer-aided dispatch (CAD):** A system designed to assist a telecommunicator by performing specific functions more quickly and efficiently than they can be done manually. (page 94)
-  **Evacuation signal:** A sequence of blasts or a siren that warns personnel to pull back to a safe location. (page 109)





Fill-in

- | | |
|------------------------|---|
| 1. dispatch (page 96) | 6. communications center (page 92) |
| 2. simplex (page 105) | 7. telecommunicator (page 93) |
| 3. duplex (page 105) | 8. Time marks (page 109) |
| 4. mobile (page 103) |  9. Mayday (page 109) |
| 5. trunking (page 106) |  10. evacuation (page 109) |

True/False

- | | |
|-----------------|--------------------|
| 1. T (page 108) | 6. T (page 107) |
| 2. T (page 97) | 7. T (page 107) |
| 3. T (page 95) | 8. T (pages 98–99) |
| 4. T (page 97) | 9. F (page 93) |
| 5. T (page 97) | 10. F (page 98) |

Short Answer

- The basic functions performed in a communications center are (*Students should include five of the following*): (1) Receiving calls for emergency incidents and dispatching fire department units; (2) Supporting the operations of fire department units delivering emergency services; (3) Coordinating fire department operations with other agencies; (4) Keeping track of the status of each fire department unit at all times; (5) Monitoring the level of coverage and managing the deployment of available units; (6) Notifying designated individuals and agencies of particular events and situations; (7) Maintaining records of all emergency-related activities; (8) Maintaining information required for dispatch purposes (page 96)
- Pieces of equipment often found in a communications center include (*Students should include five of the following*): (1) Dedicated 911 telephones; (2) Public telephones; (3) Direct-line phones to other agencies; (4) Equipment to receive alarms from public or private fire alarm systems; (5) Computers and/or hard copy files and maps to locate addresses and select units to dispatch; (6) Equipment for alerting and dispatching units to emergency calls; (7) Two-way radio systems; (8) Recording devices to record phone calls and radio traffic; (9) Backup electrical generators; (10) Records and record management system (page 94)
- The five major steps in processing an emergency incident are: (1) Call receipt; (2) Location validation; (3) Classification and prioritization; (4) Unit selection; (5) Dispatch (page 96)
-  From a legal standpoint, records and reports are vital parts of the emergency process. Information must be complete, clear, and concise because these records can become admissible evidence in a court case. Improper or inadequate documentation can have long-term negative consequences. Fire reports are considered public records under the Freedom of Information Act, so they may be viewed by an attorney, an insurance company, the news media, or the public. If a fatality occurs, incomplete or inaccurate reports may be used to prove that the fire department was negligent. The department, the fire chief, and others may be held accountable. (page 110)
-  Emergency traffic is an urgent message that takes priority over all other communications, such as a call for help or evacuation. (page 109)
-  An evacuation signal is a distinctive signal intended to be recognized by the occupants as requiring evacuation of the building. The evacuation signal that is commonly used is a sequence of three blasts on an apparatus air horn, repeated several times, or sirens sounded on “high-low” for 15 seconds. An evacuation warning should be announced at least three times to ensure that everyone hears it; the warning should also be announced on the radio by the IC. (page 109)
-  A mayday is a code indicating that a fire fighter is lost, missing, or trapped, and requires immediate assistance. The fire fighter making the mayday call should describe the situation, location, and help needed. Fire fighters should study and practice the procedure for responding to a mayday call. (page 109)

Word Fun

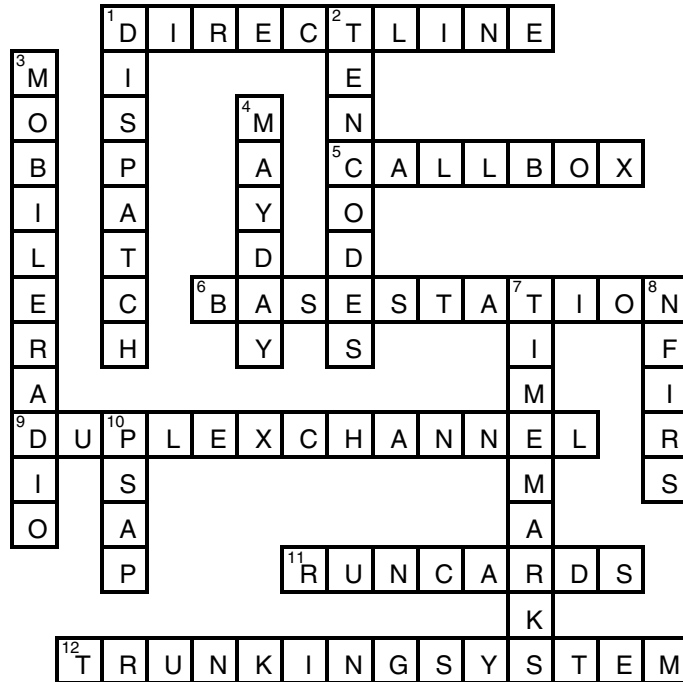

Fire Alarms

1. Your department's standard operating procedures (SOPs) should outline exactly which steps you should take in this situation, such as whether you should take the information yourself or connect the caller directly to the communications center. If you take the information from the caller, be sure to get as much information as possible, including type of incident/situation, location of the incident, cross streets or identifying landmarks, indication of scene safety, caller's name, caller's location (if different from the incident location), and caller's callback number. If your station or your unit will be responding to the call, always advise the communications center immediately before responding.
2.  The most important emergency traffic is a fire fighter's call for help. Most departments use "mayday" to indicate that a fire fighter is lost, missing, or requires immediate assistance. If a mayday call is heard on the radio, all other radio traffic should stop immediately. The fire fighter making the mayday call should describe the situation, location, and help needed. Fire fighters should study and practice the procedure for responding to a mayday call.

Fire Fighter II in Action

1. *Answers will vary.*
2. *Answers will vary.*

Skill Drills

Skill Drill 4-1: Initiating a Response to a Simulated Emergency

(page 102)



© Jones & Bartlett Learning. Photographed by Glen E. Ellman.

1. Identify your agency. Ask whether there is a(n) **emergency**. Organize your questions to get the following information: incident **location**, type of incident, and when the incident occurred. Obtain the following information: caller's **name**; location of the caller, if different from the incident; and **callback** number.



© Jones & Bartlett Learning. Photographed by Glen E. Ellman.

2. Record the information needed. Initiate an **alarm** following the protocols of your **communications center**.

Chapter 5: Incident Command System

Matching

- | | |
|-----------------|------------------|
| 1. C (page 122) | 6. I (page 120) |
| 2. F (page 127) | 7. A (page 126) |
| 3. H (page 124) | 8. D (page 126) |
| 4. B (page 127) | 9. E (page 126) |
| 5. J (page 131) | 10. G (page 126) |

Multiple Choice

- | | |
|------------------|------------------|
| 1. A (page 124) | 13. A (page 125) |
| 2. B (page 127) | 14. D (page 126) |
| 3. B (page 123) | 15. C (page 121) |
| 4. B (page 122) | 16. B (page 123) |
| 5. C (page 119) | 17. D (page 123) |
| 6. A (page 131) | 18. A (page 126) |
| 7. C (page 125) | 19. A (page 123) |
| 8. A (page 123) | 20. C (page 122) |
| 9. D (page 121) | 21. D (page 124) |
| 10. B (page 128) | 22. B (page 124) |
| 11. B (page 125) | 23. C (page 126) |
| 12. A (page 122) | 24. A (page 126) |

Vocabulary

- Incident command system:** A command system that provides a standard approach, structure, and operational procedure to organize and manage any operation. (pages 118–119)
- Unified command:** A unified command brings representatives of different agencies together to work on one plan and ensures that all actions are fully coordinated. (page 120)
- Incident action plan:** Oral or written plan containing general objectives reflecting the overall strategy for managing the incident. (page 120)
- National Incident Management System:** The standards and guidelines for incident management defined at a national level. (page 118)
- Command staff:** Individuals on the command staff perform functions that report directly to Command and cannot be delegated to other major sections of the organization. (page 123)
- Division:** Companies and/or crews working in the same geographic area. (page 126)
- Resource management:** The use of a standard system of assigning and keeping track of the resources involved in the incident. (page 122)

Fill-in

- | | |
|--|-----------------------------|
| 1. Command (page 123) | 6. terminology (page 126) |
| 2. approach; structure; operational (page 118) | 7. organization (page 128) |
| 3. single resource (page 126) | 8. designated (page 122) |
| 4. span of control (page 126) | 9. general staff (page 124) |
| 5. communication (page 118) | 10. always (page 123) |

True/False

- | | |
|-----------------|------------------|
| 1. F (page 125) | 6. F (page 125) |
| 2. F (page 124) | 7. T (page 118) |
| 3. T (page 126) | 8. T (page 126) |
| 4. T (page 118) | 9. T (page 120) |
| 5. T (page 121) | 10. F (page 122) |

Short Answer

- The four major functional components are: (1) Operations; (2) Planning; (3) Logistics; (4) Finance/Administration (page 124)
- The initial report should include the following information: (1) A size-up report; (2) Command designation; (3) The unit or individual who is assuming command; (4) An initial situation report; (5) The initial action being taken. (page 131)
- Important characteristics of an ICS include the following: (1) Recognized jurisdictional authority and responsibility; (2) Applicable to all risk and hazard situations; (3) Applicable to both day-to-day operations and major incidents; (4) Unity of command; (5) Span of control; (6) Modular organization; (7) Common terminology; (8) Integrated communications; (9) Consolidated incident action plans; (10) Designated incident facilities; (11) Resource management (page 119)
- Command is directly responsible for the following tasks: (1) Determining strategy; (2) Selecting incident tactics; (3) Setting the action plan; (4) Developing the ICS organization; (5) Managing resources; (6) Coordinating resource activities; (7) Providing for scene safety; (8) Releasing information about the incident; (9) Coordinating with outside agencies (page 123)
- The five major functional components of an ICS are: (1) Command; (2) Operations; (3) Planning; (4) Logistics; (5) Finance/Administration (page 124)

Word Fun

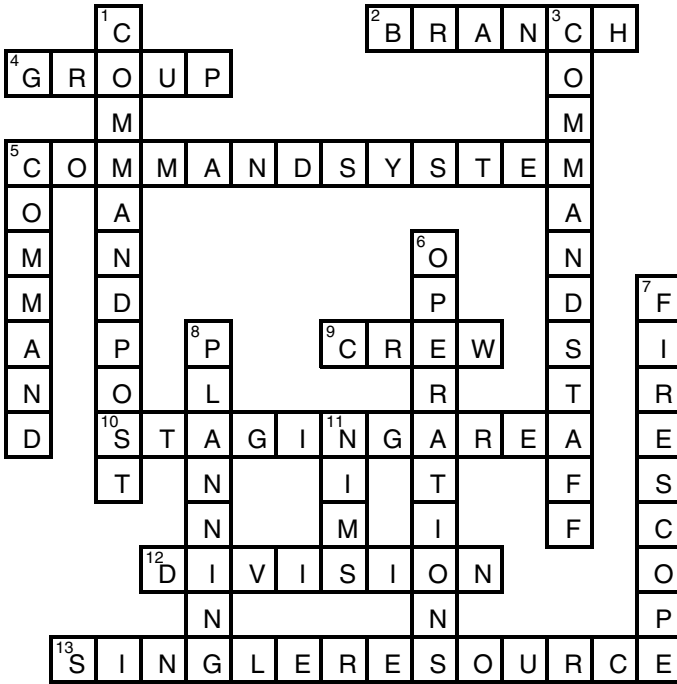

Fire Alarms

1. The ICS was developed so that each person has only one supervisor, eliminating the confusion that can result when you are given orders from more than one boss. It also ensures that every member on the emergency scene is accounted for. Notify the Division D supervisor that you are assigned to Division C.
2. The officer who is relinquishing command needs to give the new IC a current situation status report that includes tactical priorities, action plans, hazardous or potentially hazardous conditions, accomplishments, assessment of effectiveness of operations, current status of resources, and additional resource requirements.

Fire Fighter II in Action

1. Answers will vary.
2. Answers will vary.
3. Answers will vary.

Chapter 6: Fire Behavior

Matching

- | | |
|-----------------------|------------------------|
| 1. G (pages 143, 162) | 9. J (page 144) |
| 2. C (pages 143, 162) | 10. I (pages 145, 162) |
| 3. F (pages 154, 162) | 11. K (pages 153, 162) |
| 4. E (pages 145, 163) | 12. L (pages 146, 162) |
| 5. A (pages 146, 162) | 13. M (pages 155, 163) |
| 6. D (pages 147, 163) | 14. N (pages 156, 163) |
| 7. B (pages 147, 163) | 15. O (pages 151, 163) |
| 8. H (pages 146, 162) | |

Multiple Choice

1. D (page 150)
2. A (page 148)
3. C (page 143)
4. B (page 145)
5. B (page 148)
6. D (page 151)
7. A (page 146)
8. C (page 152)
9. D (page 156)
10. B (page 152)
11. D (page 149)
12. C (page 147)
13. D (page 145)
14. C (page 145)
15. B (page 157)
16. C (page 143)
17. A (page 147)
18. A (page 144)
19. C (page 145)
20. C (page 157)
21. A (page 142)
22. A (page 157)

Labeling

1. The fire tetrahedron: A. Fuel; B. Oxygen; C. Heat

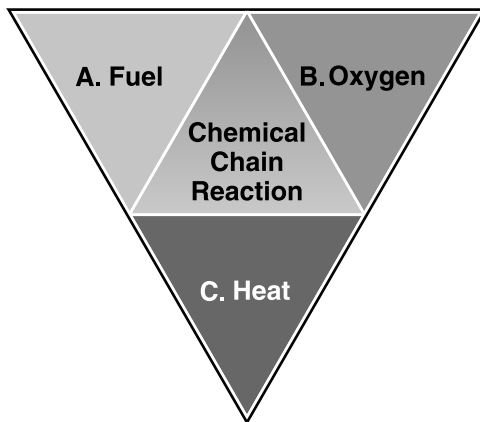

Vocabulary

1. **Lower flammable limit:** The minimum amount of gaseous fuel that must be present in a gas–air mixture for the mixture to be flammable. (page 157)
2. **Ignition temperature:** The temperature at which a combustible material will ignite. (page 156)
3. **Flash point:** The lowest temperature at which a liquid produces a flammable vapor. (page 156)
4. **BLEVE:** Boiling liquid, expanding vapor explosion; a deadly set of circumstances involving liquid and gaseous fuels. (page 157)
5. **Thermal layering:** The phenomenon of gases forming into layers according to temperature. (page 152)
6. **Fire triangle:** The three basic conditions needed for a fire to occur—fuel, oxygen, and heat. (page 144)
7. **Flashover:** The transition from a fire that is growing by igniting one type of fuel to another, to a fire where all of the exposed surfaces have ignited. (page 152)
8. **Fully developed stage:** Fire is consuming the maximum amount of fuel possible and it achieves the maximum heat release rate possible for the fuel supply and oxygen present. (page 154)
9. **Rollover:** The spontaneous ignition of hot gases in the upper levels of a room or compartment. (page 152)
10. **Smoke explosion:** A violent release of confined energy that occurs when a mixture of flammable gases and oxygen are present, usually in a void or other area separate from the fire compartment, and comes in contact with a source of ignition. In a smoke explosion, there is no change to the ventilation profile, such as an open door or window; rather, it occurs from the travel of smoke within the structure to an ignition source. (page 155)

Fill-in

1. supply; foam (page 149)
2. monoxide (page 145)
3. ventilation-limited (page 154)
4. flammable vapor (page 142)
5. fuel (page 145)
6. ignition temperature (page 154)
7. solid; liquid; gas (page 143)
8. neutral plane (page 152)
9. volatility (page 156)
10. exothermic (page 143)

True/False

1. T (page 150)
2. T (page 151)
3. F (page 152)
4. T (page 145)
5. F (page 156)
6. T (page 158)
7. F (page 144)
8. T (page 143)
9. F (page 155)
10. T (page 143)

Short Answer

1. The three conditions that must be present for a vapor-air mixture to ignite are: (1) The fuel and air must be present at a concentration within a flammable range. (2) There must be an ignition source with enough energy to start ignition. (3) The ignition source and the fuel mixture must make contact for long enough to transfer the energy to the air-fuel mixture. (page 156)
2. Three signs of an impending backdraft are (*Students should list three of the following*): (1) Any confined fire with a large heat build-up; (2) Little visible flame from the exterior of the building; (3) A “living fire”: smoke puffing from the building that looks like it is breathing; (4) Smoke that seems to be pressurized; (5) Smoke-stained windows (an indication of a significant fire); (6) No smoke showing; (7) Turbulent smoke; (7) Thick, yellowish smoke (containing sulfur compounds) (page 153)
3. Flashover can be prevented by cooling the fuel, removing the fuel, or reducing the amount of oxygen present by controlling ventilation. (page 153)
4. The hazards associated with smoke are: (1) Toxic gases; (2) Superheated, high temperatures. (page 145)
5. The four phases of fire are: (1) Ignition phase; (2) Growth phase; (3) Fully developed phase; (4) Decay phase. (page 151)
6. The four basic methods of extinguishing fires are: (1) Cool the burning material; (2) Exclude oxygen from the fire; (3) Remove fuel from the fire; (4) Interrupt the chemical reaction with a flame inhibitor. (page 148)

Fire Alarms

1. Two actions are important. First, actions among fire fighters should be coordinated so that, whenever possible, the superheated gases are being vented from the fire room as you are attacking the fire. Second, it is important to use the proper fire stream for the situation. Opening a fog stream into a heated enclosed area will produce much more steam than a straight stream. Selecting a straight stream will allow more of the water to reach the seat of the fire, where it can have the greatest effect. Use proper fire suppression techniques to avoid thermal imbalance.
2. First, recognize that there may be a backdraft condition present. Do not open any openings. The best way to prevent a backdraft is to make a ventilation opening at a high level, so that hot gases can escape from the interior without allowing fresh air to enter.



Fire Fighter II in Action

Questions 1–4: *Answers will vary.*

Chapter 7: Building Construction

Matching

1. I (page 169)
2. G (page 169)
3. H (page 189)
4. B (page 187)
5. A (page 171)
6. F (page 168)
7. E (page 180)
8. D (page 186)
9. J (page 170)
10. C (page 169)

Multiple Choice

1. C (page 173)
2. D (page 177)
3. C (page 184)
4. B (page 169)
5. B (page 184)
6. A (page 170)
7. D (page 189)
8. C (page 180)
9. C (page 171)
10. D (page 187)
11. A (page 189)
12. D (page 169)
13. B (page 182)
14. B (page 173)
15. A (page 184)
16. D (page 173)
17. B (page 186)
18. C (page 181)
19. B (page 176)
20. D (page 173)
21. A (pages 174–175)
22. B (page 176)

Vocabulary

1. **Interior finish:** The exposed interior surfaces of a building. (page 189)
2. **Dead load:** The weight of the building itself. (page 186)
3. **Balloon-frame construction:** A method of construction in which the exterior walls are assembled with wood studs that run continuously from the basement to the roof. (page 178)
4. **Bowstring truss:** A truss in the shape of an archery bow, where the top chord represents the curved bow and the bottom chord represents the straight bow string. (page 185)
5. **Thermoplastic materials:** Materials that melt and drip when exposed to high temperatures, even those as low as 500°F. (page 173)
6. **Load-bearing wall:** A wall that provides structural support by supporting a portion of the building's weight and its contents, transmitting that load down to the building's foundation. (page 186)

Fill-in

1. bowstring truss (page 185)
2. pyrolysis (page 172)
3. V (page 177)
4. pitched (page 184)
5. fire wall (page 187)
6. occupancy (page 168)
7. I (page 174)
8. contents of the building (page 175)
9. Platform (page 180)
10. live load (page 180)

Fire Alarms

1. Nursing homes are occupied 24 hours a day by persons who will probably need assistance to evacuate. A building of Type III construction has two separate fire loads: the contents and the combustible building materials used. A nursing home will have a lot of mattresses and curtains that will burn readily. A fire involving both the contents and the structural components can quickly destroy the building. Type III construction presents several problems for fire fighters. For example, an electrical fire can begin inside the void spaces within the walls, floors, and roof assemblies and extend to the contents. The void spaces also allow a fire to extend vertically and horizontally, spreading from room to room and from floor to floor. Fire fighters will have to open the void spaces to fight the fire. An uncontrolled fire within the void spaces is likely to destroy the building.
2. Stay out of the structure. Exterior walls also could collapse if a fire causes significant damage to the interior structure. Because the exterior walls, the floors, and the roof are all connected in a stable building, the collapse of the interior structure could make the freestanding masonry walls unstable and likely to collapse.



Fire Fighter II in Action

1. *Answers will vary.*
2. *Answers will vary.*

Chapter 8: Portable Fire Extinguishers

Matching

- | | |
|-----------------|------------------|
| 1. H (page 198) | 6. G (page 214) |
| 2. C (page 208) | 7. I (page 208) |
| 3. F (page 199) | 8. B (page 207) |
| 4. A (page 227) | 9. E (page 210) |
| 5. J (page 210) | 10. D (page 204) |

Multiple Choice

- | | |
|------------------|------------------|
| 1. D (page 215) | 12. C (page 207) |
| 2. B (page 203) | 13. A (page 202) |
| 3. B (page 216) | 14. A (page 204) |
| 4. A (page 205) | 15. B (page 200) |
| 5. D (page 202) | 16. C (page 225) |
| 6. A (page 203) | 17. B (page 214) |
| 7. C (page 201) | 18. A (page 210) |
| 8. C (page 210) | 19. D (page 201) |
| 9. C (page 207) | 20. A (page 202) |
| 10. D (page 205) | 21. C (page 214) |
| 11. B (page 199) | 22. D (page 205) |

Labeling

1. Basic parts of a portable fire extinguisher. (page 210)

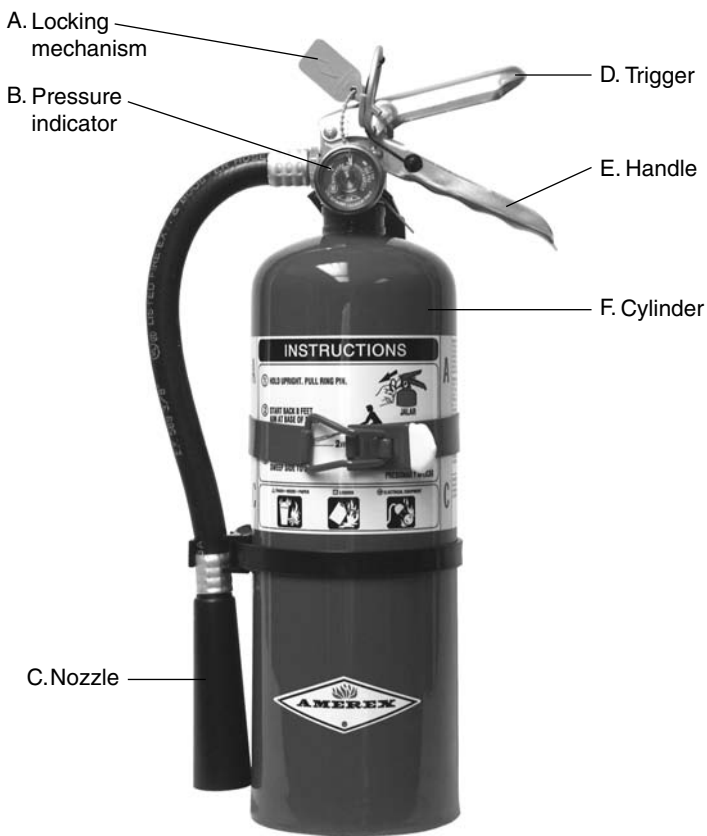

Figure 8-19

Vocabulary

1. **Polar solvent:** A water-soluble flammable liquid, such as an alcohol, acetone, ester, or ketone. (page 208)
2. **Extra hazard locations:** Locations that contain more Class A combustibles and/or Class B flammables than do ordinary hazard locations. (page 204)
3. **Extinguishing agent:** Material used to stop the combustion process (page 198)
4. **Cartridge/cylinder fire extinguisher:** An extinguisher that relies on an external cartridge of pressurized gas, which is released only when the extinguisher is to be used. (page 210)
5. **Underwriters Laboratories, Inc. (UL):** The organization that developed the standards, classification, and rating system for portable fire extinguishers. (page 202)
6. **Class K fires:** Fires involving combustible cooking oils and fats. (page 201)
7. **Rapid oxidation:** The scientific terminology for burning. (page 205)
8. **Multipurpose dry chemical extinguisher:** An extinguisher rated for Class A, B, and C fires. The chemicals in these extinguishers form a crust over Class A combustible fuels to prevent rekindling. (page 207)

Fill-in

1. Carbon dioxide (page 214)
2. nozzle (page 210)
3. basic (page 198)
4. clean agent (page 209)
5. Backpack (page 198)
6. B (page 202)
7. A (page 200)
8. Carbon dioxide (page 207)
9. recharged (page 226)
10. temperature (page 205)

True/False

1. F (page 202)
2. T (page 209)
3. F (page 218)
4. T (page 203)
5. F (page 202)
6. T (page 204)
7. F (page 199)
8. F (page 225)
9. T (page 227)
10. T (page 198)

Short Answer

1. The six basic steps in extinguishing a fire with a portable fire extinguisher are: (1) Locate the fire extinguisher. (2) Select the proper classification of extinguisher. (3) Transport the extinguisher to the location of the fire. (4) Activate the extinguisher to release the extinguishing agent. (5) Apply the extinguishing agent to the fire for maximum effect. (6) Ensure your personal safety by having an exit route. (page 216)
2. (1) Pull the safety pin. (2) Aim the nozzle at the base of the flames. (3) Squeeze the trigger to discharge the agent. (4) Sweep the nozzle across the base of the flames. (page 218)
3. Common indicators that a fire extinguisher needs maintenance are (*Students should include four of the following*): (1) The pressure gauge reading is outside the normal range. (2) The inspection tag is out of date. (3) The tamper seal is broken, especially in extinguishers with no pressure gauge. (4) The extinguisher does not appear to be full of extinguishing agent. (5) The hose and/or nozzle assembly is obstructed. (6) There are signs of physical damage, corrosion, or rust. (7) There are signs of leakage around the discharge valve or nozzle assembly. (pages 225–226)
4. The seven types of fire extinguishers are: (1) Water; (2) Dry chemical; (3) Carbon dioxide; (4) Foam; (5) Wet chemical; (6) Halogenated agent; (7) Dry powder (page 211)
5. The six basic parts of most hand-held portable fire extinguishers are: (1) Cylinder; (2) Handle; (3) Nozzle or horn; (4) Trigger and discharge valve assembly; (5) Locking mechanism; (6) Pressure indicator (pages 209–210)

Word Fun

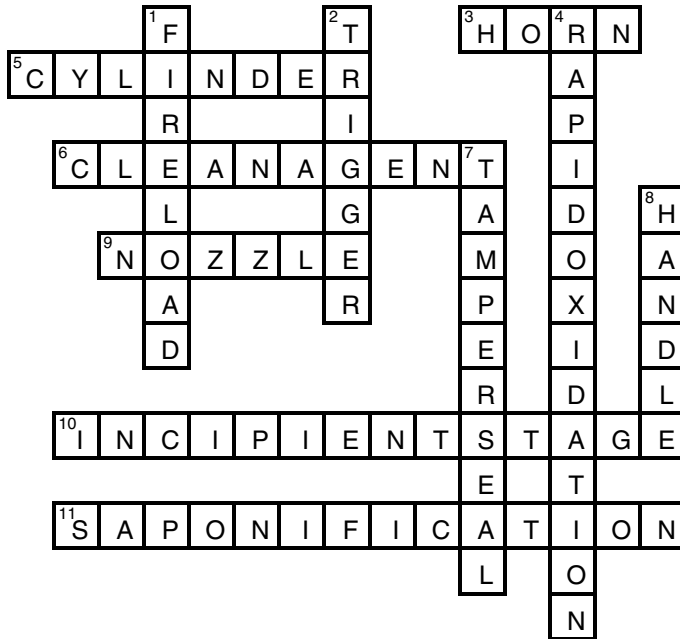

Fire Alarms

1. Ensure the damper on the fireplace is open. Use a Class A type extinguisher, preferably a stored-pressure water type. Open the fireplace door and spray a small amount of water on the fire until it is extinguished.
2. When inspecting fire extinguishers, you should be looking for some common indications that an extinguisher needs maintenance. Common indications include: (1) The pressure gauge reading is outside the normal range. (2) The inspection tag is out-of-date. (3) The tamper seal is broken. (4) Any indication that the extinguisher is not full of extinguishing agent. (5) The hose and/or nozzle assembly is obstructed. (6) There are signs of physical damage, corrosion, or rust. (7) Signs of leakage around the discharge valve or nozzle assembly can be seen.



Fire Fighter II in Action

1. Answers will vary.
2. Answers will vary.

Skill Drills

Skill Drill 8-1: Transporting a Fire Extinguisher

(page 219)



© Jones & Bartlett Learning. Photographed by Glen E. Ellman.

1. Locate the closest fire extinguisher.



© Jones & Bartlett Learning. Photographed by Glen E. Ellman.

2. Assess that the extinguisher is **safe** and **effective** for the type of fire being attacked. Release the **mounting bracket straps**.



© Jones & Bartlett Learning. Photographed by Glen E. Ellman.

3. Lift the extinguisher using good **body mechanics**. Lift small extinguishers with one hand, and large extinguishers with two hands.



© Jones & Bartlett Learning. Photographed by Glen E. Ellman.

4. Walk **briskly**—do not run—toward the fire. If the extinguisher has a hose and nozzle, carry the extinguisher with one hand and grasp the **nozzle** with the other hand.

Skill Drill 8-2: Attacking a Class A Fire with a Stored-Pressure Water-Type Fire Extinguisher

(page 220)



© Jones & Bartlett Learning. Photographed by Glen E. Ellman.

1. Size up the fire to determine whether a **stored-pressure** water extinguisher is safe and effective for this fire. Ensure that extinguisher is large enough to be safe and effective.



© Jones & Bartlett Learning. Photographed by Glen E. Ellman.

2. Ensure your safety. Make sure you have a(n) **exit route** from the fire. Do not turn your back on a fire.



© Jones & Bartlett Learning. Photographed by Glen E. Ellman.

3. Remove the **hose** and **nozzle**. Quickly check the **pressure gauge** to verify that the extinguisher is adequately charged.



© Jones & Bartlett Learning. Photographed by Glen E. Ellman.

4. Pull the pin to release the extinguisher **control** valve. You must be within 35 to 40 feet (11 to 12 meters) of the fire to be effective.



© Jones & Bartlett Learning. Photographed by Glen E. Ellman.

5. Aim the nozzle and sweep the water stream at the **base** of the flames.



© Jones & Bartlett Learning. Photographed by Glen E. Ellman.

6. Overhaul the fire; take steps to prevent **rekindling**, break apart tightly packed fuel, and summon additional help if needed.

Chapter 9: Fire Fighter Tools and Equipment

Matching

- | | |
|-----------------|------------------|
| 1. E (page 240) | 6. G (page 239) |
| 2. A (page 240) | 7. D (page 242) |
| 3. I (page 248) | 8. H (page 241) |
| 4. B (page 251) | 9. F (page 243) |
| 5. C (page 248) | 10. J (page 250) |



Multiple Choice

- | | |
|------------------|------------------------|
| 1. C (page 240) | 11. D (page 237) |
| 2. D (page 247) | 12. C (page 252) |
| 3. D (page 236) | 13. A (pages 249–250) |
| 4. B (page 250) | 14. A (page 244) |
| 5. C (page 236) | 15. D (pages 244, 246) |
| 6. B (page 241) | 16. C (page 243) |
| 7. A (page 240) | 17. D (page 250) |
| 8. A (page 244) | 18. B (page 252) |
| 9. B (page 252) | 19. D (page 250) |
| 10. D (page 244) | 20. D (page 253) |



Vocabulary

- Claw bar:** A tool with a pointed claw-hook on one end and a forked- or flat-chisel pry on the other end that can be used for forcible entry. (page 241)
- Reciprocating saw:** A saw powered by either an electric motor or a battery motor that rapidly pulls the saw blade back and forth. (page 246)
- Overhaul:** The phase in which you examine the fire scene carefully and ensure that all hidden fires are extinguished. (page 248)

4. **Gripping pliers:** A hand tool with a pincer-like working end that can also be used to bend wire or hold smaller objects. (page 239)
5. **Crowbar:** A straight bar made of steel or iron with a forked-like chisel on the working end. (page 241)
6. **Seat belt cutter:** A specialized cutting device that cuts through seat belts. (page 244)
7. **Spanner wrench:** A special wrench used to tighten or loosen hose couplings. (page 239)
8. **Kelly tool:** A steel bar with two main features—a large pick and a large chisel or fork. (page 241)
9. **Cutting torch:** A torch that produces an extremely high-temperature flame and is capable of heating steel until it melts, thereby cutting through the object. (page 247)
10. **Hydrant wrench:** A tool used to open or close a hydrant by rotating the valve stem, and to remove the caps from the hydrant outlets. (page 239)
11. **Ceiling hook:** A tool consisting of a long wood or fiberglass pole and a metal point with a spur at right angles that can be used to probe ceilings and pull down plaster lath material. (page 240)
12. **Pike pole:** A wood or fiberglass pole with a metal head attached to one end. (page 240)

Fill-in

- | | |
|-------------------------------------|--------------------------------------|
| 1. effectively (page 236) | 6. pick-head axe (page 243) |
| 2. Response/size-up (page 248) | 7. multiple-function (page 248) |
| 3. Safety (page 236) | 8. Cutting torches (page 247) |
| 4. maul (page 242) | 9. tool staging (page 252) |
| 5. Pushing; pulling (pages 239–240) | 10. manufacturer-provided (page 253) |

True/False

- | | |
|-----------------------|------------------|
| 1. T (page 249) | 6. T (page 240) |
| 2. F (page 249) | 7. F (page 248) |
| 3. T (page 237) | 8. T (page 246) |
| 4. T (page 248) | 9. T (page 236) |
| 5. F (pages 242, 251) | 10. T (page 250) |

Short Answer

1. Pushing/Pulling tools can extend the reach of the fire fighter as well as increase the power the fire fighter can exert upon an object. *Students should include five of the following:* (1) Ceiling hook; (2) Multipurpose hook; (3) Roofman's hook; (4) Clemens hook; (5) Pike pole; (6) San Francisco hook; (7) Drywall hook; (8) Plaster hook (pages 239–240)
2. If you know which tools and equipment are needed for each phase of firefighting, you will be able to achieve the desired objective quickly and have the energy needed to complete the remaining tasks. (page 236)
3. Tools used for overhaul include the following: (1) Pushing tools (pike poles of varying lengths); (2) Prying tools (Halligan tool); (3) Striking tools (sledgehammer, flat-head axe, hammer, mallet); (4) Cutting tools (axes, power saws); (5) Debris-removal tools (shovels, brooms, rakes, buckets, carryalls); (6) Water-removal equipment (water vacuums); (7) Ventilation equipment (electric, gas, or water-powered fans); (8) Portable lighting; (9) Thermal imaging device (pages 251–252)
4. The basic set of tools for interior firefighting includes: (1) A prying tool, such as a Halligan tool; (2) A striking tool, such as a flat-head axe or a sledgehammer; (3) A cutting tool, such as an axe; (4) A pushing/pulling tool, such as a pike pole; (5) A hand light or portable light (pages 249–250)
5. (1) Rotating tools apply a rotational force to make something turn. Examples: Box-end wrench, gripping pliers, hydrant wrench, open-end wrench, pipe wrench, screwdriver, socket wrench, spanner wrench.
 (2) Pushing/pulling tools extend the reach or increase the power on an object. Examples: Ceiling hook, Clemens hook, drywall hook, K tool, multipurpose hook, pike pole, plaster hook, roofman's hook, San Francisco hook.
 (3) Prying/spreading tools are used for creating or increasing the size of an opening. Examples: Claw bar, crowbar, flat bar, Halligan tool, Hux bar, hydraulic spreader, Kelly tool, pry bar, rabbet tool.

Fire Alarms

1. The special equipment that a rapid intervention crew should carry includes thermal imaging device, additional portable lighting, lifelines, prying tools, striking tools, cutting tools (including a power saw), SCBA, and spare air cylinders.
-  2. All debris should be removed and the tool should be clean and dry. All fuel tanks should be filled completely with fresh fuel. Any dull or damaged blades/chains should be replaced. Belts should be inspected to ensure they are tight and undamaged. All guards should be securely in place. All hydraulic hoses should be cleaned and inspected. All power cords should be inspected for damage. All hose fittings should be cleaned, inspected, and tested to ensure tight fit. The tools should be started to ensure that they operate properly. Tanks on water vacuums should be emptied, washed, cleaned, and dried. Hoses and nozzles on water vacuums should be cleaned and dried.

Fire Fighter II in Action

1. *Answers will vary.*
2. *Answers will vary.*

Chapter 10: Ropes and Knots

Matching

- | | |
|-----------------|---|
| 1. E (page 272) | 6. J (page 265) |
| 2. G (page 263) | 7. H (page 261) |
| 3. A (page 271) | 8. D (page 271) |
| 4. I (page 272) | 9. F (page 265) |
| 5. B (page 263) |  10. C (pages 265–266) |

Multiple Choice

- | | |
|-----------------|---|
| 1. D (page 271) | 10. A (page 263) |
| 2. C (page 260) | 11. A (page 263) |
| 3. D (page 271) | 12. B (page 271) |
| 4. D (page 272) | 13. D (page 262) |
| 5. D (page 262) | 14. C (page 271) |
| 6. B (page 288) | 15. A (page 287) |
| 7. B (page 260) | 16. B (page 260) |
| 8. C (page 263) |  17. A (pages 265–266) |
| 9. C (page 268) | |

Labeling

1. Sections of a rope used in tying knots.

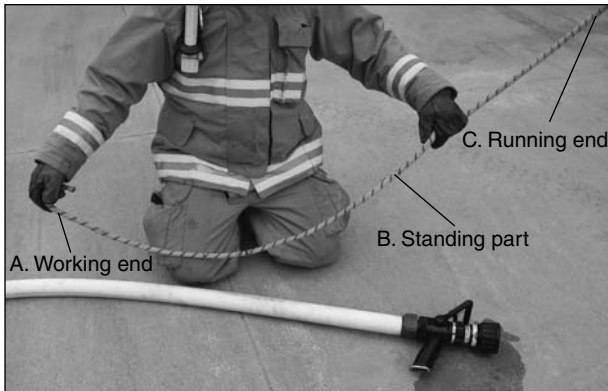

© Jones & Bartlett Learning. Photographed by Glen E. Ellman.

Figure 10-23

Vocabulary

1. **Running end:** The part of the rope used for lifting or hoisting. (page 271)
2. **Knot:** A prescribed way of fastening lengths of rope or webbing to objects or to each other. (page 271)
3. **Braided rope:** Ropes constructed by weaving or intertwining strands—typically synthetic fibers—together in the same way that hair is braided. (page 264)
4. **Rope bag:** A bag used to protect and store ropes. (page 270)
5. **Depressions:** Flat spots or lumps on the inside of the rope. (page 269)
6. **Shock load:** A shock load can occur when a rope is suddenly placed under unusual tension—for example, when someone attached to a life safety rope falls until the length of the rope or another rescuer stops the drop. (page 268)
7. **Kernmantle rope:** A rope that consists of two parts—the kern (interior component) and the mantle (outside sheath). (page 264)
8. **Working end:** The part of the rope used for forming the knot. (page 271)
9. **Round turn:** A turn formed by making a loop and then bringing the two ends of the rope parallel to each other. (page 271)
10. **Harness:** A piece of rescue or safety equipment made of webbing and worn by a person. (page 266)

Fill-in

- | | |
|---------------------------|-------------------------------|
| 1. Knots (page 271) | 6. secure loop (page 279) |
| 2. bight (page 271) | 7. round turn (page 271) |
| 3. Hitches (page 272) | 8. rope record (page 270) |
| 4. reduce (page 271) | 9. harness (page 266) |
| 5. safety knot (page 272) | 10. carabiner (pages 265–266) |

True/False

- | | |
|-----------------|-----------------|
| 1. T (page 261) | 5. T (page 261) |
| 2. T (page 272) | 6. F (page 262) |
| 3. F (page 268) | 7. T (page 265) |
| 4. T (page 272) | 8. T (page 271) |

Short Answer

1. The four parts of the rope maintenance formula are: (1) Care; (2) Clean; (3) Inspect; (4) Store (page 268)
2. The three types of rope construction are: (1) *Twisted*: Also called laid rope; made of individual fibers twisted into strands; strands are twisted together to make the rope. (2) *Braided*: Made by weaving or intertwining strands together, like braiding hair; all strands outside the rope are subject to abrasion; will stretch under a load, not prone to twisting; double-braided rope has an inner core covered by a protective braided sleeve, the inner core is protected from abrasion. (3) *Kernmantle*: Consists of two parts, the kern and the mantle; kern is the center core of the rope and provides about 70 percent of the rope's strength; mantle or sheath is the braided covering that protects the core; both parts are made with synthetic fibers, but fibers can be different for the kern and the mantle; each fiber in the kern extends the entire length of the rope without knots or splices, so that the inner core is protected from abrasion. (pages 263–264)
3. Eight simple knots and their usage in the fire service are: (1) *Safety knot (overhand knot)*: Secures the leftover working end of the rope to the standing part of the rope; used to finish knots. (2) *Half hitch*: Knot that wraps around an object; used with other knots. (3) *Clove hitch*: Used to attach a rope firmly to a round object; used to tie a hoisting rope around an axe or pike pole; can be tied anywhere in a rope. (4) *Figure eight*: Used to produce a family of other knots. (5) *Figure eight on a bight*: Creates a secure loop at the working end of a rope; loop can be used to attach the end of the rope to a fixed object or a piece of equipment, or to tie a life safety rope around a person. (6) *Figure eight follow-through*: Creates a secure loop at the end of the rope when the working end must be wrapped around an object or passed through an opening before the loop can be formed. (7) *Bowline*: Can be used to form a loop; frequently used to secure the end of a rope to an object or anchor point. (8) *Bend (sheet or Becket bend)*: Used to join two ropes together; sheet bend or Becket bend can be used to join two ropes of unequal size. (pages 272–279)
4. Four steps recommended for cleaning ropes are: (1) Wash the rope with mild soap and water. (2) Use a rope washer or machine, if recommended by the rope's manufacturer. (3) Air dry the rope out of direct sunlight. (4) Inspect the rope and replace it in the rope bag so that it is ready for use. (page 268)
5. The most common synthetic fiber ropes used for fire department operations are: (1) *Nylon*: Has a high melting temperature, has good abrasion resistance, strong and lightweight; (2) *Polyester*: Second most common synthetic fiber used for life safety ropes; (3) *Polypropylene*: Lightest of the synthetic fibers, does not absorb water, often used for water rescue (page 263)
6. Some of the drawbacks of using natural fiber ropes are that they: (1) Lose their load-carrying ability over time; (2) Are subject to mildew; (3) Absorb 50 percent of their weight in water; (4) Degrade quickly (page 262)
7. The principles to preserve the strength and integrity of rope are: (1) Protect the rope from sharp, abrasive surfaces. (2) Protect the rope from heat, chemicals, and flames. (3) Protect the rope from rubbing against another rope. (4) Protect the rope from prolonged exposure to sunlight. (5) Never step on a rope. (6) Follow the manufacturer's recommendations. (page 268)
8. Some of the advantages of using synthetic fiber ropes are: (1) Thinner without sacrificing strength; (2) Less absorbent than natural fiber ropes; (3) Greater resistance to rotting and mildew; (4) Longer-lasting than natural fiber ropes; (5) Greater strength and added safety; (6) More fire-retardant than natural fiber ropes (page 262)

Word Fun

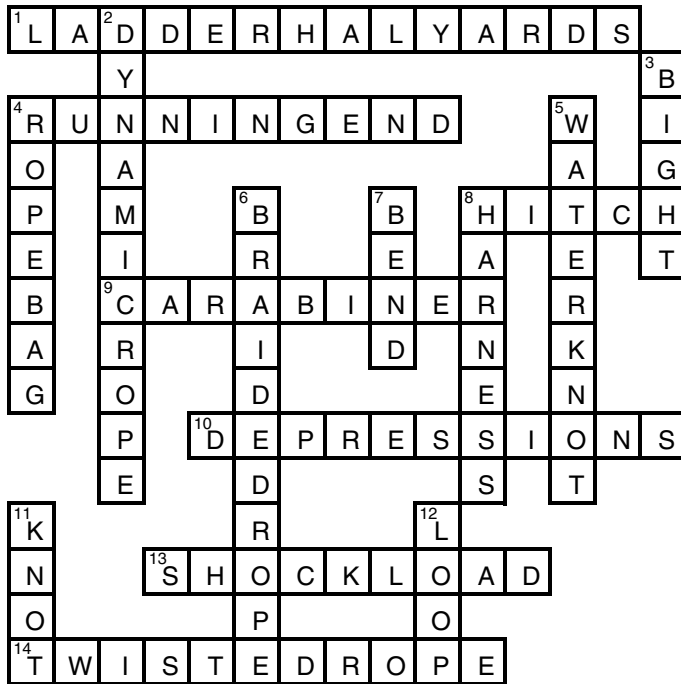

Fire Alarms

1. Tie a figure eight knot in the rope about 39 inches (1 meter) from the working end of the rope. Loop the working end of the rope around the fan handle and back to the figure eight knot. Secure the rope by tying a figure eight with a follow-through. Thread the working end back through the first figure eight in the opposite direction. Tie a safety knot in the working end of the rope. Attach a tag line to the fan for better control. Prepare to hoist the fan.
2. Many ropes made from synthetic fibers can be washed with a mild soap and water. A special rope washer can be attached to a garden hose. Some manufacturers recommend placing the rope in a mesh bag and washing it in a frontloading washing machine. Air-drying is usually recommended, but rope should not be dried in direct sunlight. The use of mechanical drying devices is not usually recommended. Life safety ropes must be inspected after each use, whether the rope was used for an emergency incident or in a training exercise. Inspect the rope visually, looking for cuts, frays, or other damage, as you run it through your fingers. Because you cannot see the inner core of a kernmantle rope, feel for any depressions. Examine the sheath for any discolorations, abrasions, or flat spots. If you have any doubt about whether the rope has been damaged, consult with your company officer.



Fire Fighter II in Action

1. Answers will vary.

Skill Drills

Skill Drill 10-5: Tying a Safety Knot

(page 273)



© Jones & Bartlett Learning. Photographed by Glen E. Ellman.

1. Take the **loose** end of the rope, beyond the **knot**, and form a loop around the **standing** part of the rope.



© Jones & Bartlett Learning. Photographed by Glen E. Ellman.

2. Pass the loose end of the rope through the **loop**.



© Jones & Bartlett Learning. Photographed by Glen E. Ellman.

3. Tighten the safety knot by pulling on **both ends** at the same time.



© Jones & Bartlett Learning. Photographed by Glen E. Ellman.

4. Test whether you have tied a safety knot correctly by sliding it on the **standing** part of the rope. A knot that is tied correctly will **slide**.

Skill Drill 10-10: Tying a Figure Eight on a Bight

(page 281)



© Jones & Bartlett Learning. Photographed by Glen E. Ellman.

1. Form a **bight** and identify the **closed** end of the bight as the **working end** of the rope.

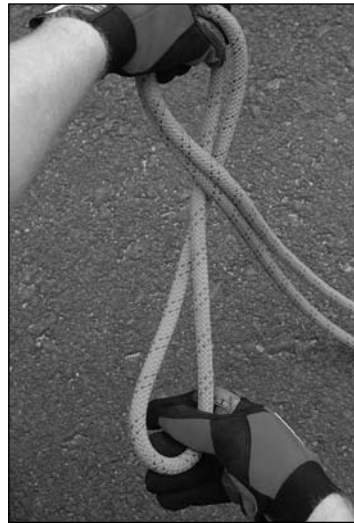

© Jones & Bartlett Learning. Photographed by Glen E. Ellman.

2. Holding both sides of the bight together, form a **loop**.



© Jones & Bartlett Learning. Photographed by Glen E. Ellman.

3. Feed the **working end** of the bight back through the **loop**.



© Jones & Bartlett Learning. Photographed by Glen E. Ellman.

4. Pull the **knot** tight.



© Jones & Bartlett Learning. Photographed by Glen E. Ellman.

5. Secure the loose end of the rope with a **safety knot**.

Skill Drill 10-13: Tying a Bowline

(page 284)



© Jones & Bartlett Learning. Photographed by Glen E. Ellman.

1. Make the desired sized loop and bring the working end back to the standing part.



© Jones & Bartlett Learning. Photographed by Glen E. Ellman.

2. Form another small loop in the standing part of the rope with the section close to the working end on top. Thread the working end up through this loop from the bottom.



© Jones & Bartlett Learning. Photographed by Glen E. Ellman.

3. Pass the working end over the loop, around and under the standing part, and back down through the same opening.



© Jones & Bartlett Learning. Photographed by Glen E. Ellman.

4. Tighten the knot by holding the working end and pulling the standard part of the rope backward.



© Jones & Bartlett Learning. Photographed by Glen E. Ellman.

5. Tie a safety knot in the working end of the rope.

Skill Drill 10-19: Hoisting a Charged Hose Line

(page 291)



© Jones & Bartlett Learning. Photographed by Glen E. Ellman.

1. Make sure that the nozzle is completely **closed** and secure. Use a **clove hitch**, 1 or 2 feet (0.3–0.6 meters) behind the nozzle, to tie the end of the **hoisting rope** around a charged hose line. Use a **safety knot** to secure the loose end of the rope below the **clove hitch**.



© Jones & Bartlett Learning. Photographed by Glen E. Ellman.

2. Make a **bight** in the rope even with the nozzle shut-off handle. Insert the **bight** through the handle opening and slip it over the end of the **nozzle**. When the bight is pulled tight, it will create a **half hitch** and secure the handle in the **off** position while the charged hose line is hoisted. Communicate with the fire fighter above that the hose line is ready to hoist.

Chapter 11: Response and Size-Up

Matching

1. C (page 300)
2. I (page 304)
3. H (page 308)
4. F (page 313)
5. A (page 304)
6. B (page 308)
7. D (page 310)
8. J (page 311)
9. E (page 300)
10. G (page 314)

Multiple Choice

1. A (page 308)
2. A (page 306)
3. C (page 301)
4. C (page 309)
5. C (page 311)
6. D (page 304)
7. C (page 313)
8. A (page 303)
9. D (page 313)
10. B (page 308)
11. A (page 302)
12. B (page 309)
13. B (page 304)
14. D (page 309)
15. A (page 311)
16. B (page 312)
17. A (page 312)
18. D (page 311)
19. C (page 306)
20. C (page 305)

Vocabulary

1. **Personnel accountability tag (PAT):** An identification card used to track the location of a fire fighter on an emergency incident. (page 304)
2. **Size-up:** The ongoing observation and evaluation of factors that are used to develop objectives, strategy, and tactics for fire suppression. (page 300)
3. **Thermal imaging devices:** Electronic cameras that can detect sources of heat. They are valuable tools for finding fires in void spaces and hence for containing the spread of fire. (page 313)
4. **Freelancing:** The dangerous practice of acting independently of command instructions. (page 304)
5. **Response actions:** Include receiving the alarm, donning protective clothing and equipment, mounting the apparatus, and transporting equipment and personnel to the emergency incident quickly and safely. (page 300)

Fill-in

1. Probabilities (page 309)
2. overhaul (page 314)
3. reconnaissance (page 309)
4. systematic (page 306)
5. secured (page 301)
6. quarter (page 306)
7. offensive (page 313)
8. size-up (page 300)
9. balloon-frame (page 308)
10. defensive (page 313)

True/False

1. F (page 313)
2. F (page 306)
3. T (page 304)
4. F (page 303)
5. F (page 309)
6. T (page 303)
7. T (page 301)
8. T (page 303)
9. T (page 304)
10. F (page 302)

Fire Alarms

1. Consider approaching traffic, including other emergency vehicles, and other, less-obvious hazards. Always check for traffic before opening doors and dismounting from the apparatus. Watch out for traffic when working in the street. Follow departmental standard operating procedures (SOPs) to close streets quickly and to block access to areas where operations are being conducted. Place traffic cones, flares, and other warning devices far enough away from the incident to slow approaching traffic and to direct it away from the work area.
2. When the fire is too large or too dangerous to extinguish with an offensive attack, the IC will implement a defensive strategy. A defensive strategy is required when the IC determines that the risk to fire fighters' lives is excessive, as in situations where structural collapse is possible. The IC who adopts a defensive strategy has determined that there is no property left to save or that the potential for saving property does not justify the risk to fire fighters.



Fire Fighter II in Action

1. Answers will vary.
2. Answers will vary.
3. Answers will vary.

Skill Drills

Skill Drill 11-1: Mounting Apparatus

(page 302)



© Jones & Bartlett Learning. Photographed by Glen E. Ellman.

1. When mounting (climbing aboard) fire apparatus, always have at least one hand firmly grasping a **handhold** and at least one foot firmly placed on a foot surface. Maintain the one hand and one foot placement until you are **seated**.



© Jones & Bartlett Learning. Photographed by Glen E. Ellman.

2. Fasten your seat belt and then don any other required safety equipment for response, such as **hearing protection** and intercom.

Chapter 12: Forcible Entry

Matching

- | | |
|-----------------|------------------|
| 1. J (page 344) | 6. A (page 326) |
| 2. F (page 320) | 7. H (page 323) |
| 3. C (page 323) | 8. G (page 325) |
| 4. I (page 338) | 9. D (page 325) |
| 5. E (page 323) | 10. B (page 325) |

Multiple Choice

- | | |
|------------------|-------------------|
| 1. A (page 325) | 12. C (page 320) |
| 2. C (page 344) | 13. B (page 326) |
| 3. A (page 339) | 14. B (page 338) |
| 4. A (page 330) | 15. A (page 322) |
| 5. D (page 340) | 16. D (page 333) |
| 6. B (page 320) | 17. B (page 323) |
| 7. B (page 333) | 18. C (page 336) |
| 8. C (page 339) | 19. C (page 326) |
| 9. C (page 328) | 20. D (page 324) |
| 10. A (page 338) | 21. D. (page 322) |
| 11. C (page 322) | |

Labeling

1. Basic parts of a door lock. (page 339)

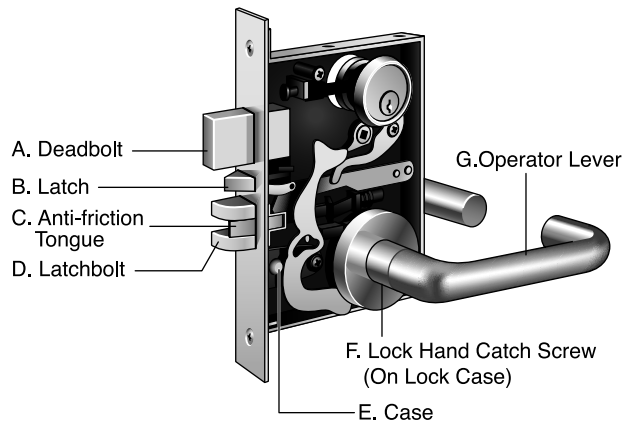
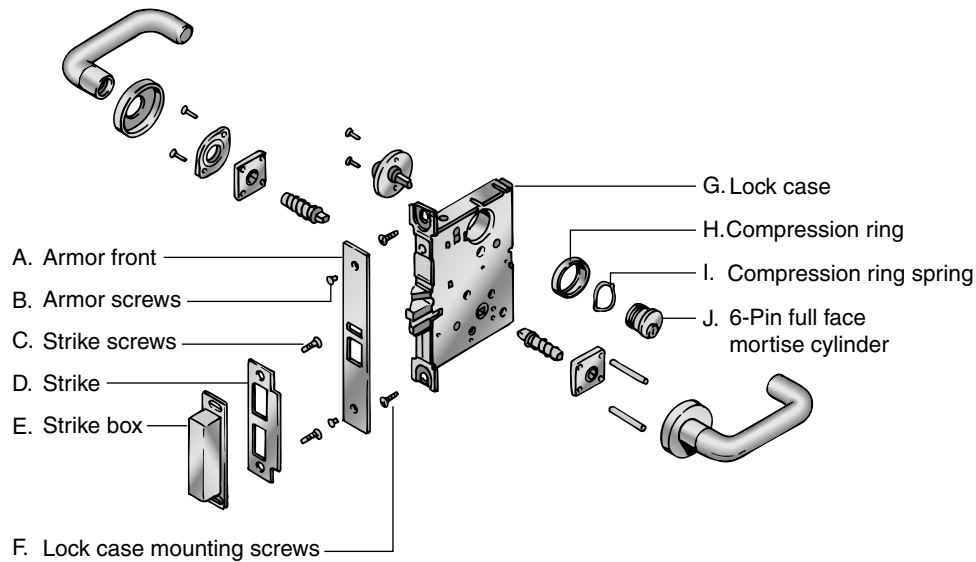

Figure 12-22

2. Basic parts of a portable fire extinguisher. (page 341)



© Jones & Bartlett Learning. Photographed by Glen E. Ellman.

Figure 12-26

Vocabulary

- Casement windows:** Windows in a steel or wood frame that open away from the building via a crank mechanism. (page 336)
- Projected windows:** Also called factory windows, usually found in older warehouse or commercial buildings. They project inward or outward on an upper hinge. (page 337)
- Rabbet:** A type of door frame in which the stop for the door is cut into the frame. (page 323)
- Mortise locks:** Door locks with both a latch and a bolt built into the same mechanism; the two locking mechanisms operate independently of each other. Mortise locks are often found in hotel rooms. (page 340)
- Tempered glass:** A type of glass that is heat treated, making it four times stronger than regular glass. (page 333)
- K tool:** A tool that is designed to cut into a lock cylinder. (page 324)
- Cylindrical locks:** The most common fixed lock in use today. The locks and handles are placed into predrilled holes in the doors. One side of the door will usually have a key-in-the-knob lock; the other side will have a keyway, a button, or some other type of locking/unlocking mechanism. (page 339)
- Jalousie windows:** Made of adjustable sections of tempered glass that overlap each other, encased in a metal frame. Commonly found in mobile homes, these are operated by a hand crank. (page 334)
- Jamb:** The part of a doorway that secures the door to the studs in a building. (page 325)

Fill-in

- Bolt cutters (pages 324)
- rabbet tool (page 323)
- critical (page 320)
- Double-hung (page 333)
- security (page 331)
- Awning (page 336)
- ready (page 321)
- Windows (page 331)
- Battery (page 324)
- Revolving (page 330)
- carbide (page 324)

True/False

1. T (page 325)
2. T (page 344)
3. T (page 320)
4. T (page 323)
5. F (page 323)
6. F (page 345)
7. F (page 328)
8. T (page 333)
9. F (page 340)
10. F (page 332)
11. T (page 330)

Short Answer

1. The four general carrying tips are: (1) Do not carry a tool or piece of equipment that is too heavy or designed to be used by more than one person. (2) Always use your legs—not your back—when lifting heavy tools. (3) Keep all sharp edges and points away from your body at all times. Cover or shield them with a gloved hand to protect those around you. (4) Carry long tools with the head down toward the ground. Be aware of overhead obstructions and wires, especially when using pike poles. (page 321)
2. The four categories of forcible entry tools are: (1) Striking tools; (2) Cutting tools; (3) Prying tools; (4) Lock tools (page 322)
3. The four general safety tips are: (1) Always wear the appropriate protective equipment. (2) Learn to recognize the materials used in building and lock construction and the appropriate tools and techniques for each. (3) Keep all tools clean, properly serviced according to the manufacturer's guidelines, and ready to use. (4) Do not leave tools lying on the ground or floor. (page 321)
4. The four basic components of a door are: (1) Door (the entryway); (2) Jamb (the frame); (3) Hardware (the handles, hinges, etc.); (4) Locking device (page 325)

Word Fun

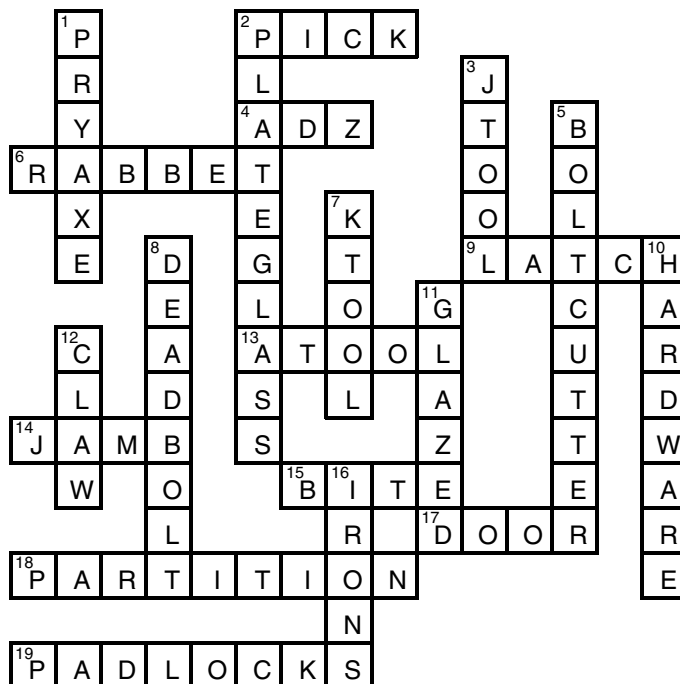

Fire Alarms

1. The quickest way to force through a security roll-up door is to cut the door with a torch or saw. Make the cut in the shape of a triangle, with the point at the top. Pad the opening to prevent injury to those entering and exiting through the opening.

2. First try before you pry. Then, break one of the glass doors and clear the glass from the steel frame. Simply unlock the door by turning the lock. Block the door open by using a wedge. Enter the classroom and overhaul the fire.

Fire Fighter II in Action

1. Answers will vary.

Skill Drills

Skill Drill 12-1: Forcing Entry into an Inward-Opening Door

(page 328)



© Jones & Bartlett Learning. Photographed by Glen E. Ellman.

1. Size up the door, looking for any **safety hazards**. Inspect the door for the location and number of locks and mechanisms.



© Jones & Bartlett Learning. Photographed by Glen E. Ellman.

4. Once the tool is past the stop but between the door and the jamb, push the Halligan tool toward the door to force it open. If more leverage is needed, your partner can slide the **axe head** between the **bevel** of the Halligan tool and the door.



© Jones & Bartlett Learning. Photographed by Glen E. Ellman.

2. Place the **adz** of the Halligan tool into the door frame between the door jamb and the door stop, near the lock, with the **beveled** end of the tool against the door.



© Jones & Bartlett Learning. Photographed by Glen E. Ellman.

3. Once the Halligan tool is in position, have your partner, on your command, drive the tool farther into the gap between the **rabbeted jamb** or stop and the door. Make sure that the tool is not driven into the door jamb itself.

Skill Drill 12-4: Forcing Entry Through a Wooden Double-Hung Window

(page 334)



© Jones & Bartlett Learning. Photographed by Glen E. Ellman.

1. Size up the window for any safety hazards and locate the **locking mechanism**.



© Jones & Bartlett Learning. Photographed by Glen E. Ellman.

2. Place the **pry end** of the Halligan tool under the bottom sash in line with the locking mechanism.



© Jones & Bartlett Learning. Photographed by Glen E. Ellman.

3. Pry the **bottom sash** upward to displace the locking mechanism. Secure the window so that it does not close.

Chapter 13: Ladders

Matching

- | | |
|-----------------|------------------|
| 1. A (page 359) | 6. D (page 357) |
| 2. B (page 357) | 7. F (page 357) |
| 3. H (page 359) | 8. I (page 356) |
| 4. E (page 359) | 9. G (page 357) |
| 5. J (page 359) | 10. C (page 357) |

Multiple Choice

1. C (page 359)
2. A (page 361)
3. C (page 388)
4. B (page 366)
5. D (page 368)
6. C (page 361)
7. A (page 357)
8. A (page 389)
9. A (page 359)
10. B (page 357)
11. D (page 359)
12. C (page 371)
13. B (page 366)
14. B (page 381)
15. D (page 357)
16. C (page 359)
17. C (page 369)
18. D (page 381)
19. D (page 367)
20. A (page 360)
21. A (page 371)
22. B (page 367)
23. C (page 357)
24. B (page 359)
25. B (page 360)
26. A (page 358)
27. D (page 357)
28. A (page 357)

Labeling

1. Basic components of a straight ladder. (page 357)

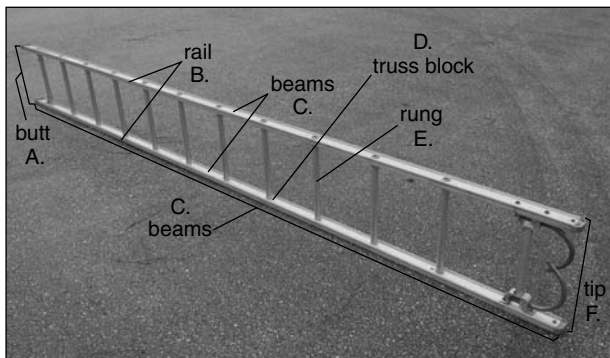

© Jones & Bartlett Learning. Photographed by Glen E. Ellman.

Figure 13-2

Vocabulary

1. **Guides:** Strips of metal or wood that guide a fly section of an extension ladder as it is being extended. (page 358)
2. **Ladder belt:** A piece of equipment specifically designed to secure a fire fighter to a ladder or elevated surface. (page 393)
3. **Heat sensor label:** A label that identifies when the ladder has been exposed to specific heat conditions that could damage its structural integrity. (page 358)
4. **Tie rod:** Metal bar that runs from one beam of the ladder to the other and keeps the beams from separating. Tie rods are typically found in wood ladders. (page 357)
5. **Roof hooks:** Spring-loaded, retractable, curved metal pieces that are attached to the tip of a roof ladder. These hooks are used to secure the tip of the ladder to the peak of a pitched roof. (page 357)
6. **Protection plates:** Reinforcing pieces that are placed on a ladder at chaffing and contact points to prevent damage from friction or contact with other surfaces. (page 358)
7. **Pawls:** The mechanical locking devices that are used to secure the extended fly sections of an extension ladder. They are sometimes called dogs, ladder locks, or rung locks. (page 359)

8. **Bed section:** The widest section of an extension ladder. It serves as the base; all other sections are raised from the bed section. (page 358)
9. **Halyard:** The rope or cable used to extend or hoist the fly sections of an extension ladder. (page 359)
10. **Pulley:** A small grooved wheel that is used to change the direction of the halyard pull. A downward pull on the halyard creates an upward force on the fly sections, extending the ladder. (page 359)

Fill-in

- | | |
|---------------------------|-------------------------------|
| 1. extension (page 358) | 7. straight (page 360) |
| 2. leg lock (page 393) | 8. rungs (page 357) |
| 3. combination (page 361) | 9. Aerial (page 359) |
| 4. three (page 392) | 10. equipment (page 357) |
| 5. portable (page 356) | 11. manufacturer's (page 362) |
| 6. webbing (page 389) | |

True/False

- | | |
|-----------------|------------------|
| 1. F (page 357) | 7. F (page 372) |
| 2. F (page 357) | 8. F (page 360) |
| 3. F (page 360) | 9. T (page 387) |
| 4. T (page 356) | 10. T (page 356) |
| 5. F (page 387) | 11. F (page 396) |
| 6. T (page 368) | 12. F (page 357) |

Short Answer

1. For the five steps to apply a leg lock to work from a ladder, follow the steps in Skill Drill 13-19. (1) Climb to the desired work height and step up one more rung. (2) Note the side of the ladder where the work will be performed. Extend the leg on the opposite side between the rungs. (3) Once the leg is between the rungs, bend the knee and bring that foot back under the rung and through to the climbing side of the ladder. (4) Secure the foot against the next lower rung or the beam of the ladder. Use the thigh for support and step down one rung with the opposite foot. (5) You are now free to lean out to the side of the ladder and work with two hands on the tool. (page 393)
2. Basic safety concerns when using ladders are (*Students should include five of the following*): (1) General safety; (2) Lifting and moving ladders; (3) Placement of ground ladders; (4) Working on a ladder; (5) Rescue operations; (6) Ladder damage. (page 366)
3. The three basic types of beam construction are: (1) *Trussed beam*: Has a top rail and a bottom rail, which are joined by a series of smaller pieces called truss blocks. The rungs are attached to the truss blocks. Trussed beams are usually constructed of aluminum or wood. (2) *I-beam*: Has thick sections at the top and the bottom, which are connected by a thinner section. The rungs are attached to the thinner section of the beam. This type of beam is usually made from fiberglass. (3) *Solid beam*: Has a simple rectangular cross-section. Many wooden ladders have solid beams. Rectangular aluminum beams, which are usually hollow or C shaped, are also classified as solid beams. (page 357)
4. Fundamental ladder maintenance tasks are (*Students should include five of the following*): (1) Clean and lubricate the dogs, following the manufacturer's instructions. (2) Clean and lubricate the slides on extension ladders in accordance with the manufacturer's recommendations. (3) Replace worn halyards and wire rope on extension ladders when they fray or kink. (4) Clean and lubricate hooks. Remove rust and other contaminants, and lubricate the folding roof hook assemblies on roof ladders to keep them operational. (5) Check the heat sensor labels. Replace the sensors when they reach their expiration date. Remove from service a ladder that has been exposed to high temperatures for testing. (6) Maintain the finish on fiberglass and wooden ladders in accordance with the manufacturer's recommendations. (7) Ensure that portable ladders are not painted except for the top and bottom 18 inches (45.2 centimeters) of each section, because paint can hide structural defects in the ladder. The tip and butt are painted for purposes of identification and visibility. (8) Maintenance records should be kept. (pages 363–364)

Word Fun

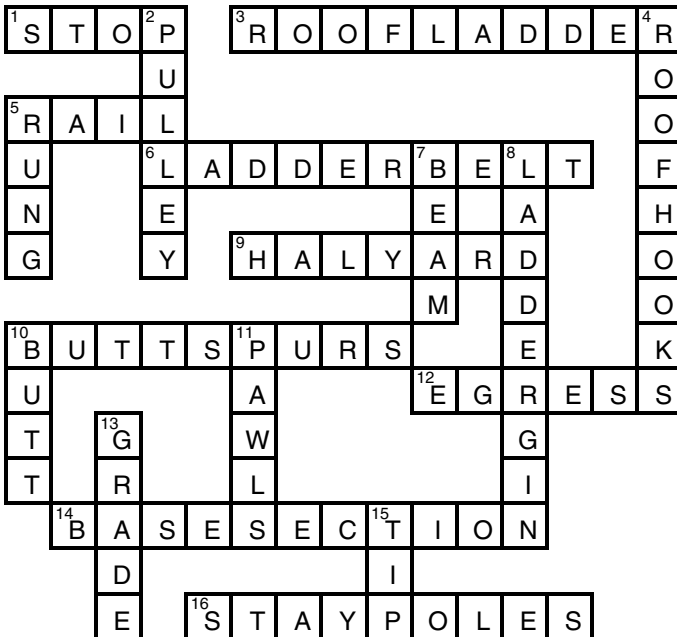

Fire Alarms

1. During rescue operations, the tip of the ladder should be immediately below the windowsill. This prevents the ladder from obstructing the window opening while a trapped occupant is removed. Remove the roof ladder from the apparatus. Choose an appropriate ladder carry for the obstacles that you will have to maneuver around. Deploy the roof ladder up the extension ladder. Remember to use a leg lock or ladder belt to secure yourself to the ladder. Place the roof ladder on the roof, ensuring the hooks are pointing down.
2. Think safety first. A person who is in extreme danger may not wait to be rescued. Jumpers risk their own lives and may endanger the fire fighters trying to rescue them. Several fire fighters have been seriously injured by persons who jumped before a rescue could be completed. A trapped person might try to jump onto the tip of an approaching ladder, or to reach out for anything or anyone nearby. You might be pulled or pushed off the ladder by the person you are trying to rescue.



Fire Fighter II in Action

1. Answers will vary. Review your fire department SOGs for placing a roof ladder, or review the steps on pages 393 and 395.

Skill Drills

Skill Drill 13-2: One-Fire-Fighter Carry

(page 372)



© Jones & Bartlett Learning. Photographed by Glen E. Ellman.

1. Start with the ladder mounted in a bracket or standing on one **beam**. Locate the **center** of the ladder. Place an arm between two rungs of the ladder just to one side of the **middle** rung.



© Jones & Bartlett Learning. Photographed by Glen E. Ellman.

2. Lift the top **beam** of the ladder and rest it on your **shoulder**.



© Jones & Bartlett Learning. Photographed by Glen E. Ellman.

3. Walk carefully with the **butt** end first.

Skill Drill 13-3: Two-Fire Fighter Shoulder Carry

(page 373)



1. Start with the ladder mounted in a bracket or standing on one beam. Both fire fighters are positioned on the same side of the ladder. Facing the butt end of the ladder, one fire fighter is positioned near the butt end of the ladder and a second fire fighter is positioned near the tip of the ladder.



2. Both fire fighters place one arm between two rung and, on the leader's command, lift the ladder onto their shoulders. The ladder is carried butt end first.



© Jones & Bartlett Learning. Photographed by Glen E. Ellman.

3. The butt spurs are covered with a gloved hand while the ladder is transported.

Skill Drill 13-13: Tying the Halyard

(page 384)



© Jones & Bartlett Learning. Photographed by Glen E. Ellman.

1. **Wrap** the excess halyard rope around two rungs of the ladder and pull the rope tight across the **upper** of the two rungs.



© Jones & Bartlett Learning. Photographed by Glen E. Ellman.

2. Tie a(n) **clove hitch** around the upper rung and the vertical section of the halyard.



© Jones & Bartlett Learning. Photographed by Glen E. Ellman.

3. **Pull** the clove hitch tight.



© Jones & Bartlett Learning. Photographed by Glen E. Ellman.

4. Place an overhand **safety knot** as close to the clove hitch as possible to prevent **slipping**.

Skill Drill 13-19: Use a Leg Lock to Work from a Ladder

(page 394)



1. Climb to the desired work height and step up to one more rung.



2. Note the side of the ladder where the work will be performed. Extend your leg between the rungs on the side opposite the side you will be working.



3. Once your leg is between the rungs, bend your knee and bring your foot back under the rung and through to the climbing side of the ladder.



4. Secure your foot against the next lower rung or the beam of the ladder. Use your thigh for support and step down one rung with the opposite foot.



© Jones & Bartlett Learning. Courtesy of MIEMSS.

5. The use of a leg lock enables you to have two hands free for a variety of tasks.

Chapter 14: Search and Rescue

Matching

1. G (page 407)
2. I (page 407)
3. H (page 404)
4. C (page 404)
5. D (page 417)
6. B (pages 404, 438)
7. F (page 404)
8. A (pages 415, 438)
9. E (pages 409, 438)
10. J (pages 413, 438)

Multiple Choice

1. D (pages 413, 414)
2. A (page 418)
3. C (page 431)
4. D (pages 432, 434)
5. A (page 424)
6. C (page 433)
7. B (page 414)
8. A (page 429)
9. A (page 407)
10. D (page 407)
11. B (page 424)
12. D (page 428)
13. B (page 407)
14. D (page 407)
15. A (page 405)
16. A (page 413)
17. C (page 408)
18. D (page 418)
19. B (page 424)
20. A (page 421)
21. D (pages 410–413)
22. C (page 412)

Vocabulary

1. **Exit assist:** The simplest rescue if the victim is responsive and able to walk without assistance or with very little assistance. (page 418)
2. **Shelter-in-place:** When the occupants are sheltered and kept in their present location instead of trying to remove them from a fire building. (page 417)
3. **Two-in/two-out rule:** The NFPA requirements state that a team of at least two fire fighters must enter together, and at least two other fire fighters must remain outside the danger area, ready to rescue the fire fighters who are inside the building. (page 417)
4. **Primary search:** A quick attempt to locate any potential victims who are in danger. (page 407)
5. **Transitional attack:** An offensive fire attack initiated by an exterior indirect handline operation into the fire compartment to initiate cooling while transitioning into an interior attack. (page 404)

Fill-In

1. lives (page 404)
2. crawl (page 408)
3. greater (page 405)
4. risk (page 415)
5. secondary (page 408)
6. marked (page 412)
7. incident commander, officer in charge, fire fighter (page 404)
8. transitional attack (page 404)
9. controlling; extinguishing (page 407)
10. Sounding floors (page 416)
11. fire flow path (page 407)
12. standard search (page 410)

True/False

1. T (page 405)
2. T (page 415)
3. T (page 417)
4. T (page 406)
5. T (page 417)
6. T (page 407)
7. F (page 405)
8. T (page 405)
9. T (*Note: True is the correct answer; however, the paragraph containing this statement was removed from the book chapter.*)
10. T (page 410)

Short Answer

1. Benefits of thermal imaging include (*Students should include three of the following*): (1) Identify the shape of a human body; (2) Show furniture, walls, doorways, and windows; (3) Navigate through the interior of a smoke-filled building; (4) Locate a fire in a smoke-filled building or behind walls or ceilings; (5) Locate the fire source and the direction of fire spread from the exterior; (6) Scanning a door before opening it can indicate whether the room is safe to enter. (page 409)
2. Search and rescue equipment includes (*Students should include six of the following*): (1) Personal protective equipment (PPE); (2) Portable radio; (3) Hand light or flashlight; (4) Forcible entry (exit) tools; (5) Hose lines; (6) Thermal imagers; (7) Ladders; (8) Long ropes; (8) A piece of tubular webbing or short rope (16 to 24 feet [4.9 to 7.3 meters]). (page 416)
3. The six tips fire fighters need to remember during search and rescue operations are: (1) Work from a single plan. (2) Maintain radio contact with the incident commander (IC), both through the chain of command and via portable radios. (3) Monitor fire conditions during the search. (4) Coordinate ventilation operations with search and rescue activities. (5) Adhere to the personal accountability system. (6) Stay with a partner. (page 417)
4. Pieces of valuable information a preincident plan can provide for search and rescue operations include (*Students should include five of the following*): (1) Corridor layouts; (2) Exit locations; (3) Stairway locations; (4) Apartment layouts; (5) Number of bedrooms in apartments; (6) Locations of handicapped residents' apartments; (7) Special-function rooms or areas. (page 407)
5. The four simple carries that can be used to move a victim who is conscious and responsive, but incapable of standing or walking are: (1) Two-person extremity carry; (2) Two-person seat carry; (3) Two-person chair carry; (4) Cradle-in-arms carry. (page 418)
6. Considerations for search and rescue size-up include (*Students should include four of the following*): (1) Occupancy; (2) Size of the building; (3) Construction of the building; (4) Time of day and day of week; (5) Number of occupants; (6) Degree of risk to the occupants presented by the fire; (7) Ability of occupants to exit on their own. (page 405)
7. Sounding the floor is not a valid measure of stability. Sounding floors to determine if they are stable is a dangerous practice to be discouraged. (page 416)
8. Disadvantages of the standard search include the following each searcher must be responsible for monitoring his or her own air supply, and monitoring his or her safety as related to changes in the fire situation, structural stability, and other fire ground operations. This has the tendency to divide the searchers' attention. It is likely that these rescuers may not notice deteriorating conditions. Also, they may fail to monitor the status of their own air supplies. Another disadvantage is that if a victim is located, the searchers will exit with that victim and the continuity of the search is more likely to be lost than if using the oriented-team search method. This means that it is hard to make and follow a systematic plan for searching that does not miss areas that need to be searched. (page 410)
9. O-VEIS should be considered only when the room is tenable for a potential victim. It should not be attempted if the room is fully charged with smoke and in danger of flashing over when additional oxygen is introduced. O-VEIS should be used only in dire emergencies in which a sizeable risk has a large potential benefit. (page 413)

Fire Alarms

1. Make sure you have a single communicated plan. Maintain radio contact with the IC using the chain of command, monitor fire conditions during the search, coordinate ventilation with your search and rescue activities, maintain your accountability system, stay with your team, and carry a thermal imager if at all possible to speed up the search and help locate exits and hazards.
2. The search and rescue needs to be coordinated with suppression and ventilation. It would also be necessary to position a hose line to protect the entry and exit paths. A marking system should be used to indicate which rooms have been searched.



Fire Fighter II in Action

Questions 1–2: *Answers will vary.*

Skill Drills

Skill Drill 14-6: Performing a Two-Person Extremity Carry

(page 421; Note: This skill drill is misnumbered in the workbook as Skill Drill 14-5.)



© Jones & Bartlett Learning. Photographed by Glen E. Ellman.

1. Two fire fighters help the victim to **sit** up.



© Jones & Bartlett Learning. Photographed by Glen E. Ellman.

2. The first fire fighter kneels **behind** the victim, reaches under the victim's arms, and grasps the victim's **wrists**.



© Jones & Bartlett Learning. Photographed by Glen E. Ellman.

3. The second fire fighter backs in between the victim's **legs**, reaches around, and grasps the victim behind the **knees**.



© Jones & Bartlett Learning. Photographed by Glen E. Ellman.

4. The first fire fighter gives the command to stand and carry the victim away, walking straight ahead. Both fire fighters must **coordinate** their movements.

Skill Drill 14-8: Performing a Two-Person Chair Carry

(page 423; Note: This skill drill is misnumbered in the workbook as Skill Drill 14-7.)



© Jones & Bartlett Learning. Photographed by Glen E. Ellman.

1. One fire fighter stands behind the seated victim, reaches down, and grasps the **back** of the chair.



© Jones & Bartlett Learning. Photographed by Glen E. Ellman.

2. The fire fighter tilts the chair backward on its rear legs so that the second fire fighter can step back between the legs of the chair and grasp the tips of the chair's **front legs**. The victim's legs should be **between** the legs of the chair.



© Jones & Bartlett Learning. Photographed by Glen E. Ellman.

3. When both fire fighters are correctly positioned, the fire fighter **behind** the chair gives the command to lift and walk away. Because the chair carry may force the victim's head **forward**, watch the victim for airway problems.

Skill Drill 14-18: Rescuing an Unconscious Victim from a Window

(page 433; Note: This skill drill is misnumbered in the workbook as Skill Drill 14-17.)



© Jones & Bartlett Learning. Photographed by Glen E. Ellman.

1. Place the tip of the ladder just **below** the windowsill.



© Jones & Bartlett Learning. Photographed by Glen E. Ellman.

2. One fire fighter enters to rescue the victim. The second fire fighter **climbs** to the window.



© Jones & Bartlett Learning. Photographed by Glen E. Ellman.

3. The fire fighter waiting on the ladder places both hands on the rungs, with one leg straight and the other horizontal to the ground with the knee at an angle of **90 degrees**. The interior fire fighter passes the victim through the window and onto the ladder, keeping the victim's **back** toward the ladder.



© Jones & Bartlett Learning. Photographed by Glen E. Ellman.

4. The victim is lowered so that he or she **straddles** the fire fighter's leg. The fire fighter's arms should be positioned under the victim's arms, holding on to the **rungs**. Step down one rung at a time, transferring the victim's weight from one leg to the other. The victim's arms can also be secured around the fire fighter's neck.

Chapter 15: Ventilation

Matching

1. I (page 466)
2. F (page 464)
3. H (pages 449, 483)
4. C (pages 466, 483)
5. G (page 465)
6. B (page 447)
7. E (page 457)
8. A (page 450)
9. J (page 466)
10. D (page 448)

Multiple Choice

1. C (page 457)
2. A (page 458)
3. D (page 473)
4. B (page 463)
5. D (page 468)
6. D (page 442)
7. C (page 472)
8. A (page 452)
9. B (page 465)
10. A (page 442)
11. C (page 464)
12. B (page 466)
13. C (page 444)
14. C (page 451)
15. A (page 449)
16. A (page 461)
17. D (page 460)
18. B (page 453)
19. D (page 444)
20. C (page 452)
21. B (page 443)
22. D (page 449)
23. A (page 445)
24. C (page 447)
25. D (page 466)

Vocabulary

1. **Smoke inversion:** The condition in which smoke hangs low to the ground on a cool, damp day with very little wind. (pages 451, 484)
2. **Sounding:** The process of striking a roof with a tool to test the roof's stability. (pages 463, 484)
3. **Ventilation:** The fire-fighting operation of removing smoke and heat from a structure by opening windows and doors or making holes in the roof. (pages 442, 484)
4. **Ordinary construction:** Buildings whose exterior walls are made of noncombustible or limited-combustible materials that support the roof and floor assemblies. The interior walls and floors are usually wood construction. (pages 449, 484)
5. **Fire-resistive construction:** A building in which all of the structural components are made of noncombustible or limited-combustible materials. (pages 449, 483)
6. **Gusset plates:** Connecting plates used in trusses, typically made of wood or lightweight metal. (pages 465, 483)
7. **Vertical ventilation:** The process of making openings in roofs or floors so that smoke, heat, and toxic gases can escape vertically from a structure. (pages 451, 461, 484)
8. **Stack effect:** A response to the differences in temperature inside and outside a building. A cold outer atmosphere and a heated interior will cause smoke to rise quickly through stairways, elevator shafts, and other vertical openings, filling the upper levels of the building. (pages 477, 484)

9. **Horizontal ventilation:** Using horizontal openings in the structure, such as windows and doors, to allow smoke, heat, and gases to escape horizontally from a building. (pages 451, 452, 483)
10. **Flow path:** The volume in a structure between an inlet and an outlet that allows the movement of heat and smoke from the higher pressure within the fire area towards the lower pressure areas accessible via doorways, halls, stairs, and window openings. (pages 446, 483)
11. **Fuel-limited fire:** Fire that has sufficient oxygen for fire growth, but has a limited amount of fuel available for burning. (pages 443, 483)

Fill-In

1. roof collapse (page 464)
2. Trench cut (page 474)
3. Hydraulic (page 461)
4. Ventilation-limited (page 446)
5. transitional (page 447)
6. Horizontal (pages 451, 483)
7. upwind (page 463)
8. bowstring (page 468)
9. high (page 460)
10. Wind (page 446)

True/False

1. T (page 468)
2. T (page 451)
3. F (page 449)
4. F (page 447)
5. F (page 461)
6. T (page 451)
7. T (page 477)
8. F (page 469)
9. T (page 466)
10. T (page 476)

Short Answer

1. One of the first actions taken by most fire departments at a structure fire is to gain access to the building by opening the front door. This action changes the ventilation profile of the fire. It results in additional cool air being supplied to the fire. This can rapidly change a ventilation-limited fire into a fuel controlled fire. If you limit the air inlet, you will limit the fire's ability to grow. The simple act of closing the front door after forcing entry will limit the air supply to the fire and slow the fire growth until a crew is ready to make access to the building and perform a coordinated fire attack. (page 444)
2. A secondary cut is used to limit the fire spread; a primary cut is located over the seat of the fire. (pages 474, 484)
3. The objective of any roof ventilation operation is simple: to provide the largest opening in the appropriate location, using the least amount of time and the safest technique. (page 468)
4. Five indicators that it is time for immediate retreat from the roof of a structure are: (1) Any visible indication of sagging roof supports; (2) Any indication that the roof assembly is separating from the walls, such as the appearance of fire or smoke near the roof edges; (3) Any structural failure of any portion of the building, even if it is some distance from the ventilation operation; (4) Any sudden increase in the intensity of the fire from the roof opening; (5) High heat indicators on a thermal imaging camera. (page 464)

-  5. The tactical priorities in structural firefighting operations and how the tactical priorities affect ventilation operations are:

Venting for Life Safety and Containment. Life safety and containment are the primary goals of the fire service, whether it involves rescuing civilians or protecting fire department personnel. Good ventilation practices help to clear smoke, heat, and toxic gases from the structure, which gives occupants a better chance to survive. It provides firefighting crews with increased visibility and makes the structure more tenable, enabling more rapid searches for victims.

Ventilation in coordination with an effective transitional fire attack cools the interior of the building, limits fire spread, and allows fire fighters to advance hose lines more safely and rapidly to attack the fire. A coordinated fire attack and ventilation effort must consider the timing and the direction of the attack, as well as the type and location of possible ventilation openings. The swift control of the fire reduces the risk to fire fighters as well as to building occupants.

Venting for Property Conservation. Another priority of the fire service is property conservation, which involves reducing the losses caused by means other than direct involvement in the fire. Because much of the damage from a fire can be smoke damage, ventilation can play a significant role in limiting property damage. If a structure is ventilated rapidly and correctly, the damages associated with smoke, heat, water, and overhaul operations can all be reduced. (page 450; *Note that venting for life safety and fire containment are now combined.*)

Fire Alarms

1. Sound the roof with a tool to locate the roof supports. Make two parallel cuts, perpendicular to the roof supports. Do not cut through the roof supports. Rock the saw over them to avoid damaging the integrity of the roof structure. Make cuts parallel to the supports and between pairs of supports in a rectangular pattern. Strike the nearest side of each section of the roofing material with an axe or maul, pushing it down on one side; use the support at the center of each panel as a fulcrum. This hole should be the same size as the opening made in the roof decking.
2. Determine the location of the fire within the building and the direction of attack. Place the fan 4 to 10 feet (1 to 3 meters) in front of the opening to be used for attack. Provide an exhaust opening at or near the fire. This opening can be made before starting the fan or when the fan is started. Check for interior openings that could allow the products of combustion to be pushed into unwanted areas. Start the fan and check the cone of air produced. It should completely cover the opening. This can be checked by running a hand around the doorframe to feel the direction of air currents. Allow smoke to clear—usually 30 seconds to 1 minute depending on the size of the area to be ventilated and smoke conditions.

Fire Fighter II in Action

Questions 1–3: *Answers will vary.*

Skill Drills

Skill Drill 15-1: Breaking Glass with a Hand Tool

(page 454)



© Jones & Bartlett Learning. Photographed by Glen E. Ellman.

1. Position yourself to the **side** of the window.



© Jones & Bartlett Learning. Photographed by Glen E. Ellman.

2. With your back facing the wall, swing **backward** forcefully with the tip of the tool striking the top one-third of the glass.



© Jones & Bartlett Learning. Photographed by Glen E. Ellman.

3. Clear remaining glass from the opening with the **hand tool**.

Skill Drill 15-5: Delivering Positive-Pressure Ventilation

(page 460)



© Jones & Bartlett Learning. Photographed by Glen E. Ellman.

1. Place the fan in front of the opening to be used for the fire attack.



© Jones & Bartlett Learning. Photographed by Glen E. Ellman.

2. Provide an exhaust opening at or near the fire.



© Jones & Bartlett Learning. Photographed by Glen E. Ellman.

3. Start the fan and allow the smoke to clear.

Skill Drill 15-7: Sounding a Roof

(page 464)



© Jones & Bartlett Learning. Photographed by Glen E. Ellman.

1. Use a hand tool to check the roof before **stepping** onto it.



© Jones & Bartlett Learning. Photographed by Glen E. Ellman.

2. Use the tool to sound ahead and to both **sides** as you walk. Locate support members by sound and **rebound**. Check conditions around your work area periodically.



© Jones & Bartlett Learning. Photographed by Glen E. Ellman.

3. Sound the roof along your **exit** path.

Skill Drill 15-9: Making a Rectangular or Square Cut

(page 471)



© Jones & Bartlett Learning. Photographed by Glen E. Ellman.

1. Locate the roof supports by sounding. Make the first cut parallel to the roof support.



© Jones & Bartlett Learning. Photographed by Glen E. Ellman.

2. Make a triangle cut at the first corner.



© Jones & Bartlett Learning. Photographed by Glen E. Ellman.

3. Make two cuts perpendicular to the roof supports and then make the final cut parallel to another roof support.



© Jones & Bartlett Learning. Photographed by Glen E. Ellman.

4. Pull out or push in the triangle cut.



© Jones & Bartlett Learning. Photographed by Glen E. Ellman.

5. Punch out the ceiling below. Be wary of a sudden updraft of hot gases or flames.

Skill Drill 15-10: Making a Louver Cut

(page 472)



© Jones & Bartlett Learning. Photographed by Glen E. Ellman.

1. Locate the roof supports by **sounding**.



© Jones & Bartlett Learning. Photographed by Glen E. Ellman.

2. Make two parallel cuts **perpendicular** to the roof supports.



© Jones & Bartlett Learning. Photographed by Glen E. Ellman.

3. Cut parallel to the supports and between pairs of supports in a(n) **rectangular** pattern.



© Jones & Bartlett Learning. Photographed by Glen E. Ellman.

4. Tilt the **panel** to a vertical position.

Skill Drill 15-11: Making a Triangular Cut (page 473)



© Jones & Bartlett Learning. Photographed by Glen E. Ellman.

1. Locate the roof **supports**.



© Jones & Bartlett Learning. Photographed by Glen E. Ellman.

2. Make the first cut from just **inside** a support member in a(n) **diagonal** direction toward the next support member.



© Jones & Bartlett Learning. Photographed by Glen E. Ellman.

3. Begin the second cut at the same location as the first, and make it in the **opposite** diagonal direction, forming a V shape.



© Jones & Bartlett Learning. Photographed by Glen E. Ellman.

4. Make the final cut **along** the support member so as to connect the first two cuts. Cutting from this location allows fire fighters the full support of the member directly below them while performing **ventilation**.

Chapter 16: Water Supply

Matching

- | | |
|-----------------|------------------|
| 1. E (page 494) | 6. B (page 492) |
| 2. J (page 500) | 7. A (page 495) |
| 3. I (page 492) | 8. F (page 490) |
| 4. D (page 494) | 9. G (page 501) |
| 5. C (page 501) | 10. H (page 501) |

Multiple Choice

- | | |
|------------------|------------------|
| 1. B (page 492) | 11. C (page 494) |
| 2. B (page 495) | 12. B (page 501) |
| 3. A (page 500) | 13. B (page 499) |
| 4. A (page 489) | 14. C (page 492) |
| 5. A (page 494) | 15. C (page 497) |
| 6. D (page 499) | 16. D (page 494) |
| 7. C (page 501) | 17. C (page 494) |
| 8. D (page 492) | 18. C (page 500) |
| 9. A (page 492) | 19. A (page 495) |
| 10. A (page 494) | 20. B (page 500) |

Vocabulary

- Municipal water system:** A water distribution system that is designed to deliver potable water to end users for domestic, industrial, and fire protection purposes. (pages 488, 492)
- Tanker shuttle:** A method of transporting water from a source to a fire scene using a number of mobile water supply apparatus. (page 492)
- Dry-barrel hydrant:** A type of hydrant used in areas subject to freezing weather. The valve that allows water to flow into the hydrant is located underground, and the barrel of the hydrant is normally dry. (page 495)
- Normal operating pressure:** The observed static pressure in a water distribution system during a period of normal demand. (page 501)
- Gravity-feed system:** A water distribution system that depends on gravity to provide the required pressure. The system storage is usually located at a higher elevation than the end users. (page 494)



Fill-in

- | | |
|-------------------------------------|-----------------------------|
| 1. barrel (page 495) | 7. water supply (page 488) |
| 2. volume (page 503) | 8. visibility (page 498) |
| 3. gravity (page 494) | 9. reservoirs (page 492) |
| 4. static water supplies (page 489) | 10. valves (page 495) |
| 5. mobile (page 490) | 11. fully; fully (page 496) |
| 6. potential (static) (page 500) | 12. Control (page 494) |

True/False

- | | |
|-----------------|------------------|
| 1. F (page 500) | 6. F (page 494) |
| 2. F (page 492) | 7. T (page 497) |
| 3. T (page 501) | 8. T (page 492) |
| 4. T (page 488) | 9. T (page 495) |
| 5. T (page 501) | 10. T (page 495) |

Short Answer

1. The duties that need to be included in a hydrant inspection include: (1) The first part of a hydrant inspection involves checking the exterior of the hydrant for signs of damage. Open the steamer port of a dry-barrel hydrant to ensure that the barrel is dry and free of debris. Make sure that all caps are present and that the outlet hose threads are in good working order. (2) The second part of the inspection ensures that the hydrant works properly. Open the hydrant valve just enough to confirm that water flows out and flushes any debris out of the barrel. After flushing, shut down the hydrant. Leave the cap off dry-barrel hydrants to ensure that they drain properly. A properly draining hydrant will create suction against a hand placed over the outlet. When the hydrant is fully drained, replace the cap. (3) If the threads on the discharge ports need cleaning, use a steel brush and a small triangular file to remove any burrs in the threads. Also check the gaskets in the caps to make sure they are not cracked, broken, or missing. Replace worn gaskets with new ones, which should be carried on each apparatus. Follow the manufacturer's recommendations for any parts that require lubrication. (pages 499–500)
2. The two water sources fire fighters rely on are: (1) Municipal water systems furnish water under pressure through fire hydrants. (2) Rural areas may depend on static water sources such as lakes and streams. (page 488)
3. Wet-barrel hydrants are used in locations where temperatures do not drop below freezing. These hydrants always have water in the barrel and do not have to be drained after each use. Dry-barrel hydrants are used in climates where temperatures can be expected to fall below freezing. The valve that controls the flow of water into the barrel of the hydrant is located at the base, below the frost line, to keep the hydrant from freezing. (page 495)
4. The fire fighter making the connection opens a large outlet cap and then releases the valve just enough to ensure that water flows into the hydrant and flushes out any foreign matter. The fire fighter then closes the valve, connects the hose, and reopens the valve all the way. (page 496)
-  5. To perform a service test on a fire hose: (1) Don turnout gear. (2) Connect up to 300 feet (91 m) of hose to a hose testing gate valve on the discharge valve of a fire department pumper or hose tester. (3) Attach a nozzle to the end of the hose. (4) Slowly fill each hose with water at 50 psi (344 kPa), and remove kinks and twists in the hose. (5) Open the nozzle to purge air from the hose, discharging the water away from the test area. Close the nozzle. (6) Measure and record the length of each section of hose. (7) Mark the position of each hose coupling on the hose. (8) Check each coupling for leaks. When leaks are found, remove the hose from service if the leak is behind the coupling. If the leak is in front of the coupling, tighten the leaking couplings. Replace gaskets if necessary after shutting down the hose line. (9) Close the hose testing gate valve. (10) Ensure that all fire fighters are clear of the test area. (11) Increase the pressure on the hose to the pressure required by NFPA 1962, and maintain that pressure for 5 minutes. (12) Monitor the hose and couplings for leaks as the pressure increases during the test. (13) Shut the gates and open the nozzle to bleed off the pressure. (14) Uncouple the hose and drain it. (15) Inspect the marks placed on the hose jacket near the couplings to determine whether slippage occurred. (16) Tag hose that failed. (17) Mark hose that passed. (18) Record the results in the departmental logs. (pages 513–514)
-  6. The information that should be noted on a hose record is: (1) Hose size, type, and manufacturer; (2) Date when the hose was manufactured; (3) Date when the hose was purchased; (4) Dates when the hose was tested; (5) Any repairs that have been made to the hose. (page 515)
-  7. Visual hose inspections should be performed at least quarterly. A visual inspection should also be performed after each use, either while the hose is being cleaned and dried or when it is reloaded onto the apparatus. If any defects are found, that length of hose should be immediately removed from service and tagged with a description of the problem. Hose that has not been used in 30 days should be unpacked, inspected, cleaned, and reloaded. The appropriate notifications must be made to have the hose repaired. To clearly mark a defective hose, follow these steps: (1) Inspect the hose for defects. (2) Upon finding a defect, mark the area on the hose and remove the hose from service. (3) Tag the hose as defective and provide a description of the defect, take it out of service, and notify your superiors. (page 513)

Word Fun

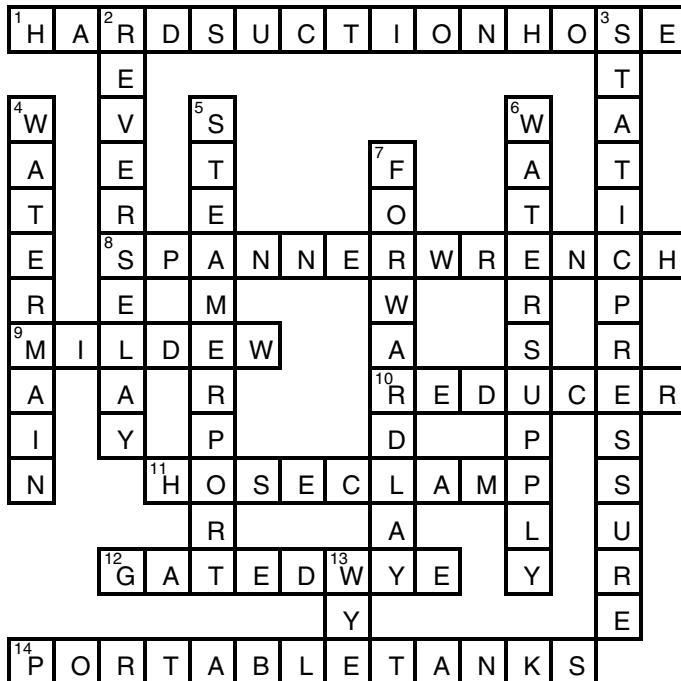

Fire Alarms

1. The first factors to check when inspecting hydrants are visibility and accessibility. Hydrants should always be visible from every direction, so they can be easily spotted. A hydrant should not be hidden by tall grass, brush, fences, debris, dumpsters, or any other obstruction. The second part of the inspection ensures that the hydrant works properly. Open the hydrant valve just enough to ensure that water flows out and flushes any debris out of the barrel. After flushing, shut down the hydrant. Leave the cap off dry-barrel hydrants to ensure that they drain properly. A properly draining hydrant will create suction against a hand placed over the outlet opening. When the hydrant is fully drained, replace the cap.
2. Remove the tank from the tender; properly position the tank and expand the tank; assist the pump operator with hooking up the hard suction and strainer; and discharge your tanker water into the tank.



Fire Fighter II in Action

1. Answers will vary.
2. Answers will vary.
3. Answers will vary.

Skill Drills

Skill Drill 16-2: Operating a Fire Hydrant

(page 498)



© Jones & Bartlett Learning. Photographed by Glen E. Ellman.

1. Remove the cap from the outlet you will be using.



© Jones & Bartlett Learning. Photographed by Glen E. Ellman.

2. Quickly look inside the hydrant opening for foreign objects (dry-barrel hydrant only).



© Jones & Bartlett Learning. Photographed by Glen E. Ellman.

3. Check that the remaining caps are snugly attached (dry-barrel hydrant only).



© Jones & Bartlett Learning. Photographed by Glen E. Ellman.

4. Attach the hydrant wrench to the stem nut. Check for an arrow indicating the direction to turn to open.



© Jones & Bartlett Learning. Photographed by Glen E. Ellman.

5. Open the hydrant enough to verify flow and flush the hydrant (dry-barrel hydrant only).



© Jones & Bartlett Learning. Photographed by Glen E. Ellman.

6. Shut off the flow of water (dry-barrel hydrant only).



© Jones & Bartlett Learning. Photographed by Glen E. Ellman.

7. Attach the hose or valve to the hydrant outlet.



© Jones & Bartlett Learning. Photographed by Glen E. Ellman.

8. When instructed, turn the hydrant wrench to fully open the valve.



© Jones & Bartlett Learning. Photographed by Glen E. Ellman.

9. Open the hydrant slowly to avoid a pressure surge.

Skill Drill 16-4: Testing a Fire Hydrant

(page 503)



© Jones & Bartlett Learning. Photographed by Glen E. Ellman.

1. Place a **cap gauge** on one of the outlets of the first hydrant.



© Jones & Bartlett Learning. Photographed by Glen E. Ellman.

2. Open the **hydrant valve** to fill the hydrant barrel. Record the initial pressure reading on the gauge as the **static** pressure.



© Jones & Bartlett Learning. Photographed by Glen E. Ellman.

3. Move to the second hydrant, remove one of the **discharge caps**, and open the hydrant.



© Jones & Bartlett Learning. Photographed by Glen E. Ellman.

4. Place the **Pitot gauge** one-half the diameter of the orifice away from the opening and record this pressure as the **Pitot** pressure. Record the pressure on the first hydrant as the **residual** pressure. Use the recorded pressures to calculate or look up the flow rates at 20 psi (138 kPa) **residual** pressure. Document your findings.

Skill Drill 16-19: Performing a Forward Hose Lay (pages 524–525)



© Jones & Bartlett Learning. Photographed by Glen E. Ellman.

1. Stop the fire apparatus **10 feet (3 m)** from the hydrant.



© Jones & Bartlett Learning. Photographed by Glen E. Ellman.

2. Grasp enough hose to reach to the hydrant and to **loop around** the hydrant. Step off the apparatus, carrying the hydrant wrench and all necessary tools. Loop the end of the hose around the hydrant or secure the hose as specified in the local SOP. Do not stand between the hose and the hydrant. Never stand on the hose.



© Jones & Bartlett Learning. Photographed by Glen E. Ellman.

3. Signal the pump driver/operator to **proceed** to the fire once the hose is secured.



© Jones & Bartlett Learning. Photographed by Glen E. Ellman.

4. Once the apparatus has moved off and a length of **supply line** has been removed from the apparatus and is lying on the ground, remove the appropriate size **hydrant cap** nearest to the fire. Follow the local SOP for checking the operating condition of the hydrant.



© Jones & Bartlett Learning. Photographed by Glen E. Ellman.

5. Attach the **supply hose** to the **outlet**. An adaptor may be needed if a large-diameter hose with Storz-type couplings is used.



© Jones & Bartlett Learning. Photographed by Glen E. Ellman.

6. Attach the **hydrant wrench** to the hydrant.



© Jones & Bartlett Learning. Photographed by Glen E. Ellman.

7. The pump driver/operator uncouples the hose and attaches the end of the supply line to the **pump inlet** or clamps the hose close to the pump, depending on the local SOP. When the pump driver/operator signals to charge the hose by prearranged hand signal, radio, or air horn, open the hydrant **slowly** and **completely**.



© Jones & Bartlett Learning. Photographed by Glen E. Ellman.

8. Follow the hose back to the **engine** and remove any kinks from the supply line.

Chapter 17: Fire Attack and Foam



Matching

- | | |
|-----------------------|--|
| 1. E (page 570) | 9. N (page 559) |
| 2. K (pages 552, 553) | 10. L (page 569) |
| 3. G (page 570) | 11. A (page 569) |
| 4. C (page 568) | 12. O (pages 552, 568) |
| 5. D (page 553) | 13. I (page 570) |
| 6. B (page 572) |  14. M (page 575) |
| 7. H (page 570) |  15. F (page 576) |
| 8. J (page 567) | |

Multiple Choice

- | | |
|------------------|--|
| 1. B (page 552) | 14. C (page 570) |
| 2. A (page 563) | 15. C (page 569) |
| 3. B (page 569) | 16. D (page 553) |
| 4. B (page 553) | 17. C (page 557) |
| 5. C (page 554) |  18. C (page 577) |
| 6. A (page 552) |  19. A (page 573) |
| 7. A (page 556) |  20. D (page 576) |
| 8. D (page 554) |  21. D (page 577) |
| 9. D (page 569) |  22. D (page 576) |
| 10. A (page 553) |  23. A (page 576) |
| 11. B (page 559) |  24. D (page 575) |
| 12. C (page 570) |  25. C (page 574) |
| 13. B (page 570) | |

Vocabulary

- Handline nozzle:** These nozzles are used on hose lines ranging from 1½ inches (38 mm) to 2½ inches (65 mm) in diameter. Handline streams usually flow between 60 and 350 gpm (273 and 1591 lpm). (page 569)
- Smooth-bore nozzle:** A nozzle that produces a straight stream that is a solid column of water. (page 569)
- Fixed-gallongage fog nozzle:** A fixed-gallongage fog nozzle delivers a preset flow at the rated discharge pressure. The nozzle could be designed to flow 60, 95, or 125 gpm (273, 432, or 568 lpm). (page 570)
-  **Foam proportioners:** A foam proportioner is the device that mixes the foam concentrate into the fire stream in the proper percentage. The two types of proportioners—eductors and injectors—are available in a wide range of sizes and capacities. (page 576)
-  **Batch mixing:** Pouring foam concentrate directly into the fire apparatus water tank, thereby mixing a large amount of foam at one time. (page 576)

Fill-In

1. attack engine (page 554)
2. Small-diameter hose lines (page 553)
3. booster hose (page 553)
4. fire attack (page 552)
5. flaked out (page 559)
6. charged (page 563)
7. gravity (page 563)
8. first fly section (page 566)
9. attack lines (page 552)
10. charge the line (page 559)
11. safety (page 562)
12. outside the door (page 562)
13. breakaway type (pages 566, 567)
14. one floor below (page 567)
15. transitional (page 559)
16. CAFs (page 575; *Note that this statement is no longer in the book chapter. Hoses containing CAFs might not kink easily; it depends on the type of nozzle used.*)

True/False

1. (page 570) T
2. (page 553) F
3. (page 554) T
4. (page 559) T
5. (page 563) F
6. (page 563) F
7. (page 558) T
8. (page 564) F
9. (page 566) T
10. (page 576) T
11. (page 576) T
12. (page 576) T
13. (page 576) F
14. (page 577) F
15. (page 575) T
16. (page 575) F



Short Answer

1. Class A foam increases the effectiveness of water as an extinguishing agent by reducing the surface tension of water. This allows the water to penetrate dense materials instead of running off the surface and allows more heat to be absorbed. Class B foam extinguishes flammable-liquid fires by separating the fuel from the fire. When a blanket of foam completely covers the surface of the liquid, the release of flammable vapors stops. (page 573)
2. Class A foams are usually formulated to be mixed with water in ratios from 0.1 percent (1 gallon of concentrate to 999 gallons of water, or 1 liter of concentrate to 999 liters of water) to 1 percent (1 gallon of concentrate to 99 gallons of water, or 1 liter of concentrate to 99 liters of water). The end product can be tweaked to have different properties by varying the percentage of foam concentrate in the mixture and the application method. It is possible to produce “wet” foam that has good penetrating properties, for example, or “drier” foam that is more effective for applying a protective layer of foam onto a building. (page 573, 574)
3. Most Class B foam concentrates are designed to be used in strengths of either 3 percent or 6 percent. A 3 percent foam mixes 3 gallons of foam concentrate with 97 gallons of water (11 liters of concentrate to 367 liters of water) to produce 100 gallons (378 liters) of foam solution. A 6 percent foam mixes 6 gallons of foam concentrate with 94 gallons of water (22 liters of concentrate to 356 liters of water) to produce 100 gallons (378 liters) of foam solution. Some foams are designed to be used at 3 percent for ordinary hydrocarbons and at 6 percent for polar solvents. Fire fighters must determine which type of fuel is involved in the incident so that they can select the correct proportioning rate. The compatibility of foam agents with other extinguishing agents needs to be considered as well. For example, some combinations of dry chemical extinguishing agents and foam agents can cause an adverse reaction. The compatibility data needed are available from the manufacturers of the agents. (page 574)

4. The major categories of Class B foam concentrate are: (1) Protein foam; (2) Fluoroprotein foam; (3) Film-forming fluoroprotein foam (FFFP); (4) Aqueous film-forming foam (AFFF); (5) Alcohol-resistant foam (page 575)
5. A. **Protein foams** are made from animal by-products. They are effective on Class B hydrocarbon fires and are applied in 3 percent or 6 percent delivery rates. (page 575)
B. **Fluoroprotein foams** are made from the same base materials as protein foam but include additional fluorochemical surfactant additives. The additives allow this foam to produce a fast-spreading film. (page 575)
C. **Aqueous film-forming foam (AFFF)** is a synthetic-based foam that is particularly suitable for spill-related fires involving gasoline and light hydrocarbon fuels. It can form a seal across a surface quickly and has excellent vapor suppression capabilities. (page 575)
D. **Alcohol-resistant foam** has properties similar to AFFF; however, it is formulated so that alcohols and other polar solvents do not dissolve the foam. Regular foams cannot be used on these products. (page 575)
E. **Compressed air foam (CAF)** is produced by injecting compressed air into a stream of water that has been mixed with 0.1 percent to 1 percent foam. This results in a small, highly compacted foam. CAF coats the surface of a fuel and may reduce rekindling and smoldering of unburned fuel. (page 575)

6. A foam proportioner is the device that mixes the foam concentrate into the fire stream in the proper percentage. The two types of proportioners—eductors and injectors—are available in a wide range of sizes and capacities. A foam eductor draws foam concentrate from a container or storage tank into a moving stream of water. An eductor can be built into the plumbing of an engine, or a portable eductor can be inserted in an attack hose line. A foam eductor is usually designed to work at a predetermined pressure and flow rate. A metering valve can be adjusted to set the percentage of foam concentrate that is educted into the stream. The most common type of portable in-line eductor used by fire departments is sized to work with a 1½-inch (38-mm) attack line. This type of eductor requires 200 psi (1379 kPa) of water pressure to draw foam concentrate from a portable container into the stream. An attack line with 150 feet (36 meters) of 1½-inch (38-mm) hose can be connected on the discharge side of the eductor to deliver the foam to a nozzle.

Foam injectors add the foam concentrate to the water stream under pressure. Most injector-based proportioning systems can work across a range of flow rates and pressures. A metering system measures the flow rate and pressure of the water and adjusts the injector to add the proper amount of foam concentrate. This type of system is often installed on special foam apparatus. (pages 575–576)

7. Foam can be applied to a fire or spill through portable extinguishers, handlines, master stream devices, or a variety of fixed systems for special applications. Foam can be applied with a wide range of expansion rates, depending on the amount of air that is mixed into the stream and the size of the bubbles that are produced:

Low-expansion foam has little entrained air and a small bubble structure.

Medium-expansion foam is produced with special aerating nozzles that are designed to introduce more air into the stream and produce a consistent bubble structure (aeration).

High-expansion foam contains a much higher proportion of air and large bubbles. Such a system uses a high-expansion foam generator to introduce large quantities of air into the discharge stream. When applying foam from a handline, the correct application techniques must be used to produce the desired quality of foam and successfully blanket the surface of a burning liquid or spill. These techniques can be direct or indirect and include the sweep, bankshot, and rain-down methods of application. The sweep (or roll-on) method should be used only on a pool of flammable product that is on open ground. With this technique, the fire fighter sweeps the stream along the ground just in front of the target to produce a quantity of foam and then uses the energy of the stream to push the foam blanket across the surface. The stream is moved back and forth in a slow, steady, horizontal motion to push the foam forward gently until the area is covered. It is important to push the foam gingerly so that the blanket is not broken. The fire fighter might need to move to different positions to be sure that the entire surface of the product is covered by the foam blanket.

The bankshot (or bank-down) method is used at fires where the fire fighter can use an object to deflect the foam stream and let it flow down onto the burning surface. This method could be used to apply foam to an open-top storage tank or a rolled-over transport vehicle, for example. The fire fighter should sweep the foam back and forth against the object while the foam flows down and spreads back across the surface. As with all foam application methods, it is important to let the foam blanket flow gently on the surface of the flammable liquid to form a blanket.

The rain-down application method consists of lofting the foam stream into the air above the fire and letting it fall down gently onto the surface. The stream should be broken so that the amount of foam falling in the same area does

not cause splashing or break up the blanket that has already been applied. Carefully observe how the foam blanket is building up and direct your stream so that the entire surface is covered. (pages 576–577)

Fire Alarms

1. (1) Connect the female end of the first length of hose to the discharge outlet. (2) Flat load the hose even to the edges of the hose bed. At approximately the 30-foot (9-meter) mark, make a loop/ear (this will create a handle for advancing purposes). Continue the load until you reach the 60- to 70-foot (18- to 21-meter) mark. Make an additional loop/ear. Flat load the remainder of the 100-foot (30-meter) section, leaving extra hose to the side, in the opposite direction of deployment. (3) Assemble the remaining hose sections and attach the nozzle. (4) Place the nozzle on the hose bed. (5) Load the remaining 100 feet (30 meters) of hose flat into the bed, alternating the folds from the left to right sides of the bed. (6) Connect the last section loaded to the first section placed in the bed. (7) Lay the remaining loose hose on top of the load.
2. (1) Grasp the nozzle and the folds next to it. (2) Pull the load approximately one-third out of the bed. (3) Turn away from the hose bed and place this top part of the hose load on your shoulder. Walk away from the apparatus until the rest of the top section of hose drops from the hose bed. (4) Turn back around toward the hose bed and grasp the loop or ear from the first section of hose. (5) Walk away from the apparatus until all hose is clear from the hose bed. (6) Continue walking away, allowing the rest of the hose to deploy from the top of the load on your shoulder.



Fire Fighter II in Action

Questions 1 and 2: *Answers will vary.*

Skill Drill

Skill Drill 17-10: Advancing an Uncharged Hose Line up a Ladder

(page 566)



© Jones & Bartlett Learning. Photographed by Glen E. Ellman.

1. Advance the hose line to the ladder. Pick up the **nozzle**; place the hose across the chest, with the nozzle draped over the **shoulder**. Climb up the ladder with the **uncharged** hose line.



© Jones & Bartlett Learning. Photographed by Glen E. Ellman.

2. Once the first fire fighter reaches the first fly section of the ladder, a second fire fighter shoulders the hose to assist advancing the hose line up the ladder. To avoid overloading of the ladder, enforce a limit of **one** fire fighter(s) per fly section. The nozzle is placed over the **top rung** of the ladder and advanced into the **fire area**.



© Jones & Bartlett Learning. Photographed by Glen E. Ellman.

3. Additional hose can be fed up the ladder until sufficient hose is in position. The hose can be secured to the ladder with a **hose strap** to support its weight and keep it from becoming dislodged.

Chapter 18: Fire Fighter Survival

Matching

1. F (page 587)
2. B (page 593)
3. C (page 588)
4. G (page 596)
5. I (page 593)
6. E (page 587)
7. J (page 602)
8. H (page 586)
9. D (page 592)
10. A (page 591)

Multiple Choice

1. C (page 593)
2. A (page 587)
3. B (page 591)
4. A (page 601)
5. B (page 588)
6. C (page 605)
7. D (page 587)
8. D (page 587)
9. D (page 605)
10. A (page 586)
11. C (page 586)
12. C (page 593)
13. C (page 590)
14. B (page 596)
15. B (page 591)
16. A (page 587)
17. D (page 588)
18. A (page 591)
19. D (pages 591–592)
20. B (page 589)

Vocabulary

1. **Critical incident stress management (CISM):** A program designed to reduce both acute and chronic effects of stress related to job functions. (page 605)
2. **Safe location:** A temporary place of refuge in which fire fighters can await rescue. (page 596)
3. **Air management:** The way in which an individual uses a limited air supply to ensure that it will last long enough to enter a hazardous area, accomplish needed tasks, and return safely. (page 600)
4. **Self-rescue:** Escaping or exiting a hazardous area under one's own power (page 593)
5. **Rapid intervention company/crew (RIC):** A company or crew that is assigned to stand by at the incident scene, fully dressed and equipped for action, ready to deploy immediately when assigned to do so by the incident commander (IC). (pages 591–592)

Fill-in

1. simple observation (page 587)
2. mayday (page 591)
3. ongoing (page 587)
4. management (page 600)
5. incident commander (page 586)
6. training (page 588)
7. rehabilitation (page 602)
8. integrity (page 589)
9. oriented (page 593)

True/False

1. T (page 588)
2. T (page 605)
3. T (page 596)
4. T (page 587)
5. F (pages 603, 605)
6. F (page 593)
7. T (page 605)
8. F (page 593)
9. T (page 589)
10. T (page 587)

Short Answer

- The recognized stages of emotional reaction experienced by fire fighters and other rescue personnel to critical incidents are: (1) Anxiety; (2) Denial/disbelief; (3) Frustration/anger; (4) Inability to function logically; (5) Remorse; (6) Grief; (7) Reconciliation/acceptance (page 605)
- A simply stated risk–benefit philosophy for a fire department is that it is permissible to risk the life of a fire fighter only in situations where there is a reasonable and realistic possibility of saving a life. The determination that a risk is acceptable in a particular situation does not justify taking unsafe actions, however; it merely justifies taking actions that involve a higher level of risk. (page 587)
- The steps to follow to initiate a mayday are: (1) Use your radio to call, “Mayday, mayday, mayday.” (2) Give a LUNAR report: **L**ocation, **U**nit number, **N**ame, **A**ssignment, **R**esources needed. (3) Activate your PASS device. (4) Attempt self-rescue. (5) If you are able to move, identify a safe haven where you can await rescue. (6) Lie on your side in a fetal position with your PASS device pointing out so that it can be heard. (7) Point your flashlight toward the ceiling. (8) Slow your breathing as much as possible to conserve your air supply. (page 591)

Word Fun

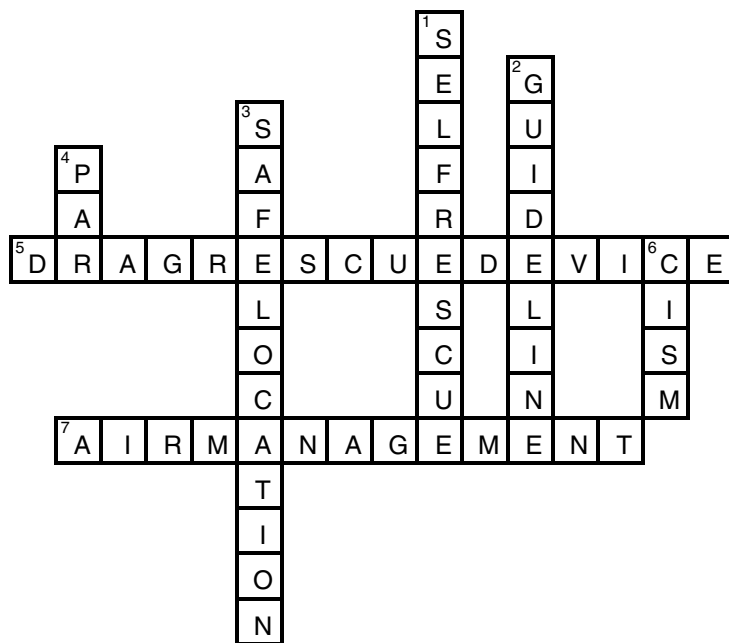

Fire Alarms

1. Initiate a mayday over the portable radio. Activate the PASS device. Stay calm and control your breathing. Change your position—back up or turn on your side to try to free yourself. Use the swimmer stroke to try to free yourself. Loosen the SCBA straps, remove one arm, and slide the air pack to the front of your body to try to free the SCBA. Cut the wires or cables causing the entanglement. Be aware of any possible electrocution risk. If you are unable to disentangle yourself, notify command of your situation. If you are able to exit, notify command that you are out of danger.
2. First, initiate a mayday over the portable radio. Manually activate the PASS device. Second, stay calm and control your breathing. Systematically locate a wall. Use a sweeping motion on the outside wall to locate an alternative exit. Identify the opening as a window, interior door, or external door. If the first opening identified is not adequate for an exit, continue to search. Third, maintain your orientation and stay low. Exit the room safely if possible. If unable to exit, assume the downed fire fighter position in a safe haven or find refuge. Keep command informed of your situation.

Fire Fighter II in Action

1. *Answers will vary.*

Skill Drills

Skill Drill 18-1: Initiating a Mayday Call

(page 592)



© Jones & Bartlett Learning. Photographed by Glen E. Ellman.

1. Use your radio to call, “Mayday, mayday, mayday.” Give a LUNAR report: your location, **unit number**, name, assignment, and **resources** needed.



© Jones & Bartlett Learning. Photographed by Glen E. Ellman.

2. Activate your **PASS** device. Attempt **self-rescue**. If you are able to move, identify a **safe location** where you can await rescue.



© Jones & Bartlett Learning. Photographed by Glen E. Ellman.

3. Lie on your side in a **fetal** position with your **PASS** device pointing out so it can be heard.



© Jones & Bartlett Learning. Photographed by Glen E. Ellman.

4. Point your flashlight toward the ceiling. Slow your breathing as much as possible to conserve your **air supply**.

Skill Drill 18-7: Rescuing a Downed Fire Fighter Using a Drag Rescue Device

(page 603)



© Jones & Bartlett Learning. Photographed by Glen E. Ellman.

1. Locate the downed fire fighter. Activate the mayday procedure, if that step had not already been taken. Shut off the PASS device to aid in communication. Assess the situation and the condition of the downed fire fighter.



© Jones & Bartlett Learning. Photographed by Glen E. Ellman.

2. Use the rapid intervention crew/company universal air connection (RIC-UAC) to fill the downed fire fighter's air supply cylinder, if needed.



© Jones & Bartlett Learning. Photographed by Glen E. Ellman.

3. Access the fire fighter's drag rescue device.



© Jones & Bartlett Learning. Photographed by Glen E. Ellman.

4. Remove the downed fire fighter from the hazard area to a safe area.

Chapter 19: Salvage and Overhaul

Matching

- | | |
|-----------------|------------------|
| 1. D (page 632) | 6. C (page 612) |
| 2. E (page 612) | 7. G (page 626) |
| 3. J (page 636) | 8. I (page 623) |
| 4. B (page 623) | 9. F (page 614) |
| 5. A (page 612) | 10. H (page 614) |



Multiple Choice

- | | |
|------------------|------------------|
| 1. A (page 617) | 11. B (page 618) |
| 2. B (page 634) | 12. C (page 626) |
| 3. A (page 618) | 13. A (page 634) |
| 4. D (page 617) | 14. B (page 612) |
| 5. D (page 623) | 15. B (page 626) |
| 6. D (page 617) | 16. C (page 616) |
| 7. B (page 613) | 17. A (page 626) |
| 8. C (page 619) | 18. D (page 617) |
| 9. B (page 631) | 19. C (page 615) |
| 10. A (page 613) | 20. A (page 614) |

Vocabulary

- Salvage cover:** Large square or rectangular sheets made of heavy canvas or plastic material that are spread over furniture and other items to protect them from water run-off and falling debris. (page 626)
- Sprinkler wedge:** A piece of wedge-shaped wood placed between the deflector and the orifice of a sprinkler head to stop the flow of water. (page 618)
- Floor runner:** A long section of protective material used to cover a section of flooring or carpet. Floor runners protect carpets or hardwood floors from water, debris, fire fighters' boots, and firefighting equipment. (page 631)
- Overhaul:** Overhaul is the process of searching for and extinguishing any pockets of fire that remain after a fire has been brought under control. (page 632)
- Sprinkler stop:** A sprinkler stop is a more sophisticated mechanical device than a sprinkler wedge, with a rubber stopper that can be inserted into a sprinkler head. Several types of sprinkler stops are available, including some that work only with specific sprinkler heads. (page 618)
- Balloon-frame construction:** In balloon-frame construction, a fire can extend directly from the basement to the attic, without obvious signs of fire on any other floor. For this reason, these buildings require a thorough floor-by-floor overhaul. (page 634)

Fill-in

- | | |
|--------------------------------------|--|
| 1. safety officer (page 633) | 9. feel (page 634) |
| 2. Fire watch (page 633) | 10. secondary losses (page 616) |
| 3. water (page 624) | 11. replaced (page 621) |
| 4. carryalls (page 636) |  12. ground-fault interrupters (GFI) (page 612) |
| 5. lower (page 612) |  13. manufacturer's instructions (page 615) |
| 6. thermal imaging device (page 635) |  14. mild soap; detergent (page 615) |
| 7. Overhaul (page 612) |  15. weekly; monthly (page 615) |
| 8. evidence (page 612) | |

True/False

- | | |
|-----------------|--|
| 1. T (page 614) | 7. F (page 619) |
| 2. T (page 631) | 8. T (page 633) |
| 3. T (page 616) | 9. T (page 617) |
| 4. T (page 634) | 10. F (page 626) |
| 5. T (page 636) |  11. T (page 615) |
| 6. T (page 612) |  12. T (page 614) |

Short Answer

- Several hazards may be present in the overhaul area. Notably, the structural safety of the building is often compromised. Catastrophic building collapses have occurred during overhaul. Heavy objects could lead to roof or ceiling collapse, debris could litter the area, and there could be holes in the floor. Visibility is often limited, so fire fighters may have to depend on portable lighting. The presence of wet or icy surfaces makes falls more likely. Smoldering areas may burst into flames, and the air is probably not safe to breathe. In addition, during overhaul operations, dangerous equipment—including axes, pike poles, and power tools—is used in close quarters. (page 633)
- Tools used in salvage operations include (*Students should list five of the following*): (1) Salvage covers (treated canvas or plastic); (2) Box cutter for cutting plastic; (3) Floor runners; (4) Wet/dry vacuums; (5) Squeegees; (6) Submersible pumps and hose; (7) Sprinkler shut-off kit; (8) Ventilation fans, power blowers; (9) Small tool kit; (10) Pike poles to construct water chutes (page 617)
- Tools used in overhaul operations include (*Students should list five of the following*): (1) Pike poles and ceiling hooks—for pulling ceilings and removing gypsum wallboard; (2) Crowbars and Halligan-type tools—for removing baseboards and window or door casings; (3) Axes—for chopping through wood, such as floor boards and roofing materials; (4) Power tools such as battery-powered saws—for opening up walls and ceilings; (5) Pitchforks and shovels—for removing debris; (6) Rubbish hooks and rakes—for pulling things apart; (7) Thermal imaging cameras—for identifying hot spots (page 636)

4. Five indicators of possible structural collapse are: (1) Lightweight and/or truss construction; (2) Cracked walls, out of alignment walls, sagging floors; (3) Heavy mechanical equipment on the roof; (4) Overhanging cornices or heavy signs; (5) Accumulations of water (page 633)
5. To conduct a weekly/monthly generator test, follow these steps: (1) Remove the generator from the apparatus compartment or open all doors as needed for ventilation. Install the grounding rod if needed. (2) Check the oil and fuel levels, and start the generator. (3) Connect the power cord or junction box to the generator, connect a load such as a fan or lights, and make sure the generator attains the proper speed. Check the voltage and amperage gauges to confirm efficient operation. (4) Run the generator under load for 15 to 30 minutes. (5) Turn off the load and listen as the generator slows down to idle speed. Allow the generator to idle for approximately 2 minutes before turning it off. (6) Disconnect all power cords and junction boxes, and remove the grounding rod if present. (7) Clean all power cords, plugs, adaptors, GFIs, and tools, and replace them in proper storage areas. Allow the generator to cool for 5 minutes. (8) Refill the generator with fuel and oil as needed, and return the generator to its compartment. Fill out the appropriate paperwork. (page 615)

Word Fun

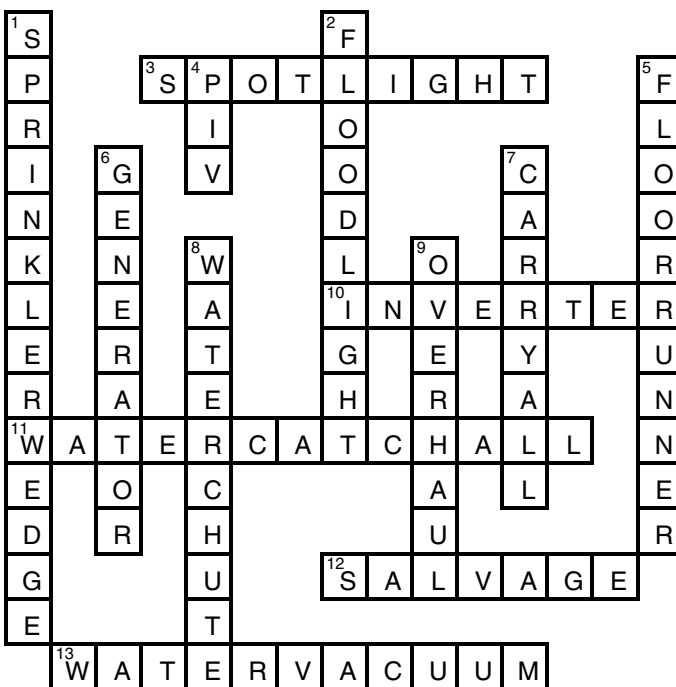

Fire Alarms

1. The most efficient way to protect a room and contents is to move all the furniture to the center of the room, away from the walls, where water could damage the backs of the furniture. This reduces the total area that must be covered, enabling one or two fire fighters to cover the pile quickly and move on to the next room. Remove any pictures from the walls and place them with the furniture. Put smaller pictures and valuable objects in drawers or wherever they will be protected from breakage. If enough time is available, roll up any rugs and place them on the pile.
2. To construct a water chute: (1) Fully open a large salvage cover flat on the ground. (2) Roll the cover tightly from one edge toward the middle. If using pike poles, lay one pole on the edge and roll the cover around the handle. Roll the opposite edge tightly toward the middle in the same manner. Stop when the rolls are 1 to 3 feet (30 to 91 centimeters) apart. (3) Turn the cover upside down. Position the chute so that it collects the dripping water and channels it toward a drain or outside opening. The chute can be placed on the floor, with one end propped up by a chair or other object. (4) Use a stepladder or other tall object to support chutes constructed with pike poles.
3. Salvage covers must be adequately maintained to preserve their shelf life. Salvage cover maintenance depends on the type of cover used. A canvas cover can usually be cleaned with a scrub brush and clean water. If the cover becomes particularly dirty, however, the user may have to use a mild detergent. Covers should be adequately rinsed if a detergent is used. Canvas covers must be properly dried before being returned to service. Effectively drying a canvas cover will reduce mildewing. Vinyl type covers are easily maintained by rinsing and do not mildew as easy as canvas covers.

Once dried, salvage covers should be inspected for tears and holes. Any damage found can be patched by using duct tape or a sewn-on patch.

4. To fold a salvage cover to prepare it for one fire fighter to deploy: (1) Spread the salvage cover flat on the ground. Stand at one end, facing your partner standing at the other end. (2) You and your partner each place one hand on the outer edge of the cover and the other hand one-quarter of the way in from the edge. (3) Together, flip the outside edge in 3 inches (8 centimeters) from the middle of the cover, creating a fold at the quarter point. (4) Flip the outside fold in to the same point of the cover, creating a second fold. Repeat steps 2, 3, and 4, from the opposite side of the cover. The folded edges should meet at the middle of the cover, with the folds 6 inches (15 centimeters) apart. (5) Fold the two halves of the salvage cover together. (6) Starting from the middle of the cover, use a broom to brush the air out of the cover. (7) Move to the newly created narrow end of the salvage cover. (8) Fold the narrow end of the salvage cover 3 inches (8 centimeters) from the middle of the cover, creating a fold at the quarter point. (9) Flip the outside fold of the narrow end in to the same point of the cover, creating a second fold. The folded edge should meet at the middle of the cover, with the folds 6 inches (8 centimeters) apart. (10) Fold the two halves of the salvage cover together.

Fire Fighter II in Action

1. Answers will vary.

Skill Drills

Skill Drill 19-2: Conducting a Weekly/Monthly Generator Test (page 616)



© Jones & Bartlett Learning. Photographed by Glen E. Ellman.



© Jones & Bartlett Learning. Photographed by Glen E. Ellman.

1. Remove the generator from the **apparatus compartment** or open all doors as needed for **ventilation**. Install the **grounding rod**, if needed.
2. Check the oil and fuel levels, and start the generator. Connect the power cord or **junction box** to the generator; connect a load such as a fan or lights, and make sure the generator attains the proper **speed**. Check the **voltage** and **amperage** gauges to confirm efficient operation.
3. Run the generator under load for **15 to 30** minutes. Turn off the load and listen as the generator slows down to idle speed. Allow the generator to idle for approximately **2** minutes before turning it off. Disconnect all power cords and junction boxes; clean all power cords, plugs, adaptors, GFIs, and tools, and replace them in proper storage areas. Allow the generator to cool for **5** minutes. Refill the generator with fuel and oil as needed, and return the generator to its compartment. Fill out the appropriate paperwork.

Skill Drill 19-10: Performing a Salvage Cover Fold for Two-Fire Fighter Deployment

(page 628)



© Jones & Bartlett Learning. Photographed by Glen E. Ellman.



© Jones & Bartlett Learning. Photographed by Glen E. Ellman.



© Jones & Bartlett Learning. Photographed by Glen E. Ellman.

1. Spread the salvage cover flat on the ground with a partner facing you. Together, fold the cover in **half**.
2. Together, grasp the **unfolded** edge and fold the cover in **half** again. Flatten the salvage cover to remove any **trapped air**.
3. Move to the newly created narrow ends of the salvage cover and fold the salvage cover in half **lengthwise**.



© Jones & Bartlett Learning. Photographed by Glen E. Ellman.



© Jones & Bartlett Learning. Photographed by Glen E. Ellman.

4. Fold the salvage cover in half **lengthwise** again. Make certain that the open end is **on top**.
5. Fold the cover in **half** a third time.

Chapter 20: Fire Fighter Rehabilitation**Matching**

- | | |
|-----------------|------------------|
| 1. E (page 653) | 6. J (page 654) |
| 2. G (page 644) | 7. F (page 646) |
| 3. B (page 652) | 8. I (page 645) |
| 4. A (page 650) | 9. D (page 651) |
| 5. C (page 644) | 10. H (page 653) |

Multiple Choice

- | | |
|-----------------|------------------|
| 1. D (page 651) | 6. C (page 651) |
| 2. A (page 655) | 7. D (page 650) |
| 3. A (page 647) | 8. D (page 655) |
| 4. A (page 655) | 9. A (page 645) |
| 5. D (page 645) | 10. D (page 648) |

Vocabulary

- 1. Rehabilitate:** To rehabilitate means to restore someone or something to a condition of health or to a state of useful and constructive activity. The goal of rehabilitation (usually called simply “rehab”) is to take time to “recharge your body’s batteries” so you can continue to be a productive member of the team. Rehabilitation is a critical factor in maintaining your health and well-being. (page 644)
- 2. Dehydration:** Dehydration is a state in which fluid losses are greater than fluid intake into the body. If left untreated, this imbalance can lead to shock and even death. Dehydration reduces strength, endurance, and mental judgment, as evidenced by a variety of signs and symptoms. Extreme dehydration can lead to confusion and total collapse. (page 646)
- 3. Hypothermia:** Hypothermia, a condition in which the internal body temperature falls below 95°F (35°C), can lead to loss of coordination, muscle stiffness, coma, and death. (page 651)
- 4. Frostbite:** Damage to tissues as the result of exposure to cold; frozen or partially frozen body parts. (page 652)
- 5. Emergency incident rehabilitation:** A function on an emergency scene that cares for the well-being of the fire fighters on the scene. It includes relief from climatic conditions, rest, cooling or warming, rehydration, calorie replacement, medical monitoring, member accountability, and release. (page 644)

Fill-in

1. glucose (page 654)
2. medical evaluation; treatment (pages 655–656)
3. Sugar (pages 653, 655)
4. Rehabilitation (page 644)
5. Reassignment (page 656)
6. Bloating (page 653)
7. intensity (page 645)
8. one; two (page 653)
9. Frostbite (page 652)
10. Carbohydrates (page 654)

True/False

1. T (page 655)
2. T (page 656)
3. T (page 647)
4. T (page 647)
5. T (page 645)
6. F (page 653)
7. F (page 653)
8. T (page 652)
9. F (page 654)
10. T (page 648)

Short Answer

1. During short-duration incidents, low-sugar, high-protein sports bars can be used to keep the glucose balance steady. During extended-duration incidents, a fire fighter should eat a more complete meal. The proper balance of carbohydrates, proteins, and fats will help to maintain energy levels throughout the emergency. To ensure peak performance, a meal should include complex carbohydrates such as whole-grain breads, whole-grain pasta, rice, and vegetables. It is also better to eat a series of smaller meals, rather than one or two large meals, because larger meals can increase glucose levels and slow down the body. (page 655)
2. Part of your responsibility is to know your own limits. No one else knows what you ate, whether you are lightheaded or dehydrated, whether you are feeling ill, or whether you need a breather. You are the only person who knows these things. Therefore, you may be the only person who knows when you need to request rehabilitation. (page 656)
3. Drinks such as colas, coffee, and tea should be avoided because they contain caffeine, which acts as a diuretic that causes the body to excrete more water. (page 653)
4. The sensation of thirst is not a reliable indicator of the amount of water the body has lost. Thirst develops only after the body is already dehydrated. (page 653)
5. Without the opportunity to rest and recover, you may develop physical symptoms such as fatigue, headaches, or gastrointestinal problems. (page 644)
6. Dehydration reduces strength, endurance, and mental judgment. (page 646)

7. Incidents that may require a rehabilitation station include: (1) High-rise fires; (2) Wildland fires; (3) Hazardous materials incidents (pages 648–650)
8. A widely used model of rehabilitation consists of seven parts: (1) Relief from climatic conditions; (2) Rest and recovery; (3) Active or passive cooling or warming; (4) Rehydration and calorie replacement; (5) Medical monitoring; (6) Member accountability; (7) Release and reassignment (page 651)
9. Factors that cause firefighting to be a stressful work environment include the following: (1) The loud, jarring sound of the alarm. (2) Your personal protective equipment (PPE). (3) You may not have time to eat or get something to drink. (4) You may have to drive an emergency vehicle, haul hoses, position a ladder, or climb to the roof to cut a ventilation hole, all of which require a significant amount of energy and concentration. You must be able to move into action quickly with no time to warm up your muscles as athletes do before an event. (5) You may be called to a fire on the hottest day of the year, the coldest day of the year, and under all types of adverse circumstances. (6) You may feel an added emotional stress, which in turn affects your body. (7) Fire fighters often work in unfamiliar, smoke-filled environments. (page 645)

Word Fun

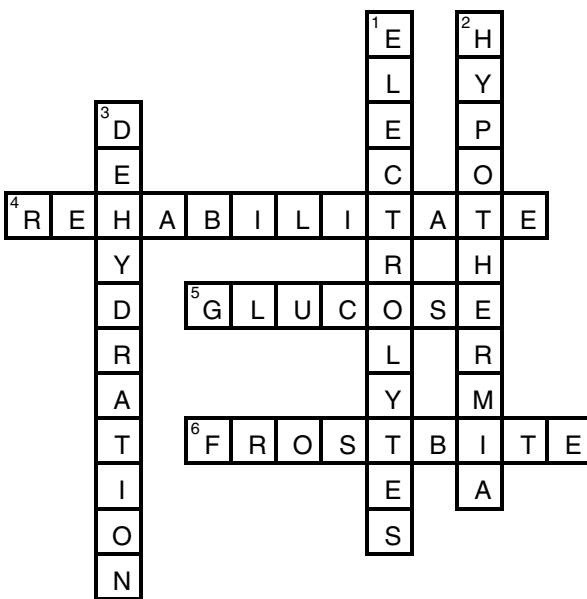

Fire Alarms

1. Fire fighters responding to incidents during cold weather are subject to both hypothermia and frostbite (damage to tissues resulting from prolonged exposure to cold). In these cases, the rehabilitation center needs to be heated so that fire fighters can warm up before returning to the chilly environment. Fire fighters who are wet or severely chilled should be wrapped in warming blankets and moved into a well-heated area before they remove their turnout gear. As soon as possible, all wet clothing should be removed and replaced with warm, dry clothing.
2. Part of your responsibility is to know your own limits. No one else can know what you ate, whether you are lightheaded or dehydrated, whether you are feeling ill, or whether you need a breather. You are the only person who knows these things. Therefore, you may be the only person who knows when you need to request rehabilitation. It may be difficult to say, “I need a break,” while your team members are still hard at work. Even so, it is better to take a break when you need it than to push yourself too far and have to be rescued by other members of your department.



Fire Fighter II in Action

1. Answers will vary.
2. Answers will vary.

Chapter 21: Wildland and Ground Fires

Matching

1. E (page 663)
2. I (page 666)
3. D (page 666)
4. B (page 666)
5. C (page 666)
6. K (page 666)
7. H (page 666)
8. F (page 667)
9. J (page 662)
10. A (page 663)
11. G (page 664)

Multiple Choice

1. D (page 665)
2. B (page 669)
3. B (page 667)
4. C (page 669)
5. B (page 670)
6. A (page 666)
7. D (page 669)
8. A (page 669)
9. B (page 664)
10. D (page 669)
11. C (page 666)
12. C (page 662)
13. B (page 666)
14. A (page 663)
15. A (page 664)
16. D (page 663)

Vocabulary

1. **Heavy fuels:** Fuels of a large diameter, such as large brush, heavy timber, snags, stumps, branches, and dead timber on the ground. These fuels ignite and are consumed more slowly than light fuels. (page 663)
2. **Fuel continuity:** The relative closeness of wildland fuels—a factor in a fire's ability to spread from one area of fuel to another. (page 664)
3. **Backpack pump extinguisher:** A portable fire extinguisher consisting of a 4-gallon to 8-gallon (15-liter to 30-liter) water tank that is worn on the user's back and features a hand-powered piston pump for discharging the water. (page 666)
4. **Topography:** The features of the earth's surface; changes in land elevation and the position of natural and human-made features. (page 665)
5. **Aerial fuels:** Fuels located more than 6 feet (1.8 meters) off the ground, usually part of or attached to trees. (page 663)

Fill-in

1. backpack pump extinguishers (page 666)
2. humidity (page 665)
3. oxygen (page 664)
4. area of origin (page 666)
5. under; on; above (page 663)
6. spot (page 666)
7. Fixed (page 666)
8. Weather (page 663)
9. Wildland; ground (page 667)
10. quickly (page 663)

True/False

1. T (page 665)
2. T (page 672)
3. T (page 664)
4. F (page 669)
5. F (page 663)
6. T (page 665)
7. T (page 663)
8. T (page 662)
9. F (page 663)
10. T (page 665)

Short Answer

1. Hazards of wildland fires are (*Students should list three of the following*): (1) Driving on unimproved roads and steep terrain greatly increases the chance of fire apparatus rollovers. (2) When working in rough terrain, wildland and ground fire fighters are at increased risk for falls. Rough ground often contains holes that are difficult to see in smoky conditions. Steep terrain also increases the likelihood of falls. (3) Because wildland and ground firefighting involves working with sharp tools, it is important to prevent injuries caused by these tools. (4) Other hazards of fighting wildland and ground fires include burns and smoke inhalation. Because the PPE worn by wildland and ground fire fighters provides less protection than the PPE worn by structural fire fighters, fire fighters must keep far enough from the heat of the fire to prevent burns. (5) Because much wildland and ground firefighting is done without self-contained breathing apparatus (SCBA), fire fighters must avoid inhaling poisonous gases and suspended smoke particles. Use SCBA in any conditions where it is needed. (6) When engaged in wildland and ground firefighting, be alert for the hazards posed by falling trees. During a fire, the lower parts of trees may burn away and weaken the support for the rest of the tree. Trees of all sizes can fall with little warning. (7) Be alert for the presence of electrical hazards. Electrical transmission lines and other electrical wires may be present in the location of a wildland fire. Wires that drop on vegetation may ignite a wildland and ground fire and pose an electrical hazard to fire fighters. Many of these safety hazards can be difficult to see at night and in smoky conditions. (page 671)

Word Fun

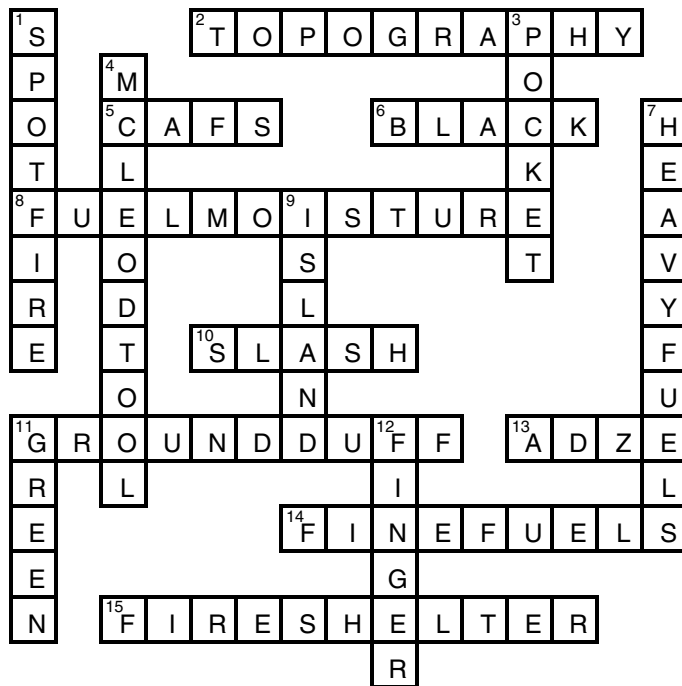

Fire Alarms

- Take the following steps to protect yourself: (1) Clear away a minimum area of 4 feet by 8 feet (1.2 by 2.4 meters) to bare earth, which is clear of any and all fuels (you can also select a 4 feet by 8 feet area that is already clear of fuels). (2) Discard all flammable items and any hand tools. (3) Remove the shelter and discard the plastic case. (4) Deploy and open the shelter. (5) Place one leg through the hold-down strap. (6) Place the upper part of the body inside the opposite ends of the hold-down strap. (7) Place the other leg into the shelter. Fall to the ground. (8) The shelter should now be deployed so that it covers the entire body and the inside flaps are tucked in and not exposed.
- Driving on unimproved roads and steep terrain greatly increases the chance of fire apparatus rollovers. Given these dangers, drivers must thoroughly understand the operating characteristics of their fire apparatus and operate the apparatus within the safe limits for which it was designed. All fire fighters should keep their seat belts fastened whenever the apparatus is moving.

Fire Fighter II in Action

1. Answers will vary.
2. Answers will vary.
3. Answers will vary.

Skill Drills

Skill Drill 21-2: Suppressing a Ground Cover Fire (page 673)



© Jones & Bartlett Learning. Photographed by Glen E. Ellman.

1. Don appropriate PPE. Identify **safety** and **exposure** risks. Protect exposures if necessary.



© Jones & Bartlett Learning. Photographed by Glen E. Ellman.

2. Construct a fire line by removing **fuel** with hand tools. OR



© Jones & Bartlett Learning. Photographed by Glen E. Ellman.

3. Extinguish the fire with a **backpack** pump extinguisher or a hand line.



© Jones & Bartlett Learning. Photographed by Glen E. Ellman.

4. **Overhaul** the area completely to ensure complete extinguishment of the ground cover.

Chapter 22: Suppression

Matching

- | | |
|-----------------------|------------------------|
| 1. H (pages 693, 704) | 6. J (pages 685, 704) |
| 2. F (pages 687, 704) | 7. G (pages 688, 704) |
| 3. I (pages 685, 704) | 8. E (page 686) |
| 4. A (pages 686, 704) | 9. B (pages 687, 704) |
| 5. C (pages 690, 704) | 10. D (pages 684, 704) |

Multiple Choice

- | | |
|------------------|--|
| 1. C (page 702) | 12. C (page 699) |
| 2. A (page 687) | 13. C (page 681) |
| 3. D (page 691) | 14. B (page 686) |
| 4. D (page 680) | 15. A (pages 680, 681) |
| 5. C (page 680) | 16. C (<i>Note: The answer to this question is no longer covered in the book chapter.</i>) |
| 6. A (page 695) | 17. C (page 685) |
| 7. C (page 680) | 18. A (page 680) |
| 8. A (page 682) | 19. B (page 697) |
| 9. D (page 697) | 20. A (page 700) |
| 10. B (page 699) | 21. C (page 700) |
| 11. A (page 683) | |

Vocabulary

- Master stream device:** Master stream devices are used to produce high-volume water streams for large fires. Several types of master stream devices exist, including portable monitors, deck guns, ladder pipes, and other elevated stream devices. (page 687, 704)
- Indirect application of water:** The use of a solid object such as a wall or ceiling to break apart a stream of water, creating more surface area on the water droplets and thereby causing the water to absorb more heat. (page 685, 704)
- Portable monitor:** A portable monitor is a master stream device that can be positioned wherever a master stream is needed. It is placed on the ground, and hose lines are then connected to the portable monitor to supply the water. Most of these devices come equipped with one, two, or three inlets. (page 688, 704)
- Straight stream:** A stream made by using an adjustable nozzle to provide a straight stream of water. (page 684, 704)
- Boiling-liquid, expanding-vapor explosion (BLEVE):** If a liquefied-petroleum gas (LPG) tank is exposed to heat from a fire, the temperature of the liquid inside the container will increase. The fire could then be fueled by propane escaping from the tank or from an external source. As the temperature of the product increases, the vapor pressure will also increase. The increasing pressure creates added stress on the container. If this pressure exceeds the strength of the cylinder, it could rupture catastrophically. An LPG cylinder can have the same explosive properties as dynamite. (page 700)

Fill-In

- | | |
|------------------------------------|-----------------------------------|
| 1. large (page 686) | 7. defensive (page 680) |
| 2. fog (page 683) | 8. booster tank (page 682) |
| 3. defensive (page 680) | 9. transitional attack (page 680) |
| 4. increased risk (page 692) | 10. monitoring (page 696) |
| 5. ignition (page 691) | 11. direct (page 685) |
| 6. exterior fire attack (page 682) | |

True/False

- | | |
|--|--|
| 1. T (page 683) | 8. T (page 680) |
| 2. F (page 695) | 9. T (page 681) |
| 3. T (page 687) | 10. T (page 684) |
| 4. T (page 684) | 11. T (page 684) |
| 5. F (page 689) |  12. T (page 700) |
|  6. F (page 698) |  13. T (page 682) |
| 7. T (page 681) | |

Short Answer

1. **A. Fog stream:** A fog stream divides water into droplets, which have a very large surface area and can absorb heat efficiently. A fog stream can also be used to protect fire fighters from the heat of a large fire.
B. Straight stream: A straight stream has a greater reach than a fog stream, so it can hit the fire from farther away. A straight stream also keeps the water concentrated in a small area, so it can penetrate through a hot atmosphere to reach and cool the burning materials. This type of stream is made up of a highly concentrated pattern of droplets that are all discharged in the same direction.
C. Solid stream: A solid stream is produced by a smooth-bore nozzle. A solid stream has a greater reach and penetrating power than a straight stream, because it is discharged as a continuous column of water. (page 684)
2. **A. Direct attack:** The most effective means of fire suppression in most situations.
B. Indirect attack: Quickly remove as much heat as possible from the fire atmosphere.
C. Combination attack: Employs both indirect attack and direct attack methods in a sequential manner. This strategy should be used when a room's interior has been heated to the point that it is nearing a flashover condition. (pages 685, 686)
3. Fires in ordinary and wood-frame construction can burn in combustible void spaces behind walls and under subfloors and ceilings. Look for signs of fire such as smoke coming from cracks or openings in walls, charred areas with no outward evidence of fire, and peeling or bubbled paint or wallpaper. Listen for cracks and pops or hissing steam. Use a thermal imaging camera to look for areas of heat that may indicate a hidden fire. Use the back of your hand to feel for heat coming from a wall or floor. (pages 685, 686)
4. Fires in basements or below grade level are difficult to recognize. Basement fires can damage the floor above the fire. If fire fighters do not identify a basement fire and enter the building above the basement fire, they are at risk of falling through the damaged floor and ending up in the burning basement. Basements may be difficult and dangerous spaces to enter and have limited routes of egress. They may be difficult to ventilate, which means that an interior attack must often be made in conditions of high heat and low visibility. Likewise, it will be difficult to remove the fire gases and steam produced by the attack lines. As a consequence, fire fighters may find it hard to see in a basement even after ventilation has been performed. Basements are often used for storage, so fire fighters may find it challenging to keep their sense of orientation in the narrow, cluttered spaces. (page 691, 692)
5. Fire fighters should identify the safest means of entry and exit into the area where firefighting operations will be conducted. An exterior access point allows them to enter a basement without passing through the hot gas layers at the basement ceiling level. If the only point of entry is an interior stairway, fire fighters must protect that opening to keep the fire from extending to the upper floors of the building. Ventilation must be planned and conducted early. If this operation is not managed properly, the interior stairwell will act as a chimney and bring heat and smoke up from the basement. Cellar fires can also spread to upper floors in houses with balloon-frame construction. Thermal imagers are especially useful in identifying fires below the floor. (page 692)

6. Protect stairways and other vertical openings between floors when fighting a fire in a multiple-level structure. Hose lines must be placed to keep the fire from extending vertically and to ensure that exit paths remain available. When working with a hose above the ground floor, fire fighters should advance the line uncharged until they reach the fire floor and have extra hose available. Interior fire crews must always look for a secondary exit path in case their entry route becomes blocked by the fire or by a structural collapse. In high-rise buildings, the standpipe system is typically used to supply water for hose lines. Additional hose lines, tools, air cylinders, and Emergency Medical Services equipment should be staged one or two floors below the fire. (page 693)



7. Factors to be evaluated when considering whether to enter an involved structure or to mount an attack include (*Students should include five of the following*): (1) What are the risks versus the potential benefits? (2) Is it safe to send fire fighters into the building? Do not risk fire fighters' lives to retrieve the dead or save a building about to be demolished. (3) What are the structural concerns? (4) Is this building made of lightweight construction? (5) Are there any lives at risk? (6) Does the size of the fire prohibit entry? (7) Are enough fire fighters on the scene to mount an interior attack? (Remember the two-in/two-out rule.) (8) Is an adequate water supply available? (9) Can proper ventilation be carried out to support offensive operations? (page 682)



8. Flammable-gas cylinders can be found in many places. Many types of flammable gases are stored in many different types and sizes of containers. A variety of flammable gases can be found in industrial occupancies. Propane is used as an alternative fuel for vehicles and is often stored to power emergency electrical generators. Propane (LPG) exists as a gas in its natural state at temperatures higher than -44°F (-42.2°C). When the gas is placed into a storage cylinder under pressure, it is changed into a liquid. Storing propane as a liquid is very efficient, because it has an expansion ratio of 270:1.

Inside a propane container, there is a space filled with propane gas above the level of the liquid propane. As the contents of the cylinder are used, the liquid level becomes lower and the vapor space increases. The internal piping is arranged so as to draw product from the vapor space.

Propane gas containers come in a variety of sizes and shapes, with capacities ranging from a few ounces to thousands of gallons. The cylinder itself is usually made of steel or aluminum. A discharge valve keeps the gas inside the cylinder from escaping into the atmosphere and controls the flow of gas into the system where it is used.

A connection to a hose, tubing, or piping allows the propane gas to flow from the cylinder to its destination. In the case of portable tanks, this connection is often the most likely place for a leak to occur. If the gas is ignited, this area could become involved in fire.

A propane cylinder is always equipped with a relief valve to allow excess pressure to escape, thereby preventing an -explosion if the tank becomes overheated. Propane cylinders must be stored in an upright position so that the relief valve remains within the vapor space. (page 699, 700)



9. Propane is highly flammable. Although it is nontoxic, this gas can displace oxygen and cause asphyxiation. By itself, propane is odorless, so leaks of pure propane cannot be detected by the human sense of smell. Propane gas is heavier than air, so it will flow along the ground and accumulate in low areas. The greatest danger with propane and similar products is a BLEVE. (page 700)



10. If an LPG tank is exposed to heat from a fire, the temperature of the liquid inside the container will increase. The fire could then be fueled by propane escaping from the tank or from an external source. As the temperature of the product increases, the vapor pressure will also increase. The increasing pressure creates added stress on the container. If this pressure exceeds the strength of the cylinder, the cylinder can rupture catastrophically. An exploding LPG cylinder can produce the same explosive power as dynamite. (page 700)



11. When responding to a reported LPG leak, fire fighters and their apparatus should be staged uphill and upwind of the scene. Because an explosion can happen at any time, fire fighters should wear full PPE and SCBA at this type of incident. Life safety should be the highest priority; depending on the type and size of the leak, an evacuation might be necessary. The best method to prevent a BLEVE is to direct heavy streams of water onto the tank from a safe distance.

The water should be directed at the area where the tank is being heated. Cool the upper part of the tank to cool the gas vapors.

The fire fighters operating these streams should work from shielded positions or use remote-controlled or unmanned monitors.

If the gas itself is burning because of a pipe or regulator failure, the best way to extinguish the fire is to shut off the main discharge valve at the cylinder. If the fire is extinguished and the fuel continues to leak, there is a high probability that it will reignite explosively. Do not attempt to extinguish the flames unless the source of the fuel has been shut off or all of the fuel has been consumed. If the fire is heating the storage tank, use hose streams to cool the cylinder, being careful not to extinguish the fire.

Unless a remote shut-off valve is available, the flow of propane can be stopped only if it is safe to approach the cylinder.

Approach a flammable-gas fire with two 1¾-inch (45-mm) hose lines working together. When approaching a horizontal LPG tank, always approach it from the sides. The nozzles should be set on a wide fog pattern, with the discharge streams interlocked to create a protective curtain. The team leader should be located between the two nozzle operators.

On the command of the leader, the crew should move forward, remaining together and never turning their backs to the burning product. Upon reaching the valve, the fire fighter in the center can turn off the valve, stopping the flow of gas. Any remaining fire may then be extinguished by normal means. Continue the flow of water as a protective curtain and to reduce sources of ignition.

Always approach and retreat from these types of fires while facing the objective with water flowing, in case of reignition. Unmanned master streams should be used to protect flammable-gas containers that are exposed to a severe fire. Direct the stream so that it is one-third of the way down the container. This technique will allow half of the water to roll up and over the container, while the remainder projects downward. The objective is to cover as much of the exposed tank as possible. If the LPG container is located next to a fully involved building or a fire that is too large to control, evacuate the area and do not fight the fire. If there is nothing to save, risk nothing. (page 700)

Fire Alarms

1. Exit the fire apparatus wearing full PPE, including SCBA. Select the proper hose line used to fight the fire depending on the fire's size, location, and type. Advance the hose line from the apparatus to the entry point of the structure. Activate your SCBA prior to entering the building. Signal the driver/operator that you are ready for water. Open the nozzle to purge air from the system and make sure water is flowing. Make sure ventilation is completed or in progress. Enter the structure and locate the seat of the fire. Apply water in either a straight or solid stream onto the base of the fire in short bursts. Watch for changing fire conditions; use only enough water to extinguish the fire. Locate and extinguish hot spots.
2. Protect the scene and call for the appropriate utility company to come and turn off the power. Do not apply water to the transformer. Let it burn until the power can be shut off or extinguish with a dry chemical extinguisher if possible. Ensure that your apparatus is not placed under any power lines.



Fire Fighter II in Action

Questions 1 and 2: *Answers will vary.*

Skill Drills

Skill Drill 22-2: Performing a Direct Attack (page 685)

1. Exit the fire apparatus wearing full PPE, including SCBA.
2. Select the proper hose line to fight the fire based on the fire's size, location, and type.
3. Advance the hose line from the apparatus to the entry point of the structure. Flake out excess hose in front of the door.
4. Don a face piece and activate the SCBA and personal alert safety system (PASS) device prior to entering the building.
5. Signal the pump operator/driver that you are ready for water.
6. Open the nozzle to purge air from the system and make sure water is flowing.
7. Make sure that ventilation is completed or in progress. (*Note: In the chapter, this step now reads, "Make sure the ventilation team is being coordinated with the attack team."*)
8. Enter into the structure and locate the seat of the fire. (*Note: This step has been omitted and the following steps renumbered 8 through 11.*)
9. Apply water in either a straight or solid stream onto the base of the fire until all visible flame has been extinguished. (*In the chapter, this step now reads, "Apply water to the base of the fire or the ceiling of the fire compartment."*)
10. Watch for changes in fire conditions.
11. Shut down the nozzle and listen.
12. Locate and extinguish hot spots.

Skill Drill 22-3: Performing an Indirect Attack (page 685)

1. Exit the fire apparatus wearing full PPE, including SCBA.
2. Select the correct hose line to be used to attack the fire depending on the type of fire, its location, and its size.
3. Advance the hose line from the apparatus to the opening in the structure where the indirect attack will be made.
4. Don a face piece, and activate the SCBA and PASS device.
5. Notify the operator/driver that you are ready for water.
6. Open the nozzle and make sure that air is purged from the hose line and that water is flowing. If using a fog nozzle, ensure that it is set to the proper nozzle pattern for entry. Shut down the nozzle until you are in a position to apply water.
7. Advance with a charged hose line to the location where you will apply water.
8. Direct the water stream toward the upper levels of the room and ceiling into the heated area overhead, and move the stream back and forth. Flow water until the room begins to darken. Shut the nozzle off, and reassess the fire conditions.
9. Watch for changes and a reduction in the amount of fire. Once the fire is reduced, shut down the nozzle.
10. Confirm that ventilation has been completed.
11. Attack any remaining fire and hot spots until the fire is completely extinguished.

Skill Drill 22-4: Performing a Combination Attack (page 686)

1. Don full PPE and SCBA. Select the correct hose line to accomplish the suppression task at hand.
2. Stretch the hose line to the entry point of the structure, and signal the operator/driver that you are ready to receive water.
3. Open the nozzle to get the air out and make sure that water is flowing.
4. Enter the structure, and locate the room or area where the fire originated.
5. Aim the nozzle at the upper-left corner of the fire and make either a "T," "O," or "Z" pattern with the nozzle. Start high and then work the pattern down to the fire level.
6. Use only enough water to darken down the fire without upsetting the thermal layering.
7. Once the fire has been reduced, find the remaining hot spots and complete fire extinguishment using a direct attack.

Skill Drill 22-5: Performing the One-Fire-Fighter Method for Operating a Large Handline

(page 688)



© Jones & Bartlett Learning. Photographed by Glen E. Ellman.

1. Select the correct size of fire hose. Advance the hose into position. Signal that you are ready for water and open the nozzle to allow air to escape and to ensure that water is flowing. Close the nozzle and then make a loop with the hose, ensuring that the nozzle is **under** the hose line that is coming from the fire apparatus.



© Jones & Bartlett Learning. Photographed by Glen E. Ellman.

2. Lash the hose sections together where they cross, or use your body weight to kneel or sit on the hose line at the point where the hose **crosses itself**.



© Jones & Bartlett Learning. Photographed by Glen E. Ellman.

3. Allow enough hose to extend past the section where the line crosses itself for **maneuverability**.



© Jones & Bartlett Learning. Photographed by Glen E. Ellman.

4. Open the nozzle and **direct** water onto the designated area.

Skill Drill 22-6: Performing the Two-Fire-Fighter Method for Operating a Large Handline

(page 689)



© Jones & Bartlett Learning. Photographed by Glen E. Ellman.

1. **Stretch** the hose line from the fire apparatus into position.



© Jones & Bartlett Learning. Photographed by Glen E. Ellman.

2. **Signal** that you are ready for water and open the nozzle to allow air to escape and to ensure water is flowing. Advance the hose line as needed.



© Jones & Bartlett Learning. Photographed by Glen E. Ellman.

3. Before attacking the fire, the fire fighter on the nozzle should cradle the hose on his or her hip while grasping the nozzle with one hand and supporting the hose with the other hand. The second fire fighter should stay approximately **three** feet behind the fire fighter who is on the nozzle. The second fire fighter should grasp the hose with two hands and may use a knee to stabilize the hose against the ground if necessary.



© Jones & Bartlett Learning. Photographed by Glen E. Ellman.

4. Open the **nozzle** in a controlled fashion and direct water onto the fire or designated exposure.

Chapter 23: Preincident Planning

Matching

- | | |
|-----------------|------------------|
| 1. G (page 720) | 9. H (page 717) |
| 2. I (page 710) | 10. D (page 722) |
| 3. F (page 717) | 11. J (page 723) |
| 4. M (page 719) | 12. L (page 717) |
| 5. B (page 720) | 13. N (page 715) |
| 6. C (page 718) | 14. E (page 708) |
| 7. K (page 710) | 15. A (page 713) |
| 8. O (page 723) | |

Multiple Choice

- | | |
|-----------------|------------------|
| 1. A (page 711) | 6. D (page 720) |
| 2. C (page 723) | 7. D (page 711) |
| 3. B (page 715) | 8. A (page 718) |
| 4. D (page 717) | 9. A (page 714) |
| 5. D (page 723) | 10. A (page 722) |

Vocabulary

- Dry hydrant:** An arrangement of pipes that is permanently connected to a static water supply. (page 720)
- Conflagration:** A large fire, often involving multiple structures. (page 710)
- Preincident plan:** A written document resulting from the gathering of general and detailed information to be used by public emergency response agencies and private industry for determining the response to reasonably anticipated emergency incidents at a specific facility. (page 708)
- Fire alarm annunciator panel:** Part of the fire alarm system that indicates the source of an alarm within a building. (page 711)
- Heating, ventilation, and air-conditioning (HVAC) system:** A system to manage the internal environment that is often found in large buildings. (page 722)
- Ordinary construction:** Buildings where the exterior walls are made of noncombustible or limited-combustible materials, but the interior floors and walls are made of combustible materials. (page 714)
- Material Safety Data Sheet (MSDS) document:** A form, provided by manufacturers and compounders (blenders) of chemicals, containing information about chemical composition, physical and chemical properties, health and safety hazards, emergency response, and waste disposal of the material. (page 725)

Fill-in

- | | |
|--|---|
| 1. retail stores; offices; industrial factories (page 717) | 11. exterior; interior (page 721) |
| 2. electricity; natural gas (page 720) | 12. static water supply (page 719) |
| 3. 75 (page 723) | 13. V (page 714) |
| 4. Material Safety Data Sheet (MSDS) (page 725) | 14. concrete; steel beams; masonry block walls (page 714) |
| 5. Standpipe systems (page 718) | 15. noncombustible; fire resistance protection (page 714) |
| 6. defend-in-place (page 723) | 16. exposure (page 717) |
| 7. horizontal (page 723) | 17. Size-up (page 713) |
| 8. IV; heavy timber (page 714) | 18. alternate (page 711) |
| 9. institutional (page 717) | 19. preincident planning (page 708) |
| 10. occupants; exits (page 721) | 20. survey (page 710) |

- | | |
|-----------------------------------|--|
| 21. incident commander (page 708) | 24. modern information technology (page 708) |
| 22. sprinkler system (page 717) | 25. response (page 711) |
| 23. annunciator panel (page 711) | 26. target hazards (page 710) |



True/False

- | | |
|-----------------|------------------|
| 1. T (page 722) | 6. T (page 713) |
| 2. F (page 714) | 7. F (page 710) |
| 3. F (page 715) | 8. T (page 714) |
| 4. F (page 710) | 9. F (page 710) |
| 5. T (page 708) | 10. T (page 717) |



Short Answer

- Most fire departments are not able to create a preincident plan for every individual property in their jurisdiction. Instead, they identify properties that are particularly large or that present unusual risks. These properties are identified as target hazards. Target hazard properties pose an increased risk to fire fighters. A preincident plan should be prepared for every property that poses a high life-safety hazard to its occupants or presents safety risks for responding fire fighters. Preincident plans should also be prepared for properties that have the potential to create a large fire or conflagration (a large fire involving multiple structures). (page 710)
- Typical target hazard properties that may be found in a community include: (1) Bulk oil facilities and refineries; (2) High-rise buildings; (3) Hospitals; (4) Hotels and rooming houses; (5) Large apartment buildings; (6) Lumberyards; (7) Manufacturing plants; (8) Nursing homes and assisted-living facilities; (9) Public-assembly occupancies; (10) Schools; (11) Shopping centers; (12) Storage structures for hazardous materials; (13) Warehouses. (page 710)
- A preincident survey should be conducted with the knowledge and cooperation of the property owner or occupant or their representative, who should be contacted before the preincident survey is conducted. Making this initial contact enables the fire department to schedule an acceptable time to explain the purpose and the importance of the preincident survey, and to clarify that the information is needed to prepare fire fighters in the event that an emergency occurs at the location. The team members who conduct the survey should dress and conduct themselves in a manner appropriate to the department's mission. A representative of the property should accompany the survey team to answer questions and provide access to different areas. Every effort should be made to obtain accurate, useful information. The preincident survey is conducted in a systematic fashion, following a uniform format. Begin with the outside of the building, gathering all of the necessary information about the building's geographic location, external features, and access points. Then survey the inside of the building to collect information about every interior area. A good, systematic approach starts at the roof and works down through the building, covering every level of the structure, including the basement. If the property is large and complicated, it may be necessary to make more than one visit to ensure that all the required information is obtained and recorded accurately. The same set of basic information must be collected for each property that is surveyed. Additional information should be gathered for properties that are unusually large, are complicated, or might be the site of a particularly hazardous situation. Most fire departments use standard forms to record the survey information. After the team returns to the fire station, they can use the information to develop the preincident plan. The fire fighters conducting the survey should prepare sketches or drawings to show the building layout and the location of important features such as exits. It takes practice and experience to learn how to sketch the required information while doing the survey, and then to convert the information to a final drawing. In some cases, the building owner can provide the survey team with a copy of a plot plan or a floor plan. Some departments use computer-assisted software to create and store these diagrams. These systems have the advantage of creating graphics more quickly and accurately than is possible with hand drawings. Many fire departments also use digital cameras to record information during the survey. (page 711)
- Information that is gathered during a preincident survey includes: (1) Building location; (2) Apparatus access to the exterior of the building; (3) Access points to the interior of the building; (4) Hydrant locations and alternative water supplies; (5) Size of the building (height, number of stories, length, width); (6) Exposures to the fire building and separation distances; (7) Type of building construction; (8) Building use; (9) Type of occupancy (assembly, institutional, residential, commercial, industrial); (10) Floor plan; (11) Life hazards; (12) Building exit plan and exit locations; (13) Stairway locations (note whether the stairways are enclosed or unenclosed); (14) Elevator locations and

emergency controls; (15) Built-in fire protection systems (sprinklers, sprinkler control valves, standpipes, standpipe connections); (16) Fire detection and alarm systems and location of the fire alarm annunciator panel (part of the fire alarm system that indicates the location of an alarm within the building); (17) Utility shut-off locations; (18) Ventilation locations; (19) Presence of hazardous materials; (20) Presence of unusual contents or hazards; (21) Type of incident expected; (22) Sources of potential damage; (23) Special resources required; (24) General firefighting concerns. (page 711)

5. The information that needs to be gathered to assist the incident commander in making a rapid and correct size-up during an emergency incident includes: (1) The building's construction, height, area, use, and occupancy, as well as the presence of hazardous materials or other risk factors; (2) The locations of other buildings or structures that might be jeopardized by a fire in the building; (3) Fire protection system information. Identify areas that are protected by automatic sprinklers or other types of fire extinguishing systems, the locations of standpipes, and the locations of firewalls and other features designed to limit the spread of a fire. Likewise, note any areas where fire protection is lacking, such as an area without sprinklers in a building that otherwise has a sprinkler system; (4) Features inside a building that would allow a fire to spread but are not readily visible from the outside. A common attic space over several occupancies, unprotected openings between floors, or buildings connected by overhead passages or conveyor systems are examples of these features. (page 713)
6. The preincident survey should determine whether the building has a sprinkler system and which parts of the building that system covers. Note the locations of the valves that control water flow to different sections of the system. Normally, these valves are found in the open position.

In addition to the control valves, sprinkler systems should have a fire department connection (FDC) outside the building. (page 717)

7. Tactical information that should be collected during a preincident survey includes considerations for water supply, utilities, search and rescue, forcible entry, ladder placement, and ventilation. (pages 718–722)
8. The required flow rate, measured in gallons per minute or liters per minute, can be calculated based on the building's size, construction, contents, and exposures. In most urban areas, the water supply will come from municipal hydrants. It is important to locate the hydrants closest to the building. In addition, for large buildings, it will be necessary to locate enough hydrants to supply the volume of water required to control a fire. The ability of the municipal water system to provide the required flow must be determined as well. In areas without municipal water systems, water may have to be obtained from a static water supply, such as a lake or stream, or be delivered by fire department tanker (or tenders). When static water sources are used, the preincident plan must identify drafting sites. It is also important to measure the distance from the water source to the fire building to determine whether a large-diameter hose can be used and whether additional engines will be needed. Finally, the preincident plan should outline the operation that would be required to deliver water to the fire. If a tanker (or tender) shuttle will be used to deliver water, the preincident plan must include several additional details. For instance, sites for filling the tankers (or tenders) and for discharging their loads must be identified. The preincident plan should also identify how many tankers (or tenders) will be needed based on the total distance they must travel, the quantity of water each vehicle can transport, and the total time it takes to empty and refill the vehicle. (pages 718–720)
9. Preincident planning for the following is performed by:
 - A. *Search and rescue*: Fire fighters who are conducting search and rescue operations will need to know the locations of the occupants of a building as well as the locations of exits. The preincident survey should identify all entrances and exits to the building, including fire escapes and roof exits. During the preincident survey, team members should obtain the interior floor plan for the building. In large buildings, it may be necessary to plan for the use of ropes during search and rescue to prevent disorientation in conditions of limited visibility. (page 721)
 - B. *Rapid forcible entry*: The preincident survey should consider both exterior and interior access problems. Locations where forcible entry may be required should be identified and marked on the site diagrams and building floor plan. Noting which tools would be needed to gain entry can save time during the actual emergency. The location of a lockbox and instructions on obtaining keys should be identified as well. (page 721)
 - C. *Safe ladder placement*: The preincident survey is an excellent time to identify the best locations for placing ground ladders or using aerial apparatus. The length of ladder needed to reach a roof or entry point should be noted. When planning ladder placement, pay careful attention to any electrical wires and other obstructions that might not be visible at night or in a smoky atmosphere. (page 722)
 - D. *Effective ventilation*: While performing a preincident survey, fire fighters should consider which information would be valuable to the members of a ventilation team during a fire. For example, what would be the best means to provide

ventilation? How useful are the existing openings for ventilation? Are there windows and doors that would be suitable for horizontal ventilation? Where could fans be placed? Could the roof be opened to provide vertical ventilation? What is the best way to reach the roof? Is the roof construction safe? Are there ventilators or skylights that could be easily removed or bulkhead doors that could be opened easily? Will fire fighters need to use saws and axes to cut through the roof? Would multiple ceilings have to be punctured to allow smoke and heat to escape? It is also important to determine whether the heating, ventilation, and air-conditioning (HVAC) system can be used to remove smoke without circulating it throughout the building. Many buildings with sealed windows have controls that enable the fire department to set the HVAC system to deliver outside air to some areas and exhaust smoke from other areas. The instructions for controlling the HVAC system should be included in the preincident plan. Roof construction must also be evaluated to determine whether it would be safe for fire fighters to work on the roof when there is a fire below. If the roof is constructed with lightweight trusses, the risk of collapse is great. Many fire departments do not permit fire fighters on these roofs. The presence of an attic that might allow a fire to spread quickly under the roof should also be noted. In addition, common attics in townhouses and shopping malls can spread fire from one occupancy to another. (page 722)

10. The following occupancy considerations need to be taken into account when conducting a preincident survey:

A. High-rise buildings: High-rise buildings present special problems during an emergency because of the difficulty in gaining access and because of the large numbers of occupants. A preincident survey should identify both the building construction and any special features that have been installed. It should note all of the systems that are present in a particular building and identify how they are designed to function. This information, in turn, should be incorporated into the preincident plan. The fire protection features of a high-rise building will vary depending on the age of the building and the specific building and fire code requirements in different jurisdictions. Older high-rise buildings are generally constructed of noncombustible materials and designed to confine a fire within a limited area. Newer buildings generally include automatic sprinklers, smoke detection and alarm systems, emergency generators, elevator control systems, smoke control systems, and building control stations where all these systems are monitored and controlled. The details of each system must be documented in the preincident plan. In many cases, expert consultants may be contacted to develop an emergency plan for such a building. These plans are intended to be used by the building tenants and management as well as the fire department. (page 723)

B. Assembly occupancies: Public-assembly venues—such as theaters, nightclubs, stadiums, churches, hotel meeting rooms, and arenas—present the possibility that large numbers of people could become involved in an emergency incident. These structures are often very large and complicated, and they may be equipped with complex systems intended to manage emergency situations. Gaining access to the location of the fire or emergency situation may prove difficult, however, when all of the occupants are trying to evacuate at the same time. (page 723)

C. Healthcare facilities: Healthcare facilities—such as hospitals, nursing homes, assisted-living facilities, surgery centers, and ambulatory healthcare centers—require special preincident planning. Hospitals are often very large and include many different areas, ranging from operating rooms to walk-in clinics. The most challenging problem during an emergency incident at a healthcare facility is protecting nonambulatory patients. A defend-in-place philosophy is used when designing fire protection for these facilities. This approach presumes that patients will not be able to escape from a fire without assistance and that there may not be enough staff present to move all of the patients. Therefore, the facility itself is designed to protect the patients from the fire. Most healthcare facilities utilize fire-resistant construction, have fire detection systems and sprinkler systems, and are compartmentalized. If it becomes necessary to move patients from a dangerous area, the preferred approach is often horizontal evacuation. It is much easier to wheel a bed to another area on the same floor level than to carry patients down stairways. (page 723)

D. Detention and correctional facilities: By their very nature, detention and correctional facilities are designed to ensure that the occupants cannot leave the building, even under normal conditions. The preincident plan must consider the problems involved in removing the inmates from a dangerous situation while protecting the fire fighters from angry or frightened inmates. Additionally, security concerns can make it difficult for fire fighters to gain rapid access to the building or for occupants and rescuers to exit the facility. (page 723)

E. Residential occupancies: In addition to the standard preincident plan information, the following information will be helpful when developing a preincident plan for a private residence: (1) Detailed floor plan; (2) Location of sleeping areas; (3) Information about any handicapped occupants; (4) Escape routes and an outside rendezvous area; (5) Fire hydrant or water source location. (page 723)

11. The types of locations that require special considerations in preplanning include airports, bridges, and tunnels, as well as incidents along highways or railroad lines, or at construction sites. The following special locations would also require preincident planning: (1) Gas or liquid fuel transmission pipelines; (2) Electrical transmission lines; (3) Ships and waterways; (4) Subways; (5) Railroads; (6) Any other locations where complicated situations could occur. (page 724)

Word Fun

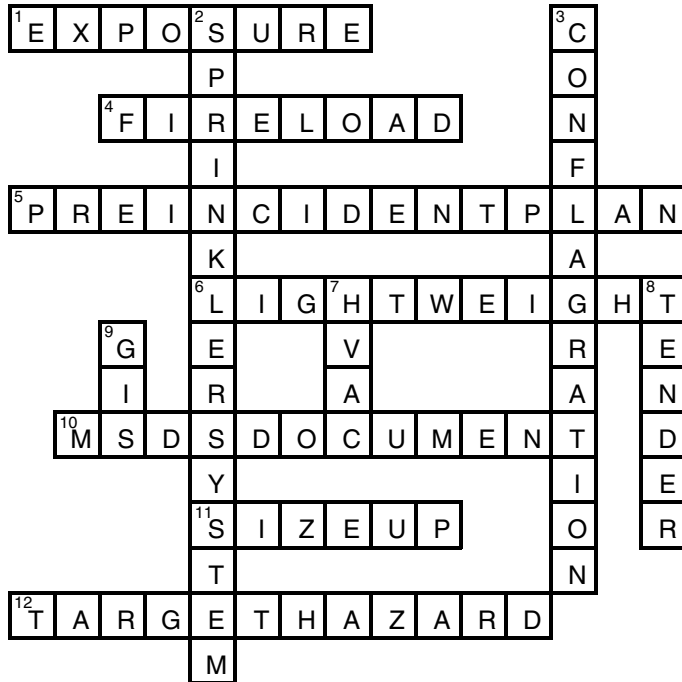

Fire Alarms

- A. Typical target hazard properties include: bulk oil facilities and refineries; high-rise buildings; hospitals; hotels and rooming houses; large apartment buildings; lumberyards; manufacturing plants; nursing homes and assisted-living facilities; public assembly occupancies; schools; shopping centers; storage structures for hazardous materials; warehouses.

B. Properties with increased life-safety hazards include: hospitals; nursing facilities; assisted-living facilities; large apartment buildings; hotels and rooming houses; schools; public assembly occupancies.
- The steps necessary for conducting a good preincident survey include scheduling the survey in advance. Make contact with a responsible person. Identify yourself by name, title, and department. Present a neat and professional image. Ensure that a representative accompanies you during the survey. Take notes as needed, and start outside. Note the building location. Identify the building construction. Identify the building use and occupancy. Note any life hazards. Note the access points to the interior of the building. Note the utility shut-off locations. Assess the apparatus access to the building. Note hydrant locations and/or alternative water supplies. Note ventilation concerns. Record built-in fire detection and suppression systems. Sketch floor plans. Note the elevator and stairway locations. Review exit plans and exit locations. Identify any special hazards and hazardous materials. Note the building exposures. Anticipate the type of incident expected. Identify any special resources needed. Complete and file the preincident survey form.

Fire Fighter II in Action

- Answers will vary.
- Answers will vary.

Chapter 24: Fire and Emergency Medical Care

Matching

1. F (page 737)
2. C (page 734)
3. H (page 739)
4. J (page 733)
5. I (page 735)
6. G (page 734)
7. D (page 735)
8. A (page 735)
9. E (page 738)
10. B (page 739)

Multiple Choice

1. A (page 740)
2. D (page 734)
3. D (page 735)
4. D (page 738)
5. A (page 734)
6. A (page 732)
7. A (page 734)
8. D (page 737)
9. C (page 735)
10. B (page 739)

Vocabulary

1. **Basic life support (BLS):** Basic Life Support (BLS) is the level of medical care that can be provided by persons trained to perform the following limited set of emergency medical skills: (1) Scene control; (2) Evaluating conditions for responder and victim safety; (3) Patient assessment; (4) Basic airway management techniques; (5) Cardiopulmonary resuscitation (CPR); (6) Providing basic care for medical emergencies; (7) Administering oxygen; (8) Splinting; (9) Controlling external bleeding and bandaging; (10) Treating for shock; (11) Lifting and moving patients; (12) Transporting patients to an appropriate medical facility. (page 733)
2. **Combination EMS system:** A system in which the fire department provides medical first response, and another agency transports the patient to the hospital emergency room. (page 737)
3. **Medical director:** Authorizes the EMS providers in the service to deliver medical care in the field. (page 738)
4. **Fire department EMS system:** A system in which the fire department both provides medical first response and transports the patient to the hospital emergency room. (page 737)
5. **Advanced life support (ALS):** Advanced life-saving procedures, such as cardiac monitoring, administration of IV fluids and medications, and use of advanced airway adjuncts. (page 734)
6. **Paramedic:** An EMT who has extensive training in advanced life support, including intravenous therapy, pharmacology, endotracheal intubation, and other advanced assessment and treatment skills. (page 735)

Fill-in

1. 80 (page 732)
2. ALS; standing orders; protocols; radio direction (page 734)
3. basic; advanced (page 733)
4. cross train (page 737)
5. BLS (page 734)
6. fire codes; public education (page 733)
7. emergency medical responder (page 734)
8. save lives; property (page 732)
9. Paramedic (page 735)
10. emergency (page 733)

True/False

1. T (page 737)
2. F (page 732)
3. T (page 737)
4. F (page 737)
5. F (page 735)
6. F (page 737)
7. T (page 732)
8. T (page 739)
9. T (page 739)

Short Answer

1. Provide prompt, efficient, competent care for all members of your community, regardless of their age, socioeconomic background, or nature of injury. (page 738)
2. Fire department EMS systems both provide the medical first response and transport patients. These medical and transport services may be provided at either BLS or ALS levels. As in a combination system, engine companies, truck companies, or special EMS units may be used for medical first response. Because all of the personnel work for the same agency, training is easily accomplished and efforts are coordinated under a united control. (page 737)
3. In a combination EMS system, the fire department provides medical first response and another agency operates the ambulances that transport the patients. (page 737)
4. The medical director serves as an ongoing liaison among the medical community, hospitals, and the EMS providers. If treatment problems arise or if different procedures should be considered, the medical director must be consulted for a decision and directions. (page 739)
5. The EMR is expected to assess and provide basic care for the patient until EMTs or Paramedics arrive to provide further care and transportation to a medical facility. The EMR course typically exceeds 40 hours in length and is designed to train a person to stabilize a patient at the scene by providing immediate, life-saving care such as controlling bleeding, establishing an airway, initiating CPR, and using an AED. (page 734)
6. The duties and abilities of the EMT are: (1) Scene size-up; (2) Securing the scene and scene safety; (3) Patient assessment; (4) Simple airway techniques; (5) CPR; (6) Splinting; (7) Bandaging; (8) Administering oxygen; (9) Lifting and moving ill and injured patients; (10) Controlling external bleeding; (11) Treating for shock; (12) Ambulance operations; (13) Performing cardiac defibrillation using an AED (page 735)
7. The duties and abilities of the Paramedic are: (1) Using electrocardiograms to evaluate the patient; (2) Administering medications; (3) Inserting endotracheal tubes into the airway; (4) Electrically pacing the heart; (5) Identifying causes and treatments of diseases (page 735)
8. Direct or online medical control is provided by an EMS physician who can be reached by radio or telephone during a call. Local protocols define when EMS providers should give a radio report or obtain online medical direction. Once the crew has initiated any immediate, urgent care according to standing orders, the online medical control physician is contacted. The crew then provides a report that describes the patient's condition and any treatment provided. The physician either confirms or modifies this proposed treatment plan; he or she may also prescribe special orders that the EMS providers are to follow for that patient.

Indirect or offline medical controls are standing orders that direct the EMS providers to take specific actions when they encounter particular situations. (page 739)

Word Fun

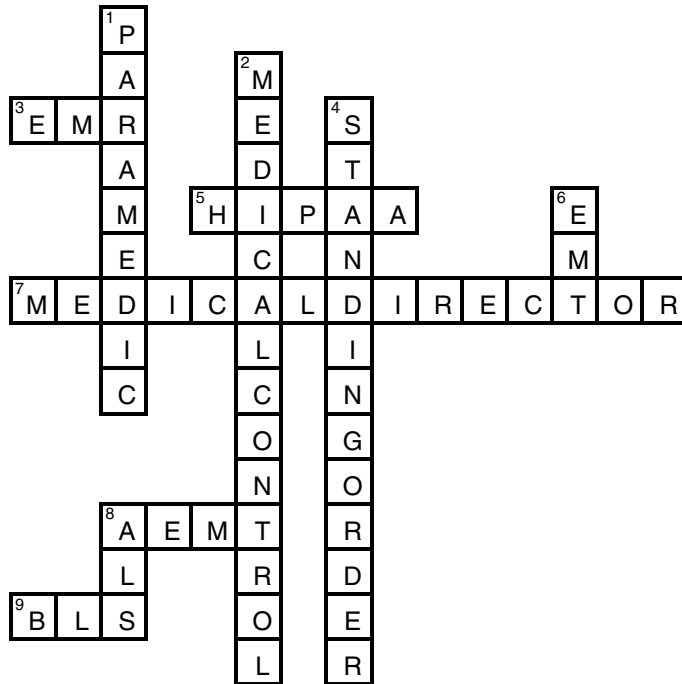

Fire Alarms

1. There are several advantages to having EMS systems located within the fire department. For example, the entry requirements for fire fighters help ensure the hiring of quality employees. Most fire departments are required to regularly monitor the health and fitness of their employees, and most have mechanisms in place to provide for continuing education. Fire departments also have the infrastructure in place to support EMS operations, including radio systems, dispatch services, and fire stations located strategically throughout the community. As a result, the fire department is prepared to respond quickly to EMS calls throughout its jurisdiction. Furthermore, the fire department is familiar with the community and its people, which can be invaluable when responding to and treating patients. In short, many communities find that when they need to find a home for their EMS system, the fire department is a good fit.
2. The EMT course involves more than 110 hours of training and teaches the following skills: (1) Scene size-up; (2) Securing the scene and scene safety; (3) Patient assessment; (4) Simple airway techniques; (5) CPR; (6) Splinting; (7) Bandaging; (8) Administering oxygen; (9) Lifting and moving ill and injured patients; (10) Controlling external bleeding; (11) Treating for shock; (12) Ambulance operations; (13) Performing cardiac defibrillation using an AED.



Fire Fighter II in Action

1. Answers will vary.
2. Answers will vary.
3. Answers will vary.
4. Answers will vary.

Chapter 25: Emergency Medical Care

Matching

1. J (page 793)
2. F (page 796)
3. H (page 766)
4. G (page 774)
5. D (page 751)
6. C (page 794)
7. L (pages 751, 772)
8. B (page 750)
9. A (page 794)
10. E (pages 774, 787)
11. K (page 776)
12. I (page 750)

Multiple Choice

1. B (page 778)
2. A (page 788)
3. A (page 764)
4. A (page 801)
5. A (page 772)
6. B (page 791)
7. D (page 765)
8. C (page 747)
9. D (page 793)
10. D (page 774)
11. A (page 749)
12. C (page 788)
13. B (page 774)
14. C (page 765)
15. C (page 788)
16. C (page 777)
17. A (page 751)
18. B (page 772)
19. A (page 759)
20. C (page 765)
21. B (page 765)
22. D (page 768)
23. B (pages 750–751)
24. C (page 759)
25. D (page 750)
26. B (page 759)
27. B (page 750)
28. D (page 751)
29. C (pages 751, 772)
30. B (page 753)

Labeling

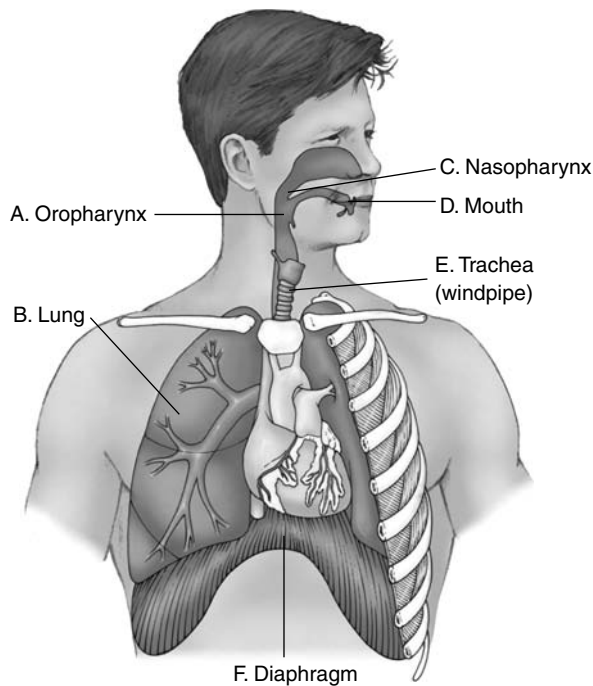

Figure 25-3

1. Anatomy of the respiratory system. (page 750)

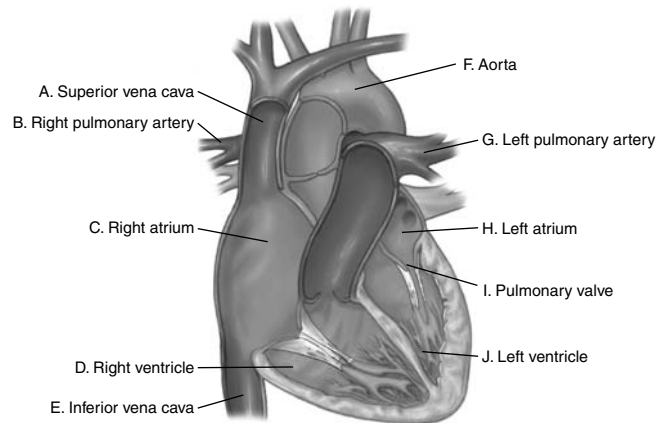

Figure 25-42

2. The heart. (page 787)

Vocabulary

- Dependent lividity:** The red or purple color that appears on those parts of the victim's body closest to the ground. It is caused by blood seeping into the tissues on the dependent, or lower, part of the person's body. (page 776)
- Radial artery:** The major artery in the forearm. It is palpable at the wrist on the thumb side. (page 772)
- Shock:** A state of collapse of the cardiovascular system; the state of inadequate delivery of blood to the organs of the body. (page 788)
- Cardiopulmonary resuscitation (CPR):** The artificial circulation of the blood and movement of air into and out of the lungs in a pulseless, nonbreathing victim. (page 774)
- Recovery position:** A position that helps keep the victim's airway open by allowing secretions to drain out of the mouth instead of into the trachea. Recovery position also uses gravity to prevent the victim's tongue and lower jaw from blocking the airway. (page 756)

Fill-in

- food (page 765)
- shock (page 791)
- responsiveness (page 752)
- two (page 777)
- HIV (page 746)
- chest compressions (page 774)
- oxygen; carbon dioxide (page 750)
- lungs (page 751)
- jaw-thrust (page 753)
- 95; 100 (page 770)
- gastric distention (page 771)
- universal precautions (page 747)

True/False

- | | |
|-----------------|----------------------|
| 1. T (page 774) | 7. F (pages 778–779) |
| 2. T (page 785) | 8. T (page 747) |
| 3. F (page 748) | 9. T (page 750) |
| 4. T (page 748) | 10. F (page 760) |
| 5. F (page 776) | 11. T (page 774) |
| 6. F (page 750) | 12. T (page 752) |

Short Answer

- The five steps used to combat or begin treatment of shock are: (1) Position the victim correctly. (2) Maintain the victim's ABCs. (3) Treat the cause of shock, if possible. (4) Maintain the victim's body temperature. (5) Do not allow the victim to eat or drink. (page 789)
- You should discontinue CPR only in the following circumstances: (1) Effective, spontaneous circulation and ventilation are restored. (2) Resuscitation efforts are transferred to another trained person who continues CPR. (3) A physician assumes responsibility for the victim and orders you to stop. (4) The victim is transferred to properly trained EMS personnel. (5) Reliable criteria for death are recognized. (6) You are too exhausted to continue resuscitation, environmental hazards endanger your safety, or continued resuscitation would place the lives of others at risk. (page 776)
- The Centers for Disease Control and Prevention's recommended five steps for universal precautions are: (1) Always wear gloves when handling victims, and change gloves after contact with each victim. Wash your hands immediately after removing gloves. (Note that leather gloves are not considered to be safe, because leather is porous and traps fluids.) (2) Always wear protective eyewear or a face shield when you anticipate that blood or other bodily fluids may splatter. Wear a gown or apron if you anticipate splashes of blood or other bodily fluids, such as those that occur with childbirth and major trauma. (3) Wash your hands and other skin surfaces immediately and thoroughly if they become contaminated with blood and other bodily fluids. Change contaminated clothes and wash exposed skin thoroughly. (4) Place used needles directly in a puncture-resistant container designed for sharps. (5) Even though saliva has not been proven to transmit HIV, you should use a face shield, pocket mask, or other airway adjunct if the victim needs resuscitation. (page 747)
- Respiratory arrest has many causes (*Students should list five of the following*). (1) Heart attack; (2) Mechanical blockage or obstruction caused by the tongue; (3) Vomitus, particularly in a victim who has been weakened by a condition such as a stroke; (4) Foreign objects such as teeth, dentures, balloons, marbles, pieces of food, or pieces of hard candy (especially in small children); (5) Illness or disease; (6) Drug overdose; (7) Poisoning; (8) Severe loss of blood; (9) Electrocution by electrical current or lightning (page 759)
- The human heart consists of four chambers: two on the right side and two on the left side. Each upper chamber is called an atrium. The right atrium receives blood from the veins of the body; the left atrium receives blood from the lungs. The bottom chambers are the ventricles. The right ventricle pumps blood to the lungs; the left ventricle pumps blood throughout the body. The most muscular chamber of the heart is the left ventricle, which needs the most power because it must force blood to all parts of the body. Together the four chambers of the heart work in a well-ordered sequence to pump blood to the lungs and to the rest of the body.
One-way valves in the heart and veins allow the blood to flow in only one direction through the circulatory system. The arteries carry blood away from the heart at high pressure; to withstand this pressure, they have very thick walls. The main artery carrying blood away from the heart is quite large (about 1 inch [25 millimeters] in diameter), but arteries become smaller as they branch out farther away from the heart. (page 772)
- Signs and symptoms of shock are as follows (*Students should include five of the following*): (1) Confusion, restlessness, or anxiety; (2) Cold, clammy, sweaty, pale skin; (3) Rapid breathing; (4) Rapid, weak pulse; (5) Increased capillary refill time; (6) Nausea and vomiting; (7) Weakness or fainting; (8) Thirst (pages 788–789)

Word Fun

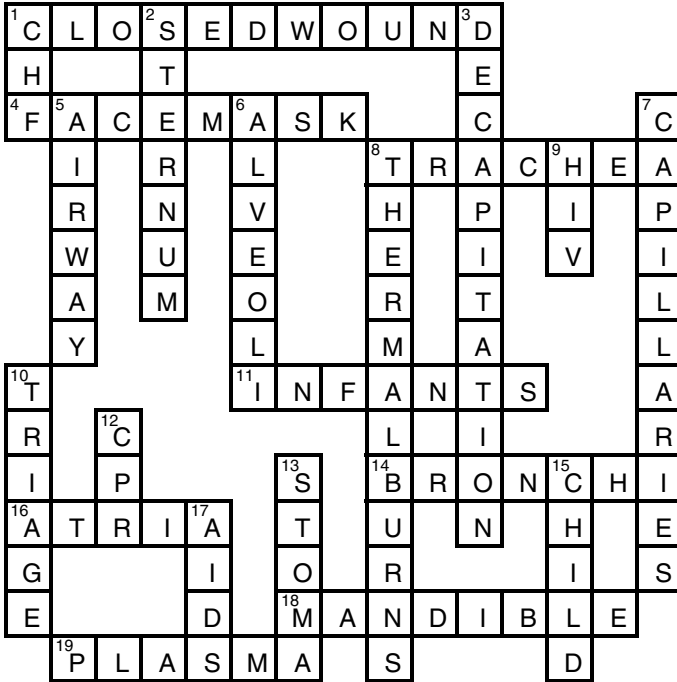

Fire Alarms

1. CDC-recommended universal precautions include: (1) Always wear gloves when handling victims, and change gloves after contact with each victim. Wash your hands immediately after removing gloves. (Note that leather gloves are not considered to be safe, because leather is porous and traps fluids.) (2) Always wear protective eyewear or a face shield when you anticipate that blood or other bodily fluids may splatter. Wear a gown or apron if you anticipate splashes of blood or other bodily fluids, such as those that occur with childbirth and major trauma. (3) Wash your hands and other skin surfaces immediately and thoroughly if they become contaminated with blood and other bodily fluids. Change contaminated clothes and wash exposed skin thoroughly. (4) Place used needles directly in a puncture-resistant container designed for sharps. (5) Even though saliva has not been proven to transmit HIV, you should use a face shield, pocket mask, or other airway adjunct if the victim needs resuscitation.
2. (A) Anaphylactic shock is caused by an extreme allergic reaction to a foreign substance (an allergen), such as venom from bee or insect stings, penicillin, or certain foods.
(B) To treat shock, follow these general steps: (1) Position the victim correctly. (2) Maintain the victim's ABCs. (3) Treat the cause of shock, if possible. (4) Maintain the victim's body temperature by placing blankets under and over the victim. (5) Make sure the victim does not eat or drink anything. (6) Assist with other treatments (such as administering oxygen, if available). (7) Arrange for immediate and prompt transportation to an appropriate medical facility.



Fire Fighter II in Action

1. Answers will vary.
2. Answers will vary.

Skill Drills

Skill Drill 25-3: Placing a Victim in the Recovery Position

(page 756)



© Jones & Bartlett Learning. Photographed by Glen E. Ellman.

1. Carefully roll the victim onto one side as you support the victim's **head**. Roll the victim as a unit without twisting the **body**. You can use the victim's **hand** to help hold his or her head in a good position.



© Jones & Bartlett Learning. Photographed by Glen E. Ellman.

2. Place the victim's head on its side so that any **secretions** drain out of the **mouth**.



© Jones & Bartlett Learning. Photographed by Glen E. Ellman.

3. Monitor the victim's airway. Bending the victim's **knee** will help maintain the victim in the recovery position.

Skill Drill 25-12: Performing One-Rescuer Adult CPR
(page 779)



1. Establish responsiveness and lack of breathing.



2. Check for circulation.



3. Perform chest compressions.



4. Open the airway.

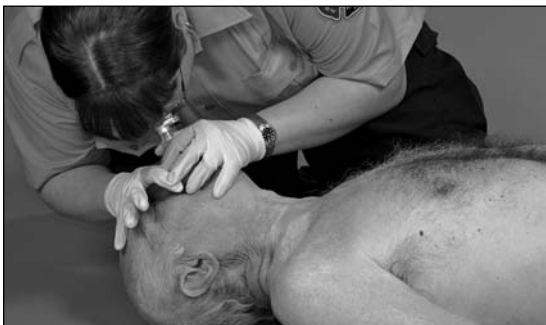

5. Perform rescue breathing.

Chapter 26: Vehicle Rescue and Extrication

Matching

- | | |
|-----------------|------------------|
| 1. G (page 810) | 6. A (page 818) |
| 2. B (page 821) | 7. H (page 817) |
| 3. F (page 824) | 8. C (page 818) |
| 4. J (page 811) | 9. E (page 824) |
| 5. I (page 819) | 10. D (page 811) |

Multiple Choice

- | | |
|------------------|-----------------------|
| 1. C (page 810) | 11. B (page 829) |
| 2. D (page 821) | 12. A (pages 817–819) |
| 3. C (page 831) | 13. A (page 811) |
| 4. C (page 827) | 14. A (page 824) |
| 5. A (page 829) | 15. D (page 830) |
| 6. B (page 833) | 16. B (page 824) |
| 7. A (page 831) | 17. C (pages 817–819) |
| 8. A (page 830) | 18. C (page 825) |
| 9. D (page 828) | 19. B (page 818) |
| 10. D (page 818) | 20. C (page 821) |

Labeling

1. Anatomy of a vehicle. (page 811)

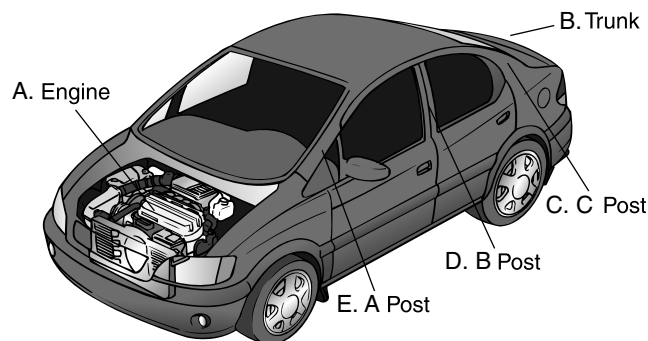

Figure 26-2

Vocabulary

1. **Hybrid vehicle:** A vehicle that uses a battery-powered electric motor and a gasoline-powered engine. (page 811)
2. **Firewall:** The structure that divides the engine compartment from the passenger compartment. (page 811)
3. **Platform frame:** A type of vehicle frame resembling a ladder, which is made up of two parallel rails joined by a series of cross members. This kind of construction is typically used for luxury vehicles, sport utility vehicles, and all types of trucks. (page 811)
4. **Post:** One of the vertical support members of a vehicle that holds up the roof and forms the upright columns of the passenger compartment. (page 811)
5. **Unibody:** The frame construction most commonly used in passenger vehicles. The base unit is made of formed sheet metal; structural components are then added to the base to form the passenger compartment. Subframes are attached to each end. This type of construction does away with the rail beams used in platform-framed vehicles. (page 811)



Fill-in

1. door (page 823)
2. BLEVE (page 810)
3. response (page 814)
-  4. door (page 825)
-  5. hazards; scope (page 814)
-  6. passenger (page 811)
-  7. A (pages 830–831)
-  8. law enforcement (page 816)
-  9. pressure (page 820)
-  10. B (page 811)

True/False

1. T (page 811)
2. T (page 818)
3. F (page 819)
4. T (page 827)
5. F (page 825)
6. T (page 816)
7. F (page 815)
8. T (page 815)
9. T (page 817)

Short Answer

1. The four general functions of gaining access and disentangling a victim are: (1) *Stabilize or hold an object or vehicle:* An example is stabilizing a vehicle with cribbing to keep it from moving. (2) *Bend, distort, or displace:* An example is bending a vehicle door back to get it out of the way. (3) *Cut or sever:* An example is cutting a roof. (4) *Disassemble:* An example is removing a vehicle door by unbolting the door hinges. (page 821)
-  2. Some vehicle air bag safety tips are (*Students should list five of the following*): (1) On most recently manufactured vehicles, the steering wheel contains the driver's-side air bag, which is a life-saving safety feature for the driver of the vehicle. Front-passenger air bags may also be present. (2) If the air bag deployed during the crash, it does not present a safety hazard for rescuers. (3) If the air bag did not deploy during the crash, it presents a hazard both for the occupant of the vehicle and for rescue personnel. An undeployed air bag could deploy if wires are cut or if it becomes activated during the rescue operation. (4) If the air bag did not deploy, disconnect the battery and allow the air bag capacitor to discharge. The time required to discharge the capacitor varies from one model of air bag to another. (5) Do not place a hard object such as a backboard between the victim and an undeployed air bag. (6) Do not attempt to cut the steering wheel if the air bag has not deployed. (7) For your safety, never get in front of an undeployed air bag. You could suffer serious injury if it activates unexpectedly. (8) Some vehicles contain side-mounted air bags or curtains that provide lateral protection for occupants. Check vehicles for the presence of these devices. (page 830)
-  3. Safety tips for using rescue-lift air bags include the following (*Students should list five of the following*): (1) Never stack high-pressure lift air bags more than two high. (2) Do not use a rescue-lift air bag to pull a steering column. (3) Do not use a rescue-lift air bag as the sole means to stabilize a vehicle; cribbing must be the primary stabilizer. (4) Never operate the rescue-lift air bag system without having been properly trained and fully understanding how the system works. (5) When stacking rescue-lift air bags, the largest size should be on the bottom and the smallest on top. The bottom rescue-lift air bag should be inflated first. (6) Place a sheet of plywood on the ground under the air bag to protect it. (7) Do not use boards or plywood between or above rescue-lift air bags. (8) Clean rescue-lift air bags by following the recommendations of their manufacturer. (9) Test rescue-lift air bags regularly. (10) Never store a lift air bag near gasoline. (page 821)

Word Fun

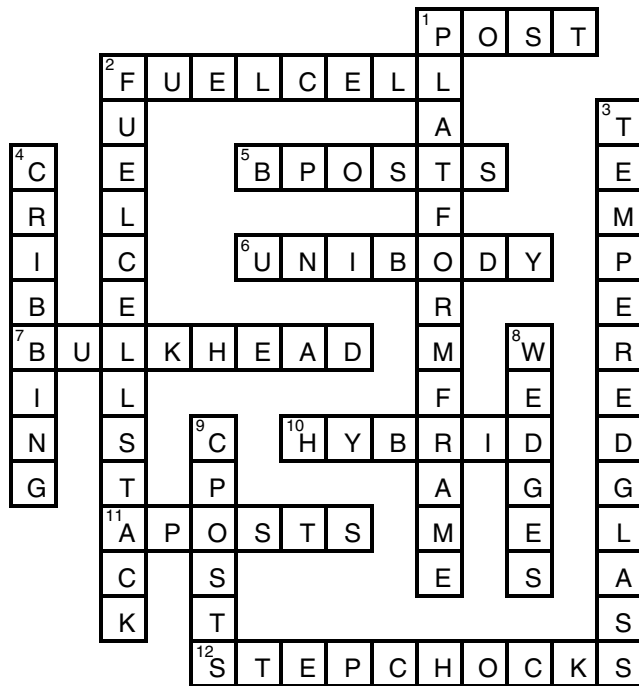

Fire Alarms

1. A. Protecting the scene from approaching traffic: Whenever possible, place emergency vehicles in a manner that will ensure safety and does not disrupt traffic any more than necessary. However, do not hesitate to request that the road be closed if necessary. Remember—safety first! Position large emergency vehicles so that they provide a barrier against motorists who fail to heed emergency warning lights. Many departments place apparatus at an angle to the crash. This position helps to push the apparatus to the side of a crash in the event that the emergency apparatus is struck from behind. Traffic cones or flares can be placed to direct motorists away from the crash. If needed, call for law enforcement to assist in traffic control.

Fire fighters need to be readily visible at a crash scene. Personal protective equipment (PPE) should be bright to help ensure fire fighters' visibility during daylight hours; PPE that is used at night should be equipped with reflective material to increase visibility in the darkness. PPE must be worn at all motor vehicle crashes.

- B. Scene size-up: (1) Position the emergency vehicle so as to protect the scene. Size up the scene from inside this vehicle. (2) Transmit the initial report over the radio. (3) Establish command. (4) Perform a scene size-up outside the vehicle. (5) Check for overhead hazards. (6) Approach the crash scene vehicles and examine the space under the vehicles. (7) Perform a 360-degree walk-around of the entire scene. (8) Assess the hazards. (9) Determine the number of people involved. (10) Determine the severity of the victims' injuries. (11) Determine the level of entanglement. (12) Assess the resources available, and call for additional units if needed. (13) Give an updated report. (14) Establish a secure work area and stabilize the vehicles. (15) Establish a staging resource area. (16) Direct the placement of arriving apparatus. (17) Assign personnel and tasks.
2. A. Equipment to use for vehicle stabilization: (1) Cribbing; (2) Step chocks; (3) Wedges; (4) Rescue-lift air bags
- B. Steps to stabilize the vehicles: (1) Don PPE. (2) Lay out a tarp at the edge of the secure work area for staging tools and equipment, if indicated. (3) Enter the secure work area safely. (4) Assess the scene for hazards. (5) Chock both sides of one tire to prevent the vehicle from rolling. (6) Place one step chock at each corner of the vehicle, and deflate the tires or use wedges to stabilize the vehicle.

Fire Fighter II in Action

1. *Answers will vary.*

Skill Drills

Skill Drill 26-2: Performing a Scene Size-up at a Motor Vehicle Crash (page 816)



© Jones & Bartlett Learning. Photographed by Glen E. Ellman.

1. Position emergency vehicles to protect the crash scene and the rescuers. Take any additional actions needed to prevent further crashes.



© Jones & Bartlett Learning. Photographed by Glen E. Ellman.

2. Perform a quick initial assessment from the first-arriving vehicle, establish command, and give a brief initial radio report.



© Jones & Bartlett Learning. Photographed by Glen E. Ellman.

3. Perform a 360-degree walk-around looking for potential hazards. Look for overhead hazards and hazards under the vehicles, and determine the stabilization needed to prevent further movement of the vehicles involved in the incident.



© Jones & Bartlett Learning. Photographed by Glen E. Ellman.

4. Determine the number of patients, the severity of their injuries, and the amount of entrapment. Give an updated report and call for additional resources if needed.



© Jones & Bartlett Learning. Photographed by Glen E. Ellman.

5. Establish a secure working area and an equipment staging area.



© Jones & Bartlett Learning. Photographed by Glen E. Ellman.

6. Direct personnel to perform initial tasks.

Skill Drill 26-4: Stabilizing a Vehicle Following a Motor Vehicle Crash (page 820)



© Jones & Bartlett Learning. Photographed by Glen E. Ellman.

1. Don personal protective equipment (PPE), including face protection. Minimize hazards to **rescuers** and **victims**. **Chock** both sides of one tire to prevent the vehicle from **rolling** by placing one **chock** in front of a wheel and a second **chock** in back of the **wheel**.



© Jones & Bartlett Learning. Photographed by Glen E. Ellman.

2. Consider **deflating** tires for added stability. Assess the need for **step chocks** for additional stability.



© Jones & Bartlett Learning. Photographed by Glen E. Ellman.

3. Turn off the **ignition** and remove the key or fob.



© Jones & Bartlett Learning. Photographed by Glen E. Ellman.

4. Place the gear shift in **park**, and apply the **parking brake**.

Chapter 27: Assisting Special Rescue Teams

Matching

1. C (page 853)
2. E (page 844)
3. H (page 852)
4. G (page 852)
5. B (page 848)
6. F (page 853)
7. A (page 843)
8. J (page 854)
9. I (page 843)
10. D (page 858)

Multiple Choice

1. B (page 846)
2. D (page 854)
3. C (page 859)
4. B (page 851)
5. B (page 857)
6. C (page 845)
7. C (page 848)
8. C (page 852)
9. D (page 858)
10. A (page 850)
11. B (page 844)
12. D (page 851)
13. B (page 845)
14. D (page 842)
15. C (page 843)
16. A (page 845)
17. B (page 840)
18. A (page 846)
19. B (page 845)
20. A (page 844)
21. C (page 843)
22. C (page 846)
23. A (page 845)
24. A (page 842)
25. D (page 843)

Vocabulary

1. **Lockout/tagout system:** Methods of ensuring that electricity and other utilities have been shut down and switches are locked so that they cannot be switched on, so as to prevent flow of power or gases into the area where rescue is being conducted. (page 843)
2. **Hazardous materials:** Any materials or substances that pose a significant risk to the health and safety of persons and/or to the environment if they are not properly handled during manufacture, processing, packaging, transportation, storage, use, or disposal. (page 858)
3. **Technical rescue incident:** A complex rescue incident involving vehicles or machinery, water or ice, rope techniques, a trench or excavation collapse, confined spaces, a structural collapse, wilderness search and rescue operation, or hazardous materials, and which requires specially trained personnel and special equipment. (page 840)

Fill-in

1. asphyxiants (page 847)
2. prior (page 851)
3. Structural (page 854)
4. stabilized (page 845)
5. training (page 848)
6. law enforcement (page 843)
7. incident command system (page 848)
8. awareness (page 840)
9. decontaminated (page 845)
10. terminology (page 842)
11. packaging (page 845)
12. proportional (page 843)

True/False

- | | |
|-----------------|------------------|
| 1. T (page 855) | 7. T (page 848) |
| 2. F (page 841) | 8. F (page 843) |
| 3. T (page 857) | 9. T (page 846) |
| 4. T (page 844) | 10. T (page 841) |
| 5. T (page 850) | 11. T (page 841) |
| 6. F (page 843) | |

Short Answer

- Considerations during size-up include (*Students should list five of the following*): (1) Scope and magnitude of the incident; (2) Risk–benefit analysis; (3) Number of known and potential victims; (4) Hazards; (5) Access to the scene; (6) Environmental factors; (7) Available and necessary resources; (8) Establishment of control perimeters. (page 846)
- The five guidelines that a fire fighter should follow when assisting rescue team members are: (1) Be safe. (2) Follow orders. (3) Work as a team. (4) Think. (5) Follow the Golden Rule of public service, which emphasizes the ethic of reciprocity: Treat others as you would like to be treated. (page 841)
- The paramilitary guidelines for which a fire fighter must have a strong appreciation in order to understand the command and control concept of fire departments are: (1) The fire officer's knowledge base and experience are greater than yours. (2) Orders come from superiors. Legitimate orders are those given by a fire officer or other designated person. (3) Follow rules and procedures. A fire fighter is required to follow rules, procedures, and guidelines regardless of his or her personal opinions. (4) You must do your own job. (5) Get the job done. In emergency situations, time is critical. Nevertheless, you must not act beyond your own skill and training level, and you must not violate any rules, procedures, standard operating guidelines, or orders of a superior in an effort to get the job done quickly. (page 841)
- (1) Preparation; (2) Response; (3) Arrival and size-up; (4) Stabilization; (5) Access; (6) Disentanglement; (7) Removal; (8) Transport; (9) Security of the scene and preparation for the next call; (10) Postincident analysis. (page 842)
- F:** Failure to understand the environment, or underestimating it. **A:** Additional medical problems not considered. **I:** Inadequate rescue skills. **L:** Lack of teamwork or experience. **U:** Underestimating the logistics of the incident. **R:** Rescue versus recovery mode not considered. **E:** Equipment not mastered. (page 842)
- (1) Vehicle and machinery rescue; (2) Confined-space rescue; (3) Rope rescue; (4) Trench and excavation rescue; (5) Structural collapse rescue; (6) Water and ice rescue; (7) Wilderness rescue; (8) Hazardous materials incidents. (page 840)
- All confined spaces should be considered to contain, or have the potential to contain, a hazardous atmosphere until proven otherwise.

As you approach a rescue scene, look for a bystander who might have witnessed the emergency. Information gathered prior to the technical rescue team's arrival will save valuable time during the actual rescue. Do not assume that a person in a pit has simply suffered a heart attack; instead, assume that an immediately dangerous to life and health (IDLH) atmosphere is present at any confined-space call. An IDLH atmosphere can immediately incapacitate anyone who enters the area without breathing protection. Toxic or explosive gases may be present, or the confined space may not have enough oxygen to support life.

When a rescue involves a confined space, remember that it will take some time for qualified rescuers to arrive on the scene and prepare for a safe entry into the confined space. Given this delay, the victim of the original incident may have died before your arrival. Do not put your life in danger on behalf of a body recovery. The majority of deaths in confined spaces are would-be rescuers.

Your main role in confined-space rescues is to secure the scene, preventing other people from entering the confined space until additional rescue resources arrive. If the incident has occurred at an industrial site, ascertain whether a confined-space entry permit was prepared. If so, locate the entry supervisor and attendant listed on the permit and have them stand by at the space. As additional highly trained personnel arrive, your company may provide help by giving the rescuers a situation report.

The first-responding company must share whatever information it discovered at the rescue scene with other arriving crews. Anything that might be important to the response should be noted by the first-arriving unit. Observed condi-

tions should be compared to reported conditions, and a determination should be made as to the relative change over the time period. Whether an incident appears to be stable or has changed greatly since the first report will affect the operation strategy for the rescue. A size-up should be completed quickly and immediately upon arrival, and this information should be relayed to the special rescue team members upon their arrival at the scene. Other items of importance that should be included in a situation report are a description of any rescue attempts that have been made, the exposures, any hazards present, the extinguishment of fires, the facts and probabilities of the scene, the situation and resources of the fire company, the identities of any hazardous materials present, and an evaluation of the progress made so far.

Many engine and ladder companies carry atmospheric or gas detection devices; if you have this capability, obtain readings to determine whether the situation presents a hazard. If you do encounter an oxygen-deficient atmosphere, set up a ventilation fan to help remove toxic gases and improve air flow to the victim. Sometimes you can help a victim without entering the confined space by passing down self-contained breathing apparatus (SCBA), oxygen, first-aid supplies, or even a ladder that the victim can use to climb out.

Confined-space rescues can be complex and take a long time to complete. You may be asked to assist by bringing rescue equipment to the scene, maintaining a charged hose line, or providing crowd control. By understanding the hazards associated with confined spaces, you will be better prepared to assist a specialized team that is dealing with an emergency involving a confined space. (page 851)

8. Hazardous materials incidents are not always dispatched as hazardous materials incidents. Given this fact, you must be able to recognize the signs indicating that hazardous materials may be present as you approach the scene. Preincident plans may note that a fixed facility stores chemicals, or the use of a specific type of transport container may tip you off to the presence of hazardous materials. You might also see an escaping chemical or smell a suspicious odor. Warning placards are required for most hazardous materials for storage or in transit.

Once you have recognized the presence of a hazardous material, you must protect yourself by staying out of the area exposed to the material. If you have happened upon a hazardous materials incident, it is important to have the hazardous materials team dispatched as soon as possible. In addition to standard action and precautions, call for a special hazardous materials rescue team immediately upon your arrival at such an incident, implement site control and scene management, and assist specialized personnel after their arrival according to your training level.

To assist in operations at a hazardous materials incident, you need formal training in techniques to deal with this kind of threat. Training at the awareness level will provide you with the knowledge and skills you need to be able to recognize the presence of a hazardous material, protect yourself, call for appropriate assistance, and evacuate or secure the affected area. As part of your training, you will learn how to assist other responders to the hazardous materials incident.

The four major objectives of training at the operational level are to analyze the magnitude of the hazardous materials incident, plan an initial response, implement the planned response, and evaluate the progress of the actions taken to mitigate the incident. Being trained and equipped to perform emergency decontamination of victims may help to minimize the effects of chemical exposures while hazardous materials technicians are en route. (page 858)

 **Word Fun**



 **Fire Alarms**

1. Tools to assemble include the following: (1) Personal protective equipment; (2) Hydraulic tools (spreaders, cutters, rams); (3) Halligan tool; (4) Cutting torch; (5) Air chisels; (6) Cribbing; (7) Saber saw; (8) Windshield cutter; (9) Spring-loaded punch; (10) Chains; (11) Air bags (high and low pressure); (12) Extra SCBA tanks; (13) Basic hand tool; (14) Come along; (15) Portable generator; (16) Seat belt cutters; (17) Hand lights and other scene lighting; (18) Hose lines (protection); (19) Blanket
2. Safety is of paramount importance when approaching a trench or excavation collapse. Walking close to the edge of a collapse can trigger a secondary collapse, so stay away from the edge of the collapse and keep all workers and bystanders at a distance from the site. Vibration from equipment and machinery can also cause secondary collapses, so shut off all heavy equipment. Likewise, vibrations caused by nearby traffic can cause collapse, so it may be necessary to stop or divert traffic near the scene.
3. Respond safely to the emergency scene. Place the emergency vehicle in a safe position that protects the scene, and perform a size-up to assess for hazards. Secure the scene and call for needed assistance. Don the appropriate personal protective equipment (PPE). Use appropriate devices to establish a barrier, following the IC's orders.

 **Fire Fighter II in Action**

1. Answers will vary.
2. Answers will vary.

Chapter 28: Hazardous Materials: Overview

Matching

1. F (page 870)
2. J (page 868)
3. C (page 873)
4. E (page 870)
5. H (page 874)
6. I (page 873)
7. B (page 871)
8. G (page 869)
9. A (page 873)
10. D (page 870)

Multiple Choice

1. D (page 873)
2. C (page 871)
3. B (page 868)
4. C (page 873)
5. B (page 871)
6. B (page 870)
7. A (page 870)
8. D (page 870)
9. A (page 873)
10. C (page 873)

Vocabulary

1. **Specialist level:** A level of fire fighter expertise at which the individual receives more specialized training than a hazardous materials technician does. Practically speaking, the two levels are not very different. Most of the training that specialist employees receive is either product or transportation mode specific. (page 871)
2. **Local emergency planning committee (LEPC):** A group (consisting of members of industry, transportation officials, the public at large, media, and fire and police agencies) that gathers and disseminates information on hazardous materials stored in the community and ensures that there are adequate local resources to respond to a chemical event in the community. (page 873)
3. **Operations level:** First responders at the operations level are individuals who respond to releases or potential releases of hazardous substances as part of the initial response to the site for the purpose of protecting nearby persons, property, or the environment from the effects of the release. They are trained to respond in a defensive fashion without actually trying to stop the release. Their function is to contain the release from a safe distance, keep it from spreading, and prevent exposures. (page 871)
4. **Material safety data sheet (MSDS):** A form, provided by manufacturers and compounders (blenders) of chemicals, containing information about chemical composition, physical and chemical properties, health and safety hazards, emergency response, and waste disposal of the material. (page 873)
5. **HAZWOPER:** Hazardous Waste Operations and Emergency Response. This OSHA regulation governs hazardous materials waste sites and response training. Specifics can be found in 29 CFR 1910.120. Subsection (q) is specific to emergency response. (page 870)

Fill-in

1. Preplanning (page 874)
2. Hazardous waste (page 869)
3. Environmental Protection Agency (page 873)
4. state-plan (page 870)
5. more (page 874)
6. HAZWOPER (page 870)
7. recognize; identify; notify (page 871)
8. NFPA 472 (page 868)
9. material safety data sheet (page 873)
10. technicians (page 873)

True/False

1. F (page 873)
2. T (page 874)
3. T (page 868)
4. T (page 873)
5. T (page 873)
6. T (page 874)
7. F (page 874)
8. F (page 874)
9. F (page 873)
10. T (page 874)

Short Answer

1. The Superfund Amendments and Reauthorization Act (SARA) was one of the first laws to affect how fire departments respond in a hazardous materials emergency. Finalized in 1986, SARA was the original driver for OSHA's HAZWOPER regulation. Indirectly, it indicated that workers handling hazardous wastes should have a minimum amount of training. Additionally, this law laid the foundation that ultimately allowed local fire departments and the community at large to obtain information on how and where hazardous materials were stored in their community. (page 873)
2. The five levels of hazardous materials training and competencies, according to NFPA 472, are: (1) Awareness-level personnel are persons who, in the course of their normal duties, could encounter an emergency involving hazardous materials/weapons of mass destruction (WMD). They are expected to recognize the presence of the hazardous materials/WMD, protect themselves, call for trained personnel, and secure the area. This level of training enables those who are first on scene of an incident to recognize a potential hazardous materials emergency, isolate the area, and call for assistance. Awareness-level trained persons are not seen as responders, but they do take protective actions. (2) Operations-level responders are persons who respond to hazardous materials/WMD incidents for the purpose of protecting nearby persons, the environment, or property from the effects of the release. Fire fighters in modern society are usually trained to the operations level because they should be able to recognize potential hazardous materials incidents, isolate and deny entry to other responders and the public, evacuate persons in danger, and take defensive actions such as shutting off valves and protecting drains without having contact with the product. Operations-level responders act in a defensive fashion. (3) Technician-level fire fighters are trained to enter heavily contaminated areas using the highest levels of personal protection. Hazardous materials technicians take offensive actions. (4) Specialist-level fire fighters receive more specialized training than do hazardous materials technicians. Practically speaking, however, the two levels are not very different. The majority of the specialized training relates to a specific product such as chlorine or to a specific mode of transportation such as rail emergencies. (5) The hazardous materials branch director/group supervisor level of training is intended for those assuming command of a hazardous materials incident beyond the operations level. Individuals trained as hazardous materials branch director/group supervisors receive operations-level training as well as additional training specific to commanding a hazardous materials incident. The hazardous materials branch director/group supervisor is trained to act as a branch director or group supervisor for the hazardous materials component of the incident. (pages 870–873)

Word Fun

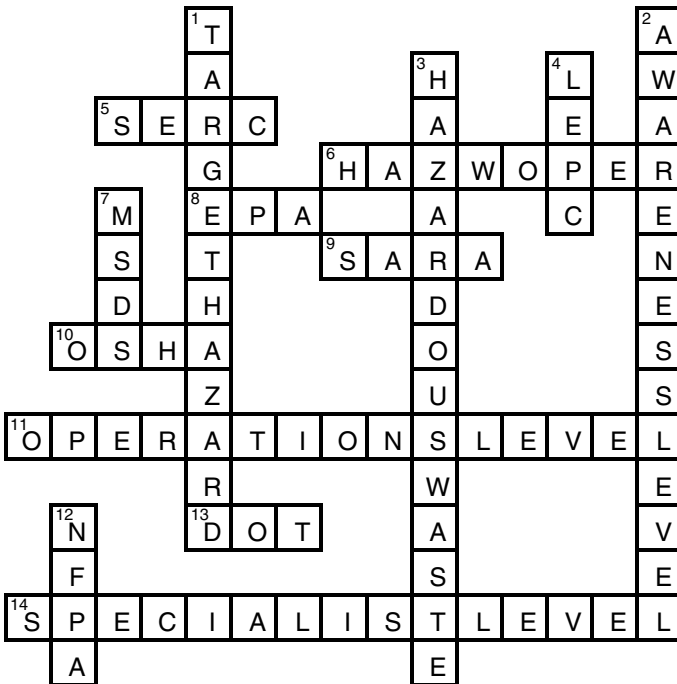

Fire Alarms

1. The response begins with finding out about potential hazards in your area. Response agencies also should conduct preincident planning activities related to target hazards and other potential problem areas throughout the jurisdiction. Preplanning activities enable agencies to develop logical and appropriate response procedures for anticipated incidents. Jurisdictions that have no railways or maritime ports do not have to include training for those kinds of responses. Planning should focus on the real threats that exist in your community or adjacent communities you could be assisting. Once the threats have been identified, agencies must determine how they will respond. Some agencies establish parameters that guide their response to particular hazardous materials incidents. Those parameters outline incident severity based on the nature of the chemical, the amount released, or the type of occupancy involved in the incident.
2. A hazardous material, as defined by the U.S. Department of Transportation (DOT), is a material that poses an unreasonable risk to the health and safety of operating emergency personnel, the public, and/or the environment if it is not properly controlled during handling, storage, manufacture, processing, packaging, use and disposal, or transportation.



Fire Fighter II in Action

1. Answers will vary.
2. Answers will vary.

Chapter 29: Hazardous Materials: Properties and Effects

Matching

- | | |
|-----------------|------------------|
| 1. C (page 881) | 6. J (page 885) |
| 2. E (page 890) | 7. I (page 882) |
| 3. A (page 892) | 8. G (page 886) |
| 4. D (page 881) | 9. F (page 882) |
| 5. H (page 883) | 10. B (page 883) |

Multiple Choice

- | | |
|------------------|------------------|
| 1. B (page 885) | 12. A (page 886) |
| 2. A (page 887) | 13. D (page 888) |
| 3. A (page 894) | 14. D (page 881) |
| 4. B (page 889) | 15. A (page 884) |
| 5. B (page 894) | 16. D (page 885) |
| 6. C (page 889) | 17. C (page 885) |
| 7. A (page 885) | 18. C (page 881) |
| 8. C (page 885) | 19. C (page 881) |
| 9. D (page 880) | 20. B (page 883) |
| 10. C (page 881) | 21. A (page 883) |
| 11. B (page 891) | 22. B (page 881) |

Labeling

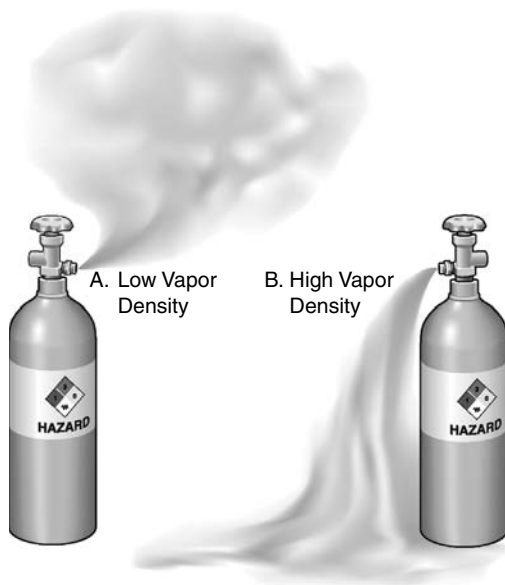

Figure 29-3

1. Vapor density. (page 883)

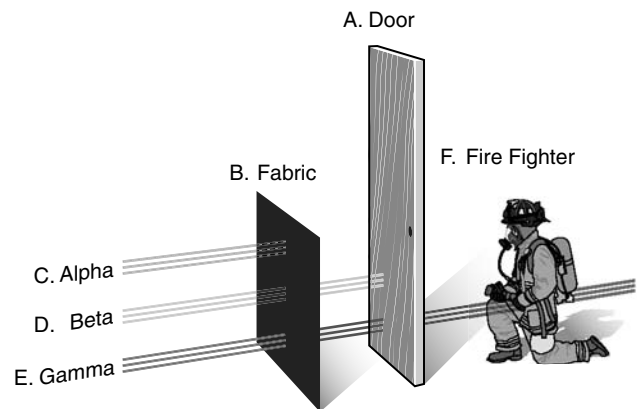
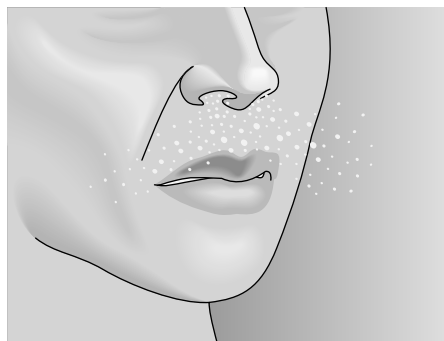

Figure 29-6

2. Alpha, beta, and gamma radiation. (page 887)



A. Inhalation



B. Absorption

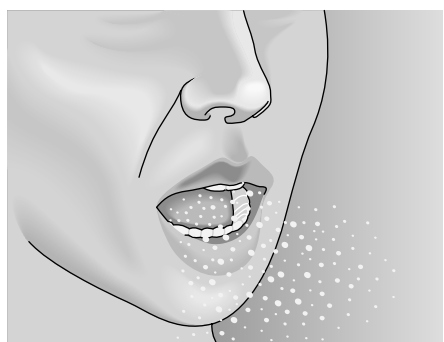

C. Ingestion

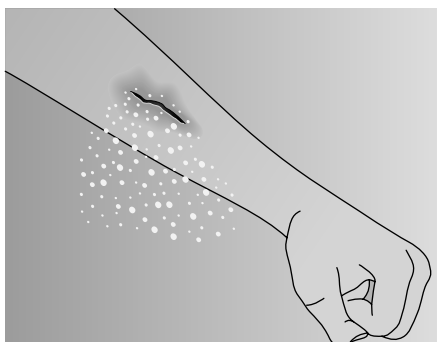

D. Injection

Figure 29-8

3. The four ways a chemical substance can enter the body. (page 890)

Vocabulary

1. **Contamination:** The process of transferring a hazardous material from its source to people, animals, the environment, or equipment, all of which may act as carriers for the material. (page 888)
2. **Flammable vapor:** A concentration of constituents in air that exceeds 10 percent of its lower flammable limit (LFL). (page 881)
3. **Weapon of mass destruction (WMD):** (1) A weapon used to cause mass casualties, damage, and chaos; (2) any destructive device, such as any explosive, incendiary, or poison gas bomb, grenade, rocket having a propellant charge of more than 4 ounces (113 grams), missile having an explosive or incendiary charge of more than $\frac{1}{4}$ ounce (7 grams), mine, or device similar to the above; (3) any weapon involving toxic or poisonous chemicals; (4) any weapon involving a disease organism; or (5) any weapon that is designed to release radiation or radioactivity at a level dangerous to human life. (page 888)
4. **Radiation:** Energy transmitted through space in the form of electromagnetic waves or energetic particles. (page 886)
5. **HEPA filter:** High-efficiency particulate air filter capable of catching particles as small as 0.3 micron—much smaller than a typical dust or alpha radiation particle. (page 887)

Fill-in

1. ignition (page 882)
2. predict (page 880)
3. Flash point (page 882)
4. convulsants (page 890)
5. physical (page 881)
6. Beta (page 887)
7. -43°F (-41°C) (page 882)
8. 14.7 (page 881)
9. float (page 884)
10. elements (page 886)

True/False

1. T (page 884)
2. T (page 892)
3. F (page 886)
4. T (page 881)
5. T (page 882)
6. T (page 888)
7. F (page 886)
8. T (page 882)
9. T (page 887)
10. F (page 881)

Short Answer

1. In the absence of reliable reference sources in the field, you can use the HA HA MICEN mnemonic to remember a number of lighter-than-air gases. This mnemonic stands for:
H: Hydrogen
A: Acetylene
H: Helium
A: Ammonia
M: Methane
I: Illuminating gas (neon and hydrogen cyanide)
C: Carbon monoxide
E: Ethylene
N: Nitrogen (page 883)
2. The health hazards posed by radiation are a function of two factors: (1) The amount of radiation absorbed by the body has a direct relationship to the degree of damage done. (2) The amount of exposure time ultimately determines the extent of the injury. (page 886)
3. The nerve agent signs and symptoms represented by the mnemonic "SLUDGEM" are:
S: Salivation
L: Lachrymation (tearing)
U: Urination
D: Defecation
G: Gastric disturbance
E: Emesis (vomiting)
M: Miosis (constriction of the pupil) (page 888)
4. The four ways through which chemical substances can enter the human body are: (1) *Inhalation*: Through the lungs. (2) *Absorption*: By permeating the skin. (3) *Ingestion*: Via the gastrointestinal tract. (4) *Injection*: Through cuts or other breaches in the skin. (page 890)
5. Possible hazardous material incidents represented by the mnemonic "TRACEMP" are (*Students should list any five of the following*):
Thermal: Heat created from intentional explosions or fires, or cold generated by cryogenic liquids.
Radiological: Radioactive contamination from dirty bombs; alpha, beta, and gamma radiation.
Asphyxiation: Oxygen deprivation caused by materials such as nitrogen; tissue asphyxiation from blood agents.
Chemical: Injury and death caused by the intentional release of toxic industrial chemicals, nerve agents, vesicants, poisons, or other chemicals.
Etiological: Illness and death resulting from biohazards such as anthrax, plague, and smallpox; hazards posed by bloodborne pathogens.

Mechanical: Property damage and injury caused by explosion; falling debris; shrapnel; firearms; explosives; and slips, trips, and falls.

Psychogenic: The mental harm from being potentially exposed to and contaminated by, or even just being in close proximity to, an incident of this nature. (page 888)

Word Fun

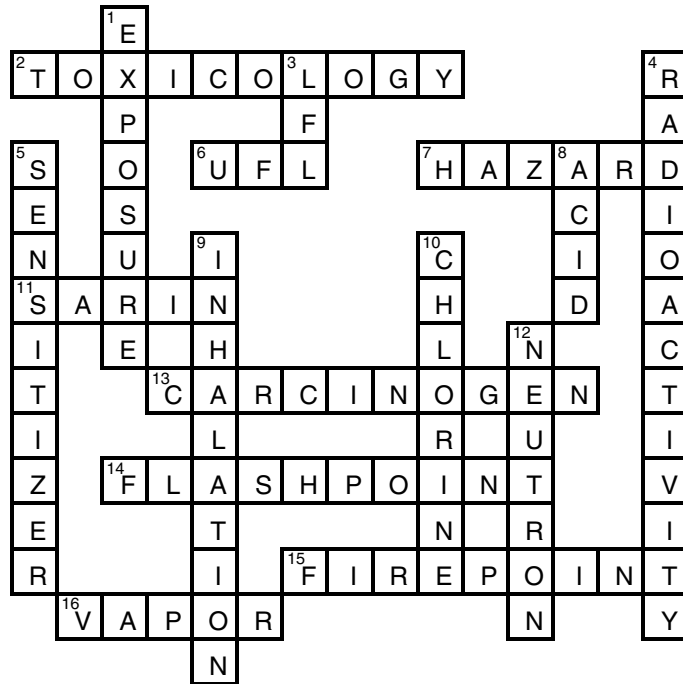

Fire Alarms

1. From a terrorism perspective, irritants may be employed to incapacitate rescuers or to drive a group of people into another area where a more dangerous substance can be released. Irritants pose the least amount of danger in terms of toxicity of all the potential WMD agents a fire fighter may encounter. Exposed patients can be decontaminated with clean water, and the residual effects of the exposure should not be significant.
2. Make every effort to reduce or eliminate the ability of the substance to enter your body, and keep the duration of the exposure to an absolute minimum. This requires you to reduce the time you are exposed to the material, to stay far enough away so that you are not directly exposed, and/or to shield yourself with personal protective equipment or solid objects. Time, distance, and shielding are methods used to protect fire fighters from the adverse effects of radiation. If you suspect a radiation incident at a fixed facility, you should initially ask for the radiation safety officer of the facility. This person is responsible for maintaining the use, handling, and storage procedures for all the radioactive material at the site. This person will likely be a tremendous resource to you and will know exactly what is being used at the facility.



Fire Fighter II in Action

1. Answers will vary.
2. Answers will vary.
3. Answers will vary.

Chapter 30: Hazardous Materials: Recognizing and Identifying the Hazards

Matching

- | | |
|-----------------|------------------|
| 1. F (page 910) | 6. H (page 914) |
| 2. A (page 905) | 7. C (page 903) |
| 3. E (page 914) | 8. D (page 904) |
| 4. B (page 904) | 9. I (page 906) |
| 5. G (page 904) | 10. J (page 914) |

Multiple Choice

- | | |
|------------------|------------------|
| 1. A (page 913) | 11. B (page 903) |
| 2. B (page 917) | 12. C (page 907) |
| 3. C (page 905) | 13. A (page 904) |
| 4. D (page 903) | 14. B (page 907) |
| 5. A (page 915) | 15. D (page 903) |
| 6. C (page 911) | 16. D (page 906) |
| 7. C (page 915) | 17. A (page 907) |
| 8. B (page 914) | 18. D (page 913) |
| 9. D (page 904) | 19. C (page 906) |
| 10. A (page 914) | 20. A (page 905) |

Labeling

1. Chemical transport vehicles. (page 908)



Courtesy of Polar Tank Trailer L.L.C.



Courtesy of Polar Tank Trailer L.L.C.



Courtesy of Rob Schnepp.



E. An MC-338 cryogenic tanker

Courtesy of Jack B. Kelley, Inc.



F. A tube trailer

Courtesy of Jack B. Kelley, Inc.



G. A dry bulk cargo tank

Courtesy of Polar Tank Trailer L.L.C.



H. Intermodal tanks

Courtesy of Eurotainer.

Figure 30-6

Vocabulary

1. **Pipeline right-of-way:** An area, patch, or roadway that extends a certain number of feet on either side of the pipe itself and that may contain warning and informational signs about hazardous materials carried in the pipeline. (page 910)
2. **Shipping papers:** A shipping order, bill of lading, manifest, or other shipping document serving a similar purpose and usually including the names and addresses of both the shipper and the receiver as well as a list of shipped materials along with their quantity and weight. (page 914)
3. **Placards and labels:** Placards are diamond-shaped indicators (10 inches on each side) that must be placed on all four sides of highway transport vehicles, railroad tank cars, and other forms of transportation carrying hazardous materials. Labels are smaller versions (4-inch diamond-shaped indicators) of placards and are used on the four sides of individual boxes and smaller packages being transported. Placards and labels are intended to give fire fighters a general idea of the hazard inside a particular container. A placard may identify the broad hazard class (e.g., flammable, poison, corrosive) of material that a tanker contains, while the label on a box inside a delivery truck relates only to the potential hazard inside that package. (page 911)
4. **Hazardous materials:** Any materials or substances that pose an unreasonable risk of damage or injury to persons, property, or the environment if not properly controlled during handling, storage, manufacture, processing, packaging, use and disposal, or transportation. (page 902)
5. **Secondary containment:** Any device or structure that prevents environmental contamination when the primary container or its appurtenances fail. Examples of secondary containment include dikes, curbing, and double-walled tanks. (page 903)

Fill-in

1. W (page 913)
2. waybills; consist (page 914)
3. Hazardous Materials Information System (page 913)
4. military (page 914)
5. 312 (page 907)
6. material safety data sheet (page 914)
7. size-up (page 902)
8. pipelines (page 910)
9. 102 (page 904)
10. tube (page 907)

True/False

1. F (page 915)
2. F (page 911)
3. T (page 913)
4. T (page 904)
5. T (page 914)
6. T (page 902)
7. F (page 904)
8. T (pages 904–905)
9. T (page 913)
10. F (page 913)

Short Answer

1. The nine ERG chemical families are: (1) DOT Class 1: Explosives. (2) DOT Class 2: Gases. (3) DOT Class 3: Flammable combustible liquids. (4) DOT Class 4: Flammable solids. (5) DOT Class 5: Oxidizers. (6) DOT Class 6: Poisons (including blood agents and choking agents). (7) DOT Class 7: Radioactive materials. (8) DOT Class 8: Corrosives. (9) DOT Class 9: Other regulated material. (pages 911–912)
2. Information that is normally included on a material safety data sheet includes (*Students should include five of the following*): (1) Physical and chemical characteristics; (2) Physical hazards of the material; (3) Health hazards of the material; (4) Signs and symptoms of exposure; (5) Routes of entry; (6) Permissible exposure limits; (7) Responsible-party contact; (8) Precautions for safe handling (including hygiene practices, protective measures, and procedures for cleaning up spills or leaks); (9) Applicable control measures, including personal protective equipment; (10) Emergency and first-aid procedures; (11) Appropriate waste disposal. (page 914)
3. The NFPA 704 hazard identification system uses a diamond-shaped symbol of any size, which is itself broken into four smaller diamonds, each representing a particular property or characteristic. The blue diamond at the nine o'clock position indicates the health hazard posed by the material. The top red diamond indicates flammability. The yellow diamond at the three o'clock position indicates reactivity. The bottom white diamond is used for special symbols and handling instructions. The blue, red, and yellow diamonds will each contain a numerical rating of 0 to 4, with 0 being the least hazardous and 4 being the most hazardous for that type of hazard. The white quadrant will not have a number but may contain special symbols. Among the symbols used are a burning O (oxidizing capability), a three-bladed fan (radioactivity), and a W with a slash through it (water reactive). (pages 912–913)
4. The four colored sections of the ERG and their descriptions are: (1) *Yellow section*: Chemicals in this section are listed numerically by their four-digit UN identification number. Entry number 1017, for example, identifies chlorine. Use the yellow section when the UN number is known or can be identified. The entries include the name of the chemical and the emergency action guide number. (2) *Blue section*: Chemicals in the blue section are listed alphabetically by name. The entry will include the emergency action guide number and the identification number. The same information, organized differently, appears in both the blue and yellow sections. (3) *Orange section*: This section contains the emergency action guides. Guide numbers are organized by general hazard class and indicate what basic emergency actions should be taken, based on hazard class. (4) *Green section*: This section is organized numerically by UN identification number and provides the initial isolation distances for specific materials. Chemicals included in this section are highlighted in the blue or yellow sections. Any materials listed in the green section are always extremely hazardous. This section also directs the reader to consult the tables listing toxic inhalation hazard (TIH) materials. These gases or volatile liquids are extremely toxic to humans and pose a hazard to health during transportation. (page 912)
5. Specific information that is included on a pesticide bag label includes (*Students should list five of the following*): (1) Name of the product; (2) Statement of ingredients; (3) Total amount of product in the container; (4) Manufacturer's name and address; (5) U.S. Environmental Protection Agency (EPA) registration number, which provides proof that the product was registered with the EPA; (6) The EPA establishment number, which shows where the product was

manufactured; (7) Signal words to indicate the relative toxicity of the material: (a) Danger: Poison: Highly toxic by all routes of entry, (b) Danger: Severe eye damage or skin irritation, (c) Warning: Moderately toxic, and (d) Caution: Minor toxicity and minor eye damage or skin irritation; (8) Practical first-aid treatment description; (9) Directions for use; (10) Agricultural use requirements; (11) Precautionary statements such as mixing directions or potential environmental hazards; (12) Storage and disposal information; (13) Classification statement on who may use the product.

In addition, every pesticide label must carry the statement, “Keep out of reach of children.” (page 905)

Word Fun

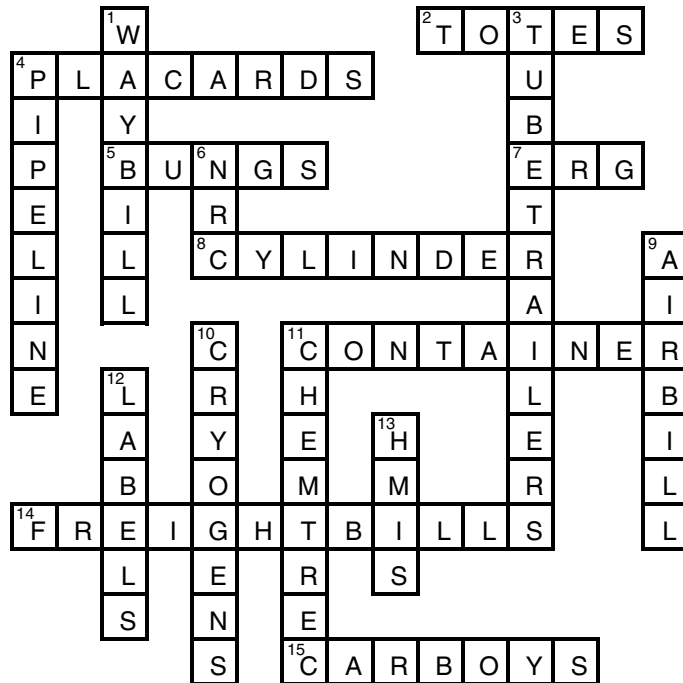

Fire Alarms

- (A) A secondary device is a second explosive device placed in a location with the intent to kill emergency responders after an initial explosion has taken place. (B) Indicators of potential secondary devices may include trip devices such as timers, wires, or switches. They may also include common concealment containers, such as briefcases, backpacks, boxes, or other common packages, and uncommon concealment containers, such as pressurized vessels (e.g., propane tanks) or industrial chemical containers (e.g., chlorine storage containers). Attackers may be watching the site of the primary devices and waiting to manually activate the secondary devices.
- (A) The information collected for the phone call may include the name of the caller and callback telephone number; location of the actual incident or problem; name of the chemical involved in the incident (if known); shipper or manufacturer of the chemical (if known); container type; railcar or vehicle markings or numbers; shipping carrier's name; recipient of material; local conditions and exact description of the situation. (B) The CHEMTREC emergency phone number is 1-800-424-9300.



Fire Fighter II in Action

- Answers will vary.
- Answers will vary.
- Answers will vary.

Chapter 31: Hazardous Materials: Implementing a Response

Matching

1. E (page 924)
2. A (page 924)
3. D (page 928)
4. B (page 926)
5. C (page 924)

Multiple Choice

1. A (page 930)
2. D (page 926)
3. D (page 925)
4. C (page 928)
5. B (page 925)
6. B (page 928)
7. A (page 925)
8. A (page 926)
9. D (page 928)
10. B (page 930)

Vocabulary

1. **Decontamination team:** The team responsible for reducing and preventing the spread of contaminants from persons and equipment used at a hazardous materials incident. Members of this team establish the decontamination corridor and conduct all phases of decontamination. (page 931)
2. **Hazardous materials safety officer:** A second safety officer dedicated to the safety needs of the Hazardous Materials Branch. (page 930)
3. **Defensive objectives:** Actions that do not involve the actual stopping of the leak or release of a hazardous material, or contact of responders with the material. These actions include preventing further injury and controlling or containing the spread of the hazardous material. (page 926)
4. **Backup entry team:** A dedicated team of fully qualified and equipped responders who are ready to enter the hot zone at a moment's notice to rescue any member of the hot zone entry team. (page 931)
5. **Hot zone entry team:** The team of fire fighters assigned to the entry into the designated hot zone. (page 932)

Fill-in

1. responders (page 930)
2. defensive (page 926)
3. incident commander (page 928)
4. resources (page 924)
5. characteristics (page 925)
6. maximum (page 930)
7. hazardous materials (page 928)
8. offensive (page 924)
9. command; operations; logistics; planning; finance (page 930)
10. Litmus (page 928)

True/False

1. F (page 924)
2. F (page 924)
3. T (page 928)
4. T (page 925)
5. T (page 928)

Short Answer

- The special technical group may include a second safety officer reporting directly to the hazardous materials officer. This hazardous materials safety officer is responsible for the hazardous materials team's safety only. The group may also include a hot zone entry team, a decontamination team, a backup entry team (rapid intervention team), and a hazardous materials information research team. (page 930)
- The three hazardous materials incident levels are: (1) *Level I*: Lowest level of threat. A small amount of hazardous material is involved, and the incident can usually be handled by the local fire department. Fire fighters must wear turnout gear and SCBA. Example: A small gasoline spill occurs as a result of a motor vehicle accident. (2) *Level II*: A hazardous materials team is needed at this level. Fire fighters only support the hazardous materials team. Additional PPE required will be specialized and carried only by the hazardous materials team. Civilian evacuations may be required. Decontamination may need to be performed. Example: A gasoline tanker overturns in a tunnel and spills gasoline onto the highway. (3) *Level III*: The highest level of threat. Large-scale evacuations may be needed. Federal agencies will be called. Example: A ship in a highly populated harbor catches fire and begins to release chlorine vapors from its cargo area. (page 924)
- The three defensive objectives are: (1) Isolate the area affected by the leak or spill, and evacuate victims who could become exposed to the hazardous material if the leak or spill were to progress. (2) Control where the spill or release is spreading. (3) Contain the spill to a specific area. (page 926)
- Pieces of information that could be reported to agencies to assist in their preparation for a response to a hazardous materials incident are: (1) The exact address and specific location of the leak or spill; (2) Identification of indicators and markers of hazardous materials; (3) All color or class information obtained from placards; (4) Four-digit United Nations/North American Hazardous Materials Code numbers for the hazardous materials; (5) Hazardous material identification obtained from shipping papers or MSDSs and the potential quantities of hazardous materials involved; (6) Description of the container, including its size, capacity, type, and shape; (7) The amount of chemical that could leak and the amount that has already leaked; (8) Exposures of people and the presence of special populations (children or elderly); (9) The environment in the immediate area; (10) Current weather conditions, including wind direction and speed; (11) A contact or callback telephone number and two-way radio frequency or channel. (page 925)

Word Fun

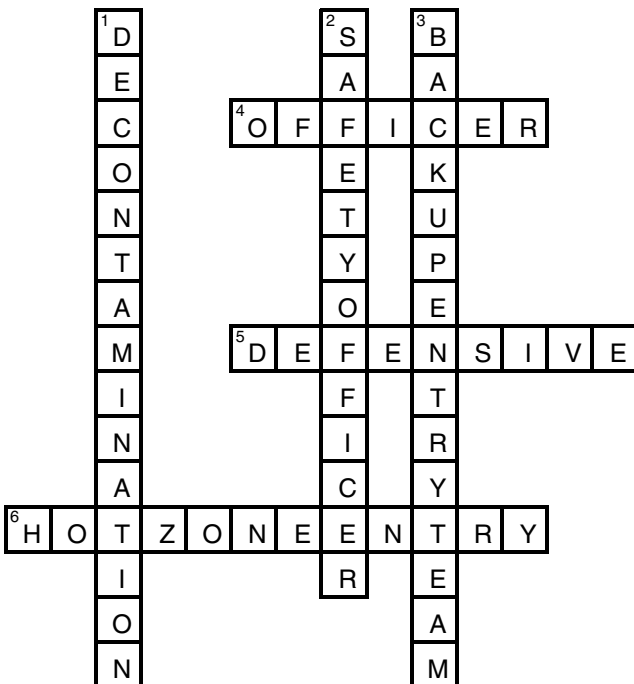

Fire Alarms

1. The ICP must be located upwind and updrift from the spill or leak, in the cold zone, to keep it from becoming contaminated or unsafe. If the ICP, including those personnel housed there, were to become contaminated, the personnel inside the ICP would no longer be able to control the operation. The officers and members in that location would become victims, the ICP would become a part of the hot zone, and all operations would have to be reestablished elsewhere using a completely different pool of personnel, equipment, and supplies. In this scenario, the overall efficiency of command would be negatively affected, and control of the scene would be temporarily lost during the transfer of command.

Based on the potential threat or severity of the hazard, the ICP could be as close as one block from the incident site or as far away as several miles from the hot zone. When choosing a site for the ICP, the maximum margin of safety must be used.



Fire Fighter II in Action

1. *Answers will vary.*
2. *Answers will vary.*

Chapter 32: Hazardous Materials: Personal Protective Equipment, Scene Safety, and Scene Control

Matching

- | | |
|----------------------|------------------|
| 1. B (page 938) | 6. H (page 940) |
| 2. I (page 941) | 7. D (page 954) |
| 3. A (page 955) | 8. E (page 936) |
| 4. J (pages 945–946) | 9. G (page 940) |
| 5. C (page 936) | 10. F (page 954) |

Multiple Choice

- | | |
|-----------------|------------------|
| 1. D (page 953) | 9. B (page 954) |
| 2. D (page 955) | 10. B (page 954) |
| 3. C (page 941) | 11. B (page 938) |
| 4. C (page 954) | 12. D (page 938) |
| 5. C (page 953) | 13. A (page 952) |
| 6. A (page 937) | 14. B (page 940) |
| 7. A (page 954) | 15. A (page 950) |
| 8. A (page 938) | |

Vocabulary

1. **Backup personnel:** Individuals who remove or rescue those working in the hot zone in the event of an emergency. (page 955)
2. **Immediately dangerous to life and health (IDLH):** A designation indicating that an atmospheric concentration of a toxic, corrosive, or asphyxiant substance poses an immediate threat to life or could cause irreversible or delayed adverse health effects. (page 936)
3. **High temperature-protective clothing:** Protective clothing designed to shield the wearer during short-term exposures to high temperatures. (page 938)
4. **Heat stroke:** A severe and sometimes fatal condition resulting from the failure of the temperature-regulating capacity of the body. It is caused by prolonged exposure to the sun or high temperatures. Reduction or cessation of sweating is an early symptom; body temperature of 105°F (40°C) or higher, rapid pulse, hot and dry skin, headache, confusion, unconsciousness, and convulsions may also occur. Heat stroke is a true medical emergency requiring immediate transport to a medical facility. (page 952)
5. **Heat exhaustion:** A mild form of shock caused when the circulatory system begins to fail because the body is unable to dissipate excessive heat. (page 950)

Fill-in

1. Chemical (page 938)
2. Skin absorption (page 950)
3. 8; 16 (page 952)
4. socks (page 953)
5. least (page 937)
6. Liquids (page 938)
7. eyes (page 950)
8. 240 (page 952)
9. single (page 939)
10. Alkaline (page 950)

True/False

1. F (page 955)
2. F (page 955)
3. T (page 937)
4. T (page 954)
5. T (page 955)
6. T (page 954)
7. T (page 937)
8. F (page 939)
9. F (page 955)
10. T (page 955)

Short Answer

1. The three zones at a hazardous materials incident are: (1) *Hot zone:* The area immediately surrounding a hazardous materials spill/incident site that is directly dangerous to life and health. All personnel working in the hot zone must wear complete, appropriate protective clothing and equipment. Entry requires approval by the IC or a designated hazardous materials officer. Complete backup, rescue, and decontamination teams must be in place at the perimeter before operations begin. (2) *Warm zone:* The area located between the hot zone and the cold zone at the incident. Personal protective equipment is required when working in this zone. The decontamination corridor is located in the warm zone, which is also called the contamination reduction zone. (3) *Cold zone:* A safe area at a hazardous materials incident for those agencies involved in the operations. The incident commander, incident command post, EMS providers, and other support functions necessary to control the incident should be located in the cold zone, which is also called the clean zone or support zone. (pages 954–955)
2. The three basic atmospheres at a hazardous materials emergency according to the exposure guidelines are: (1) *Safe atmosphere:* No harmful hazardous materials effects exist, so personnel can handle routine emergencies without donning specialized PPE. (2) *Unsafe atmosphere:* A hazardous material that is no longer contained has created an unsafe condition or atmosphere. A person who is exposed to the material for long enough will probably experience some form of acute or chronic injury. (3) *Dangerous atmosphere:* Serious, irreversible injury or death may occur in the environment. (page 937)

3. The four levels of protective clothing are: (1) *Level A protection*: Personal protective equipment that provides protection against vapors, gases, mists, and even dusts. The highest level of protection, it requires a totally encapsulating suit that includes self-contained breathing apparatus. (2) *Level B protection*: Personal protective equipment that is used when the type and atmospheric concentration of substances have been identified. It generally requires a high level of respiratory protection but less skin protection: chemical-protective coveralls and clothing, chemical protection for shoes, gloves, and self-contained breathing apparatus outside of a nonencapsulating chemical-protective suit. (3) *Level C protection*: Personal protective equipment that is used when the type of airborne substance is known, the concentration is measured, the criteria for using air-purifying respirators are met, and skin and eye exposure is unlikely. It consists of standard work clothing with the addition of chemical-protective clothing, chemically resistant gloves, and a form of respirator protection. (4) *Level D protection*: Personal protective equipment that is used when the atmosphere contains no known hazard, and work functions preclude splashes, immersion, or the potential for unexpected inhalation of or contact with hazardous levels of chemicals. It is primarily a work uniform that includes coveralls and affords minimal protection. (pages 941–949)

Word Fun

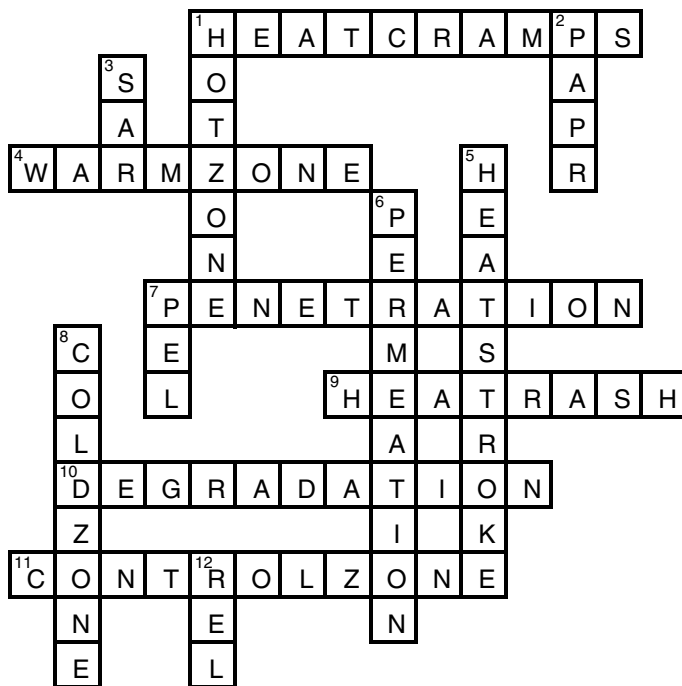

Fire Alarms

- (A) Heat exhaustion is a mild form of shock that occurs when the circulatory system begins to fail because the body is unable to dissipate excessive heat and becomes overheated. (B) Although heat exhaustion is not an immediately life-threatening condition, the affected individual should be removed at once from the source of heat, rehydrated with electrolyte solutions, and kept cool. If not properly treated, heat exhaustion may progress to heat stroke.
- The recommended PPE for Level B protection includes the following components: (1) SCBA or SAR; (2) Chemical-resistant clothing; (3) Inner and outer chemical-resistant gloves; (4) Chemical-resistant safety boots/shoes; (5) Hard hat; (6) Two-way radio. Optional PPE for Level B protection includes the following components: (1) Coveralls; (2) Long cotton underwear; (3) Disposable gloves and boot covers



Fire Fighter II in Action

- Answers will vary.
- Answers will vary.

Skill Drills

Skill Drill 32-1: Donning a Level B Encapsulated Chemical-Protective Clothing Ensemble

(pages 943–944)



© Jones & Bartlett Learning. Photographed by Glen E. Ellman.



© Jones & Bartlett Learning. Photographed by Glen E. Ellman.



© Jones & Bartlett Learning. Photographed by Glen E. Ellman.

1. While seated, pull on the suit to **waist** level; put on the **chemical boots** over the chemical suit. Pull the suit **boot covers** over the tops of the boots.
2. Stand up and don SCBA and the SCBA **face piece**, but do not connect the **regulator** to the face piece.
3. Place the **helmet** on the head, if required.



© Jones & Bartlett Learning. Photographed by Glen E. Ellman.



© Jones & Bartlett Learning. Photographed by Glen E. Ellman.



© Jones & Bartlett Learning. Photographed by Glen E. Ellman.

4. Don the **inner gloves**.
5. With assistance, complete donning the suit. Instruct the assistant to connect the **regulator** to the SCBA **face piece** and ensure **air flow**.
6. Instruct the assistant to close the chemical suit by closing the zipper and sealing the **splash flap**.



© Jones & Bartlett Learning. Photographed by Glen E. Ellman.

7. Review **hand signals** and indicate that you are ready to operate.

Skill Drill 32-2: Doffing a Level B Encapsulated Chemical-Protective Clothing Ensemble (pages 944–945)



© Jones & Bartlett Learning. Photographed by Glen E. Ellman.



© Jones & Bartlett Learning. Photographed by Glen E. Ellman.



© Jones & Bartlett Learning. Photographed by Glen E. Ellman.

1. After completing decontamination, proceed to the **clean** area. Remove the **hands** and **arms** from the suit gloves and sleeves, and cross the arms in front inside the suit.

2. Instruct the assistant to open the chemical **splash flap** and open suit zipper.

3. Instruct the assistant to begin at the head and roll the suit down and away from you until the suit is below **waist** level.



© Jones & Bartlett Learning. Photographed by Glen E. Ellman.



© Jones & Bartlett Learning. Photographed by Glen E. Ellman.



© Jones & Bartlett Learning. Photographed by Glen E. Ellman.

4. Sit and instruct the assistant to complete rolling down the suit and remove the **outer boots** and suit. Rotate on the bench to the direction that will allow you to place feet on a dry, clean area.

5. Stand and doff the SCBA using the **quick-release** method. Keep the **face piece** in place while the SCBA frame is placed on the ground.

6. Take a deep breath, doff the SCBA mask, and walk away from the clean area. Go to the **rehabilitation** area for **medical** monitoring, rehydration, and personal decontamination shower.

Chapter 33: Hazardous Materials: Response Priorities and Actions

Matching

1. C (page 966)
2. F (page 965)
3. B (page 970)
4. D (page 968)
5. E (page 965)
6. G (page 968)
7. H (page 969)
8. A (page 970)
9. I (page 969)
10. J (page 971)

Multiple Choice

1. D (page 966)
2. B (page 962)
3. D (page 970)
4. B (page 972)
5. C (page 972)
6. D (page 963)
7. B (page 972)
8. A (page 965)
9. B (page 970)
10. A (page 963)
11. C (page 965)
12. C (page 963)
13. A (page 969)
14. C (page 966)
15. B (page 962)

Vocabulary

1. **Shelter-in-place:** A method of safeguarding people near or in a hazardous area by keeping them in a safe atmosphere, usually inside structures. (page 963)
2. **Recovery phase:** The stage of a hazardous materials incident after the imminent danger has passed, when clean-up and the return to normalcy have begun. (page 972)
3. **Exposures (hazardous materials):** People, property, structures, or parts of the environment that are subject to influence, damage, or injury as a result of contact with a hazardous material. The amount of exposures that remain is determined both by the location of the incident and by the amount of progress that has been made in protecting those exposures via isolation and other indirect responses. Incidents in urban areas will likely have more exposures and, therefore, will likely need more resources to protect those exposures from the hazardous materials. (page 962)

Fill-in

1. not necessary (page 964)
2. technician (page 965)
3. liquid fires (page 965)
4. Retention (page 969)
5. safe area (page 962)
6. life (page 964)
7. cylinders (page 966)
8. toxicity (page 963)
9. unnecessary (page 962)
10. complete dam (page 968)

True/False

1. T (page 972)
2. T (page 964)
3. F (page 969)
4. F (page 972)
5. T (page 970)
6. T (page 963)
7. T (page 971)
8. F (page 965)
9. T (page 972)
10. F (page 966)

Skill Drills

Skill Drill 33-2: Using Absorption/Adsorption to Manage a Hazardous Materials Incident

(page 968)



© Jones & Bartlett Learning. Photographed by Glen E. Ellman.



© Jones & Bartlett Learning. Photographed by Glen E. Ellman.

1. Decide which **material** is best suited with the spilled product. Assess location of spill and stay clear of **spilled product**.

2. Apply appropriate material to **control** and **contain** the spilled material.



© Jones & Bartlett Learning. Photographed by Glen E. Ellman.

3. Maintain materials and take appropriate steps for their **disposal**.

Chapter 34: Hazardous Materials: Decontamination Techniques

Matching

1. F (page 983)
2. D (page 982)
3. B (page 978)
4. C (page 983)
5. E (page 983)
6. G (page 983)
7. I (page 983)
8. A (page 983)
9. J (page 982)
10. H (page 982)

Multiple Choice

1. D (page 983)
2. A (page 982)
3. A (page 978)
4. C (page 983)
5. B (page 982)
6. B (page 984)
7. D (page 980)
8. C (page 983)
9. A (page 984)
10. B (page 984)

Vocabulary

1. **Adsorption:** The process of adding a material such as sand or activated carbon to a contaminant, which then adheres to the surface of the material and allows for collection of the contaminated material. (page 982)
2. **Decontamination team:** The team responsible for reducing and preventing the spread of contaminants from persons and equipment used at a hazardous materials incident. Members of this team establish the decontamination corridor and conduct all phases of decontamination. (page 980)
3. **Emulsification:** The process of changing the chemical properties of a hazardous material so as to reduce its harmful effects. (page 983)
4. **Contamination:** The process of transferring a hazardous material from its source to people, animals, the environment, or equipment, any of which may act as a carrier. (page 978)
5. **Solidification:** The process of chemically treating a hazardous liquid so as to turn it into a solid material, thereby making the material easier to handle. (page 983)

Fill-in

1. identify (page 979)
2. adsorption (page 982)
3. decontamination corridor (page 978)
4. vapor dispersion (page 983)
5. drains; streams; ponds (page 978)
6. removal (page 983)
7. contaminants (page 979)
8. dilution (page 982)
9. Technical decontamination (page 980)
10. disperse (page 983)

True/False

1. T (page 984)
2. T (page 983)
3. F (page 979)
4. F (page 978)
5. T (page 983)

Short Answer

- The four major categories of decontamination are: (1) Emergency decontamination is used in potentially life-threatening situations to rapidly remove the bulk of the contamination from an individual, regardless of the presence or absence of a technical decontamination corridor. (2) Gross decontamination, like emergency decontamination, aims to significantly reduce the amount of surface contaminant by delivery of a continuous shower of water and removal of outer clothing or PPE. It differs from emergency decontamination, however, in that gross decontamination is controlled through the decontamination corridor. (3) Technical decontamination is performed after gross decontamination and is a more thorough cleaning process. Technical decontamination may involve several stations or steps. During this type of decontamination, multiple personnel (the decontamination team) typically use brushes to scrub and wash the person or object to remove contaminants. (4) Mass decontamination is often used in incidents involving unknown agents or in the case of a contamination of large groups of people. It takes place in the field and is a way of quickly performing gross decontamination on a large number of victims who have escaped from a hazardous materials incident. (pages 978–980)

Word Fun

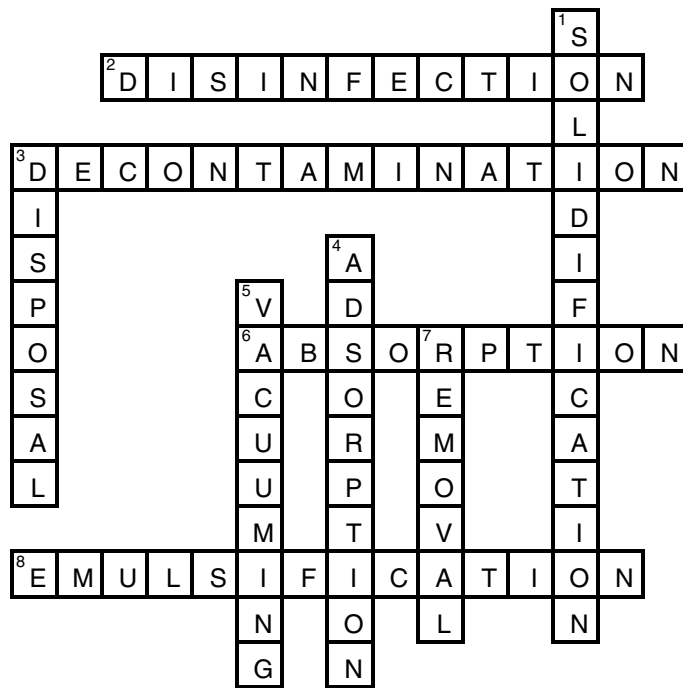

Fire Alarms

- Alternative decontamination procedures include the following techniques: (1) Absorption; (2) Adsorption; (3) Dilution; (4) Disinfection; (5) Disposal; (6) Solidification; (7) Emulsification; (8) Vapor dispersion; (9) Removal; (10) Vacuuming.
- Ensure that you have the appropriate PPE to protect against the chemical threat. Stay clear of the product, and do not make physical contact with it. Make an effort to contain runoff by directing victims out of the hazard zone and into a suitable location for decontamination. Flush the victim to remove the product from the victim's clothing. Instruct and assist the victim in removing contaminated clothing. Flush the contaminated victim. Assist or obtain medical treatment for the victim, and arrange for the victim's transport.



Fire Fighter II in Action

- Answers will vary.

Skill Drills

Skill Drill 34-3: Performing Technical Decontamination

(page 985)



© Jones & Bartlett Learning. Photographed by Glen E. Ellman.

1. Drop any tools and equipment into a tool drum or onto a designated tarp.



© Jones & Bartlett Learning. Photographed by Glen E. Ellman.

2. Perform gross decontamination.



© Jones & Bartlett Learning. Photographed by Glen E. Ellman.

3. Wash and rinse the entry team member.



© Jones & Bartlett Learning. Photographed by Glen E. Ellman.

4. Remove outer hazardous materials—protective clothing and isolate PPE.



© Jones & Bartlett Learning. Photographed by Glen E. Ellman.

5. Remove SCBA and the face piece.



© Jones & Bartlett Learning. Photographed by Glen E. Ellman.

6. Remove personal clothing. Bag and tag all personal clothing.



© Jones & Bartlett Learning. Photographed by Glen E. Ellman.

7. Shower and wash the body. Dry off the body and put on clean clothing. The entry team member should proceed to medical monitoring. At the station, the entry members should fill out any record-keeping information about the incident to include exposure reporting.

Chapter 35: Terrorism Awareness

Matching

- | | |
|------------------|-------------------|
| 1. C (page 993) | 9. K (page 998) |
| 2. B (page 1002) | 10. G (page 996) |
| 3. E (page 1004) | 11. D (page 1000) |
| 4. F (page 997) | 12. M (page 1001) |
| 5. I (page 1008) | 13. L (page 1000) |
| 6. J (page 1001) | 14. O (page 1000) |
| 7. H (page 1001) | 15. A (page 1004) |
| 8. N (page 1002) | |

Multiple Choice

- | | |
|------------------|-------------------|
| 1. C (page 1004) | 9. A (page 994) |
| 2. D (page 993) | 10. C (page 994) |
| 3. C (page 1008) | 11. D (page 998) |
| 4. A (page 1006) | 12. B (page 1004) |
| 5. B (page 994) | 13. C (page 998) |
| 6. C (page 1005) | 14. D (page 994) |
| 7. A (page 996) | 15. B (page 998) |
| 8. D (page 1006) | |

Vocabulary

- Smallpox:** A highly infectious and often fatal disease caused by the virus *Variola*; it kills approximately 30 percent of those infected. (page 1003)
- Radiation dispersal device:** Any device that causes the purposeful dissemination of radioactive material without a nuclear detonation; a dirty bomb. (page 1005)
- Forward staging area:** A strategically placed area, close to the incident site, where personnel and equipment can be held in readiness for rapid response to an emergency event. (page 998)
- V-agent:** The most stable nerve agent, principally a contact hazard; an oily liquid that can persist for several weeks. (page 1001)
- Plague:** An infectious disease caused by the bacterium *Yersinia pestis*, which is commonly found on rodents. (page 1003)
- Universal precautions:** Protective measures for use in dealing with objects, blood, body fluids, or other items associated with potential exposure risks of communicable diseases. (page 1004)
- Tabun:** A nerve gas that is both a contact hazard and a vapor hazard. It disables the chemical connection between the nerves and their target organs. (page 1001)

Fill-in

- | | |
|--------------------------------------|----------------------------------|
| 1. mass decontamination (page 1007) | 6. incubation period (page 1004) |
| 2. defined perimeter (page 1008) | 7. air flow (page 1000) |
| 3. Radioactive materials (page 1004) | 8. Terrorism (page 992) |
| 4. absorption (page 1007) | 9. SLUDGEM (page 1001) |
| 5. pipe bomb (page 997) | 10. Nerve agents (page 1000) |

True/False

1. T (page 1006)
2. F (pages 1002–1003)
3. F (page 1006)
4. T (page 1004)
5. T (page 1006)
6. F (page 1004)
7. T (page 1005)
8. F (page 1004)
9. F (page 994)
10. F (page 1001)

Short Answer

1. Responding to a terrorist incident puts fire fighters and other emergency personnel at increased risk. Although responders must ensure their own safety at every incident, a terrorist incident may carry an extra dimension of risk. Because the terrorist's objective is to cause as much harm as possible, emergency responders are just as likely to be targets as are ordinary civilians. In most cases, the first emergency units will not be dispatched for a known WMD or terrorist incident. Rather, the initial dispatch might be for an explosion, for a possible hazardous materials incident, for a single person with difficulty breathing, or for multiple victims with similar symptoms. Emergency responders will usually not know that a terrorist incident has occurred until personnel on the scene begin to piece together information gained from their own observations and from witnesses. (page 1005)
2. The three types of radiation are alpha, beta, and gamma. To limit exposure to each, keep the time of exposure as short as possible, stay as far away from the source of the radiation as possible, and use shielding to limit the amount of radiation absorbed by the body. (page 1004)
3. (1) Ecoterrorism refers to illegal acts committed by groups supporting environmental or related causes. Examples include spiking trees to sabotage logging operations, vandalizing a university research laboratory that is conducting experiments on animals, or firebombing a store that sells fur coats. (2) Cyberterrorism refers to electronically attacking government or private computer systems. This type of terrorism would disrupt many day-to-day activities in our society, because the use of computers is woven into most things we do as part of contemporary life. (3) Agroterrorism includes the use of chemical or biological agents to attack the agricultural industry or the food supply. The deliberate introduction of an animal disease such as foot-and-mouth disease to the livestock population could result in major losses to the food industry and produce fear among members of the general population. (page 994)
4. The issues that fire fighters must consider following a large explosion are as follow: The first priority should be to ensure the safety of the scene. During the initial stages of an incident, you will not know whether the event was caused by an intentional act or by accidental circumstances. In any incident involving an explosion, follow departmental procedures to ensure the safety of rescuers, victims, and bystanders. Consider the possibility that a secondary device may be in the vicinity. Quickly survey the area for any suspicious bags, packages, or other items. It is also possible that chemical, biological, or radiological agents may be involved in a terrorist bombing. Qualified personnel with monitoring instruments should be assigned to check the area for potential contaminants. The initial size-up should also include an assessment of hazards and dangerous situations. The stability of any building involved in the explosion must be evaluated before anyone is permitted to enter it, because entering an unstable area without proper training and equipment may complicate rescue and recovery efforts. (page 998)
5. Terrorists are motivated by a cause and choose targets they believe will help them achieve their goals and objectives. Terrorist incidents aim to instill fear and panic among the general population and to disrupt daily ways of life. Given this goal, terrorists tend to choose symbolic targets, such as places of worship, embassies, monuments, or prominent government buildings. Sometimes the objective is sabotage—that is, to destroy or disable a facility that is significant to the terrorist cause. The ultimate goal could be to cause economic turmoil by interfering with transportation, trade, or commerce. (page 993)

Word Fun

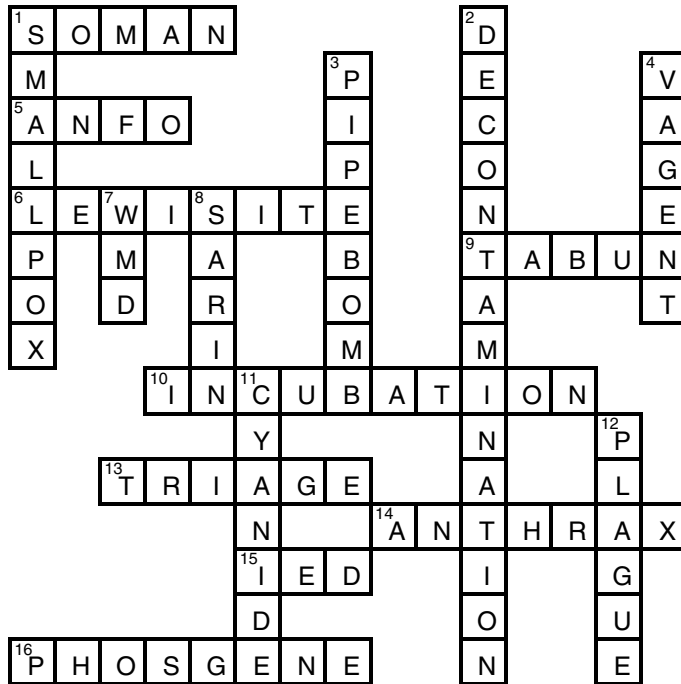

Fire Alarms

1. Unless the cause of an explosion is known to be accidental, fire fighters at the scene should always consider the possibility that an explosive device was detonated. The first priority should be to ensure the safety of the scene. Fire fighters should also consider the possibility that a secondary device may be in the vicinity. Responders should quickly survey the area for any suspicious bags, packages, or other items. It is also possible that chemical, biologic, or radiological agents may be involved in a terrorist bombing. Qualified personnel with monitoring instruments should be assigned to check the area for potential contaminants. These precautions should be implemented immediately. The initial size-up should also include an assessment of hazards and dangerous situations. The stability of any building involved in the explosion must be evaluated before anyone is permitted to enter. Entering an unstable area without the proper training and equipment may complicate rescue and recovery efforts.
2. The fire service role includes emergency medical services (EMS), hazardous materials mitigation, and technical rescue as well as fire suppression. All of these functions will probably be needed when a terrorist incident occurs. Terrorism presents challenges to the fire service on a scale that has never previously been experienced in North America; it also presents an unparalleled threat to the lives of fire fighters and emergency responders. The terrorist threat requires fire fighters to work closely with local, state, and federal law enforcement agencies; emergency management agencies; allied health agencies; and the military. It is critical that all of these agencies work together in a coordinated and cooperative manner. All emergency responders and law enforcement agencies must be prepared to face a wide range of situations.



Fire Fighter II in Action

1. Answers will vary.
2. Answers will vary.

Chapter 36: Fire Prevention and Public Education

Matching

1. C (page 1015)
2. B (page 1018)
3. D (page 1016)
4. A (page 1014)
5. E (page 1014)

Multiple Choice

1. C (page 1015)
2. A (page 1024)
3. A (page 1014)
4. B (page 1024)
5. B (page 1014)
6. D (page 1014)
7. C (page 1023)
8. A (page 1015)
9. D (page 1022)
10. B (page 1021)

Vocabulary

1. **Fire prevention:** Activities conducted with the aim of preventing fires and protecting lives and property in the event of a fire. These activities include the enactment and enforcement of fire codes, the inspection of properties, the presentation of fire safety education programs, and the investigation of the causes of fires. (page 1014)
2. **Fire code:** A set of legally adopted rules and regulations designed to prevent fires and protect lives and property in the event of a fire. (page 1014)

Fill-in

1. bare hand (page 1018)
2. prevent (page 1014)
3. bedrooms (page 1024)
4. systematic (page 1023)
5. legal (page 1015)
6. interior (page 1015)
7. buildings (page 1015)
8. home fire (page 1015)
9. building (page 1015)
10. smoke alarms (page 1018)

True/False

1. T (page 1024)
2. F (page 1024)
3. T (page 1023)
4. T (page 1022)
5. T (page 1015)
6. T (page 1014)
7. F (page 1018)
8. F (page 1022)
9. T (page 1018)
10. T (page 1025)

Short Answer

1. Recommendations for kitchen safety include (*Students should include five of the following*): (1) Do not leave anything cooking unattended on a stove. (2) Keep all flammable materials, cleaning supplies, cooking oils, and aerosols away from the stove. (3) Do not place anything that could ignite on a cooking surface, even when it is turned off and cold. (4) Do not place towel racks near the stove. (5) Store smoking materials out of the reach of children. (6) Do not overload electrical outlets or extension cords. (7) Keep electric cords properly maintained; replace any frayed cords. (8) Be sure that the fire extinguisher is visible and properly charged. (page 1024)
2. Important smoke alarm tips include (*Students should include five of the following*): (1) Smoke alarms should be installed on every floor and in or near every sleeping room of the home. (2) Smoke alarms should be mounted on the ceiling,

at least 4 inches (10 cm) from a wall, or high on the wall, 4 to 12 inches (10 to 30 cm) below the ceiling. (3) Smoke alarms should not be located near windows, exterior doors, or duct vents that could interfere with their operation. (4) Only qualified electricians should install or replace AC-powered smoke alarms. (5) Smoke alarms should be tested at least once a month by using the test button on the device. (6) Smoke alarms should be dusted and vacuumed regularly. (7) Alkaline batteries in smoke alarms should be replaced twice each year, or as soon as the intermittent “chirp” warning that the battery is low sounds. Remind homeowners to “change the battery when you change your clock.” If the smoke alarm is equipped with lithium batteries, the smoke alarm batteries need to be replaced only once every 10 years. (page 1023)

3. Examples of public fire safety education programs include (*Students should include six of the following*): (1) Stop, Drop, and Roll; (2) Exit Drills in the Home (EDITH); (3) Installation and maintenance of smoke alarms; (4) Learn Not to Burn; (5) Change Your Clock—Change Your Battery; (6) Fire safety for babysitters; (7) Fire safety for seniors; (8) Fire safety for college students; (9) Wildland fire prevention programs. (page 1015)

4. **A.** Stop, Drop, and Roll: **Stop** means just that: Stay in place; do not run. Stress the fact that running will fan the flames and spread the fire. **Drop** means getting down on the ground or on the floor. The person should cover his or her face with the hands to help protect the airway and the eyes. **Roll** means the person should tuck in his or her elbows and keep his or her legs together and roll like a bug. He or she should then roll over and over, and then roll back in the other direction. This helps to smother the flames. (page 1016)

B. Exit Drills in the Home: Many fire deaths could be prevented if everyone learned a few simple rules about what to do in the event of a fire in the home. As part of this exercise, residents need to understand the importance of having properly installed and properly working smoke alarms. Working smoke alarms alert residents to a fire and give them more time to escape from a burning building.

As part of your EDITH presentation, stress the importance of keeping bedroom doors closed during sleeping hours, as this step prevents smoke and heat from reaching bedrooms. Emphasize the need to have two escape routes from each bedroom. If smoke, heat, or flames are present in the primary escape route, occupants should use the secondary escape route. The secondary escape route may be through a window or through a different door. Stress the importance of alerting other occupants to the presence of a fire.

When alerted to the presence of a fire, all occupants should roll out of bed, stay low, and crawl toward the designated exit. By staying low, individuals decrease the amount of smoke and gases they inhale.

Before opening any door, occupants should touch the closed door to see if it is hot. Teach them to use the back of a bare hand to sense the temperature of the door. If the door is hot, they should not open it; instead, they should use a window or another door for escape.

Once outside the house, all occupants should gather at a preestablished meeting spot. They should not go back into the house. Also, they should make sure the fire department has been called. If any doubt arises about whether the fire department has been called, a neighbor’s phone or a cell phone should be used to call the fire department again. (page 1018)

C. Importance of smoke alarms: Studies show that the presence of working smoke alarms on each level of a house reduces the risk of death from fire by 50 percent. (page 1023)

Word Fun

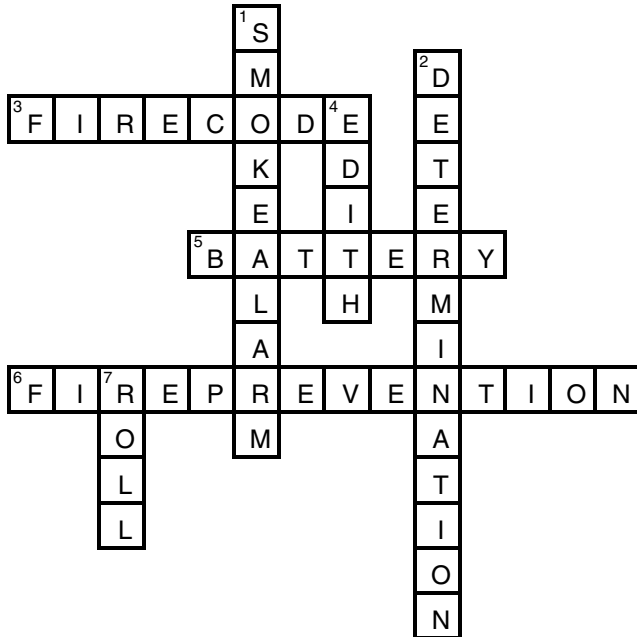

Fire Alarms

1. Tell the home occupant that storage of gasoline and other flammable substances is a major concern, because an open flame or pilot light can easily ignite leaking vapors. Gasoline and other flammable liquids should be stored only in approved containers and in outside storage areas or outbuildings. Small quantities of flammable and combustible liquids (such as paint, thinners, varnishes, and cleaning fluids) should be stored in closed metal containers away from heat sources.
2. Teenagers are ready for lessons that they can apply to everyday life. Many teenagers work as babysitters, so prevention messages might be geared toward cooking safety and evacuating children in the event of a fire. Teenagers are also a high-risk group for motor vehicle collisions, so it is appropriate to teach them about safe driving practices, the dangers of drinking and driving, and what to do if they see or hear an emergency vehicle while driving. Some teenagers might be interested in becoming fire fighters or joining a fire fighter explorer group. This age group can be a good source of recruits for both career and volunteer departments.

Fire Fighter II in Action

1. Answers will vary.
2. Answers will vary.
3. Answers will vary.

Skill Drills

Skill Drill 36-3: Installing and Maintaining Smoke Alarms

(page 1021)



© Jones & Bartlett Learning. Photographed by Glen E. Ellman.

1. Ensure that smoke alarms are mounted on the **ceiling** or as **high** as possible on walls.



© Jones & Bartlett Learning. Photographed by Glen E. Ellman.

2. Test smoke alarms **once** a month using the **test button**.



© Jones & Bartlett Learning. Photographed by Glen E. Ellman.

3. Change **alkaline** batteries in the smoke detector every **six months** if not a 10 year battery.



© Jones & Bartlett Learning. Photographed by Glen E. Ellman.

4. **Clean** alarms regularly to prevent false alarms.

Skill Drill 36-4: Conducting a Home Safety Survey

(page 1026)



© Jones & Bartlett Learning. Photographed by Glen E. Ellman.

1. Look outside the house for accumulated trash, overgrown shrubs, and blocked exits.



© Jones & Bartlett Learning. Photographed by Glen E. Ellman.

2. Check inside the house for properly working smoke alarms, fire extinguishers, and fire sprinkler systems. Explain how improper cooking procedures can start kitchen fires. Stress the safe storage of cooking oils and flammable objects away from the stove. Explain the safe use of fireplaces, heating stoves, and portable heaters.



© Jones & Bartlett Learning. Photographed by Glen E. Ellman.

3. Review the results of the fire safety survey with the building occupants.



© Jones & Bartlett Learning. Photographed by Glen E. Ellman.

4. Leave fire and life safety brochures with the building occupants.

Chapter 37: Fire Detection, Protection and Suppression Systems

Matching

1. H (page 1044)
2. G (page 1034)
3. D (page 1049)
4. F (page 1051)
5. A (page 1056)
6. B (page 1050)
7. I (page 1042)
8. E (page 1057)
9. M (page 1043)
10. C (page 1056)
11. L (page 1041)
12. J (page 1052)
13. K (page 1044)
14. N (page 1049)

Multiple Choice

1. B (page 1063)
2. D (page 1048)
3. B (page 1060)
4. C (page 1036)
5. D (page 1054)
6. C (page 1059)
7. C (page 1034)
8. C (page 1052)
9. A (page 1058)
10. A (page 1036)
11. D (page 1042)
12. B (page 1047)
13. A (page 1048)
14. B (page 1038)
15. B (page 1044)
16. A (page 1040)
17. C (page 1044)
18. A (page 1042)
19. D (page 1041)
20. C (page 1035)

Vocabulary

1. **Zoned-system:** A fire alarm system design that divides a building or facility into zones so that the area where an alarm originated can be identified. (page 1045)
2. **Deluge sprinkler system:** A sprinkler system in which all sprinkler heads are open. When an initiation device, such as a smoke detector or heat detector, is activated, the deluge valve opens and water discharges from all of the open sprinkler heads simultaneously. (page 1057)
3. **Verification system:** A fire alarm system that does not immediately initiate an alarm condition when a smoke detector is activated. The system will wait for a preset interval, generally 30 to 60 seconds, before checking the detector again. If the condition is clear, the system returns to normal status. If the detector is still sensing smoke, the system activates the fire alarm. (page 1044)
4. **Outside stem and yoke valve:** A sprinkler control valve with a valve stem that moves in and out as the valve is opened or closed. (page 1051)
5. **Post indicator valve:** A sprinkler control valve with an indicator that reads either open or shut depending on its position. (page 1051)
6. **Fire department connection:** A fire hose connection through which the fire department can pump water into a sprinkler system or standpipe system. (page 1054)

Fill-in

1. unwanted (page 1043)
2. I (page 1059)
3. beam (page 1040)
4. piping (page 1050)
5. remote station (page 1045)
6. Sidewall (page 1050)
7. brain (page 1035)
8. Rate of rise (page 1041)
9. faults (page 1035)
10. Photoelectric (page 1036)

 **True/False**

1. F (page 1036)
2. T (page 1036)
3. T (page 1055)
4. T (page 1044)
5. T (page 1047)
6. F (page 1037)
7. F (page 1047)
8. T (page 1041)
9. F (page 1041)
10. F (page 1043)

 **Short Answer**

1. The five fire department notification systems are: (1) Local alarm; (2) Remote station; (3) Auxiliary system; (4) Proprietary system; (5) Central station. (pages 1045–1047)
2. The three fire suppression systems are: (1) Automatic sprinkler systems; (2) Standpipe systems; (3) Specialized extinguishing agents. (page 1047)
3. The four categories of sprinkler systems are: (1) *Wet sprinkler system*: The piping in a wet system is always filled with water. When activated, water is immediately discharged; (2) *Dry sprinkler system*: The pipes are filled with pressurized air, which keeps water out until the air pressure is released. The system utilizes accelerators and exhausters; (3) *Preaction sprinkler system*: This system is similar to a dry sprinkler system except that a secondary device (pull alarm, smoke detector) must be activated before the water is released; (4) *Deluge sprinkler system*: In this type of dry sprinkler system, all of the sprinkler heads are activated as soon as the system is activated. The sprinkler heads are always open. (pages 1056–1057)
4. The three categories of standpipes are: (1) A Class I standpipe is designed for use by fire department personnel only. Each outlet has a 2½-inch (64-mm) male coupling and a valve to open the water supply after the attack line is connected. Often the connection is located inside a cabinet, which may or may not be locked. Responding fire personnel carry the hose into the building with them, usually in some sort of roll, bag, or backpack. A Class I standpipe system must be able to supply an adequate volume of water with sufficient pressure to operate fire department attack lines. (2) A Class II standpipe is designed for use by the building occupants. The outlets are generally equipped with a length of 1½-inch (38-mm) single-jacket hose preconnected to the system. These systems are intended to enable occupants to attack a fire before the fire department arrives, but their safety and effectiveness are questionable. (3) A Class III standpipe has the features of both Class I and Class II standpipes in a single system. This kind of system has 2½-inch (64-mm) outlets for fire department use as well as smaller outlets with attached hoses for occupant use. (pages 1059–1060)
5. A fire alarm system has three basic components: an alarm initiation device, an alarm notification device, and a control panel. The alarm initiation device is either an automatic or a manually operated device that, when activated, causes the system to indicate an alarm. The alarm notification device is generally an audible device, often accompanied by a visual device that alerts the building occupants when the system is activated. The control panel links the initiation device to the notification device and performs other essential functions. (page 1034)
6. Four types of sprinkler heads are: (1) Frangible bulb; (2) Chemical pellet; (3) Fusible link; (4) Deluge. (pages 1048–1049)
7. The different styles of indicator valves include the outside stem and yoke (OS&Y) valve, the post indicator valve (PIV), and the wall post indicator valve (WPIV). (pages 1051–1052)

Word Fun

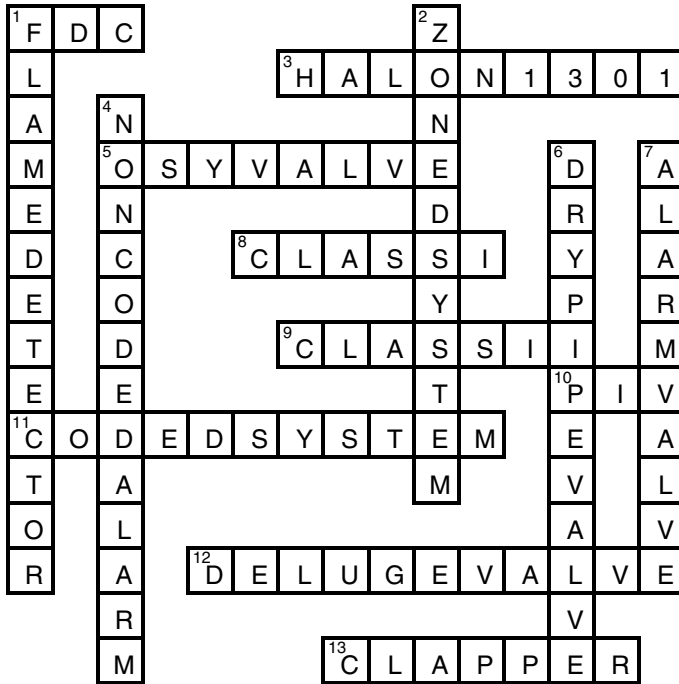

Fire Alarms

1. Carbon dioxide extinguishes a fire by displacing the oxygen and creates a dangerous situation. Responding personnel should wear SCBA at all times when entering the server room.
2. From a safety standpoint, fire fighters need to understand the operations and limitations of fire detection and suppression systems. A building with a fire protection system will have very different working conditions during a fire than an unprotected building will. Fire fighters need to know how to fight a fire in a building with a working fire suppression system, and how to shut down the system after the fire is extinguished. From a customer service standpoint, fire fighters who understand how fire protection systems work can help dispel misconceptions about these systems and advise building owners and occupants after an alarm is sounded.

Fire Fighter II in Action



1. Answers will vary.
2. Answers will vary.
3. Answers will vary.

Chapter 38: Fire Cause Determination

Matching

- | | |
|--|---|
| 1. F (page 1075) |  6. H (page 1084) |
| 2. B (page 1073) |  7. I (page 1076) |
| 3. G (page 1077) |  8. J (page 1076) |
|  4. A (page 1084) |  9. C (page 1076) |
|  5. D (page 1084) |  10. E (page 1076) |

Multiple Choice

- | | |
|-------------------|--|
| 1. A (page 1074) | 11. C (page 1074) |
| 2. B (page 1080) |  12. D (page 1073) |
| 3. C (page 1082) |  13. D (page 1084) |
| 4. A (page 1075) |  14. D (page 1075) |
| 5. D (page 1082) |  15. A (page 1085) |
| 6. D (page 1073) |  16. B (page 1085) |
| 7. B (page 1081) |  17. C (page 1085) |
| 8. B (page 1072) |  18. A (page 1084) |
| 9. B (page 1075) |  19. C (page 1076) |
| 10. A (page 1077) |  20. C (page 1085) |

Vocabulary

- Competent ignition source:** An ignition source that can ignite a fuel under the existing conditions at the time of the fire. It must have sufficient heat and be in close enough proximity to the fuel for a sufficient amount of time to ignite the fuel. (page 1073)
- Chain of custody:** A legal term used to describe the paperwork or documentation describing the movement, storage, and custody of evidence, such as the record of possession of a gas can from a fire scene. (page 1077)
- Trailers:** Combustible materials (such as rolled rags, blankets, and newspapers or ignitable liquid) that are used to spread fire from one point or area to other points or areas, often used in conjunction with an incendiary device. (page 1082)
- Depth of char:** The thickness of the layer of a material that has been consumed by a fire. The depth of char on wood can be used to help determine the intensity of a fire at a specific location. (page 1075)

Fill-in

- | | |
|-----------------------------|---|
| 1. obstacles (page 1082) | 7. fuel supply (page 1073) |
| 2. Clothing (page 1083) | 8. cause (page 1078) |
| 3. location (page 1081) | 9. exterior (page 1074) |
| 4. burn (page 1075) |  10. demonstrative (page 1076) |
| 5. contaminated (page 1077) |  11. validity (page 1073) |
| 6. observes (page 1080) |  12. lessons (page 1084) |

True/False

- | | |
|------------------|-------------------|
| 1. T (page 1080) | 7. T (page 1081) |
| 2. T (page 1073) | 8. T (page 1073) |
| 3. F (page 1077) | 9. T (page 1077) |
| 4. F (page 1074) | 10. T (page 1078) |
| 5. F (page 1081) | 11. T (page 1080) |
| 6. F (page 1075) | 12. F (page 1076) |

Short Answer

- Characteristics of fires set by pyromaniacs include: (1) Fires are set in easily accessible locations, such as immediately inside entrances, on basement stairs, in trash bins, or on porches. (2) Fires are set in structures such as occupied residences of all types, barns, and vacant buildings. (3) Accelerants are rarely used. The pyromaniac is impulsive, so materials readily at hand are used. (4) Each pyromaniac follows a unique pattern—for example, setting fires at the same time of day or night, using the same method, and setting fires in similar locations. (page 1084)
- The six common arson motives listed in NFPA 921, *Guide to Fire and Explosion Investigations* are: (1) Vandalism; (2) Excitement; (3) Revenge; (4) Crime concealment; (5) Profit; (6) Extremism. (page 1085)
- If a fire investigator is not available and the premises must be maintained under the control of the fire department until the investigation can take place, take the following steps: (1) Suspend salvage and overhaul, and secure the scene. Keep nonessential personnel out of the area. Deny entry to all unauthorized and unnecessary persons. (2) Photograph the fire scene extensively. Start with the area with the least amount of damage, and work your way toward the area of possible origin. Take several pictures of the point of origin from various angles. Photograph any incendiary devices on the premises in the exact location where they were found. (3) If weather, traffic, or other factors could destroy evidence, take steps to preserve the evidence in the best way possible. Protect tire tracks or footprints by placing boxes over them to prevent dust accumulation. Use barricades to block off the area to further traffic. Rope off areas surrounding plants, trailers, and devices, and post a guard at the site. (4) To secure the property, cordon off the area with fire- or police-line tape. A member of the fire department or law enforcement agency should remain at the scene to ensure that no unauthorized persons cross the line. As previously mentioned, the fire department has the authority to deny access to a building for as long as necessary to conduct a thorough investigation and ensure the safety of the public. (5) Before leaving the scene, make sure the building is properly secured and no hazards to public safety exist. Shut off all utilities and seal any openings in the roof to prevent additional water damage. Board up and secure windows and doors to prevent unauthorized entry. (6) Fire departments can secure and protect the premises in several ways. Lock and guard gates if necessary. Rope off dangerous areas and mark them with signs. Most fire departments have contracts with local companies that provide 24-hour board-up services, and they sometimes hire private security guards to secure a property after a fire. (page 1083)
- Because state fire investigators cannot always reach the fire scene quickly, the local fire department must be prepared to conduct a thorough preliminary investigation and to protect the scene and preserve evidence.

Insurance companies often investigate fires to determine the validity of a claim for damages or to identify factors that might help prevent future fires. The cost of an investigation is more than offset by the savings the company would keep by identifying a fraudulent claim. Some insurance companies employ their own fire investigators, whereas others retain the services of independent fire investigators. These outside fire investigators often have valuable experience and can provide critical technical support to determine the cause of a fire. (page 1073)

- According to NFPA 921, a scientific method and a systematic analysis are needed to determine the origin and cause of a fire. As part of his or her responsibilities, the investigator must determine where the fire started and how it was ignited. He or she must look at the situation objectively to be sure the evidence is convincing and fully explains the situation. If more than one explanation for the observations exists, each possibility must be considered. The cause cannot be determined with absolute certainty until all alternative explanations have been ruled out. (page 1074)
- Systematically digging out through the debris often can uncover the exact point of origin and point to the cause of both accidental and deliberate fires. If circumstances or eyewitness accounts indicate that a deliberate fire is a possibility, the fire investigator may request that fire fighters help examine the entire area. Common search methods include the “grid” search (also known as the “double strip” search) and the “strip” search. The investigator will explain generally what to look for, how to search, and what to do with any potential evidence.



Fire Alarms

1. After the investigator identifies the area of origin, fire fighters could be asked to assist in digging out the fire scene. “Digging out” is a term used to describe the process of carefully looking for evidence within the debris. Sometimes the entire fire scene must be closely examined to determine the cause of the fire and gather evidence. Removing and inspecting the layers of debris enable the investigator to determine in what order items burned, whether an item burned from the top down or from the bottom up, and how long it burned. Systematically digging through the debris often can uncover the exact point of origin and cause of both accidental and deliberate fires. Common search methods include the “grid” search (also known as the “double strip” search) and the “strip” search. The investigator will explain generally what to look for, how to search, and what to do with any potential evidence.
2. Take photographs of each piece of evidence as it is found and collected. If possible, photograph the item as it was found, before it is moved or disturbed. On the fire scene, sketch, mark, and label the location of the evidence.

Place evidence in appropriate containers to ensure its safety and prevent contamination. Unused paint cans with lids that seal automatically when closed are the best containers for transporting evidence. Glass mason jars sealed with a sturdy sealing tape are appropriate for transporting smaller quantities of materials. Soak up small quantities of liquids with either a cellulose sponge or cotton batting. Protect partially burned paper and ash by placing them between layers of glass.

Tag all evidence at the fire scene. Evidence being transported to the laboratory should include a label with the date, time, location, discoverer’s name, and witnesses’ names. Record the time the evidence was found, the location where it was found, and the name of the person who found it. Keep a record of each person who handled the evidence.

Keep a constant watch on the evidence until it can be stored in a secure location. Evidence that must be moved temporarily should be put in a secure place accessible only to authorized personnel. Preserve the chain of custody in handling all the evidence. A broken chain of custody may result in a court ruling that the evidence is inadmissible.



Fire Fighter II in Action

1. *Answers will vary.*
2. *Answers will vary.*