

The AME2016 atomic mass evaluation (II). Tables, graphs and references

This content has been downloaded from IOPscience. Please scroll down to see the full text.

2017 Chinese Phys. C 41 030003

(<http://iopscience.iop.org/1674-1137/41/3/030003>)

View [the table of contents for this issue](#), or go to the [journal homepage](#) for more

Download details:

IP Address: 128.219.49.14

This content was downloaded on 17/05/2017 at 14:30

Please note that [terms and conditions apply](#).

You may also be interested in:

[\(II\). Tables, graphs and references](#)

M. Wang, G. Audi, A.H. Wapstra et al.

[Analyzing direct dark matter detection data with unrejected background events by the AMIDAS website](#)
Chung-Lin Shan

The AME2016 atomic mass evaluation ^{*}

(II). Tables, graphs and references

Meng Wang (王猛)^{1,2;1)} G. Audi (欧乔治)³ F.G. Kondev⁴ W.J. Huang(黄文嘉)³ S. Naimi⁵ Xing Xu(徐星)¹

¹ Institute of Modern Physics, Chinese Academy of Sciences, Lanzhou 730000, People's Republic of China

² Joint Department for Nuclear Physics, Institute of Modern Physics, CAS and Lanzhou University, Lanzhou 730000, China

³ CSNSM, Univ Paris-Sud, CNRS/IN2P3, Université Paris-Saclay, 91405 Orsay, France

⁴ Argonne National Laboratory, Argonne, IL 60439, USA

⁵ RIKEN Nishina Center, Wako, Saitama 351-0198, Japan

Abstract This paper is the second part of the new evaluation of atomic masses, AME2016. Using least-squares adjustments to all evaluated and accepted experimental data, described in Part I, we derive tables with numerical values and graphs to replace those given in AME2012. The first table lists the recommended atomic mass values and their uncertainties. It is followed by a table of the influences of data on primary nuclides, a table of various reaction and decay energies, and finally, a series of graphs of separation and decay energies. The last section of this paper lists all references of the input data used in the AME2016 and the NUBASE2016 evaluations (first paper in this issue).

AMDC: <http://amdc.impcas.ac.cn/>

Keywords: atomic mass evaluation, atomic mass table, separation and reaction energies, trends from the mass surface

PACS: 21.10.Dr, 21.10.-k **DOI:** 10.1088/1674-1137/41/3/030003

1 Introduction

The description of the AME2016 general procedures and policies are given in Part I of this series of two papers, where the input data used in the evaluation are presented. In this paper, we present tables with numerical values and graphs derived from the evaluation of the input data presented in Part I.

Firstly, we present the table of atomic masses (Table I) expressed as mass excess in keV, together with the binding energy per nucleon, the beta-decay energy and the total atomic mass in mass units.

Secondly, we provide the table of influences for primary nuclides (Table II). For each primary nuclide, we give three main data and their influences on its mass (see the definitions in Part I, Section 5.1, p. 030002-18).

Thirdly, we give a table of values and their uncertainties for the separation and reaction energies for twelve selected combinations of nuclides. This selection, together with the β -decay energies in Table I, provides all differences in masses between any pair of nuclides differing at most by two units in Z and N . A method is indicated in which many more different reaction energy values can

be derived from the present table.

The following series of graphs are then presented: two-neutron separation energies and α -decay energies as a function of neutron number, and two-proton separation energies as a function of proton number. These graphs are considered to be the most illustrative ones for representing the regular trends from the mass surface (TMS) and deriving estimates for unknown masses.

Finally, references of the input data used in the AME2016 and the NUBASE2016 evaluations, the first paper of this issue, are given in Section 6.

2 Atomic mass table

The tables containing the values of atomic masses and other derived quantities given in the present work are similar to those published in the earlier AME editions [1–9]. With few exceptions, experimental data on masses of nuclides refer to “atomic” masses or to masses of singly ionized atoms. In the last case, the ionization energy is generally (much) smaller than the uncertainty of the mass and, for a small number of very precise mass measurements, corrections for the first- and second-

Received 10 March 2017

* This work has been undertaken with the endorsement of the IUPAP Commission on Symbols, Units, Nomenclature, Atomic Masses and Fundamental Constants (SUNAMCO).

1) E-mail: wangm@impcas.ac.cn

©2017 Chinese Physical Society and the Institute of High Energy Physics of the Chinese Academy of Sciences and the Institute of Modern Physics of the Chinese Academy of Sciences and IOP Publishing Ltd

ionization potentials can be applied without much loss of accuracy. The same is true for the electron mass, M_e ; see Table A in Part I. This is the reason for the decision to present atomic rather than nuclear masses in our evaluations.

In general, the nuclear masses M_N can be calculated from the atomic ones M_A :

$$M_N(A, Z) = M_A(A, Z) - Z \times M_e + B_e(Z). \quad (1)$$

Nowadays, several mass measurements are conducted with fully or almost fully ionized atoms. In such cases, a correction must be made for the total binding energy of all the removed electrons $B_e(Z)$, which can be found in the table of calculated total atomic binding energy of all electrons by Huang *et al* [10]. Unfortunately, the precision of the calculated $B_e(Z)$ values is not well established, since this quantity (approximately 760 keV for ${}_{92}\text{U}$) cannot be easily measured. However, we can state with a high confidence that the precision for ${}_{92}\text{U}$ is better compared to that for the best known masses of the uranium isotopes, which is about 1.1 keV. An approximate formula for B_e can be found in the review of Lunney, Pearson and Thibault [11]:

$$B_e(Z) = 14.4381 Z^{2.39} + 1.55468 \times 10^{-6} Z^{5.35} \text{ eV}. \quad (2)$$

The atomic masses are given in mass units and the derived quantities in energy units. For the atomic mass unit we use the “unified atomic mass unit”, symbol “u”, defined as 1/12 of the atomic mass of one ${}^{12}\text{C}$ atom in its electronic and nuclear ground states and in its rest coordinate system. In our work, energy values are expressed as electron-volt, using the *maintained* volt V_{90} . For a discussion see Part I, Section 2.

Due to the dramatic increase in the accuracy of mass for some light nuclides, the printing format of the mass table is not adequate for the most precisely known masses, which require many more digits. Table A gives values of mass excesses and atomic masses for 16 nuclides, whose masses are the most precisely known, with an uncertainty below 1 eV $_{90}$.

Mass excesses expressed in keV, which are of practical use, are also given. Conversion of the uncertainties from μu to keV can be obtained by:

$$\sigma_{M_{\text{keV}}}^2 = (\sigma_{M_u} \times u)^2 + (M_u \times \sigma_u)^2, \quad (3)$$

where M_u and σ_{M_u} are the mass excess and its uncertainty in μu , and σ_u is the uncertainty of u expressed in eV $_{90}$. The second term in Eq. 3 is only important for a very few nuclides.

Table A. The most precisely known masses.

	Mass excess (keV $_{90}$)	Uncertainty (keV $_{90}$)	Atomic mass (μu)	Uncertainty (μu)
${}^1\text{n}$	8 071.317 133	0.000 458	1 008 664.915 823	0.000 491
${}^1\text{H}$	7 288.970 613	0.000 087	1 007 825.032 241	0.000 094
${}^2\text{H}$	13 135.721 756	0.000 113	2 014 101.778 114	0.000 122
${}^3\text{H}$	14 949.809 935	0.000 215	3 016 049.281 985	0.000 231
${}^3\text{He}$	14 931.217 929	0.000 205	3 016 029.322 645	0.000 220
${}^4\text{He}$	2 424.915 612	0.000 059	4 002 603.254 130	0.000 063
${}^{13}\text{C}$	3 125.008 881	0.000 215	13 003 354.835 209	0.000 231
${}^{14}\text{N}$	2 863.416 722	0.000 193	14 003 074.004 460	0.000 207
${}^{15}\text{N}$	101.438 709	0.000 601	15 000 108.898 939	0.000 645
${}^{16}\text{O}$	- 4 737.001 351	0.000 162	15 994 914.619 598	0.000 173
${}^{17}\text{O}$	- 808.763 482	0.000 655	16 999 131.756 642	0.000 704
${}^{18}\text{O}$	- 782.815 600	0.000 706	17 999 159.612 840	0.000 758
${}^{19}\text{F}$	- 1 487.444 200	0.000 864	18 998 403.162 882	0.000 927
${}^{28}\text{Si}$	- 21 492.794 304	0.000 488	27 976 926.534 991	0.000 524
${}^{29}\text{Si}$	- 21 895.078 375	0.000 559	28 976 494.665 252	0.000 600
${}^{31}\text{P}$	- 24 440.540 953	0.000 674	30 973 761.998 625	0.000 724

Table B. Correlation matrices for the most precisely known very light nuclei (in squared nano atomic mass units).

	n	H	D	⁴ He	¹³ C	¹⁴ N	¹⁵ N	¹⁶ O	²⁸ Si
n	0.241391								
H	-0.006172	0.008794							
D	0.012177	0.002620	0.014802						
⁴ He	0.000000	0.000000	0.000000	0.004011					
¹³ C	0.004685	-0.006200	-0.001514	0.000000	0.053148				
¹⁴ N	-0.001300	0.002355	0.001055	0.000000	0.039083	0.042986			
¹⁵ N	-0.001181	0.013972	0.012791	0.000000	-0.003234	0.009421	0.416385		
¹⁶ O	-0.000837	0.002306	0.001470	0.000000	0.011842	0.014288	0.007047	0.030065	
²⁸ Si	-0.005085	0.009502	0.004416	0.000000	0.041404	0.043532	0.051304	0.024329	0.274560

	n	H	D	³ H	³ He	¹⁶ O	²⁰ Ne	²³ Na	²⁸ Si
n	0.241391								
H	-0.006172	0.008794							
D	0.012177	0.002620	0.014802						
³ H	0.006005	0.011413	0.017422	0.053335					
³ He	0.006005	0.011413	0.017422	0.048435	0.048435				
¹⁶ O	-0.000837	0.002306	0.001470	0.003776	0.003776	0.030065			
²⁰ Ne	0.027152	0.012479	0.039644	0.052123	0.052123	0.006215	2.829718		
²³ Na	0.000000	0.000001	0.000001	0.000001	0.000001	0.000004	0.000007	3.781636	
²⁸ Si	-0.005085	0.009502	0.004416	0.013918	0.013918	0.024329	0.019401	0.000047	0.274560

Since AME2003, we give in Table I the binding energy per nucleon, which is of educational interest, since it connects to the Aston Curve, displaying the maximum stability around the ‘iron-peak’ which is of importance in astrophysics. The highest binding energy per nucleon is observed for ⁶²Ni, followed sequentially by ⁵⁸Fe and ⁵⁶Fe.

3 Influences on primary nuclides

Table II lists all primary nuclides, together with the main data that contribute to their mass determination (up to the three most important ones) and the *influences* of these data on their masses. It complements the information given in the main table (Part I, Table I) where the *significance* (total flux) and the main *flux* of each datum are displayed. In other words, the flow-of-information matrix **F**, defined in Part I, Section 5.1, is (partly) displayed once along lines and once along columns.

4 Nuclear reaction and decay energies

The linear combinations involving neighboring nuclides with small differences in atomic number and mass number, and particles such as n, p, d, t, ³He and α, are important for studies of the trends in the nuclear energy surface and for Q-values of frequently used reactions. In Table III, values for 12 such combinations and their uncertainties are presented.

With the help of the instructions given in the explanation of Table III, values for 28 additional reactions and their uncertainties can be derived (cf. p. 030003-

99). The derived values will be correct, but in a few cases (when reactions involving light nuclei measured with very high precision) the uncertainties will be slightly larger than those obtained when correlations in the calculation are included.

In cases where any combination of the most precise mass values are involved, the uncertainties can be obtained with the help of the correlation coefficients given in Table B, where the variances and covariances for the most precisely known light nuclei are listed. When calculating uncertainties of mass combinations, one should use the mass values and their uncertainties in μu, and not the mass excesses (in keV). As an example, if one considers the mass difference between ³H and ³He, the mass difference can be easily obtained from the values listed in Table A. However, the corresponding uncertainty cannot be simply determined from the square root of the quadratic sum of the individual uncertainties, which would be:

$$\sqrt{0.231^2 + 0.220^2} = 0.32 \text{ nu.} \tag{4}$$

Since there is a strong correlation between these two nuclides, the uncertainty of the mass difference should be calculated using the correlation information provided in Table B. Thus, its uncertainty can be obtained from the square root of the sum of the variances minus twice the covariance:

$$\sqrt{0.231^2 + 0.220^2 - 2 * 0.048435} = 0.07 \text{ nu.} \tag{5}$$

As a result, the final uncertainty is much smaller when the correlation is taken into account.

The result of the least-squares adjustment of the experimental data that are used to determine atomic

masses, as described in Part I, is not represented completely by the atomic mass values given in the Table I and the energy values in Table III. A complete representation would require reproduction of a matrix of correlation coefficients. This matrix contains $\frac{1}{2}N(N+1)$ elements in which $N=1207$. As for AME2012, we made available at the AMDC website a full list of correlation coefficients for AME2016 [12], of which a very short sample is displayed in Table C.

We have also prepared a table of neutron, proton and deuteron pairing energies, available from the Atomic Mass Data Center (AMDC) [13], defined as:

Table C. Sample of variances and covariances in squared nano atomic mass units. Nuclides coded as AAAZZZi (i=isomeric state), e.g. $^1\text{H}=10010$, $^{16}\text{O}=160080$. Full table is on the AMDC website [12]

nuclide 1	nuclide 2	Variance or Covariance
10000	10000	0.24139060
10010	10000	-0.61717354E-02
.....
30010	30010	0.53335160E-01
30020	10000	0.60053621E-02
30020	10010	0.11413390E-01
30020	20010	0.17421780E-01
30020	30010	0.48435162E-01
.....
2541020	2531020	541761.20
2541020	2541020	0.10749120E+09

$$P_n(A, Z) = \frac{1}{4}(-1)^{A-Z+1}[S_n(A+1, Z) - 2S_n(A, Z) + S_n(A-1, Z)],$$

$$P_p(A, Z) = \frac{1}{4}(-1)^{Z+1}[S_p(A+1, Z+1) - 2S_p(A, Z) + S_p(A-1, Z-1)],$$

$$P_d(A, Z) = \frac{1}{4}(-1)^{Z+1}[S_d(A+2, Z+1) - 2S_d(A, Z) + S_d(A-2, Z-1)].$$

S_n , S_p , and S_d are the neutron, proton and deuteron separation energies, the latter being defined as:

$$S_d(A, Z) = -M(A, Z) + M(A-2, Z-1) + M(d) = -Q(\gamma, d).$$

The quantities S_n , and S_p are defined in the Explanation of Table III and $Q(\gamma, d)$ can be calculated as indicated there.

Remark: P_n is also sometimes written as:

$$P_n(A, Z) = \frac{1}{4}(-1)^{A-Z+1}[-M(A+1, Z) + 3M(A, Z) - 3M(A-1, Z) + M(A-2, Z)],$$

displaying thus more clearly the combination of the involved masses. Similar expressions are valid for P_p and P_d .

5 Graphs of trends from the mass surface

All the information contained in the mass table (Table I) and in the nuclear reaction and separation energy table (Table III) can in principle be displayed in plots of the binding energy (or mass) versus Z , N , or A . The atomic mass surface as a function of Z and N splits into four sheets due to the pairing energy, as discussed in Part I, Section 4. These sheets are nearly parallel almost everywhere in this three-dimensional space and have remarkably regular trends, as one may convince oneself by making various cuts (e.g. Z or N or A constant). Any derivative of the binding energies also defines four sheets. In this context, *derivative* means a specified difference between the masses of two nearby nuclides. For a derivative specified in such a way where the differences are between nuclides in the same mass sheet, the nearly parallelism of these sheets leads to an (almost) unified

surface for the derivative, thus allowing a single display. The derivatives are also smooth and have the advantage of displaying much smaller variations in data. Therefore, in order to illustrate the regular trends in the mass surface, three derivatives of this last type were chosen:

1. the two-neutron separation energies versus N , with lines connecting the isotopes of a given element (Figs. 1–9);
2. the two-proton separation energies versus Z , with lines connecting the isotones (the same number of neutrons) (Figs. 10–17);
3. the α -decay energies versus N , with lines connecting the isotopes of a given element (Figs. 18–26);

These figures supersede the ones published in Ref. [2].

In the previous AME publications, the graphs of the double β -decay energies versus A were also given. Such

drawings were not included in the present publication, but can be easily derived from the data in Table I.

The Trends from the Mass Surface (TMS) can be quite useful for checking the quality of any interpolation or extrapolation (if not too far). When some masses deviate from the regular TMS in a specific mass region, there could be a serious physical cause, like a shell or subshell closure or an onset of deformation. However, if only one mass exhibits an irregular pattern, thus violating the general smooth trends, then one may seriously question the correctness of the related input data (see the discussion in Part I, Section 4, p. 030002-11).

6 List of references

A complete list of references related to the input data used in the AME2016 and the NUBASE2016 evaluations are presented at the end of this paper. The individual references are identified using the CODEN style [14] (see

p. 030003-261). There is only one exception for the Eur. Phys. A journal, where instead of the ‘ZAANE’ identifier [14], we have used ‘EPJAA’.

7 Acknowledgements

This work is supported in part by the National Key Program for S&T Research and Development (Contract No. 2016YFA0400504) and the Major State Basic Research Development Program of China (Contract No. 2013CB834401). The work at ANL was supported by the U.S. Department of Energy, Office of Science, Office of Nuclear Physics, under Contract No. DE-AC02-06CH11357. W.J. Huang acknowledges the support from the China Scholarship Council, grant No. 201404910496. S. Naimi acknowledges the support of “RIKEN Pioneering Project Funding” from the Riken project. X. Xu acknowledges the support of “Light of West China Program” of Chinese Academy of Sciences.

References

- 1 G. Audi, M. Wang, A.H. Wapstra, F.G. Kondev, M. MacCormick, X. Xu and B. Pfeiffer, *Chin. Phys. C*, **36**: 1287 (2012)
- 2 M. Wang, G. Audi, A.H. Wapstra, F.G. Kondev, M. MacCormick, X. Xu and B. Pfeiffer, *Chin. Phys. C*, **36**: 1603 (2012)
- 3 A.H. Wapstra, G. Audi and C. Thibault, *Nucl. Phys. A*, **729**: 129 (2003)
- 4 G. Audi, A.H. Wapstra and C. Thibault, *Nucl. Phys. A*, **729**: 337 (2003)
- 5 G. Audi and A.H. Wapstra, *Nucl. Phys. A*, **595**: 409 (1995)
- 6 G. Audi and A.H. Wapstra, *Nucl. Phys. A*, **565**: 1 (1993)
- 7 G. Audi and A.H. Wapstra, *Nucl. Phys. A*, **565**: 66 (1993)
- 8 C. Borcea, G. Audi, A.H. Wapstra and P. Favaron, *Nucl. Phys. A*, **565**: 158 (1993)
- 9 G. Audi, A.H. Wapstra and M. Dedieu, *Nucl. Phys. A*, **565**: 193 (1993)
- 10 K.-N. Huang, M. Aoyagi, M.H. Chen, B. Crasemann and H. Mark, *At. Data Nucl. Data Tables* **18**: 243 (1976)
- 11 D. Lunney, J.M. Pearson and C. Thibault, *Rev. Mod. Phys.* **75**: 1021 (2003)
- 12 The full list of correlation coefficients can be downloaded from: <http://amdc.impcas.ac.cn/masstables/Ame2016/>
- 13 The AME2016 files in the electronic distribution and complementary documents can be retrieved from the Atomic Mass Data Center (AMDC) through the *Web*: <http://amdc.impcas.ac.cn/>
- 14 B. Pritychenko, E. Běták, M.A. Kellett, B. Singh and J. Totans, *Nucl. Instrum. Methods Phys. Res. A*, **640**: 213 (2011)

Table I. The 2016 Atomic mass table

EXPLANATION OF TABLE

N	Number of neutrons.
Z	Number of protons.
A	Mass number $A = N + Z$.
Elt.	Element symbol (for $Z \geq 113$ see Part I, Section 6.8, p. 030002-31).
Orig.	Origin of values for secondary nuclides.
	$z p n m$ mass of ${}^A Z$ derived from mass of ${}^{A+z+n}(Z+z)$.
	Special notations:
	IT when $z = 0, n = 0$;
	+ when $z = +1, n = -1$;
	- when $z = -1, n = +1$;
	++ when $z = +2, n = -2$;
	-- when $z = -2, n = +2$;
	ϵp when $z = -2, n = +1$;
	$+\alpha$ when $z = +2, n = +2$;
	$-\alpha$ when $z = -2, n = -2$;
	x for distant connection.
Mass excess	Mass excess [$M(\text{in u}) - A$], in keV, and its uncertainty (one-standard deviation). In cases where the furthest-left significant digit in the uncertainty was larger than 3, values and uncertainties were rounded off, but not to more than tens of keV. (Examples: $2345.67 \pm 2.78 \rightarrow 2345.7 \pm 2.8$, $2345.67 \pm 4.68 \rightarrow 2346 \pm 5$, but $2346.7 \pm 468.2 \rightarrow 2350 \pm 470$).
	# in place of decimal point: value and uncertainty derived not from purely experimental data, but at least partly from TMS (see Part I, Section 4, p. 030002-9).
Binding energy per nucleon	Tabulated binding energy per nucleon (in keV): $B/A = 1/A[ZM({}^1\text{H}) + NM({}^1\text{n}) - M(A, Z)]$. and its uncertainty.
	# in place of decimal point: see above.
	a in place of uncertainty : uncertainty smaller than 0.5 eV.
Beta-decay energy	Direction of decay, value and uncertainty in keV: for β^- : $Q^- = M(A, Z) - M(A, Z + 1)$; for β^+ : $Q^+ = M(A, Z) - M(A, Z - 1)$. For a few odd-odd nuclides near maximum β -stability decaying both β^- and β^+ , the Q^+ values are given as negative Q^- values for the preceding even-even isobar.
	* in place of value: not calculable.
	# in place of decimal point: see above.
	a in place of uncertainty : uncertainty smaller than 0.5 eV.
Atomic mass	Atomic mass M and its uncertainty in μu . # in place of decimal point: see above.

Table I. The 2016 Atomic mass table (Explanation of Table on p. 030003-6)

<i>N</i>	<i>Z</i>	<i>A</i>	El.	Orig.	Mass excess (keV)		Binding energy per nucleon (keV)		Beta-decay energy (keV)		Atomic mass μ		
1	0	1	n		8071.3171	0.0005	0.0	0.0	β^-	782.346	0.001	1 008664.9158	0.0005
0	1		H		7288.97061	0.00009	0.0	0.0	*	*		1 007825.03224	0.00009
1	1	2	H		13135.72176	0.00011	1112.283	<i>a</i>	*	*		2 014101.77811	0.00012
2	1	3	H		14949.80993	0.00022	2827.265	<i>a</i>	β^-	18.592	<i>a</i>	3 016049.28199	0.00023
1	2		He		14931.21793	0.00021	2572.680	<i>a</i>	*	*		3 016029.32265	0.00022
0	3		Li	-pp	28670#	2000#	-2270#	670#	β^+	13740#	2000#	3 030780#	2150#
3	1	4	H	-n	24620	100	1720	25	β^-	22200	100	4 026430	110
2	2		He		2424.91561	0.00006	7073.915	<i>a</i>	*	*		4 002603.25413	0.00006
1	3		Li	-p	25320	210	1150	50	β^+	22900	210	4 027190	230
4	1	5	H	-nn	32890	90	1336	18	β^-	21660	90	5 035310	100
3	2		He	-n	11231	20	5512	4	*	*		5 012057	21
2	3		Li	-p	11680	50	5266	10	β^+	450	50	5 012540	50
1	4		Be	x	37140#	2000#	20#	400#	β^+	25460#	2000#	5 039870#	2150#
5	1	6	H	-3n	41880	250	960	40	β^-	24280	250	6 044960	270
4	2		He		17592.10	0.05	4878.519	0.009	β^-	3505.22	0.05	6 018885.89	0.06
3	3		Li		14086.8789	0.0014	5332.331	<i>a</i>	*	*		6 015122.8874	0.0015
2	4		Be	-	18375	5	4487.2	0.9	β^+	4288	5	6 019726	6
1	5		B	x	47320#	2000#	-470#	330#	β^+	28950#	2000#	6 050800#	2150#
6	1	7	H	-nn	49140#	1000#	940#	140#	β^-	23060#	1000#	7 052750#	1080#
5	2		He	-n	26073	8	4123.1	1.1	β^-	11166	8	7 027991	8
4	3		Li		14907.105	0.004	5606.439	0.001	*	*		7 016003.437	0.005
3	4		Be		15769.00	0.07	5371.548	0.010	β^+	861.89	0.07	7 016928.72	0.08
2	5		B	p4n	27677	25	3559	4	β^+	11908	25	7 029712	27
6	2	8	He		31609.68	0.09	3924.520	0.011	β^-	10663.88	0.10	8 033934.39	0.10
5	3		Li		20945.80	0.05	5159.712	0.006	β^-	16004.13	0.06	8 022486.25	0.05
4	4		Be	$-\alpha$	4941.67	0.04	7062.435	0.004	*	*		8 005305.10	0.04
3	5		B		22921.6	1.0	4717.15	0.12	β^+	17979.9	1.0	8 024607.3	1.1
2	6		C		35064	18	3101.5	2.3	β^+	12143	18	8 037643	20
7	2	9	He		40940	50	3349	5	β^-	15980	50	9 043950	50
6	3		Li	-3n	24954.90	0.19	5037.768	0.021	β^-	13606.45	0.20	9 026790.19	0.20
5	4		Be		11348.45	0.08	6462.668	0.009	*	*		9 012183.07	0.08
4	5		B	-	12416.5	0.9	6257.07	0.10	β^+	1068.0	0.9	9 013329.6	1.0
3	6		C	-pp	28911.0	2.1	4337.42	0.24	β^+	16494.5	2.3	9 031037.2	2.3
8	2	10	He	-nn	49200	90	2995	9	β^-	16140	90	10 052820	100
7	3		Li	-n	33053	13	4531.4	1.3	β^-	20445	13	10 035483	14
6	4		Be		12607.49	0.08	6497.630	0.008	β^-	556.88	0.08	10 013534.70	0.09
5	5		B		12050.609	0.015	6475.083	0.002	*	*		10 012936.862	0.016
4	6		C		15698.67	0.07	6032.042	0.007	β^+	3648.06	0.07	10 016853.22	0.08
3	7		N	--	38800	400	3640	40	β^+	23100	400	10 041650	430
8	3	11	Li	x	40728.3	0.6	4155.38	0.06	β^-	20551.1	0.7	11 043723.6	0.7
7	4		Be		20177.17	0.24	5952.540	0.022	β^-	11509.46	0.24	11 021661.08	0.26
6	5		B		8667.707	0.012	6927.732	0.001	*	*		11 009305.167	0.013
5	6		C		10649.40	0.06	6676.456	0.005	β^+	1981.69	0.06	11 011432.60	0.06
4	7		N	-p	24300	50	5364	4	β^+	13650	50	11 026090	50
9	3	12	Li	-n	49010	30	3791.6	2.5	β^-	23930	30	12 052610	30
8	4		Be		25077.8	1.9	5720.72	0.16	β^-	11708.4	2.3	12 026922.1	2.0
7	5		B		13369.4	1.3	6631.22	0.11	β^-	13369.4	1.3	12 014352.6	1.4
6	6		C		0.0	0.0	7680.144	<i>a</i>	*	*		12 000000.0	0.0
5	7		N		17338.1	1.0	6170.11	0.08	β^+	17338.1	1.0	12 018613.2	1.1
4	8		O	-pp	31915	24	4890.2	2.0	β^+	14577	24	12 034262	26

Table I. The 2012 Atomic mass table (continued, Explanation of Table on p. 030003-6)

<i>N</i>	<i>Z</i>	<i>A</i>	Elt.	Orig.	Mass excess (keV)		Binding energy per nucleon (keV)		Beta-decay energy (keV)		Atomic mass μ		
10	3	13	Li	-nn	56980	70	3508	5	β^-	23320	70	13 061170	80
9	4		Be	-n	33659	10	5241.4	0.8	β^-	17097	10	13 036135	11
8	5		B	-nn	16561.9	1.0	6496.42	0.08	β^-	13436.9	1.0	13 017780.0	1.1
7	6		C		3125.00888	0.00021	7469.849	<i>a</i>	*			13 003354.83521	0.00023
6	7		N		5345.48	0.27	7238.863	0.021	β^+	2220.47	0.27	13 005738.61	0.29
5	8		O	+3n	23115	10	5811.8	0.7	β^+	17770	10	13 024815	10
10	4	14	Be	x	39950	130	4994	9	β^-	16290	130	14 042890	140
9	5		B		23664	21	6101.6	1.5	β^-	20644	21	14 025404	23
8	6		C		3019.893	0.004	7520.319	<i>a</i>	β^-	156.476	0.004	14 003241.988	0.004
7	7		N		2863.41672	0.00019	7475.614	<i>a</i>	*			14 003074.00446	0.00021
6	8		O		8007.781	0.025	7052.278	0.002	β^+	5144.364	0.025	14 008596.706	0.027
5	9		F	-p	31960	40	5285.2	2.9	β^+	23960	40	14 034320	40
11	4	15	Be	-n	49830	170	4541	11	β^-	20870	170	15 053490	180
10	5		B		28958	21	5880.0	1.4	β^-	19085	21	15 031088	23
9	6		C	-n	9873.1	0.8	7100.17	0.05	β^-	9771.7	0.8	15 010599.3	0.9
8	7		N		101.4387	0.0006	7699.460	<i>a</i>	*			15 000108.8989	0.0006
7	8		O		2855.6	0.5	7463.69	0.03	β^+	2754.2	0.5	15 003065.6	0.5
6	9		F	-p	16567	14	6497.5	0.9	β^+	13711	14	15 017785	15
5	10		Ne	-pp	40220	70	4869	4	β^+	23650	70	15 043170	70
12	4	16	Be	-nn	57450	170	4285	10	β^-	20330	170	16 061670	180
11	5		B		37113	25	5507.3	1.5	β^-	23418	25	16 039842	26
10	6		C	-nn	13694	4	6922.05	0.22	β^-	8010	4	16 014701	4
9	7		N	-n	5683.9	2.3	7373.80	0.14	β^-	10420.9	2.3	16 006101.9	2.5
8	8		O		-4737.00135	0.00016	7976.206	<i>a</i>	*			15 994914.61960	0.00017
7	9		F	-	10680	8	6963.7	0.5	β^+	15417	8	16 011466	9
6	10		Ne	--	23987	20	6083.2	1.3	β^+	13307	22	16 025751	22
12	5	17	B	x	43720	200	5270	12	β^-	22680	200	17 046930	220
11	6		C	2p-n	21032	17	6558.0	1.0	β^-	13162	23	17 022579	19
10	7		N	+p	7870	15	7286.2	0.9	β^-	8679	15	17 008449	16
9	8		O		-808.7635	0.0007	7750.728	<i>a</i>	*			16 999131.7566	0.0007
8	9		F		1951.70	0.25	7542.328	0.015	β^+	2760.47	0.25	17 002095.24	0.27
7	10		Ne		16500.4	0.4	6640.499	0.021	β^+	14548.7	0.4	17 017714.0	0.4
6	11		Na	x	35170	1000	5500	60	β^+	18670	1000	17 037760	1080
13	5	18	B	-n	51790	200	4977	11	β^-	26870	210	18 055600	220
12	6		C	++	24920	30	6426.1	1.7	β^-	11810	40	18 026750	30
11	7		N	+	13113	19	7038.6	1.0	β^-	13896	19	18 014078	20
10	8		O		-782.8156	0.0007	7767.097	<i>a</i>	*			17 999159.6128	0.0008
9	9		F		873.1	0.5	7631.638	0.026	β^+	1655.9	0.5	18 000937.3	0.5
8	10		Ne		5317.6	0.4	7341.257	0.020	β^+	4444.5	0.6	18 005708.7	0.4
7	11		Na		25040	90	6202	5	β^+	19720	90	18 026880	100
14	5	19	B	x	59770	530	4720	28	β^-	27360	530	19 064170	560
13	6		C	-n	32410	100	6118	5	β^-	16560	100	19 034800	110
12	7		N	p-2n	15856	16	6948.5	0.9	β^-	12523	17	19 017022	18
11	8		O	-n	3332.9	2.6	7566.49	0.14	β^-	4820.3	2.6	19 003578.0	2.8
10	9		F		-1487.4442	0.0009	7779.018	<i>a</i>	*			18 998403.1629	0.0009
9	10		Ne	+3n	1752.05	0.16	7567.343	0.008	β^+	3239.49	0.16	19 001880.90	0.17
8	11		Na		12929	11	6937.9	0.6	β^+	11177	11	19 013880	11
7	12		Mg	-pp	31830	50	5902.0	2.6	β^+	18900	50	19 034170	50

Table I. The 2012 Atomic mass table (continued, Explanation of Table on p. 030003-6)

<i>N</i>	<i>Z</i>	<i>A</i>	Elt.	Orig.	Mass excess (keV)		Binding energy per nucleon (keV)		Beta-decay energy (keV)		Atomic mass μ u		
15	5	20	B	x	68450#	800#	4450#	40#	β^-	30950#	830#	20 073480#	860#
14	6		C	x	37500	230	5961	12	β^-	15740	240	20 040260	250
13	7		N	x	21770	80	6709	4	β^-	17970	80	20 023370	80
12	8		O	-nn	3796.2	0.9	7568.57	0.04	β^-	3813.6	0.9	20 004075.4	0.9
11	9		F	-n	-17.463	0.030	7720.134	0.002	β^-	7024.467	0.030	19 999981.25	0.03
10	10		Ne		-7041.9305	0.0016	8032.240	<i>a</i>	*	*	*	19 992440.1762	0.0017
9	11		Na		6850.6	1.1	7298.50	0.06	β^+	13892.5	1.1	20 007354.4	1.2
8	12		Mg	+t	17477.7	1.9	6728.02	0.09	β^+	10627.1	2.2	20 018763.1	2.0
16	5	21	B	x	77330#	900#	4200#	40#	β^-	31690#	1080#	21 083020#	970#
15	6		C	x	45640#	600#	5674#	28#	β^-	20410#	610#	21 049000#	640#
14	7		N	x	25230	130	6609	6	β^-	17170	130	21 027090	140
13	8		O	-3n	8062	12	7389.4	0.6	β^-	8110	12	21 008655	13
12	9		F	-nn	-47.6	1.8	7738.29	0.09	β^-	5684.2	1.8	20 999948.9	1.9
11	10		Ne		-5731.78	0.04	7971.713	0.002	*	*	*	20 993846.69	0.04
10	11		Na		-2184.63	0.10	7765.547	0.005	β^+	3547.14	0.09	20 997654.70	0.11
9	12		Mg	x	10903.8	0.8	7105.03	0.04	β^+	13088.5	0.8	21 011705.8	0.8
8	13		Al	x	26990#	600#	6302#	28#	β^+	16090#	600#	21 028980#	640#
16	6	22	C	-nn	53610	230	5421	11	β^-	21850	310	22 057550	250
15	7		N	x	31760	210	6379	9	β^-	22480	220	22 034100	220
14	8		O	-4n	9280	60	7364.9	2.6	β^-	6490	60	22 009970	60
13	9		F	+	2793	12	7624.3	0.6	β^-	10818	12	22 002999	13
12	10		Ne		-8024.719	0.018	8080.465	0.001	*	*	*	21 991385.110	0.019
11	11		Na		-5181.51	0.17	7915.667	0.008	β^+	2843.21	0.17	21 994437.42	0.18
10	12		Mg		-399.9	0.3	7662.761	0.014	β^+	4781.6	0.3	21 999570.7	0.3
9	13		Al	x	18200#	400#	6782#	18#	β^+	18600#	400#	22 019540#	430#
8	14		Si	x	33340#	500#	6058#	23#	β^+	15140#	640#	22 035790#	540#
17	6	23	C	x	64170#	1000#	5080#	40#	β^-	27450#	1080#	23 068890#	1070#
16	7		N	x	36720	420	6237	18	β^-	22100	440	23 039420	450
15	8		O	x	14620	120	7163	5	β^-	11340	130	23 015700	130
14	9		F	x	3290	30	7622.3	1.4	β^-	8440	30	23 003530	40
13	10		Ne	-n	-5154.05	0.10	7955.256	0.005	β^-	4375.80	0.10	22 994466.90	0.11
12	11		Na		-9529.8525	0.0018	8111.493	<i>a</i>	*	*	*	22 989769.2820	0.0019
11	12		Mg	—	-5473.51	0.16	7901.115	0.007	β^+	4056.34	0.16	22 994123.94	0.17
10	13		Al	—	6748.1	0.3	7335.727	0.015	β^+	12221.6	0.4	23 007244.4	0.4
9	14		Si	x	23700#	500#	6565#	22#	β^+	16950#	500#	23 025440#	540#
17	7	24	N	x	46940#	400#	5887#	17#	β^-	28440#	430#	24 050390#	430#
16	8		O	x	18500	160	7040	7	β^-	10960	190	24 019860	180
15	9		F	x	7540	100	7464	4	β^-	13500	100	24 008100	100
14	10		Ne	-nn	-5951.6	0.5	7993.325	0.021	β^-	2466.3	0.5	23 993610.6	0.6
13	11		Na	-n	-8417.901	0.017	8063.488	0.001	β^-	5515.669	0.021	23 990963.011	0.018
12	12		Mg		-13933.569	0.013	8260.709	0.001	*	*	*	23 985041.697	0.014
11	13		Al	ϵ p	-48.86	0.23	7649.582	0.010	β^+	13884.70	0.23	23 999947.54	0.25
10	14		Si	—	10745	19	7167.2	0.8	β^+	10794	19	24 011535	21
9	15		P	x	33320#	500#	6194#	21#	β^+	22570#	500#	24 035770#	540#
18	7	25	N	x	55980#	500#	5613#	20#	β^-	28650#	530#	25 060100#	540#
17	8		O	-n	27330	170	6728	7	β^-	15990	190	25 029340	180
16	9		F	x	11330	100	7336	4	β^-	13370	100	25 012170	100
15	10		Ne		-2036	29	7839.8	1.2	β^-	7322	29	24 997810	30
14	11		Na	-nn	-9357.8	1.2	8101.40	0.05	β^-	3835.0	1.2	24 989954.0	1.3
13	12		Mg		-13192.78	0.05	8223.502	0.002	*	*	*	24 985836.96	0.05
12	13		Al		-8915.97	0.06	8021.136	0.003	β^+	4276.81	0.04	24 990428.31	0.07
11	14		Si	+3n	3827	10	7480.1	0.4	β^+	12743	10	25 004109	11
10	15		P	x	19740#	400#	6812#	16#	β^+	15910#	400#	25 021190#	430#

Table I. The 2012 Atomic mass table (continued, Explanation of Table on p. 030003-6)

<i>N</i>	<i>Z</i>	<i>A</i>	Elt.	Orig.	Mass excess (keV)		Binding energy per nucleon (keV)		Beta-decay energy (keV)		Atomic mass μ u		
18	8	26	O	-nn	34660	160	6497	6	β^-	16010	200	26 037210	180
17	9		F	x	18650	110	7083	4	β^-	18170	110	26 020020	120
16	10		Ne	x	481	18	7751.9	0.7	β^-	7342	19	26 000516	20
15	11		Na	x	-6861	4	8004.20	0.13	β^-	9354	4	25 992635	4
14	12		Mg		-16214.542	0.030	8333.870	0.001	*			25 982592.97	0.03
13	13		Al		-12210.15	0.07	8149.765	0.003	β^+	4004.39	0.06	25 986891.86	0.07
12	14		Si	-	-7141.02	0.11	7924.708	0.004	β^+	5069.14	0.08	25 992333.80	0.12
11	15		P	x	10970#	200#	7198#	8#	β^+	18110#	200#	26 011780#	210#
10	16		S	x	27080#	600#	6548#	23#	β^+	16110#	630#	26 029070#	640#
19	8	27	O	x	44670#	500#	6185#	19#	β^-	19220#	630#	27 047960#	540#
18	9		F	x	25450	390	6868	14	β^-	18400	400	27 027320	420
17	10		Ne	x	7050	90	7520	3	β^-	12570	90	27 007570	100
16	11		Na	++	-5518	4	7956.95	0.14	β^-	9069	4	26 994076	4
15	12		Mg	-n	-14586.61	0.05	8263.852	0.002	β^-	2610.25	0.07	26 984340.63	0.05
14	13		Al		-17196.86	0.05	8331.553	0.002	*			26 981538.41	0.05
13	14		Si	-	-12384.50	0.11	8124.341	0.004	β^+	4812.36	0.10	26 986704.69	0.12
12	15		P	p4n	-722	26	7663.4	1.0	β^+	11662	26	26 999224	28
11	16		S	-	17030#	400#	6977#	15#	β^+	17750#	400#	27 018280#	430#
20	8	28	O	x	52080#	700#	5988#	25#	β^-	18340#	800#	28 055910#	750#
19	9		F	-n	33740	390	6615	14	β^-	22440	410	28 036220	420
18	10		Ne	x	11300	130	7388	5	β^-	12290	130	28 012130	140
17	11		Na	x	-988	10	7799.3	0.4	β^-	14031	10	27 998939	11
16	12		Mg	+	-15018.8	2.0	8272.41	0.07	β^-	1831.8	2.0	27 983876.6	2.1
15	13		Al	-n	-16850.64	0.08	8309.894	0.003	β^-	4642.15	0.08	27 981910.09	0.08
14	14		Si		-21492.7943	0.0005	8447.744	<i>a</i>	*			27 976926.5350	0.0005
13	15		P		-7147.7	1.2	7907.48	0.04	β^+	14345.1	1.2	27 992326.6	1.2
12	16		S	--	4070	160	7479	6	β^+	11220	160	28 004370	170
11	17		Cl	x	27520#	600#	6614#	21#	β^+	23440#	620#	28 029540#	640#
20	9	29	F	x	40150	530	6444	18	β^-	21750	550	29 043100	560
19	10		Ne	x	18400	150	7167	5	β^-	15720	150	29 019750	160
18	11		Na		2680	7	7682.15	0.25	β^-	13283	14	29 002877	8
17	12		Mg	x	-10603	11	8113.2	0.4	β^-	7605	11	28 988617	12
16	13		Al	x	-18207.8	0.3	8348.464	0.012	β^-	3687.3	0.3	28 980453.2	0.4
15	14		Si		-21895.0784	0.0006	8448.635	<i>a</i>	*			28 976494.6653	0.0006
14	15		P		-16952.8	0.4	8251.236	0.012	β^+	4942.2	0.4	28 981800.4	0.4
13	16		S	+3n	-3160	50	7748.5	1.7	β^+	13800	50	28 996610	50
12	17		Cl	-p	13160	190	7159	7	β^+	16320	200	29 014130	200
21	9	30	F	x	48110#	600#	6233#	20#	β^-	24830#	650#	30 051650#	640#
20	10		Ne		23280	250	7035	8	β^-	14810	250	30 024990	270
19	11		Na		8475	5	7501.97	0.16	β^-	17358	6	30 009098	5
18	12		Mg	x	-8884	3	8054.51	0.11	β^-	6981	4	29 990463	4
17	13		Al	x	-15864.8	2.9	8261.13	0.10	β^-	8568.1	2.9	29 982968	3
16	14		Si	-n	-24432.960	0.022	8520.654	0.001	*			29 973770.137	0.023
15	15		P	-	-20200.85	0.07	8353.506	0.002	β^+	4232.11	0.06	29 978313.49	0.07
14	16		S	-	-14059.25	0.21	8122.707	0.007	β^+	6141.60	0.20	29 984906.77	0.22
13	17		Cl	x	4440#	200#	7480#	7#	β^+	18500#	200#	30 004770#	210#
12	18		Ar	-pp	20930	210	6904	7	β^+	16490#	280#	30 022470	220
22	9	31	F	-nn	56140#	550#	6033#	18#	β^-	24960#	610#	31 060270#	590#
21	10		Ne		31180	270	6813	9	β^-	18940	270	31 033470	290
20	11		Na	x	12246	14	7398.7	0.5	β^-	15368	14	31 013147	15
19	12		Mg	x	-3122	3	7869.19	0.10	β^-	11829	4	30 996648	3
18	13		Al	x	-14950.7	2.2	8225.52	0.07	β^-	7998.3	2.2	30 983949.8	2.4
17	14		Si	-n	-22949.04	0.04	8458.291	0.001	β^-	1491.50	0.04	30 975363.19	0.05
16	15		P		-24440.5410	0.0007	8481.167	<i>a</i>	*			30 973761.9986	0.0007
15	16		S		-19042.52	0.23	8281.800	0.007	β^+	5398.02	0.23	30 979557.01	0.25
14	17		Cl	--	-7035	3	7869.21	0.11	β^+	12008	3	30 992448	4
13	18		Ar	-	11330#	200#	7252#	6#	β^+	18360#	200#	31 012160#	220#

Table I. The 2012 Atomic mass table (continued, Explanation of Table on p. 030003-6)

<i>N</i>	<i>Z</i>	<i>A</i>	Elt.	Orig.	Mass excess (keV)	Binding energy per nucleon (keV)	Beta-decay energy (keV)	Atomic mass μ		
22	10	32	Ne	x	37000#	500#	6671# 16#	β^- 18360# 500#	32 039720#	540#
21	11		Na	x	18640	40	7219.9 1.2	β^- 19470 40	32 020010	40
20	12		Mg	x	-829	3	7803.84 0.10	β^- 10270 8	31 999110	4
19	13		Al	x	-11099	7	8100.34 0.22	β^- 12978 7	31 988084	8
18	14		Si	x	-24077.69	0.30	8481.468 0.009	β^- 227.2 0.3	31 974151.5	0.3
17	15		P	-n	-24304.87	0.04	8464.120 0.001	β^- 1710.66 0.04	31 973907.64	0.04
16	16		S		-26015.5336	0.0013	8493.129 <i>a</i>	*	31 972071.1744	0.0014
15	17		Cl		-13334.7	0.6	8072.404 0.018	β^+ 12680.9 0.6	31 985684.6	0.6
14	18		Ar	x	-2200.4	1.8	7700.01 0.06	β^+ 11134.3 1.9	31 997637.8	1.9
13	19		K	x	21100#	400#	6947# 13#	β^+ 23300# 400#	32 022650#	430#
23	10	33	Ne	x	46000#	600#	6440# 18#	β^- 22220# 750#	33 049380#	640#
22	11		Na	x	23780	450	7090 14	β^- 18820 450	33 025530	480
21	12		Mg	x	4962.3	2.9	7636.45 0.09	β^- 13460 8	33 005327	3
20	13		Al	x	-8497	7	8020.62 0.21	β^- 12017 7	32 990878	8
19	14		Si	x	-20514.3	0.7	8361.059 0.021	β^- 5823.0 1.3	32 977977.0	0.8
18	15		P	+	-26337.3	1.1	8513.81 0.03	β^- 248.5 1.1	32 971725.7	1.2
17	16		S		-26585.8543	0.0014	8497.630 <i>a</i>	*	32 971458.9099	0.0015
16	17		Cl		-21003.3	0.4	8304.755 0.012	β^+ 5582.5 0.4	32 977452.0	0.4
15	18		Ar	x	-9384.3	0.4	7928.955 0.012	β^+ 11619.0 0.6	32 989925.5	0.4
14	19		K	x	7040#	200#	7407# 6#	β^+ 16430# 200#	33 007560#	210#
24	10	34	Ne	-nn	52840#	510#	6287# 15#	β^- 21160# 790#	34 056730#	550#
23	11		Na	x	31680	600	6886 18	β^- 23360 600	34 034010	640
22	12		Mg	x	8323	29	7550.4 0.8	β^- 11324 29	34 008940	30
21	13		Al	x	-3000	3	7860.43 0.09	β^- 16957 14	33 996779	3
20	14		Si	+pp	-19957	14	8336.1 0.4	β^- 4592 14	33 978575	15
19	15		P	x	-24548.7	0.8	8448.185 0.024	β^- 5383.0 0.8	33 973645.9	0.9
18	16		S		-29931.69	0.04	8583.498 0.001	*	33 967867.01	0.05
17	17		Cl		-24440.08	0.05	8398.970 0.002	β^+ 5491.60 0.04	33 973762.49	0.05
16	18		Ar		-18378.29	0.08	8197.672 0.002	β^+ 6061.79 0.06	33 980270.09	0.08
15	19		K	x	-1220#	200#	7670# 6#	β^+ 17160# 200#	33 998690#	210#
14	20		Ca	x	13850#	300#	7204# 9#	β^+ 15070# 360#	34 014870#	320#
24	11	35	Na	-n	38230#	670#	6733# 19#	β^- 22590# 720#	35 041040#	720#
23	12		Mg	x	15640	270	7356 8	β^- 15860 270	35 016790	290
22	13		Al	x	-224	7	7787.12 0.21	β^- 14170 40	34 999760	8
21	14		Si	2p-n	-14390	40	8169.6 1.0	β^- 10470 40	34 984550	40
20	15		P	+p	-24857.8	1.9	8446.25 0.05	β^- 3988.4 1.9	34 973314.1	2.0
19	16		S		-28846.21	0.04	8537.850 0.001	β^- 167.322 0.026	34 969032.32	0.04
18	17		Cl		-29013.53	0.04	8520.278 0.001	*	34 968852.69	0.04
17	18		Ar	-	-23047.3	0.7	8327.461 0.019	β^+ 5966.2 0.7	34 975257.7	0.7
16	19		K	4n	-11172.9	0.5	7965.840 0.015	β^+ 11874.4 0.9	34 988005.4	0.6
15	20		Ca	x	4790#	200#	7487# 6#	β^+ 15960# 200#	35 005140#	210#
25	11	36	Na	-n	46300#	680#	6546# 19#	β^- 25920# 970#	36 049710#	730#
24	12		Mg	x	20380	690	7244 19	β^- 14430 710	36 021880	740
23	13		Al	x	5950	150	7624 4	β^- 18390 170	36 006390	160
22	14		Si	x	-12440	70	8112.5 2.0	β^- 7810 70	35 986650	80
21	15		P	+	-20251	13	8307.9 0.4	β^- 10413 13	35 978260	14
20	16		S		-30664.13	0.19	8575.389 0.005	β^- -1142.13 0.19	35 967080.70	0.20
19	17		Cl		-29522.01	0.04	8521.931 0.001	β^- 709.53 0.04	35 968306.82	0.04
18	18		Ar		-30231.540	0.027	8519.909 0.001	*	35 967545.105	0.029
17	19		K		-17417.1	0.3	8142.219 0.009	β^+ 12814.5 0.3	35 981302.0	0.4
16	20		Ca	4n	-6450	40	7815.9 1.1	β^+ 10970 40	35 993070	40
15	21		Sc	x	15350#	300#	7189# 8#	β^+ 21800# 300#	36 016480#	320#

Table I. The 2012 Atomic mass table (continued, Explanation of Table on p. 030003-6)

<i>N</i>	<i>Z</i>	<i>A</i>	Elt.	Orig.	Mass excess (keV)		Binding energy per nucleon (keV)		Beta-decay energy (keV)		Atomic mass μ u		
26	11	37	Na	-nn	53530#	690#	6392#	19#	β^-	25320#	980#	37 057470#	740#
25	12		Mg	-n	28210	700	7055	19	β^-	18400	720	37 030290	750
24	13		Al	x	9810	180	7531	5	β^-	16380	210	37 010530	190
23	14		Si	x	-6570	110	7953	3	β^-	12420	120	36 992950	120
22	15		P	p-2n	-19000	40	8267.6	1.0	β^-	7900	40	36 979610	40
21	16		S	-n	-26896.42	0.20	8459.935	0.005	β^-	4865.12	0.20	36 971125.51	0.21
20	17		Cl		-31761.54	0.05	8570.281	0.001	*			36 965902.58	0.06
19	18		Ar	-	-30947.66	0.21	8527.139	0.006	β^+	813.87	0.20	36 966776.31	0.22
18	19		K	-p	-24800.20	0.09	8339.847	0.003	β^+	6147.47	0.23	36 973375.89	0.10
17	20		Ca	x	-13136.1	0.6	8003.456	0.017	β^+	11664.1	0.6	36 985897.9	0.7
16	21		Sc	x	3520#	300#	7532#	8#	β^+	16660#	300#	37 003780#	320#
26	12	38	Mg	x	34070#	500#	6928#	13#	β^-	17860#	630#	38 036580#	540#
25	13		Al	x	16210	370	7377	10	β^-	20380	390	38 017400	400
24	14		Si	x	-4170	100	7892.8	2.8	β^-	10450	130	37 995520	110
23	15		P	x	-14620	70	8147.3	1.9	β^-	12240	70	37 984300	80
22	16		S	+	-26861	7	8448.78	0.19	β^-	2937	7	37 971163	8
21	17		Cl	-n	-29798.10	0.10	8505.481	0.003	β^-	4916.72	0.22	37 968010.42	0.11
20	18		Ar		-34714.82	0.19	8614.280	0.005	*			37 962732.10	0.21
19	19		K		-28800.75	0.20	8438.058	0.005	β^+	5914.07	0.04	37 969081.12	0.21
18	20		Ca		-22058.50	0.19	8240.043	0.005	β^+	6742.26	0.06	37 976319.23	0.21
17	21		Sc	x	-4250#	200#	7751#	5#	β^+	17810#	200#	37 995440#	220#
16	22		Ti	x	10870#	300#	7332#	8#	β^+	15120#	360#	38 011670#	320#
27	12	39	Mg	-n	42280#	510#	6747#	13#	β^-	21630#	650#	39 045380#	550#
26	13		Al	x	20650#	400#	7281#	10#	β^-	18330#	420#	39 022170#	430#
25	14		Si	x	2320	140	7731	3	β^-	15090	180	39 002490	150
24	15		P	x	-12770	110	8098.0	2.9	β^-	10390	120	38 986290	120
23	16		S	2p-n	-23160	50	8344.3	1.3	β^-	6640	50	38 975130	50
22	17		Cl	-nn	-29800.2	1.7	8494.40	0.04	β^-	3442	5	38 968008.2	1.9
21	18		Ar	+	-33242	5	8562.60	0.13	β^-	565	5	38 964313	5
20	19		K		-33807.190	0.005	8557.025	<i>a</i>	*			38 963706.487	0.005
19	20		Ca		-27282.7	0.6	8369.670	0.015	β^+	6524.5	0.6	38 970710.8	0.6
18	21		Sc	2n-p	-14173	24	8013.5	0.6	β^+	13110	24	38 984785	26
17	22		Ti	x	2200#	200#	7574#	5#	β^+	16370#	200#	39 002360#	220#
28	12	40	Mg	x	48350#	500#	6628#	13#	β^-	20760#	640#	40 051910#	540#
27	13		Al	x	27590#	400#	7127#	10#	β^-	22160#	530#	40 029620#	430#
26	14		Si	x	5430	350	7662	9	β^-	13540	380	40 005830	370
25	15		P	x	-8110	150	7981	4	β^-	14720	150	39 991290	160
24	16		S		-22838	4	8329.32	0.10	β^-	4720	30	39 975483	4
23	17		Cl	+	-27560	30	8427.8	0.8	β^-	7480	30	39 970420	30
22	18		Ar		-35039.8946	0.0022	8595.259	<i>a</i>	β^-	-1504.40	0.06	39 962383.1238	0.0024
21	19		K		-33535.49	0.06	8538.090	0.001	β^-	1310.89	0.06	39 963998.17	0.06
20	20		Ca		-34846.384	0.021	8551.303	0.001	*			39 962590.866	0.022
19	21		Sc	-	-20523.3	2.8	8173.67	0.07	β^+	14323.0	2.8	39 977967	3
18	22		Ti	--	-8850	160	7862	4	β^+	11670	160	39 990500	170
17	23		V	x	12170#	300#	7317#	7#	β^+	21020#	340#	40 013070#	320#
28	13	41	Al	x	33420#	500#	7008#	12#	β^-	21300#	750#	41 035880#	540#
27	14		Si	x	12120	550	7509	14	β^-	17100	570	41 013010	600
26	15		P	x	-4980	120	7906.6	2.9	β^-	14030	120	40 994650	130
25	16		S	x	-19009	4	8229.64	0.10	β^-	8300	70	40 979593	4
24	17		Cl	x	-27310	70	8413.0	1.7	β^-	5760	70	40 970680	70
23	18		Ar	-n	-33067.5	0.3	8534.372	0.008	β^-	2492.0	0.3	40 964500.6	0.4
22	19		K		-35559.543	0.004	8576.072	<i>a</i>	*			40 961825.258	0.004
21	20		Ca		-35137.89	0.14	8546.706	0.003	β^+	421.65	0.14	40 962277.92	0.15
20	21		Sc		-28642.41	0.08	8369.198	0.002	β^+	6495.48	0.16	40 969251.10	0.09
19	22		Ti	x	-15698	28	8034.4	0.7	β^+	12945	28	40 983150	30
18	23		V	x	320#	200#	7625#	5#	β^+	16020#	200#	41 000340#	220#

Table I. The 2012 Atomic mass table (continued, Explanation of Table on p. 030003-6)

<i>N</i>	<i>Z</i>	<i>A</i>	Elt.	Orig.	Mass excess (keV)		Binding energy per nucleon (keV)		Beta-decay energy (keV)		Atomic mass μu		
29	13	42	Al	x	40100#	600#	6874#	14#	β^-	23630#	780#	42 043050#	640#
28	14		Si	x	16470#	500#	7418#	12#	β^-	15460#	590#	42 017680#	540#
27	15		P	x	1010	310	7768	7	β^-	18650	310	42 001080	340
26	16		S	x	-17637.7	2.8	8193.23	0.07	β^-	7190	60	41 981065	3
25	17		Cl	x	-24830	60	8345.9	1.4	β^-	9590	60	41 973340	60
24	18		Ar	x	-34423	6	8555.61	0.14	β^-	599	6	41 963046	6
23	19		K	-n	-35022.03	0.11	8551.256	0.003	β^-	3525.22	0.18	41 962402.31	0.11
22	20		Ca		-38547.24	0.15	8616.563	0.004	*			41 958617.83	0.16
21	21		Sc		-32121.15	0.17	8444.933	0.004	β^+	6426.09	0.10	41 965516.52	0.18
20	22		Ti		-25104.67	0.28	8259.247	0.007	β^+	7016.48	0.22	41 973049.02	0.30
19	23		V	x	-7620#	200#	7824#	5#	β^+	17490#	200#	41 991820#	210#
18	24		Cr	x	6730#	400#	7464#	10#	β^+	14350#	450#	42 007230#	430#
30	13	43	Al	x	47020#	800#	6741#	19#	β^-	23920#	1000#	43 050480#	860#
29	14		Si	x	23100#	600#	7279#	14#	β^-	18420#	810#	43 024800#	640#
28	15		P	x	4680	550	7690	13	β^-	16880	550	43 005020	600
27	16		S	x	-12195	5	8063.83	0.12	β^-	11960	60	42 986908	5
26	17		Cl	x	-24160	60	8323.9	1.4	β^-	7850	60	42 974060	70
25	18		Ar	x	-32010	5	8488.24	0.12	β^-	4566	5	42 965636	6
24	19		K	-4n	-36575.4	0.4	8576.220	0.010	β^-	1833.4	0.5	42 960734.7	0.4
23	20		Ca		-38408.82	0.23	8600.663	0.005	*			42 958766.43	0.24
22	21		Sc	-p	-36188.1	1.9	8530.82	0.04	β^+	2220.7	1.9	42 961150.5	2.0
21	22		Ti	-n2p	-29321	7	8352.93	0.17	β^+	6867	7	42 968523	8
20	23		V	x	-17920	40	8069.5	1.0	β^+	11400	40	42 980770	50
19	24		Cr	x	-1970#	400#	7680#	9#	β^+	15950#	400#	42 997890#	430#
30	14	44	Si	x	28510#	600#	7174#	14#	β^-	18060#	780#	44 030610#	640#
29	15		P	x	10450#	500#	7567#	11#	β^-	19660#	500#	44 011220#	540#
28	16		S	x	-9204	5	7996.01	0.12	β^-	11180	140	43 990119	6
27	17		Cl	x	-20380	140	8232	3	β^-	12290	140	43 978120	150
26	18		Ar	x	-32673.3	1.6	8493.84	0.04	β^-	3108.2	1.6	43 964923.8	1.7
25	19		K	x	-35781.5	0.4	8546.701	0.010	β^-	5687.2	0.5	43 961587.0	0.5
24	20		Ca		-41468.7	0.3	8658.175	0.007	*			43 955481.5	0.3
23	21		Sc	-p	-37816.0	1.8	8557.38	0.04	β^+	3652.7	1.8	43 959402.9	1.9
22	22		Ti	$-\alpha$	-37548.6	0.7	8533.520	0.016	β^+	267.4	1.9	43 959690.0	0.8
21	23		V	x	-24120	180	8210	4	β^+	13430	180	43 974110	200
20	24		Cr	x	-13360#	300#	7948#	7#	β^+	10760#	350#	43 985660#	320#
19	25		Mn	x	7030#	500#	7467#	11#	β^+	20390#	580#	44 007550#	540#
31	14	45	Si	x	37490#	700#	6995#	16#	β^-	21890#	860#	45 040250#	750#
30	15		P	x	15600#	500#	7464#	11#	β^-	19590#	1150#	45 016750#	540#
29	16		S	x	-3990	1040	7882	23	β^-	14270	1040	44 995720	1110
28	17		Cl	x	-18260	140	8182	3	β^-	11510	140	44 980390	150
27	18		Ar	x	-29770.8	0.5	8419.952	0.011	β^-	6844.8	0.7	44 968039.7	0.6
26	19		K	x	-36615.6	0.5	8554.674	0.012	β^-	4196.5	0.6	44 960691.5	0.6
25	20		Ca		-40812.2	0.4	8630.545	0.008	β^-	259.7	0.7	44 956186.3	0.4
24	21		Sc		-41071.9	0.7	8618.931	0.015	*			44 955907.5	0.7
23	22		Ti		-39009.8	0.8	8555.722	0.019	β^+	2062.1	0.5	44 958121.2	0.9
22	23		V		-31886.0	0.9	8380.029	0.019	β^+	7123.82	0.21	44 965769.0	0.9
21	24		Cr	x	-19510	40	8087.7	0.8	β^+	12370	40	44 979050	40
20	25		Mn	x	-5250#	400#	7753#	9#	β^+	14270#	400#	44 994360#	430#
19	26		Fe	-pp	13760#	400#	7313#	9#	β^+	19010#	570#	45 014770#	430#

Table I. The 2012 Atomic mass table (continued, Explanation of Table on p. 030003-6)

<i>N</i>	<i>Z</i>	<i>A</i>	Elt.	Orig.	Mass excess (keV)		Binding energy per nucleon (keV)		Beta-decay energy (keV)		Atomic mass μ		
31	15	46	P	x	22970#	700#	7317#	15#	β^-	22630#	860#	46 024660#	750#
30	16		S	x	340#	500#	7792#	11#	β^-	14200#	540#	46 000370#	540#
29	17		Cl	x	-13860	210	8083	5	β^-	15910	210	45 985120	220
28	18		Ar	x	-29772.9	1.1	8412.419	0.024	β^-	5641.0	1.3	45 968037.4	1.2
27	19		K	x	-35413.9	0.7	8518.042	0.016	β^-	7725.4	2.4	45 961981.6	0.8
26	20		Ca		-43139.4	2.2	8668.98	0.05	β^-	-1378.1	2.3	45 953688.0	2.4
25	21		Sc	-n	-41761.2	0.7	8622.012	0.015	β^-	2366.6	0.7	45 955167.5	0.7
24	22		Ti		-44127.80	0.16	8656.451	0.004	*			45 952626.86	0.18
23	23		V		-37075.35	0.20	8486.130	0.004	β^+	7052.45	0.09	45 960197.97	0.22
22	24		Cr		-29472	11	8303.82	0.25	β^+	7604	11	45 968361	12
21	25		Mn	x	-12570#	400#	7919#	9#	β^+	16900#	400#	45 986510#	430#
20	26		Fe	x	910#	500#	7609#	11#	β^+	13480#	640#	46 000980#	540#
32	15	47	P	x	29710#	800#	7190#	17#	β^-	22340#	940#	47 031900#	860#
31	16		S	x	7370#	500#	7648#	11#	β^-	17150#	640#	47 007910#	540#
30	17		Cl	x	-9780#	400#	7996#	9#	β^-	15590#	400#	46 989500#	430#
29	18		Ar	x	-25366.3	1.1	8311.404	0.024	β^-	10345.6	1.8	46 972768.1	1.2
28	19		K	x	-35712.0	1.4	8514.879	0.030	β^-	6632.4	2.6	46 961661.6	1.5
27	20		Ca		-42344.4	2.2	8639.35	0.05	β^-	1992.2	1.2	46 954541.4	2.4
26	21		Sc		-44336.6	1.9	8665.09	0.04	β^-	600.8	1.9	46 952402.7	2.1
25	22		Ti		-44937.36	0.12	8661.227	0.003	*			46 951757.75	0.12
24	23		V		-42006.62	0.17	8582.225	0.004	β^+	2930.75	0.14	46 954904.04	0.18
23	24		Cr		-34563	6	8407.20	0.13	β^+	7444	6	46 962896	6
22	25		Mn	x	-22570	30	8135.3	0.7	β^+	12000	30	46 975770	30
21	26		Fe	x	-6870#	500#	7785#	11#	β^+	15700#	500#	46 992630#	540#
20	27		Co	x	10370#	600#	7401#	13#	β^+	17240#	780#	47 011130#	640#
32	16	48	S	x	12760#	600#	7545#	12#	β^-	17040#	780#	48 013700#	640#
31	17		Cl	x	-4280#	500#	7883#	10#	β^-	18000#	590#	47 995410#	540#
30	18		Ar	x	-22280	310	8242	6	β^-	10000	310	47 976080	330
29	19		K	x	-32284.5	0.8	8434.232	0.016	β^-	11940.2	0.8	47 965341.2	0.8
28	20		Ca		-44224.63	0.10	8666.686	0.002	β^-	279	5	47 952522.90	0.10
27	21		Sc		-44504	5	8656.20	0.10	β^-	3989	5	47 952223	5
26	22		Ti		-48492.71	0.11	8723.006	0.002	*			47 947940.93	0.12
25	23		V		-44477.7	1.0	8623.061	0.020	β^+	4015.0	1.0	47 952251.2	1.0
24	24		Cr	+nn	-42822	7	8572.27	0.15	β^+	1656	7	47 954029	8
23	25		Mn		-29296	7	8274.19	0.14	β^+	13526	10	47 968549	7
22	26		Fe	x	-18000#	400#	8023#	8#	β^+	11300#	400#	47 980680#	430#
21	27		Co	x	1500#	500#	7600#	10#	β^+	19500#	640#	48 001610#	540#
20	28		Ni	-pp	16790#	500#	7265#	10#	β^+	15290#	710#	48 018030#	540#
33	16	49	S	-n	21090#	670#	7385#	14#	β^-	20150#	900#	49 022640#	720#
32	17		Cl	x	940#	600#	7781#	12#	β^-	18130#	720#	49 001010#	640#
31	18		Ar	x	-17190#	400#	8135#	8#	β^-	12420#	400#	48 981550#	430#
30	19		K	x	-29611.5	0.8	8372.274	0.016	β^-	11688.3	0.8	48 968210.8	0.9
29	20		Ca	-n	-41299.77	0.20	8594.844	0.004	β^-	5261.5	2.7	48 955662.88	0.22
28	21		Sc		-46561.3	2.7	8686.26	0.06	β^-	2002.5	2.7	48 950014.4	2.9
27	22		Ti		-48563.79	0.11	8711.157	0.002	*			48 947864.63	0.12
26	23		V	-	-47961.9	0.8	8682.908	0.017	β^+	601.9	0.8	48 948510.7	0.9
25	24		Cr		-45333.1	2.2	8613.29	0.05	β^+	2628.9	2.4	48 951333.0	2.4
24	25		Mn		-37620.6	2.3	8439.93	0.05	β^+	7712.43	0.23	48 959612.6	2.4
23	26		Fe	x	-24751	24	8161.3	0.5	β^+	12870	24	48 973429	26
22	27		Co	x	-9880#	500#	7842#	10#	β^+	14870#	500#	48 989390#	540#
21	28		Ni	x	8200#	600#	7457#	12#	β^+	18080#	780#	49 008800#	640#

Table I. The 2012 Atomic mass table (continued, Explanation of Table on p. 030003-6)

<i>N</i>	<i>Z</i>	<i>A</i>	Elt.	Orig.	Mass excess (keV)		Binding energy per nucleon (keV)		Beta-decay energy (keV)		Atomic mass μ		
33	17	50	Cl	x	7740#	600#	7651#	12#	β^-	21070#	780#	50 008310#	640#
32	18		Ar	x	-13330#	500#	8056#	10#	β^-	12400#	500#	49 985690#	540#
31	19		K	x	-25728	8	8288.58	0.15	β^-	13861	8	49 972380	8
30	20		Ca	x	-39589.2	1.6	8550.16	0.03	β^-	4958	15	49 957499.2	1.7
29	21		Sc	-pn	-44547	15	8633.7	0.3	β^-	6884	15	49 952176	16
28	22		Ti		-51431.66	0.12	8755.718	0.002	β^-	-2207.6	0.4	49 944785.84	0.13
27	23		V	+n	-49224.0	0.4	8695.918	0.008	β^-	1038.06	0.30	49 947155.8	0.4
26	24		Cr		-50262.1	0.4	8701.032	0.009	*			49 946041.4	0.5
25	25		Mn		-42627.6	0.4	8532.696	0.009	β^+	7634.48	0.07	49 954237.4	0.5
24	26		Fe	x	-34476	8	8354.03	0.17	β^+	8151	8	49 962988	9
23	27		Co	x	-17630#	400#	8001#	8#	β^+	16850#	400#	49 981070#	430#
22	28		Ni	x	-4120#	500#	7716#	10#	β^+	13510#	640#	49 995580#	540#
34	17	51	Cl	x	14290#	700#	7530#	14#	β^-	20980#	920#	51 015340#	750#
33	18		Ar	x	-6690#	600#	7926#	12#	β^-	15830#	600#	50 992820#	640#
32	19		K	x	-22516	13	8221.35	0.26	β^-	13816	13	50 975828	14
31	20		Ca	x	-36332.3	0.5	8476.913	0.010	β^-	6896	20	50 960995.7	0.6
30	21		Sc	-p2n	-43229	20	8596.8	0.4	β^-	6504	20	50 953592	21
29	22		Ti	-n	-49732.8	0.5	8708.988	0.010	β^-	2471.0	0.6	50 946609.6	0.5
28	23		V		-52203.8	0.4	8742.099	0.008	*			50 943956.9	0.4
27	24		Cr		-51451.4	0.4	8712.005	0.008	β^+	752.45	0.21	50 944764.7	0.4
26	25		Mn		-48243.9	0.5	8633.772	0.010	β^+	3207.5	0.3	50 948208.1	0.5
25	26		Fe		-40203	9	8460.76	0.18	β^+	8041	9	50 956841	10
24	27		Co	x	-27340	50	8193.3	0.9	β^+	12860	50	50 970650	50
23	28		Ni	x	-11900#	500#	7875#	10#	β^+	15440#	500#	50 987230#	540#
34	18	52	Ar	x	-1280#	600#	7825#	12#	β^-	15860#	600#	51 998630#	640#
33	19		K	x	-17140	30	8115.0	0.6	β^-	17130	30	51 981600	40
32	20		Ca	x	-34266.3	0.7	8429.381	0.013	β^-	6180	80	51 963213.6	0.7
31	21		Sc	x	-40440	80	8533.1	1.6	β^-	9030	80	51 956580	90
30	22		Ti	-nn	-49470	7	8691.67	0.14	β^-	1974	7	51 946892	8
29	23		V	-n	-51443.8	0.4	8714.582	0.008	β^-	3975.5	0.5	51 944772.8	0.5
28	24		Cr		-55419.2	0.3	8775.989	0.007	*			51 940505.0	0.4
27	25		Mn		-50707.3	1.8	8670.33	0.04	β^+	4712.0	1.9	51 945563.5	2.0
26	26		Fe		-48330	5	8609.57	0.10	β^+	2377	5	51 948115	5
25	27		Co	x	-34361	8	8325.89	0.16	β^+	13969	10	51 963112	9
24	28		Ni	x	-22330#	400#	8079#	8#	β^+	12030#	400#	51 976030#	430#
23	29		Cu	x	-2280#	600#	7679#	12#	β^+	20050#	720#	51 997550#	640#
35	18	53	Ar	x	6790#	700#	7677#	13#	β^-	19090#	710#	53 007290#	750#
34	19		K	x	-12300	110	8022.8	2.1	β^-	17090	120	52 986800	120
33	20		Ca	x	-29390	40	8330.6	0.8	β^-	9520	100	52 968450	50
32	21		Sc	x	-38910	90	8495.4	1.8	β^-	7920	140	52 958230	100
31	22		Ti	+	-46830	100	8630.2	1.9	β^-	5020	100	52 949720	110
30	23		V	+p	-51851	3	8710.13	0.06	β^-	3436	3	52 944336	3
29	24		Cr		-55287.0	0.3	8760.198	0.007	*			52 940647.0	0.4
28	25		Mn		-54690.1	0.5	8734.175	0.009	β^+	596.9	0.4	52 941287.7	0.5
27	26		Fe		-50947.5	1.7	8648.80	0.03	β^+	3742.6	1.7	52 945305.6	1.8
26	27		Co		-42659.4	1.7	8477.66	0.03	β^+	8288.1	0.4	52 954203.2	1.8
25	28		Ni	x	-29631	25	8217.1	0.5	β^+	13029	25	52 968190	27
24	29		Cu	x	-13270#	500#	7894#	9#	β^+	16360#	500#	52 985750#	540#

Table I. The 2012 Atomic mass table (continued, Explanation of Table on p. 030003-6)

<i>N</i>	<i>Z</i>	<i>A</i>	Elt.	Orig.	Mass excess (keV)		Binding energy per nucleon (keV)		Beta-decay energy (keV)		Atomic mass μ u		
35	19	54	K	x	-5000#	600#	7889#	11#	β^-	20160#	600#	53 994630#	640#
34	20		Ca	x	-25160	50	8247.5	0.9	β^-	8730	280	53 972990	50
33	21		Sc	x	-33890	270	8395	5	β^-	11730	280	53 963620	290
32	22		Ti	x	-45620	80	8597.4	1.5	β^-	4270	80	53 951020	90
31	23		V	+	-49893	15	8662.04	0.28	β^-	7042	15	53 946437	16
30	24		Cr		-56934.8	0.4	8777.955	0.007	β^-	-1377.1	1.0	53 938878.0	0.4
29	25		Mn	-p	-55557.6	1.1	8737.965	0.020	β^-	696.9	1.1	53 940356.4	1.1
28	26		Fe		-56254.5	0.4	8736.382	0.007	*			53 939608.3	0.4
27	27		Co		-48010.0	0.4	8569.217	0.007	β^+	8244.55	0.09	53 948459.2	0.4
26	28		Ni	x	-39278	5	8393.03	0.09	β^+	8732	5	53 957833	5
25	29		Cu	x	-21410#	400#	8048#	7#	β^+	17870#	400#	53 977020#	430#
24	30		Zn	-pp	-6270#	400#	7753#	7#	β^+	15140#	570#	53 993270#	430#
36	19	55	K	x	710#	700#	7788#	13#	β^-	19060#	760#	55 000760#	750#
35	20		Ca	x	-18350#	300#	8120#	5#	β^-	11810#	540#	54 980300#	320#
34	21		Sc	x	-30160	450	8321	8	β^-	11510	480	54 967620	490
33	22		Ti		-41670	160	8516.0	2.9	β^-	7480	160	54 955270	170
32	23		V		-49140	100	8637.7	1.7	β^-	5970	100	54 947240	100
31	24		Cr		-55109.7	0.4	8731.924	0.007	β^-	2602.7	0.4	54 940837.3	0.4
30	25		Mn		-57712.4	0.3	8765.022	0.006	*			54 938043.2	0.3
29	26		Fe		-57481.3	0.3	8746.595	0.006	β^+	231.11	0.18	54 938291.3	0.4
28	27		Co		-54029.9	0.4	8669.618	0.008	β^+	3451.4	0.3	54 941996.5	0.5
27	28		Ni	-	-45335.8	0.7	8497.320	0.013	β^+	8694.0	0.6	54 951330.0	0.8
26	29		Cu	x	-31640	160	8234.0	2.8	β^+	13700	160	54 966040	170
25	30		Zn	x	-14570#	400#	7909#	7#	β^+	17070#	430#	54 984360#	430#
37	19	56	K	x	7930#	800#	7664#	14#	β^-	21830#	900#	56 008510#	860#
36	20		Ca	x	-13900#	400#	8040#	7#	β^-	10950#	710#	55 985080#	430#
35	21		Sc	x	-24850	590	8222	10	β^-	14470	600	55 973320	630
34	22		Ti		-39320	120	8466.1	2.2	β^-	6830	190	55 957790	130
33	23		V		-46150	180	8574	3	β^-	9130	180	55 950450	190
32	24		Cr	++	-55285.0	0.6	8723.258	0.011	β^-	1626.5	0.6	55 940649.1	0.6
31	25		Mn	-n	-56911.5	0.3	8738.333	0.006	β^-	3695.54	0.21	55 938902.9	0.4
30	26		Fe		-60607.1	0.3	8790.354	0.005	*			55 934935.6	0.3
29	27		Co		-56040.4	0.5	8694.836	0.009	β^+	4566.7	0.4	55 939838.2	0.5
28	28		Ni		-53907.5	0.4	8642.779	0.008	β^+	2132.9	0.4	55 942127.9	0.5
27	29		Cu	x	-38643	15	8356.23	0.27	β^+	15265	15	55 958515	16
26	30		Zn	x	-25390#	400#	8106#	7#	β^+	13250#	400#	55 972740#	430#
25	31		Ga	x	-3390#	500#	7699#	9#	β^+	22000#	640#	55 996360#	540#
37	20	57	Ca	x	-6870#	400#	7917#	7#	β^-	14120#	1360#	56 992620#	430#
36	21		Sc	x	-21000	1300	8151	23	β^-	12920	1330	56 977460	1400
35	22		Ti	x	-33920	260	8364	4	β^-	10500	270	56 963590	280
34	23		V	x	-44410	80	8534.8	1.4	β^-	8110	80	56 952320	90
33	24		Cr	x	-52524.7	1.1	8663.394	0.019	β^-	4961.5	1.8	56 943612.4	1.1
32	25		Mn		-57486.3	1.5	8736.713	0.026	β^-	2695.6	1.5	56 938286.0	1.6
31	26		Fe		-60181.8	0.3	8770.279	0.005	*			56 935392.1	0.3
30	27		Co		-59345.6	0.5	8741.882	0.009	β^+	836.3	0.5	56 936289.9	0.6
29	28		Ni		-56083.8	0.6	8670.933	0.010	β^+	3261.7	0.6	56 939791.5	0.6
28	29		Cu		-47308.9	0.5	8503.262	0.009	β^+	8774.9	0.4	56 949211.8	0.6
27	30		Zn	x	-32550#	200#	8231#	4#	β^+	14760#	200#	56 965060#	220#
26	31		Ga	x	-15010#	400#	7909#	7#	β^+	17540#	450#	56 983890#	430#

Table I. The 2012 Atomic mass table (continued, Explanation of Table on p. 030003-6)

<i>N</i>	<i>Z</i>	<i>A</i>	Elt.	Orig.	Mass excess (keV)		Binding energy per nucleon (keV)		Beta-decay energy (keV)		Atomic mass μ u		
38	20	58	Ca	x	-1920#	500#	7835#	9#	β^-	12960#	640#	57 997940#	540#
37	21		Sc	x	-14880#	400#	8045#	7#	β^-	16230#	450#	57 984030#	430#
36	22		Ti	x	-31110#	200#	8311#	3#	β^-	9290#	220#	57 966600#	220#
35	23		V	x	-40400	90	8457.7	1.5	β^-	11590	90	57 956630	100
34	24		Cr	x	-51991.8	1.5	8643.998	0.026	β^-	3836	3	57 944184.5	1.6
33	25		Mn	x	-55827.6	2.7	8696.64	0.05	β^-	6327.6	2.7	57 940066.6	2.9
32	26		Fe		-62155.1	0.3	8792.250	0.006	β^-	-2308.0	1.1	57 933273.7	0.4
31	27		Co		-59847.2	1.2	8738.969	0.020	β^-	381.6	1.1	57 935751.4	1.2
30	28		Ni		-60228.7	0.4	8732.059	0.006		*		57 935341.8	0.4
29	29		Cu		-51667.7	0.6	8570.967	0.010	β^+	8561.0	0.4	57 944532.4	0.6
28	30		Zn	---	-42300	50	8395.9	0.9	β^+	9370	50	57 954590	50
27	31		Ga	x	-23540#	300#	8059#	5#	β^+	18760#	300#	57 974730#	320#
26	32		Ge	x	-7080#	500#	7762#	9#	β^+	16460#	580#	57 992400#	540#
38	21	59	Sc	x	-10300#	400#	7967#	7#	β^-	15210#	450#	58 988940#	430#
37	22		Ti	x	-25510#	200#	8212#	3#	β^-	12320#	260#	58 972610#	220#
36	23		V	x	-37830	160	8407.6	2.7	β^-	10250	270	58 959390	170
35	24		Cr	x	-48090	220	8568	4	β^-	7440	220	58 948380	230
34	25		Mn	x	-55525.3	2.3	8680.92	0.04	β^-	5139.5	2.4	58 940391.1	2.5
33	26		Fe		-60664.8	0.4	8754.771	0.006	β^-	1564.9	0.4	58 934873.6	0.4
32	27		Co		-62229.7	0.4	8768.035	0.007		*		58 933193.7	0.4
31	28		Ni		-61156.7	0.4	8736.588	0.006	β^+	1073.00	0.19	58 934345.6	0.4
30	29		Cu		-56358.3	0.5	8642.000	0.009	β^+	4798.4	0.4	58 939496.8	0.6
29	30		Zn		-47215.6	0.8	8473.777	0.013	β^+	9142.8	0.6	58 949312.0	0.8
28	31		Ga	x	-33760#	170#	8232#	3#	β^+	13460#	170#	58 963760#	180#
27	32		Ge	x	-15870#	400#	7916#	7#	β^+	17890#	430#	58 982960#	430#
39	21	60	Sc	x	-4050#	500#	7865#	8#	β^-	18280#	580#	59 995650#	540#
38	22		Ti	x	-22330#	300#	8157#	5#	β^-	10910#	370#	59 976030#	320#
37	23		V	x	-33240	220	8325	4	β^-	13430	290	59 964310	240
36	24		Cr	x	-46670	190	8536	3	β^-	6300	190	59 949900	210
35	25		Mn	x	-52967.9	2.3	8628.14	0.04	β^-	8445	4	59 943136.6	2.5
34	26		Fe	-nn	-61413	3	8755.85	0.06	β^-	237	3	59 934070	4
33	27		Co	-n	-61650.3	0.4	8746.766	0.007	β^-	2822.81	0.21	59 933815.7	0.5
32	28		Ni		-64473.1	0.4	8780.774	0.006		*		59 930785.3	0.4
31	29		Cu	-	-58345.1	1.6	8665.602	0.027	β^+	6128.0	1.6	59 937363.9	1.7
30	30		Zn		-54174.3	0.6	8583.050	0.009	β^+	4170.8	1.6	59 941841.5	0.6
29	31		Ga	x	-39590#	200#	8327#	3#	β^+	14580#	200#	59 957500#	220#
28	32		Ge	x	-27090#	300#	8106#	5#	β^+	12500#	360#	59 970920#	320#
27	33		As	x	-5470#	400#	7732#	7#	β^+	21620#	500#	59 994130#	430#
40	21	61	Sc	x	930#	600#	7787#	10#	β^-	17280#	720#	61 001000#	640#
39	22		Ti	x	-16350#	400#	8057#	7#	β^-	14160#	980#	60 982450#	430#
38	23		V	x	-30510	890	8276	15	β^-	11970	900	60 967250	960
37	24		Cr	x	-42480	100	8459.8	1.7	β^-	9270	100	60 954400	110
36	25		Mn	x	-51742.1	2.3	8598.91	0.04	β^-	7178	3	60 944452.5	2.5
35	26		Fe	x	-58920.5	2.6	8703.77	0.04	β^-	3977.6	2.7	60 936746.2	2.8
34	27		Co	p2n	-62898.1	0.8	8756.148	0.014	β^-	1323.8	0.8	60 932476.1	0.9
33	28		Ni		-64221.9	0.4	8765.025	0.006		*		60 931054.9	0.4
32	29		Cu	p2n	-61984.1	1.0	8715.514	0.016	β^+	2237.8	1.0	60 933457.4	1.0
31	30		Zn		-56349	16	8610.31	0.26	β^+	5635	16	60 939507	17
30	31		Ga		-47130	40	8446.4	0.6	β^+	9210	40	60 949400	40
29	32		Ge	x	-33360#	300#	8208#	5#	β^+	13780#	300#	60 964190#	320#
28	33		As	x	-16900#	300#	7925#	5#	β^+	16460#	420#	60 981860#	320#

Table I. The 2012 Atomic mass table (continued, Explanation of Table on p. 030003-6)

<i>N</i>	<i>Z</i>	<i>A</i>	Elt.	Orig.	Mass excess (keV)		Binding energy per nucleon (keV)		Beta-decay energy (keV)		Atomic mass μ u		
40	22	62	Ti	x	-12500#	400#	7995#	6#	β^-	12980#	500#	61 986580#	430#
39	23		V	x	-25480#	300#	8192#	5#	β^-	15420#	330#	61 972650#	320#
38	24		Cr	x	-40890	150	8428.1	2.4	β^-	7630	150	61 956100	160
37	25		Mn	IT	-48524	7	8538.50	0.11	β^-	10354	7	61 947907	7
36	26		Fe	x	-58878.0	2.8	8692.88	0.05	β^-	2546	19	61 936792	3
35	27		Co	+	-61424	19	8721.33	0.30	β^-	5322	19	61 934058	20
34	28		Ni		-66746.3	0.4	8794.553	0.007		*		61 928344.9	0.5
33	29		Cu	-	-62787.4	0.6	8718.081	0.010	β^+	3958.9	0.5	61 932594.9	0.7
32	30		Zn		-61168.0	0.6	8679.343	0.010	β^+	1619.5	0.7	61 934333.5	0.7
31	31		Ga		-51986.9	0.6	8518.642	0.010	β^+	9181.1	0.4	61 944189.8	0.7
30	32		Ge	x	-41740#	140#	8341#	2#	β^+	10250#	140#	61 955190#	150#
29	33		As	x	-24320#	300#	8047#	5#	β^+	17420#	330#	61 973890#	320#
41	22	63	Ti	x	-5750#	500#	7889#	8#	β^-	16140#	640#	62 993830#	540#
40	23		V	x	-21890#	400#	8133#	6#	β^-	14120#	540#	62 976500#	430#
39	24		Cr	x	-36010	360	8345	6	β^-	10880	360	62 961340	380
38	25		Mn	x	-46887	4	8505.10	0.06	β^-	8749	6	62 949665	4
37	26		Fe		-55636	4	8631.55	0.07	β^-	6216	19	62 940273	5
36	27		Co		-61851	19	8717.79	0.29	β^-	3661	19	62 933600	20
35	28		Ni		-65512.8	0.4	8763.493	0.007	β^-	66.977	0.015	62 929669.1	0.5
34	29		Cu		-65579.8	0.4	8752.138	0.007		*		62 929597.2	0.5
33	30		Zn		-62213.4	1.6	8686.285	0.025	β^+	3366.4	1.5	62 933211.2	1.7
32	31		Ga	x	-56547.1	1.3	8583.926	0.021	β^+	5666.3	2.0	62 939294.2	1.4
31	32		Ge	x	-46920	40	8418.7	0.6	β^+	9630	40	62 949630	40
30	33		As	x	-33500#	200#	8193#	3#	β^+	13420#	200#	62 964040#	220#
42	22	64	Ti	x	-1030#	600#	7818#	9#	β^-	15300#	720#	63 998900#	640#
41	23		V	x	-16320#	400#	8045#	6#	β^-	17160#	590#	63 982480#	430#
40	24		Cr	x	-33480	440	8301	7	β^-	9510	440	63 964060	470
39	25		Mn	x	-42989	4	8437.42	0.06	β^-	11981	6	63 953849	4
38	26		Fe	x	-54970	5	8612.39	0.08	β^-	4823	21	63 940988	5
37	27		Co	+	-59792	20	8675.5	0.3	β^-	7307	20	63 935810	21
36	28		Ni		-67098.9	0.5	8777.461	0.007	β^-	-1674.38	0.23	63 927966.3	0.5
35	29		Cu		-65424.5	0.4	8739.075	0.007	β^-	579.5	0.6	63 929763.9	0.5
34	30		Zn		-66004.0	0.6	8735.905	0.010		*		63 929141.8	0.7
33	31		Ga		-58832.8	1.4	8611.631	0.022	β^+	7171.2	1.5	63 936840.4	1.5
32	32		Ge	x	-54315	4	8528.82	0.06	β^+	4517	4	63 941690	4
31	33		As	-p	-39530#	200#	8286#	3#	β^+	14780#	200#	63 957560#	220#
30	34		Se	x	-26700#	500#	8073#	8#	β^+	12830#	540#	63 971340#	540#
42	23	65	V	x	-11780#	500#	7976#	8#	β^-	16440#	580#	64 987350#	540#
41	24		Cr	x	-28220#	300#	8217#	5#	β^-	12750#	300#	64 969710#	320#
40	25		Mn	x	-40967	4	8400.68	0.06	β^-	10251	6	64 956020	4
39	26		Fe	x	-51218	5	8546.35	0.08	β^-	7967	6	64 945015	5
38	27		Co	x	-59185.2	2.1	8656.88	0.03	β^-	5940.5	2.1	64 936462.1	2.2
37	28		Ni	-n	-65125.7	0.5	8736.240	0.008	β^-	2138.0	0.7	64 930084.7	0.5
36	29		Cu		-67263.7	0.6	8757.096	0.010		*		64 927789.5	0.7
35	30		Zn		-65912.0	0.6	8724.265	0.010	β^+	1351.6	0.4	64 929240.5	0.7
34	31		Ga		-62657.5	0.8	8662.160	0.013	β^+	3254.5	0.7	64 932734.4	0.9
33	32		Ge		-56478.2	2.2	8555.06	0.03	β^+	6179.3	2.3	64 939368.1	2.3
32	33		As	x	-46940	80	8396.2	1.3	β^+	9540	80	64 949610	90
31	34		Se	x	-33020#	300#	8170#	5#	β^+	13920#	310#	64 964550#	320#

Table I. The 2012 Atomic mass table (continued, Explanation of Table on p. 030003-6)

<i>N</i>	<i>Z</i>	<i>A</i>	Elt.	Orig.	Mass excess (keV)		Binding energy per nucleon (keV)		Beta-decay energy (keV)		Atomic mass μ u		
43	23	66	V	x	-5610#	500#	7884#	8#	β^-	19110#	640#	65 993980#	540#
42	24		Cr	x	-24720#	400#	8161#	6#	β^-	12030#	400#	65 973460#	430#
41	25		Mn	x	-36750	11	8331.80	0.17	β^-	13317	12	65 960547	12
40	26		Fe	x	-50068	4	8521.72	0.06	β^-	6341	15	65 946250	4
39	27		Co	x	-56409	14	8605.94	0.21	β^-	9598	14	65 939443	15
38	28		Ni	x	-66006.3	1.4	8739.508	0.021	β^-	252.0	1.5	65 929139.3	1.5
37	29		Cu		-66258.3	0.7	8731.472	0.010	β^-	2640.9	0.9	65 928868.8	0.7
36	30		Zn		-68899.2	0.7	8759.632	0.011	*			65 926033.7	0.8
35	31		Ga	—	-63723.7	1.1	8669.361	0.017	β^+	5175.5	0.8	65 931589.8	1.2
34	32		Ge	x	-61607.0	2.4	8625.44	0.04	β^+	2116.6	2.6	65 933862.1	2.6
33	33		As	x	-52025	6	8468.40	0.09	β^+	9582	6	65 944149	6
32	34		Se	x	-41660#	200#	8300#	3#	β^+	10370#	200#	65 955280#	220#
44	23	67	V	x	-650#	600#	7812#	9#	β^-	18030#	720#	66 999300#	640#
43	24		Cr	x	-18680#	400#	8070#	6#	β^-	14780#	500#	66 979950#	430#
42	25		Mn	x	-33460#	300#	8279#	4#	β^-	12150#	400#	66 964080#	320#
41	26		Fe	x	-45610	270	8448	4	β^-	9710	270	66 951040	290
40	27		Co	x	-55322	6	8581.74	0.10	β^-	8421	7	66 940610	7
39	28		Ni	x	-63742.7	2.9	8695.75	0.04	β^-	3577	3	66 931569	3
38	29		Cu		-67319.5	0.9	8737.458	0.013	β^-	560.8	0.8	66 927729.5	1.0
37	30		Zn		-67880.3	0.8	8734.152	0.011	*			66 927127.5	0.8
36	31		Ga		-66879.0	1.2	8707.531	0.018	β^+	1001.3	1.1	66 928202.4	1.3
35	32		Ge	-n2p	-62658	5	8632.86	0.07	β^+	4221	5	66 932734	5
34	33		As		-56587.2	0.4	8530.568	0.007	β^+	6071	5	66 939251.1	0.5
33	34		Se	x	-46580	70	8369.5	1.0	β^+	10010	70	66 949990	70
32	35		Br	x	-32790#	400#	8152#	6#	β^+	13790#	410#	66 964800#	430#
44	24	68	Cr	x	-14800#	500#	8013#	7#	β^-	13580#	640#	67 984110#	540#
43	25		Mn	x	-28380#	400#	8201#	6#	β^-	15110#	540#	67 969530#	430#
42	26		Fe	x	-43490	370	8412	5	β^-	8440	410	67 953310	390
41	27		Co	x	-51930	190	8524.4	2.8	β^-	11530	190	67 944250	200
40	28		Ni	x	-63463.8	3.0	8682.47	0.04	β^-	2103	3	67 931869	3
39	29		Cu	x	-65567.0	1.6	8701.890	0.023	β^-	4440.1	1.8	67 929610.9	1.7
38	30		Zn		-70007.1	0.8	8755.680	0.012	*			67 924844.3	0.8
37	31		Ga	—	-67086.0	1.4	8701.218	0.021	β^+	2921.1	1.2	67 927980.2	1.5
36	32		Ge	x	-66978.8	1.9	8688.136	0.028	β^+	107.2	2.4	67 928095.3	2.0
35	33		As		-58894.5	1.8	8557.745	0.027	β^+	8084.3	2.6	67 936774.1	2.0
34	34		Se	x	-54189.4	0.5	8477.047	0.007	β^+	4705.1	1.9	67 941825.2	0.5
33	35		Br	-p	-38790#	260#	8239#	4#	β^+	15400#	260#	67 958360#	280#
45	24	69	Cr	x	-8580#	500#	7924#	7#	β^-	16190#	640#	68 990790#	540#
44	25		Mn	x	-24770#	400#	8147#	6#	β^-	14260#	570#	68 973410#	430#
43	26		Fe	x	-39030#	400#	8342#	6#	β^-	11250#	420#	68 958100#	430#
42	27		Co	x	-50280	140	8493.9	2.0	β^-	9700	140	68 946020	150
41	28		Ni	x	-59979	4	8623.10	0.05	β^-	5758	4	68 935610	4
40	29		Cu	x	-65736.2	1.4	8695.204	0.020	β^-	2681.6	1.6	68 929429.3	1.5
39	30		Zn	-n	-68417.8	0.8	8722.729	0.012	β^-	910.0	1.4	68 926550.4	0.9
38	31		Ga		-69327.8	1.2	8724.579	0.017	*			68 925573.5	1.3
37	32		Ge		-67100.7	1.3	8680.963	0.019	β^+	2227.1	0.5	68 927964.5	1.4
36	33		As		-63110	30	8611.8	0.5	β^+	3990	30	68 932250	30
35	34		Se		-56434.7	1.5	8503.707	0.022	β^+	6680	30	68 939414.8	1.6
34	35		Br	-p	-46260	40	8344.9	0.6	β^+	10180	40	68 950340	50
33	36		Kr	x	-32440#	400#	8133#	6#	β^+	13830#	400#	68 965180#	430#

Table I. The 2012 Atomic mass table (continued, Explanation of Table on p. 030003-6)

<i>N</i>	<i>Z</i>	<i>A</i>	Elt.	Orig.	Mass excess (keV)		Binding energy per nucleon (keV)		Beta-decay energy (keV)		Atomic mass μ		
46	24	70	Cr	x	-4480#	600#	7867#	9#	β^-	15020#	780#	69 995190#	640#
45	25		Mn	x	-19500#	500#	8070#	7#	β^-	17010#	640#	69 979070#	540#
44	26		Fe	x	-36510#	400#	8302#	6#	β^-	10120#	500#	69 960810#	430#
43	27		Co	x	-46630#	300#	8436#	4#	β^-	12580#	300#	69 949940#	320#
42	28		Ni	x	-59213.9	2.1	8604.29	0.03	β^-	3762.5	2.4	69 936431.3	2.3
41	29		Cu	x	-62976.4	1.1	8646.865	0.015	β^-	6588.4	2.2	69 932392.1	1.2
40	30		Zn		-69564.7	1.9	8729.808	0.027	β^-	-654.6	1.6	69 925319.2	2.1
39	31		Ga		-68910.1	1.2	8709.280	0.017	β^-	1651.7	1.5	69 926021.9	1.3
38	32		Ge		-70561.9	0.8	8721.700	0.012		*		69 924248.7	0.9
37	33		As	-	-64340	50	8621.7	0.7	β^+	6220	50	69 930930	50
36	34		Se	x	-61929.9	1.6	8576.033	0.023	β^+	2410	50	69 933515.5	1.7
35	35		Br	x	-51426	15	8414.80	0.21	β^+	10504	15	69 944792	16
34	36		Kr	x	-41100#	200#	8256#	3#	β^+	10330#	200#	69 955880#	220#
46	25	71	Mn	x	-15570#	500#	8015#	7#	β^-	15860#	640#	70 983290#	540#
45	26		Fe	x	-31430#	400#	8227#	6#	β^-	12940#	610#	70 966260#	430#
44	27		Co	x	-44370	470	8399	7	β^-	11040	470	70 952370	500
43	28		Ni	x	-55406.2	2.2	8543.16	0.03	β^-	7304.9	2.7	70 940519.0	2.4
42	29		Cu	x	-62711.1	1.5	8635.022	0.021	β^-	4618	3	70 932676.8	1.6
41	30		Zn		-67328.8	2.7	8689.04	0.04	β^-	2810.4	2.8	70 927719.6	2.8
40	31		Ga		-70139.1	0.8	8717.604	0.011		*		70 924702.5	0.9
39	32		Ge		-69906.5	0.8	8703.309	0.012	β^+	232.64	0.22	70 924952.3	0.9
38	33		As	-	-67893	4	8663.93	0.06	β^+	2013	4	70 927114	4
37	34		Se	x	-63146.5	2.8	8586.06	0.04	β^+	4747	5	70 932209	3
36	35		Br		-56502	5	8481.46	0.08	β^+	6644	6	70 939342	6
35	36		Kr		-46330	130	8327.1	1.8	β^+	10180	130	70 950270	140
34	37		Rb	x	-32060#	400#	8115#	6#	β^+	14270#	420#	70 965580#	430#
47	25	72	Mn	x	-9900#	600#	7937#	8#	β^-	18530#	780#	71 989370#	640#
46	26		Fe	x	-28430#	500#	8184#	7#	β^-	11770#	640#	71 969480#	540#
45	27		Co	x	-40200#	400#	8336#	6#	β^-	14030#	400#	71 956840#	430#
44	28		Ni	x	-54226.1	2.2	8520.21	0.03	β^-	5556.9	2.6	71 941785.9	2.4
43	29		Cu	x	-59783.0	1.4	8586.525	0.019	β^-	8362.5	2.6	71 935820.3	1.5
42	30		Zn	x	-68145.5	2.1	8691.805	0.030	β^-	442.8	2.3	71 926842.8	2.3
41	31		Ga		-68588.3	0.8	8687.089	0.011	β^-	3997.6	0.8	71 926367.4	0.9
40	32		Ge		-72585.90	0.08	8731.745	0.001		*		71 922075.83	0.08
39	33		As	-	-68230	4	8660.38	0.06	β^+	4356	4	71 926752	4
38	34		Se	x	-67868.2	2.0	8644.489	0.027	β^+	362	5	71 927140.5	2.1
37	35		Br	x	-59061.7	1.0	8511.312	0.014	β^+	8806.4	2.2	71 936594.6	1.1
36	36		Kr	x	-53941	8	8429.32	0.11	β^+	5121	8	71 942092	9
35	37		Rb	x	-38330#	500#	8202#	7#	β^+	15610#	500#	71 958850#	540#
47	26	73	Fe	x	-22900#	500#	8106#	7#	β^-	14520#	640#	72 975420#	540#
46	27		Co	x	-37420#	400#	8295#	5#	β^-	12690#	400#	72 959830#	430#
45	28		Ni	x	-50108.2	2.4	8457.65	0.03	β^-	8879	3	72 946206.7	2.6
44	29		Cu		-58987.4	1.9	8568.569	0.027	β^-	6606.0	2.7	72 936674.4	2.1
43	30		Zn	x	-65593.4	1.9	8648.345	0.026	β^-	4105.9	2.5	72 929582.6	2.0
42	31		Ga	x	-69699.3	1.7	8693.873	0.023	β^-	1598.2	1.7	72 925174.7	1.8
41	32		Ge		-71297.52	0.06	8705.049	0.001		*		72 923458.96	0.06
40	33		As		-70953	4	8689.61	0.05	β^+	345	4	72 923829	4
39	34		Se		-68227	7	8641.56	0.10	β^+	2725	7	72 926755	8
38	35		Br	x	-63647	7	8568.10	0.10	β^+	4580	10	72 931672	8
37	36		Kr	x	-56552	7	8460.18	0.09	β^+	7096	10	72 939289	7
36	37		Rb	-p	-46080#	200#	8306#	3#	β^+	10470#	200#	72 950530#	220#
35	38		Sr	x	-31950#	400#	8102#	5#	β^+	14130#	450#	72 965700#	430#

Table I. The 2012 Atomic mass table (continued, Explanation of Table on p. 030003-6)

<i>N</i>	<i>Z</i>	<i>A</i>	Elt.	Orig.	Mass excess (keV)		Binding energy per nucleon (keV)		Beta-decay energy (keV)		Atomic mass μ		
48	26	74	Fe	x	-19590#	600#	8061#	8#	β^-	13230#	780#	73 978970#	640#
47	27		Co	x	-32820#	500#	8229#	7#	β^-	15640#	540#	73 964770#	540#
46	28		Ni	x	-48460#	200#	8430#	3#	β^-	7550#	200#	73 947980#	210#
45	29		Cu	x	-56006	6	8521.56	0.08	β^-	9751	7	73 939875	7
44	30		Zn	x	-65756.7	2.5	8642.75	0.03	β^-	2293	4	73 929407.3	2.7
43	31		Ga	x	-68049.6	3.0	8663.17	0.04	β^-	5372.8	3.0	73 926946	3
42	32		Ge		-73422.442	0.013	8725.200	<i>a</i>	β^-	-2562.4	1.7	73 921177.762	0.013
41	33		As		-70860.1	1.7	8680.001	0.023	β^-	1353.1	1.7	73 923928.6	1.8
40	34		Se		-72213.201	0.015	8687.715	<i>a</i>	*			73 922475.935	0.016
39	35		Br		-65288	6	8583.56	0.08	β^+	6925	6	73 929910	6
38	36		Kr		-62331.8	2.0	8533.038	0.027	β^+	2956	6	73 933084.0	2.2
37	37		Rb		-51916	3	8381.71	0.04	β^+	10416	3	73 944266	3
36	38		Sr	x	-40830#	100#	8221#	1#	β^+	11090#	100#	73 956170#	110#
49	26	75	Fe	x	-13640#	600#	7982#	8#	β^-	16010#	780#	74 985360#	640#
48	27		Co	x	-29650#	500#	8185#	7#	β^-	14380#	580#	74 968170#	540#
47	28		Ni	x	-44030#	300#	8366#	4#	β^-	10440#	300#	74 952730#	320#
46	29		Cu	x	-54471.3	2.3	8495.09	0.03	β^-	8088	3	74 941522.6	2.5
45	30		Zn	x	-62558.9	2.0	8592.497	0.026	β^-	5906	3	74 932840.2	2.1
44	31		Ga	x	-68464.6	2.4	8660.81	0.03	β^-	3392.4	2.4	74 926500.2	2.6
43	32		Ge	-n	-71856.96	0.05	8695.609	0.001	β^-	1177.2	0.9	74 922858.37	0.06
42	33		As		-73034.2	0.9	8700.874	0.012	*			74 921594.6	0.9
41	34		Se		-72169.48	0.07	8678.913	0.001	β^+	864.7	0.9	74 922522.87	0.08
40	35		Br	x	-69107	4	8627.65	0.06	β^+	3062	4	74 925811	5
39	36		Kr	x	-64324	8	8553.44	0.11	β^+	4783	9	74 930946	9
38	37		Rb	x	-57218.7	1.2	8448.275	0.016	β^+	7105	8	74 938573.2	1.3
37	38		Sr	—	-46620	220	8296.5	2.9	β^+	10600	220	74 949950	240
36	39		Y	x	-31820#	300#	8089#	4#	β^+	14800#	370#	74 965840#	320#
49	27	76	Co	x	-24510#	600#	8116#	8#	β^-	17120#	720#	75 973690#	640#
48	28		Ni	x	-41630#	400#	8331#	5#	β^-	9350#	400#	75 955310#	430#
47	29		Cu	x	-50976	7	8443.53	0.09	β^-	11327	7	75 945275	7
46	30		Zn		-62303.0	1.5	8582.273	0.019	β^-	3993.6	2.4	75 933115.0	1.6
45	31		Ga	x	-66296.6	2.0	8624.526	0.026	β^-	6916.2	2.0	75 928827.6	2.1
44	32		Ge		-73212.889	0.018	8705.236	<i>a</i>	β^-	-921.5	0.9	75 921402.727	0.019
43	33		As	-n	-72291.4	0.9	8682.816	0.012	β^-	2960.6	0.9	75 922392.0	1.0
42	34		Se		-75251.950	0.016	8711.477	<i>a</i>	*			75 919213.704	0.017
41	35		Br	—	-70289	9	8635.88	0.12	β^+	4963	9	75 924542	10
40	36		Kr		-69014	4	8608.81	0.05	β^+	1275	10	75 925911	4
39	37		Rb	x	-60479.1	0.9	8486.215	0.012	β^+	8535	4	75 935073.0	1.0
38	38		Sr	x	-54250	30	8393.9	0.5	β^+	6230	30	75 941760	40
37	39		Y	x	-38480#	300#	8176#	4#	β^+	15770#	300#	75 958690#	320#
50	27	77	Co	x	-21020#	600#	8070#	8#	β^-	15790#	780#	76 977440#	640#
49	28		Ni	x	-36800#	500#	8265#	6#	β^-	11820#	520#	76 960490#	540#
48	29		Cu	x	-48620#	150#	8408#	2#	β^-	10170#	150#	76 947800#	160#
47	30		Zn		-58789.2	2.0	8530.003	0.026	β^-	7203	3	76 936887.2	2.1
46	31		Ga	x	-65992.3	2.4	8613.39	0.03	β^-	5220.5	2.4	76 929154.3	2.6
45	32		Ge	-n	-71212.86	0.05	8671.029	0.001	β^-	2703.5	1.7	76 923549.84	0.06
44	33		As		-73916.3	1.7	8695.978	0.022	β^-	683.2	1.7	76 920647.6	1.8
43	34		Se		-74599.49	0.06	8694.690	0.001	*			76 919914.15	0.07
42	35		Br	—	-73234.8	2.8	8666.81	0.04	β^+	1364.7	2.8	76 921379	3
41	36		Kr	x	-70169.4	2.0	8616.836	0.025	β^+	3065	3	76 924670.0	2.1
40	37		Rb	x	-64830.5	1.3	8537.339	0.017	β^+	5339.0	2.4	76 930401.6	1.4
39	38		Sr	x	-57803	8	8435.92	0.10	β^+	7027	8	76 937945	9
38	39		Y	-p	-46440#	200#	8278#	3#	β^+	11370#	200#	76 950150#	220#
37	40		Zr	x	-32040#	400#	8081#	5#	β^+	14400#	450#	76 965600#	430#

Table I. The 2012 Atomic mass table (continued, Explanation of Table on p. 030003-6)

<i>N</i>	<i>Z</i>	<i>A</i>	Elt.	Orig.	Mass excess (keV)		Binding energy per nucleon (keV)		Beta-decay energy (keV)			Atomic mass μ	
50	28	78	Ni	x	-33890#	600#	8225#	8#	β^-	10610#	780#	77 963620#	640#
49	29		Cu	x	-44500	500	8351	6	β^-	12990	500	77 952230	540
48	30		Zn		-57483.2	1.9	8507.379	0.025	β^-	6222.7	2.7	77 938289.2	2.1
47	31		Ga		-63706.0	1.9	8577.127	0.024	β^-	8156	4	77 931608.8	2.0
46	32		Ge	-nn	-71862	4	8671.66	0.05	β^-	955	10	77 922853	4
45	33		As	+pn	-72817	10	8673.87	0.13	β^-	4209	10	77 921828	11
44	34		Se		-77025.94	0.18	8717.806	0.002	β^-	-3574	4	77 917309.24	0.19
43	35		Br	—	-73452	4	8661.96	0.05	β^-	726	4	77 921146	4
42	36		Kr		-74178.3	0.3	8661.238	0.004		*		77 920366.3	0.3
41	37		Rb	x	-66935	3	8558.35	0.04	β^+	7243	3	77 928142	3
40	38		Sr	x	-63174	7	8500.10	0.10	β^+	3761	8	77 932180	8
39	39		Y	x	-52170#	300#	8349#	4#	β^+	11000#	300#	77 943990#	320#
38	40		Zr	x	-40850#	400#	8194#	5#	β^+	11320#	500#	77 956150#	430#
51	28	79	Ni	x	-27570#	600#	8143#	8#	β^-	14170#	670#	78 970400#	640#
50	29		Cu	x	-41740#	300#	8312#	4#	β^-	11690#	300#	78 955190#	320#
49	30		Zn		-53432.3	2.2	8450.582	0.028	β^-	9115.4	2.9	78 942638.1	2.4
48	31		Ga		-62547.7	1.9	8556.063	0.024	β^-	6980	40	78 932852.3	2.0
47	32		Ge		-69530	40	8634.5	0.5	β^-	4110	40	78 925360	40
46	33		As		-73636	5	8676.62	0.07	β^-	2281	5	78 920948	6
45	34		Se	-n	-75917.46	0.22	8695.592	0.003	β^-	150.6	1.0	78 918499.25	0.24
44	35		Br	+n	-76068.0	1.0	8687.594	0.013		*		78 918337.6	1.1
43	36		Kr	—	-74442	3	8657.11	0.04	β^+	1626	3	78 920083	4
42	37		Rb	x	-70803.0	2.1	8601.142	0.027	β^+	3639	4	78 923989.9	2.3
41	38		Sr	x	-65477	8	8523.82	0.11	β^+	5326	9	78 929708	9
40	39		Y	x	-57820	80	8417.0	1.0	β^+	7660	80	78 937930	90
39	40		Zr	x	-46770#	300#	8267#	4#	β^+	11050#	310#	78 949790#	320#
38	41		Nb	x	-31650#	500#	8066#	6#	β^+	15120#	580#	78 966020#	540#
52	28	80	Ni	x	-22630#	700#	8080#	9#	β^-	13570#	810#	79 975710#	750#
51	29		Cu	x	-36200#	400#	8240#	5#	β^-	15450#	400#	79 961140#	430#
50	30		Zn		-51648.6	2.6	8423.54	0.03	β^-	7575	4	79 944552.9	2.8
49	31		Ga	x	-59223.7	2.9	8508.45	0.04	β^-	10312	4	79 936421	3
48	32		Ge	x	-69535.3	2.1	8627.570	0.026	β^-	2679	4	79 925350.8	2.2
47	33		As	x	-72214	3	8651.28	0.04	β^-	5545	3	79 922475	4
46	34		Se		-77759.5	1.0	8710.813	0.012	β^-	-1870.5	0.3	79 916521.8	1.0
45	35		Br	—	-75889.0	1.0	8677.653	0.013	β^-	2004.4	1.2	79 918529.8	1.1
44	36		Kr		-77893.3	0.7	8692.928	0.009		*		79 916378.0	0.7
43	37		Rb	x	-72175.5	1.9	8611.675	0.023	β^+	5717.9	2.0	79 922516.4	2.0
42	38		Sr	x	-70311	3	8578.60	0.04	β^+	1864	4	79 924518	4
41	39		Y	x	-61148	6	8454.28	0.08	β^+	9163	7	79 934355	7
40	40		Zr	x	-54360#	300#	8360#	4#	β^+	6790#	300#	79 941640#	320#
39	41		Nb	x	-38420#	400#	8151#	5#	β^+	15940#	500#	79 958750#	430#
52	29	81	Cu	x	-31420#	500#	8179#	6#	β^-	14780#	500#	80 966270#	540#
51	30		Zn	x	-46200	5	8351.93	0.06	β^-	11428	6	80 950403	5
50	31		Ga	x	-57628	3	8483.36	0.04	β^-	8664	4	80 938134	4
49	32		Ge	x	-66291.7	2.1	8580.658	0.025	β^-	6242	3	80 928832.9	2.2
48	33		As		-72533.3	2.6	8648.06	0.03	β^-	3855.7	2.8	80 922132.3	2.8
47	34		Se		-76389.0	1.0	8685.999	0.012	β^-	1588.0	1.4	80 917993.0	1.1
46	35		Br		-77977.0	1.0	8695.946	0.012		*		80 916288.2	1.0
45	36		Kr		-77696.2	1.1	8682.820	0.013	β^+	280.9	0.5	80 916589.7	1.2
44	37		Rb		-75457	5	8645.51	0.06	β^+	2240	5	80 918994	5
43	38		Sr	x	-71528	3	8587.35	0.04	β^+	3929	6	80 923211	3
42	39		Y	x	-65713	5	8505.90	0.07	β^+	5815	6	80 929454	6
41	40		Zr	x	-57460	90	8394.4	1.2	β^+	8250	90	80 938310	100
40	41		Nb	x	-46360#	400#	8248#	5#	β^+	11100#	410#	80 950230#	430#
39	42		Mo	x	-31750#	500#	8058#	6#	β^+	14610#	640#	80 965920#	540#

Table I. The 2012 Atomic mass table (continued, Explanation of Table on p. 030003-6)

<i>N</i>	<i>Z</i>	<i>A</i>	Elt.	Orig.	Mass excess (keV)		Binding energy per nucleon (keV)		Beta-decay energy (keV)		Atomic mass μ u		
53	29	82	Cu	x	-25320#	600#	8103#	7#	β^-	16990#	600#	81 972820#	640#
52	30		Zn	x	-42314	3	8301.12	0.04	β^-	10617	4	81 954574	3
51	31		Ga	x	-52930.7	2.4	8421.049	0.030	β^-	12484	3	81 943176.5	2.6
50	32		Ge	x	-65415.1	2.2	8563.756	0.027	β^-	4690	4	81 929774.0	2.4
49	33		As	x	-70105	4	8611.41	0.05	β^-	7488	4	81 924739	4
48	34		Se		-77593.9	0.5	8693.196	0.006	β^-	-95.2	1.1	81 916699.5	0.5
47	35		Br		-77498.7	1.0	8682.494	0.012	β^-	3093.1	1.0	81 916801.8	1.0
46	36		Kr		-80591.785	0.005	8710.675	<i>a</i>	*	*	*	81 913481.155	0.006
45	37		Rb	IT	-76188	3	8647.43	0.04	β^+	4404	3	81 918209	3
44	38		Sr		-76010	6	8635.72	0.07	β^+	178	7	81 918400	6
43	39		Y	x	-68064	5	8529.28	0.07	β^+	7946	8	81 926930	6
42	40		Zr	x	-63631	11	8465.68	0.14	β^+	4433	12	81 931689	12
41	41		Nb	x	-52090#	300#	8315#	4#	β^+	11540#	300#	81 944080#	320#
40	42		Mo	x	-40370#	400#	8163#	5#	β^+	11720#	500#	81 956660#	430#
53	30	83	Zn	x	-36290#	300#	8226#	4#	β^-	12970#	300#	82 961040#	320#
52	31		Ga	x	-49257.1	2.6	8372.57	0.03	β^-	11719	4	82 947120.3	2.8
51	32		Ge	x	-60976.4	2.4	8504.345	0.029	β^-	8693	4	82 934539.1	2.6
50	33		As	x	-69669.3	2.8	8599.65	0.03	β^-	5671	4	82 925207	3
49	34		Se	-n	-75341	3	8658.56	0.04	β^-	3673	5	82 919119	3
48	35		Br		-79014	4	8693.38	0.05	β^-	977	4	82 915175	4
47	36		Kr		-79990.633	0.009	8695.729	<i>a</i>	*	*	*	82 914126.518	0.010
46	37		Rb		-79070.6	2.3	8675.218	0.028	β^+	920.0	2.3	82 915114.2	2.5
45	38		Sr		-76798	7	8638.41	0.08	β^+	2273	6	82 917554	7
44	39		Y	x	-72206	19	8573.66	0.22	β^+	4592	20	82 922484	20
43	40		Zr	x	-65912	6	8488.40	0.08	β^+	6294	20	82 929241	7
42	41		Nb	x	-57560	150	8378.3	1.8	β^+	8360	150	82 938210	160
41	42		Mo	x	-46340#	400#	8234#	5#	β^+	11220#	430#	82 950250#	430#
40	43		Tc	x	-31320#	500#	8043#	6#	β^+	15020#	640#	82 966380#	540#
54	30	84	Zn	x	-31930#	400#	8172#	5#	β^-	12160#	450#	83 965720#	430#
53	31		Ga	x	-44090#	200#	8307#	2#	β^-	14060#	200#	83 952670#	220#
52	32		Ge	x	-58148	3	8465.52	0.04	β^-	7705	4	83 937575	3
51	33		As	x	-65854	3	8547.94	0.04	β^-	10094	4	83 929303	3
50	34		Se		-75947.7	2.0	8658.793	0.023	β^-	1835	26	83 918466.8	2.1
49	35		Br		-77783	26	8671.3	0.3	β^-	4656	26	83 916496	28
48	36		Kr		-82439.335	0.004	8717.446	<i>a</i>	β^-	-2680.4	2.2	83 911497.729	0.004
47	37		Rb		-79759.0	2.2	8676.224	0.026	β^-	890.6	2.3	83 914375.2	2.4
46	38		Sr		-80649.6	1.2	8677.512	0.015	*	*	*	83 913419.1	1.3
45	39		Y		-73894	4	8587.78	0.05	β^+	6755	4	83 920671	5
44	40		Zr	x	-71422	5	8549.03	0.07	β^+	2473	7	83 923326	6
43	41		Nb	x	-61219	13	8418.25	0.16	β^+	10203	14	83 934279	14
42	42		Mo	x	-54170#	300#	8325#	4#	β^+	7050#	300#	83 941850#	320#
41	43		Tc	x	-37700#	400#	8120#	5#	β^+	16470#	500#	83 959530#	430#
55	30	85	Zn	x	-25230#	500#	8092#	6#	β^-	14620#	580#	84 972910#	540#
54	31		Ga	x	-39850#	300#	8255#	4#	β^-	13270#	300#	84 957220#	320#
53	32		Ge	x	-53123	4	8401.77	0.04	β^-	10066	5	84 942970	4
52	33		As	x	-63189	3	8510.98	0.04	β^-	9224	4	84 932164	3
51	34		Se	+3p	-72413.6	2.6	8610.30	0.03	β^-	6162	4	84 922260.8	2.8
50	35		Br	+n2p	-78575	3	8673.59	0.04	β^-	2905	4	84 915646	3
49	36		Kr	+	-81480.3	2.0	8698.562	0.024	β^-	687.0	2.0	84 912527.3	2.1
48	37		Rb		-82167.331	0.005	8697.441	<i>a</i>	*	*	*	84 911789.738	0.005
47	38		Sr		-81103.3	2.8	8675.72	0.03	β^+	1064.1	2.8	84 912932	3
46	39		Y	x	-77842	19	8628.15	0.22	β^+	3261	19	84 916433	20
45	40		Zr	x	-73175	6	8564.04	0.08	β^+	4667	20	84 921443	7
44	41		Nb	x	-66280	4	8473.71	0.05	β^+	6896	8	84 928846	4
43	42		Mo	x	-57510	16	8361.33	0.19	β^+	8770	16	84 938261	17
42	43		Tc	x	-45850#	400#	8215#	5#	β^+	11660#	400#	84 950780#	430#
41	44		Ru	x	-30950#	500#	8030#	6#	β^+	14900#	640#	84 966770#	540#

Table I. The 2012 Atomic mass table (continued, Explanation of Table on p. 030003-6)

<i>N</i>	<i>Z</i>	<i>A</i>	Elt.	Orig.	Mass excess (keV)		Binding energy per nucleon (keV)		Beta-decay energy (keV)		Atomic mass μ u		
55	31	86	Ga	x	-34080#	400#	8186#	5#	β^-	15320#	590#	85 963410#	430#
54	32		Ge	x	-49400	440	8355	5	β^-	9560	440	85 946970	470
53	33		As	x	-58962	3	8456.72	0.04	β^-	11541	4	85 936702	4
52	34		Se	x	-70503.2	2.5	8581.822	0.029	β^-	5129	4	85 924311.7	2.7
51	35		Br	+pp	-75632	3	8632.37	0.04	β^-	7633	3	85 918805	3
50	36		Kr		-83265.666	0.004	8712.029	<i>a</i>	β^-	-518.67	0.20	85 910610.626	0.004
49	37		Rb	-n	-82746.99	0.20	8696.900	0.002	β^-	1776.10	0.20	85 911167.44	0.21
48	38		Sr		-84523.089	0.005	8708.456	<i>a</i>	*			85 909260.726	0.006
47	39		Y	-	-79283	14	8638.43	0.16	β^+	5240	14	85 914886	15
46	40		Zr		-77969	4	8614.05	0.04	β^+	1314	15	85 916297	4
45	41		Nb	x	-69134	5	8502.22	0.06	β^+	8835	7	85 925782	6
44	42		Mo	x	-64110	4	8434.71	0.04	β^+	5024	7	85 931175	4
43	43		Tc	x	-51570#	300#	8280#	3#	β^+	12540#	300#	85 944640#	320#
42	44		Ru	x	-39770#	400#	8133#	5#	β^+	11800#	500#	85 957310#	430#
56	31	87	Ga	x	-29250#	500#	8129#	6#	β^-	14830#	580#	86 968600#	540#
55	32		Ge	x	-44080#	300#	8290#	3#	β^-	11540#	300#	86 952680#	320#
54	33		As	x	-55617.9	3.0	8413.85	0.03	β^-	10808	4	86 940292	3
53	34		Se	x	-66426.1	2.2	8529.091	0.026	β^-	7466	4	86 928688.6	2.4
52	35		Br	2p-n	-73892	3	8605.91	0.04	β^-	6818	3	86 920674	3
51	36		Kr	-n	-80709.52	0.25	8675.283	0.003	β^-	3888.27	0.25	86 913354.76	0.26
50	37		Rb		-84597.791	0.006	8710.983	<i>a</i>	β^-	282.275	0.006	86 909180.531	0.006
49	38		Sr		-84880.066	0.005	8705.236	<i>a</i>	*			86 908877.496	0.005
48	39		Y	-	-83018.4	1.1	8674.844	0.013	β^+	1861.7	1.1	86 910876.1	1.2
47	40		Zr		-79347	4	8623.65	0.05	β^+	3671	4	86 914817	4
46	41		Nb	x	-73874	7	8551.76	0.08	β^+	5473	8	86 920692	7
45	42		Mo		-66884.8	2.9	8462.42	0.03	β^+	6990	7	86 928196	3
44	43		Tc	x	-57690	4	8347.74	0.05	β^+	9195	5	86 938067	5
43	44		Ru	x	-45520#	400#	8199#	5#	β^+	12170#	400#	86 951130#	430#
56	32	88	Ge	x	-40140#	400#	8243#	5#	β^-	10580#	450#	87 956910#	430#
55	33		As	x	-50720#	200#	8354#	2#	β^-	13160#	200#	87 945550#	210#
54	34		Se	x	-63884	3	8495.00	0.04	β^-	6832	5	87 931417	4
53	35		Br	++	-70716	3	8563.75	0.04	β^-	8975	4	87 924083	3
52	36		Kr	x	-79691.3	2.6	8656.849	0.030	β^-	2917.7	2.6	87 914447.9	2.8
51	37		Rb		-82608.99	0.16	8681.115	0.002	β^-	5312.62	0.16	87 911315.59	0.17
50	38		Sr		-87921.618	0.006	8732.595	<i>a</i>	*			87 905612.256	0.006
49	39		Y	-	-84299.0	1.5	8682.539	0.017	β^+	3622.6	1.5	87 909501.3	1.6
48	40		Zr		-83629	5	8666.03	0.06	β^+	670	6	87 910221	6
47	41		Nb		-76170	60	8572.4	0.7	β^+	7460	60	87 918220	60
46	42		Mo	x	-72687	4	8523.91	0.04	β^+	3490	60	87 921968	4
45	43		Tc	x	-61680	150	8390.0	1.7	β^+	11010	150	87 933780	160
44	44		Ru	x	-54340#	300#	8298#	3#	β^+	7340#	340#	87 941660#	320#
43	45		Rh	x	-36860#	400#	8090#	5#	β^+	17480#	500#	87 960430#	430#
57	32	89	Ge	x	-33730#	400#	8169#	4#	β^-	13070#	500#	88 963790#	430#
56	33		As	x	-46800#	300#	8307#	3#	β^-	12190#	300#	88 949760#	320#
55	34		Se	x	-58992	4	8435.28	0.04	β^-	9282	5	88 936669	4
54	35		Br	x	-68274	3	8530.78	0.04	β^-	8262	4	88 926705	4
53	36		Kr	x	-76535.8	2.1	8614.815	0.024	β^-	5177	6	88 917835.5	2.3
52	37		Rb		-81712	5	8664.19	0.06	β^-	4497	5	88 912278	6
51	38		Sr		-86209.02	0.09	8705.922	0.001	β^-	1499.3	1.6	88 907450.81	0.10
50	39		Y		-87708.4	1.6	8713.978	0.018	*			88 905841.2	1.7
49	40		Zr		-84876	3	8673.36	0.03	β^+	2832.8	2.8	88 908882	3
48	41		Nb		-80625	24	8616.81	0.27	β^+	4250	24	88 913445	25
47	42		Mo	x	-75015	4	8544.98	0.04	β^+	5610	24	88 919468	4
46	43		Tc	x	-67395	4	8450.57	0.04	β^+	7620	5	88 927649	4
45	44		Ru	x	-58260#	300#	8339#	3#	β^+	9140#	300#	88 937460#	320#
44	45		Rh	-p	-45860#	360#	8191#	4#	β^+	12400#	470#	88 950770#	390#

Table I. The 2012 Atomic mass table (continued, Explanation of Table on p. 030003-6)

<i>N</i>	<i>Z</i>	<i>A</i>	Elt.	Orig.	Mass excess (keV)		Binding energy per nucleon (keV)		Beta-decay energy (keV)		Atomic mass μ		
58	32	90	Ge	x	-29220#	500#	8118#	6#	β^-	12110#	640#	89 968630#	540#
57	33		As	x	-41330#	400#	8244#	4#	β^-	14470#	520#	89 955630#	430#
56	34		Se	x	-55800	330	8396	4	β^-	8200	330	89 940100	350
55	35		Br	x	-64000	3	8478.19	0.04	β^-	10959	4	89 931293	4
54	36		Kr	x	-74959.2	1.9	8591.259	0.021	β^-	4405	7	89 919527.9	2.0
53	37		Rb		-79364	6	8631.51	0.07	β^-	6584	7	89 914799	7
52	38		Sr		-85948.1	2.1	8695.972	0.024	β^-	545.9	1.4	89 907730.9	2.3
51	39		Y		-86494.1	1.6	8693.345	0.018	β^-	2278.5	1.6	89 907144.8	1.7
50	40		Zr		-88772.54	0.12	8709.969	0.001	*			89 904698.76	0.13
49	41		Nb		-82662	3	8633.38	0.04	β^+	6111	3	89 911259	4
48	42		Mo		-80173	3	8597.03	0.04	β^+	2489	3	89 913931	4
47	43		Tc	x	-70724.7	1.0	8483.359	0.011	β^+	9448	4	89 924073.9	1.1
46	44		Ru		-64884	4	8409.77	0.04	β^+	5841	4	89 930344	4
45	45		Rh	x	-51700#	300#	8255#	3#	β^+	13180#	300#	89 944500#	320#
44	46		Pd	x	-39710#	400#	8113#	4#	β^+	11990#	500#	89 957370#	430#
58	33	91	As	x	-36900#	400#	8193#	4#	β^-	13680#	590#	90 960390#	430#
57	34		Se	x	-50580	430	8335	5	β^-	10530	430	90 945700	470
56	35		Br	-n2p	-61107	4	8441.92	0.04	β^-	9867	4	90 934399	4
55	36		Kr	x	-70974.0	2.2	8541.751	0.025	β^-	6771	8	90 923806.3	2.4
54	37		Rb		-77745	8	8607.56	0.09	β^-	5907	9	90 916537	8
53	38		Sr		-83652	5	8663.87	0.06	β^-	2699	5	90 910196	6
52	39		Y		-86351.3	1.8	8684.941	0.020	β^-	1544.3	1.8	90 907298.1	2.0
51	40		Zr		-87895.57	0.10	8693.314	0.001	*			90 905640.22	0.11
50	41		Nb		-86638.0	2.9	8670.90	0.03	β^+	1257.6	2.9	90 906990	3
49	42		Mo		-82209	6	8613.63	0.07	β^+	4429	7	90 911745	7
48	43		Tc		-75986.6	2.4	8536.655	0.026	β^+	6222	7	90 918425.0	2.5
47	44		Ru		-68239.8	2.2	8442.928	0.024	β^+	7747	3	90 926741.5	2.4
46	45		Rh	x	-58570#	300#	8328#	3#	β^+	9670#	300#	90 937120#	320#
45	46		Pd	x	-45930#	400#	8181#	4#	β^+	12640#	500#	90 950690#	430#
59	33	92	As	x	-30980#	500#	8127#	5#	β^-	15740#	640#	91 966740#	540#
58	34		Se	x	-46720#	400#	8290#	4#	β^-	9510#	400#	91 949840#	430#
57	35		Br	x	-56233	7	8384.91	0.07	β^-	12537	7	91 939632	7
56	36		Kr	x	-68769.3	2.7	8512.674	0.029	β^-	6003	7	91 926173.1	2.9
55	37		Rb		-74772	6	8569.42	0.07	β^-	8095	6	91 919728	7
54	38		Sr		-82867	3	8648.91	0.04	β^-	1949	9	91 911038	4
53	39		Y		-84816	9	8661.59	0.10	β^-	3643	9	91 908946	10
52	40		Zr		-88459.03	0.10	8692.678	0.001	β^-	-2005.7	1.8	91 905035.32	0.11
51	41		Nb		-86453.3	1.8	8662.372	0.019	β^-	355.3	1.8	91 907188.6	1.9
50	42		Mo		-86808.58	0.16	8657.730	0.002	*			91 906807.16	0.17
49	43		Tc		-78926	3	8563.54	0.03	β^+	7883	3	91 915270	3
48	44		Ru		-74301.2	2.7	8504.773	0.030	β^+	4624	4	91 920234.4	2.9
47	45		Rh	x	-62999	4	8373.42	0.05	β^+	11302	5	91 932368	5
46	46		Pd	x	-54580#	300#	8273#	3#	β^+	8420#	300#	91 941410#	320#
45	47		Ag	x	-37130#	500#	8075#	5#	β^+	17450#	580#	91 960140#	540#
59	34	93	Se	x	-40720#	400#	8223#	4#	β^-	12180#	590#	92 956290#	430#
58	35		Br	x	-52890	430	8346	5	β^-	11250	430	92 943220	460
57	36		Kr	x	-64136.0	2.5	8458.108	0.027	β^-	8484	8	92 931147.2	2.7
56	37		Rb		-72620	8	8540.92	0.08	β^-	7466	9	92 922039	8
55	38		Sr		-80086	8	8612.79	0.08	β^-	4141	12	92 914024	8
54	39		Y		-84227	10	8648.90	0.11	β^-	2895	10	92 909578	11
53	40		Zr		-87122.0	0.5	8671.620	0.005	β^-	90.8	1.5	92 906470.6	0.5
52	41		Nb		-87212.8	1.5	8664.184	0.016	*			92 906373.2	1.6
51	42		Mo	-n	-86807.07	0.18	8651.409	0.002	β^+	405.8	1.5	92 906808.77	0.19
50	43		Tc	-p	-83606.1	1.0	8608.577	0.011	β^+	3201.0	1.0	92 910245.1	1.1
49	44		Ru		-77216.7	2.1	8531.462	0.022	β^+	6389.4	2.3	92 917104.4	2.2
48	45		Rh		-69011.8	2.6	8434.825	0.028	β^+	8205	3	92 925912.8	2.8
47	46		Pd	+p	-59000#	300#	8319#	3#	β^+	10010#	300#	92 936660#	320#
46	47		Ag	x	-46270#	400#	8173#	4#	β^+	12730#	500#	92 950330#	430#

Table I. The 2012 Atomic mass table (continued, Explanation of Table on p. 030003-6)

<i>N</i>	<i>Z</i>	<i>A</i>	Elt.	Orig.	Mass excess (keV)		Binding energy per nucleon (keV)		Beta-decay energy (keV)		Atomic mass μ		
60	34	94	Se	x	-36800#	500#	8180#	5#	β^-	10600#	580#	93 960490#	540#
59	35		Br	x	-47400#	300#	8284#	3#	β^-	13950#	300#	93 949110#	320#
58	36		Kr	x	-61348	12	8424.33	0.13	β^-	7215	12	93 934140	13
57	37		Rb		-68562.8	2.0	8492.764	0.022	β^-	10282.9	2.6	93 926394.8	2.2
56	38		Sr		-78845.7	1.7	8593.834	0.018	β^-	3506	6	93 915355.6	1.8
55	39		Y		-82351	6	8622.81	0.07	β^-	4918	6	93 911592	7
54	40		Zr		-87269.32	0.16	8666.801	0.002	β^-	-900.3	1.5	93 906312.52	0.18
53	41		Nb		-86369.1	1.5	8648.901	0.016	β^-	2045.0	1.5	93 907279.0	1.6
52	42		Mo		-88414.06	0.14	8662.333	0.002		*		93 905083.59	0.15
51	43		Tc	—	-84158	4	8608.74	0.04	β^+	4256	4	93 909652	4
50	44		Ru		-82584	3	8583.66	0.03	β^+	1575	5	93 911343	3
49	45		Rh		-72908	3	8472.40	0.04	β^+	9676	5	93 921730	4
48	46		Pd	x	-66102	4	8391.68	0.05	β^+	6805	5	93 929036	5
47	47		Ag	x	-52410#	400#	8238#	4#	β^+	13690#	400#	93 943740#	430#
46	48		Cd	x	-40140#	500#	8099#	5#	β^+	12270#	640#	93 956910#	540#
61	34	95	Se	x	-30460#	500#	8112#	5#	β^-	13310#	580#	94 967300#	540#
60	35		Br	x	-43770#	300#	8244#	3#	β^-	12390#	300#	94 953010#	320#
59	36		Kr	x	-56159	19	8366.00	0.20	β^-	9733	28	94 939711	20
58	37		Rb		-65891	20	8460.21	0.21	β^-	9228	20	94 929263	22
57	38		Sr		-75120	6	8549.11	0.06	β^-	6089	7	94 919356	6
56	39		Y		-81209	7	8604.97	0.07	β^-	4451	7	94 912819	7
55	40		Zr		-85659.9	0.9	8643.592	0.009	β^-	1126.3	1.0	94 908040.3	0.9
54	41		Nb		-86786.3	0.5	8647.212	0.005	β^-	925.6	0.5	94 906831.1	0.5
53	42		Mo		-87711.86	0.12	8648.720	0.001		*		94 905837.44	0.13
52	43		Tc		-86021	5	8622.69	0.05	β^+	1691	5	94 907652	5
51	44		Ru		-83458	10	8587.47	0.10	β^+	2564	11	94 910404	10
50	45		Rh		-78341	4	8525.37	0.04	β^+	5117	10	94 915898	4
49	46		Pd	x	-69966	3	8428.98	0.03	β^+	8375	5	94 924889	3
48	47		Ag	x	-59600#	300#	8312#	3#	β^+	10370#	300#	94 936020#	320#
47	48		Cd	x	-46630#	400#	8167#	4#	β^+	12970#	500#	94 949940#	430#
61	35	96	Br	x	-38160#	300#	8184#	3#	β^-	14920#	300#	95 959030#	320#
60	36		Kr	x	-53080	20	8330.85	0.21	β^-	8275	21	95 943017	22
59	37		Rb		-61354	3	8408.90	0.03	β^-	11570	9	95 934133	4
58	38		Sr		-72924	8	8521.26	0.09	β^-	5412	10	95 921713	9
57	39		Y		-78336	6	8569.49	0.06	β^-	7103	6	95 915903	7
56	40		Zr		-85438.85	0.11	8635.327	0.001	β^-	163.97	0.10	95 908277.62	0.12
55	41		Nb		-85602.82	0.15	8628.886	0.002	β^-	3192.06	0.11	95 908101.59	0.16
54	42		Mo		-88794.88	0.12	8653.987	0.001	β^-	-2973	5	95 904674.77	0.13
53	43		Tc	—	-85822	5	8614.87	0.05	β^-	259	5	95 907867	6
52	44		Ru		-86080.37	0.17	8609.412	0.002		*		95 907588.91	0.18
51	45		Rh	—	-79688	10	8534.67	0.10	β^+	6393	10	95 914452	11
50	46		Pd	x	-76183	4	8490.02	0.04	β^+	3504	11	95 918214	5
49	47		Ag	ϵ p	-64510	90	8360.3	0.9	β^+	11670	90	95 930740	100
48	48		Cd	x	-55570#	400#	8259#	4#	β^+	8940#	410#	95 940340#	430#
47	49		In	x	-37890#	500#	8067#	5#	β^+	17680#	640#	95 959320#	540#

Table I. The 2012 Atomic mass table (continued, Explanation of Table on p. 030003-6)

<i>N</i>	<i>Z</i>	<i>A</i>	Elt.	Orig.	Mass excess (keV)		Binding energy per nucleon (keV)		Beta-decay energy (keV)		Atomic mass μ		
62	35	97	Br	x	-34060#	400#	8140#	4#	β^-	13370#	420#	96 963440#	430#
61	36		Kr	x	-47420	130	8269.9	1.3	β^-	11100	130	96 949090	140
60	37		Rb		-58519.1	1.9	8376.186	0.020	β^-	10062	4	96 937177.1	2.1
59	38		Sr		-68581	3	8471.86	0.03	β^-	7540	8	96 926375	4
58	39		Y	+	-76121	7	8541.52	0.07	β^-	6821	7	96 918280	7
57	40		Zr		-82942.7	0.4	8603.779	0.004	β^-	2663	4	96 910957.4	0.4
56	41		Nb		-85606	4	8623.17	0.04	β^-	1939	4	96 908098	5
55	42		Mo		-87544.69	0.16	8635.092	0.002	*			96 906016.90	0.18
54	43		Tc		-87224	4	8623.72	0.04	β^+	320	4	96 906361	4
53	44		Ru	-n	-86120.6	2.8	8604.279	0.028	β^+	1104	5	96 907545.8	3.0
52	45		Rh	-	-82600	40	8559.9	0.4	β^+	3520	40	96 911330	40
51	46		Pd	x	-77806	5	8502.43	0.05	β^+	4790	40	96 916472	5
50	47		Ag	-	-70830	110	8422.4	1.1	β^+	6980	110	96 923970	120
49	48		Cd	x	-60450#	300#	8307#	3#	β^+	10370#	320#	96 935100#	320#
48	49		In	x	-47190#	400#	8163#	4#	β^+	13260#	500#	96 949340#	430#
63	35	98	Br	x	-28250#	400#	8080#	4#	β^-	16060#	500#	97 969670#	430#
62	36		Kr	x	-44310#	300#	8236#	3#	β^-	10060#	300#	97 952430#	320#
61	37		Rb		-54369	16	8330.73	0.16	β^-	12054	16	97 941632	17
60	38		Sr		-66423	3	8445.75	0.03	β^-	5872	9	97 928692	3
59	39		Y	p-2n	-72295	8	8497.68	0.08	β^-	8992	12	97 922388	9
58	40		Zr		-81287	8	8581.45	0.09	β^-	2238	10	97 912735	9
57	41		Nb	-pn	-83525	5	8596.30	0.05	β^-	4591	5	97 910333	5
56	42		Mo		-88115.97	0.17	8635.168	0.002	β^-	-1684	3	97 905403.61	0.19
55	43		Tc		-86432	3	8610.00	0.03	β^-	1793	7	97 907211	4
54	44		Ru		-88225	6	8620.31	0.07	*			97 905287	7
53	45		Rh	-	-83175	12	8560.80	0.12	β^+	5050	10	97 910708	13
52	46		Pd		-81321	5	8533.90	0.05	β^+	1854	13	97 912698	5
51	47		Ag		-73070	30	8441.7	0.3	β^+	8250	30	97 921560	40
50	48		Cd	-	-67640	50	8378.3	0.5	β^+	5430	40	97 927390	60
49	49		In	x	-53900#	300#	8230#	3#	β^+	13740#	300#	97 942140#	320#
63	36	99	Kr	x	-38760#	400#	8178#	4#	β^-	12360#	400#	98 958390#	430#
62	37		Rb	x	-51121	4	8295.30	0.04	β^-	11400	6	98 945119	4
61	38		Sr		-62521	5	8402.55	0.05	β^-	8128	8	98 932881	5
60	39		Y	x	-70650	7	8476.75	0.07	β^-	6971	12	98 924154	7
59	40		Zr		-77621	11	8539.26	0.11	β^-	4715	16	98 916671	11
58	41		Nb	+p	-82335	12	8578.99	0.12	β^-	3635	12	98 911609	13
57	42		Mo		-85970.10	0.23	8607.797	0.002	β^-	1357.8	0.9	98 907707.30	0.25
56	43		Tc		-87327.9	0.9	8613.610	0.009	β^-	297.5	0.9	98 906249.7	1.0
55	44		Ru		-87625.4	0.3	8608.712	0.003	*			98 905930.3	0.4
54	45		Rh		-85581	7	8580.16	0.07	β^+	2044	7	98 908125	7
53	46		Pd		-82183	5	8537.93	0.05	β^+	3399	8	98 911773	5
52	47		Ag	x	-76712	6	8474.77	0.06	β^+	5470	8	98 917646	7
51	48		Cd	x	-69931.1	1.6	8398.373	0.016	β^+	6781	6	98 924925.8	1.7
50	49		In	x	-61380#	300#	8304#	3#	β^+	8560#	300#	98 934110#	320#
49	50		Sn	x	-47940#	500#	8160#	5#	β^+	13430#	590#	98 948530#	540#

Table I. The 2012 Atomic mass table (continued, Explanation of Table on p. 030003-6)

<i>N</i>	<i>Z</i>	<i>A</i>	Elt.	Orig.	Mass excess (keV)		Binding energy per nucleon (keV)		Beta-decay energy (keV)		Atomic mass μ u		
64	36	100	Kr	x	-35050#	400#	8140#	4#	β^-	11200#	400#	99 962370#	430#
63	37		Rb	x	-46247	20	8244.32	0.20	β^-	13574	21	99 950352	21
62	38		Sr		-59821	7	8372.23	0.07	β^-	7506	13	99 935780	8
61	39		Y	x	-67327	11	8439.48	0.11	β^-	9050	14	99 927721	12
60	40		Zr		-76377	8	8522.15	0.08	β^-	3420	11	99 918005	9
59	41		Nb	IT	-79797	8	8548.53	0.08	β^-	6396	8	99 914334	9
58	42		Mo		-86193.0	0.3	8604.662	0.003	β^-	-172.1	1.4	99 907468.0	0.3
57	43		Tc	-n	-86020.9	1.4	8595.118	0.014	β^-	3206.4	1.4	99 907652.7	1.5
56	44		Ru		-89227.4	0.3	8619.359	0.003		*		99 904210.5	0.4
55	45		Rh		-85591	18	8575.17	0.18	β^+	3636	18	99 908114	19
54	46		Pd		-85213	18	8563.57	0.18	β^+	378	25	99 908520	19
53	47		Ag	x	-78138	5	8484.99	0.05	β^+	7075	18	99 916115	5
52	48		Cd		-74194.6	1.7	8437.737	0.017	β^+	3943	5	99 920348.8	1.8
51	49		In		-64310	180	8331.1	1.8	β^+	9880	180	99 930960	200
50	50		Sn	—	-57280	300	8253	3	β^+	7030	240	99 938500	320
65	36	101	Kr	x	-29130#	500#	8081#	5#	β^-	13720#	540#	100 968730#	540#
64	37		Rb	+	-42850#	200#	8209#	2#	β^-	12480#	200#	100 954000#	220#
63	38		Sr	x	-55325	8	8324.74	0.08	β^-	9736	11	100 940606	9
62	39		Y	x	-65061	7	8413.39	0.07	β^-	8105	11	100 930154	8
61	40		Zr		-73166	8	8485.89	0.08	β^-	5726	9	100 921453	9
60	41		Nb	x	-78891	4	8534.83	0.04	β^-	4628	4	100 915306	4
59	42		Mo	-n	-83519.9	0.3	8572.915	0.003	β^-	2825	24	100 910337.6	0.3
58	43		Tc	+	-86345	24	8593.14	0.24	β^-	1614	24	100 907305	26
57	44		Ru		-87958.1	0.4	8601.365	0.004		*		100 905573.1	0.4
56	45		Rh		-87412	6	8588.22	0.06	β^+	546	6	100 906159	6
55	46		Pd		-85432	5	8560.86	0.05	β^+	1980	4	100 908285	5
54	47		Ag	x	-81334	5	8512.55	0.05	β^+	4098	7	100 912684	5
53	48		Cd	x	-75836.5	1.5	8450.365	0.015	β^+	5498	5	100 918586.2	1.6
52	49		In	x	-68610#	200#	8371#	2#	β^+	7220#	200#	100 926340#	210#
51	50		Sn	ϵ p	-60310	300	8281.1	3.0	β^+	8310#	360#	100 935260	320
65	37	102	Rb	x	-37710#	300#	8157#	3#	β^-	14450#	310#	101 959520#	320#
64	38		Sr	x	-52160	70	8291.2	0.7	β^-	9010	70	101 944000	70
63	39		Y	x	-61173	4	8371.92	0.04	β^-	10415	10	101 934328	4
62	40		Zr		-71588	9	8466.35	0.09	β^-	4717	9	101 923147	9
61	41		Nb		-76304.5	2.5	8504.928	0.025	β^-	7262	9	101 918083.7	2.7
60	42		Mo		-83566	8	8568.45	0.08	β^-	1007	12	101 910288	9
59	43		Tc		-84573	9	8570.65	0.09	β^-	4534	9	101 909207	10
58	44		Ru		-89106.4	0.4	8607.427	0.004	β^-	-2323	6	101 904340.3	0.4
57	45		Rh	—	-86783	6	8576.98	0.06	β^-	1120	6	101 906834	7
56	46		Pd		-87903.2	0.6	8580.290	0.005		*		101 905632.1	0.6
55	47		Ag	+	-82247	8	8517.16	0.08	β^+	5656	8	101 911705	9
54	48		Cd		-79659.7	1.7	8484.131	0.016	β^+	2587	8	101 914481.8	1.8
53	49		In		-70695	5	8388.57	0.04	β^+	8965	5	101 924106	5
52	50		Sn	—	-64930	100	8324.4	1.0	β^+	5760	100	101 930290	110
66	37	103	Rb	x	-33610#	400#	8117#	4#	β^-	13810#	450#	102 963920#	430#
65	38		Sr	x	-47420#	200#	8243#	2#	β^-	11040#	200#	102 949090#	210#
64	39		Y	x	-58458	11	8342.64	0.11	β^-	9358	15	102 937243	12
63	40		Zr	x	-67815	9	8425.89	0.09	β^-	7213	10	102 927197	10
62	41		Nb	x	-75029	4	8488.33	0.04	β^-	5932	10	102 919453	4
61	42		Mo	x	-80961	9	8538.33	0.09	β^-	3643	13	102 913085	10
60	43		Tc	+p	-84604	10	8566.10	0.10	β^-	2663	10	102 909174	11
59	44		Ru		-87267.2	0.4	8584.365	0.004	β^-	764.5	2.3	102 906314.8	0.5
58	45		Rh		-88031.7	2.3	8584.192	0.022		*		102 905494.1	2.5
57	46		Pd	-n	-87457.2	0.9	8571.019	0.009	β^+	574.5	2.4	102 906110.8	1.0
56	47		Ag	x	-84803	4	8537.65	0.04	β^+	2654	4	102 908961	4
55	48		Cd		-80651.6	1.8	8489.754	0.018	β^+	4151	4	102 913416.9	1.9
54	49		In		-74633	10	8423.72	0.09	β^+	6019	10	102 919879	10
53	50		Sn	—	-66970	70	8341.8	0.7	β^+	7660	70	102 928100	80
52	51		Sb	x	-56180#	300#	8229#	3#	β^+	10790#	310#	102 939690#	320#

Table I. The 2012 Atomic mass table (continued, Explanation of Table on p. 030003-6)

N	Z	A	Elt.	Orig.	Mass excess (keV)		Binding energy per nucleon (keV)		Beta-decay energy (keV)		Atomic mass μ		
66	38	104	Sr	x	-44110#	300#	8210#	3#	β^-	9960#	500#	103 952650#	320#
65	39		Y	x	-54060#	400#	8298#	4#	β^-	11660#	400#	103 941960#	430#
64	40		Zr	x	-65724	9	8402.38	0.09	β^-	6095	10	103 929442	10
63	41		Nb	x	-71819.0	2.7	8453.459	0.026	β^-	8531	9	103 922899.1	2.9
62	42		Mo		-80350	9	8527.97	0.09	β^-	2153	24	103 913741	10
61	43		Tc		-82503	25	8541.15	0.24	β^-	5592	25	103 911429	27
60	44		Ru		-88095.7	2.5	8587.399	0.024	β^-	-1136	3	103 905425.4	2.7
59	45		Rh	-n	-86959.3	2.3	8568.949	0.022	β^-	2435.8	2.7	103 906645.3	2.5
58	46		Pd	+n	-89395.1	1.3	8584.848	0.013	*			103 904030.4	1.4
57	47		Ag	-	-85116	4	8536.18	0.04	β^+	4279	4	103 908624	5
56	48		Cd		-83968.4	1.7	8517.622	0.016	β^+	1148	5	103 909856.2	1.8
55	49		In	x	-76183	6	8435.24	0.06	β^+	7786	6	103 918215	6
54	50		Sn		-71627	6	8383.91	0.06	β^+	4556	8	103 923105	6
53	51		Sb	-p	-59170	120	8256.6	1.2	β^+	12450	120	103 936470	130
67	38	105	Sr	x	-38610#	500#	8156#	5#	β^-	12660#	1430#	104 958550#	540#
66	39		Y	x	-51270	1340	8269	13	β^-	10190	1340	104 944960	1440
65	40		Zr	x	-61465	12	8358.66	0.12	β^-	8451	13	104 934015	13
64	41		Nb	x	-69916	4	8431.69	0.04	β^-	7422	10	104 924943	4
63	42		Mo		-77337	9	8494.92	0.09	β^-	4950	40	104 916975	10
62	43		Tc		-82290	40	8534.6	0.3	β^-	3640	40	104 911660	40
61	44		Ru		-85934.5	2.5	8561.900	0.024	β^-	1916.8	2.9	104 907745.5	2.7
60	45		Rh		-87851.2	2.5	8572.704	0.024	β^-	566.6	2.3	104 905687.8	2.7
59	46		Pd		-88417.9	1.1	8570.650	0.011	*			104 905079.5	1.2
58	47		Ag		-87071	5	8550.37	0.04	β^+	1347	5	104 906526	5
57	48		Cd		-84333.8	1.4	8516.852	0.013	β^+	2737	4	104 909463.9	1.5
56	49		In	x	-79641	10	8464.70	0.10	β^+	4693	10	104 914502	11
55	50		Sn		-73338	4	8397.23	0.04	β^+	6303	11	104 921268	4
54	51		Sb	$+\alpha$	-64015	22	8300.99	0.21	β^+	9323	22	104 931277	23
53	52		Te	$-\alpha$	-52810	300	8186.8	2.9	β^+	11200	300	104 943300	320
68	38	106	Sr	x	-34790#	600#	8119#	6#	β^-	11260#	780#	105 962650#	640#
67	39		Y	x	-46050#	500#	8218#	5#	β^-	12500#	660#	105 950560#	540#
66	40		Zr	x	-58550	430	8328	4	β^-	7650	430	105 937140	470
65	41		Nb	x	-66203	4	8393.27	0.04	β^-	9931	10	105 928928	4
64	42		Mo	x	-76135	9	8479.58	0.09	β^-	3642	15	105 918266	10
63	43		Tc	+	-79776	12	8506.56	0.12	β^-	6547	11	105 914357	13
62	44		Ru		-86323	5	8560.94	0.05	β^-	39.40	0.21	105 907328	6
61	45		Rh		-86363	5	8553.93	0.05	β^-	3545	5	105 907286	6
60	46		Pd		-89907.5	1.1	8579.992	0.010	β^-	-2965.1	2.8	105 903480.3	1.2
59	47		Ag		-86942	3	8544.639	0.028	β^-	189.8	2.8	105 906664	3
58	48		Cd		-87132.1	1.1	8539.048	0.010	*			105 906459.8	1.2
57	49		In	-	-80608	12	8470.12	0.12	β^+	6524	12	105 913464	13
56	50		Sn		-77354	5	8432.04	0.05	β^+	3254	13	105 916957	5
55	51		Sb	x	-66473	7	8322.01	0.07	β^+	10880	9	105 928638	8
54	52		Te	$-\alpha$	-58220	100	8236.8	0.9	β^+	8250	100	105 937500	110

Table I. The 2012 Atomic mass table (continued, Explanation of Table on p. 030003-6)

<i>N</i>	<i>Z</i>	<i>A</i>	Elt.	Orig.	Mass excess (keV)		Binding energy per nucleon (keV)		Beta-decay energy (keV)		Atomic mass μ		
69	38	107	Sr	x	-28900#	700#	8064#	7#	β^-	13470#	860#	106 968980#	750#
68	39		Y	x	-42360#	500#	8182#	5#	β^-	12020#	1230#	106 954520#	540#
67	40		Zr	x	-54380	1120	8287	10	β^-	9340	1120	106 941620	1210
66	41		Nb	x	-63724	8	8367.09	0.07	β^-	8828	12	106 931590	9
65	42		Mo	x	-72552	9	8442.28	0.09	β^-	6198	13	106 922113	10
64	43		Tc	x	-78750	9	8492.90	0.08	β^-	5113	12	106 915458	9
63	44		Ru	-nn	-83863	9	8533.37	0.08	β^-	3001	15	106 909970	9
62	45		Rh	+p	-86864	12	8554.10	0.11	β^-	1509	12	106 906748	13
61	46		Pd		-88372.6	1.2	8560.894	0.011	β^-	34.0	2.3	106 905128.1	1.3
60	47		Ag		-88406.7	2.4	8553.900	0.022	*			106 905091.5	2.6
59	48		Cd		-86990.3	1.7	8533.351	0.016	β^+	1416.4	2.6	106 906612.1	1.8
58	49		In	-	-83564	11	8494.02	0.10	β^+	3426	11	106 910290	12
57	50		Sn	x	-78512	5	8439.49	0.05	β^+	5052	12	106 915714	6
56	51		Sb		-70653	4	8358.73	0.04	β^+	7859	7	106 924151	4
55	52		Te	$-\alpha$	-60540	70	8256.9	0.7	β^+	10110	70	106 935010	80
54	53		I	x	-49430#	300#	8146#	3#	β^+	11110#	310#	106 946940#	320#
69	39	108	Y	x	-37300#	600#	8134#	6#	β^-	14060#	720#	107 959960#	640#
68	40		Zr	x	-51350#	400#	8257#	4#	β^-	8190#	400#	107 944870#	430#
67	41		Nb	x	-59546	8	8325.66	0.08	β^-	11210	12	107 936075	9
66	42		Mo	x	-70756	9	8422.22	0.09	β^-	5167	13	107 924040	10
65	43		Tc	x	-75923	9	8462.82	0.08	β^-	7739	12	107 918494	9
64	44		Ru	-3n	-83661	9	8527.23	0.08	β^-	1370	16	107 910186	9
63	45		Rh	x	-85032	14	8532.67	0.13	β^-	4492	14	107 908715	15
62	46		Pd		-89524.2	1.1	8567.023	0.010	β^-	-1917.4	2.6	107 903891.8	1.2
61	47		Ag	-n	-87606.8	2.4	8542.025	0.022	β^-	1645.7	2.6	107 905950.3	2.6
60	48		Cd		-89252.4	1.1	8550.019	0.010	*			107 904183.6	1.2
59	49		In		-84120	9	8495.25	0.08	β^+	5133	9	107 909694	9
58	50		Sn		-82070	5	8469.03	0.05	β^+	2050	10	107 911894	6
57	51		Sb	x	-72445	5	8372.67	0.05	β^+	9625	8	107 922227	6
56	52		Te		-65782	5	8303.72	0.05	β^+	6664	8	107 929380	6
55	53		I	$-\alpha$	-52650	130	8174.9	1.2	β^+	13130	130	107 943480	140
70	39	109	Y	x	-33200#	700#	8096#	6#	β^-	12990#	860#	108 964360#	750#
69	40		Zr	x	-46190#	500#	8208#	5#	β^-	10500#	570#	108 950410#	540#
68	41		Nb	x	-56690	260	8297.1	2.4	β^-	9980	260	108 939140	280
67	42		Mo	x	-66666	11	8381.48	0.10	β^-	7617	15	108 928431	12
66	43		Tc	x	-74283	10	8444.18	0.09	β^-	6456	13	108 920254	10
65	44		Ru	-4n	-80738	9	8496.23	0.08	β^-	4261	10	108 913324	10
64	45		Rh		-84999	4	8528.14	0.04	β^-	2607	4	108 908749	4
63	46		Pd		-87606.5	1.1	8544.882	0.010	β^-	1112.9	1.4	108 905950.6	1.2
62	47		Ag		-88719.4	1.3	8547.915	0.012	*			108 904755.8	1.4
61	48		Cd		-88504.3	1.5	8538.764	0.014	β^+	215.1	1.8	108 904986.7	1.6
60	49		In		-86490	4	8513.10	0.04	β^+	2015	4	108 907150	4
59	50		Sn		-82630	8	8470.52	0.07	β^+	3859	9	108 911293	9
58	51		Sb		-76251	5	8404.82	0.05	β^+	6379	9	108 918141	6
57	52		Te		-67715	4	8319.33	0.04	β^+	8536	7	108 927305	5
56	53		I	-p	-57672	7	8220.02	0.06	β^+	10043	8	108 938086	7
55	54		Xe	$-\alpha$	-46170	300	8107.3	2.8	β^+	11500	300	108 950430	320

Table I. The 2012 Atomic mass table (continued, Explanation of Table on p. 030003-6)

<i>N</i>	<i>Z</i>	<i>A</i>	Elt.	Orig.	Mass excess (keV)		Binding energy per nucleon (keV)		Beta-decay energy (keV)		Atomic mass μu		
70	40	110	Zr	x	-42890#	600#	8177#	5#	β^-	9420#	1030#	109 953960#	640#
69	41		Nb	x	-52310	840	8255	8	β^-	12230	840	109 943840	900
68	42		Mo	x	-64543	24	8359.35	0.22	β^-	6492	26	109 930711	26
67	43		Tc	x	-71035	9	8411.26	0.09	β^-	9038	13	109 923741	10
66	44		Ru		-80073	9	8486.31	0.08	β^-	2756	19	109 914039	10
65	45		Rh		-82829	18	8504.25	0.16	β^-	5502	18	109 911080	19
64	46		Pd		-88330.9	0.6	8547.162	0.006	β^-	-873.6	1.4	109 905172.9	0.7
63	47		Ag		-87457.3	1.3	8532.108	0.012	β^-	2890.7	1.3	109 906110.7	1.4
62	48		Cd		-90348.0	0.4	8551.275	0.003		*		109 903007.5	0.4
61	49		In	-	-86470	12	8508.91	0.11	β^+	3878	12	109 907171	12
60	50		Sn	x	-85842	14	8496.09	0.13	β^+	628	18	109 907845	15
59	51		Sb	x	-77450	6	8412.68	0.05	β^+	8392	15	109 916854	6
58	52		Te		-72230	7	8358.12	0.06	β^+	5220	9	109 922458	7
57	53		I	$-\alpha$	-60460	50	8244.0	0.5	β^+	11770	50	109 935090	50
56	54		Xe	$-\alpha$	-51920	100	8159.3	0.9	β^+	8540	110	109 944260	110
71	40	111	Zr	x	-37560#	700#	8128#	6#	β^-	11320#	760#	110 959680#	750#
70	41		Nb	x	-48880#	300#	8223#	3#	β^-	11060#	300#	110 947530#	320#
69	42		Mo	+	-59940	13	8315.29	0.11	β^-	9085	7	110 935652	14
68	43		Tc	x	-69025	11	8390.09	0.10	β^-	7761	14	110 925899	11
67	44		Ru	x	-76785	10	8452.96	0.09	β^-	5519	12	110 917568	10
66	45		Rh		-82304	7	8495.63	0.06	β^-	3681	7	110 911643	7
65	46		Pd	-n	-85985.9	0.7	8521.749	0.007	β^-	2229.6	1.6	110 907690.3	0.8
64	47		Ag	+	-88215.4	1.5	8534.787	0.013	β^-	1036.8	1.4	110 905296.8	1.6
63	48		Cd		-89252.2	0.4	8537.079	0.003		*		110 904183.8	0.4
62	49		In		-88392	3	8522.28	0.03	β^+	860	3	110 905107	4
61	50		Sn	+n	-85939	5	8493.13	0.05	β^+	2453	6	110 907741	6
60	51		Sb	x	-80837	9	8440.12	0.08	β^+	5102	10	110 913218	10
59	52		Te	x	-73587	6	8367.76	0.06	β^+	7249	11	110 921001	7
58	53		I		-64954	5	8282.93	0.04	β^+	8634	8	110 930269	5
57	54		Xe	$-\alpha$	-54400	90	8180.8	0.8	β^+	10560	90	110 941600	90
56	55		Cs	x	-42820#	200#	8069#	2#	β^+	11580#	210#	110 954030#	210#
72	40	112	Zr	x	-33810#	700#	8094#	6#	β^-	10460#	760#	111 963700#	750#
71	41		Nb	x	-44270#	300#	8180#	3#	β^-	13190#	360#	111 952470#	320#
70	42		Mo	x	-57460#	200#	8291#	2#	β^-	7800#	200#	111 938310#	210#
69	43		Tc	x	-65259	6	8353.62	0.05	β^-	10372	11	111 929942	6
68	44		Ru	x	-75631	10	8439.24	0.09	β^-	4100	50	111 918807	10
67	45		Rh		-79730	40	8468.9	0.4	β^-	6590	40	111 914400	50
66	46		Pd		-86322	7	8520.72	0.06	β^-	262	7	111 907330	7
65	47		Ag	x	-86583.7	2.4	8516.080	0.022	β^-	3991.1	2.4	111 907048.6	2.6
64	48		Cd		-90574.86	0.25	8544.730	0.002	β^-	-2585	4	111 902763.88	0.27
63	49		In		-87990	4	8514.67	0.04	β^-	665	4	111 905539	5
62	50		Sn		-88655.06	0.29	8513.618	0.003		*		111 904824.9	0.3
61	51		Sb	x	-81599	18	8443.63	0.16	β^+	7056	18	111 912400	19
60	52		Te	x	-77568	8	8400.65	0.07	β^+	4031	20	111 916728	9
59	53		I	x	-67063	10	8299.88	0.09	β^+	10504	13	111 928005	11
58	54		Xe	$-\alpha$	-60026	8	8230.06	0.07	β^+	7037	13	111 935559	9
57	55		Cs	-p	-46290	90	8100.4	0.8	β^+	13740	90	111 950310	90

Table I. The 2012 Atomic mass table (continued, Explanation of Table on p. 030003-6)

<i>N</i>	<i>Z</i>	<i>A</i>	Elt.	Orig.	Mass excess (keV)		Binding energy per nucleon (keV)		Beta-decay energy (keV)		Atomic mass μ		
72	41	113	Nb	x	-40510#	400#	8146#	4#	β^-	11980#	500#	112 956510#	430#
71	42		Mo	x	-52490#	300#	8245#	3#	β^-	10320#	300#	112 943650#	320#
70	43		Tc	x	-62812	3	8329.464	0.030	β^-	9060	40	112 932569	4
69	44		Ru		-71870	40	8402.7	0.3	β^-	6900	40	112 922850	40
68	45		Rh	x	-78768	7	8456.82	0.06	β^-	4824	10	112 915440	8
67	46		Pd	x	-83591	7	8492.58	0.06	β^-	3436	18	112 910261	7
66	47		Ag	+	-87027	17	8516.07	0.15	β^-	2016	17	112 906573	18
65	48		Cd		-89043.28	0.24	8526.987	0.002	β^-	323.83	0.27	112 904408.10	0.26
64	49		In		-89367.12	0.19	8522.929	0.002		*		112 904060.45	0.20
63	50		Sn		-88328.1	1.6	8506.811	0.014	β^+	1039.0	1.6	112 905175.8	1.7
62	51		Sb	-	-84417	17	8465.28	0.15	β^+	3911	17	112 909375	18
61	52		Te	x	-78347	28	8404.64	0.25	β^+	6070	30	112 915890	30
60	53		I	x	-71120	8	8333.75	0.07	β^+	7228	29	112 923650	9
59	54		Xe		-62204	7	8247.93	0.06	β^+	8916	11	112 933222	7
58	55		Cs	-p	-51765	9	8148.62	0.08	β^+	10439	11	112 944428	9
57	56		Ba	x	-39780#	300#	8036#	3#	β^+	11980#	300#	112 957290#	320#
73	41	114	Nb	x	-35390#	500#	8100#	4#	β^-	14420#	590#	113 962010#	540#
72	42		Mo	x	-49810#	300#	8220#	3#	β^-	8790#	530#	113 946530#	320#
71	43		Tc	x	-58600	430	8290	4	β^-	11620	430	113 937090	470
70	44		Ru	x	-70222	4	8385.34	0.03	β^-	5490	70	113 924614	4
69	45		Rh		-75710	70	8426.6	0.6	β^-	7780	70	113 918720	80
68	46		Pd	x	-83491	7	8488.01	0.06	β^-	1440	8	113 910369	7
67	47		Ag	x	-84931	5	8493.78	0.04	β^-	5084	5	113 908823	5
66	48		Cd		-90014.93	0.28	8531.513	0.002	β^-	-1445.1	0.4	113 903364.99	0.30
65	49		In		-88569.8	0.3	8511.973	0.003	β^-	1989.9	0.3	113 904916.4	0.3
64	50		Sn		-90559.723	0.029	8522.566	<i>a</i>		*		113 902780.13	0.03
63	51		Sb		-84497	22	8462.52	0.19	β^+	6063	22	113 909289	23
62	52		Te	x	-81889	28	8432.78	0.25	β^+	2610	40	113 912090	30
61	53		I	x	-72800#	150#	8346#	1#	β^+	9090#	150#	113 921850#	160#
60	54		Xe	x	-67086	11	8289.20	0.10	β^+	5710#	150#	113 927980	12
59	55		Cs	$-\alpha$	-54680	70	8173.5	0.6	β^+	12400	70	113 941300	80
58	56		Ba	$-\alpha$	-45910	100	8089.7	0.9	β^+	8780	120	113 950720	110
74	41	115	Nb	x	-31350#	500#	8065#	4#	β^-	13400#	640#	114 966340#	540#
73	42		Mo	x	-44750#	400#	8175#	3#	β^-	11570#	890#	114 951960#	430#
72	43		Tc	x	-56320	790	8269	7	β^-	9870	790	114 939540	850
71	44		Ru	x	-66190	90	8347.5	0.8	β^-	8040	90	114 928940	100
70	45		Rh	x	-74230	7	8410.66	0.06	β^-	6197	15	114 920311	8
69	46		Pd		-80426	14	8457.74	0.12	β^-	4556	22	114 913659	15
68	47		Ag		-84983	18	8490.56	0.16	β^-	3102	18	114 908767	20
67	48		Cd		-88084.5	0.7	8510.724	0.006	β^-	1451.9	0.7	114 905437.4	0.7
66	49		In		-89536.346	0.012	8516.546	<i>a</i>	β^-	497.489	0.010	114 903878.774	0.013
65	50		Sn		-90033.835	0.015	8514.069	<i>a</i>		*		114 903344.697	0.016
64	51		Sb	x	-87003	16	8480.91	0.14	β^+	3030	16	114 906598	17
63	52		Te	x	-82063	28	8431.15	0.24	β^+	4940	30	114 911900	30
62	53		I	x	-76338	29	8374.56	0.25	β^+	5720	40	114 918050	30
61	54		Xe	x	-68657	12	8300.97	0.11	β^+	7680	30	114 926294	13
60	55		Cs	x	-59700#	100#	8216#	1#	β^+	8960#	100#	114 935910#	110#
59	56		Ba	x	-49020#	200#	8117#	2#	β^+	10680#	230#	114 947380#	220#

Table I. The 2012 Atomic mass table (continued, Explanation of Table on p. 030003-6)

<i>N</i>	<i>Z</i>	<i>A</i>	Elt.	Orig.	Mass excess (keV)		Binding energy per nucleon (keV)		Beta-decay energy (keV)		Atomic mass μu		
74	42	116	Mo	x	-41500#	500#	8146#	4#	β^-	9960#	580#	115 955450#	540#
73	43		Tc	x	-51460#	300#	8225#	3#	β^-	12610#	300#	115 944760#	320#
72	44		Ru	x	-64069	4	8326.88	0.03	β^-	6670	70	115 931219	4
71	45		Rh		-70740	70	8377.6	0.6	β^-	9100	70	115 924060	80
70	46		Pd	x	-79832	7	8449.28	0.06	β^-	2711	8	115 914297	8
69	47		Ag	x	-82543	3	8465.907	0.028	β^-	6170	3	115 911387	4
68	48		Cd		-88712.48	0.16	8512.350	0.001	β^-	-462.73	0.27	115 904763.23	0.17
67	49		In	-n	-88249.75	0.22	8501.617	0.002	β^-	3276.22	0.24	115 905259.99	0.24
66	50		Sn		-91525.97	0.10	8523.116	0.001	*			115 901742.82	0.10
65	51		Sb		-86822	5	8475.82	0.04	β^+	4704	5	115 906793	6
64	52		Te	x	-85269	28	8455.69	0.24	β^+	1553	28	115 908460	30
63	53		I	+	-77490	100	8381.9	0.8	β^+	7780	100	115 916810	100
62	54		Xe	x	-73047	13	8336.83	0.11	β^+	4450	100	115 921581	14
61	55		Cs	ea	-62040#	100#	8235#	1#	β^+	11000#	100#	115 933400#	110#
60	56		Ba	x	-54580#	200#	8164#	2#	β^+	7460#	220#	115 941410#	220#
59	57		La	$-\alpha$	-40650#	310#	8037#	3#	β^+	13940#	370#	115 956370#	340#
75	42	117	Mo	x	-36170#	500#	8100#	4#	β^-	12210#	640#	116 961170#	540#
74	43		Tc	x	-48380#	400#	8197#	3#	β^-	11110#	590#	116 948060#	430#
73	44		Ru	x	-59490	430	8286	4	β^-	9410	430	116 936140	470
72	45		Rh	x	-68897	9	8359.28	0.08	β^-	7527	11	116 926036	10
71	46		Pd		-76424	7	8416.93	0.06	β^-	5758	15	116 917955	8
70	47		Ag		-82182	14	8459.45	0.12	β^-	4236	14	116 911774	15
69	48		Cd	-n	-86418.4	1.0	8488.973	0.009	β^-	2525	5	116 907226.0	1.1
68	49		In		-88943	5	8503.86	0.04	β^-	1455	5	116 904516	5
67	50		Sn		-90397.8	0.5	8509.611	0.004	*			116 902954.0	0.5
66	51		Sb		-88640	8	8487.90	0.07	β^+	1758	8	116 904842	9
65	52		Te		-85095	13	8450.92	0.12	β^+	3544	13	116 908646	14
64	53		I		-80436	26	8404.41	0.22	β^+	4659	29	116 913648	28
63	54		Xe	x	-74185	10	8344.30	0.09	β^+	6251	28	116 920359	11
62	55		Cs	x	-66490	60	8271.9	0.5	β^+	7690	60	116 928620	70
61	56		Ba	ϵp	-57460	250	8188.0	2.1	β^+	9040	260	116 938320	270
60	57		La	-p	-46470#	200#	8087#	2#	β^+	10990#	320#	116 950110#	220#
76	42	118	Mo	x	-32630#	500#	8069#	4#	β^-	11160#	640#	117 964970#	540#
75	43		Tc	x	-43790#	400#	8157#	3#	β^-	13470#	450#	117 952990#	430#
74	44		Ru	x	-57260#	200#	8265#	2#	β^-	7630#	200#	117 938530#	220#
73	45		Rh	x	-64887	24	8322.86	0.21	β^-	10501	24	117 930340	26
72	46		Pd		-75388.7	2.5	8405.222	0.021	β^-	4165	4	117 919066.8	2.7
71	47		Ag	x	-79553.8	2.5	8433.889	0.021	β^-	7148	20	117 914595.5	2.7
70	48		Cd	-nn	-86702	20	8487.83	0.17	β^-	527	21	117 906922	21
69	49		In		-87228	8	8485.67	0.07	β^-	4425	8	117 906357	8
68	50		Sn		-91652.9	0.5	8516.533	0.004	*			117 901606.6	0.5
67	51		Sb	-	-87996	3	8478.915	0.026	β^+	3656.6	3.0	117 905532	3
66	52		Te	+nn	-87697	18	8469.75	0.16	β^+	300	19	117 905854	20
65	53		I	x	-80971	20	8406.12	0.17	β^+	6726	27	117 913074	21
64	54		Xe	x	-78079	10	8374.98	0.09	β^+	2892	22	117 916179	11
63	55		Cs	IT	-68409	13	8286.40	0.11	β^+	9670	16	117 926560	14
62	56		Ba	x	-62350#	200#	8228#	2#	β^+	6060#	200#	117 933060#	210#
61	57		La	x	-49560#	300#	8113#	3#	β^+	12790#	360#	117 946800#	320#

Table I. The 2012 Atomic mass table (continued, Explanation of Table on p. 030003-6)

<i>N</i>	<i>Z</i>	<i>A</i>	Elt.	Orig.	Mass excess (keV)		Binding energy per nucleon (keV)		Beta-decay energy (keV)		Atomic mass μ		
76	43	119	Tc	x	-40370#	500#	8128#	4#	β^-	12190#	590#	118 956660#	540#
75	44		Ru	x	-52560#	300#	8224#	3#	β^-	10260#	300#	118 943570#	320#
74	45		Rh	x	-62823	9	8303.39	0.08	β^-	8585	12	118 932557	10
73	46		Pd	x	-71408	8	8368.96	0.07	β^-	7238	17	118 923340	9
72	47		Ag		-78646	15	8423.21	0.12	β^-	5330	40	118 915570	16
71	48		Cd		-83980	40	8461.4	0.3	β^-	3720	40	118 909850	40
70	49		In		-87699	7	8486.14	0.06	β^-	2366	7	118 905851	8
69	50		Sn		-90065.0	0.7	8499.449	0.006	*			118 903311.2	0.8
68	51		Sb		-89474	8	8487.91	0.06	β^+	591	8	118 903946	8
67	52		Te	—	-87181	8	8462.07	0.07	β^+	2293.0	2.0	118 906407	9
66	53		I	x	-83766	28	8426.79	0.23	β^+	3416	29	118 910070	30
65	54		Xe	x	-78794	10	8378.44	0.09	β^+	4971	30	118 915411	11
64	55		Cs	IT	-72305	14	8317.33	0.12	β^+	6489	17	118 922377	15
63	56		Ba	ϵ p	-64590	200	8245.9	1.7	β^+	7710	200	118 930660	210
62	57		La	x	-54790#	300#	8157#	3#	β^+	9800#	360#	118 941180#	320#
61	58		Ce	x	-43940#	500#	8059#	4#	β^+	10850#	580#	118 952830#	540#
77	43	120	Tc	x	-35520#	500#	8087#	4#	β^-	14490#	640#	119 961870#	540#
76	44		Ru	x	-50010#	400#	8201#	3#	β^-	8800#	450#	119 946310#	430#
75	45		Rh	x	-58820#	200#	8268#	2#	β^-	11470#	200#	119 936860#	210#
74	46		Pd		-70280.1	2.3	8357.085	0.019	β^-	5371	5	119 924551.3	2.5
73	47		Ag	x	-75652	4	8395.33	0.04	β^-	8306	6	119 918785	5
72	48		Cd	x	-83957	4	8458.02	0.03	β^-	1770	40	119 909868	4
71	49		In	+	-85730	40	8466.3	0.3	β^-	5370	40	119 907970	40
70	50		Sn		-91098.4	0.9	8504.492	0.007	β^-	-2681	7	119 902201.9	1.0
69	51		Sb	—	-88418	7	8475.63	0.06	β^-	950	8	119 905080	8
68	52		Te		-89368	3	8477.034	0.026	*			119 904060	3
67	53		I	—	-83753	15	8423.72	0.13	β^+	5615	15	119 910087	16
66	54		Xe	x	-82172	12	8404.03	0.10	β^+	1581	19	119 911784	13
65	55		Cs	IT	-73889	10	8328.48	0.08	β^+	8284	15	119 920677	11
64	56		Ba	—	-68890	300	8280.3	2.5	β^+	5000	300	119 926050	320
63	57		La	x	-57570#	300#	8179#	2#	β^+	11320#	420#	119 938200#	320#
62	58		Ce	x	-49600#	500#	8107#	4#	β^+	7970#	580#	119 946750#	540#
78	43	121	Tc	x	-31780#	500#	8056#	4#	β^-	13270#	640#	120 965880#	540#
77	44		Ru	x	-45050#	400#	8159#	3#	β^-	11200#	740#	120 951640#	430#
76	45		Rh	x	-56250	620	8245	5	β^-	9930	620	120 939610	670
75	46		Pd	x	-66182	3	8320.858	0.028	β^-	8220	13	120 928950	4
74	47		Ag	x	-74403	12	8382.33	0.10	β^-	6671	12	120 920125	13
73	48		Cd	x	-81073.8	1.9	8430.996	0.016	β^-	4762	27	120 912963.7	2.1
72	49		In	+p	-85836	27	8463.89	0.23	β^-	3361	27	120 907851	29
71	50		Sn		-89197.3	1.0	8485.201	0.008	β^-	403.1	2.7	120 904242.8	1.0
70	51		Sb		-89600.3	2.6	8482.066	0.021	*			120 903810.1	2.8
69	52		Te		-88546	26	8466.88	0.21	β^+	1055	26	120 904942	28
68	53		I		-86251	5	8441.46	0.04	β^+	2294	26	120 907405	6
67	54		Xe		-82481	10	8403.83	0.08	β^+	3770	12	120 911453	11
66	55		Cs		-77102	14	8352.91	0.12	β^+	5379	14	120 917227	15
65	56		Ba	—	-70740	140	8293.9	1.2	β^+	6360	140	120 924050	150
64	57		La	x	-62190#	300#	8217#	2#	β^+	8560#	330#	120 933240#	320#
63	58		Ce	x	-52690#	400#	8132#	3#	β^+	9500#	500#	120 943440#	430#
62	59		Pr	-p	-41420#	500#	8032#	4#	β^+	11270#	640#	120 955530#	540#

Table I. The 2012 Atomic mass table (continued, Explanation of Table on p. 030003-6)

<i>N</i>	<i>Z</i>	<i>A</i>	Elt.	Orig.	Mass excess (keV)		Binding energy per nucleon (keV)		Beta-decay energy (keV)		Atomic mass μ u		
78	44	122	Ru	x	-42150#	500#	8135#	4#	β^-	9930#	580#	121 954750#	540#
77	45		Rh	x	-52080#	300#	8210#	2#	β^-	12540#	300#	121 944090#	320#
76	46		Pd	x	-64616	20	8305.97	0.16	β^-	6490	40	121 930632	21
75	47		Ag	x	-71110	40	8352.8	0.3	β^-	9510	40	121 923660	40
74	48		Cd		-80612.4	2.3	8424.266	0.019	β^-	2960	50	121 913459.1	2.5
73	49		In	+	-83570	50	8442.1	0.4	β^-	6370	50	121 910280	50
72	50		Sn		-89941.3	2.4	8487.907	0.020	β^-	-1606	3	121 903444.0	2.6
71	51		Sb		-88335.4	2.6	8468.331	0.021	β^-	1979.1	2.1	121 905168.1	2.8
70	52		Te		-90314.5	1.5	8478.140	0.012	*			121 903043.4	1.6
69	53		I	-	-86080	5	8437.02	0.04	β^+	4234	5	121 907589	6
68	54		Xe	x	-85355	11	8424.66	0.09	β^+	725	12	121 908368	12
67	55		Cs		-78140	30	8359.15	0.28	β^+	7210	40	121 916110	40
66	56		Ba	x	-74609	28	8323.76	0.23	β^+	3540	40	121 919900	30
65	57		La	x	-64540#	300#	8235#	2#	β^+	10070#	300#	121 930710#	320#
64	58		Ce	x	-57870#	400#	8174#	3#	β^+	6670#	500#	121 937870#	430#
63	59		Pr	x	-44780#	500#	8060#	4#	β^+	13090#	640#	121 951930#	540#
79	44	123	Ru	x	-37080#	500#	8093#	4#	β^-	12280#	640#	122 960190#	540#
78	45		Rh	x	-49360#	400#	8186#	3#	β^-	11070#	890#	122 947010#	430#
77	46		Pd	x	-60430	790	8270	6	β^-	9120	790	122 935130	850
76	47		Ag	x	-69550	30	8337.80	0.25	β^-	7870	30	122 925340	30
75	48		Cd		-77414.2	2.7	8395.395	0.022	β^-	6016	20	122 916892.5	2.9
74	49		In		-83430	20	8437.95	0.16	β^-	4386	20	122 910434	21
73	50		Sn		-87816.2	2.4	8467.243	0.020	β^-	1407.9	2.7	122 905725.4	2.6
72	51		Sb		-89224.1	1.5	8472.328	0.012	*			122 904214.0	1.6
71	52		Te		-89172.2	1.5	8465.546	0.012	β^+	51.91	0.07	122 904269.7	1.6
70	53		I		-87944	4	8449.20	0.03	β^+	1228	3	122 905589	4
69	54		Xe		-85249	10	8420.93	0.08	β^+	2695	10	122 908482	10
68	55		Cs	x	-81044	12	8380.38	0.10	β^+	4205	15	122 912996	13
67	56		Ba	x	-75655	12	8330.21	0.10	β^+	5389	17	122 918781	13
66	57		La	x	-68650#	200#	8267#	2#	β^+	7000#	200#	122 926300#	210#
65	58		Ce	x	-60290#	300#	8193#	2#	β^+	8370#	360#	122 935280#	320#
64	59		Pr	x	-50230#	400#	8104#	3#	β^+	10060#	500#	122 946080#	430#
80	44	124	Ru	x	-33960#	600#	8068#	5#	β^-	10930#	720#	123 963540#	640#
79	45		Rh	x	-44890#	400#	8149#	3#	β^-	13500#	500#	123 951810#	430#
78	46		Pd	x	-58390#	300#	8252#	2#	β^-	7810#	390#	123 937320#	320#
77	47		Ag	x	-66200	250	8308.7	2.0	β^-	10500	250	123 928930	270
76	48		Cd		-76701.7	3.0	8387.035	0.024	β^-	4170	30	123 917657	3
75	49		In		-80870	30	8414.34	0.25	β^-	7360	30	123 913180	30
74	50		Sn		-88234.2	1.0	8467.421	0.008	β^-	-613.9	1.5	123 905276.7	1.1
73	51		Sb	-n	-87620.2	1.5	8456.160	0.012	β^-	2905.07	0.13	123 905935.8	1.6
72	52		Te		-90525.3	1.5	8473.279	0.012	β^-	-3159.6	1.9	123 902817.1	1.6
71	53		I	-	-87365.7	2.4	8441.489	0.019	β^-	295.7	2.8	123 906209.0	2.6
70	54		Xe		-87661.4	1.8	8437.565	0.014	*			123 905891.6	1.9
69	55		Cs	x	-81731	8	8383.43	0.07	β^+	5930	8	123 912258	9
68	56		Ba	x	-79090	12	8355.82	0.10	β^+	2642	15	123 915094	13
67	57		La	x	-70260	60	8278.3	0.5	β^+	8830	60	123 924570	60
66	58		Ce	x	-64920#	300#	8229#	2#	β^+	5340#	300#	123 930310#	320#
65	59		Pr	x	-53150#	400#	8128#	3#	β^+	11770#	500#	123 942940#	430#
64	60		Nd	x	-44530#	500#	8052#	4#	β^+	8630#	640#	123 952200#	540#

Table I. The 2012 Atomic mass table (continued, Explanation of Table on p. 030003-6)

<i>N</i>	<i>Z</i>	<i>A</i>	El.	Orig.	Mass excess (keV)		Binding energy per nucleon (keV)		Beta-decay energy (keV)		Atomic mass μ u		
80	45	125	Rh	x	-42000#	500#	8126#	4#	β^-	12120#	640#	124 954910#	540#
79	46		Pd	x	-54120#	400#	8216#	3#	β^-	10400#	590#	124 941900#	430#
78	47		Ag	x	-64520	430	8293	3	β^-	8830	430	124 930740	470
77	48		Cd		-73348.1	2.9	8357.681	0.023	β^-	7129	27	124 921258	3
76	49		In		-80477	27	8408.45	0.22	β^-	5420	27	124 913605	29
75	50		Sn		-85896.4	1.0	8445.550	0.008	β^-	2359.9	2.6	124 907786.4	1.1
74	51		Sb	+	-88256.3	2.6	8458.170	0.021	β^-	766.7	2.1	124 905253.0	2.8
73	52		Te		-89023.0	1.5	8458.045	0.012	*			124 904429.9	1.6
72	53		I	-	-88837.2	1.5	8450.300	0.012	β^+	185.77	0.06	124 904629.3	1.6
71	54		Xe		-87193.4	1.8	8430.890	0.015	β^+	1643.8	2.2	124 906394.1	2.0
70	55		Cs		-84088	8	8399.79	0.06	β^+	3105	8	124 909728	8
69	56		Ba		-79669	11	8358.18	0.09	β^+	4419	13	124 914472	12
68	57		La		-73759	26	8304.64	0.21	β^+	5909	28	124 920816	28
67	58		Ce	x	-66660#	200#	8242#	2#	β^+	7100#	200#	124 928440#	210#
66	59		Pr	x	-57940#	300#	8166#	2#	β^+	8720#	360#	124 937800#	320#
65	60		Nd	x	-47600#	400#	8077#	3#	β^+	10340#	500#	124 948900#	430#
81	45	126	Rh	x	-37300#	500#	8088#	4#	β^-	14560#	640#	125 959960#	540#
80	46		Pd	x	-51860#	400#	8197#	3#	β^-	8820#	450#	125 944330#	430#
79	47		Ag	x	-60680#	200#	8261#	2#	β^-	11580#	200#	125 934860#	220#
78	48		Cd		-72256.8	2.5	8346.747	0.020	β^-	5516	27	125 922429.1	2.7
77	49		In		-77773	27	8384.32	0.21	β^-	8242	27	125 916507	29
76	50		Sn		-86015	10	8443.52	0.08	β^-	380	30	125 907659	11
75	51		Sb	-	-86390	30	8440.31	0.25	β^-	3670	30	125 907250	30
74	52		Te		-90065.3	1.5	8463.248	0.012	β^-	-2154	4	125 903310.9	1.6
73	53		I		-87911	4	8439.94	0.03	β^-	1236	5	125 905623	4
72	54		Xe		-89147	3	8443.541	0.028	*			125 904297	4
71	55		Cs		-84351	10	8399.27	0.08	β^+	4796	11	125 909446	11
70	56		Ba	x	-82670	12	8379.72	0.10	β^+	1681	16	125 911250	13
69	57		La	x	-74970	90	8312.4	0.7	β^+	7700	90	125 919510	100
68	58		Ce	x	-70821	28	8273.26	0.22	β^+	4150	90	125 923970	30
67	59		Pr	x	-60320#	200#	8184#	2#	β^+	10500#	200#	125 935240#	210#
66	60		Nd	x	-52990#	300#	8119#	2#	β^+	7330#	360#	125 943110#	320#
65	61		Pm	x	-39350#	500#	8005#	4#	β^+	13640#	580#	125 957760#	540#
82	45	127	Rh	x	-34030#	600#	8062#	5#	β^-	13150#	780#	126 963470#	640#
81	46		Pd	x	-47180#	500#	8159#	4#	β^-	11260#	540#	126 949350#	540#
80	47		Ag	x	-58440#	200#	8242#	2#	β^-	10310#	200#	126 937260#	220#
79	48		Cd	x	-68747	12	8316.95	0.10	β^-	8149	24	126 926197	13
78	49		In		-76896	21	8374.95	0.17	β^-	6575	19	126 917449	23
77	50		Sn		-83471	10	8420.56	0.08	β^-	3229	11	126 910390	11
76	51		Sb		-86699	5	8439.82	0.04	β^-	1582	5	126 906924	6
75	52		Te		-88281.7	1.5	8446.118	0.012	β^-	702	4	126 905225.7	1.6
74	53		I		-88984	4	8445.487	0.029	*			126 904472	4
73	54		Xe		-88322	4	8434.11	0.03	β^+	662.3	2.0	126 905183	4
72	55		Cs		-86240	6	8411.56	0.04	β^+	2081	6	126 907417	6
71	56		Ba		-82818	11	8378.46	0.09	β^+	3422	13	126 911091	12
70	57		La		-77896	26	8333.54	0.20	β^+	4922	28	126 916375	28
69	58		Ce	x	-71979	29	8280.79	0.23	β^+	5920	40	126 922730	30
68	59		Pr	x	-64540#	200#	8216#	2#	β^+	7440#	200#	126 930710#	210#
67	60		Nd	x	-55540#	300#	8139#	2#	β^+	9010#	360#	126 940380#	320#
66	61		Pm	x	-44790#	400#	8048#	3#	β^+	10750#	500#	126 951920#	430#

Table I. The 2012 Atomic mass table (continued, Explanation of Table on p. 030003-6)

<i>N</i>	<i>Z</i>	<i>A</i>	Elt.	Orig.	Mass excess (keV)		Binding energy per nucleon (keV)		Beta-decay energy (keV)		Atomic mass μ		
82	46	128	Pd	x	-44490#	500#	8138#	4#	β^-	10130#	580#	127 952240#	540#
81	47		Ag	x	-54620#	300#	8211#	2#	β^-	12620#	300#	127 941360#	320#
80	48		Cd		-67242	7	8303.26	0.06	β^-	6900	150	127 927813	8
79	49		In		-74150	150	8351.1	1.2	β^-	9220	150	127 920400	160
78	50		Sn		-83362	18	8416.98	0.14	β^-	1268	14	127 910507	19
77	51		Sb	IT	-84630	19	8420.78	0.15	β^-	4363	19	127 909146	21
76	52		Te		-88993.7	0.9	8448.752	0.007	β^-	-1255	4	127 904461.3	0.9
75	53		I		-87739	4	8432.836	0.028	β^-	2122	4	127 905809	4
74	54		Xe		-89860.3	1.1	8443.298	0.008	*			127 903531.0	1.1
73	55		Cs		-85932	5	8406.49	0.04	β^+	3929	5	127 907749	6
72	56		Ba		-85378	5	8396.06	0.04	β^+	553	8	127 908342	6
71	57		La	x	-78630	50	8337.2	0.4	β^+	6750	50	127 915590	60
70	58		Ce	x	-75534	28	8306.93	0.22	β^+	3090	60	127 918910	30
69	59		Pr	x	-66331	30	8228.91	0.23	β^+	9200	40	127 928790	30
68	60		Nd	x	-60310#	200#	8176#	2#	β^+	6020#	200#	127 935250#	210#
67	61		Pm	x	-47790#	300#	8072#	2#	β^+	12530#	360#	127 948700#	320#
66	62		Sm	x	-38670#	500#	7994#	4#	β^+	9120#	580#	127 958490#	540#
83	46	129	Pd	x	-37610#	600#	8084#	5#	β^-	14370#	720#	128 959620#	640#
82	47		Ag	x	-51980#	400#	8189#	3#	β^-	11080#	400#	128 944200#	430#
81	48		Cd	x	-63058	17	8269.03	0.13	β^-	9780	17	128 932304	18
80	49		In		-72837.7	2.7	8338.780	0.021	β^-	7753	17	128 921805.5	2.9
79	50		Sn		-80591	17	8392.82	0.13	β^-	4038	27	128 913482	19
78	51		Sb	+	-84629	21	8418.06	0.16	β^-	2375	21	128 909147	23
77	52		Te		-87004.8	0.9	8430.409	0.007	β^-	1502	3	128 906596.5	0.9
76	53		I		-88507	3	8435.990	0.025	β^-	189	3	128 904984	3
75	54		Xe		-88696.059	0.005	8431.390	<i>a</i>	*			128 904780.859	0.006
74	55		Cs		-87499	5	8416.05	0.04	β^+	1197	5	128 906066	5
73	56		Ba		-85063	11	8391.10	0.08	β^+	2436	11	128 908681	11
72	57		La		-81325	21	8356.05	0.17	β^+	3739	22	128 912694	23
71	58		Ce	x	-76287	28	8310.94	0.22	β^+	5040	40	128 918100	30
70	59		Pr	x	-69774	30	8254.38	0.23	β^+	6510	40	128 925100	30
69	60		Nd	ϵ p	-62320#	200#	8190#	2#	β^+	7460#	200#	128 933100#	220#
68	61		Pm	x	-52880#	300#	8111#	2#	β^+	9430#	360#	128 943230#	320#
67	62		Sm	x	-42000#	500#	8021#	4#	β^+	10880#	580#	128 954910#	540#
83	47	130	Ag	-nn	-45700#	500#	8140#	4#	β^-	15420#	500#	129 950940#	540#
82	48		Cd	x	-61118	22	8252.59	0.17	β^-	8770	40	129 934388	24
81	49		In	+	-69880	40	8314.00	0.29	β^-	10250	40	129 924980	40
80	50		Sn		-80132.2	1.9	8386.816	0.014	β^-	2153	14	129 913974.5	2.0
79	51		Sb		-82286	14	8397.36	0.11	β^-	5067	14	129 911663	15
78	52		Te		-87352.949	0.011	8430.324	<i>a</i>	β^-	-417	3	129 906222.747	0.012
77	53		I	-n	-86936	3	8421.100	0.024	β^-	2944	3	129 906670	3
76	54		Xe		-89880.463	0.009	8437.731	<i>a</i>	β^-	-2981	8	129 903509.349	0.010
75	55		Cs		-86900	8	8408.78	0.06	β^-	362	9	129 906709	9
74	56		Ba		-87261.5	2.6	8405.549	0.020	*			129 906320.9	2.7
73	57		La	x	-81627	26	8356.19	0.20	β^+	5634	26	129 912369	28
72	58		Ce	x	-79423	28	8333.22	0.21	β^+	2200	40	129 914740	30
71	59		Pr	x	-71180	60	8263.8	0.5	β^+	8250	70	129 923590	70
70	60		Nd	x	-66596	28	8222.51	0.21	β^+	4580	70	129 928510	30
69	61		Pm	x	-55400#	200#	8130#	2#	β^+	11200#	200#	129 940530#	210#
68	62		Sm	x	-47510#	400#	8064#	3#	β^+	7890#	450#	129 949000#	430#
67	63		Eu	-p	-33680#	500#	7951#	4#	β^+	13820#	640#	129 963840#	540#

Table I. The 2012 Atomic mass table (continued, Explanation of Table on p. 030003-6)

<i>N</i>	<i>Z</i>	<i>A</i>	Elt.	Orig.	Mass excess (keV)		Binding energy per nucleon (keV)		Beta-decay energy (keV)		Atomic mass μ		
84	47	131	Ag	x	-40380#	500#	8099#	4#	β^-	14840#	510#	130 956650#	540#
83	48		Cd	x	-55220	100	8206.2	0.8	β^-	12810	100	130 940720	110
82	49		In	x	-68025.0	2.7	8297.959	0.021	β^-	9240	5	130 926972.1	2.9
81	50		Sn		-77265	4	8362.517	0.028	β^-	4717	4	130 917053	4
80	51		Sb		-81981.4	2.1	8392.552	0.016	β^-	3229.6	2.1	130 911989.3	2.2
79	52		Te	-n	-85211.01	0.06	8411.233	0.001	β^-	2231.7	0.6	130 908522.21	0.07
78	53		I	+	-87442.7	0.6	8422.297	0.005	β^-	970.8	0.6	130 906126.4	0.6
77	54		Xe		-88413.558	0.009	8423.736	<i>a</i>		*		130 905084.136	0.009
76	55		Cs		-88059	5	8415.06	0.04	β^+	355	5	130 905465	5
75	56		Ba		-86683.7	2.6	8398.587	0.020	β^+	1375	5	130 906941.2	2.8
74	57		La	x	-83769	28	8370.37	0.21	β^+	2914	28	130 910070	30
73	58		Ce		-79710	30	8333.40	0.25	β^+	4060	40	130 914430	40
72	59		Pr		-74300	50	8286.1	0.4	β^+	5410	60	130 920230	50
71	60		Nd		-67768	28	8230.30	0.21	β^+	6530	50	130 927248	30
70	61		Pm	x	-59660#	200#	8162#	2#	β^+	8110#	200#	130 935950#	220#
69	62		Sm	x	-50130#	400#	8084#	3#	β^+	9530#	450#	130 946180#	430#
68	63		Eu	-p	-39270#	400#	7995#	3#	β^+	10860#	570#	130 957840#	430#
85	47	132	Ag	x	-33790#	500#	8049#	4#	β^-	16470#	540#	131 963730#	540#
84	48		Cd	x	-50260#	200#	8168#	1#	β^-	12150#	210#	131 946040#	210#
83	49		In	+	-62410	60	8253.7	0.5	β^-	14140	60	131 933000	60
82	50		Sn		-76546.5	2.0	8354.872	0.015	β^-	3089	3	131 917823.9	2.1
81	51		Sb		-79635.3	2.5	8372.344	0.019	β^-	5553	4	131 914508.0	2.6
80	52		Te		-85188	3	8408.485	0.026	β^-	515	3	131 908547	4
79	53		I		-85703	4	8406.46	0.03	β^-	3575	4	131 907994	4
78	54		Xe		-89278.962	0.005	8427.622	<i>a</i>	β^-	-2126.3	1.0	131 904155.087	0.006
77	55		Cs		-87152.7	1.0	8405.587	0.008	β^-	1282.3	1.5	131 906437.7	1.1
76	56		Ba		-88435.0	1.1	8409.375	0.008		*		131 905061.1	1.1
75	57		La		-83720	40	8367.76	0.28	β^+	4710	40	131 910120	40
74	58		Ce		-82471	20	8352.34	0.15	β^+	1250	40	131 911464	22
73	59		Pr	x	-75227	29	8291.54	0.22	β^+	7240	40	131 919240	30
72	60		Nd	x	-71426	24	8256.81	0.18	β^+	3800	40	131 923321	26
71	61		Pm	x	-61630#	150#	8177#	1#	β^+	9800#	150#	131 933840#	160#
70	62		Sm	x	-55080#	300#	8121#	2#	β^+	6550#	330#	131 940870#	320#
69	63		Eu	x	-42200#	400#	8018#	3#	β^+	12880#	500#	131 954700#	430#
85	48	133	Cd	x	-43920#	300#	8119#	2#	β^-	13540#	360#	132 952850#	320#
84	49		In	x	-57460#	200#	8215#	1#	β^-	13410#	200#	132 938310#	210#
83	50		Sn		-70873.9	1.9	8310.088	0.014	β^-	8050	4	132 923913.8	2.0
82	51		Sb		-78924	3	8364.729	0.024	β^-	4014	4	132 915272	3
81	52		Te		-82937.1	2.1	8389.025	0.016	β^-	2921	7	132 910963.3	2.2
80	53		I	++	-85858	6	8405.11	0.05	β^-	1785	7	132 907827	7
79	54		Xe	+	-87643.6	2.4	8412.647	0.018	β^-	427.4	2.4	132 905910.8	2.6
78	55		Cs		-88070.931	0.008	8409.978	<i>a</i>		*		132 905451.961	0.009
77	56		Ba		-87553.6	1.0	8400.206	0.007	β^+	517.3	1.0	132 906007.3	1.1
76	57		La	x	-85494	28	8378.84	0.21	β^+	2059	28	132 908220	30
75	58		Ce	x	-82418	16	8349.83	0.12	β^+	3080	30	132 911520	18
74	59		Pr	x	-77938	12	8310.26	0.09	β^+	4481	21	132 916331	13
73	60		Nd	x	-72330	50	8262.2	0.4	β^+	5610	50	132 922350	50
72	61		Pm	x	-65410	50	8204.3	0.4	β^+	6920	70	132 929780	50
71	62		Sm	x	-57230#	300#	8137#	2#	β^+	8180#	300#	132 938560#	320#
70	63		Eu	x	-47240#	300#	8056#	2#	β^+	10000#	420#	132 949290#	320#
69	64		Gd	x	-35860#	500#	7964#	4#	β^+	11380#	580#	132 961500#	540#

Table I. The 2012 Atomic mass table (continued, Explanation of Table on p. 030003-6)

<i>N</i>	<i>Z</i>	<i>A</i>	Elt.	Orig.	Mass excess (keV)		Binding energy per nucleon (keV)		Beta-decay energy (keV)		Atomic mass μ u		
86	48	134	Cd	x	-38920#	400#	8082#	3#	β^-	12740#	500#	133 958220#	430#
85	49		In	x	-51660#	300#	8171#	2#	β^-	14770#	300#	133 944540#	320#
84	50		Sn	x	-66434	3	8275.171	0.024	β^-	7587	4	133 928680	3
83	51		Sb	x	-74020.5	1.7	8325.950	0.013	β^-	8513	3	133 920535.7	1.8
82	52		Te		-82533.7	2.7	8383.643	0.020	β^-	1510	5	133 911396.4	2.9
81	53		I		-84043	5	8389.07	0.04	β^-	4082	5	133 909776	5
80	54		Xe		-88125.822	0.009	8413.699	<i>a</i>	β^-	-1234.667	0.018	133 905393.034	0.010
79	55		Cs		-86891.154	0.016	8398.646	<i>a</i>	β^-	2058.7	0.3	133 906718.504	0.018
78	56		Ba		-88949.9	0.3	8408.171	0.002		*		133 904508.4	0.3
77	57		La	x	-85219	20	8374.49	0.15	β^+	3731	20	133 908514	21
76	58		Ce	x	-84833	20	8365.77	0.15	β^+	386	29	133 908928	22
75	59		Pr	x	-78528	20	8312.88	0.15	β^+	6305	29	133 915697	22
74	60		Nd	x	-75646	12	8285.54	0.09	β^+	2882	24	133 918790	13
73	61		Pm	x	-66740	60	8213.2	0.4	β^+	8910	60	133 928350	60
72	62		Sm	x	-61380#	200#	8167#	1#	β^+	5360#	200#	133 934110#	210#
71	63		Eu	x	-49930#	300#	8076#	2#	β^+	11450#	360#	133 946400#	320#
70	64		Gd	x	-41300#	400#	8006#	3#	β^+	8630#	500#	133 955660#	430#
86	49	135	In	x	-46530#	400#	8132#	3#	β^-	14100#	400#	134 950050#	430#
85	50		Sn	x	-60632	3	8230.687	0.023	β^-	9058	4	134 934909	3
84	51		Sb		-69690.3	2.6	8291.989	0.020	β^-	8038	3	134 925184.4	2.8
83	52		Te		-77728.8	1.7	8345.738	0.013	β^-	6050.4	2.7	134 916554.7	1.8
82	53		I		-83779.1	2.1	8384.760	0.015	β^-	2634	4	134 910059.4	2.2
81	54		Xe		-86413	4	8398.476	0.028	β^-	1168	4	134 907232	4
80	55		Cs		-87581.6	1.0	8401.336	0.007	β^-	268.9	1.0	134 905977.2	1.1
79	56		Ba		-87850.5	0.3	8397.533	0.002		*		134 905688.6	0.3
78	57		La		-86643	9	8382.80	0.07	β^+	1207	9	134 906985	10
77	58		Ce		-84616	10	8361.98	0.08	β^+	2027	5	134 909161	11
76	59		Pr	x	-80936	12	8328.93	0.09	β^+	3680	16	134 913112	13
75	60		Nd	x	-76214	19	8288.15	0.14	β^+	4722	22	134 918181	21
74	61		Pm	x	-70050	80	8236.7	0.6	β^+	6160	80	134 924800	80
73	62		Sm	x	-62860	150	8177.6	1.1	β^+	7190	170	134 932520	170
72	63		Eu	x	-54150#	200#	8107#	1#	β^+	8710#	250#	134 941870#	210#
71	64		Gd	x	-44390#	400#	8029#	3#	β^+	9760#	450#	134 952350#	430#
70	65		Tb	-p	-32830#	400#	7938#	3#	β^+	11570#	570#	134 964760#	430#
87	49	136	In	x	-40510#	400#	8087#	3#	β^-	15390#	500#	135 956510#	430#
86	50		Sn	x	-55900#	300#	8195#	2#	β^-	8610#	300#	135 939990#	320#
85	51		Sb		-64507	6	8252.25	0.04	β^-	9918	6	135 930749	6
84	52		Te		-74425.3	2.3	8319.429	0.017	β^-	5120	14	135 920101.2	2.4
83	53		I		-79545	14	8351.32	0.10	β^-	6884	14	135 914605	15
82	54		Xe		-86429.159	0.007	8396.188	<i>a</i>	β^-	-90.5	1.9	135 907214.476	0.007
81	55		Cs	+	-86338.7	1.9	8389.770	0.014	β^-	2548.2	1.9	135 907311.6	2.0
80	56		Ba		-88886.9	0.3	8402.755	0.002	β^-	-2850	50	135 904576.0	0.3
79	57		La	x	-86040	50	8376.1	0.4	β^-	470	50	135 907630	60
78	58		Ce		-86508.4	0.4	8373.760	0.003		*		135 907129.4	0.4
77	59		Pr		-81340	11	8330.01	0.08	β^+	5168	11	135 912678	12
76	60		Nd	x	-79199	12	8308.51	0.09	β^+	2141	16	135 914976	13
75	61		Pm	x	-71170	70	8243.7	0.5	β^+	8030	70	135 923600	70
74	62		Sm	x	-66811	12	8205.92	0.09	β^+	4360	70	135 928276	13
73	63		Eu	x	-56240#	200#	8122#	1#	β^+	10570#	200#	135 939620#	210#
72	64		Gd	x	-49090#	300#	8064#	2#	β^+	7150#	360#	135 947300#	320#
71	65		Tb	x	-36130#	500#	7963#	4#	β^+	12960#	580#	135 961210#	540#

Table I. The 2012 Atomic mass table (continued, Explanation of Table on p. 030003-6)

<i>N</i>	<i>Z</i>	<i>A</i>	Elt.	Orig.	Mass excess (keV)		Binding energy per nucleon (keV)		Beta-decay energy (keV)		Atomic mass μ u		
88	49	137	In	x	-35040#	500#	8047#	4#	β^-	14750#	640#	136 962380#	540#
87	50		Sn	x	-49790#	400#	8149#	3#	β^-	10270#	400#	136 946550#	430#
86	51		Sb	x	-60060	50	8218.5	0.4	β^-	9240	50	136 935520	60
85	52		Te		-69303.8	2.1	8280.235	0.015	β^-	7053	9	136 925599.4	2.3
84	53		I	p-2n	-76356	8	8326.00	0.06	β^-	6027	8	136 918028	9
83	54		Xe	-n	-82383.40	0.10	8364.286	0.001	β^-	4162.2	0.4	136 911557.77	0.11
82	55		Cs	+	-86545.6	0.4	8388.956	0.003	β^-	1175.63	0.17	136 907089.5	0.4
81	56		Ba		-87721.2	0.3	8391.827	0.002	*			136 905827.4	0.3
80	57		La	+	-87140.7	1.7	8381.879	0.012	β^+	580.5	1.6	136 906450.6	1.8
79	58		Ce		-85918.6	0.4	8367.248	0.003	β^+	1222.1	1.6	136 907762.6	0.5
78	59		Pr		-83202	8	8341.71	0.06	β^+	2717	8	136 910679	9
77	60		Nd		-79585	12	8309.59	0.09	β^+	3617	14	136 914562	13
76	61		Pm	x	-74073	13	8263.65	0.10	β^+	5512	18	136 920480	14
75	62		Sm		-68030	40	8213.8	0.3	β^+	6050	40	136 926970	50
74	63		Eu	x	-60146	4	8150.57	0.03	β^+	7880	40	136 935431	5
73	64		Gd	x	-51210#	300#	8080#	2#	β^+	8930#	300#	136 945020#	320#
72	65		Tb	x	-40970#	400#	7999#	3#	β^+	10250#	500#	136 956020#	430#
88	50	138	Sn	x	-44860#	500#	8113#	4#	β^-	9360#	1180#	137 951840#	540#
87	51		Sb	x	-54220	1060	8175	8	β^-	11480	1060	137 941790	1140
86	52		Te		-65696	4	8252.578	0.027	β^-	6284	7	137 929472	4
85	53		I	x	-71980	6	8292.44	0.04	β^-	7992	7	137 922726	6
84	54		Xe		-79972.2	2.8	8344.690	0.020	β^-	2915	10	137 914146	3
83	55		Cs		-82887	9	8360.14	0.07	β^-	5375	9	137 911017	10
82	56		Ba		-88261.6	0.3	8393.420	0.002	β^-	-1742	3	137 905247.2	0.3
81	57		La		-86519	3	8375.125	0.023	β^-	1052	4	137 907118	3
80	58		Ce		-87571	5	8377.08	0.04	*			137 905989	5
79	59		Pr	-	-83134	11	8339.26	0.08	β^+	4437	10	137 910752	12
78	60		Nd		-82018	12	8325.50	0.08	β^+	1116	16	137 911950	12
77	61		Pm		-74940	28	8268.54	0.20	β^+	7078	29	137 919548	30
76	62		Sm	x	-71498	12	8237.93	0.09	β^+	3440	30	137 923244	13
75	63		Eu	x	-61750	28	8161.62	0.20	β^+	9750	30	137 933710	30
74	64		Gd	x	-55800#	200#	8113#	1#	β^+	5950#	200#	137 940100#	210#
73	65		Tb	x	-43670#	300#	8019#	2#	β^+	12130#	360#	137 953120#	320#
72	66		Dy	x	-34930#	500#	7950#	4#	β^+	8740#	590#	137 962500#	540#
89	50	139	Sn	x	-38440#	500#	8066#	4#	β^-	11350#	640#	138 958730#	540#
88	51		Sb	x	-49790#	400#	8142#	3#	β^-	10420#	400#	138 946550#	430#
87	52		Te	x	-60205	4	8211.771	0.025	β^-	8266	5	138 935367	4
86	53		I	x	-68471	4	8265.609	0.029	β^-	7174	5	138 926493	4
85	54		Xe	x	-75644.6	2.1	8311.590	0.015	β^-	5056	4	138 918792.2	2.3
84	55		Cs	+	-80701	3	8342.338	0.023	β^-	4213	3	138 913364	3
83	56		Ba		-84913.8	0.3	8367.017	0.002	β^-	2312.5	2.0	138 908841.3	0.3
82	57		La		-87226.2	2.0	8378.025	0.014	*			138 906358.8	2.2
81	58		Ce		-86948	7	8370.39	0.05	β^+	278	7	138 906658	8
80	59		Pr		-84819	8	8349.45	0.06	β^+	2129.1	3.0	138 908943	8
79	60		Nd		-82014	28	8323.64	0.20	β^+	2805	28	138 911954	30
78	61		Pm		-77500	14	8285.54	0.10	β^+	4513	26	138 916800	15
77	62		Sm	x	-72380	11	8243.08	0.08	β^+	5120	17	138 922297	12
76	63		Eu	x	-65398	13	8187.22	0.09	β^+	6982	17	138 929792	14
75	64		Gd	x	-57630#	200#	8126#	1#	β^+	7770#	200#	138 938130#	210#
74	65		Tb	x	-48130#	300#	8052#	2#	β^+	9500#	360#	138 948330#	320#
73	66		Dy	x	-37640#	500#	7971#	4#	β^+	10490#	590#	138 959590#	540#

Table I. The 2012 Atomic mass table (continued, Explanation of Table on p. 030003-6)

<i>N</i>	<i>Z</i>	<i>A</i>	Elt.	Orig.	Mass excess (keV)		Binding energy per nucleon (keV)		Beta-decay energy (keV)		Atomic mass μ u		
89	51	140	Sb	x	-43940#	600#	8100#	4#	β^-	12640#	600#	139 952830#	640#
88	52		Te	x	-56580	60	8184.8	0.4	β^-	7030	60	139 939260	70
87	53		I	x	-63606	12	8229.47	0.09	β^-	9380	12	139 931716	13
86	54		Xe	x	-72986.5	2.3	8290.887	0.017	β^-	4064	9	139 921645.8	2.5
85	55		Cs		-77050	8	8314.32	0.06	β^-	6219	10	139 917283	9
84	56		Ba		-83269	8	8353.16	0.06	β^-	1047	8	139 910607	9
83	57		La		-84315.9	2.0	8355.047	0.014	β^-	3760.2	1.7	139 909483.2	2.2
82	58		Ce		-88076.1	1.6	8376.317	0.011	*			139 905446.4	1.7
81	59		Pr	-	-84688	6	8346.53	0.04	β^+	3388	6	139 909084	7
80	60		Nd	x	-84259	3	8337.875	0.025	β^+	429	7	139 909544	4
79	61		Pm	-	-78214	24	8289.11	0.17	β^+	6045	24	139 916034	26
78	62		Sm	x	-75456	12	8263.82	0.09	β^+	2758	27	139 918995	13
77	63		Eu	-	-66990	50	8197.7	0.4	β^+	8470	50	139 928090	60
76	64		Gd	x	-61782	28	8154.97	0.20	β^+	5200	60	139 933670	30
75	65		Tb	-	-50480	800	8069	6	β^+	11300	800	139 945810	860
74	66		Dy	x	-42830#	400#	8008#	3#	β^+	7650#	900#	139 954020#	430#
73	67		Ho	-p	-29260#	500#	7906#	4#	β^+	13570#	640#	139 968590#	540#
90	51	141	Sb	x	-39110#	500#	8066#	4#	β^-	11380#	640#	140 958010#	540#
89	52		Te	x	-50490#	400#	8141#	3#	β^-	9440#	400#	140 945800#	430#
88	53		I	x	-59927	16	8202.26	0.11	β^-	8271	16	140 935666	17
87	54		Xe	x	-68197.3	2.9	8255.364	0.020	β^-	6280	10	140 926787	3
86	55		Cs		-74478	9	8294.36	0.07	β^-	5255	10	140 920045	10
85	56		Ba		-79733	5	8326.08	0.04	β^-	3199	7	140 914404	6
84	57		La		-82932	4	8343.217	0.030	β^-	2501	4	140 910969	5
83	58		Ce		-85432.9	1.6	8355.408	0.011	β^-	582.7	1.2	140 908284.0	1.7
82	59		Pr		-86015.6	1.7	8353.992	0.012	*			140 907658.4	1.8
81	60		Nd	-	-84193	3	8335.515	0.023	β^+	1823.0	2.8	140 909615	4
80	61		Pm	x	-80523	14	8303.94	0.10	β^+	3670	14	140 913555	15
79	62		Sm		-75934	9	8265.84	0.06	β^+	4589	16	140 918482	9
78	63		Eu		-69926	13	8217.68	0.09	β^+	6008	14	140 924932	14
77	64		Gd	x	-63224	20	8164.61	0.14	β^+	6701	23	140 932126	21
76	65		Tb	x	-54540	110	8097.5	0.7	β^+	8680	110	140 941450	110
75	66		Dy	x	-45380#	300#	8027#	2#	β^+	9160#	320#	140 951280#	320#
74	67		Ho	-p	-34360#	400#	7943#	3#	β^+	11020#	500#	140 963110#	430#
90	52	142	Te	x	-46370#	500#	8111#	4#	β^-	8400#	630#	141 950220#	540#
89	53		I	x	-54770	370	8165.0	2.6	β^-	10460	370	141 941200	400
88	54		Xe	x	-65229.6	2.7	8233.169	0.019	β^-	5285	8	141 929973.1	2.9
87	55		Cs		-70515	7	8264.88	0.05	β^-	7328	8	141 924300	8
86	56		Ba		-77842	6	8310.97	0.04	β^-	2182	8	141 916433	6
85	57		La		-80024	6	8320.83	0.04	β^-	4509	6	141 914090	7
84	58		Ce		-84533.2	2.5	8347.071	0.018	β^-	-745.7	2.5	141 909249.9	2.7
83	59		Pr		-83787.5	1.7	8336.310	0.012	β^-	2162.5	1.4	141 910050.4	1.8
82	60		Nd		-85950.0	1.4	8346.030	0.010	*			141 907728.9	1.5
81	61		Pm		-81142	24	8306.66	0.17	β^+	4808	24	141 912890	25
80	62		Sm		-78986	3	8285.972	0.022	β^+	2156	24	141 915205	3
79	63		Eu	-	-71310	30	8226.43	0.21	β^+	7670	30	141 923440	30
78	64		Gd	x	-66960	28	8190.26	0.20	β^+	4350	40	141 928120	30
77	65		Tb	-	-56560	700	8112	5	β^+	10400	700	141 939280	750
76	66		Dy	-	-50120#	730#	8061#	5#	β^+	6440#	200#	141 946190#	780#
75	67		Ho	x	-37250#	400#	7965#	3#	β^+	12870#	830#	141 960010#	430#
74	68		Er	x	-28030#	500#	7894#	4#	β^+	9220#	640#	141 969910#	540#

Table I. The 2012 Atomic mass table (continued, Explanation of Table on p. 030003-6)

<i>N</i>	<i>Z</i>	<i>A</i>	Elt.	Orig.	Mass excess (keV)		Binding energy per nucleon (keV)		Beta-decay energy (keV)		Atomic mass μ u		
91	52	143	Te	x	-40280#	500#	8068#	4#	β^-	10350#	540#	142 956760#	540#
90	53		I	x	-50630#	200#	8135#	1#	β^-	9570#	200#	142 945650#	220#
89	54		Xe	x	-60203	5	8196.88	0.03	β^-	7473	9	142 935370	5
88	55		Cs		-67676	8	8243.67	0.05	β^-	6262	10	142 927347	8
87	56		Ba		-73937	7	8281.99	0.05	β^-	4234	10	142 920625	7
86	57		La		-78172	7	8306.13	0.05	β^-	3435	8	142 916079	8
85	58		Ce		-81606.7	2.5	8324.678	0.018	β^-	1461.6	1.9	142 912391.6	2.7
84	59		Pr		-83068.2	1.9	8329.428	0.013	β^-	934.0	1.4	142 910822.6	2.0
83	60		Nd		-84002.2	1.4	8330.488	0.010	*			142 909819.9	1.5
82	61		Pm		-82960.7	3.0	8317.733	0.021	β^+	1041.6	2.7	142 910938	3
81	62		Sm		-79517.2	2.8	8288.182	0.020	β^+	3443	4	142 914635	3
80	63		Eu	x	-74241	11	8245.82	0.08	β^+	5276	11	142 920299	12
79	64		Gd	-	-68230	200	8198.3	1.4	β^+	6010	200	142 926750	220
78	65		Tb	x	-60420	50	8138.2	0.4	β^+	7810	210	142 935140	60
77	66		Dy	x	-52169	13	8075.05	0.09	β^+	8250	50	142 943994	14
76	67		Ho	x	-42050#	300#	7999#	2#	β^+	10120#	300#	142 954860#	320#
75	68		Er	x	-31260#	400#	7918#	3#	β^+	10790#	500#	142 966440#	430#
91	53	144	I	x	-45280#	400#	8098#	3#	β^-	11590#	400#	143 951390#	430#
90	54		Xe	x	-56872	5	8172.88	0.04	β^-	6399	21	143 938945	6
89	55		Cs		-63271	20	8211.89	0.14	β^-	8496	20	143 932075	22
88	56		Ba		-71767	7	8265.45	0.05	β^-	3083	15	143 922955	8
87	57		La	x	-74850	13	8281.43	0.09	β^-	5582	13	143 919646	14
86	58		Ce	+	-80431.9	2.9	8314.760	0.020	β^-	318.6	0.8	143 913653	3
85	59		Pr	+	-80750.5	2.8	8311.540	0.019	β^-	2997.4	2.4	143 913310.8	3.0
84	60		Nd		-83748.0	1.4	8326.922	0.009	β^-	-2331.9	2.6	143 910092.9	1.5
83	61		Pm		-81416.1	3.0	8305.296	0.021	β^-	549.4	2.7	143 912596	3
82	62		Sm		-81965.5	1.6	8303.679	0.011	*			143 912006.4	1.7
81	63		Eu		-75619	11	8254.17	0.07	β^+	6346	11	143 918820	12
80	64		Gd	x	-71760	28	8221.94	0.19	β^+	3860	30	143 922960	30
79	65		Tb	x	-62368	28	8151.29	0.19	β^+	9390	40	143 933050	30
78	66		Dy	x	-56570	7	8105.59	0.05	β^+	5798	29	143 939270	8
77	67		Ho	x	-44610	8	8017.10	0.06	β^+	11961	11	143 952110	9
76	68		Er	x	-36610#	200#	7956#	1#	β^+	8000#	200#	143 960700#	210#
75	69		Tm	-p	-22260#	400#	7851#	3#	β^+	14350#	450#	143 976100#	430#
92	53	145	I	x	-40940#	500#	8068#	3#	β^-	10550#	500#	144 956050#	540#
91	54		Xe	x	-51493	11	8135.09	0.08	β^-	8561	14	144 944720	12
90	55		Cs		-60054	9	8188.73	0.06	β^-	7462	12	144 935529	10
89	56		Ba	x	-67516	8	8234.80	0.06	β^-	5319	15	144 927518	9
88	57		La		-72835	12	8266.09	0.08	β^-	4230	40	144 921808	13
87	58		Ce		-77070	30	8289.88	0.23	β^-	2560	30	144 917270	40
86	59		Pr		-79626	7	8302.13	0.05	β^-	1806	7	144 914518	8
85	60		Nd		-81432.0	1.4	8309.187	0.010	*			144 912579.2	1.5
84	61		Pm		-81267.5	2.9	8302.657	0.020	β^+	164.5	2.5	144 912756	3
83	62		Sm		-80651.3	1.6	8293.013	0.011	β^+	616.2	2.5	144 913417.2	1.7
82	63		Eu		-77992	3	8269.274	0.021	β^+	2659.8	2.7	144 916273	3
81	64		Gd		-72926	20	8228.95	0.14	β^+	5065	20	144 921710	21
80	65		Tb		-66390	110	8178.5	0.8	β^+	6540	110	144 928730	120
79	66		Dy	x	-58243	7	8116.89	0.04	β^+	8150	110	144 937474	7
78	67		Ho	x	-49120	7	8048.58	0.05	β^+	9122	10	144 947267	8
77	68		Er	x	-39240#	200#	7975#	1#	β^+	9880#	200#	144 957870#	220#
76	69		Tm	-p	-27580#	200#	7889#	1#	β^+	11660#	280#	144 970390#	210#

Table I. The 2012 Atomic mass table (continued, Explanation of Table on p. 030003-6)

<i>N</i>	<i>Z</i>	<i>A</i>	Elt.	Orig.	Mass excess (keV)		Binding energy per nucleon (keV)		Beta-decay energy (keV)		Atomic mass μ		
92	54	146	Xe	x	-47955	24	8110.41	0.17	β^-	7355	24	145 948518	26
91	55		Cs	x	-55310.4	2.9	8155.436	0.020	β^-	9637	21	145 940622	3
90	56		Ba		-64947	21	8216.08	0.14	β^-	4100	30	145 930276	22
89	57		La		-69050	30	8238.83	0.23	β^-	6590	30	145 925870	40
88	58		Ce		-75635	16	8278.57	0.11	β^-	1050	30	145 918802	18
87	59		Pr		-76680	30	8280.38	0.24	β^-	4240	30	145 917680	40
86	60		Nd		-80925.9	1.4	8304.092	0.009	β^-	-1472	4	145 913122.5	1.5
85	61		Pm	+	-79454	4	8288.654	0.030	β^-	1542	3	145 914702	5
84	62		Sm		-80996	3	8293.857	0.021		*		145 913047	3
83	63		Eu		-77118	6	8261.93	0.04	β^+	3879	6	145 917211	6
82	64		Gd		-76086	4	8249.506	0.028	β^+	1032	7	145 918319	4
81	65		Tb		-67760	40	8187.1	0.3	β^+	8320	40	145 927250	50
80	66		Dy		-62555	7	8146.11	0.05	β^+	5210	50	145 932845	7
79	67		Ho		-51238	7	8063.24	0.05	β^+	11317	9	145 944994	7
78	68		Er		-44322	7	8010.51	0.05	β^+	6916	9	145 952418	7
77	69		Tm	-p	-31060#	200#	7914#	1#	β^+	13270#	200#	145 966660#	220#
93	54	147	Xe	x	-42360#	200#	8072#	1#	β^-	9560#	200#	146 954530#	220#
92	55		Cs	x	-51920	8	8131.80	0.06	β^-	8344	21	146 944262	9
91	56		Ba	x	-60264	20	8183.24	0.13	β^-	6414	22	146 935304	21
90	57		La	x	-66678	11	8221.55	0.07	β^-	5336	14	146 928418	12
89	58		Ce		-72014	9	8252.53	0.06	β^-	3430	16	146 922690	9
88	59		Pr		-75444	16	8270.54	0.11	β^-	2703	16	146 919007	17
87	60		Nd		-78146.7	1.4	8283.603	0.009	β^-	895.5	0.5	146 916106.0	1.5
86	61		Pm		-79042.3	1.4	8284.372	0.010	β^-	224.09	0.29	146 915144.6	1.5
85	62		Sm		-79266.4	1.4	8280.575	0.009		*		146 914904.1	1.5
84	63		Eu		-77544.8	2.6	8263.541	0.018	β^+	1721.6	2.3	146 916752.3	2.8
83	64		Gd		-75356.9	2.0	8243.336	0.013	β^+	2187.8	2.5	146 919101.0	2.1
82	65		Tb		-70743	8	8206.62	0.06	β^+	4614	8	146 924055	9
81	66		Dy	x	-64196	9	8156.77	0.06	β^+	6547	12	146 931083	10
80	67		Ho		-55757	5	8094.04	0.03	β^+	8439	10	146 940142	5
79	68		Er	x	-46610	40	8026.48	0.26	β^+	9150	40	146 949960	40
78	69		Tm		-35974	7	7948.82	0.05	β^+	10630	40	146 961380	7
94	54	148	Xe	x	-38600#	300#	8047#	2#	β^-	8310#	300#	147 958560#	320#
93	55		Cs	x	-46911	13	8097.55	0.09	β^-	10680	60	147 949639	14
92	56		Ba	+	-57590	60	8164.4	0.4	β^-	5110	60	147 938170	70
91	57		La	x	-62709	19	8193.72	0.13	β^-	7690	22	147 932679	21
90	58		Ce		-70398	11	8240.39	0.08	β^-	2137	13	147 924424	12
89	59		Pr		-72535	15	8249.54	0.10	β^-	4873	15	147 922130	16
88	60		Nd		-77408.0	2.1	8277.177	0.014	β^-	-542	6	147 916899.1	2.3
87	61		Pm	+p	-76866	6	8268.23	0.04	β^-	2471	6	147 917481	6
86	62		Sm		-79336.3	1.4	8279.633	0.009		*		147 914829.0	1.5
85	63		Eu		-76299	10	8253.83	0.07	β^+	3037	10	147 918089	11
84	64		Gd		-76269.3	1.6	8248.338	0.011	β^+	30	10	147 918121.5	1.7
83	65		Tb		-70537	12	8204.32	0.08	β^+	5732	13	147 924275	13
82	66		Dy		-67860	9	8180.94	0.06	β^+	2678	10	147 927150	9
81	67		Ho	x	-57990	80	8109.0	0.6	β^+	9870	80	147 937740	90
80	68		Er	x	-51479	10	8059.69	0.07	β^+	6510	80	147 944735	11
79	69		Tm	x	-38765	10	7968.50	0.07	β^+	12714	14	147 958384	11
78	70		Yb	x	-30330#	400#	7906#	3#	β^+	8440#	400#	147 967440#	430#

Table I. The 2012 Atomic mass table (continued, Explanation of Table on p. 030003-6)

<i>N</i>	<i>Z</i>	<i>A</i>	Elt.	Orig.	Mass excess (keV)		Binding energy per nucleon (keV)		Beta-decay energy (keV)		Atomic mass μ		
94	55	149	Cs	x	-43250#	400#	8073#	3#	β^-	9870#	590#	148 953570#	430#
93	56		Ba	x	-53120	440	8133.8	2.9	β^-	7100	480	148 942970	470
92	57		La	+	-60220	200	8176.2	1.3	β^-	6450	200	148 935350	210
91	58		Ce	x	-66670	10	8214.23	0.07	β^-	4369	14	148 928427	11
90	59		Pr	x	-71039	10	8238.30	0.07	β^-	3336	10	148 923736	11
89	60		Nd	-n	-74375.5	2.1	8255.442	0.014	β^-	1688.8	2.5	148 920154.6	2.3
88	61		Pm		-76064.3	2.3	8261.526	0.015	β^-	1071.5	1.9	148 918341.7	2.4
87	62		Sm		-77135.7	1.3	8263.466	0.009	*			148 917191.4	1.4
86	63		Eu		-76441	4	8253.554	0.027	β^+	695	4	148 917937	4
85	64		Gd		-75127	3	8239.484	0.023	β^+	1314	4	148 919348	4
84	65		Tb		-71489	4	8209.815	0.025	β^+	3638	4	148 923254	4
83	66		Dy		-67696	9	8179.11	0.06	β^+	3793	9	148 927325	10
82	67		Ho		-61647	12	8133.26	0.08	β^+	6049	13	148 933820	13
81	68		Er	x	-53742	28	8074.96	0.19	β^+	7900	30	148 942310	30
80	69		Tm	x	-43880#	200#	8004#	1#	β^+	9860#	200#	148 952890#	210#
79	70		Yb	x	-33200#	300#	7927#	2#	β^+	10680#	360#	148 964360#	320#
95	55	150	Cs	x	-38170#	400#	8039#	3#	β^-	11730#	500#	149 959020#	430#
94	56		Ba	x	-49900#	300#	8112#	2#	β^-	6230#	530#	149 946430#	320#
93	57		La	x	-56130	440	8148.2	2.9	β^-	8720	440	149 939740	470
92	58		Ce		-64847	12	8201.12	0.08	β^-	3454	14	149 930384	13
91	59		Pr		-68300	9	8218.93	0.06	β^-	5379	9	149 926676	10
90	60		Nd		-73679.8	1.3	8249.577	0.009	β^-	-83	20	149 920901.5	1.4
89	61		Pm	+	-73597	20	8243.81	0.13	β^-	3454	20	149 920990	22
88	62		Sm		-77051.1	1.3	8261.621	0.009	β^-	-2259	6	149 917282.2	1.4
87	63		Eu		-74792	6	8241.35	0.04	β^-	972	4	149 919707	7
86	64		Gd		-75764	6	8242.61	0.04	*			149 918664	7
85	65		Tb		-71106	7	8206.34	0.05	β^+	4658	8	149 923665	8
84	66		Dy		-69310	4	8189.149	0.029	β^+	1796	8	149 925593	5
83	67		Ho		-61946	14	8134.84	0.09	β^+	7364	14	149 933498	15
82	68		Er		-57831	17	8102.20	0.11	β^+	4115	14	149 937916	18
81	69		Tm	x	-46490#	200#	8021#	1#	β^+	11340#	200#	149 950090#	210#
80	70		Yb	x	-38640#	300#	7964#	2#	β^+	7850#	360#	149 958520#	320#
79	71		Lu	-p	-24640#	300#	7865#	2#	β^+	14000#	420#	149 973550#	320#
96	55	151	Cs	x	-34230#	500#	8013#	3#	β^-	10710#	640#	150 963250#	540#
95	56		Ba	x	-44940#	400#	8079#	3#	β^-	8370#	590#	150 951760#	430#
94	57		La	x	-53310	440	8129.0	2.9	β^-	7910	440	150 942770	470
93	58		Ce	x	-61225	18	8176.28	0.12	β^-	5555	21	150 934272	19
92	59		Pr		-66780	12	8207.88	0.08	β^-	4163	12	150 928309	13
91	60		Nd		-70943.0	1.3	8230.272	0.009	β^-	2443	4	150 923839.6	1.4
90	61		Pm		-73386	5	8241.27	0.03	β^-	1190	4	150 921217	5
89	62		Sm		-74576.3	1.3	8243.971	0.008	β^-	76.6	0.5	150 919939.1	1.4
88	63		Eu		-74652.9	1.3	8239.297	0.009	*			150 919856.9	1.4
87	64		Gd		-74189	3	8231.043	0.020	β^+	464.1	2.8	150 920355	3
86	65		Tb		-71624	4	8208.873	0.027	β^+	2565	4	150 923109	4
85	66		Dy	$-\alpha$	-68752	3	8184.678	0.022	β^+	2871	5	150 926191	4
84	67		Ho	$-\alpha$	-63623	8	8145.53	0.05	β^+	5130	9	150 931698	9
83	68		Er	x	-58266	16	8104.87	0.11	β^+	5356	18	150 937449	18
82	69		Tm	$+\alpha$	-50773	19	8050.06	0.13	β^+	7494	25	150 945493	21
81	70		Yb	ϵp	-41540	300	7983.8	2.0	β^+	9230	300	150 955400	320
80	71		Lu	-p	-30110#	300#	7903#	2#	β^+	11430#	430#	150 967680#	320#

Table I. The 2012 Atomic mass table (continued, Explanation of Table on p. 030003-6)

<i>N</i>	<i>Z</i>	<i>A</i>	Elt.	Orig.	Mass excess (keV)		Binding energy per nucleon (keV)		Beta-decay energy (keV)		Atomic mass μ		
97	55	152	Cs	x	-28930#	500#	7979#	3#	β^-	12780#	640#	151 968940#	540#
96	56		Ba	x	-41710#	400#	8057#	3#	β^-	7580#	500#	151 955220#	430#
95	57		La	x	-49290#	300#	8102#	2#	β^-	9690#	360#	151 947090#	320#
94	58		Ce	x	-58980#	200#	8161#	1#	β^-	4780#	200#	151 936680#	220#
93	59		Pr	x	-63758	19	8187.10	0.12	β^-	6390	30	151 931553	20
92	60		Nd		-70149	24	8224.01	0.16	β^-	1105	19	151 924692	26
91	61		Pm		-71254	26	8226.13	0.17	β^-	3508	26	151 923505	28
90	62		Sm		-74762.6	1.2	8244.061	0.008	β^-	-1874.3	0.7	151 919739.0	1.3
89	63		Eu		-72888.3	1.3	8226.583	0.009	β^-	1818.7	0.7	151 921751.2	1.4
88	64		Gd		-74706.9	1.2	8233.401	0.008	*			151 919798.8	1.3
87	65		Tb	-	-70720	40	8202.00	0.26	β^+	3990	40	151 924080	40
86	66		Dy	$-\alpha$	-70118	5	8192.92	0.03	β^+	600	40	151 924725	5
85	67		Ho		-63605	13	8144.92	0.08	β^+	6513	13	151 931717	13
84	68		Er		-60500	9	8119.35	0.06	β^+	3104	10	151 935050	9
83	69		Tm		-51720	50	8056.4	0.4	β^+	8780	50	151 944480	60
82	70		Yb		-46270	150	8015.4	1.0	β^+	5450	140	151 950330	160
81	71		Lu	x	-33420#	200#	7926#	1#	β^+	12850#	250#	151 964120#	210#
97	56	153	Ba	x	-36470#	400#	8023#	3#	β^-	9590#	500#	152 960850#	430#
96	57		La	x	-46060#	300#	8081#	2#	β^-	8850#	360#	152 950550#	320#
95	58		Ce	x	-54910#	200#	8134#	1#	β^-	6660#	200#	152 941050#	220#
94	59		Pr		-61568	12	8172.04	0.08	β^-	5762	12	152 933904	13
93	60		Nd		-67330.3	2.7	8204.582	0.018	β^-	3318	9	152 927717.9	2.9
92	61		Pm		-70648	9	8221.15	0.06	β^-	1912	9	152 924156	10
91	62		Sm	-n	-72559.7	1.2	8228.534	0.008	β^-	807.5	0.7	152 922104.0	1.3
90	63		Eu		-73367.2	1.3	8228.699	0.009	*			152 921237.0	1.4
89	64		Gd		-72882.6	1.2	8220.418	0.008	β^+	484.7	0.7	152 921757.4	1.3
88	65		Tb		-71313	4	8205.048	0.026	β^+	1569	4	152 923442	4
87	66		Dy		-69143	4	8185.749	0.026	β^+	2170.4	1.9	152 925772	4
86	67		Ho	$-\alpha$	-65012	5	8153.64	0.03	β^+	4131	6	152 930207	5
85	68		Er		-60469	9	8118.83	0.06	β^+	4543	10	152 935084	10
84	69		Tm		-53973	12	8071.26	0.08	β^+	6495	13	152 942057	13
83	70		Yb	x	-47210#	200#	8022#	1#	β^+	6770#	200#	152 949320#	210#
82	71		Lu	$+\alpha$	-38370	150	7959.1	1.0	β^+	8840#	250#	152 958810	160
81	72		Hf	x	-27300#	300#	7882#	2#	β^+	11070#	340#	152 970690#	320#
98	56	154	Ba	x	-32820#	500#	8000#	3#	β^-	8710#	580#	153 964770#	540#
97	57		La	x	-41530#	300#	8051#	2#	β^-	10690#	360#	153 955420#	320#
96	58		Ce	x	-52220#	200#	8116#	1#	β^-	5890#	230#	153 943940#	220#
95	59		Pr	+	-58100	110	8148.9	0.7	β^-	7720	100	153 937620	120
94	60		Nd	+	-65820	50	8193.9	0.3	β^-	2687	25	153 929330	60
93	61		Pm	IT	-68510	50	8206.3	0.3	β^-	3940	50	153 926450	50
92	62		Sm		-72455.2	1.5	8226.835	0.009	β^-	-717.1	1.1	153 922216.2	1.6
91	63		Eu		-71738.1	1.3	8217.098	0.009	β^-	1967.8	0.8	153 922986.0	1.4
90	64		Gd		-73706.0	1.2	8224.796	0.008	β^-	-3550	50	153 920873.4	1.3
89	65		Tb	-	-70160	50	8196.67	0.29	β^-	240	50	153 924680	50
88	66		Dy		-70394	7	8193.13	0.05	*			153 924429	8
87	67		Ho	$-\alpha$	-64639	8	8150.68	0.05	β^+	5755	10	153 930607	9
86	68		Er		-62605	5	8132.39	0.03	β^+	2034	9	153 932791	5
85	69		Tm	$-\alpha$	-54427	14	8074.21	0.09	β^+	8178	15	153 941570	15
84	70		Yb		-49932	17	8039.94	0.11	β^+	4495	14	153 946396	19
83	71		Lu	$+\alpha$	-39720#	200#	7969#	1#	β^+	10220#	200#	153 957360#	210#
82	72		Hf	x	-32670#	300#	7918#	2#	β^+	7050#	360#	153 964930#	320#

Table I. The 2012 Atomic mass table (continued, Explanation of Table on p. 030003-6)

<i>N</i>	<i>Z</i>	<i>A</i>	Elt.	Orig.	Mass excess (keV)		Binding energy per nucleon (keV)		Beta-decay energy (keV)		Atomic mass μ u		
98	57	155	La	x	-37930#	400#	8028#	3#	β^-	9850#	500#	154 959280#	430#
97	58		Ce	x	-47780#	300#	8087#	2#	β^-	7640#	300#	154 948710#	320#
96	59		Pr		-55415	17	8131.04	0.11	β^-	6868	19	154 940509	18
95	60		Nd		-62284	9	8170.30	0.06	β^-	4656	10	154 933136	10
94	61		Pm		-66940	5	8195.30	0.03	β^-	3251	5	154 928137	5
93	62		Sm	-n	-70190.8	1.5	8211.223	0.010	β^-	1627.3	1.2	154 924647.1	1.6
92	63		Eu		-71818.1	1.4	8216.674	0.009	β^-	251.8	0.9	154 922900.1	1.5
91	64		Gd		-72069.9	1.2	8213.251	0.008		*		154 922629.8	1.3
90	65		Tb	+	-71250	10	8202.91	0.06	β^+	820	10	154 923510	11
89	66		Dy		-69156	10	8184.35	0.06	β^+	2094.5	1.9	154 925758	10
88	67		Ho		-66040	17	8159.20	0.11	β^+	3116	17	154 929104	19
87	68		Er	$-\alpha$	-62209	6	8129.44	0.04	β^+	3830	18	154 933216	7
86	69		Tm	$-\alpha$	-56626	10	8088.38	0.06	β^+	5583	12	154 939210	11
85	70		Yb	$-\alpha$	-50503	17	8043.82	0.11	β^+	6123	19	154 945783	18
84	71		Lu	$+\alpha$	-42545	19	7987.44	0.12	β^+	7958	25	154 954326	21
83	72		Hf	x	-34170#	300#	7928#	2#	β^+	8380#	300#	154 963320#	320#
82	73		Ta	-p	-23930#	300#	7857#	2#	β^+	10240#	420#	154 974310#	320#
99	57	156	La	x	-33050#	400#	7997#	3#	β^-	11770#	500#	155 964520#	430#
98	58		Ce	x	-44820#	300#	8068#	2#	β^-	6750#	360#	155 951880#	320#
97	59		Pr	x	-51570#	200#	8106#	1#	β^-	8910#	280#	155 944640#	220#
96	60		Nd	+	-60470	200	8158.1	1.3	β^-	3690	200	155 935080	210
95	61		Pm		-64164	4	8176.705	0.023	β^-	5197	9	155 931117	4
94	62		Sm		-69360	9	8205.00	0.05	β^-	722	8	155 925539	9
93	63		Eu		-70083	4	8204.617	0.023	β^-	2452	3	155 924763	4
92	64		Gd		-72534.9	1.2	8215.322	0.008	β^-	-2444	4	155 922130.6	1.3
91	65		Tb		-70091	4	8194.639	0.024	β^-	438	4	155 924754	4
90	66		Dy		-70529.0	1.2	8192.433	0.008		*		155 924284.0	1.3
89	67		Ho	-	-65480	60	8155.0	0.4	β^+	5050	60	155 929710	60
88	68		Er		-64212	25	8141.91	0.16	β^+	1270	60	155 931066	26
87	69		Tm		-56835	14	8089.60	0.09	β^+	7377	27	155 938986	15
86	70		Yb		-53266	9	8061.71	0.06	β^+	3569	13	155 942817	10
85	71		Lu	$-\alpha$	-43700	50	7995.4	0.3	β^+	9570	50	155 953090	60
84	72		Hf		-37820	150	7952.7	1.0	β^+	5880	140	155 959400	160
83	73		Ta	-p	-25860#	300#	7871#	2#	β^+	11960#	330#	155 972240#	320#
99	58	157	Ce	x	-39930#	400#	8037#	3#	β^-	8610#	500#	156 957130#	430#
98	59		Pr	x	-48540#	300#	8086#	2#	β^-	7920#	300#	156 947890#	320#
97	60		Nd		-56462	25	8131.96	0.16	β^-	5835	26	156 939386	27
96	61		Pm		-62297	7	8164.14	0.04	β^-	4381	8	156 933121	8
95	62		Sm		-66678	4	8187.063	0.028	β^-	2781	6	156 928419	5
94	63		Eu		-69459	4	8199.795	0.027	β^-	1365	4	156 925433	5
93	64		Gd		-70823.5	1.2	8203.504	0.008		*		156 923967.9	1.3
92	65		Tb		-70763.4	1.2	8198.138	0.008	β^+	60.04	0.30	156 924032.3	1.3
91	66		Dy		-69425	5	8184.63	0.03	β^+	1339	5	156 925470	6
90	67		Ho		-66833	23	8163.14	0.15	β^+	2592	24	156 928252	25
89	68		Er		-63414	27	8136.37	0.17	β^+	3420	30	156 931923	28
88	69		Tm	x	-58709	28	8101.43	0.18	β^+	4700	40	156 936970	30
87	70		Yb		-53422	11	8062.77	0.07	β^+	5290	30	156 942649	12
86	71		Lu		-46441	12	8013.32	0.08	β^+	6981	14	156 950144	13
85	72		Hf	$-\alpha$	-38900#	200#	7960#	1#	β^+	7540#	200#	156 958240#	210#
84	73		Ta	IT	-29590	150	7896.0	1.0	β^+	9310#	250#	156 968230	160
83	74		W	x	-19470#	400#	7827#	3#	β^+	10120#	430#	156 979100#	430#

Table I. The 2012 Atomic mass table (continued, Explanation of Table on p. 030003-6)

<i>N</i>	<i>Z</i>	<i>A</i>	Elt.	Orig.	Mass excess (keV)		Binding energy per nucleon (keV)		Beta-decay energy (keV)		Atomic mass μ		
100	58	158	Ce	x	-36660#	400#	8016#	3#	β^-	7670#	500#	157 960640#	430#
99	59		Pr	x	-44330#	300#	8060#	2#	β^-	9730#	360#	157 952410#	320#
98	60		Nd	x	-54060#	200#	8116#	1#	β^-	5040#	200#	157 941970#	220#
97	61		Pm		-59089	13	8143.25	0.09	β^-	6161	14	157 936565	14
96	62		Sm		-65250	5	8177.30	0.03	β^-	2005	10	157 929951	5
95	63		Eu		-67255	10	8185.03	0.06	β^-	3434	10	157 927799	11
94	64		Gd		-70689.5	1.2	8201.819	0.008	β^-	-1218.9	1.0	157 924111.6	1.3
93	65		Tb		-69470.7	1.4	8189.153	0.009	β^-	936.7	2.5	157 925420.2	1.5
92	66		Dy		-70407.3	2.4	8190.130	0.015	*			157 924414.6	2.5
91	67		Ho	—	-66188	27	8158.47	0.17	β^+	4220	27	157 928945	29
90	68		Er		-65304	25	8147.93	0.16	β^+	880	40	157 929893	27
89	69		Tm		-58703	25	8101.20	0.16	β^+	6600	30	157 936980	27
88	70		Yb		-56010	8	8079.20	0.05	β^+	2693	26	157 939871	9
87	71		Lu	$-\alpha$	-47212	15	8018.57	0.10	β^+	8798	17	157 949316	16
86	72		Hf		-42102	17	7981.28	0.11	β^+	5110	15	157 954801	19
85	73		Ta	$+\alpha$	-31170#	200#	7907#	1#	β^+	10940#	200#	157 966540#	210#
84	74		W	$-\alpha$	-23630#	300#	7854#	2#	β^+	7530#	360#	157 974630#	320#
100	59	159	Pr	x	-41090#	400#	8039#	3#	β^-	8720#	500#	158 955890#	430#
99	60		Nd	x	-49810#	300#	8089#	2#	β^-	6750#	300#	158 946530#	320#
98	61		Pm		-56554	10	8126.86	0.06	β^-	5653	12	158 939286	11
97	62		Sm		-62208	6	8157.50	0.04	β^-	3836	7	158 933217	6
96	63		Eu		-66043	4	8176.697	0.027	β^-	2518	4	158 929100	5
95	64		Gd		-68561.4	1.2	8187.614	0.007	β^-	970.9	0.8	158 926396.3	1.3
94	65		Tb		-69532.4	1.3	8188.800	0.008	*			158 925353.9	1.3
93	66		Dy		-69167.1	1.5	8181.583	0.010	β^+	365.2	1.2	158 925746.0	1.6
92	67		Ho	—	-67330	3	8165.105	0.019	β^+	1837.6	2.7	158 927719	3
91	68		Er	—	-64561	4	8142.773	0.023	β^+	2768.5	2.0	158 930691	4
90	69		Tm	x	-60570	28	8112.75	0.18	β^+	3991	28	158 934980	30
89	70		Yb	x	-55839	18	8078.07	0.11	β^+	4730	30	158 940055	19
88	71		Lu	x	-49710	40	8034.60	0.24	β^+	6130	40	158 946640	40
87	72		Hf	$-\alpha$	-42853	17	7986.56	0.11	β^+	6860	40	158 953996	18
86	73		Ta	IT	-34439	20	7928.73	0.12	β^+	8413	26	158 963028	21
85	74		W	$-\alpha$	-25300#	300#	7866#	2#	β^+	9150#	300#	158 972850#	320#
84	75		Re	IT	-14750#	310#	7795#	2#	β^+	10550#	430#	158 984170#	330#
101	59	160	Pr	x	-36520#	400#	8011#	2#	β^-	10610#	500#	159 960790#	430#
100	60		Nd	x	-47130#	300#	8073#	2#	β^-	5870#	360#	159 949400#	320#
99	61		Pm	x	-53000#	200#	8104#	1#	β^-	7230#	200#	159 943100#	220#
98	62		Sm		-60235	6	8144.63	0.04	β^-	3246	11	159 935335	6
97	63		Eu		-63480	10	8160.02	0.06	β^-	4461	10	159 931851	10
96	64		Gd		-67941.7	1.3	8183.014	0.008	β^-	-105.5	1.0	159 927061.5	1.4
95	65		Tb		-67836.3	1.3	8177.465	0.008	β^-	1836.5	1.2	159 927174.8	1.4
94	66		Dy		-69672.7	0.8	8184.054	0.005	*			159 925203.2	0.8
93	67		Ho	—	-66383	15	8158.60	0.09	β^+	3290	15	159 928735	16
92	68		Er		-66064	24	8151.72	0.15	β^+	319	29	159 929077	26
91	69		Tm		-60300	30	8110.82	0.21	β^+	5760	40	159 935260	40
90	70		Yb		-58163	7	8092.56	0.05	β^+	2140	40	159 937560	8
89	71		Lu	x	-50270	60	8038.3	0.4	β^+	7890	60	159 946030	60
88	72		Hf		-45939	10	8006.38	0.06	β^+	4330	60	159 950683	10
87	73		Ta	$-\alpha$	-35820	50	7938.3	0.3	β^+	10120	60	159 961540	60
86	74		W		-29330	150	7892.8	0.9	β^+	6500	140	159 968520	160
85	75		Re	$-\alpha$	-16740#	300#	7809#	2#	β^+	12590#	330#	159 982030#	320#

Table I. The 2012 Atomic mass table (continued, Explanation of Table on p. 030003-6)

<i>N</i>	<i>Z</i>	<i>A</i>	Elt.	Orig.	Mass excess (keV)		Binding energy per nucleon (keV)		Beta-decay energy (keV)		Atomic mass μ		
101	60	161	Nd	x	-42590#	400#	8044#	2#	β^-	7650#	500#	160 954280#	430#
100	61		Pm	x	-50240#	300#	8087#	2#	β^-	6440#	300#	160 946070#	320#
99	62		Sm		-56672	7	8122.04	0.04	β^-	5120	12	160 939160	7
98	63		Eu		-61792	10	8148.98	0.06	β^-	3714	11	160 933664	11
97	64		Gd	-n	-65505.8	1.6	8167.191	0.010	β^-	1955.8	1.4	160 929676.6	1.7
96	65		Tb		-67461.6	1.4	8174.479	0.008	β^-	594.2	1.3	160 927577.0	1.4
95	66		Dy		-68055.8	0.8	8173.310	0.005	*			160 926939.1	0.8
94	67		Ho		-67197.3	2.2	8163.119	0.014	β^+	858.5	2.2	160 927860.8	2.4
93	68		Er	+n	-65202	9	8145.86	0.05	β^+	1996	9	160 930003	9
92	69		Tm	x	-61899	28	8120.49	0.17	β^+	3303	29	160 933550	30
91	70		Yb	x	-57839	15	8090.42	0.10	β^+	4060	30	160 937907	16
90	71		Lu	x	-52562	28	8052.78	0.17	β^+	5280	30	160 943570	30
89	72		Hf		-46315	23	8009.12	0.14	β^+	6250	40	160 950279	24
88	73		Ta	$+\alpha$	-38779	24	7957.45	0.15	β^+	7540	30	160 958369	26
87	74		W	$-\alpha$	-30560#	200#	7902#	1#	β^+	8220#	200#	160 967200#	210#
86	75		Re		-20840	150	7836.3	0.9	β^+	9720#	250#	160 977630	160
85	76		Os	$-\alpha$	-9980#	400#	7764#	2#	β^+	10860#	430#	160 989290#	430#
102	60	162	Nd	x	-39550#	400#	8026#	2#	β^-	6820#	500#	161 957540#	430#
101	61		Pm	x	-46370#	300#	8063#	2#	β^-	8160#	360#	161 950220#	320#
100	62		Sm	x	-54530#	200#	8109#	1#	β^-	4170#	200#	161 941460#	210#
99	63		Eu	+	-58700	40	8129.44	0.22	β^-	5580	40	161 936980	40
98	64		Gd	-nn	-64280	4	8159.035	0.025	β^-	1400	40	161 930992	4
97	65		Tb	+	-65680	40	8162.82	0.22	β^-	2510	40	161 929490	40
96	66		Dy		-68181.5	0.8	8173.457	0.005	β^-	-2140	3	161 926804.2	0.8
95	67		Ho		-66042	3	8155.418	0.020	β^-	293	3	161 929101	3
94	68		Er		-66334.5	0.8	8152.397	0.005	*			161 928787.0	0.9
93	69		Tm	-	-61478	26	8117.59	0.16	β^+	4857	26	161 934001	28
92	70		Yb	x	-59826	15	8102.56	0.09	β^+	1650	30	161 935774	16
91	71		Lu	x	-52830	80	8054.6	0.5	β^+	6990	80	161 943280	80
90	72		Hf		-49169	9	8027.12	0.06	β^+	3660	80	161 947215	10
89	73		Ta	$-\alpha$	-39780	50	7964.3	0.3	β^+	9390	50	161 957290	60
88	74		W		-33999	18	7923.82	0.11	β^+	5780	50	161 963500	19
87	75		Re	$+\alpha$	-22500#	200#	7848#	1#	β^+	11500#	200#	161 975840#	210#
86	76		Os	$-\alpha$	-14440#	300#	7793#	2#	β^+	8060#	360#	161 984500#	320#
102	61	163	Pm	x	-43250#	400#	8044#	2#	β^-	7470#	500#	162 953570#	430#
101	62		Sm	x	-50720#	300#	8085#	2#	β^-	5770#	310#	162 945550#	320#
100	63		Eu	+	-56480	70	8115.5	0.4	β^-	4830	70	162 939360	70
99	64		Gd		-61314	8	8140.30	0.05	β^-	3282	9	162 934177	9
98	65		Tb	+p	-64596	4	8155.633	0.025	β^-	1785	4	162 930653	4
97	66		Dy		-66381.2	0.8	8161.785	0.005	*			162 928736.9	0.8
96	67		Ho		-66378.3	0.8	8156.968	0.005	β^+	2.834	0.019	162 928739.9	0.8
95	68		Er		-65168	5	8144.741	0.028	β^+	1211	5	162 930040	5
94	69		Tm	-	-62729	6	8124.98	0.03	β^+	2439	3	162 932658	6
93	70		Yb	x	-59299	15	8099.14	0.09	β^+	3430	16	162 936340	16
92	71		Lu	x	-54791	28	8066.68	0.17	β^+	4510	30	162 941180	30
91	72		Hf		-49264	25	8027.97	0.15	β^+	5530	40	162 947113	27
90	73		Ta	$-\alpha$	-42530	40	7981.89	0.23	β^+	6730	50	162 954340	40
89	74		W	$-\alpha$	-34910	50	7930.3	0.3	β^+	7630	70	162 962520	60
88	75		Re	$+\alpha$	-26002	19	7870.86	0.11	β^+	8910	60	162 972085	20
87	76		Os	$-\alpha$	-16190#	300#	7806#	2#	β^+	9810#	300#	162 982620#	320#

Table I. The 2012 Atomic mass table (continued, Explanation of Table on p. 030003-6)

<i>N</i>	<i>Z</i>	<i>A</i>	Elt.	Orig.	Mass excess (keV)		Binding energy per nucleon (keV)		Beta-decay energy (keV)		Atomic mass μ		
103	61	164	Pm	x	-38870#	400#	8017#	2#	β^-	9230#	500#	163 958270#	430#
102	62		Sm	x	-48100#	300#	8069#	2#	β^-	5280#	320#	163 948360#	320#
101	63		Eu	+	-53380#	110#	8096#	1#	β^-	6390	50	163 942690#	120#
100	64		Gd	x	-59770#	100#	8130#	1#	β^-	2300#	140#	163 935830#	110#
99	65		Tb	+	-62080	100	8139.8	0.6	β^-	3890	100	163 933360	110
98	66		Dy		-65968.0	0.8	8158.714	0.005	β^-	-986.5	1.4	163 929180.5	0.8
97	67		Ho		-64981.5	1.5	8147.929	0.009	β^-	961.4	1.4	163 930239.5	1.6
96	68		Er		-65942.9	0.8	8149.020	0.005	*			163 929207.4	0.8
95	69		Tm		-61904	24	8119.62	0.15	β^+	4039	24	163 933543	26
94	70		Yb	x	-61017	15	8109.45	0.09	β^+	887	29	163 934495	16
93	71		Lu	x	-54642	28	8065.80	0.17	β^+	6380	30	163 941340	30
92	72		Hf		-51819	16	8043.81	0.10	β^+	2820	30	163 944371	17
91	73		Ta	x	-43283	28	7987.00	0.17	β^+	8540	30	163 953530	30
90	74		W		-38236	10	7951.45	0.06	β^+	5047	30	163 958952	10
89	75		Re	$-\alpha$	-27470	50	7881.1	0.3	β^+	10760	60	163 970510	60
88	76		Os		-20420	150	7833.3	0.9	β^+	7050	140	163 978080	160
87	77		Ir	$-\alpha$	-7340#	310#	7749#	2#	β^+	13080#	350#	163 992120#	340#
103	62	165	Sm	x	-43810#	400#	8043#	2#	β^-	6920#	420#	164 952970#	430#
102	63		Eu	+	-50720#	140#	8080#	1#	β^-	5730	70	164 945550#	150#
101	64		Gd	+	-56450#	120#	8110#	1#	β^-	4110	70	164 939400#	130#
100	65		Tb	x	-60570#	100#	8130#	1#	β^-	3050#	100#	164 934980#	110#
99	66		Dy	-n	-63612.6	0.8	8143.909	0.005	β^-	1286.4	0.8	164 931709.1	0.8
98	67		Ho		-64899.0	1.0	8146.964	0.006	*			164 930328.0	1.1
97	68		Er		-64521.6	1.0	8139.936	0.006	β^+	377.4	1.0	164 930733.2	1.0
96	69		Tm		-62929.6	1.7	8125.546	0.010	β^+	1592.0	1.5	164 932442.3	1.8
95	70		Yb		-60295	27	8104.84	0.16	β^+	2634	27	164 935270	28
94	71		Lu		-56442	27	8076.75	0.16	β^+	3850	40	164 939407	28
93	72		Hf	x	-51636	28	8042.87	0.17	β^+	4810	40	164 944570	30
92	73		Ta		-45848	14	8003.05	0.08	β^+	5790	30	164 950780	15
91	74		W		-38861	25	7955.97	0.15	β^+	6987	29	164 958281	27
90	75		Re	$+\alpha$	-30660	24	7901.52	0.14	β^+	8200	30	164 967085	25
89	76		Os	$-\alpha$	-21800#	200#	7843#	1#	β^+	8870#	200#	164 976600#	210#
88	77		Ir	IT	-11590#	160#	7776#	1#	β^+	10200#	250#	164 987560#	170#
104	62	166	Sm	x	-40730#	400#	8024#	2#	β^-	6480#	540#	165 956280#	430#
103	63		Eu	+	-47210#	360#	8059#	2#	β^-	7320	300	165 949320#	380#
102	64		Gd	x	-54530#	200#	8098#	1#	β^-	3360#	210#	165 941460#	210#
101	65		Tb	+	-57880	70	8113.7	0.4	β^-	4700	70	165 937860	80
100	66		Dy	-n	-62584.8	0.9	8137.280	0.005	β^-	486.5	0.9	165 932812.5	0.9
99	67		Ho		-63071.3	1.0	8135.499	0.006	β^-	1854.7	0.9	165 932290.1	1.1
98	68		Er		-64926.0	1.2	8141.959	0.007	*			165 930299.0	1.3
97	69		Tm	-	-61888	12	8118.95	0.07	β^+	3038	12	165 933560	12
96	70		Yb	$+\text{nn}$	-61596	7	8112.47	0.04	β^+	293	14	165 933874	8
95	71		Lu	x	-56021	30	8074.17	0.18	β^+	5570	30	165 939860	30
94	72		Hf	x	-53859	28	8056.44	0.17	β^+	2160	40	165 942180	30
93	73		Ta	x	-46098	28	8004.97	0.17	β^+	7760	40	165 950510	30
92	74		W		-41888	9	7974.90	0.06	β^+	4210	30	165 955031	10
91	75		Re	$-\alpha$	-31890	70	7910.0	0.4	β^+	9990	70	165 965760	80
90	76		Os		-25432	18	7866.34	0.11	β^+	6460	70	165 972698	19
89	77		Ir	-p	-13350#	200#	7789#	1#	β^+	12080#	200#	165 985660#	210#
88	78		Pt	$-\alpha$	-4730#	300#	7732#	2#	β^+	8620#	360#	165 994920#	320#

Table I. The 2012 Atomic mass table (continued, Explanation of Table on p. 030003-6)

<i>N</i>	<i>Z</i>	<i>A</i>	Elt.	Orig.	Mass excess (keV)		Binding energy per nucleon (keV)		Beta-decay energy (keV)		Atomic mass μ		
104	63	167	Eu	x	-44010#	400#	8040#	2#	β^-	6800#	500#	166 952750#	430#
103	64		Gd	x	-50810#	300#	8076#	2#	β^-	5110#	360#	166 945450#	320#
102	65		Tb	x	-55930#	200#	8102#	1#	β^-	4000#	210#	166 939960#	210#
101	66		Dy	+	-59930	60	8121.0	0.4	β^-	2350	60	166 935660	60
100	67		Ho	p2n	-62281	5	8130.38	0.03	β^-	1011	5	166 933139	6
99	68		Er		-63291.2	1.2	8131.746	0.007	*			166 932054.1	1.3
98	69		Tm		-62543.6	1.3	8122.585	0.008	β^+	747.5	1.5	166 932856.6	1.4
97	70		Yb		-60591	4	8106.205	0.024	β^+	1953	4	166 934953	4
96	71		Lu	x	-57500	30	8083.02	0.19	β^+	3090	30	166 938270	30
95	72		Hf	x	-53468	28	8054.18	0.17	β^+	4030	40	166 942600	30
94	73		Ta	x	-48351	28	8018.86	0.17	β^+	5120	40	166 948090	30
93	74		W		-42098	18	7976.73	0.11	β^+	6250	30	166 954806	20
92	75		Re	$+\alpha$	-34830#	40#	7929#	0#	β^+	7270#	40#	166 962610#	40#
91	76		Os	$-\alpha$	-26500	70	7874.0	0.4	β^+	8330#	80#	166 971550	80
90	77		Ir		-17072	18	7812.82	0.11	β^+	9430	70	166 981672	20
89	78		Pt	$-\alpha$	-6610#	300#	7746#	2#	β^+	10460#	300#	166 992900#	330#
105	63	168	Eu	x	-39740#	500#	8014#	3#	β^-	8620#	640#	167 957340#	540#
104	64		Gd	x	-48360#	400#	8061#	2#	β^-	4360#	500#	167 948080#	430#
103	65		Tb	x	-52720#	300#	8082#	2#	β^-	5840#	330#	167 943400#	320#
102	66		Dy	+pp	-58560	140	8112.5	0.8	β^-	1500	140	167 937130	150
101	67		Ho	+	-60060	30	8116.82	0.18	β^-	2930	30	167 935520	30
100	68		Er		-62991.2	1.2	8129.601	0.007	β^-	-1678.3	1.9	167 932376.2	1.3
99	69		Tm		-61312.9	1.7	8114.954	0.010	β^-	269.0	1.9	167 934177.9	1.8
98	70		Yb		-61581.9	1.2	8111.898	0.007	*			167 933889.1	1.3
97	71		Lu	-	-57070	40	8080.37	0.23	β^+	4510	40	167 938740	40
96	72		Hf	x	-55361	28	8065.55	0.17	β^+	1710	50	167 940570	30
95	73		Ta	x	-48394	28	8019.43	0.17	β^+	6970	40	167 948050	30
94	74		W		-44893	13	7993.93	0.08	β^+	3500	30	167 951805	14
93	75		Re	$-\alpha$	-35790	30	7935.12	0.18	β^+	9100	30	167 961570	30
92	76		Os		-29995	10	7895.94	0.06	β^+	5800	30	167 967799	11
91	77		Ir	$-\alpha$	-18670	60	7823.9	0.3	β^+	11330	60	167 979960	60
90	78		Pt	$-\alpha$	-11010	150	7773.6	0.9	β^+	7660	140	167 988180	160
105	64	169	Gd	x	-44150#	500#	8036#	3#	β^-	6180#	590#	168 952600#	540#
104	65		Tb	x	-50330#	300#	8068#	2#	β^-	5270#	420#	168 945970#	320#
103	66		Dy	+	-55600	300	8094.8	1.8	β^-	3200	300	168 940310	320
102	67		Ho	+p	-58797	20	8109.07	0.12	β^-	2126	20	168 936879	22
101	68		Er	-n	-60923.1	1.2	8117.019	0.007	β^-	352.1	1.1	168 934596.4	1.3
100	69		Tm		-61275.2	0.8	8114.473	0.005	*			168 934218.4	0.9
99	70		Yb	-n	-60377.6	1.2	8104.532	0.007	β^+	897.6	1.1	168 935182.0	1.3
98	71		Lu	-	-58085	3	8086.335	0.019	β^+	2293	3	168 937644	3
97	72		Hf	x	-54717	28	8061.78	0.17	β^+	3368	28	168 941260	30
96	73		Ta	x	-50290	28	8030.96	0.17	β^+	4430	40	168 946010	30
95	74		W		-44918	15	7994.54	0.09	β^+	5370	30	168 951779	17
94	75		Re	$+\alpha$	-38409	11	7951.40	0.07	β^+	6509	19	168 958766	12
93	76		Os	$-\alpha$	-30723	25	7901.28	0.15	β^+	7687	28	168 967018	27
92	77		Ir	$+\alpha$	-22094	23	7845.60	0.14	β^+	8630	30	168 976281	25
91	78		Pt	$-\alpha$	-12510#	200#	7784#	1#	β^+	9580#	200#	168 986570#	210#
90	79		Au	x	-1790#	300#	7716#	2#	β^+	10720#	360#	168 998080#	320#

Table I. The 2012 Atomic mass table (continued, Explanation of Table on p. 030003-6)

<i>N</i>	<i>Z</i>	<i>A</i>	Elt.	Orig.	Mass excess (keV)		Binding energy per nucleon (keV)		Beta-decay energy (keV)		Atomic mass μ		
106	64	170	Gd	x	-41380#	600#	8020#	4#	β^-	5340#	720#	169 955580#	640#
105	65		Tb	x	-46720#	400#	8047#	2#	β^-	6940#	450#	169 949840#	430#
104	66		Dy	x	-53660#	200#	8083#	1#	β^-	2580#	200#	169 942390#	210#
103	67		Ho	+	-56240	50	8093.80	0.29	β^-	3870	50	169 939630	50
102	68		Er		-60108.7	1.5	8111.959	0.009	β^-	-312.8	1.8	169 935470.7	1.7
101	69		Tm		-59795.9	0.8	8105.517	0.005	β^-	968.1	0.8	169 935806.5	0.9
100	70		Yb		-60763.919	0.010	8106.609	<i>a</i>		*		169 934767.246	0.011
99	71		Lu	-	-57306	17	8081.67	0.10	β^+	3458	17	169 938479	18
98	72		Hf	x	-56254	28	8070.88	0.16	β^+	1050	30	169 939610	30
97	73		Ta	x	-50138	28	8030.30	0.16	β^+	6120	40	169 946180	30
96	74		W		-47291	13	8008.95	0.08	β^+	2850	30	169 949231	14
95	75		Re		-38913	23	7955.07	0.14	β^+	8378	27	169 958225	25
94	76		Os		-33926	10	7921.13	0.06	β^+	4987	25	169 963579	10
93	77		Ir	$-\alpha$	-23360#	90#	7854#	1#	β^+	10570#	90#	169 974920#	100#
92	78		Pt		-16299	18	7808.24	0.11	β^+	7060#	90#	169 982502	20
91	79		Au	-p	-3750#	200#	7730#	1#	β^+	12550#	200#	169 995970#	210#
106	65	171	Tb	x	-44030#	500#	8031#	3#	β^-	6160#	590#	170 952730#	540#
105	66		Dy	x	-50190#	300#	8063#	2#	β^-	4330#	670#	170 946120#	320#
104	67		Ho	+	-54520	600	8084	4	β^-	3200	600	170 941470	640
103	68		Er		-57719.0	1.6	8097.746	0.009	β^-	1491.3	1.3	170 938036.1	1.7
102	69		Tm		-59210.3	1.0	8101.893	0.006	β^-	96.5	1.0	170 936435.1	1.0
101	70		Yb		-59306.810	0.013	8097.882	<i>a</i>		*		170 936331.517	0.014
100	71		Lu		-57828.4	1.9	8084.661	0.011	β^+	1478.4	1.9	170 937918.7	2.0
99	72		Hf	x	-55431	29	8066.07	0.17	β^+	2397	29	170 940490	30
98	73		Ta	x	-51720	28	8039.79	0.16	β^+	3710	40	170 944480	30
97	74		W	x	-47086	28	8008.12	0.16	β^+	4630	40	170 949450	30
96	75		Re	x	-41250	28	7969.41	0.16	β^+	5840	40	170 955720	30
95	76		Os		-34302	18	7924.20	0.10	β^+	6950	30	170 963175	19
94	77		Ir	$-\alpha$	-26410	40	7873.49	0.22	β^+	7890	40	170 971650	40
93	78		Pt	$-\alpha$	-17470	70	7816.6	0.4	β^+	8940	80	170 981250	80
92	79		Au	-p	-7562	21	7754.11	0.12	β^+	9910	80	170 991882	22
91	80		Hg	$-\alpha$	3480#	300#	7685#	2#	β^+	11040#	300#	171 003740#	330#
107	65	172	Tb	x	-39850#	500#	8007#	3#	β^-	8160#	590#	171 957220#	540#
106	66		Dy	x	-48010#	300#	8050#	2#	β^-	3470#	360#	171 948460#	320#
105	67		Ho	x	-51480#	200#	8066#	1#	β^-	5000#	200#	171 944730#	210#
104	68		Er		-56484	4	8090.410	0.023	β^-	891	5	171 939362	4
103	69		Tm		-57374	6	8091.04	0.03	β^-	1881	6	171 938406	6
102	70		Yb		-59255.446	0.014	8097.429	<i>a</i>		*		171 936386.659	0.015
101	71		Lu		-56736.0	2.3	8078.232	0.014	β^+	2519.5	2.3	171 939091.4	2.5
100	72		Hf	x	-56402	24	8071.74	0.14	β^+	334	25	171 939450	26
99	73		Ta	x	-51330	28	8037.70	0.16	β^+	5070	40	171 944900	30
98	74		W	x	-49097	28	8020.17	0.16	β^+	2230	40	171 947290	30
97	75		Re		-41540	40	7971.67	0.23	β^+	7560	50	171 955410	40
96	76		Os		-37244	13	7942.16	0.07	β^+	4290	40	171 960017	14
95	77		Ir	$-\alpha$	-27380	30	7880.26	0.19	β^+	9860	30	171 970610	30
94	78		Pt		-21107	10	7839.25	0.06	β^+	6270	30	171 977341	11
93	79		Au	$-\alpha$	-9320	60	7766.2	0.3	β^+	11790	60	171 990000	60
92	80		Hg	$-\alpha$	-1060	150	7713.6	0.9	β^+	8260	140	171 998860	160

Table I. The 2012 Atomic mass table (continued, Explanation of Table on p. 030003-6)

N	Z	A	Elt.	Orig.	Mass excess (keV)		Binding energy per nucleon (keV)		Beta-decay energy (keV)		Atomic mass μu		
107	66	173	Dy	x	-43940#	400#	8027#	2#	β^-	5410#	500#	172 952830#	430#
106	67		Ho	x	-49350#	300#	8054#	2#	β^-	4300#	360#	172 947020#	320#
105	68		Er	x	-53650#	200#	8074#	1#	β^-	2600#	200#	172 942400#	210#
104	69		Tm	p2n	-56256	4	8084.463	0.025	β^-	1295	4	172 939607	5
103	70		Yb		-57551.225	0.011	8087.427	a	*			172 938216.215	0.012
102	71		Lu		-56880.9	1.6	8079.030	0.009	β^+	670.3	1.6	172 938935.8	1.7
101	72		Hf	x	-55412	28	8066.02	0.16	β^+	1469	28	172 940510	30
100	73		Ta	x	-52397	28	8044.06	0.16	β^+	3020	40	172 943750	30
99	74		W	x	-48727	28	8018.33	0.16	β^+	3670	40	172 947690	30
98	75		Re	x	-43554	28	7983.91	0.16	β^+	5170	40	172 953240	30
97	76		Os		-37438	15	7944.03	0.09	β^+	6120	30	172 959808	16
96	77		Ir		-30268	11	7898.07	0.06	β^+	7170	19	172 967505	12
95	78		Pt	$-\alpha$	-21940	60	7845.4	0.3	β^+	8330	60	172 976440	60
94	79		Au	$+\alpha$	-12832	23	7788.24	0.13	β^+	9110	60	172 986224	24
93	80		Hg	$-\alpha$	-2710#	200#	7725#	1#	β^+	10120#	200#	172 997090#	210#
108	66	174	Dy	x	-41370#	500#	8012#	3#	β^-	4320#	590#	173 955590#	540#
107	67		Ho	x	-45690#	300#	8033#	2#	β^-	6260#	420#	173 950950#	320#
106	68		Er	x	-51950#	300#	8064#	2#	β^-	1920#	300#	173 944230#	320#
105	69		Tm	+	-53860	40	8070.64	0.26	β^-	3080	40	173 942170	50
104	70		Yb		-56944.512	0.011	8083.847	a	β^-	-1374.3	1.6	173 938867.548	0.012
103	71		Lu		-55570.2	1.6	8071.453	0.009	β^-	274.3	2.2	173 940342.9	1.7
102	72		Hf		-55844.5	2.3	8068.533	0.013	*			173 940048.5	2.4
101	73		Ta	x	-51741	28	8040.45	0.16	β^+	4104	28	173 944450	30
100	74		W	x	-50227	28	8027.26	0.16	β^+	1510	40	173 946080	30
99	75		Re	x	-43673	28	7985.09	0.16	β^+	6550	40	173 953120	30
98	76		Os		-39995	10	7959.46	0.06	β^+	3678	30	173 957063	11
97	77		Ir		-30863	24	7902.48	0.14	β^+	9132	26	173 966867	26
96	78		Pt	$-\alpha$	-25318	10	7866.12	0.06	β^+	5545	26	173 972820	11
95	79		Au	$-\alpha$	-14240#	90#	7798#	1#	β^+	11080#	90#	173 984720#	100#
94	80		Hg	$-\alpha$	-6641	19	7749.78	0.11	β^+	7590#	90#	173 992871	21
108	67	175	Ho	x	-43200#	400#	8019#	2#	β^-	5450#	570#	174 953620#	430#
107	68		Er	x	-48650#	400#	8045#	2#	β^-	3660#	400#	174 947770#	430#
106	69		Tm	+	-52310	50	8061.77	0.29	β^-	2380	50	174 943840	50
105	70		Yb		-54695.55	0.07	8070.925	0.001	β^-	470.0	1.2	174 941281.91	0.08
104	71		Lu		-55165.6	1.2	8069.140	0.007	*			174 940777.3	1.3
103	72		Hf		-54481.7	2.3	8060.761	0.013	β^+	683.9	2.0	174 941511.5	2.4
102	73		Ta	x	-52409	28	8044.44	0.16	β^+	2073	28	174 943740	30
101	74		W	x	-49633	28	8024.11	0.16	β^+	2780	40	174 946720	30
100	75		Re	x	-45288	28	7994.82	0.16	β^+	4340	40	174 951380	30
99	76		Os		-40105	12	7960.73	0.07	β^+	5180	30	174 956945	13
98	77		Ir		-33395	12	7917.91	0.07	β^+	6711	17	174 964150	13
97	78		Pt		-25713	18	7869.55	0.10	β^+	7681	22	174 972395	20
96	79		Au	$-\alpha$	-17400	40	7817.59	0.22	β^+	8310	40	174 981320	40
95	80		Hg	$-\alpha$	-7970	70	7759.2	0.4	β^+	9430	80	174 991440	80
109	67	176	Ho	x	-39290#	500#	7997#	3#	β^-	7340#	640#	175 957820#	540#
108	68		Er	x	-46630#	400#	8034#	2#	β^-	2740#	410#	175 949940#	430#
107	69		Tm	+	-49370	100	8045.1	0.6	β^-	4120	100	175 947000	110
106	70		Yb		-53491.314	0.015	8064.085	a	β^-	-109.1	1.2	175 942574.709	0.016
105	71		Lu		-53382.2	1.2	8059.020	0.007	β^-	1194.1	0.9	175 942691.8	1.3
104	72		Hf		-54576.3	1.5	8061.359	0.008	*			175 941409.9	1.6
103	73		Ta	x	-51370	30	8038.67	0.17	β^+	3210	30	175 944860	30
102	74		W	x	-50642	28	8030.11	0.16	β^+	720	40	175 945630	30
101	75		Re	x	-45063	28	7993.97	0.16	β^+	5580	40	175 951620	30
100	76		Os	x	-42098	28	7972.68	0.16	β^+	2960	40	175 954810	30
99	77		Ir		-33878	17	7921.53	0.10	β^+	8220	30	175 963630	18
98	78		Pt		-28934	13	7888.99	0.07	β^+	4944	21	175 968938	14
97	79		Au	$-\alpha$	-18520	30	7825.38	0.19	β^+	10410	40	175 980120	40
96	80		Hg		-11785	11	7782.67	0.06	β^+	6740	30	175 987348	12
95	81		Tl	-p	580	80	7708.0	0.4	β^+	12370	80	176 000620	80

Table I. The 2012 Atomic mass table (continued, Explanation of Table on p. 030003-6)

<i>N</i>	<i>Z</i>	<i>A</i>	Elt.	Orig.	Mass excess (keV)		Binding energy per nucleon (keV)		Beta-decay energy (keV)		Atomic mass μu		
109	68	177	Er	x	-42860#	500#	8013#	3#	β^-	4610#	590#	176 953990#	540#
108	69		Tm	x	-47470#	300#	8035#	2#	β^-	3520#	300#	176 949040#	320#
107	70		Yb	-n	-50986.40	0.22	8049.973	0.001	β^-	1397.4	1.2	176 945263.85	0.24
106	71		Lu		-52383.8	1.2	8053.448	0.007	β^-	496.8	0.8	176 943763.7	1.3
105	72		Hf		-52880.6	1.4	8051.835	0.008	*			176 943230.3	1.5
104	73		Ta	-	-51715	3	8040.827	0.019	β^+	1166	3	176 944482	4
103	74		W	x	-49702	28	8025.04	0.16	β^+	2013	28	176 946640	30
102	75		Re	x	-46269	28	8001.22	0.16	β^+	3430	40	176 950330	30
101	76		Os	$+\alpha$	-41956	15	7972.44	0.08	β^+	4310	30	176 954958	16
100	77		Ir	x	-36047	20	7934.63	0.11	β^+	5909	25	176 961302	21
99	78		Pt		-29370	15	7892.49	0.08	β^+	6677	25	176 968470	16
98	79		Au		-21545	10	7843.86	0.06	β^+	7825	18	176 976870	11
97	80		Hg	$-\alpha$	-12780	80	7789.9	0.4	β^+	8760	80	176 986280	80
96	81		Tl	IT	-3341	22	7732.17	0.12	β^+	9440	80	176 996414	23
110	68	178	Er	x	-40260#	600#	7999#	3#	β^-	3860#	720#	177 956780#	640#
109	69		Tm	x	-44120#	400#	8016#	2#	β^-	5580#	400#	177 952640#	430#
108	70		Yb	-nn	-49695	10	8042.84	0.06	β^-	642	10	177 946650	11
107	71		Lu		-50337.8	2.3	8042.054	0.013	β^-	2097.5	2.1	177 945960.2	2.4
106	72		Hf		-52435.2	1.4	8049.442	0.008	*			177 943708.5	1.5
105	73		Ta	IT	-50600#	50#	8035#	0#	β^+	1840#	50#	177 945680#	60#
104	74		W	-	-50407	15	8029.26	0.09	β^+	190#	50#	177 945886	16
103	75		Re	x	-45653	28	7998.16	0.16	β^+	4750	30	177 950990	30
102	76		Os		-43544	14	7981.91	0.08	β^+	2110	30	177 953253	15
101	77		Ir	x	-36252	20	7936.55	0.11	β^+	7292	24	177 961082	21
100	78		Pt		-31998	10	7908.25	0.06	β^+	4254	22	177 965649	11
99	79		Au		-22304	10	7849.40	0.06	β^+	9694	14	177 976056	11
98	80		Hg	$-\alpha$	-16316	11	7811.36	0.06	β^+	5988	15	177 982484	12
97	81		Tl	$-\alpha$	-4790#	90#	7742#	1#	β^+	11530#	90#	177 994860#	100#
96	82		Pb	$-\alpha$	3574	24	7690.83	0.13	β^+	8370#	90#	178 003837	26
110	69	179	Tm	x	-41600#	500#	8002#	3#	β^-	4940#	540#	178 955340#	540#
109	70		Yb	x	-46540#	200#	8025#	1#	β^-	2520#	200#	178 950040#	210#
108	71		Lu		-49059	5	8035.073	0.029	β^-	1404	5	178 947333	6
107	72		Hf		-50462.9	1.4	8038.546	0.008	*			178 945825.8	1.5
106	73		Ta		-50357.3	1.5	8033.585	0.008	β^+	105.6	0.4	178 945939.2	1.6
105	74		W		-49295	15	8023.28	0.08	β^+	1062	15	178 947080	16
104	75		Re		-46584	25	8003.77	0.14	β^+	2711	27	178 949990	26
103	76		Os		-43019	17	7979.48	0.09	β^+	3565	30	178 953817	18
102	77		Ir		-38082	10	7947.52	0.05	β^+	4938	19	178 959118	10
101	78		Pt		-32268	8	7910.68	0.04	β^+	5814	13	178 965359	9
100	79		Au		-24989	12	7865.64	0.07	β^+	7280	14	178 973174	13
99	80		Hg		-16928	27	7816.24	0.15	β^+	8060	30	178 981827	29
98	81		Tl	$-\alpha$	-8270	40	7763.49	0.22	β^+	8660	50	178 991120	40
97	82		Pb	$-\alpha$	2050	80	7701.5	0.4	β^+	10320	80	179 002200	80
111	69	180	Tm	x	-37920#	500#	7982#	3#	β^-	6680#	590#	179 959290#	540#
110	70		Yb	x	-44600#	300#	8015#	2#	β^-	2080#	310#	179 952120#	320#
109	71		Lu	+	-46680	70	8022.0	0.4	β^-	3100	70	179 949890	80
108	72		Hf		-49779.3	1.4	8034.930	0.008	β^-	-846.5	2.3	179 946559.7	1.5
107	73		Ta	+n	-48932.9	1.9	8025.881	0.011	β^-	703.2	2.3	179 947468.4	2.1
106	74		W		-49636.1	1.4	8025.442	0.008	*			179 946713.4	1.5
105	75		Re	x	-45837	21	7999.99	0.12	β^+	3799	21	179 950792	23
104	76		Os		-44358	16	7987.43	0.09	β^+	1480	27	179 952380	18
103	77		Ir	x	-37978	22	7947.63	0.12	β^+	6380	27	179 959229	23
102	78		Pt	$+\alpha$	-34436	11	7923.61	0.06	β^+	3542	24	179 963032	12
101	79		Au		-25626	5	7870.318	0.027	β^+	8810	12	179 972490	5
100	80		Hg		-20250	13	7836.11	0.07	β^+	5375	14	179 978260	14
99	81		Tl	$-\alpha$	-9390	60	7771.4	0.3	β^+	10860	60	179 989920	60
98	82		Pb	$-\alpha$	-1941	12	7725.70	0.07	β^+	7450	60	179 997916	13

Table I. The 2012 Atomic mass table (continued, Explanation of Table on p. 030003-6)

<i>N</i>	<i>Z</i>	<i>A</i>	Elt.	Orig.	Mass excess (keV)		Binding energy per nucleon (keV)		Beta-decay energy (keV)		Atomic mass μ		
112	69	181	Tm	x	-35170#	600#	7967#	3#	β^-	5920#	670#	180 962240#	640#
111	70		Yb	x	-41090#	300#	7996#	2#	β^-	3710#	320#	180 955890#	320#
110	71		Lu	x	-44800	130	8011.9	0.7	β^-	2610	130	180 951910	140
109	72		Hf	-n	-47402.8	1.4	8022.002	0.008	β^-	1035.5	1.8	180 949111.0	1.5
108	73		Ta		-48438.3	1.4	8023.400	0.008	*			180 947999.3	1.5
107	74		W	-n	-48233.8	1.4	8017.948	0.008	β^+	204.5	1.9	180 948218.9	1.6
106	75		Re	4n	-46517	13	8004.14	0.07	β^+	1716	13	180 950062	13
105	76		Os		-43550	25	7983.43	0.14	β^+	2967	28	180 953247	27
104	77		Ir	$+\alpha$	-39463	5	7956.523	0.029	β^+	4087	26	180 957635	6
103	78		Pt		-34382	14	7924.13	0.08	β^+	5082	15	180 963090	15
102	79		Au	$-\alpha$	-27871	20	7883.84	0.11	β^+	6510	24	180 970079	21
101	80		Hg		-20661	15	7839.68	0.08	β^+	7210	25	180 977819	17
100	81		Tl		-12799	9	7791.92	0.05	β^+	7862	18	180 986260	10
99	82		Pb	$-\alpha$	-3120	80	7734.1	0.4	β^+	9680	80	180 996650	80
112	70	182	Yb	x	-38820#	400#	7984#	2#	β^-	3060#	450#	181 958330#	430#
111	71		Lu	x	-41880#	200#	7996#	1#	β^-	4170#	200#	181 955040#	210#
110	72		Hf	-nn	-46050	6	8014.84	0.03	β^-	380	6	181 950564	7
109	73		Ta		-46429.9	1.4	8012.628	0.008	β^-	1816.1	1.4	181 950155.4	1.5
108	74		W		-48246.1	0.7	8018.308	0.004	*			181 948205.7	0.8
107	75		Re	IT	-45450	100	7998.6	0.6	β^+	2800	100	181 951210	110
106	76		Os		-44609	22	7989.73	0.12	β^+	840	100	181 952110	23
105	77		Ir		-39052	21	7954.89	0.12	β^+	5560	30	181 958076	23
104	78		Pt		-36168	13	7934.75	0.07	β^+	2883	25	181 961172	14
103	79		Au	$-\alpha$	-28301	20	7887.23	0.11	β^+	7868	24	181 969618	22
102	80		Hg		-23577	10	7856.97	0.05	β^+	4724	23	181 974689	11
101	81		Tl	$-\alpha$	-13328	12	7796.36	0.07	β^+	10249	15	181 985692	13
100	82		Pb	$-\alpha$	-6825	12	7756.33	0.07	β^+	6503	17	181 992673	13
113	70	183	Yb	x	-35100#	400#	7964#	2#	β^-	4620#	410#	182 962320#	430#
112	71		Lu	x	-39720	80	7984.8	0.4	β^-	3570	90	182 957360	90
111	72		Hf	+	-43280	30	8000.03	0.16	β^-	2010	30	182 953530	30
110	73		Ta	-n	-45292.8	1.4	8006.735	0.008	β^-	1072.8	1.4	182 951376.2	1.5
109	74		W		-46365.6	0.7	8008.322	0.004	*			182 950224.5	0.8
108	75		Re	-	-45810	8	8001.01	0.04	β^+	556	8	182 950821	9
107	76		Os		-43660	50	7985.01	0.27	β^+	2150	50	182 953120	50
106	77		Ir		-40203	24	7961.82	0.13	β^+	3460	50	182 956840	26
105	78		Pt		-35772	16	7933.34	0.08	β^+	4431	29	182 961597	17
104	79		Au		-30191	9	7898.56	0.05	β^+	5581	18	182 967588	10
103	80		Hg		-23805	7	7859.39	0.04	β^+	6387	12	182 974445	8
102	81		Tl		-16587	9	7815.67	0.05	β^+	7217	12	182 982193	10
101	82		Pb	$-\alpha$	-7575	28	7762.15	0.15	β^+	9012	30	182 991870	30
114	70	184	Yb	x	-32540#	500#	7951#	3#	β^-	3870#	590#	183 965070#	540#
113	71		Lu	x	-36410#	300#	7967#	2#	β^-	5090#	300#	183 960910#	320#
112	72		Hf	+	-41500	40	7990.72	0.22	β^-	1340	30	183 955450	40
111	73		Ta	+	-42839	26	7993.75	0.14	β^-	2866	26	183 954010	28
110	74		W		-45705.4	0.7	8005.077	0.004	β^-	-1486	4	183 950933.3	0.8
109	75		Re		-44220	4	7992.750	0.023	β^-	33	4	183 952528	5
108	76		Os		-44252.5	0.8	7988.677	0.005	*			183 952492.9	0.9
107	77		Ir	x	-39611	28	7959.20	0.15	β^+	4642	28	183 957480	30
106	78		Pt		-37334	16	7942.57	0.08	β^+	2280	30	183 959920	17
105	79		Au	$-\alpha$	-30319	22	7900.19	0.12	β^+	7016	27	183 967452	24
104	80		Hg		-26349	10	7874.37	0.05	β^+	3970	24	183 971713	11
103	81		Tl		-16883	10	7818.67	0.05	β^+	9466	14	183 981875	11
102	82		Pb		-11052	13	7782.73	0.07	β^+	5832	16	183 988136	14
101	83		Bi	$-\alpha$	1060	80	7712.6	0.4	β^+	12110	80	184 001140	80

Table I. The 2012 Atomic mass table (continued, Explanation of Table on p. 030003-6)

<i>N</i>	<i>Z</i>	<i>A</i>	Elt.	Orig.	Mass excess (keV)		Binding energy per nucleon (keV)		Beta-decay energy (keV)		Atomic mass μ		
115	70	185	Yb	x	-28500#	500#	7929#	3#	β^-	5390#	590#	184 969400#	540#
114	71		Lu	x	-33890#	300#	7954#	2#	β^-	4430#	310#	184 963620#	320#
113	72		Hf	x	-38320	60	7974.0	0.3	β^-	3070	70	184 958860	70
112	73		Ta	+	-41394	14	7986.36	0.08	β^-	1994	14	184 955561	15
111	74		W		-43387.8	0.7	7992.907	0.004	β^-	431.2	0.7	184 953421.3	0.8
110	75		Re		-43819.0	0.8	7991.009	0.004	*			184 952958.3	0.9
109	76		Os		-42805.9	0.8	7981.304	0.004	β^+	1013.1	0.4	184 954046.0	0.9
108	77		Ir	x	-40336	28	7963.72	0.15	β^+	2470	28	184 956700	30
107	78		Pt		-36688	26	7939.78	0.14	β^+	3650	40	184 960614	28
106	79		Au	x	-31858.1	2.6	7909.440	0.014	β^+	4830	26	184 965798.9	2.8
105	80		Hg		-26184	14	7874.54	0.07	β^+	5674	14	184 971891	15
104	81		Tl	IT	-19758	21	7835.57	0.11	β^+	6426	25	184 978789	22
103	82		Pb	$-\alpha$	-11541	16	7786.93	0.09	β^+	8217	26	184 987610	17
102	83		Bi	IT	-2240#	80#	7732#	0#	β^+	9310#	80#	184 997600#	90#
115	71	186	Lu	x	-30210#	400#	7935#	2#	β^-	6210#	400#	185 967570#	430#
114	72		Hf	x	-36420	50	7964.30	0.28	β^-	2180	80	185 960900	60
113	73		Ta	+	-38610	60	7971.8	0.3	β^-	3900	60	185 958550	60
112	74		W		-42508.5	1.2	7988.601	0.007	β^-	-581.4	1.2	185 954365.2	1.3
111	75		Re		-41927.1	0.8	7981.269	0.004	β^-	1072.9	0.8	185 954989.4	0.9
110	76		Os		-42999.9	0.8	7982.831	0.004	*			185 953837.7	0.8
109	77		Ir	x	-39172	17	7958.05	0.09	β^+	3828	17	185 957947	18
108	78		Pt		-37864	22	7946.81	0.12	β^+	1308	27	185 959351	23
107	79		Au		-31715	21	7909.54	0.11	β^+	6150	30	185 965953	23
106	80		Hg		-28539	12	7888.26	0.06	β^+	3176	24	185 969362	13
105	81		Tl	x	-19887	22	7837.54	0.12	β^+	8652	25	185 978651	24
104	82		Pb	$-\alpha$	-14682	11	7805.35	0.06	β^+	5205	25	185 984238	12
103	83		Bi	$-\alpha$	-3146	17	7739.12	0.09	β^+	11536	20	185 996622	18
102	84		Po	$-\alpha$	4101	18	7695.95	0.10	β^+	7247	25	186 004403	20
116	71	187	Lu	x	-27580#	400#	7922#	2#	β^-	5240#	500#	186 970390#	430#
115	72		Hf	x	-32820#	300#	7946#	2#	β^-	4080#	300#	186 964770#	320#
114	73		Ta	x	-36900	60	7963.21	0.30	β^-	3010	60	186 960390	60
113	74		W		-39904.0	1.2	7975.116	0.006	β^-	1312.5	1.1	186 957161.3	1.3
112	75		Re		-41216.5	0.7	7977.951	0.004	β^-	2.467	0.002	186 955752.3	0.8
111	76		Os		-41218.9	0.7	7973.780	0.004	*			186 955749.6	0.8
110	77		Ir	x	-39549	28	7960.67	0.15	β^+	1670	28	186 957540	30
109	78		Pt		-36685	24	7941.17	0.13	β^+	2860	40	186 960617	26
108	79		Au		-33028	22	7917.43	0.12	β^+	3657	27	186 964543	24
107	80		Hg		-28118	14	7886.99	0.07	β^+	4910	26	186 969814	15
106	81		Tl		-22445	8	7852.46	0.04	β^+	5673	16	186 975905	9
105	82		Pb		-14987	5	7808.400	0.027	β^+	7458	10	186 983911	5
104	83		Bi	$-\alpha$	-6383	10	7758.21	0.05	β^+	8604	11	186 993147	11
103	84		Po	$-\alpha$	2830	30	7704.76	0.17	β^+	9210	30	187 003040	30
117	71	188	Lu	x	-23790#	500#	7902#	3#	β^-	7090#	590#	187 974460#	540#
116	72		Hf	x	-30880#	300#	7936#	2#	β^-	2730#	300#	187 966850#	320#
115	73		Ta	x	-33610	50	7946.32	0.29	β^-	5060	60	187 963920	60
114	74		W	+	-38668	3	7969.052	0.016	β^-	349	3	187 958488	3
113	75		Re	-n	-39016.8	0.7	7966.747	0.004	β^-	2120.42	0.15	187 958113.7	0.8
112	76		Os		-41137.2	0.7	7973.864	0.004	*			187 955837.4	0.8
111	77		Ir		-38345	9	7954.85	0.05	β^+	2792	9	187 958835	10
110	78		Pt		-37821	5	7947.902	0.028	β^+	524	9	187 959398	6
109	79		Au	x	-32371.3	2.7	7914.753	0.014	β^+	5450	6	187 965248.0	2.9
108	80		Hg		-30202	12	7899.05	0.07	β^+	2169	13	187 967577	13
107	81		Tl	x	-22336	30	7853.05	0.16	β^+	7870	30	187 976020	30
106	82		Pb	$-\alpha$	-17815	11	7824.84	0.06	β^+	4520	30	187 980875	11
105	83		Bi	$-\alpha$	-7195	11	7764.19	0.06	β^+	10621	15	187 992276	12
104	84		Po	$-\alpha$	-544	20	7724.65	0.11	β^+	6650	23	187 999416	21

Table I. The 2012 Atomic mass table (continued, Explanation of Table on p. 030003-6)

<i>N</i>	<i>Z</i>	<i>A</i>	Elt.	Orig.	Mass excess (keV)		Binding energy per nucleon (keV)		Beta-decay energy (keV)		Atomic mass μ u		
117	72	189	Hf	x	-27160#	300#	7917#	2#	β^-	4670#	360#	188 970840#	320#
116	73		Ta	x	-31830#	200#	7938#	1#	β^-	3790#	200#	188 965830#	210#
115	74		W	x	-35620	40	7953.45	0.21	β^-	2360	40	188 961760	40
114	75		Re	+p	-37979	8	7961.81	0.04	β^-	1008	8	188 959228	9
113	76		Os		-38986.7	0.7	7963.002	0.004	*			188 958146.0	0.7
112	77		Ir		-38450	13	7956.02	0.07	β^+	537	13	188 958723	14
111	78		Pt		-36469	10	7941.40	0.05	β^+	1980	14	188 960849	11
110	79		Au	x	-33582	20	7921.99	0.11	β^+	2887	22	188 963948	22
109	80		Hg		-29630	30	7896.92	0.17	β^+	3960	40	188 968190	30
108	81		Tl		-24616	8	7866.27	0.04	β^+	5010	30	188 973574	9
107	82		Pb		-17844	14	7826.30	0.07	β^+	6772	16	188 980844	15
106	83		Bi	$-\alpha$	-10065	21	7781.00	0.11	β^+	7779	25	188 989195	22
105	84		Po	$-\alpha$	-1422	22	7731.13	0.12	β^+	8640	30	188 998473	24
118	72	190	Hf	x	-25030#	400#	7907#	2#	β^-	3480#	450#	189 973130#	430#
117	73		Ta	x	-28510#	200#	7921#	1#	β^-	5870#	200#	189 969390#	210#
116	74		W		-34380	40	7947.57	0.21	β^-	1250	60	189 963090	40
115	75		Re		-35640	70	7950.1	0.4	β^-	3070	70	189 961740	80
114	76		Os		-38707.8	0.6	7962.104	0.003	β^-	-1954.2	1.2	189 958445.5	0.7
113	77		Ir	+n	-36753.5	1.4	7947.701	0.007	β^-	552.9	1.3	189 960543.4	1.5
112	78		Pt		-37306.5	0.7	7946.493	0.003	*			189 959949.9	0.7
111	79		Au	x	-32834	3	7918.834	0.018	β^+	4473	4	189 964752	4
110	80		Hg		-31371	16	7907.02	0.08	β^+	1463	16	189 966322	17
109	81		Tl	$+\alpha$	-24372	8	7866.06	0.04	β^+	6999	18	189 973836	9
108	82		Pb	$-\alpha$	-20417	13	7841.13	0.07	β^+	3955	15	189 978082	13
107	83		Bi	$-\alpha$	-10600	23	7785.34	0.12	β^+	9817	26	189 988621	24
106	84		Po	$-\alpha$	-4564	13	7749.46	0.07	β^+	6036	26	189 995101	14
118	73	191	Ta	x	-26490#	300#	7911#	2#	β^-	4680#	300#	190 971560#	320#
117	74		W	x	-31180	40	7931.44	0.22	β^-	3170	40	190 966530	50
116	75		Re	+p	-34350	10	7943.96	0.05	β^-	2045	10	190 963123	11
115	76		Os		-36395.2	0.7	7950.568	0.003	β^-	313.6	1.1	190 960928.2	0.7
114	77		Ir		-36708.8	1.3	7948.113	0.007	*			190 960591.5	1.4
113	78		Pt		-35698	4	7938.727	0.022	β^+	1011	4	190 961676	4
112	79		Au		-33798	5	7924.681	0.026	β^+	1900	6	190 963716	5
111	80		Hg		-30592	22	7903.80	0.12	β^+	3206	23	190 967158	24
110	81		Tl	$+\alpha$	-26283	7	7877.14	0.04	β^+	4309	23	190 971784	8
109	82		Pb	x	-20230	40	7841.36	0.20	β^+	6050	40	190 978280	40
108	83		Bi		-13239	7	7800.66	0.04	β^+	6990	40	190 985787	8
107	84		Po		-5069	7	7753.79	0.04	β^+	8171	10	190 994558	8
106	85		At	$-\alpha$	3864	16	7702.92	0.08	β^+	8933	18	191 004148	17
119	73	192	Ta	x	-23060#	400#	7894#	2#	β^-	6590#	450#	191 975240#	430#
118	74		W	x	-29650#	200#	7924#	1#	β^-	1940#	210#	191 968170#	210#
117	75		Re	x	-31590	70	7930.2	0.4	β^-	4290	70	191 966090	80
116	76		Os		-35882.2	2.3	7948.525	0.012	β^-	-1046.6	2.4	191 961478.9	2.5
115	77		Ir		-34835.6	1.3	7938.999	0.007	β^-	1452.9	2.3	191 962602.5	1.4
114	78		Pt		-36288.5	2.6	7942.491	0.013	*			191 961042.7	2.8
113	79		Au	-	-32772	16	7920.10	0.08	β^+	3516	16	191 964818	17
112	80		Hg	x	-32012	16	7912.07	0.08	β^+	761	22	191 965634	17
111	81		Tl	x	-25870	30	7876.02	0.16	β^+	6140	40	191 972230	30
110	82		Pb	$-\alpha$	-22556	13	7854.67	0.07	β^+	3320	30	191 975785	14
109	83		Bi	$-\alpha$	-13530	30	7803.61	0.16	β^+	9020	30	191 985470	30
108	84		Po	$-\alpha$	-8071	11	7771.08	0.06	β^+	5460	30	191 991336	12
107	85		At	$-\alpha$	2926	28	7709.73	0.15	β^+	11000	30	192 003141	30

Table I. The 2012 Atomic mass table (continued, Explanation of Table on p. 030003-6)

<i>N</i>	<i>Z</i>	<i>A</i>	Elt.	Orig.	Mass excess (keV)		Binding energy per nucleon (keV)		Beta-decay energy (keV)		Atomic mass μ		
120	73	193	Ta	x	-20870#	400#	7884#	2#	β^-	5420#	450#	192 977600#	430#
119	74		W	x	-26290#	200#	7908#	1#	β^-	3950#	200#	192 971780#	210#
118	75		Re	x	-30230	40	7923.94	0.20	β^-	3160	40	192 967550	40
117	76		Os		-33394.3	2.3	7936.270	0.012	β^-	1141.9	2.4	192 964149.8	2.5
116	77		Ir		-34536.2	1.3	7938.133	0.007	*			192 962923.8	1.4
115	78		Pt		-34479.6	1.4	7933.786	0.007	β^+	56.63	0.30	192 962984.6	1.5
114	79		Au		-33405	9	7924.16	0.04	β^+	1075	9	192 964138	9
113	80		Hg		-31062	16	7907.97	0.08	β^+	2343	14	192 966653	17
112	81		Tl	x	-27477	7	7885.34	0.03	β^+	3585	17	192 970502	7
111	82		Pb	x	-22190	50	7853.92	0.26	β^+	5280	50	192 976170	50
110	83		Bi		-15885	8	7817.17	0.04	β^+	6310	50	192 982947	8
109	84		Po	$-\alpha$	-8325	15	7773.95	0.08	β^+	7559	16	192 991062	16
108	85		At	$-\alpha$	-67	22	7727.11	0.11	β^+	8258	26	192 999928	23
107	86		Rn	$-\alpha$	9043	25	7675.85	0.13	β^+	9110	30	193 009708	27
121	73	194	Ta	x	-17300#	500#	7866#	3#	β^-	7230#	590#	193 981430#	540#
120	74		W	x	-24530#	300#	7899#	2#	β^-	2710#	360#	193 973670#	320#
119	75		Re	x	-27240#	200#	7909#	1#	β^-	5200#	200#	193 970760#	210#
118	76		Os	+	-32435.1	2.4	7932.022	0.012	β^-	96.6	2.0	193 965179.5	2.6
117	77		Ir	-n	-32531.7	1.3	7928.487	0.007	β^-	2228.4	1.3	193 965075.8	1.4
116	78		Pt		-34760.1	0.5	7935.941	0.003	*			193 962683.5	0.5
115	79		Au	+3n	-32211.9	2.1	7918.774	0.011	β^+	2548.1	2.1	193 965419.1	2.3
114	80		Hg	x	-32183.9	2.9	7914.597	0.015	β^+	28	4	193 965449	3
113	81		Tl	x	-26937	14	7883.52	0.07	β^+	5246	14	193 971081	15
112	82		Pb		-24208	17	7865.42	0.09	β^+	2730	22	193 974012	19
111	83		Bi	+ α	-16029	6	7819.22	0.03	β^+	8179	18	193 982792	7
110	84		Po	$-\alpha$	-11005	13	7789.29	0.07	β^+	5024	14	193 988186	14
109	85		At	$-\alpha$	-720	25	7732.25	0.13	β^+	10284	28	193 999227	27
108	86		Rn	$-\alpha$	5723	17	7695.00	0.09	β^+	6440	30	194 006144	18
121	74	195	W	x	-21010#	300#	7882#	2#	β^-	4570#	420#	194 977450#	320#
120	75		Re	x	-25580#	300#	7902#	2#	β^-	3930#	300#	194 972540#	320#
119	76		Os	x	-29510	60	7917.74	0.29	β^-	2180	60	194 968320	60
118	77		Ir	-n	-31692.3	1.3	7924.915	0.007	β^-	1101.6	1.3	194 965977.0	1.4
117	78		Pt		-32793.8	0.5	7926.552	0.003	*			194 964794.4	0.5
116	79		Au		-32567.0	1.1	7921.377	0.006	β^+	226.8	1.0	194 965037.9	1.2
115	80		Hg		-31013	23	7909.40	0.12	β^+	1554	23	194 966706	25
114	81		Tl		-28155	11	7890.73	0.06	β^+	2858	26	194 969774	12
113	82		Pb		-23708	18	7863.91	0.09	β^+	4448	21	194 974549	19
112	83		Bi		-18026	5	7830.757	0.027	β^+	5682	19	194 980649	6
111	84		Po	$-\alpha$	-11060	40	7791.01	0.19	β^+	6970	40	194 988130	40
110	85		At	$-\alpha$	-3470	10	7748.09	0.05	β^+	7590	40	194 996274	10
109	86		Rn	$-\alpha$	5050	50	7700.38	0.26	β^+	8520	50	195 005420	50
122	74	196	W	x	-18880#	400#	7872#	2#	β^-	3660#	500#	195 979730#	430#
121	75		Re	x	-22540#	300#	7887#	2#	β^-	5740#	300#	195 975800#	320#
120	76		Os	+pp	-28280	40	7912.23	0.20	β^-	1160	60	195 969640	40
119	77		Ir	+	-29440	40	7914.15	0.20	β^-	3210	40	195 968400	40
118	78		Pt		-32644.5	0.5	7926.529	0.003	β^-	-1505.8	3.0	195 964954.7	0.5
117	79		Au		-31138.7	3.0	7914.855	0.015	β^-	687	3	195 966571	3
116	80		Hg		-31825.9	2.9	7914.369	0.015	*			195 965833	3
115	81		Tl	x	-27497	12	7888.29	0.06	β^+	4329	12	195 970481	13
114	82		Pb		-25348	8	7873.34	0.04	β^+	2148	14	195 972787	8
113	83		Bi	x	-18009	24	7831.90	0.12	β^+	7339	26	195 980667	26
112	84		Po	$-\alpha$	-13473	14	7804.77	0.07	β^+	4536	28	195 985536	15
111	85		At	$-\alpha$	-3910	30	7752.01	0.15	β^+	9560	30	195 995800	30
110	86		Rn	$-\alpha$	1971	14	7717.99	0.07	β^+	5890	30	196 002116	15

Table I. The 2012 Atomic mass table (continued, Explanation of Table on p. 030003-6)

<i>N</i>	<i>Z</i>	<i>A</i>	Elt.	Orig.	Mass excess (keV)		Binding energy per nucleon (keV)		Beta-decay energy (keV)		Atomic mass μ		
123	74	197	W	x	-15140#	400#	7854#	2#	β^-	5360#	500#	196 983750#	430#
122	75		Re	x	-20500#	300#	7878#	2#	β^-	4810#	360#	196 977990#	320#
121	76		Os	x	-25310#	200#	7898#	1#	β^-	2960#	200#	196 972830#	210#
120	77		Ir	+p	-28264	20	7909.00	0.10	β^-	2156	20	196 969657	22
119	78		Pt		-30419.7	0.5	7915.971	0.003	β^-	720.0	0.5	196 967343.1	0.6
118	79		Au		-31139.7	0.5	7915.654	0.003	*			196 966570.1	0.6
117	80		Hg		-30540	3	7908.640	0.016	β^+	600	3	196 967214	3
116	81		Tl	+ α	-28342	16	7893.51	0.08	β^+	2199	17	196 969574	18
115	82		Pb		-24745	5	7871.282	0.024	β^+	3596	17	196 973435	5
114	83		Bi	+ α	-19687	8	7841.63	0.04	β^+	5058	10	196 978865	9
113	84		Po	- α	-13360	50	7805.53	0.25	β^+	6330	50	196 985660	50
112	85		At		-6355	8	7766.02	0.04	β^+	7000	50	196 993177	9
111	86		Rn	- α	1510	16	7722.12	0.08	β^+	7866	18	197 001621	17
110	87		Fr	- α	10250	50	7673.76	0.28	β^+	8740	60	197 011010	60
123	75	198	Re	x	-17140#	400#	7862#	2#	β^-	6700#	450#	197 981600#	430#
122	76		Os	x	-23840#	200#	7891#	1#	β^-	1980#	280#	197 974410#	210#
121	77		Ir	x	-25820#	200#	7897#	1#	β^-	4080#	200#	197 972280#	210#
120	78		Pt		-29904.0	2.1	7914.150	0.011	β^-	-323.2	2.1	197 967896.7	2.3
119	79		Au		-29580.8	0.5	7908.567	0.003	β^-	1373.5	0.5	197 968243.7	0.6
118	80		Hg		-30954.3	0.5	7911.552	0.002	*			197 966769.2	0.5
117	81		Tl	x	-27529	8	7890.30	0.04	β^+	3426	8	197 970447	8
116	82		Pb		-26067	9	7878.97	0.04	β^+	1461	12	197 972015	9
115	83		Bi	x	-19369	28	7841.19	0.14	β^+	6698	29	197 979210	30
114	84		Po		-15473	17	7817.56	0.09	β^+	3900	30	197 983389	19
113	85		At	x	-6715	6	7769.373	0.030	β^+	8759	18	197 992792	6
112	86		Rn	- α	-1230	13	7737.72	0.07	β^+	5484	15	197 998679	14
111	87		Fr	- α	9570	30	7679.21	0.16	β^+	10800	30	198 010280	30
124	75	199	Re	x	-14860#	400#	7851#	2#	β^-	5620#	450#	198 984050#	430#
123	76		Os	x	-20480#	200#	7875#	1#	β^-	3920#	200#	198 978010#	210#
122	77		Ir	p-2n	-24400	40	7891.21	0.21	β^-	2990	40	198 973810	40
121	78		Pt	-n	-27388.7	2.2	7902.300	0.011	β^-	1705.1	2.1	198 970597.0	2.3
120	79		Au		-29093.7	0.5	7906.937	0.003	β^-	452.3	0.6	198 968766.6	0.6
119	80		Hg		-29546.1	0.5	7905.279	0.003	*			198 968281.0	0.6
118	81		Tl	x	-28059	28	7893.88	0.14	β^+	1487	28	198 969880	30
117	82		Pb	+ α	-25232	10	7875.74	0.05	β^+	2828	30	198 972913	11
116	83		Bi		-20798	11	7849.52	0.05	β^+	4434	15	198 977673	11
115	84		Po	- α	-15208	18	7817.50	0.09	β^+	5589	21	198 983673	19
114	85		At		-8823	5	7781.488	0.027	β^+	6385	19	198 990528	6
113	86		Rn	- α	-1500	40	7740.75	0.19	β^+	7320	40	198 998390	40
112	87		Fr	- α	6771	14	7695.26	0.07	β^+	8270	40	199 007269	15
124	76	200	Os	x	-18780#	300#	7868#	1#	β^-	2830#	360#	199 979840#	320#
123	77		Ir	x	-21610#	200#	7878#	1#	β^-	4990#	200#	199 976800#	210#
122	78		Pt	-nn	-26599	20	7899.20	0.10	β^-	640	30	199 971445	22
121	79		Au		-27240	27	7898.49	0.13	β^-	2263	27	199 970757	29
120	80		Hg		-29503.3	0.5	7905.895	0.003	*			199 968326.9	0.6
119	81		Tl	-	-27047	6	7889.703	0.029	β^+	2456	6	199 970964	6
118	82		Pb	4n	-26251	11	7881.81	0.05	β^+	796	12	199 971818	12
117	83		Bi	+ α	-20371	22	7848.50	0.11	β^+	5880	25	199 978131	24
116	84		Po		-16942	8	7827.44	0.04	β^+	3429	24	199 981812	8
115	85		At	- α	-8988	24	7783.76	0.12	β^+	7954	26	199 990351	26
114	86		Rn	- α	-4005	14	7754.93	0.07	β^+	4983	28	199 995701	15
113	87		Fr	- α	6130	30	7700.33	0.15	β^+	10140	30	200 006580	30

Table I. The 2012 Atomic mass table (continued, Explanation of Table on p. 030003-6)

<i>N</i>	<i>Z</i>	<i>A</i>	Elt.	Orig.	Mass excess (keV)		Binding energy per nucleon (keV)		Beta-decay energy (keV)		Atomic mass μ		
125	76	201	Os	x	-15240#	300#	7851#	1#	β^-	4660#	360#	200 983640#	320#
124	77		Ir	x	-19900#	200#	7871#	1#	β^-	3840#	200#	200 978640#	210#
123	78		Pt	+	-23740	50	7885.83	0.25	β^-	2660	50	200 974510	50
122	79		Au		-26401	3	7895.175	0.016	β^-	1262	3	200 971658	3
121	80		Hg		-27662.5	0.7	7897.560	0.004	*			200 970303.0	0.8
120	81		Tl		-27181	14	7891.27	0.07	β^+	482	14	200 970820	15
119	82		Pb		-25271	14	7877.88	0.07	β^+	1910	19	200 972870	15
118	83		Bi	$+\alpha$	-21416	15	7854.81	0.08	β^+	3855	20	200 977009	16
117	84		Po		-16521	5	7826.561	0.025	β^+	4895	16	200 982264	5
116	85		At	$+\alpha$	-10789	8	7794.15	0.04	β^+	5732	10	200 988417	9
115	86		Rn	$-\alpha$	-4070	50	7756.84	0.25	β^+	6720	50	200 995630	50
114	87		Fr	$-\alpha$	3589	9	7714.84	0.05	β^+	7660	50	201 003852	10
113	88		Ra	$-\alpha$	11937	20	7669.41	0.10	β^+	8348	22	201 012815	22
126	76	202	Os	x	-13090#	400#	7842#	2#	β^-	3690#	500#	201 985950#	430#
125	77		Ir	x	-16780#	300#	7856#	1#	β^-	5920#	300#	201 981990#	320#
124	78		Pt	x	-22692	25	7881.56	0.12	β^-	1660	30	201 975639	27
123	79		Au	x	-24353	23	7885.91	0.12	β^-	2992	23	201 973856	25
122	80		Hg		-27345.3	0.7	7896.850	0.003	*			201 970643.6	0.8
121	81		Tl		-25980.2	1.6	7886.219	0.008	β^+	1365.1	1.6	201 972109.1	1.7
120	82		Pb		-25941	4	7882.150	0.019	β^+	40	4	201 972152	4
119	83		Bi		-20741	15	7852.54	0.08	β^+	5199	16	201 977733	17
118	84		Po		-17942	9	7834.80	0.04	β^+	2800	18	201 980739	9
117	85		At	$-\alpha$	-10591	28	7794.54	0.14	β^+	7351	29	201 988630	30
116	86		Rn	$-\alpha$	-6275	18	7769.30	0.09	β^+	4320	30	201 993264	19
115	87		Fr	$-\alpha$	3096	7	7719.04	0.03	β^+	9371	19	202 003324	8
114	88		Ra	$-\alpha$	9075	15	7685.57	0.07	β^+	5979	17	202 009742	16
127	76	203	Os	x	-7640#	400#	7816#	2#	β^-	7050#	570#	202 991800#	430#
126	77		Ir	x	-14690#	400#	7847#	2#	β^-	4940#	450#	202 984230#	430#
125	78		Pt	x	-19630#	200#	7867#	1#	β^-	3520#	200#	202 978930#	210#
124	79		Au		-23143	3	7880.864	0.015	β^-	2126	3	202 975154	3
123	80		Hg		-25269.3	1.6	7887.482	0.008	β^-	492.1	1.2	202 972872.3	1.7
122	81		Tl		-25761.4	1.2	7886.053	0.006	*			202 972344.0	1.3
121	82		Pb		-24787	7	7877.40	0.03	β^+	975	6	202 973391	7
120	83		Bi	$+\alpha$	-21525	13	7857.48	0.06	β^+	3262	14	202 976892	14
119	84		Po	$+\alpha$	-17311	9	7832.86	0.04	β^+	4214	15	202 981416	9
118	85		At		-12163	11	7803.65	0.05	β^+	5148	14	202 986943	11
117	86		Rn	$-\alpha$	-6154	18	7770.19	0.09	β^+	6009	21	202 993394	20
116	87		Fr		876	6	7731.71	0.03	β^+	7030	19	203 000941	7
115	88		Ra	$-\alpha$	8660	40	7689.50	0.19	β^+	7790	40	203 009300	40
127	77	204	Ir	x	-9690#	400#	7824#	2#	β^-	8230#	450#	203 989600#	430#
126	78		Pt	x	-17920#	200#	7860#	1#	β^-	2730#	280#	203 980760#	210#
125	79		Au	+	-20650#	200#	7870#	1#	β^-	4040#	200#	203 977830#	220#
124	80		Hg		-24690.1	0.5	7885.545	0.003	β^-	-344.0	1.2	203 973494.0	0.5
123	81		Tl		-24346.1	1.2	7880.023	0.006	β^-	763.75	0.18	203 973863.3	1.2
122	82		Pb		-25109.9	1.1	7879.932	0.006	*			203 973043.4	1.2
121	83		Bi	$+\alpha$	-20646	9	7854.21	0.05	β^+	4464	9	203 977836	10
120	84		Po	$-\alpha$	-18341	11	7839.08	0.05	β^+	2305	14	203 980310	12
119	85		At		-11875	22	7803.55	0.11	β^+	6466	25	203 987251	24
118	86		Rn		-7970	7	7780.57	0.04	β^+	3905	23	203 991444	8
117	87		Fr	$-\alpha$	607	25	7734.69	0.12	β^+	8578	26	204 000652	26
116	88		Ra	$-\alpha$	6057	15	7704.14	0.07	β^+	5449	29	204 006502	16

Table I. The 2012 Atomic mass table (continued, Explanation of Table on p. 030003-6)

<i>N</i>	<i>Z</i>	<i>A</i>	Elt.	Orig.	Mass excess (keV)		Binding energy per nucleon (keV)		Beta-decay energy (keV)		Atomic mass μ		
128	77	205	Ir	x	-5960#	500#	7807#	2#	β^-	7010#	590#	204 993600#	540#
127	78		Pt	x	-12970#	300#	7837#	1#	β^-	5800#	360#	204 986080#	320#
126	79		Au	x	-18770#	200#	7861#	1#	β^-	3520#	200#	204 979850#	210#
125	80		Hg		-22288	4	7874.732	0.018	β^-	1533	4	204 976073	4
124	81		Tl		-23820.9	1.2	7878.394	0.006		*		204 974427.2	1.3
123	82		Pb		-23770.2	1.1	7874.331	0.006	β^+	50.6	0.5	204 974481.6	1.2
122	83		Bi		-21065	5	7857.316	0.025	β^+	2706	5	204 977386	5
121	84		Po		-17521	10	7836.22	0.05	β^+	3543	11	204 981190	11
120	85		At	$+\alpha$	-12972	15	7810.21	0.07	β^+	4549	18	204 986074	16
119	86		Rn		-7710	5	7780.722	0.025	β^+	5262	16	204 991723	5
118	87		Fr	x	-1310	8	7745.69	0.04	β^+	6400	9	204 998594	8
117	88		Ra	$-\alpha$	5840	70	7707.0	0.3	β^+	7150	70	205 006270	80
116	89		Ac	$-\alpha$	14110	50	7662.85	0.25	β^+	8270	90	205 015140	50
128	78	206	Pt	x	-9630#	300#	7822#	1#	β^-	4580#	420#	205 989660#	320#
127	79		Au	x	-14220#	300#	7840#	1#	β^-	6730#	300#	205 984740#	320#
126	80		Hg	$+\alpha$	-20946	20	7869.17	0.10	β^-	1308	20	205 977514	22
125	81		Tl		-22253.4	1.3	7871.721	0.006	β^-	1532.2	0.6	205 976110.0	1.4
124	82		Pb		-23785.6	1.1	7875.362	0.006		*		205 974465.1	1.2
123	83		Bi	-	-20028	8	7853.32	0.04	β^+	3757	8	205 978499	8
122	84		Po	$-\alpha$	-18189	4	7840.597	0.019	β^+	1840	9	205 980474	4
121	85		At		-12430	15	7808.84	0.07	β^+	5759	16	205 986656	16
120	86		Rn		-9133	9	7789.04	0.04	β^+	3297	17	205 990195	9
119	87		Fr	$-\alpha$	-1242	28	7746.94	0.14	β^+	7891	29	205 998670	30
118	88		Ra	$-\alpha$	3566	18	7719.80	0.09	β^+	4810	30	206 003828	19
117	89		Ac	$-\alpha$	13480	50	7667.88	0.25	β^+	9910	50	206 014470	50
129	78	207	Pt	x	-4540#	400#	7798#	2#	β^-	6270#	500#	206 995130#	430#
128	79		Au	x	-10810#	300#	7825#	1#	β^-	5680#	300#	206 988400#	320#
127	80		Hg	x	-16487	30	7848.61	0.14	β^-	4550	30	206 982300	30
126	81		Tl		-21034	5	7866.797	0.026	β^-	1418	5	206 977419	6
125	82		Pb		-22452.0	1.1	7869.866	0.006		*		206 975896.7	1.2
124	83		Bi		-20054.6	2.4	7854.505	0.012	β^+	2397.4	2.1	206 978470.5	2.6
123	84		Po		-17146	7	7836.67	0.03	β^+	2909	7	206 981593	7
122	85		At	$+\alpha$	-13227	12	7813.96	0.06	β^+	3918	14	206 985800	13
121	86		Rn	$+\alpha$	-8635	8	7788.00	0.04	β^+	4593	15	206 990730	9
120	87		Fr		-2844	18	7756.25	0.08	β^+	5790	19	206 996946	19
119	88		Ra	$-\alpha$	3540	50	7721.60	0.26	β^+	6390	60	207 003810	60
118	89		Ac	$-\alpha$	11150	50	7681.10	0.24	β^+	7600	70	207 011970	50
130	78	208	Pt	x	-990#	400#	7783#	2#	β^-	5110#	500#	207 998940#	430#
129	79		Au	x	-6100#	300#	7804#	1#	β^-	7160#	300#	207 993450#	320#
128	80		Hg	x	-13270	30	7834.19	0.15	β^-	3480	30	207 985760	30
127	81		Tl	$+\alpha$	-16750.1	1.9	7847.183	0.009	β^-	4998.5	1.7	207 982018.0	2.0
126	82		Pb		-21748.6	1.1	7867.453	0.006		*		207 976651.9	1.2
125	83		Bi	$+\alpha$	-18870.2	2.3	7849.853	0.011	β^+	2878.4	2.0	207 979742.0	2.5
124	84		Po	$-\alpha$	-17469.6	1.7	7839.358	0.008	β^+	1400.6	2.4	207 981245.6	1.9
123	85		At	$+\alpha$	-12470	9	7811.56	0.04	β^+	5000	9	207 986613	10
122	86		Rn	$-\alpha$	-9656	11	7794.27	0.05	β^+	2814	14	207 989634	12
121	87		Fr		-2666	12	7756.90	0.06	β^+	6990	16	207 997138	13
120	88		Ra	$-\alpha$	1728	9	7732.02	0.04	β^+	4394	15	208 001855	10
119	89		Ac	$-\alpha$	10750	60	7684.86	0.27	β^+	9030	60	208 011540	60
118	90		Th	$-\alpha$	16680	30	7652.59	0.16	β^+	5930	70	208 017910	40

Table I. The 2012 Atomic mass table (continued, Explanation of Table on p. 030003-6)

<i>N</i>	<i>Z</i>	<i>A</i>	Elt.	Orig.	Mass excess (keV)		Binding energy per nucleon (keV)		Beta-decay energy (keV)		Atomic mass μ		
130	79	209	Au	x	-2540#	400#	7788#	2#	β^-	6100#	430#	208 997270#	430#
129	80		Hg	x	-8640#	150#	7813#	1#	β^-	5000#	150#	208 990720#	160#
128	81		Tl	$+\alpha$	-13645	6	7833.397	0.029	β^-	3970	6	208 985352	7
127	82		Pb		-17614.6	1.7	7848.648	0.008	β^-	644.0	1.1	208 981089.9	1.9
126	83		Bi		-18258.7	1.4	7847.987	0.007	*			208 980398.5	1.5
125	84		Po	$-\alpha$	-16366.1	1.8	7835.188	0.009	β^+	1892.6	1.6	208 982430.3	1.9
124	85		At		-12883	5	7814.777	0.024	β^+	3483	5	208 986170	5
123	86		Rn		-8941	10	7792.17	0.05	β^+	3942	11	208 990401	11
122	87		Fr	x	-3770	15	7763.69	0.07	β^+	5171	18	208 995953	16
121	88		Ra	$-\alpha$	1858	6	7733.017	0.027	β^+	5628	16	209 001995	6
120	89		Ac	$-\alpha$	8840	50	7695.85	0.24	β^+	6990	50	209 009490	50
119	90		Th	IT	16370#	140#	7656#	1#	β^+	7520#	150#	209 017570#	150#
131	79	210	Au	x	2330#	400#	7766#	2#	β^-	7690#	450#	210 002500#	430#
130	80		Hg	x	-5370#	200#	7799#	1#	β^-	3880#	200#	209 994240#	210#
129	81		Tl	$+\alpha$	-9247	12	7813.59	0.06	β^-	5482	12	209 990073	12
128	82		Pb		-14728.5	1.4	7835.965	0.007	β^-	63.5	0.5	209 984188.3	1.6
127	83		Bi		-14792.0	1.4	7832.542	0.006	β^-	1161.2	0.8	209 984120.2	1.5
126	84		Po		-15953.1	1.1	7834.346	0.005	*			209 982873.6	1.2
125	85		At	$-\alpha$	-11972	8	7811.66	0.04	β^+	3981	8	209 987147	8
124	86		Rn	$-\alpha$	-9605	5	7796.665	0.022	β^+	2367	9	209 989689	5
123	87		Fr		-3333	15	7763.07	0.07	β^+	6272	16	209 996422	16
122	88		Ra	$-\alpha$	443	9	7741.37	0.04	β^+	3776	18	210 000475	10
121	89		Ac	$-\alpha$	8790	60	7697.90	0.27	β^+	8350	60	210 009440	60
120	90		Th	$-\alpha$	14059	19	7669.08	0.09	β^+	5270	60	210 015093	20
131	80	211	Hg	x	-620#	200#	7778#	1#	β^-	5450#	200#	210 999330#	210#
130	81		Tl	x	-6080	40	7799.79	0.20	β^-	4410	40	210 993480	50
129	82		Pb		-10492.9	2.3	7817.007	0.011	β^-	1366	5	210 988735.4	2.4
128	83		Bi		-11859	5	7819.774	0.026	β^-	573	5	210 987269	6
127	84		Po	$-\alpha$	-12432.6	1.3	7818.784	0.006	*			210 986653.1	1.3
126	85		At	$-\alpha$	-11647.3	2.7	7811.354	0.013	β^+	785.3	2.5	210 987496.1	2.9
125	86		Rn	$-\alpha$	-8755	7	7793.94	0.03	β^+	2892	7	210 990601	7
124	87		Fr		-4140	12	7768.36	0.06	β^+	4615	14	210 995555	13
123	88		Ra	x	832	8	7741.09	0.04	β^+	4972	14	211 000893	9
122	89		Ac	$-\alpha$	7200	50	7707.19	0.25	β^+	6370	50	211 007730	60
121	90		Th	$-\alpha$	13910	70	7671.7	0.3	β^+	6710	90	211 014930	80
120	91		Pa	x	22080#	100#	7629#	0#	β^+	8170#	130#	211 023700#	110#
132	80	212	Hg	x	2760#	300#	7763#	1#	β^-	4310#	360#	212 002960#	320#
131	81		Tl	$+\alpha$	-1550#	200#	7780#	1#	β^-	6000#	200#	211 998340#	220#
130	82		Pb		-7548.8	1.8	7804.319	0.009	β^-	569.1	1.8	211 991896.0	2.0
129	83		Bi		-8118.0	1.9	7803.313	0.009	β^-	2251.5	1.7	211 991285.0	2.0
128	84		Po		-10369.5	1.2	7810.243	0.005	β^-	-1741.3	2.1	211 988867.9	1.2
127	85		At	$-\alpha$	-8628.2	2.4	7798.340	0.011	β^-	31	4	211 990737.2	2.6
126	86		Rn	$-\alpha$	-8660	3	7794.797	0.015	*			211 990704	3
125	87		Fr		-3516	9	7766.84	0.04	β^+	5144	9	211 996225	9
124	88		Ra	$-\alpha$	-199	11	7747.51	0.05	β^+	3317	14	211 999786	12
123	89		Ac	$-\alpha$	7280	50	7708.55	0.24	β^+	7480	50	212 007810	60
122	90		Th	$-\alpha$	12111	10	7682.06	0.05	β^+	4830	50	212 013001	11
121	91		Pa	$-\alpha$	21590	70	7633.6	0.4	β^+	9480	80	212 023180	80

Table I. The 2012 Atomic mass table (continued, Explanation of Table on p. 030003-6)

<i>N</i>	<i>Z</i>	<i>A</i>	Elt.	Orig.	Mass excess (keV)		Binding energy per nucleon (keV)		Beta-decay energy (keV)		Atomic mass μu		
133	80	213	Hg	x	7670#	300#	7741#	1#	β^-	5880#	300#	213 008230#	320#
132	81		Tl	x	1784	27	7765.43	0.13	β^-	4987	28	213 001915	29
131	82		Pb	$+\alpha$	-3204	7	7785.17	0.03	β^-	2028	8	212 996561	7
130	83		Bi		-5232	5	7791.021	0.024	β^-	1422	5	212 994384	5
129	84		Po		-6654	3	7794.024	0.014	*			212 992857	3
128	85		At	$-\alpha$	-6580	5	7790.003	0.023	β^+	74	5	212 992937	5
127	86		Rn	$-\alpha$	-5696	3	7782.182	0.016	β^+	884	6	212 993885	4
126	87		Fr		-3553	5	7768.447	0.024	β^+	2143	6	212 996186	5
125	88		Ra		346	10	7746.47	0.05	β^+	3898	11	213 000371	11
124	89		Ac	$-\alpha$	6155	15	7715.53	0.07	β^+	5809	18	213 006607	16
123	90		Th	$-\alpha$	12120	9	7683.85	0.04	β^+	5965	18	213 013011	10
122	91		Pa	$-\alpha$	19660	70	7644.8	0.3	β^+	7540	70	213 021110	80
134	80	214	Hg	x	11180#	400#	7727#	2#	β^-	4710#	450#	214 012000#	430#
133	81		Tl	x	6470#	200#	7745#	1#	β^-	6650#	200#	214 006940#	210#
132	82		Pb		-182.8	2.0	7772.394	0.009	β^-	1018	11	213 999803.8	2.1
131	83		Bi		-1201	11	7773.49	0.05	β^-	3269	11	213 998711	12
130	84		Po		-4470.0	1.4	7785.116	0.007	β^-	-1090	4	213 995201.2	1.6
129	85		At	$-\alpha$	-3380	4	7776.366	0.020	β^-	940	10	213 996372	5
128	86		Rn	$-\alpha$	-4320	9	7777.10	0.04	*			213 995363	10
127	87		Fr	$-\alpha$	-959	9	7757.74	0.04	β^+	3361	13	213 998971	9
126	88		Ra	$-\alpha$	93	5	7749.171	0.025	β^+	1051	10	214 000100	6
125	89		Ac	$-\alpha$	6444	15	7715.84	0.07	β^+	6351	16	214 006918	16
124	90		Th	$-\alpha$	10695	11	7692.32	0.05	β^+	4251	19	214 011481	11
123	91		Pa	$-\alpha$	19490	80	7647.6	0.4	β^+	8790	80	214 020920	80
135	80	215	Hg	x	16210#	400#	7705#	2#	β^-	6300#	500#	215 017400#	430#
134	81		Tl	x	9910#	300#	7730#	1#	β^-	5570#	300#	215 010640#	320#
133	82		Pb	$+\alpha$	4340	50	7752.74	0.24	β^-	2710	50	215 004660	60
132	83		Bi		1629	6	7761.717	0.026	β^-	2171	6	215 001749	6
131	84		Po		-541.7	2.1	7768.176	0.010	β^-	714	7	214 999418.5	2.3
130	85		At	$-\alpha$	-1256	7	7767.86	0.03	*			214 998652	7
129	86		Rn	$-\alpha$	-1169	8	7763.81	0.04	β^+	87	10	214 998745	8
128	87		Fr	$-\alpha$	318	7	7753.26	0.03	β^+	1487	10	215 000341	8
127	88		Ra	$-\alpha$	2534	8	7739.32	0.04	β^+	2216	10	215 002720	8
126	89		Ac	$-\alpha$	6031	12	7719.41	0.06	β^+	3497	15	215 006474	13
125	90		Th	$-\alpha$	10922	9	7693.03	0.04	β^+	4891	15	215 011725	9
124	91		Pa	$-\alpha$	17860	70	7657.1	0.3	β^+	6940	70	215 019180	80
123	92		U	$-\alpha$	24920	90	7620.6	0.4	β^+	7060	110	215 026760	90
136	80	216	Hg	x	19860#	400#	7690#	2#	β^-	5140#	500#	216 021320#	430#
135	81		Tl	x	14720#	300#	7710#	1#	β^-	7240#	360#	216 015800#	320#
134	82		Pb	x	7480#	200#	7740#	1#	β^-	1610#	200#	216 008030#	210#
133	83		Bi	x	5874	11	7743.50	0.05	β^-	4092	11	216 006306	12
132	84		Po		1782.4	1.8	7758.819	0.008	β^-	-474	4	216 001913.5	1.9
131	85		At	$-\alpha$	2257	4	7753.002	0.017	β^-	2004	7	216 002423	4
130	86		Rn	$-\alpha$	253	6	7758.657	0.028	*			216 000271	6
129	87		Fr	$-\alpha$	2971	4	7742.451	0.019	β^+	2718	7	216 003189	4
128	88		Ra	$-\alpha$	3291	9	7737.35	0.04	β^+	320	10	216 003533	9
127	89		Ac	$-\alpha$	8144	11	7711.26	0.05	β^+	4853	14	216 008743	12
126	90		Th	$-\alpha$	10298	12	7697.66	0.06	β^+	2154	16	216 011056	13
125	91		Pa	$-\alpha$	17800	50	7659.31	0.25	β^+	7500	50	216 019110	60
124	92		U	$-\alpha$	23066	28	7631.31	0.13	β^+	5270	60	216 024760	30

Table I. The 2012 Atomic mass table (continued, Explanation of Table on p. 030003-6)

<i>N</i>	<i>Z</i>	<i>A</i>	Elt.	Orig.	Mass excess (keV)		Binding energy per nucleon (keV)		Beta-decay energy (keV)		Atomic mass μ		
136	81	217	Tl	x	18310#	400#	7695#	2#	β^-	6070#	500#	217 019660#	430#
135	82		Pb	x	12240#	300#	7719#	1#	β^-	3510#	300#	217 013140#	320#
134	83		Bi	x	8730	18	7731.85	0.08	β^-	2846	19	217 009372	19
133	84		Po	$+\alpha$	5884	7	7741.36	0.03	β^-	1489	8	217 006316	7
132	85		At		4395	5	7744.616	0.023	β^-	736	6	217 004718	5
131	86		Rn	$-\alpha$	3659	4	7744.403	0.019	*			217 003928	5
130	87		Fr	$-\alpha$	4315	7	7737.77	0.03	β^+	656	8	217 004632	7
129	88		Ra	$-\alpha$	5890	7	7726.91	0.03	β^+	1575	10	217 006323	8
128	89		Ac	$-\alpha$	8704	11	7710.34	0.05	β^+	2814	13	217 009344	12
127	90		Th	$-\alpha$	12206	11	7690.59	0.05	β^+	3502	16	217 013103	11
126	91		Pa	$-\alpha$	17068	16	7664.58	0.07	β^+	4863	19	217 018324	17
125	92		U	$-\alpha$	22970#	70#	7634#	0#	β^+	5910#	70#	217 024660#	80#
137	81	218	Tl	x	23180#	400#	7674#	2#	β^-	7730#	500#	218 024890#	430#
136	82		Pb	x	15450#	300#	7706#	1#	β^-	2240#	300#	218 016590#	320#
135	83		Bi	x	13216	27	7712.83	0.12	β^-	4859	27	218 014188	29
134	84		Po		8356.9	2.0	7731.528	0.009	β^-	259	12	218 008971.5	2.1
133	85		At	$-\alpha$	8098	12	7729.13	0.05	β^-	2881	12	218 008694	12
132	86		Rn		5217.3	2.3	7738.752	0.011	β^-	-1842	5	218 005601.1	2.5
131	87		Fr	$-\alpha$	7059	5	7726.715	0.022	β^-	408	12	218 007578	5
130	88		Ra	$-\alpha$	6651	11	7725.00	0.05	*			218 007140	12
129	89		Ac	$-\alpha$	10840	50	7702.18	0.23	β^+	4190	50	218 011640	50
128	90		Th	$-\alpha$	12367	11	7691.60	0.05	β^+	1520	50	218 013276	11
127	91		Pa	$-\alpha$	18684	18	7659.04	0.08	β^+	6317	21	218 020058	20
126	92		U	$-\alpha$	21895	14	7640.72	0.06	β^+	3211	23	218 023505	15
137	82	219	Pb	x	20280#	400#	7686#	2#	β^-	4000#	450#	219 021770#	430#
136	83		Bi	x	16280#	200#	7700#	1#	β^-	3600#	200#	219 017480#	210#
135	84		Po	x	12681	16	7713.33	0.07	β^-	2285	16	219 013614	17
134	85		At		10396	3	7720.196	0.015	β^-	1566.7	2.9	219 011161	3
133	86		Rn		8829.4	2.1	7723.777	0.010	β^-	212	7	219 009478.8	2.3
132	87		Fr	$-\alpha$	8618	7	7721.17	0.03	*			219 009252	8
131	88		Ra	$-\alpha$	9394	8	7714.05	0.04	β^+	777	11	219 010085	9
130	89		Ac	$-\alpha$	11570	50	7700.55	0.23	β^+	2180	50	219 012420	50
129	90		Th	$-\alpha$	14470	50	7683.73	0.23	β^+	2900	70	219 015540	50
128	91		Pa	$-\alpha$	18540	50	7661.57	0.24	β^+	4070	70	219 019900	60
127	92		U	$-\alpha$	23290	50	7636.33	0.23	β^+	4750	70	219 025000	50
126	93		Np	$-\alpha$	29460	90	7604.6	0.4	β^+	6170	100	219 031620	90
138	82	220	Pb	x	23670#	400#	7672#	2#	β^-	2850#	500#	220 025410#	430#
137	83		Bi	x	20820#	300#	7682#	1#	β^-	5560#	300#	220 022350#	320#
136	84		Po	x	15263	18	7703.22	0.08	β^-	888	23	220 016386	19
135	85		At	x	14376	14	7703.70	0.06	β^-	3764	14	220 015433	15
134	86		Rn		10612.1	1.8	7717.254	0.008	β^-	-870	4	220 011392.5	1.9
133	87		Fr	$-\alpha$	11482	4	7709.742	0.018	β^-	1212	9	220 012327	4
132	88		Ra	$-\alpha$	10270	8	7711.70	0.04	*			220 011026	9
131	89		Ac	$-\alpha$	13744	6	7692.351	0.028	β^+	3473	10	220 014754	7
130	90		Th	$-\alpha$	14669	22	7684.59	0.10	β^+	925	23	220 015748	24
129	91		Pa	$-\alpha$	20220#	50#	7656#	0#	β^+	5550#	60#	220 021710#	60#
128	92		U	$-\alpha$	22930#	100#	7640#	0#	β^+	2720#	110#	220 024620#	110#
127	93		Np	x	30310#	200#	7603#	1#	β^+	7380#	220#	220 032540#	210#

Table I. The 2012 Atomic mass table (continued, Explanation of Table on p. 030003-6)

<i>N</i>	<i>Z</i>	<i>A</i>	Elt.	Orig.	Mass excess (keV)		Binding energy per nucleon (keV)		Beta-decay energy (keV)		Atomic mass μ u		
138	83	221	Bi	x	24100#	300#	7668#	1#	β^-	4320#	300#	221 025870#	320#
137	84		Po	x	19774	20	7684.48	0.09	β^-	2991	24	221 021228	21
136	85		At	x	16783	14	7694.47	0.06	β^-	2311	15	221 018017	15
135	86		Rn	$+\alpha$	14471	6	7701.393	0.026	β^-	1194	7	221 015536	6
134	87		Fr		13277	5	7703.256	0.022	β^-	313	6	221 014254	5
133	88		Ra	$-\alpha$	12964	5	7701.135	0.021	*			221 013917	5
132	89		Ac	$-\alpha$	14520	50	7690.54	0.23	β^+	1560	50	221 015590	50
131	90		Th	$-\alpha$	16940	8	7676.06	0.04	β^+	2420	50	221 018186	9
130	91		Pa	$-\alpha$	20380	50	7656.97	0.23	β^+	3440	50	221 021870	60
129	92		U	$-\alpha$	24520	50	7634.68	0.23	β^+	4140	70	221 026320	50
128	93		Np	x	29850#	200#	7607#	1#	β^+	5330#	210#	221 032050#	220#
139	83	222	Bi	x	28730#	300#	7649#	1#	β^-	6240#	300#	222 030840#	320#
138	84		Po	x	22490	40	7674.00	0.18	β^-	1530	40	222 024140	40
137	85		At	x	20953	16	7677.39	0.07	β^-	4581	16	222 022494	17
136	86		Rn		16372.2	1.9	7694.497	0.009	β^-	-6	8	222 017576.3	2.1
135	87		Fr	x	16378	7	7690.95	0.03	β^-	2058	9	222 017583	8
134	88		Ra		14320	4	7696.692	0.020	*			222 015373	5
133	89		Ac	$-\alpha$	16621	5	7682.802	0.023	β^+	2301	7	222 017844	6
132	90		Th	$-\alpha$	17203	12	7676.66	0.06	β^+	582	13	222 018468	13
131	91		Pa	$-\alpha$	22160#	70#	7651#	0#	β^+	4950#	70#	222 023780#	80#
130	92		U	$-\alpha$	24270	50	7637.76	0.23	β^+	2120#	90#	222 026060	60
129	93		Np	x	31020#	200#	7604#	1#	β^+	6750#	200#	222 033300#	210#
140	83	223	Bi	x	32140#	400#	7636#	2#	β^-	5060#	450#	223 034500#	430#
139	84		Po	x	27080#	200#	7655#	1#	β^-	3650#	200#	223 029070#	210#
138	85		At	x	23428	14	7668.05	0.06	β^-	3038	16	223 025151	15
137	86		Rn		20390	8	7678.17	0.04	β^-	2007	8	223 021889	8
136	87		Fr		18382.4	1.9	7683.664	0.009	β^-	1149.1	0.8	223 019734.3	2.1
135	88		Ra		17233.3	2.1	7685.309	0.009	*			223 018500.7	2.2
134	89		Ac	$-\alpha$	17826	7	7679.14	0.03	β^+	593	7	223 019137	8
133	90		Th	$-\alpha$	19386	9	7668.64	0.04	β^+	1560	12	223 020812	10
132	91		Pa	$-\alpha$	22320	70	7652.0	0.3	β^+	2930	70	223 023960	80
131	92		U	$-\alpha$	25840	70	7632.7	0.3	β^+	3520	100	223 027740	80
130	93		Np	x	30600#	200#	7608#	1#	β^+	4760#	210#	223 032850#	210#
141	83	224	Bi	x	36830#	400#	7617#	2#	β^-	6920#	450#	224 039540#	430#
140	84		Po	x	29910#	200#	7644#	1#	β^-	2200#	200#	224 032110#	210#
139	85		At	x	27711	22	7650.73	0.10	β^-	5266	24	224 029749	24
138	86		Rn		22445	10	7670.75	0.04	β^-	696	15	224 024096	11
137	87		Fr	x	21749	11	7670.37	0.05	β^-	2923	11	224 023348	12
136	88		Ra		18825.9	1.8	7679.922	0.008	β^-	-1408	4	224 020210.5	1.9
135	89		Ac	$-\alpha$	20234	4	7670.143	0.018	β^-	240	11	224 021722	4
134	90		Th	$-\alpha$	19994	10	7667.72	0.05	*			224 021464	11
133	91		Pa	$-\alpha$	23862	8	7646.96	0.03	β^+	3869	13	224 025617	8
132	92		U	$-\alpha$	25722	23	7635.16	0.10	β^+	1860	24	224 027614	25
131	93		Np	x	31880#	200#	7604#	1#	β^+	6150#	200#	224 034220#	210#
141	84	225	Po	x	34530#	300#	7626#	1#	β^-	4140#	420#	225 037070#	320#
140	85		At	x	30400#	300#	7641#	1#	β^-	3860#	300#	225 032630#	320#
139	86		Rn		26534	11	7654.36	0.05	β^-	2714	16	225 028486	12
138	87		Fr		23821	12	7662.94	0.05	β^-	1828	12	225 025572	13
137	88		Ra		21993.1	2.6	7667.586	0.012	β^-	356	5	225 023610.6	2.8
136	89		Ac		21637	5	7665.690	0.021	*			225 023229	5
135	90		Th	$-\alpha$	22310	5	7659.222	0.023	β^+	673	7	225 023951	5
134	91		Pa	$-\alpha$	24340	70	7646.7	0.3	β^+	2030	70	225 026130	80
133	92		U	$-\alpha$	27380	11	7629.74	0.05	β^+	3040	70	225 029394	12
132	93		Np	$-\alpha$	31590	70	7607.6	0.3	β^+	4210	70	225 033910	80

Table I. The 2012 Atomic mass table (continued, Explanation of Table on p. 030003-6)

<i>N</i>	<i>Z</i>	<i>A</i>	Elt.	Orig.	Mass excess (keV)		Binding energy per nucleon (keV)		Beta-decay energy (keV)		Atomic mass μ		
142	84	226	Po	x	37550#	400#	7614#	2#	β^-	2930#	500#	226 040310#	430#
141	85		At	x	34610#	300#	7624#	1#	β^-	5870#	300#	226 037160#	320#
140	86		Rn		28747	10	7646.41	0.05	β^-	1227	12	226 030861	11
139	87		Fr		27521	6	7648.376	0.028	β^-	3853	7	226 029545	7
138	88		Ra		23667.8	1.9	7661.962	0.009	β^-	-641	3	226 025408.5	2.1
137	89		Ac		24309	3	7655.662	0.014	β^-	1112	5	226 026097	3
136	90		Th		23198	4	7657.119	0.020	*			226 024904	5
135	91		Pa	$-\alpha$	26033	11	7641.11	0.05	β^+	2836	12	226 027948	12
134	92		U	$-\alpha$	27329	13	7631.92	0.06	β^+	1296	17	226 029339	14
133	93		Np	$-\alpha$	32780#	90#	7604#	0#	β^+	5450#	90#	226 035190#	100#
143	84	227	Po	x	42280#	400#	7596#	2#	β^-	4800#	500#	227 045390#	430#
142	85		At	x	37480#	300#	7613#	1#	β^-	4600#	300#	227 040240#	320#
141	86		Rn		32886	14	7630.05	0.06	β^-	3203	15	227 035304	15
140	87		Fr		29682	6	7640.715	0.026	β^-	2505	6	227 031865	6
139	88		Ra	-n	27177.7	2.0	7648.303	0.009	β^-	1328.1	2.3	227 029176.5	2.1
138	89		Ac		25849.6	1.9	7650.707	0.008	β^-	44.8	0.8	227 027750.7	2.1
137	90		Th		25804.8	2.1	7647.458	0.009	*			227 027702.6	2.2
136	91		Pa	$-\alpha$	26831	7	7639.49	0.03	β^+	1026	7	227 028804	8
135	92		U	$-\alpha$	29045	10	7626.29	0.04	β^+	2214	12	227 031182	10
134	93		Np	$-\alpha$	32560	70	7607.4	0.3	β^+	3520	70	227 034960	80
133	94		Pu	x	36770#	100#	7585#	0#	β^+	4210#	120#	227 039470#	110#
143	85	228	At	x	41680#	400#	7597#	2#	β^-	6440#	400#	228 044750#	430#
142	86		Rn		35243	18	7621.64	0.08	β^-	1859	19	228 037835	19
141	87		Fr		33384	7	7626.368	0.030	β^-	4444	7	228 035839	7
140	88		Ra	$+\alpha$	28940.3	2.0	7642.428	0.009	β^-	45.5	0.6	228 031068.7	2.1
139	89		Ac	-	28894.7	2.1	7639.196	0.009	β^-	2123.7	2.6	228 031019.8	2.2
138	90		Th		26771.0	1.8	7645.080	0.008	*			228 028739.8	1.9
137	91		Pa	$-\alpha$	28924	4	7632.207	0.019	β^+	2153	4	228 031051	5
136	92		U	$-\alpha$	29222	14	7627.47	0.06	β^+	299	15	228 031371	15
135	93		Np	$-\alpha$	33600	50	7604.85	0.22	β^+	4370	50	228 036070	50
134	94		Pu	$-\alpha$	36087	29	7590.49	0.13	β^+	2490	60	228 038740	30
144	85	229	At	x	44820#	400#	7585#	2#	β^-	5460#	400#	229 048120#	430#
143	86		Rn	x	39362	13	7605.62	0.06	β^-	3694	14	229 042257	14
142	87		Fr		35668	5	7618.337	0.022	β^-	3106	16	229 038291	5
141	88		Ra	x	32562	15	7628.49	0.07	β^-	1872	20	229 034957	17
140	89		Ac	x	30690	12	7633.24	0.05	β^-	1104	12	229 032947	13
139	90		Th		29585.6	2.4	7634.650	0.011	*			229 031761.4	2.6
138	91		Pa		29897	3	7629.874	0.014	β^+	311	4	229 032096	4
137	92		U	$-\alpha$	31211	6	7620.721	0.026	β^+	1314	7	229 033506	6
136	93		Np	$-\alpha$	33780	90	7606.1	0.4	β^+	2570	90	229 036260	90
135	94		Pu	$-\alpha$	37400	50	7586.88	0.22	β^+	3620	100	229 040150	50
134	95		Am	$-\alpha$	42150	90	7562.7	0.4	β^+	4750	100	229 045250	90
144	86	230	Rn	x	42050#	200#	7596#	1#	β^-	2560#	200#	230 045140#	210#
143	87		Fr		39487	7	7603.704	0.028	β^-	4970	12	230 042391	7
142	88		Ra	x	34516	10	7621.91	0.04	β^-	678	19	230 037055	11
141	89		Ac	x	33838	16	7621.46	0.07	β^-	2976	16	230 036327	17
140	90		Th		30862.6	1.2	7630.996	0.005	β^-	-1311.0	2.8	230 033132.4	1.3
139	91		Pa		32174	3	7621.895	0.013	β^-	559	5	230 034540	3
138	92		U	$-\alpha$	31615	5	7620.922	0.020	*			230 033940	5
137	93		Np	$-\alpha$	35240	50	7601.78	0.22	β^+	3620	50	230 037830	60
136	94		Pu	$-\alpha$	36934	15	7590.99	0.06	β^+	1700	50	230 039651	16
135	95		Am	$-\alpha$	42930#	130#	7562#	1#	β^+	6000#	130#	230 046090#	140#

Table I. The 2012 Atomic mass table (continued, Explanation of Table on p. 030003-6)

<i>N</i>	<i>Z</i>	<i>A</i>	Elt.	Orig.	Mass excess (keV)		Binding energy per nucleon (keV)		Beta-decay energy (keV)		Atomic mass μu		
145	86	231	Rn	x	46450#	300#	7579#	1#	β^-	4370#	300#	231 049870#	320#
144	87		Fr	x	42081	8	7594.50	0.03	β^-	3864	14	231 045175	8
143	88		Ra		38216	11	7607.84	0.05	β^-	2454	17	231 041027	12
142	89		Ac	x	35763	13	7615.08	0.06	β^-	1947	13	231 038393	14
141	90		Th		33815.9	1.2	7620.118	0.005	β^-	391.5	1.5	231 036302.9	1.3
140	91		Pa		33424.4	1.8	7618.426	0.008	*			231 035882.6	1.9
139	92		U	$-\alpha$	33806.0	2.7	7613.387	0.012	β^+	381.6	2.0	231 036292.3	2.9
138	93		Np	$-\alpha$	35620	50	7602.13	0.22	β^+	1820	50	231 038240	50
137	94		Pu	$-\alpha$	38309	23	7587.12	0.10	β^+	2680	60	231 041126	24
136	95		Am	x	42410#	300#	7566#	1#	β^+	4100#	300#	231 045530#	320#
135	96		Cm	x	47270#	300#	7542#	1#	β^+	4860#	420#	231 050750#	320#
145	87	232	Fr	x	46073	14	7579.35	0.06	β^-	5576	17	232 049461	15
144	88		Ra		40497	9	7600.01	0.04	β^-	1343	16	232 043475	10
143	89		Ac	x	39154	13	7602.42	0.06	β^-	3708	13	232 042034	14
142	90		Th		35446.8	1.4	7615.033	0.006	β^-	-500	8	232 038053.7	1.5
141	91		Pa	+	35947	8	7609.51	0.03	β^-	1337	7	232 038590	8
140	92		U		34609.5	1.8	7611.897	0.008	*			232 037154.9	1.9
139	93		Np	-	37360#	100#	7597#	0#	β^+	2750#	100#	232 040110#	110#
138	94		Pu	$-\alpha$	38363	18	7588.97	0.08	β^+	1000#	100#	232 041185	19
137	95		Am	x	43340#	300#	7564#	1#	β^+	4980#	300#	232 046530#	320#
136	96		Cm	$-\alpha$	46310#	200#	7548#	1#	β^+	2970#	360#	232 049720#	220#
146	87	233	Fr	x	48920	20	7569.24	0.08	β^-	4586	21	233 052518	21
145	88		Ra		44334	9	7585.56	0.04	β^-	3026	16	233 047595	9
144	89		Ac	x	41308	13	7595.19	0.06	β^-	2576	13	233 044346	14
143	90		Th		38731.7	1.4	7602.893	0.006	β^-	1242.2	1.1	233 041580.2	1.5
142	91		Pa		37489.5	1.3	7604.866	0.006	β^-	570.3	2.0	233 040246.6	1.4
141	92		U		36919.2	2.3	7603.956	0.010	*			233 039634.4	2.4
140	93		Np	$-\alpha$	37950	50	7596.18	0.22	β^+	1030	50	233 040740	50
139	94		Pu	$-\alpha$	40050	50	7583.80	0.22	β^+	2100	70	233 043000	50
138	95		Am	$-\alpha$	43260#	100#	7567#	0#	β^+	3210#	110#	233 046450#	110#
137	96		Cm	$-\alpha$	47290	70	7546.0	0.3	β^+	4030#	120#	233 050770	80
136	97		Bk	$-\alpha$	52860#	220#	7519#	1#	β^+	5570#	240#	233 056750#	240#
146	88	234	Ra	x	46931	8	7576.54	0.04	β^-	2089	16	234 050382	9
145	89		Ac	x	44841	14	7582.13	0.06	β^-	4228	14	234 048139	15
144	90		Th	$+\alpha$	40613.0	2.6	7596.855	0.011	β^-	274	3	234 043599.9	2.8
143	91		Pa	IT	40339	4	7594.683	0.017	β^-	2194	4	234 043306	4
142	92		U		38145.0	1.1	7600.715	0.005	*			234 040950.4	1.2
141	93		Np	-	39955	8	7589.64	0.04	β^+	1810	8	234 042893	9
140	94		Pu	$-\alpha$	40350	7	7584.605	0.029	β^+	395	11	234 043317	7
139	95		Am	$-\alpha$	44460#	160#	7564#	1#	β^+	4110#	160#	234 047730#	170#
138	96		Cm	$-\alpha$	46725	17	7550.68	0.07	β^+	2260#	160#	234 050161	19
137	97		Bk	$-\alpha$	53460#	140#	7519#	1#	β^+	6730#	140#	234 057390#	150#
147	88	235	Ra	x	51130#	300#	7561#	1#	β^-	3770#	300#	235 054890#	320#
146	89		Ac	x	47357	14	7573.50	0.06	β^-	3339	19	235 050840	15
145	90		Th	x	44018	13	7584.39	0.06	β^-	1729	19	235 047255	14
144	91		Pa	x	42289	14	7588.41	0.06	β^-	1370	14	235 045399	15
143	92		U		40918.8	1.1	7590.914	0.005	*			235 043928.2	1.2
142	93		Np		41043.1	1.4	7587.056	0.006	β^+	124.3	0.9	235 044061.6	1.5
141	94		Pu	$-\alpha$	42182	21	7578.88	0.09	β^+	1139	20	235 045285	22
140	95		Am	$-\alpha$	44630	50	7565.15	0.22	β^+	2440	60	235 047910	60
139	96		Cm	$-\alpha$	48030#	200#	7547#	1#	β^+	3410#	210#	235 051570#	220#
138	97		Bk	x	52700#	400#	7524#	2#	β^+	4670#	450#	235 056580#	430#

Table I. The 2012 Atomic mass table (continued, Explanation of Table on p. 030003-6)

<i>N</i>	<i>Z</i>	<i>A</i>	Elt.	Orig.	Mass excess (keV)		Binding energy per nucleon (keV)		Beta-decay energy (keV)		Atomic mass μ		
150	92	242	U	$+\alpha$	58620#	200#	7532#	1#	β^-	1200#	280#	242 062930#	220#
149	93		Np	+	57420	200	7533.4	0.8	β^-	2700	200	242 061640	210
148	94		Pu		54716.9	1.2	7541.327	0.005	β^-	-751.1	0.7	242 058741.0	1.3
147	95		Am	-n	55468.1	1.1	7534.991	0.005	β^-	664.3	0.4	242 059547.4	1.2
146	96		Cm		54803.8	1.1	7534.503	0.005	*			242 058834.3	1.2
145	97		Bk	-	57730#	200#	7519#	1#	β^+	2930#	200#	242 061980#	220#
144	98		Cf	$-\alpha$	59387	13	7509.10	0.05	β^+	1650#	200#	242 063755	14
143	99		Es	$-\alpha$	64800#	260#	7483#	1#	β^+	5410#	260#	242 069570#	280#
142	100		Fm	x	68400#	400#	7465#	2#	β^+	3600#	480#	242 073430#	430#
151	92	243	U	x	62360#	300#	7518#	1#	β^-	2480#	300#	243 066950#	320#
150	93		Np	IT	59880#	30#	7525#	0#	β^-	2120#	30#	243 064280#	30#
149	94		Pu		57754.6	2.5	7531.008	0.010	β^-	579.6	2.6	243 062002.1	2.7
148	95		Am		57175.0	1.4	7530.173	0.006	*			243 061379.9	1.5
147	96		Cm	$-\alpha$	57182.0	1.5	7526.925	0.006	β^+	7.0	1.6	243 061387.4	1.6
146	97		Bk	$-\alpha$	58690	5	7517.501	0.019	β^+	1508	5	243 063006	5
145	98		Cf	$-\alpha$	60990#	110#	7505#	0#	β^+	2300#	110#	243 065480#	120#
144	99		Es	$-\alpha$	64750#	210#	7486#	1#	β^+	3760#	240#	243 069510#	220#
143	100		Fm	$-\alpha$	69390#	220#	7464#	1#	β^+	4640#	300#	243 074490#	230#
151	93	244	Np	x	63200#	300#	7514#	1#	β^-	3400#	300#	244 067850#	320#
150	94		Pu		59806.0	2.3	7524.815	0.010	β^-	-73.2	2.7	244 064204.4	2.5
149	95		Am	+	59879.2	1.5	7521.308	0.006	β^-	1427.3	1.0	244 064283.0	1.6
148	96		Cm	$-\alpha$	58451.9	1.1	7523.952	0.005	*			244 062750.7	1.2
147	97		Bk	$-\alpha$	60714	14	7511.47	0.06	β^+	2262	14	244 065179	15
146	98		Cf		61478.2	2.6	7505.136	0.011	β^+	764	15	244 065999.5	2.8
145	99		Es	$-\alpha$	66030#	180#	7483#	1#	β^+	4550#	180#	244 070880#	200#
144	100		Fm	$-\alpha$	68970#	200#	7468#	1#	β^+	2940#	270#	244 074040#	220#
152	93	245	Np	x	65890#	300#	7505#	1#	β^-	2710#	300#	245 070740#	320#
151	94		Pu	-n	63178	14	7513.28	0.06	β^-	1278	14	245 067825	15
150	95		Am	$+\alpha$	61900.5	1.9	7515.303	0.008	β^-	895.9	1.5	245 066452.9	2.0
149	96		Cm		61004.6	1.1	7515.767	0.005	*			245 065491.1	1.2
148	97		Bk	$-\alpha$	61813.8	1.8	7509.270	0.007	β^+	809.3	1.5	245 066359.9	1.9
147	98		Cf		63385.2	2.4	7499.663	0.010	β^+	1571.4	2.6	245 068046.8	2.6
146	99		Es	$-\alpha$	66370#	200#	7484#	1#	β^+	2980#	200#	245 071250#	220#
145	100		Fm	$-\alpha$	70190#	200#	7466#	1#	β^+	3820#	280#	245 075350#	210#
144	101		Md	$-\alpha$	75270#	310#	7442#	1#	β^+	5090#	360#	245 080810#	330#
152	94	246	Pu		65395	15	7506.54	0.06	β^-	401#	14#	246 070204	16
151	95		Am	IT	64994#	18#	7505#	0#	β^-	2377#	18#	246 069774#	19#
150	96		Cm		62617.0	1.5	7511.471	0.006	*			246 067222.1	1.6
149	97		Bk	-	63970	60	7502.80	0.24	β^+	1350	60	246 068670	60
148	98		Cf		64090.3	1.5	7499.121	0.006	β^+	120	60	246 068803.8	1.6
147	99		Es	$-\alpha$	67900#	220#	7480#	1#	β^+	3810#	220#	246 072890#	240#
146	100		Fm	$-\alpha$	70189	15	7467.97	0.06	β^+	2290#	220#	246 075351	16
145	101		Md	$-\alpha$	76120#	260#	7441#	1#	β^+	5930#	260#	246 081710#	280#
153	94	247	Pu	x	69110#	200#	7494#	1#	β^-	1950#	220#	247 074190#	210#
152	95		Am	+	67150#	100#	7499#	0#	β^-	1620#	100#	247 072090#	110#
151	96		Cm		65533	4	7501.931	0.015	β^-	44	6	247 070353	4
150	97		Bk	$-\alpha$	65490	5	7498.940	0.021	*			247 070306	6
149	98		Cf	$+\alpha$	66104	15	7493.29	0.06	β^+	614	16	247 070965	16
148	99		Es	$+\alpha$	68578	19	7480.10	0.08	β^+	2474	25	247 073622	21
147	100		Fm	$+\alpha$	71670#	120#	7464#	0#	β^+	3090#	120#	247 076940#	120#
146	101		Md	$-\alpha$	75940#	210#	7444#	1#	β^+	4260#	240#	247 081520#	220#

Table I. The 2012 Atomic mass table (continued, Explanation of Table on p. 030003-6)

<i>N</i>	<i>Z</i>	<i>A</i>	Elt.	Orig.	Mass excess (keV)		Binding energy per nucleon (keV)		Beta-decay energy (keV)		Atomic mass μ		
153	95	248	Am	+	70560#	200#	7487#	1#	β^-	3170#	200#	248 075750#	220#
152	96		Cm		67392.8	2.4	7496.728	0.010	β^-	-690#	70#	248 072349.1	2.5
151	97		Bk	IT	68080#	70#	7491#	0#	β^-	840#	70#	248 073090#	80#
150	98		Cf	$-\alpha$	67238	5	7491.043	0.021	*			248 072183	5
149	99		Es	$-\alpha$	70300#	50#	7476#	0#	β^+	3060#	50#	248 075470#	60#
148	100		Fm		71898	8	7465.94	0.03	β^+	1600#	50#	248 077186	9
147	101		Md	$-\alpha$	77150#	240#	7442#	1#	β^+	5250#	240#	248 082820#	260#
146	102		No	$-\alpha$	80620#	220#	7424#	1#	β^+	3470#	330#	248 086550#	240#
154	95	249	Am	x	73100#	300#	7479#	1#	β^-	2350#	300#	249 078480#	320#
153	96		Cm	-n	70750.7	2.4	7485.550	0.010	β^-	904.3	2.6	249 075954.0	2.5
152	97		Bk	+	69846.4	1.2	7486.040	0.005	β^-	123.6	0.4	249 074983.2	1.3
151	98		Cf		69722.8	1.2	7483.394	0.005	*			249 074850.5	1.3
150	99		Es	$-\alpha$	71180#	30#	7474#	0#	β^+	1450#	30#	249 076410#	30#
149	100		Fm		73519	6	7461.864	0.025	β^+	2340#	30#	249 078926	7
148	101		Md	$-\alpha$	77230#	200#	7444#	1#	β^+	3710#	200#	249 082910#	220#
147	102		No	$-\alpha$	81780#	280#	7422#	1#	β^+	4550#	340#	249 087800#	300#
154	96	250	Cm	-nn	72990	10	7478.94	0.04	β^-	40	11	250 078358	11
153	97		Bk	$+\alpha$	72950	4	7475.967	0.015	β^-	1780	3	250 078315	4
152	98		Cf	$-\alpha$	71170.4	1.5	7479.956	0.006	*			250 076404.6	1.7
151	99		Es	-	73230#	100#	7469#	0#	β^+	2060#	100#	250 078610#	110#
150	100		Fm		74072	8	7462.09	0.03	β^+	850#	100#	250 079520	8
149	101		Md	$-\alpha$	78630#	300#	7441#	1#	β^+	4560#	300#	250 084410#	320#
148	102		No	$-\alpha$	81560#	200#	7426#	1#	β^+	2930#	360#	250 087560#	220#
155	96	251	Cm	+	76648	23	7466.72	0.09	β^-	1420	20	251 082285	24
154	97		Bk	+	75228	11	7469.26	0.04	β^-	1093	10	251 080761	12
153	98		Cf	$-\alpha$	74135	4	7470.500	0.016	*			251 079587	4
152	99		Es	$-\alpha$	74512	6	7465.881	0.024	β^+	377	7	251 079992	6
151	100		Fm	$+\alpha$	75954	15	7457.02	0.06	β^+	1442	16	251 081540	16
150	101		Md	$+\alpha$	78967	19	7441.90	0.08	β^+	3013	24	251 084774	20
149	102		No	IT	82850#	110#	7423#	0#	β^+	3880#	120#	251 088940#	120#
148	103		Lr	x	87730#	300#	7401#	1#	β^+	4880#	320#	251 094180#	320#
156	96	252	Cm	x	79060#	300#	7460#	1#	β^-	520#	360#	252 084870#	320#
155	97		Bk	+	78540#	200#	7459#	1#	β^-	2500#	200#	252 084310#	220#
154	98		Cf	$-\alpha$	76034.6	2.4	7465.347	0.009	β^-	-1260	50	252 081626.5	2.5
153	99		Es	-	77290	50	7457.24	0.20	β^-	480	50	252 082980	50
152	100		Fm	$-\alpha$	76816	5	7456.038	0.022	*			252 082465	6
151	101		Md	IT	80510#	130#	7438#	1#	β^+	3700#	130#	252 086430#	140#
150	102		No		82871	9	7425.80	0.04	β^+	2360#	130#	252 088966	10
149	103		Lr	$-\alpha$	88740#	240#	7399#	1#	β^+	5870#	240#	252 095260#	260#
156	97	253	Bk	$-\alpha$	80930#	360#	7451#	1#	β^-	1630#	360#	253 086880#	390#
155	98		Cf	$-\alpha$	79302	4	7454.829	0.017	β^-	291	4	253 085134	5
154	99		Es	$-\alpha$	79010.5	1.2	7452.887	0.005	*			253 084821.3	1.3
153	100		Fm	$-\alpha$	79345.7	2.9	7448.470	0.012	β^+	335.2	2.7	253 085181	3
152	101		Md	$-\alpha$	81170#	30#	7438#	0#	β^+	1830#	30#	253 087140#	30#
151	102		No		84359	7	7422.471	0.027	β^+	3190#	30#	253 090563	7
150	103		Lr	$-\alpha$	88580#	200#	7403#	1#	β^+	4220#	200#	253 095090#	220#
149	104		Rf	$-\alpha$	93560#	410#	7380#	2#	β^+	4980#	460#	253 100440#	440#
157	97	254	Bk	x	84390#	300#	7440#	1#	β^-	3050#	300#	254 090600#	320#
156	98		Cf	$-\alpha$	81341	11	7449.23	0.05	β^-	-649	12	254 087324	12
155	99		Es	$-\alpha$	81991	4	7443.589	0.016	β^-	1088	3	254 088021	4
154	100		Fm	$-\alpha$	80902.8	2.4	7444.792	0.010	*			254 086852.7	2.6
153	101		Md	-	83450#	100#	7432#	0#	β^+	2550#	100#	254 089590#	110#
152	102		No		84723	10	7423.59	0.04	β^+	1270#	100#	254 090954	10
151	103		Lr	$-\alpha$	89870#	300#	7400#	1#	β^+	5150#	300#	254 096480#	320#
150	104		Rf	$-\alpha$	93200#	280#	7384#	1#	β^+	3330#	410#	254 100050#	300#

Table I. The 2012 Atomic mass table (continued, Explanation of Table on p. 030003-6)

N	Z	A	Elt.	Orig.	Mass excess (keV)		Binding energy per nucleon (keV)		Beta-decay energy (keV)		Atomic mass μu		
157	98	255	Cf	+	84810#	200#	7438#	1#	β^-	720#	200#	255 091050#	220#
156	99		Es	$-\alpha$	84089	11	7437.82	0.04	β^-	290	10	255 090274	12
155	100		Fm	$-\alpha$	83800	4	7435.888	0.017	*			255 089963	5
154	101		Md	$-\alpha$	84843	7	7428.729	0.026	β^+	1043	8	255 091083	7
153	102		No	x	86807	15	7417.96	0.06	β^+	1964	16	255 093191	16
152	103		Lr	x	89947	18	7402.58	0.07	β^+	3140	23	255 096562	19
151	104		Rf	$-\alpha$	94330#	120#	7382#	0#	β^+	4380#	120#	255 101270#	120#
150	105		Db	$-\alpha$	99590#	360#	7359#	1#	β^+	5260#	380#	255 106920#	390#
158	98	256	Cf	$-\alpha$	87040#	310#	7432#	1#	β^-	-150#	330#	256 093440#	340#
157	99		Es	+	87190#	100#	7428#	0#	β^-	1700#	100#	256 093600#	110#
156	100		Fm	$-\alpha$	85487	6	7431.780	0.022	*			256 091774	6
155	101		Md	IT	87460#	120#	7421#	0#	β^+	1970#	120#	256 093890#	130#
154	102		No	$-\alpha$	87822	8	7416.55	0.03	β^+	370#	120#	256 094281	8
153	103		Lr	x	91750	80	7398.2	0.3	β^+	3920	80	256 098490	90
152	104		Rf	$-\alpha$	94222	18	7385.43	0.07	β^+	2480	80	256 101152	19
151	105		Db	$-\alpha$	100500#	240#	7358#	1#	β^+	6280#	240#	256 107890#	260#
158	99	257	Es	$-\alpha$	89400#	410#	7422#	2#	β^-	810#	410#	257 095980#	440#
157	100		Fm	$-\alpha$	88590	4	7422.194	0.017	*			257 095105	5
156	101		Md	$-\alpha$	88993.1	1.6	7417.582	0.006	β^+	403	5	257 095538.0	1.7
155	102		No	$-\alpha$	90247	7	7409.657	0.026	β^+	1254	7	257 096884	7
154	103		Lr	$-\alpha$	92670#	40#	7397#	0#	β^+	2420#	50#	257 099480#	50#
153	104		Rf	$-\alpha$	95866	11	7381.70	0.04	β^+	3200#	50#	257 102917	12
152	105		Db	$-\alpha$	100210#	200#	7362#	1#	β^+	4340#	200#	257 107580#	220#
159	99	258	Es	x	92700#	400#	7412#	2#	β^-	2280#	450#	258 099520#	430#
158	100		Fm	$-\alpha$	90430#	200#	7418#	1#	β^-	-1260#	200#	258 097080#	220#
157	101		Md	$-\alpha$	91687	4	7409.675	0.017	β^-	210#	100#	258 098430	5
156	102		No	$-\alpha$	91480#	100#	7407#	0#	*			258 098210#	110#
155	103		Lr	$-\alpha$	94780#	100#	7392#	0#	β^+	3300#	140#	258 101750#	110#
154	104		Rf	$-\alpha$	96340	30	7382.54	0.12	β^+	1560#	110#	258 103430	30
153	105		Db	$-\alpha$	101800#	310#	7358#	1#	β^+	5460#	310#	258 109280#	330#
152	106		Sg	$-\alpha$	105240#	410#	7342#	2#	β^+	3450#	510#	258 112980#	440#
159	100	259	Fm	$-\alpha$	93700#	280#	7407#	1#	β^-	80#	350#	259 100600#	300#
158	101		Md	$-\alpha$	93620#	200#	7405#	1#	*			259 100510#	220#
157	102		No	$-\alpha$	94079	7	7399.974	0.025	β^+	450#	200#	259 100998	7
156	103		Lr	$-\alpha$	95850#	70#	7390#	0#	β^+	1770#	70#	259 102900#	80#
155	104		Rf	$-\alpha$	98360#	70#	7377#	0#	β^+	2510#	100#	259 105600#	80#
154	105		Db	$-\alpha$	101990	50	7360.36	0.20	β^+	3630#	90#	259 109490	60
153	106		Sg	$-\alpha$	106520#	120#	7340#	0#	β^+	4530#	130#	259 114350#	120#
160	100	260	Fm	$-\alpha$	95770#	440#	7402#	2#	β^-	-790#	540#	260 102810#	470#
159	101		Md	$-\alpha$	96550#	320#	7396#	1#	β^-	940#	370#	260 103650#	340#
158	102		No	$-\alpha$	95610#	200#	7397#	1#	*			260 102640#	220#
157	103		Lr	$-\alpha$	98280#	120#	7383#	0#	β^+	2670#	240#	260 105500#	130#
156	104		Rf	$-\alpha$	99150#	200#	7377#	1#	β^+	870#	240#	260 106440#	220#
155	105		Db	$-\alpha$	103670#	90#	7357#	0#	β^+	4530#	220#	260 111300#	100#
154	106		Sg	$-\alpha$	106548	21	7342.56	0.08	β^+	2880#	100#	260 114384	22
153	107		Bh	$-\alpha$	113320#	250#	7313#	1#	β^+	6780#	250#	260 121660#	260#
160	101	261	Md	$-\alpha$	98580#	510#	7391#	2#	β^-	120#	550#	261 105830#	550#
159	102		No	$-\alpha$	98460#	200#	7388#	1#	*			261 105700#	220#
158	103		Lr	$-\alpha$	99560#	200#	7381#	1#	β^+	1100#	280#	261 106880#	220#
157	104		Rf	$-\alpha$	101320	50	7371.38	0.19	β^+	1760#	210#	261 108770	50
156	105		Db	$-\alpha$	104310#	110#	7357#	0#	β^+	2990#	120#	261 111980#	120#
155	106		Sg	$-\alpha$	108005	18	7339.77	0.07	β^+	3700#	110#	261 115948	20
154	107		Bh	$-\alpha$	113130#	210#	7317#	1#	β^+	5130#	210#	261 121450#	220#

Table I. The 2012 Atomic mass table (continued, Explanation of Table on p. 030003-6)

<i>N</i>	<i>Z</i>	<i>A</i>	Elt.	Orig.	Mass excess (keV)		Binding energy per nucleon (keV)		Beta-decay energy (keV)		Atomic mass μ u		
165	105	270	Db	$-\alpha$	122310#	620#	7314#	2#	β^-	820#	830#	270 131300#	660#
164	106		Sg	$-\alpha$	121490#	560#	7314#	2#	*			270 130430#	600#
163	107		Bh	$-\alpha$	124230#	290#	7301#	1#	β^+	2740#	630#	270 133360#	310#
162	108		Hs	$-\alpha$	125110#	250#	7295#	1#	β^+	890#	380#	270 134310#	270#
161	109		Mt	$-\alpha$	130710#	170#	7271#	1#	β^+	5600#	300#	270 140320#	180#
160	110		Ds	$-\alpha$	134680	50	7253.77	0.18	β^+	3970#	180#	270 144580	50
165	106	271	Sg	$-\alpha$	124760#	590#	7305#	2#	*			271 133930#	630#
164	107		Bh	$-\alpha$	125920#	420#	7298#	2#	β^+	1160#	720#	271 135180#	450#
163	108		Hs	$-\alpha$	127740#	280#	7288#	1#	β^+	1820#	500#	271 137140#	300#
162	109		Mt	$-\alpha$	131100#	330#	7273#	1#	β^+	3360#	430#	271 140740#	350#
161	110		Ds	$-\alpha$	135950#	100#	7252#	0#	β^+	4850#	340#	271 145950#	100#
166	106	272	Sg	$-\alpha$	126580#	730#	7301#	3#	*			272 135890#	780#
165	107		Bh	$-\alpha$	128790#	530#	7290#	2#	β^+	2210#	900#	272 138260#	570#
164	108		Hs	$-\alpha$	129010#	510#	7286#	2#	β^+	220#	740#	272 138490#	550#
163	109		Mt	$-\alpha$	133580#	490#	7267#	2#	β^+	4580#	700#	272 143410#	520#
162	110		Ds	$-\alpha$	136020#	410#	7255#	2#	β^+	2430#	640#	272 146020#	440#
161	111		Rg	$-\alpha$	142770#	230#	7227#	1#	β^+	6760#	470#	272 153270#	250#
167	106	273	Sg	x	130020#	500#	7291#	2#	*			273 139580#	540#
166	107		Bh	$-\alpha$	130630#	690#	7286#	3#	β^+	620#	860#	273 140240#	740#
165	108		Hs	$-\alpha$	131890#	370#	7279#	1#	β^+	1260#	780#	273 141590#	390#
164	109		Mt	$-\alpha$	134710#	420#	7265#	2#	β^+	2820#	560#	273 144620#	460#
163	110		Ds	$-\alpha$	138360#	130#	7249#	0#	β^+	3640#	450#	273 148530#	140#
162	111		Rg	$-\alpha$	142700#	530#	7231#	2#	β^+	4340#	540#	273 153190#	570#
167	107	274	Bh	$-\alpha$	133680#	620#	7278#	2#	β^-	200#	860#	274 143510#	660#
166	108		Hs	$-\alpha$	133490#	590#	7276#	2#	*			274 143300#	640#
165	109		Mt	$-\alpha$	137250#	350#	7259#	1#	β^+	3760#	690#	274 147340#	380#
164	110		Ds	$-\alpha$	139200#	390#	7249#	1#	β^+	1950#	530#	274 149430#	420#
163	111		Rg	$-\alpha$	144610#	180#	7227#	1#	β^+	5420#	430#	274 155250#	190#
168	107	275	Bh	x	135690#	600#	7273#	2#	*			275 145670#	640#
167	108		Hs	$-\alpha$	136620#	590#	7267#	2#	β^+	930#	840#	275 146670#	630#
166	109		Mt	$-\alpha$	138830#	420#	7256#	2#	β^+	2210#	720#	275 149040#	450#
165	110		Ds	$-\alpha$	141570#	410#	7244#	1#	β^+	2740#	590#	275 151980#	440#
164	111		Rg	$-\alpha$	145300#	520#	7227#	2#	β^+	3730#	660#	275 155980#	560#
168	108	276	Hs	$-\alpha$	138290#	750#	7264#	3#	*			276 148460#	810#
167	109		Mt	$-\alpha$	141320#	530#	7250#	2#	β^+	3030#	920#	276 151710#	570#
166	110		Ds	$-\alpha$	142540#	550#	7243#	2#	β^+	1230#	760#	276 153020#	590#
165	111		Rg	$-\alpha$	147490#	630#	7222#	2#	β^+	4950#	830#	276 158330#	680#
164	112		Cn	x	150350#	600#	7209#	2#	β^+	2870#	870#	276 161410#	640#
169	108	277	Hs	$-\alpha$	141490#	540#	7255#	2#	*			277 151900#	580#
168	109		Mt	$-\alpha$	142970#	700#	7247#	3#	β^+	1480#	880#	277 153480#	750#
167	110		Ds	$-\alpha$	145140#	380#	7237#	1#	β^+	2170#	800#	277 155820#	410#
166	111		Rg	$-\alpha$	148340#	520#	7222#	2#	β^+	3200#	650#	277 159250#	560#
165	112		Cn	$-\alpha$	152400#	140#	7205#	1#	β^+	4070#	540#	277 163610#	150#
169	109	278	Mt	$-\alpha$	145740#	620#	7240#	2#	*			278 156450#	670#
168	110		Ds	$-\alpha$	146380#	630#	7235#	2#	β^+	650#	880#	278 157150#	670#
167	111		Rg	$-\alpha$	150520#	360#	7218#	1#	β^+	4140#	720#	278 161590#	380#
166	112		Cn	$-\alpha$	152930#	440#	7206#	2#	β^+	2420#	570#	278 164180#	470#
165	113		Ed	$-\alpha$	158890#	180#	7182#	1#	β^+	5960#	480#	278 170570#	200#
170	109	279	Mt	$-\alpha$	147500#	670#	7237#	2#	*			279 158340#	720#
169	110		Ds	$-\alpha$	149130#	600#	7228#	2#	β^+	1630#	900#	279 160090#	640#
168	111		Rg	$-\alpha$	151780#	420#	7216#	2#	β^+	2650#	730#	279 162940#	450#
167	112		Cn	$-\alpha$	155030#	460#	7202#	2#	β^+	3260#	620#	279 166430#	490#
166	113		Ed	x	159240#	700#	7184#	3#	β^+	4210#	840#	279 170950#	750#

Table I. The 2012 Atomic mass table (continued, Explanation of Table on p. 030003-6)

N	Z	A	Elt.	Orig.	Mass excess (keV)		Binding energy per nucleon (keV)		Beta-decay energy (keV)		Atomic mass μu	
170	110	280	Ds	$-\alpha$	150520#	780#	7226#	3#	*		280 161590#	840#
169	111		Rg	$-\alpha$	153890#	530#	7212#	2#	β^+	3370# 940#	280 165200#	570#
168	112		Cn	$-\alpha$	155700#	580#	7202#	2#	β^+	1810# 790#	280 167150#	630#
167	113		Ed	x	161140#	400#	7180#	1#	β^+	5440# 710#	280 172990#	430#
171	110	281	Ds	$-\alpha$	153430#	580#	7219#	2#	*		281 164720#	620#
170	111		Rg	$-\alpha$	155300#	810#	7210#	3#	β^+	1870# 990#	281 166720#	870#
169	112		Cn	$-\alpha$	158020#	390#	7197#	1#	β^+	2720# 890#	281 169640#	420#
168	113		Ed	x	161810#	300#	7181#	1#	β^+	3790# 490#	281 173710#	320#
171	111	282	Rg	$-\alpha$	157800#	650#	7204#	2#	*		282 169410#	700#
170	112		Cn	$-\alpha$	158980#	660#	7197#	2#	β^+	1180# 930#	282 170670#	700#
169	113		Ed	$-\alpha$	163730#	360#	7177#	1#	β^+	4750# 750#	282 175770#	390#
172	111	283	Rg	$-\alpha$	159280#	700#	7202#	2#	*		283 171000#	750#
171	112		Cn	$-\alpha$	161490#	610#	7191#	2#	β^+	2210# 930#	283 173360#	650#
170	113		Ed	$-\alpha$	164710#	440#	7177#	2#	β^+	3220# 750#	283 176820#	470#
172	112	284	Cn	$-\alpha$	162550#	810#	7190#	3#	*		284 174500#	870#
171	113		Ed	$-\alpha$	166590#	530#	7173#	2#	β^+	4050# 970#	284 178840#	570#
170	114		Fl	$-\alpha$	168920#	660#	7162#	2#	β^+	2330# 850#	284 181340#	700#
173	112	285	Cn	$-\alpha$	165170#	580#	7184#	2#	*		285 177320#	620#
172	113		Ed	$-\alpha$	167730#	810#	7173#	3#	β^+	2560# 1000#	285 180070#	870#
171	114		Fl	$-\alpha$	171000#	390#	7158#	1#	β^+	3270# 900#	285 183580#	420#
173	113	286	Ed	$-\alpha$	170010#	660#	7168#	2#	*		286 182520#	700#
172	114		Fl	$-\alpha$	171770#	660#	7159#	2#	β^+	1760# 930#	286 184410#	710#
174	113	287	Ed	$-\alpha$	171250#	730#	7167#	3#	*		287 183840#	780#
173	114		Fl	$-\alpha$	174070#	610#	7154#	2#	β^+	2830# 950#	287 186880#	660#
172	115		Ef	$-\alpha$	177900#	440#	7138#	2#	β^+	3820# 750#	287 190980#	470#
174	114	288	Fl	$-\alpha$	175040#	810#	7154#	3#	*		288 187920#	870#
173	115		Ef	$-\alpha$	179770#	540#	7135#	2#	β^+	4730# 970#	288 192990#	580#
175	114	289	Fl	$-\alpha$	177560#	580#	7148#	2#	*		289 190620#	630#
174	115		Ef	$-\alpha$	180670#	810#	7135#	3#	β^+	3100# 1000#	289 193950#	870#
173	116		Lv	$-\alpha$	184530#	490#	7119#	2#	β^+	3860# 950#	289 198100#	530#
175	115	290	Ef	$-\alpha$	182890#	660#	7130#	2#	*		290 196350#	710#
174	116		Lv	$-\alpha$	185200#	660#	7120#	2#	β^+	2300# 930#	290 198820#	710#
176	115	291	Ef	$-\alpha$	183990#	780#	7130#	3#	*		291 197520#	840#
175	116		Lv	$-\alpha$	187390#	610#	7116#	2#	β^+	3400# 1000#	291 201170#	660#
174	117		Eh	$-\alpha$	191800#	590#	7098#	2#	β^+	4410# 850#	291 205910#	640#
176	116	292	Lv	$-\alpha$	188240#	810#	7116#	3#	*		292 202090#	870#
175	117		Eh	$-\alpha$	193580#	670#	7095#	2#	β^+	5330# 1050#	292 207810#	720#
177	116	293	Lv	$-\alpha$	190670#	590#	7111#	2#	*		293 204690#	630#
176	117		Eh	$-\alpha$	194390#	810#	7095#	3#	β^+	3720# 1000#	293 208680#	870#
175	118		Ei	$-\alpha$	198870#	700#	7077#	2#	β^+	4490# 1070#	293 213500#	750#
177	117	294	Eh	$-\alpha$	196520#	660#	7092#	2#	*		294 210970#	710#
176	118		Ei	$-\alpha$	199460#	660#	7079#	2#	β^+	2940# 940#	294 214130#	710#
177	118	295	Ei	$-\alpha$	201510#	640#	7075#	2#	*		295 216330#	690#

Table II. Influences on primary nuclides

EXPLANATION OF TABLE

This table gives for each of the 1207 primary nuclides the up to three most important contributing data and their *influences* ($\times 100$) on its mass, as given by the flow-of-information matrix.

Nuclide	Nuclidic name (primaries only)			
Influence	<i>Influence</i> ($\times 100$) brought to the determination of the mass of the nuclide, by the piece of data represented by the equation in following column			
Equation	$K^m, Cs^m, Cs^n,$ $In^p, Tl^q:$ higher isomers, see NUBASE.	In nuclear reactions: ϵ = electron capture,	In mass-doublet equation: $H = ^1H,$ $N = ^{14}N,$ $D = ^2H,$ $O = ^{16}O,$ $C = ^{12}C,$ u = absolute mass-doublet.	In mass-triplet equation: $Rb^x, Rb^y:$ different mixtures of isomers or contaminants.

Nuclide	Infl.	Equation	Infl.	Equation	Infl.	Equation
$0\pi^+$	100.0	π^+				
$0\pi^-$	99.6	$\pi^+(2\beta^+)\pi^-$				
1 n	100.0	$^1H(n,\gamma)^2H$				
1H	43.8	$H_{12}-C$	24.4	H_2-D	16.5	$C_2H_4-^{28}Si$
2H	78.0	D_6-C	7.8	H_2-D	3.2	$CD_3-^{18}O$
3H	100.0	$^3H-^3He$				
3He	100.0	^3He-HD				
4He	100.0	$^4He_3-C$				
6He	100.0	$^6He-^7Li_{1.857}$				
6Li	100.0	$^6Li_2-C$				
7Li	99.8	$^7Li-H_7$	0.1	$^7Li(n,\gamma)^8Li$	0.1	$^8He-^7Li_{1.143}$
$^7Li^i$	61.0	$^9Be(p,^3He)^7Li^i$	39.0	$^6Li(n,\gamma)^7Li^i$		
7Be	100.0	$^7Li(p,n)^7Be$				
8He	74.9	$^8He-^7Li_{1.143}$	25.1	$^8He-^6Li_{1.333}$		
8Li	78.7	$^7Li(n,\gamma)^8Li$	21.3	$^8Li-^6Li_{1.333}$		
$^8Be^j$	57.1	$^{10}Be(p,t)^8Be^j$	42.9	$^6Li(d,\gamma)^8Be^j$		
8B	100.0	$^6Li(^3He,n)^8B$				
8C	62.5	$^{12}C(\alpha,^8He)^8C$	37.5	^8C-u		
9He	56.2	$^9He(\gamma,n)^8He$	43.8	$^9Be(\pi^-, \pi^+)^9He$		
9Be	67.1	$^9Be-^7Li_{1.286}$	32.9	$^9Be(n,\gamma)^{10}Be$		
^{10}Be	55.6	$^9Be(n,\gamma)^{10}Be$	44.4	$^{10}Be-^7Li_{1.429}$		
^{10}B	100.0	$^{10}B-u$				
^{10}C	67.2	$^{10}C-^{10}B$	32.8	$^{10}B(p,n)^{10}C$		
^{11}Be	83.1	$^{11}Be-^6Li_{1.833}$	16.9	$^{11}Be-^7Li_{1.571}$		
^{11}B	100.0	$^{11}B-u$				
$^{11}B^i$	79.1	$^9Be(^3He,p)^{11}B^i$	20.9	$^7Li(\alpha,\gamma)^{11}B^i$		
^{11}C	100.0	$^{11}C-^{14}N_{786}$				
$^{11}C^i$	50.0	$^{11}B(^3He,t)^{11}C^i$	50.0	$^9Be(^3He,n)^{11}C^i$		
^{12}Be	79.4	$^{12}Be-C$	20.6	$^{10}Be(t,p)^{12}Be$		
^{12}B	89.1	$^{14}C(d,\alpha)^{12}B$	10.9	$^{11}B(d,p)^{12}B$		
$^{12}B^i$	86.3	$^{14}C(p,^3He)^{12}B^i$	13.7	$^9Be(^7Li,\alpha)^{12}B^i$		
$^{12}C^i$	69.2	$^{11}B(d,n)^{12}C^i$	30.8	$^{10}B(^3He,p)^{12}C^i$		

Table II. Influences on primary nuclides (continued, Explanation of Table on page 030003-74)

Nuclide	Infl.	Equation	Infl.	Equation	Infl.	Equation
¹² N	100.0	¹⁴ N(p,t) ¹² N				
¹³ C	78.6	¹³ C H- ¹⁴ N	20.8	¹³ C ₂ H ₂ - ²⁸ Si	0.5	¹³ C D ₃ - ¹⁹ F
¹³ N	100.0	¹² C(p,γ) ¹³ N				
¹⁴ B	100.0	¹⁴ C(⁷ Li, ⁷ Be) ¹⁴ B				
¹⁴ C	80.0	¹⁴ C H ₂ -N D	20.0	C D ₂ - ¹⁴ C H ₂		
¹⁴ N	81.3	N ₂ -C O	15.5	¹³ C H- ¹⁴ N	1.2	⁸⁶ Kr-N ₆
¹⁴ O	100.0	¹⁴ O- ¹⁴ N				
¹⁵ B	88.4	¹⁸ O(⁴⁸ Ca, ⁵¹ V) ¹⁵ B	11.6	¹⁶ B(γ,n) ¹⁵ B		
¹⁵ N	60.9	C D H- ¹⁵ N	26.2	¹⁵ N ₂ - ²⁸ Si H ₂	13.0	C H ₃ - ¹⁵ N
¹⁵ O	70.3	¹⁵ N(p,n) ¹⁵ O	29.7	¹⁴ N(p,γ) ¹⁵ O		
¹⁶ B	83.2	¹⁶ B(γ,n) ¹⁵ B	16.8	¹⁴ C(¹⁴ C, ¹² N) ¹⁶ B		
¹⁶ O	92.8	C ₄ -O ₃	3.5	O ₂ - ³¹ P H	1.4	³² S-O ₂
¹⁶ O ⁱ	54.4	¹⁴ N(³ He,p) ¹⁶ O ⁱ	45.6	¹⁵ N(p,γ) ¹⁶ O ⁱ		
¹⁶ O ^j	77.0	¹⁴ N(d,γ) ¹⁶ O ^j	23.0	¹⁴ C(³ He,n) ¹⁶ O ^j		
¹⁷ O	81.7	¹⁷ O ₂ - ²⁸ Si D ₃	18.3	¹⁷ O- ¹⁶ O H		
¹⁷ F	100.0	¹⁶ O(p,γ) ¹⁷ F				
¹⁷ Ne	100.0	¹⁷ Ne- ²² Ne. ₇₇₃				
¹⁸ O	84.1	C D ₃ - ¹⁸ O	15.9	C ₃ - ¹⁸ O ₂		
¹⁸ F	59.6	¹⁷ O(p,γ) ¹⁸ F	40.4	¹⁸ O(p,n) ¹⁸ F		
¹⁸ Ne	99.9	¹⁸ Ne- ²² Ne. ₈₁₈	0.1	²² Mg ⁱ (α) ¹⁸ Ne		
¹⁸ Na	69.7	¹⁸ Na(p) ¹⁷ Ne	30.3	¹⁸ Na-u		
¹⁹ F	84.5	¹³ C D ₃ - ¹⁹ F	15.5	²⁸ Si H ₃ -C ¹⁹ F		
¹⁹ Na	77.1	²⁴ Mg(³ He, ⁸ Li) ¹⁹ Na	22.9	¹⁹ Na(p) ¹⁸ Ne		
²⁰ Ne	60.5	²⁰ Ne ₂ - ⁴⁰ Ar	39.5	C D ₄ - ²⁰ Ne		
²⁰ Na	100.0	²⁰ Ne(³ He,t) ²⁰ Na- ³⁶ Ar() ³⁶ K				
²¹ Ne	100.0	²⁰ Ne(n,γ) ²¹ Ne				
²¹ Na	100.0	²¹ Na- ²¹ Ne				
²² Ne	98.9	²² Ne-u	0.5	⁴⁶ Ti- ²² Ne _{2.091}	0.3	⁴⁶ V- ²² Ne _{2.091}
²² Na	30.8	²² Na- ²² Ne	17.8	²² Na- ²³ Na. ₉₅₇	16.6	²² Na- ³⁹ K. ₅₆₄
²² Mg	40.9	²² Mg- ³⁹ K. ₅₆₄	38.0	²² Mg- ²² Na	21.1	²² Mg- ²² Ne
²² Mg ⁱ	60.1	²² Mg ⁱ (α) ¹⁸ Ne	22.8	²² Mg ⁱ (2p) ²⁰ Ne	17.1	²² Mg ⁱ (p) ²¹ Na
²³ F	86.3	²³ F-u	13.7	²² Ne(¹⁸ O, ¹⁷ F) ²³ F		
²³ Na	100.0	²³ Na-u				
²⁴ Mg	98.1	²⁴ Mg-H ₂₄	1.9	²⁴ Mg(n,γ) ²⁵ Mg	0.1	²² Na- ²⁴ Mg. ₉₁₇
²⁵ Ne	57.8	²⁵ Ne-u	42.2	²⁶ Mg(⁷ Li, ⁸ B) ²⁵ Ne		
²⁵ Mg	45.7	²⁵ Mg(n,γ) ²⁶ Mg	43.1	²⁴ Mg(n,γ) ²⁵ Mg	11.2	²⁵ Mg(p,γ) ²⁶ Al
²⁵ Al	100.0	²⁵ Al- ²⁵ Mg				
²⁵ Al ⁱ	84.7	²⁵ Al ⁱ (IT) ²⁵ Al	15.3	²⁷ Al(p,t) ²⁵ Al ⁱ		
²⁶ Mg	88.9	²⁶ Mg-H ₂₆	8.9	²⁵ Mg(n,γ) ²⁶ Mg	0.9	²⁶ Al- ²⁶ Mg
²⁶ Al	64.1	²⁵ Mg(p,γ) ²⁶ Al	15.0	²⁶ Al- ²⁶ Mg	14.9	²⁶ Al ^m (IT) ²⁶ Al
²⁶ Al ^m	84.5	²⁶ Al ^m (IT) ²⁶ Al	15.5	²⁶ Al ^m - ²⁶ Mg		
²⁷ Al	88.5	²⁷ Al- ²³ Na _{1.174}	11.4	²⁷ Al(p,γ) ²⁸ Si		
²⁷ Si ⁱ	78.7	²⁸ Si(³ He,α) ²⁷ Si ⁱ	21.3	²⁹ Si(p,t) ²⁷ Si ⁱ		
²⁸ Si	37.9	C ₂ H ₄ - ²⁸ Si	34.3	¹³ C ₂ H ₂ - ²⁸ Si	17.2	³¹ P- ²⁸ Si H ₃
²⁸ P	100.0	²⁸ Si(³ He,t) ²⁸ P- ³⁶ Ar() ³⁶ K				
²⁹ Na	63.3	²⁹ Na- ³⁹ K. ₇₄₄	36.7	²⁹ Na-u		
²⁹ Si	100.0	²⁹ Si- ²⁸ Si H				
²⁹ P	59.4	²⁹ P ⁴⁰ Ar-u	40.2	²⁸ Si(p,γ) ²⁹ P	0.4	²⁹ P ⁱ (IT) ²⁹ P
²⁹ P ⁱ	75.8	²⁹ P ⁱ (IT) ²⁹ P	24.2	²⁸ Si(p,γ) ²⁹ P ⁱ		
³⁰ Ne	72.5	³⁰ Ne-u	27.5	³⁰ Ne(n,γ) ³¹ Ne		
³⁰ Na	82.1	³⁰ Na-O _{1.876}	17.9	³⁰ Na- ³⁹ K. ₇₆₉		
³¹ Ne	67.3	³⁰ Ne(n,γ) ³¹ Ne	32.7	³¹ Ne-u		

Table II. Influences on primary nuclides (continued, Explanation of Table on page 030003-74)

Nuclide	Infl.	Equation	Infl.	Equation	Infl.	Equation
³¹ P	60.7	O ₂ - ³¹ P H	39.3	³¹ P- ²⁸ Si H ₃		
³¹ S	96.9	³¹ S- ³¹ P	3.1	³² Cl(p) ³¹ S		
³² S	51.7	³² S-C ₂ D ₄	48.3	³² S-O ₂		
³² Cl	76.3	³² Cl(p) ³¹ S	23.7	³² S(³ He,t) ³² Cl- ³⁶ Ar() ³⁶ K		
³³ S	100.0	³³ S- ³² S H				
³³ Cl	79.9	³² S(p,γ) ³³ Cl	20.1	³³ Cl ⁱ (IT) ³³ Cl		
³³ Cl ⁱ	63.1	³³ Cl ⁱ (IT) ³³ Cl	36.9	³² S(p,γ) ³³ Cl ⁱ		
³⁴ S	46.4	³⁴ S(n,γ) ³⁵ S	23.7	³³ S(n,γ) ³⁴ S	18.0	³⁴ Cl- ³⁴ S
³⁴ Cl	48.4	³³ S(p,γ) ³⁴ Cl	31.0	³⁴ Cl- ³⁴ S	18.4	³⁴ Cl ^m (IT) ³⁴ Cl
³⁴ Cl ^m	65.1	³⁴ Cl ^m (IT) ³⁴ Cl	30.7	³⁴ Cl ^m - ³⁴ S	4.2	³⁴ Cl ^m - ³⁴ Ar
³⁴ Ar	52.0	³⁴ Ar- ³⁴ Cl	35.1	³⁴ Cl ^m - ³⁴ Ar	12.9	³⁴ S- ³⁴ Ar
³⁵ S	71.4	³⁵ S(β ⁻) ³⁵ Cl	28.6	³⁴ S(n,γ) ³⁵ S		
³⁵ Cl	55.8	C ₃ - ³⁵ Cl H	19.5	³⁵ S(β ⁻) ³⁵ Cl	15.3	C ₅ H ₁₀ - ³⁵ Cl ₂
³⁶ S	63.6	³⁶ S(p,γ) ³⁷ Cl	36.4	³⁶ S(p,n) ³⁶ Cl		
³⁶ Cl	99.1	³⁵ Cl(n,γ) ³⁶ Cl	0.9	³⁶ S(p,n) ³⁶ Cl		
³⁶ Ar	100.0	³⁶ Ar-u				
³⁶ K	92.8	³⁶ K- ³⁹ K ₉₂₃	7.2	³² S(³ He,t) ³² Cl- ³⁶ Ar() ³⁶ K		
³⁷ Cl	85.2	C ₃ H ₆ O ₂ - ³⁷ Cl ₂	9.2	C ₅ H ₁₂ - ³⁵ Cl ³⁷ Cl	1.8	³⁶ S(p,γ) ³⁷ Cl
³⁸ Ar	32.0	³⁸ Ar- ³⁹ K ₉₇₄	27.4	³⁸ K ^m - ³⁸ Ar	23.5	³⁸ K- ³⁸ Ar
³⁸ K	26.5	³⁸ K- ³⁸ Ar	26.1	³⁸ K ^m - ³⁸ K	24.6	³⁸ Ca- ³⁸ K
³⁸ K ^m	44.5	³⁸ K ^m - ³⁸ Ar	34.0	³⁸ K ^m - ³⁸ K	21.5	³⁸ K ^m - ³⁸ Ca
³⁸ Ca	48.4	³⁸ Ca-H ₆ O ₂	20.5	³⁸ Ca- ³⁸ K	15.8	³⁸ K ^m - ³⁸ Ca
³⁹ K	99.8	³⁹ K- ⁴⁰ Ar	0.1	³⁹ K(n,γ) ⁴⁰ K	0.1	⁴⁸ Ca- ³⁹ K _{1.231}
³⁹ Ca	100.0	³⁹ Ca ¹⁹ F- ³⁹ K _{1.487}				
⁴⁰ S	79.3	⁴⁰ S- ⁴⁰ Ar	20.7	⁴⁰ S- ⁴¹ K ₉₇₆		
⁴⁰ Ar	46.2	C ₃ H ₄ - ⁴⁰ Ar	32.9	C ₂ D ₈ - ⁴⁰ Ar	13.5	²⁰ Ne ₂ - ⁴⁰ Ar
⁴⁰ K	60.9	³⁹ K(n,γ) ⁴⁰ K	39.1	⁴⁰ K(n,γ) ⁴¹ K		
⁴⁰ Ca	98.9	⁴⁰ Ca-H ₄₀	1.1	⁴⁸ Ca- ⁴⁰ Ca _{1.200}		
⁴¹ K	99.9	⁴¹ K- ⁴⁰ Ar H	0.1	⁴⁰ K(n,γ) ⁴¹ K		
⁴¹ Ca	99.6	⁴⁰ Ca(n,γ) ⁴¹ Ca	0.4	⁴¹ Ca(n,γ) ⁴² Ca		
⁴¹ Sc	79.2	⁴⁰ Ca(p,γ) ⁴¹ Sc	20.8	⁴¹ Sc ^r (IT) ⁴¹ Sc		
⁴¹ Sc ^r	72.4	⁴¹ Sc ^r (IT) ⁴¹ Sc	27.6	⁴¹ Ca(p,γ) ⁴² Sc ^r - ⁴⁰ Ca() ⁴¹ Sc ^r		
⁴² Ca	90.3	⁴¹ Ca(n,γ) ⁴² Ca	3.4	⁴² Sc- ⁴² Ca	2.9	⁴² Sc ^m - ⁴² Ca
⁴² Sc	49.6	⁴² Sc ^r (IT) ⁴² Sc	18.9	⁴² Sc- ⁴² Ca	16.5	⁴² Sc ^m (IT) ⁴² Sc
⁴² Sc ^m	76.3	⁴² Sc ^m (IT) ⁴² Sc	21.8	⁴² Sc ^m - ⁴² Ca	2.0	⁴² Ti- ⁴² Sc ^m
⁴² Sc ^r	66.0	⁴¹ Ca(p,γ) ⁴² Sc ^r - ⁴⁰ Ca() ⁴¹ Sc ^r	34.0	⁴² Sc ^r (IT) ⁴² Sc		
⁴² Ti	48.8	⁴² Ti- ⁴² Sc	38.5	⁴² Ti- ⁴² Sc ^m	12.7	⁴² Ti- ⁴² Ca
⁴³ Ca	98.8	⁴² Ca(n,γ) ⁴³ Ca	1.1	⁴³ Ca(n,γ) ⁴⁴ Ca		
⁴³ Ca ⁱ	76.8	⁴⁴ Ca(p,d) ⁴³ Ca ⁱ	23.2	⁴¹ K(³ He,p) ⁴³ Ca ⁱ		
⁴³ Sc ⁱ	83.3	⁴³ Ca(³ He,t) ⁴³ Sc ⁱ	16.7	⁴² Ca(³ He,d) ⁴³ Sc ⁱ		
⁴³ V ⁱ	88.8	⁴³ V ⁱ (2p) ⁴¹ Sc	11.2	⁴³ V ⁱ (p) ⁴² Ti		
⁴⁴ Ca	97.5	⁴³ Ca(n,γ) ⁴⁴ Ca	2.3	⁴⁴ Ca(n,γ) ⁴⁵ Ca	0.2	⁴⁴ Ca(³ He,t) ⁴⁴ Sc ⁱ
⁴⁴ Sc ⁱ	75.6	⁴⁴ Ca(³ He,t) ⁴⁴ Sc ⁱ	24.4	⁴³ Ca(³ He,d) ⁴⁴ Sc ⁱ		
⁴⁵ Ca	97.0	⁴⁴ Ca(n,γ) ⁴⁵ Ca	3.0	⁴⁵ Ca(β ⁻) ⁴⁵ Sc		
⁴⁵ Sc	87.9	⁴⁵ Sc(p,γ) ⁴⁶ Ti	11.0	⁴⁵ Ca(β ⁻) ⁴⁵ Sc	1.1	⁴⁵ Sc(³ He,t) ⁴⁵ Ti
⁴⁵ Ti	100.0	⁴⁵ Sc(p,n) ⁴⁵ Ti				
⁴⁵ Ti ⁱ	60.3	⁴⁵ Sc(³ He,t) ⁴⁵ Ti ⁱ	39.7	⁴⁶ Ti(p,d) ⁴⁵ Ti ⁱ		
⁴⁵ V	100.0	⁴⁵ V- ⁴⁵ Ti				
⁴⁶ Ca	90.4	⁴⁶ Ca(n,γ) ⁴⁷ Ca	9.6	⁴⁶ Ca(³ He,t) ⁴⁶ Sc ⁱ		
⁴⁶ Sc ⁱ	62.6	⁴⁶ Ca(³ He,t) ⁴⁶ Sc ⁱ	37.4	⁴⁸ Ti(p, ³ He) ⁴⁶ Sc ⁱ		
⁴⁶ Ti	33.1	⁴⁶ Ti(p,γ) ⁴⁷ V	33.1	⁴⁶ Ti(³ He,t) ⁴⁶ V- ⁴⁷ Ti() ⁴⁷ V	25.2	⁴⁶ Ti(d,p) ⁴⁷ Ti- ⁴⁸ Ti() ⁴⁹ Ti
⁴⁶ V	100.0	⁴⁶ V- ⁴⁶ Ti	13.8	⁴⁶ V- ²² Ne _{2.091}	0.1	⁴⁶ Ti(³ He,t) ⁴⁶ V- ⁴⁸ Ti() ⁴⁸ Vxi

Table II. Influences on primary nuclides (continued, Explanation of Table on page 030003-74)

Nuclide	Infl.	Equation	Infl.	Equation	Infl.	Equation
⁴⁶ Cr	67.2	⁴⁶ Cr-u	32.8	³² S(¹⁶ O,2n) ⁴⁶ Cr		
⁴⁷ Ca	90.5	⁴⁷ Ca(β^-) ⁴⁷ Sc	9.5	⁴⁶ Ca(n, γ) ⁴⁷ Ca		
⁴⁷ Sc	93.0	⁴⁷ Sc(β^-) ⁴⁷ Ti	7.0	⁴⁷ Ca(β^-) ⁴⁷ Sc		
⁴⁷ Ti	90.7	⁴⁷ Ti(n, γ) ⁴⁸ Ti	3.5	⁴⁶ Ti(³ He,t) ⁴⁶ V- ⁴⁷ Ti(γ) ⁴⁷ V	3.4	⁴⁶ Ti(d,p) ⁴⁷ Ti- ⁴⁸ Ti(γ) ⁴⁹ Ti
⁴⁷ V	61.0	⁴⁶ Ti(p, γ) ⁴⁷ V	39.0	⁴⁶ Ti(³ He,t) ⁴⁶ V- ⁴⁷ Ti(γ) ⁴⁷ V		
⁴⁷ Cr	56.7	⁴⁷ Cr-u	24.8	⁴⁸ Mn ⁱ (p) ⁴⁷ Cr	18.5	⁵⁰ Cr(³ He, ⁶ He) ⁴⁷ Cr
⁴⁸ Ca	23.0	⁴⁸ Ti- ⁴⁸ Ca	22.1	⁴⁸ Ca- ⁴¹ K _{1,171}	22.1	⁴⁸ Ca- ³⁹ K _{1,231}
⁴⁸ Sc	50.0	⁴⁸ Ca(p,n) ⁴⁸ Sc	50.0	⁴⁸ Sc(β^-) ⁴⁸ Ti		
⁴⁸ Ti	64.8	⁴⁸ Ti- ⁴⁸ Ca	26.1	⁴⁸ Ti-N ¹⁸ O O	8.3	⁴⁷ Ti(n, γ) ⁴⁸ Ti
⁴⁸ V	89.6	⁴⁸ V ⁱ (IT) ⁴⁸ V	10.4	⁴⁸ V(β^+) ⁴⁸ Ti		
⁴⁸ V ⁱ	99.5	⁴⁶ Ti(³ He,t) ⁴⁶ V- ⁴⁸ Ti(γ) ⁴⁸ V ⁱ	0.5	⁴⁸ V ⁱ (IT) ⁴⁸ V		
⁴⁸ Mn	55.5	⁴⁸ Mn-u	44.5	⁴⁸ Mn ⁱ (IT) ⁴⁸ Mn		
⁴⁸ Mn ⁱ	55.1	⁴⁸ Mn ⁱ (IT) ⁴⁸ Mn	44.9	⁴⁸ Mn ⁱ (p) ⁴⁷ Cr		
⁴⁹ Sc	70.9	⁴⁸ Ca(p, γ) ⁴⁹ Sc	29.1	⁴⁹ Sc(β^-) ⁴⁹ Ti		
⁴⁹ Ti	100.0	⁴⁸ Ti(n, γ) ⁴⁹ Ti				
⁴⁹ Cr	100.0	⁵⁰ Cr(d,t) ⁴⁹ Cr				
⁴⁹ Mn	100.0	⁴⁹ Mn- ⁴⁹ Cr				
⁵⁰ Ti	100.0	⁴⁹ Ti(n, γ) ⁵⁰ Ti				
⁵⁰ V ⁱ	100.0	⁴⁶ Ti(³ He,t) ⁴⁶ V- ⁵⁰ Ti(γ) ⁵⁰ V ⁱ				
⁵⁰ Cr	86.8	⁵⁰ Cr(n, γ) ⁵¹ Cr	13.1	⁵⁰ Cr(p, γ) ⁵¹ Mn	0.1	⁵⁰ Cr(³ He, ⁶ He) ⁴⁷ Cr
⁵⁰ Mn	52.0	⁵⁰ Mn- ⁵⁰ Cr	36.5	⁵⁰ Mn ^m - ⁵⁰ Mn	11.5	⁵⁰ Cr(³ He,t) ⁵⁰ Mn- ⁵⁴ Fe(γ) ⁵⁴ Co
⁵⁰ Mn ^m	81.2	⁵⁰ Mn ^m - ⁵⁰ Cr	18.8	⁵⁰ Mn ^m - ⁵⁰ Mn		
⁵¹ V	53.6	⁵¹ V- ³⁹ K _{1,308}	39.4	⁵¹ V(p,n) ⁵¹ Cr	7.0	⁵¹ Cr- ⁵¹ V
⁵¹ Cr	43.2	⁵¹ Cr- ³⁹ K _{1,308}	39.1	⁵¹ V(p,n) ⁵¹ Cr	10.8	⁵⁰ Cr(n, γ) ⁵¹ Cr
⁵¹ Mn	81.5	⁵⁰ Cr(p, γ) ⁵¹ Mn	18.5	⁵⁴ Fe(p, α) ⁵¹ Mn		
⁵¹ Fe	64.3	⁵¹ Fe-u	35.7	⁵⁴ Fe(³ He, ⁶ He) ⁵¹ Fe		
⁵² Cr	57.7	⁵² Cr- ³⁹ K _{1,333}	33.2	⁵² Cr(n, γ) ⁵³ Cr	9.0	⁵² Cr(p, γ) ⁵³ Mn
⁵² Mn	96.9	⁵⁴ Fe(d, α) ⁵² Mn	3.1	⁵² Fe(β^+) ⁵² Mn		
⁵² Fe	61.4	⁵² Fe(β^+) ⁵² Mn	38.6	⁵³ Co ^m (p) ⁵² Fe		
⁵³ Cr	62.0	⁵² Cr(n, γ) ⁵³ Cr	38.0	⁵³ Cr(n, γ) ⁵⁴ Cr		
⁵³ Mn	76.6	⁵² Cr(p, γ) ⁵³ Mn	23.4	⁵⁶ Fe(p, α) ⁵³ Mn		
⁵³ Fe	97.6	⁵⁴ Fe(d,t) ⁵³ Fe	1.4	⁵³ Co ^m - ⁵³ Fe	1.0	⁵³ Co- ⁵³ Fe
⁵³ Co	93.2	⁵³ Co- ⁵³ Fe	6.8	⁵³ Co ^m - ⁵³ Co		
⁵³ Co ^m	57.7	⁵³ Co ^m - ⁵³ Fe	39.1	⁵³ Co ^m - ⁵³ Co	3.2	⁵³ Co ^m (p) ⁵² Fe
⁵⁴ Cr	58.3	⁵³ Cr(n, γ) ⁵⁴ Cr	41.7	⁵⁴ Cr(p, γ) ⁵⁵ Mn	0.1	⁵⁴ Cr(³ He,t) ⁵⁴ Mn ⁱ
⁵⁴ Mn ⁱ	51.3	⁵² Cr(³ He,p) ⁵⁴ Mn ⁱ	48.7	⁵⁴ Cr(³ He,t) ⁵⁴ Mn ⁱ		
⁵⁴ Fe	71.4	⁵⁴ Fe(n, γ) ⁵⁵ Fe	18.4	⁵⁴ Fe(p, γ) ⁵⁵ Co	9.1	⁵⁴ Fe(p, α) ⁵¹ Mn
⁵⁴ Co	46.9	⁵⁴ Co- ⁵⁴ Fe	29.7	⁵⁴ Co ^m - ⁵⁴ Co	23.5	⁵⁰ Cr(³ He,t) ⁵⁰ Mn- ⁵⁴ Fe(γ) ⁵⁴ Co
⁵⁴ Co ^m	80.8	⁵⁴ Co ^m - ⁵⁴ Fe	19.2	⁵⁴ Co ^m - ⁵⁴ Co		
⁵⁵ Ti	52.2	⁵⁵ Ti(β^-) ⁵⁵ V	47.8	⁵⁵ Ti-u		
⁵⁵ V	90.4	⁵⁵ V(β^-) ⁵⁵ Cr	9.6	⁵⁵ Ti(β^-) ⁵⁵ V		
⁵⁵ Cr	100.0	⁵⁴ Cr(n, γ) ⁵⁵ Cr				
⁵⁵ Mn	44.1	⁵⁵ Mn(p, γ) ⁵⁶ Fe	21.3	⁵⁴ Cr(p, γ) ⁵⁵ Mn	15.0	⁵⁵ Mn- ⁸⁵ Rb _{.647}
⁵⁵ Fe	81.8	⁵⁵ Fe(ϵ) ⁵⁵ Mn	18.2	⁵⁴ Fe(n, γ) ⁵⁵ Fe		
⁵⁵ Co	55.3	⁵⁴ Fe(p, γ) ⁵⁵ Co	33.0	⁵⁶ Ni- ⁵⁵ Co _{1,018}	11.6	⁵⁸ Ni(p, α) ⁵⁵ Co
⁵⁶ Ti	90.2	⁵⁶ Ti-u	9.8	⁵⁶ Ti(β^-) ⁵⁶ V		
⁵⁶ V	75.0	⁵⁶ V-u	25.0	⁵⁶ Ti(β^-) ⁵⁶ V		
⁵⁶ Fe	42.1	⁵⁵ Mn(p, γ) ⁵⁶ Fe	27.3	⁵⁶ Fe- ⁸⁵ Rb _{.659}	15.8	⁵⁶ Fe(n, γ) ⁵⁷ Fe
⁵⁶ Co	50.8	⁵⁶ Co- ⁵⁸ Ni _{.966}	49.2	⁵⁶ Ni- ⁵⁶ Co		
⁵⁶ Ni	39.7	⁵⁶ Ni- ⁵⁶ Fe	27.1	⁵⁶ Ni- ⁵⁵ Co _{1,018}	17.8	⁵⁶ Ni- ⁵⁶ Co
⁵⁷ Mn	49.3	⁵⁷ Mn- ⁸⁵ Rb _{.671}	33.3	⁵⁷ Mn- ³⁹ K _{1,462}	17.4	⁵⁵ Mn(t,p) ⁵⁷ Mn
⁵⁷ Fe	83.2	⁵⁶ Fe(n, γ) ⁵⁷ Fe	10.3	⁵⁷ Fe(n, γ) ⁵⁸ Fe	5.3	⁵⁷ Fe- ⁵⁸ Ni _{.983}

Table II. Influences on primary nuclides (continued, Explanation of Table on page 030003-74)

Nuclide	Infl.	Equation	Infl.	Equation	Infl.	Equation
^{57}Co	33.1	$^{60}\text{Ni}(p,\alpha)^{57}\text{Co}$	28.5	$^{56}\text{Fe}(p,\gamma)^{57}\text{Co}$	28.3	$^{58}\text{Fe}(p,\gamma)^{59}\text{Co}-^{56}\text{Fe}()^{57}\text{Co}$
^{57}Ni	50.1	$^{57}\text{Ni}-^{58}\text{Ni}_{.983}$	49.9	$^{57}\text{Cu}-^{57}\text{Ni}$		
^{57}Cu	47.9	$^{57}\text{Cu}-^{56}\text{Ni}_{1.018}$	28.5	$^{57}\text{Cu}-^{57}\text{Fe}$	23.6	$^{57}\text{Cu}-^{57}\text{Ni}$
^{58}Fe	82.4	$^{57}\text{Fe}(n,\gamma)^{58}\text{Fe}$	13.4	$^{58}\text{Fe}(n,\gamma)^{59}\text{Fe}$	4.2	$^{58}\text{Fe}(p,\gamma)^{59}\text{Co}-^{56}\text{Fe}()^{57}\text{Co}$
^{58}Co	60.9	$^{59}\text{Co}(d,t)^{58}\text{Co}$	25.1	$^{60}\text{Ni}(d,\alpha)^{58}\text{Co}$	14.0	$^{57}\text{Fe}(p,\gamma)^{58}\text{Co}$
^{58}Ni	28.3	$^{57}\text{Fe}-^{58}\text{Ni}_{.983}$	27.7	$^{58}\text{Ni}(n,\gamma)^{59}\text{Ni}$	25.7	$^{56}\text{Fe}-^{58}\text{Ni}_{.966}$
^{58}Cu	90.2	$^{58}\text{Cu}-^{58}\text{Ni}$	9.8	$^{59}\text{Zn}-^{58}\text{Cu}_{1.017}$		
^{59}Fe	85.5	$^{58}\text{Fe}(n,\gamma)^{59}\text{Fe}$	14.5	$^{59}\text{Fe}-^{85}\text{Rb}_{.694}$		
^{59}Co	90.4	$^{59}\text{Co}(p,n)^{59}\text{Ni}$	8.5	$^{58}\text{Fe}(p,\gamma)^{59}\text{Co}-^{56}\text{Fe}()^{57}\text{Co}$	1.1	$^{59}\text{Co}(d,t)^{58}\text{Co}$
^{59}Ni	71.8	$^{58}\text{Ni}(n,\gamma)^{59}\text{Ni}$	24.1	$^{59}\text{Ni}(n,\gamma)^{60}\text{Ni}$	4.1	$^{59}\text{Co}(p,n)^{59}\text{Ni}$
^{59}Cu	62.5	$^{58}\text{Ni}(p,\gamma)^{59}\text{Cu}$	30.3	$^{60}\text{Zn}-^{59}\text{Cu}_{1.017}$	7.2	$^{59}\text{Zn}-^{59}\text{Cu}$
^{59}Zn	73.3	$^{59}\text{Zn}-^{59}\text{Cu}$	26.7	$^{59}\text{Zn}-^{58}\text{Cu}_{1.017}$		
^{60}Ni	75.3	$^{59}\text{Ni}(n,\gamma)^{60}\text{Ni}$	20.5	$^{60}\text{Ni}(n,\gamma)^{61}\text{Ni}$	4.0	$^{60}\text{Ni}(p,\alpha)^{57}\text{Co}$
$^{60}\text{Cu}^i$	73.5	$^{60}\text{Ni}(^3\text{He},t)^{60}\text{Cu}^i$	26.5	$^{58}\text{Ni}(^3\text{He},p)^{60}\text{Cu}^i$		
^{60}Zn	65.0	$^{60}\text{Zn}-^{58}\text{Ni}_{1.034}$	35.0	$^{60}\text{Zn}-^{59}\text{Cu}_{1.017}$		
^{61}Ni	79.2	$^{60}\text{Ni}(n,\gamma)^{61}\text{Ni}$	20.8	$^{61}\text{Ni}(n,\gamma)^{62}\text{Ni}$		
^{61}Zn	95.4	$^{64}\text{Zn}(^3\text{He},^6\text{He})^{61}\text{Zn}$	4.6	$^{61}\text{Ga}(\beta^+)^{61}\text{Zn}$		
^{61}Ga	52.2	$^{61}\text{Ga}(\beta^+)^{61}\text{Zn}$	47.8	$^{61}\text{Ga}-u$		
^{62}Ni	66.9	$^{61}\text{Ni}(n,\gamma)^{62}\text{Ni}$	15.9	$^{62}\text{Ni}(p,\gamma)^{63}\text{Cu}$	13.9	$^{62}\text{Ni}(n,\gamma)^{63}\text{Ni}$
^{62}Zn	67.7	$^{62}\text{Zn}-^{62}\text{Ni}$	32.3	$^{62}\text{Ga}-^{62}\text{Zn}$		
^{62}Ga	51.7	$^{62}\text{Ga}-^{62}\text{Ni}$	48.3	$^{62}\text{Ga}-^{62}\text{Zn}$		
^{63}Fe	57.3	$^{63}\text{Fe}-^{39}\text{K}_{1.615}$	21.3	$^{63}\text{Fe}-\text{H C}_2 \text{ F}_2$	21.3	$^{63}\text{Fe}-\text{C }^{32}\text{S F}$
^{63}Co	86.2	$^{64}\text{Ni}(t,\alpha)^{63}\text{Co}$	13.8	$^{63}\text{Co}(\beta^-)^{63}\text{Ni}$		
^{63}Ni	55.3	$^{63}\text{Ni}(\beta^-)^{63}\text{Cu}$	33.6	$^{62}\text{Ni}(n,\gamma)^{63}\text{Ni}$	11.1	$^{63}\text{Ni}(n,\gamma)^{64}\text{Ni}$
^{63}Cu	43.1	$^{63}\text{Ni}(\beta^-)^{63}\text{Cu}$	37.8	$^{62}\text{Ni}(p,\gamma)^{63}\text{Cu}$	9.7	$^{63}\text{Cu}(n,\gamma)^{64}\text{Cu}$
^{63}Zn	72.7	$^{64}\text{Zn}(d,t)^{63}\text{Zn}$	27.3	$^{63}\text{Cu}(p,n)^{63}\text{Zn}$		
$^{64}\text{Co}^m$	86.8	$\text{H C}_2 \text{ F}_2-^{64}\text{Co}^m_{.984}$	13.2	$^{64}\text{Co}^m-^{32}\text{S O}_2$		
^{64}Ni	86.7	$^{63}\text{Ni}(n,\gamma)^{64}\text{Ni}$	13.3	$^{64}\text{Ni}-^{85}\text{Rb}_{.753}$		
^{64}Cu	89.8	$^{63}\text{Cu}(n,\gamma)^{64}\text{Cu}$	10.2	$^{64}\text{Cu}(\beta^-)^{64}\text{Zn}$		
^{64}Zn	43.6	$^{64}\text{Zn}(n,\gamma)^{65}\text{Zn}$	32.0	$^{64}\text{Cu}(\beta^-)^{64}\text{Zn}$	17.1	$^{64}\text{Zn}(p,\gamma)^{65}\text{Ga}$
^{64}Ga	37.6	$^{64}\text{Ga}-^{85}\text{Rb}_{.753}$	32.7	$\text{C}_5 \text{ H}_2-^{64}\text{Ga}_{.969}$	13.1	$^{64}\text{Ga}-^{64}\text{Zn}$
$^{64}\text{Ga}^i$	83.2	$^{64}\text{Ga}^i(\text{IT})^{64}\text{Ga}$	16.8	$^{64}\text{Zn}(^3\text{He},t)^{64}\text{Ga}^i$		
^{65}Cu	45.6	$^{65}\text{Cu}(p,n)^{65}\text{Zn}$	33.8	$^{65}\text{Cu}-^{85}\text{Rb}_{.765}$	10.4	$^{65}\text{Cu}(p,\alpha)^{62}\text{Ni}$
^{65}Zn	54.6	$^{64}\text{Zn}(n,\gamma)^{65}\text{Zn}$	45.4	$^{65}\text{Cu}(p,n)^{65}\text{Zn}$		
^{65}Ga	66.0	$^{64}\text{Zn}(p,\gamma)^{65}\text{Ga}$	34.0	$^{65}\text{Ga}-^{85}\text{Rb}_{.765}$		
^{65}Ge	56.7	$\text{C}_5 \text{ H}_2-^{65}\text{Ge}_{.939}$	29.2	$^{65}\text{Ge O H}-^{85}\text{Rb}_{.965}$	14.0	$^{65}\text{Ge H}-^{85}\text{Rb}_{.776}$
^{66}Cu	89.8	$^{65}\text{Cu}(n,\gamma)^{66}\text{Cu}$	10.2	$^{66}\text{Cu}-^{85}\text{Rb}_{.776}$		
^{66}Zn	65.9	$^{66}\text{Zn}(p,\alpha)^{63}\text{Cu}$	34.1	$^{66}\text{Zn}(n,\gamma)^{67}\text{Zn}$		
^{67}Cu	54.5	$^{67}\text{Cu}-^{85}\text{Rb}_{.788}$	45.5	$^{67}\text{Cu}(\beta^-)^{67}\text{Zn}$		
^{67}Zn	63.7	$^{66}\text{Zn}(n,\gamma)^{67}\text{Zn}$	23.4	$^{67}\text{Cu}(\beta^-)^{67}\text{Zn}$	11.6	$^{67}\text{Zn}(p,n)^{67}\text{Ga}$
^{67}Ga	54.6	$^{67}\text{Zn}(p,n)^{67}\text{Ga}$	45.4	$^{70}\text{Ge}(p,\alpha)^{67}\text{Ga}$		
^{67}As	77.4	$^{67}\text{As}-^{85}\text{Rb}_{.788}$	22.6	$^{67}\text{As O}-^{85}\text{Rb}_{.976}$		
^{68}Zn	98.6	$^{67}\text{Zn}(n,\gamma)^{68}\text{Zn}$	1.4	$^{70}\text{Zn }^{35}\text{Cl}-^{68}\text{Zn }^{37}\text{Cl}$		
^{68}As	87.5	$^{68}\text{As}-\text{C}_5 \text{ H}_8$	12.5	$\text{C F}_3-^{68}\text{As}_{1.015}$		
^{69}Ga	64.5	$^{69}\text{Ga}-^{85}\text{Rb}_{.812}$	35.4	$^{69}\text{Ga}(n,\gamma)^{70}\text{Ga}$		
^{69}Ge	100.0	$^{69}\text{Ga}(p,n)^{69}\text{Ge}$				
^{69}As	81.8	$^{69}\text{As}(\beta^+)^{69}\text{Ge}$	18.2	$^{69}\text{Se}(\beta^+)^{69}\text{As}$		
^{69}Se	100.0	$\text{C F}_3-^{69}\text{Se}$				
^{70}Zn	87.6	$^{70}\text{Zn}(p,n)^{70}\text{Ga}$	9.0	$^{70}\text{Zn }^{35}\text{Cl}-^{68}\text{Zn }^{37}\text{Cl}$	3.4	$^{70}\text{Zn}(d,p)^{71}\text{Zn}$
^{70}Ga	64.1	$^{69}\text{Ga}(n,\gamma)^{70}\text{Ga}$	31.4	$^{70}\text{Ga}-^{85}\text{Rb}_{.824}$	4.5	$^{70}\text{Zn}(p,n)^{70}\text{Ga}$
^{70}Ge	85.4	$^{70}\text{Ge}(n,\gamma)^{71}\text{Ge}$	14.6	$^{70}\text{Ge}(p,\alpha)^{67}\text{Ga}$		
^{71}Zn	93.2	$^{71}\text{Zn}^m(\text{IT})^{71}\text{Zn}$	6.8	$^{70}\text{Zn}(d,p)^{71}\text{Zn}$		

Table II. Influences on primary nuclides (continued, Explanation of Table on page 030003-74)

Nuclide	Infl.	Equation	Infl.	Equation	Infl.	Equation
$^{71}\text{Zn}^m$	94.7	$^{71}\text{Zn}^m - ^{85}\text{Rb}_{.835}$	5.3	$^{71}\text{Zn}^m(\text{IT})^{71}\text{Zn}$		
^{71}Ga	53.3	$^{71}\text{Ga} - ^{85}\text{Rb}_{.835}$	33.1	$^{71}\text{Ga}(\text{n},\gamma)^{72}\text{Ga}$	13.5	$^{71}\text{Ge}(\epsilon)^{71}\text{Ga}$
^{71}Ge	85.6	$^{71}\text{Ge}(\epsilon)^{71}\text{Ga}$	14.4	$^{70}\text{Ge}(\text{n},\gamma)^{71}\text{Ge}$		
^{71}Br	100.0	$^{71}\text{Br} \text{H}_2 - \text{C}_4 \text{H}_9 \text{O}$				
^{71}Kr	83.8	$^{71}\text{Kr} - \text{u}$	16.2	$^{71}\text{Kr}(\epsilon)^{71}\text{Br}$		
^{72}Ga	65.7	$^{71}\text{Ga}(\text{n},\gamma)^{72}\text{Ga}$	34.3	$^{72}\text{Ga} - ^{85}\text{Rb}_{.847}$		
^{72}Ge	100.0	$^{72}\text{Ge}(\text{n},\gamma)^{73}\text{Ge}$				
^{73}Cu	75.4	$^{73}\text{Cu} - ^{72}\text{Ge}_{1.014}$	24.6	$^{73}\text{Cu} - ^{85}\text{Rb}_{.859}$		
^{73}Ge	100.0	$^{73}\text{Ge}(\text{n},\gamma)^{74}\text{Ge}$				
^{73}As	92.8	$^{72}\text{Ge}(\beta^+)^{73}\text{As}$	7.2	$^{73}\text{Se}(\beta^+)^{73}\text{As}$		
^{73}Se	52.5	$^{73}\text{Se} - ^{85}\text{Rb}_{.859}$	47.5	$^{73}\text{Se}(\beta^+)^{73}\text{As}$		
^{74}Ge	100.0	$^{74}\text{Ge} - ^{84}\text{Kr}$				
^{74}As	82.1	$^{74}\text{As}(\beta^+)^{74}\text{Ge}$	17.9	$^{74}\text{As}(\beta^-)^{74}\text{Se}$		
^{74}Se	100.0	$^{74}\text{Se} - ^{74}\text{Ge}$				
^{74}Br	84.9	$^{74}\text{Br} - ^{27}\text{Al} - ^{85}\text{Rb}_{1.188}$	15.1	$^{74}\text{Se}(\text{p},\text{n})^{74}\text{Br}$		
^{74}Kr	93.3	$^{74}\text{Kr} - ^{85}\text{Rb}_{.871}$	6.7	$^{74}\text{Rb}(\beta^+)^{74}\text{Kr}$		
^{74}Rb	82.8	$^{74}\text{Rb} - ^{85}\text{Rb}_{.871}$	17.2	$^{74}\text{Rb}(\beta^+)^{74}\text{Kr}$		
^{75}As	85.3	$^{75}\text{As}(\text{p},\text{n})^{75}\text{Se}$	14.7	$^{78}\text{Se}(\text{p},\alpha)^{75}\text{As}$		
^{75}Se	99.9	$^{74}\text{Se}(\text{n},\gamma)^{75}\text{Se}$	0.1	$^{75}\text{As}(\text{p},\text{n})^{75}\text{Se}$		
^{76}Zn	61.1	$^{76}\text{Zn} - ^{85}\text{Rb}_{.894}$	38.9	$^{76}\text{Zn} - ^{88}\text{Rb}_{.864}$		
^{76}Ge	100.0	$^{76}\text{Ge} - ^{76}\text{Se}$				
^{76}Se	100.0	$^{76}\text{Se} - ^{84}\text{Kr}$				
^{76}Kr	84.0	$^{76}\text{Kr} - ^{85}\text{Rb}_{.894}$	16.0	$^{80}\text{Kr}(\alpha, ^6\text{He})^{78}\text{Kr} - ^{78}\text{Kr}(\text{O})^{76}\text{Kr}$		
^{77}Zn	77.9	$^{77}\text{Zn} - ^{85}\text{Rb}_{.906}$	22.1	$^{77}\text{Zn} - ^{88}\text{Rb}_{.875}$		
^{77}As	32.4	$^{80}\text{Se}(\text{p},\alpha)^{77}\text{As}$	31.8	$^{76}\text{Ge}(\beta^+)^{77}\text{As}$	17.9	$^{77}\text{As}(\beta^-)^{77}\text{Se}$
^{77}Se	99.4	$^{76}\text{Se}(\text{n},\gamma)^{77}\text{Se}$	0.5	$^{77}\text{Se}(\text{n},\gamma)^{78}\text{Se}$		
^{78}Zn	51.6	$^{78}\text{Zn} - ^{88}\text{Rb}_{.886}$	48.4	$^{78}\text{Zn} - ^{85}\text{Rb}_{.918}$		
^{78}Ga	61.7	$^{78}\text{Ga} - ^{85}\text{Rb}_{.918}$	38.3	$^{78}\text{Ga} - ^{88}\text{Rb}_{.886}$		
^{78}Se	95.3	$^{77}\text{Se}(\text{n},\gamma)^{78}\text{Se}$	3.5	$^{78}\text{Kr} - ^{78}\text{Se}$	0.5	$^{80}\text{Se}(\text{p},\text{t})^{78}\text{Se}$
^{78}Kr	88.8	$^{78}\text{Kr} - ^{78}\text{Se}$	10.9	$^{78}\text{Kr} - ^{86}\text{Kr}_{.907}$	0.3	$^{80}\text{Kr}(\alpha, ^6\text{He})^{78}\text{Kr} - ^{78}\text{Kr}(\text{O})^{76}\text{Kr}$
^{79}Zn	67.7	$^{79}\text{Zn} - ^{88}\text{Rb}_{.898}$	32.3	$^{79}\text{Zn} - ^{85}\text{Rb}_{.929}$		
^{79}Ga	100.0	$^{79}\text{Ga} - ^{88}\text{Rb}_{.898}$				
^{79}Ge	86.2	$^{79}\text{Ga}(\beta^-)^{79}\text{Ge}$	13.8	$^{79}\text{Ge}(\beta^-)^{79}\text{As}$		
^{79}As	99.8	$^{80}\text{Se}(\text{d}, ^3\text{He})^{79}\text{As}$	0.2	$^{79}\text{Ge}(\beta^-)^{79}\text{As}$		
^{80}Zn	85.6	$^{80}\text{Zn} - ^{85}\text{Rb}_{.941}$	14.4	$^{80}\text{Zn} - ^{88}\text{Rb}_{.909}$		
^{80}Se	37.0	$^{82}\text{Se} - ^{35}\text{Cl} - ^{80}\text{Se} - ^{37}\text{Cl}$	26.0	$^{80}\text{Se}(\text{n},\gamma)^{81}\text{Se}$	20.5	$^{80}\text{Se}(\text{p},\text{t})^{78}\text{Se}$
^{80}Kr	45.5	$^{80}\text{Kr} - ^{86}\text{Kr}_{.930}$	19.1	$^{80}\text{Kr} - ^{85}\text{Rb}_{.941}$	7.9	$^{81}\text{Se} - ^{80}\text{Kr}_{1.013}$
^{81}As	73.8	$^{81}\text{As} - ^{88}\text{Rb}_{.920}$	26.2	$^{82}\text{Se}(\text{d}, ^3\text{He})^{81}\text{As}$		
^{81}Se	71.3	$^{80}\text{Se}(\text{n},\gamma)^{81}\text{Se}$	17.8	$^{81}\text{Se} - ^{80}\text{Kr}_{1.013}$	10.9	$^{82}\text{Se}(\text{p},\text{d})^{81}\text{Se}$
^{81}Br	94.3	$^{81}\text{Br}(\text{n},\gamma)^{82}\text{Br}$	5.1	$^{81}\text{Kr}(\epsilon)^{81}\text{Br}$	0.6	$^{87}\text{Rb}(\beta^+)^{81}\text{Br} - ^{81}\text{Br}(\text{O})^{81}\text{Kr}$
^{81}Kr	83.7	$^{81}\text{Kr}(\epsilon)^{81}\text{Br}$	9.3	$^{87}\text{Rb}(\beta^+)^{81}\text{Br} - ^{81}\text{Br}(\text{O})^{81}\text{Kr}$	7.0	$^{80}\text{Kr}(\text{d},\text{p})^{81}\text{Kr}$
^{81}Rb	76.1	$^{81}\text{Rb} - ^{85}\text{Rb}_{.953}$	23.9	$^{80}\text{Kr}(\beta^+)^{81}\text{Rb}$		
^{82}Se	92.8	$^{82}\text{Se} - ^{82}\text{Kr}$	4.1	$^{82}\text{Se} - ^{35}\text{Cl} - ^{80}\text{Se} - ^{37}\text{Cl}$	1.1	$^{82}\text{Se}(\text{p},\text{d})^{81}\text{Se}$
^{82}Br	94.4	$^{82}\text{Br}(\beta^-)^{82}\text{Kr}$	5.6	$^{81}\text{Br}(\text{n},\gamma)^{82}\text{Br}$		
^{82}Kr	75.4	$^{82}\text{Kr} - ^{84}\text{Kr}_{.976}$	24.6	$^{82}\text{Kr} - ^{86}\text{Kr}_{.953}$		
^{82}Sr	64.7	$^{82}\text{Sr} - ^{85}\text{Rb}_{.965}$	35.3	$^{84}\text{Sr}(\text{p},\text{t})^{82}\text{Sr}$		
^{83}Br	54.4	$^{83}\text{Br}(\beta^-)^{83}\text{Kr}$	45.6	$^{82}\text{Se}(\beta^+)^{83}\text{Br}$		
^{83}Kr	100.0	$^{83}\text{Kr} - ^{84}\text{Kr}_{.988}$				
^{83}Rb	100.0	$^{83}\text{Rb} - ^{85}\text{Rb}_{.976}$				
^{83}Sr	58.7	$^{83}\text{Sr} - ^{83}\text{Rb}$	41.3	$^{83}\text{Sr}(\beta^+)^{83}\text{Rb}$		
^{84}Se	99.9	$^{84}\text{Se} - ^{88}\text{Rb}_{.955}$	0.1	$^{84}\text{Se}(\beta^-)^{84}\text{Br}$		
^{84}Br	73.6	$^{84}\text{Br}(\beta^-)^{84}\text{Kr}$	26.4	$^{84}\text{Se}(\beta^-)^{84}\text{Br}$		

Table II. Influences on primary nuclides (continued, Explanation of Table on page 030003-74)

Nuclide	Infl.	Equation	Infl.	Equation	Infl.	Equation
^{84}Kr	21.2	$^{84}\text{Kr}-\text{N}_6$	19.7	$^{86}\text{Kr}-^{84}\text{Kr}_{1.024}$	14.6	$^{86}\text{Kr}-^{84}\text{Kr}$
^{84}Rb	72.7	$^{84}\text{Rb}(\beta^+)^{84}\text{Kr}$	27.3	$^{84}\text{Rb}(\beta^-)^{84}\text{Sr}$		
^{84}Sr	88.8	$^{84}\text{Sr}-^{85}\text{Rb}_{.988}$	6.8	$^{84}\text{Rb}(\beta^-)^{84}\text{Sr}$	2.1	$^{84}\text{Sr}(\text{d,p})^{85}\text{Sr}$
^{84}Y	81.8	$^{84}\text{Y O}-^{97}\text{Mo}_{1.031}$	18.2	$^{84}\text{Y}(\beta^+)^{84}\text{Sr}$		
^{85}Rb	65.9	$^{86}\text{Kr}-^{85}\text{Rb}$	34.1	$^{85}\text{Rb}-^{84}\text{Kr}$		
^{85}Sr	87.9	$^{85}\text{Rb}(\beta^+)^{85}\text{Sr}$	12.1	$^{84}\text{Sr}(\text{d,p})^{85}\text{Sr}$		
^{86}Kr	27.0	$^{86}\text{Kr}-\text{N}_6$	15.5	$^{129}\text{Xe}_2-^{86}\text{Kr}_3$	12.0	$\text{C}_2 \text{O}_4-^{86}\text{Kr}$
^{86}Sr	53.5	$^{86}\text{Sr}-^{84}\text{Kr}_{1.024}$	46.5	$^{86}\text{Sr}-^{86}\text{Kr}$		
^{86}Zr	69.2	$^{86}\text{Zr}-^{85}\text{Rb}_{1.012}$	30.8	$^{86}\text{Zr O}-^{98}\text{Mo}_{1.041}$		
^{87}Rb	81.3	$^{87}\text{Rb}-^{86}\text{Kr}$	18.4	$^{87}\text{Rb}-\text{C}_6 \text{H}_{14}$	0.1	$^{90}\text{Zr}-^{87}\text{Rb}_{1.034}$
^{87}Sr	58.9	$^{87}\text{Sr}-^{86}\text{Kr}_{1.012}$	41.1	$^{87}\text{Sr}-^{84}\text{Kr}_{1.036}$		
^{87}Zr	73.2	$^{87}\text{Zr O}-^{97}\text{Mo}_{1.062}$	26.8	$^{90}\text{Zr}(\beta^+)^{87}\text{Zr}$		
^{87}Mo	53.3	$^{87}\text{Mo}-^{85}\text{Rb}_{1.024}$	46.7	$^{87}\text{Mo}_{1.069}-\text{C}_7 \text{H}_9$		
^{88}Rb	99.0	$^{87}\text{Rb}(\text{n},\gamma)^{88}\text{Rb}$	0.2	$^{76}\text{Zn}-^{88}\text{Rb}_{.864}$	0.1	$^{94}\text{Rb}-^{88}\text{Rb}_{1.068}$
^{88}Sr	58.3	$^{88}\text{Sr}-^{86}\text{Kr}_{1.023}$	41.7	$^{88}\text{Sr}-^{84}\text{Kr}_{1.048}$		
^{88}Zr	70.6	$^{88}\text{Zr O}-^{98}\text{Mo}_{1.061}$	29.2	$^{90}\text{Zr}(\text{p,t})^{88}\text{Zr}$	0.2	$^{88}\text{Nb}(\beta^+)^{88}\text{Zr}$
^{88}Nb	65.5	$^{88}\text{Nb O}-^{98}\text{Mo}_{1.061}$	34.5	$^{88}\text{Nb}(\beta^+)^{88}\text{Zr}$		
^{89}Rb	56.8	$^{89}\text{Rb}(\beta^-)^{89}\text{Sr}$	41.9	$^{89}\text{Rb}-^{85}\text{Rb}_{1.047}$	1.3	$^{91}\text{Rb}-^{93}\text{Rb}_{.489} \text{ } ^{89}\text{Rb}_{.511}$
^{89}Sr	100.0	$^{88}\text{Sr}(\text{n},\gamma)^{89}\text{Sr}$				
^{89}Y	63.2	$^{89}\text{Y}(\text{n},\gamma)^{90}\text{Y}$	16.2	$^{88}\text{Sr}(\text{p},\gamma)^{89}\text{Y}$	16.2	$^{89}\text{Y}(\text{p},\gamma)^{90}\text{Zr}$
^{89}Zr	80.9	$^{89}\text{Zr}(\beta^+)^{89}\text{Y}$	18.8	$^{90}\text{Zr}(\text{d,t})^{89}\text{Zr}$	0.3	$^{89}\text{Nb}(\beta^+)^{89}\text{Zr}$
^{89}Nb	77.7	$^{89}\text{Nb}-\text{u}$	22.3	$^{89}\text{Nb}(\beta^+)^{89}\text{Zr}$		
^{90}Rb	59.8	$^{90}\text{Rb}-^{85}\text{Rb}_{1.059}$	40.2	$^{90}\text{Rb}(\beta^-)^{90}\text{Sr}$		
^{90}Sr	97.3	$^{90}\text{Sr}(\beta^-)^{90}\text{Y}$	2.7	$^{90}\text{Rb}(\beta^-)^{90}\text{Sr}$		
^{90}Y	61.8	$^{90}\text{Y}(\beta^-)^{90}\text{Zr}$	36.7	$^{89}\text{Y}(\text{n},\gamma)^{90}\text{Y}$	1.5	$^{90}\text{Sr}(\beta^-)^{90}\text{Y}$
^{90}Zr	62.4	$^{90}\text{Zr}-^{87}\text{Rb}_{1.034}$	30.2	$^{90}\text{Zr}-\text{u}$	7.2	$^{90}\text{Zr}(\text{n},\gamma)^{91}\text{Zr}$
^{90}Nb	68.7	$^{90}\text{Nb}(\beta^+)^{90}\text{Zr}$	31.3	$^{90}\text{Mo}(\beta^+)^{90}\text{Nb}$		
^{90}Mo	62.6	$^{90}\text{Mo}-\text{C}_7 \text{H}_6$	37.4	$^{90}\text{Mo}(\beta^+)^{90}\text{Nb}$		
^{90}Ru	85.9	$^{90}\text{Ru}-^{85}\text{Rb}_{1.059}$	14.1	$^{90}\text{Ru}_{1.033}-\text{C}_7 \text{H}_9$		
^{91}Rb	70.1	$^{91}\text{Rb}-^{85}\text{Rb}_{1.071}$	18.4	$^{91}\text{Rb}(\beta^-)^{91}\text{Sr}$	11.5	$^{91}\text{Rb}-^{93}\text{Rb}_{.489} \text{ } ^{89}\text{Rb}_{.511}$
^{91}Sr	81.0	$^{91}\text{Sr}(\beta^-)^{91}\text{Y}$	11.1	$^{92}\text{Rb}(\beta^- \text{n})^{91}\text{Sr}$	8.0	$^{91}\text{Rb}(\beta^-)^{91}\text{Sr}$
^{91}Y	98.2	$^{91}\text{Y}(\beta^-)^{91}\text{Zr}$	1.8	$^{91}\text{Sr}(\beta^-)^{91}\text{Y}$		
^{91}Zr	39.4	$^{91}\text{Zr}(\text{n},\gamma)^{92}\text{Zr}$	34.8	$^{91}\text{Zr}-^{87}\text{Rb}_{1.046}$	20.2	$^{91}\text{Zr}-\text{u}$
^{91}Nb	97.7	$^{91}\text{Zr}(\text{p,n})^{91}\text{Nb}$	2.3	$^{91}\text{Mo}(\beta^+)^{91}\text{Nb}$		
^{91}Mo	65.1	$^{91}\text{Mo}-\text{C}_7 \text{H}_7$	23.5	$^{92}\text{Mo}(\text{p,d})^{91}\text{Mo}$	11.4	$^{91}\text{Mo}(\beta^+)^{91}\text{Nb}$
^{91}Tc	44.7	$^{91}\text{Tc}-\text{C}_7 \text{H}_7$	33.2	$^{91}\text{Tc}-^{94}\text{Mo}_{.968}$	22.1	$^{91}\text{Tc}-^{85}\text{Rb}_{1.071}$
^{91}Ru	37.4	$^{91}\text{Ru}-\text{C}_7 \text{H}_7$	36.9	$^{91}\text{Ru}-^{85}\text{Rb}_{1.071}$	25.7	$^{91}\text{Ru}-^{94}\text{Mo}_{.968}$
^{92}Rb	53.3	$^{92}\text{Rb}-^{85}\text{Rb}_{1.082}$	31.7	$^{92}\text{Rb}(\beta^-)^{92}\text{Sr}$	14.5	$^{92}\text{Rb}(\beta^- \text{n})^{91}\text{Sr}$
^{92}Sr	89.7	$^{92}\text{Sr}-^{85}\text{Rb}_{1.082}$	7.3	$^{92}\text{Rb}(\beta^-)^{92}\text{Sr}$	3.0	$^{92}\text{Sr}(\beta^-)^{92}\text{Y}$
^{92}Y	57.8	$^{92}\text{Y}(\beta^-)^{92}\text{Zr}$	28.8	$^{92}\text{Sr}(\beta^-)^{92}\text{Y}$	13.3	$^{94}\text{Zr}(\text{d},\alpha)^{92}\text{Y}$
^{92}Zr	37.2	$^{92}\text{Zr}-\text{u}$	35.4	$^{91}\text{Zr}(\text{n},\gamma)^{92}\text{Zr}$	27.3	$^{92}\text{Zr}-^{87}\text{Rb}_{1.057}$
^{92}Nb	72.7	$^{92}\text{Zr}(\text{p,n})^{92}\text{Nb}$	27.3	$^{93}\text{Nb}(\gamma,\text{n})^{92}\text{Nb}$		
^{92}Mo	87.2	$^{92}\text{Mo}-^{87}\text{Rb}_{1.057}$	12.8	$^{92}\text{Mo}-\text{u}$		
^{92}Tc	60.0	$^{92}\text{Tc}-^{85}\text{Rb}_{1.082}$	40.0	$^{92}\text{Tc}_{.989}-\text{C}_7 \text{H}_7$		
^{92}Ru	72.3	$^{92}\text{Ru}-^{85}\text{Rb}_{1.082}$	27.7	$^{92}\text{Ru}_{1.011}-\text{C}_7 \text{H}_9$		
^{93}Rb	70.7	$^{93}\text{Rb}-^{85}\text{Rb}_{1.094}$	26.5	$^{93}\text{Rb}(\beta^-)^{93}\text{Sr}$	2.5	$^{91}\text{Rb}-^{93}\text{Rb}_{.489} \text{ } ^{89}\text{Rb}_{.511}$
^{93}Sr	65.8	$^{93}\text{Sr}-^{85}\text{Rb}_{1.094}$	23.7	$^{93}\text{Rb}(\beta^-)^{93}\text{Sr}$	10.5	$^{93}\text{Sr}(\beta^-)^{93}\text{Y}$
^{93}Y	76.3	$^{93}\text{Y}(\beta^-)^{93}\text{Zr}$	23.7	$^{93}\text{Sr}(\beta^-)^{93}\text{Y}$		
^{93}Zr	97.6	$^{92}\text{Zr}(\text{n},\gamma)^{93}\text{Zr}$	2.4	$^{93}\text{Zr}(\beta^-)^{93}\text{Nb}$		
^{93}Nb	52.7	$^{93}\text{Zr}(\beta^-)^{93}\text{Nb}$	30.7	$^{93}\text{Nb}(\text{n},\gamma)^{94}\text{Nb}$	16.6	$^{93}\text{Nb}(\gamma,\text{n})^{92}\text{Nb}$
^{93}Ru	73.4	$^{93}\text{Ru}-\text{C}_7 \text{H}_9$	26.6	$^{93}\text{Ru}-^{85}\text{Rb}_{1.094}$		
^{93}Rh	55.1	$^{93}\text{Rh}-\text{C}_7 \text{H}_9$	44.9	$^{93}\text{Rh}-^{85}\text{Rb}_{1.094}$		

Table II. Influences on primary nuclides (continued, Explanation of Table on page 030003-74)

Nuclide	Infl.	Equation	Infl.	Equation	Infl.	Equation
⁹⁴ Rb	70.2	⁹⁴ Rb- ⁸⁵ Rb _{1.106}	29.6	⁹⁴ Rb- ⁸⁸ Rb _{1.068}	0.3	⁹⁴ Rb- ⁹⁵ Rb _{.660} ⁹² Rb _{.341}
⁹⁴ Sr	98.3	⁹⁴ Sr- ⁸⁵ Rb _{1.106}	1.7	⁹⁴ Sr(β ⁻) ⁹⁴ Y		
⁹⁴ Y	50.2	⁹⁴ Y(β ⁻) ⁹⁴ Zr	39.6	⁹⁴ Sr(β ⁻) ⁹⁴ Y	10.2	⁹⁶ Zr(d,α) ⁹⁴ Y
⁹⁴ Zr	77.2	⁹⁴ Zr-u	22.5	⁹⁴ Zr- ⁸⁷ Rb _{1.080}	0.3	⁹⁴ Zr(n,γ) ⁹⁵ Zr
⁹⁴ Nb	69.2	⁹³ Nb(n,γ) ⁹⁴ Nb	30.8	⁹⁴ Nb(β ⁻) ⁹⁴ Mo		
⁹⁴ Mo	67.9	⁹⁴ Mo(n,γ) ⁹⁵ Mo	18.7	⁹⁴ Mo- ⁸⁷ Rb _{1.080}	13.0	⁹⁴ Mo-u
⁹⁴ Ru	56.2	⁹⁴ Ru- ⁸⁵ Rb _{1.106}	43.8	⁹⁴ Ru-C ₇ H ₁₀		
⁹⁴ Rh	62.2	⁹⁴ Rh- ⁸⁵ Rb _{1.106}	37.8	⁹⁴ Rh-C ₇ H ₁₀		
⁹⁵ Rb	51.4	⁹⁵ Rb(β ⁻) ⁹⁵ Sr	25.5	⁹⁵ Rb- ⁹⁶ Rb _{.742} ⁹² Rb _{.258}	12.7	⁹⁴ Rb- ⁹⁵ Rb _{.660} ⁹² Rb _{.341}
⁹⁵ Sr	38.9	⁹⁵ Sr- ⁸⁵ Rb _{1.118}	38.9	⁹⁵ Sr- ⁹⁷ Zr _{.979}	20.1	⁹⁵ Sr(β ⁻) ⁹⁵ Y
⁹⁵ Y	56.2	⁹⁵ Y(β ⁻) ⁹⁵ Zr	32.3	⁹⁵ Sr(β ⁻) ⁹⁵ Y	11.5	⁹⁶ Zr(t,α) ⁹⁵ Y
⁹⁵ Zr	91.4	⁹⁴ Zr(n,γ) ⁹⁵ Zr	8.2	⁹⁵ Zr(β ⁻) ⁹⁵ Nb	0.4	⁹⁵ Y(β ⁻) ⁹⁵ Zr
⁹⁵ Nb	97.4	⁹⁵ Nb(β ⁻) ⁹⁵ Mo	2.6	⁹⁵ Zr(β ⁻) ⁹⁵ Nb		
⁹⁵ Mo	66.5	⁹⁵ Mo(n,γ) ⁹⁶ Mo	21.1	⁹⁴ Mo(n,γ) ⁹⁵ Mo	12.2	⁹⁵ Mo-u
⁹⁵ Tc	97.4	⁹⁵ Tc(β ⁺) ⁹⁵ Mo	2.6	⁹⁵ Ru(β ⁺) ⁹⁵ Tc		
⁹⁵ Ru	90.3	⁹⁶ Ru(p,d) ⁹⁵ Ru	9.7	⁹⁵ Ru(β ⁺) ⁹⁵ Tc		
⁹⁵ Rh	85.9	⁹⁵ Rh- ⁸⁵ Rb _{1.118}	14.1	⁹⁵ Rh _{.989} -C ₇ H ₁₀		
⁹⁶ Rb	99.7	⁹⁶ Rb- ⁸⁸ Rb _{1.091}	0.3	⁹⁵ Rb- ⁹⁶ Rb _{.742} ⁹² Rb _{.258}		
⁹⁶ Sr	82.6	⁹⁶ Sr- ⁹⁷ Zr _{.990}	17.4	⁹⁶ Sr(β ⁻) ⁹⁶ Y		
⁹⁶ Y	92.0	⁹⁶ Y- ⁹⁷ Zr _{.990}	8.0	⁹⁶ Sr(β ⁻) ⁹⁶ Y		
⁹⁶ Zr	52.2	⁹⁶ Zr-u	29.3	⁹⁶ Zr- ⁹⁶ Mo	13.0	⁹⁶ Zr- ⁸⁷ Rb _{1.103}
⁹⁶ Nb	62.8	⁹⁶ Zr- ⁹⁶ Nb	37.2	⁹⁶ Nb- ⁹⁶ Mo		
⁹⁶ Mo	46.1	⁹⁶ Zr- ⁹⁶ Mo	29.8	⁹⁵ Mo(n,γ) ⁹⁶ Mo	15.4	⁹⁶ Mo(n,γ) ⁹⁷ Mo
⁹⁶ Ru	100.0	⁹⁶ Ru- ⁹⁶ Mo				
⁹⁷ Rb	87.0	⁹⁷ Rb- ⁸⁵ Rb _{1.141}	13.0	⁹⁷ Rb- ⁸⁸ Rb _{1.102}		
⁹⁷ Sr	86.8	⁹⁷ Sr- ⁸⁵ Rb _{1.141}	13.2	⁹⁷ Sr- ⁹⁷ Zr		
⁹⁷ Zr	98.8	⁹⁶ Zr(n,γ) ⁹⁷ Zr	0.2	⁹⁷ Zr(β ⁻) ⁹⁷ Nb	0.2	⁹⁹ Sr- ⁹⁷ Zr _{1.021}
⁹⁷ Nb	50.1	⁹⁷ Nb(β ⁻) ⁹⁷ Mo	49.9	⁹⁷ Zr(β ⁻) ⁹⁷ Nb		
⁹⁷ Mo	43.8	⁹⁶ Mo(n,γ) ⁹⁷ Mo	24.1	⁹⁷ Mo-u	20.5	⁹⁷ Mo- ⁸⁷ Rb _{1.115}
⁹⁷ Tc	52.9	⁹⁶ Mo(³ He,d) ⁹⁷ Tc	47.1	⁹⁷ Mo(p,n) ⁹⁷ Tc		
⁹⁸ Rb	70.9	⁹⁸ Rb-u	29.1	⁹⁸ Rb- ⁸⁵ Rb _{1.153}		
⁹⁸ Sr	88.0	⁹⁸ Sr- ⁸⁵ Rb _{1.153}	12.0	⁹⁸ Sr- ⁹⁷ Zr _{1.010}		
⁹⁸ Zr	82.1	⁹⁸ Zr- ⁹⁷ Zr _{1.010}	17.9	⁹⁶ Zr(t,p) ⁹⁸ Zr		
⁹⁸ Mo	86.9	⁹⁷ Mo(n,γ) ⁹⁸ Mo	12.4	⁹⁸ Mo-u	0.6	⁹⁸ Mo(n,γ) ⁹⁹ Mo
⁹⁸ Tc	57.2	⁹⁹ Tc(p,d) ⁹⁸ Tc	29.2	⁹⁷ Mo(³ He,d) ⁹⁸ Tc	11.4	⁹⁸ Mo(p,n) ⁹⁸ Tc
⁹⁸ Ru	91.6	C ₇ H ₁₄ - ⁹⁸ Ru	8.4	⁹⁸ Tc(β ⁻) ⁹⁸ Ru		
⁹⁸ Pd	99.6	⁹⁸ Pd- ⁸⁵ Rb _{1.153}	0.4	⁹⁸ Ag(β ⁺) ⁹⁸ Pd		
⁹⁸ Ag	78.0	⁹⁸ Ag- ⁸⁵ Rb _{1.153}	22.0	⁹⁸ Ag(β ⁺) ⁹⁸ Pd		
⁹⁹ Sr	52.9	⁹⁹ Sr- ⁸⁵ Rb _{1.165}	47.1	⁹⁹ Sr- ⁹⁷ Zr _{1.021}		
⁹⁹ Zr	64.8	⁹⁹ Zr- ⁹⁷ Zr _{1.021}	35.2	⁹⁹ Zr-u		
⁹⁹ Mo	98.9	⁹⁸ Mo(n,γ) ⁹⁹ Mo	1.1	⁹⁹ Mo(β ⁻) ⁹⁹ Tc		
⁹⁹ Tc	78.2	⁹⁹ Mo(β ⁻) ⁹⁹ Tc	20.0	⁹⁹ Tc(β ⁻) ⁹⁹ Ru	1.8	⁹⁹ Tc(p,d) ⁹⁸ Tc
⁹⁹ Ru	97.6	⁹⁹ Ru(n,γ) ¹⁰⁰ Ru	2.4	⁹⁹ Tc(β ⁻) ⁹⁹ Ru		
⁹⁹ Rh	89.5	⁹⁹ Rh(β ⁺) ⁹⁹ Ru	10.5	⁹⁹ Pd(β ⁺) ⁹⁹ Rh		
⁹⁹ Pd	94.5	⁹⁹ Pd- ⁹⁶ Mo _{1.031}	5.5	⁹⁹ Pd(β ⁺) ⁹⁹ Rh		
¹⁰⁰ Sr	59.0	¹⁰⁰ Sr- ⁹⁷ Zr _{1.031}	41.0	¹⁰⁰ Sr- ⁸⁵ Rb _{1.176}		
¹⁰⁰ Zr	76.4	¹⁰⁰ Zr- ⁹⁷ Zr _{1.031}	23.6	¹⁰⁰ Zr-u		
¹⁰⁰ Mo	65.5	¹⁰⁰ Mo-u	32.3	¹⁰⁰ Mo- ⁸⁷ Rb _{1.149}	2.2	¹⁰⁰ Mo- ¹⁰⁰ Ru
¹⁰⁰ Ru	97.1	¹⁰⁰ Mo- ¹⁰⁰ Ru	2.4	⁹⁹ Ru(n,γ) ¹⁰⁰ Ru	0.5	¹⁰⁰ Ru(n,γ) ¹⁰¹ Ru
¹⁰⁰ Rh	82.1	¹⁰⁰ Rh(β ⁺) ¹⁰⁰ Ru	17.9	¹⁰⁰ Rh-u		
¹⁰⁰ Pd	54.0	¹⁰² Pd(p,t) ¹⁰⁰ Pd	46.0	⁹⁶ Ru(¹⁶ O, ¹² C) ¹⁰⁰ Pd		
¹⁰⁰ Cd	100.0	¹⁰⁰ Cd- ⁸⁵ Rb _{1.176}				

Table II. Influences on primary nuclides (continued, Explanation of Table on page 030003-74)

Nuclide	Infl.	Equation	Infl.	Equation	Infl.	Equation
^{100}In	63.0	$^{100}\text{In}(\beta^+)^{100}\text{Cd}$	37.0	$^{100}\text{In}-\text{u}$		
^{101}Zr	80.0	$^{101}\text{Zr}-^{97}\text{Zr}_{1.041}$	20.0	$^{101}\text{Zr}-\text{u}$		
^{101}Ru	99.3	$^{100}\text{Ru}(\text{n},\gamma)^{101}\text{Ru}$	0.7	$^{101}\text{Ru}(\text{n},\gamma)^{102}\text{Ru}$		
^{101}Rh	88.4	$^{101}\text{Pd}(\beta^+)^{101}\text{Rh}$	11.6	$^{103}\text{Rh}(\text{p},\text{t})^{101}\text{Rh}$		
^{101}Pd	93.2	$^{101}\text{Pd}-^{96}\text{Mo}_{1.052}$	6.8	$^{101}\text{Pd}(\beta^+)^{101}\text{Rh}$		
^{102}Zr	92.0	$^{102}\text{Zr}-^{97}\text{Zr}_{1.052}$	8.0	$^{102}\text{Zr}(\beta^-)^{102}\text{Nb}^m$		
^{102}Nb	99.4	$^{102}\text{Nb}-^{97}\text{Zr}_{1.052}$	0.6	$^{102}\text{Nb}^m-^{102}\text{Nb}$		
$^{102}\text{Nb}^m$	94.2	$^{102}\text{Nb}^m-^{102}\text{Nb}$	5.8	$^{102}\text{Zr}(\beta^-)^{102}\text{Nb}^m$		
^{102}Mo	82.7	$^{102}\text{Mo}-^{97}\text{Zr}_{1.052}$	17.3	$^{100}\text{Mo}(\text{t},\text{p})^{102}\text{Mo}$		
^{102}Tc	79.0	$^{104}\text{Ru}(\text{d},\alpha)^{102}\text{Tc}$	21.0	$^{100}\text{Mo}(^3\text{He},\text{p})^{102}\text{Tc}$		
^{102}Ru	99.3	$^{101}\text{Ru}(\text{n},\gamma)^{102}\text{Ru}$	0.7	$^{102}\text{Ru}(\text{n},\gamma)^{103}\text{Ru}$		
^{102}Pd	100.0	$^{102}\text{Pd}-^{102}\text{Ru}$				
^{102}Cd	88.2	$^{102}\text{Cd}-^{85}\text{Rb}_{1.200}$	11.8	$^{102}\text{Cd}-^{96}\text{Mo}_{1.063}$		
^{102}In	85.7	$^{102}\text{In}-^{96}\text{Mo}_{1.063}$	14.3	$^{102}\text{In}-^{85}\text{Rb}_{1.200}$		
^{103}Ru	99.2	$^{102}\text{Ru}(\text{n},\gamma)^{103}\text{Ru}$	0.8	$^{104}\text{Ru}(\text{d},\text{t})^{103}\text{Ru}-^{148}\text{Gd}()^{147}\text{Gd}$	0.1	$^{103}\text{Ru}(\beta^-)^{103}\text{Rh}$
^{103}Rh	98.4	$^{103}\text{Ru}(\beta^-)^{103}\text{Rh}$	1.6	$^{103}\text{Rh}(\text{p},\text{t})^{101}\text{Rh}$		
^{103}Cd	85.7	$^{103}\text{Cd}-^{85}\text{Rb}_{1.212}$	14.0	$^{103}\text{Cd}-^{96}\text{Mo}_{1.073}$	0.4	$^{103}\text{In}(\beta^+)^{103}\text{Cd}$
^{103}In	88.2	$^{103}\text{In}-^{85}\text{Rb}_{1.212}$	11.8	$^{103}\text{In}(\beta^+)^{103}\text{Cd}$		
^{104}Mo	97.2	$^{104}\text{Mo}-^{97}\text{Zr}_{1.072}$	2.8	$^{104}\text{Mo}(\beta^-)^{104}\text{Tc}$		
^{104}Tc	70.2	$^{104}\text{Mo}(\beta^-)^{104}\text{Tc}$	29.8	$^{104}\text{Tc}(\beta^-)^{104}\text{Ru}$		
^{104}Ru	57.7	$^{104}\text{Ru}(\text{d},\text{t})^{103}\text{Ru}-^{148}\text{Gd}()^{147}\text{Gd}$	30.9	$^{104}\text{Ru}(\text{n},\gamma)^{105}\text{Ru}$	10.0	$\text{C}_8\text{H}_8-^{104}\text{Ru}$
^{104}Cd	89.3	$^{104}\text{Cd}-^{85}\text{Rb}_{1.224}$	10.7	$^{104}\text{Cd}-^{96}\text{Mo}_{1.083}$		
^{104}Sn	92.9	$^{104}\text{Sn}-^{87}\text{Rb}_{1.195}$	7.1	$^{108}\text{Te}(\alpha)^{104}\text{Sn}$		
^{105}Mo	98.4	$^{105}\text{Mo}-^{97}\text{Zr}_{1.082}$	1.6	$^{105}\text{Mo}(\beta^-)^{105}\text{Tc}$		
^{105}Tc	59.0	$^{105}\text{Mo}(\beta^-)^{105}\text{Tc}$	41.0	$^{105}\text{Tc}(\beta^-)^{105}\text{Ru}$		
^{105}Ru	69.1	$^{104}\text{Ru}(\text{n},\gamma)^{105}\text{Ru}$	25.4	$^{105}\text{Ru}(\beta^-)^{105}\text{Rh}$	5.1	$^{106}\text{Ru}-^{105}\text{Ru}_{1.010}$
^{105}Rh	74.6	$^{105}\text{Rh}(\beta^-)^{105}\text{Pd}$	25.4	$^{105}\text{Ru}(\beta^-)^{105}\text{Rh}$		
^{105}Pd	96.0	$^{105}\text{Pd}(\text{n},\gamma)^{106}\text{Pd}$	3.9	$^{105}\text{Rh}(\beta^-)^{105}\text{Pd}$	0.2	$^{105}\text{Pd}(^3\text{He},\text{d})^{106}\text{Ag}$
^{105}Ag	91.1	$^{105}\text{Cd}(\beta^+)^{105}\text{Ag}$	8.9	$^{107}\text{Ag}(\text{p},\text{t})^{105}\text{Ag}$		
^{105}Cd	99.2	$^{105}\text{Cd}-^{85}\text{Rb}_{1.235}$	0.8	$^{105}\text{Cd}(\beta^+)^{105}\text{Ag}$		
^{105}Sn	58.0	$^{105}\text{Sn}-^{87}\text{Rb}_{1.207}$	36.1	$^{105}\text{Sn}-^{85}\text{Rb}_{1.235}$	6.0	$^{109}\text{Te}(\alpha)^{105}\text{Sn}$
^{106}Ru	63.3	$^{106}\text{Ru}(\beta^-)^{106}\text{Rh}$	36.7	$^{106}\text{Ru}-^{105}\text{Ru}_{1.010}$		
^{106}Rh	63.3	$^{106}\text{Rh}(\beta^-)^{106}\text{Pd}$	36.7	$^{106}\text{Ru}(\beta^-)^{106}\text{Rh}$		
^{106}Pd	69.9	$^{106}\text{Cd}-^{106}\text{Pd}$	20.2	$^{106}\text{Pd}-\text{u}$	5.2	$^{106}\text{Pd}(\text{n},\gamma)^{107}\text{Pd}$
^{106}Ag	81.0	$^{106}\text{Ag}(\epsilon)^{106}\text{Pd}$	12.3	$^{105}\text{Pd}(^3\text{He},\text{d})^{106}\text{Ag}$	6.6	$^{107}\text{Ag}(\text{p},\text{d})^{106}\text{Ag}$
^{106}Cd	43.3	$^{106}\text{Cd}-^{85}\text{Rb}_{1.247}$	29.9	$^{106}\text{Cd}-^{106}\text{Pd}$	26.8	$^{106}\text{Cd}-\text{u}$
^{106}Sn	51.7	$^{106}\text{Sn}-^{87}\text{Rb}_{1.218}$	39.5	$^{106}\text{Sn}-^{85}\text{Rb}_{1.247}$	8.8	$^{110}\text{Te}(\alpha)^{106}\text{Sn}$
^{107}Pd	93.7	$^{106}\text{Pd}(\text{n},\gamma)^{107}\text{Pd}$	6.3	$^{107}\text{Pd}(\beta^-)^{107}\text{Ag}$		
^{107}Ag	53.3	$^{107}\text{Pd}(\beta^-)^{107}\text{Ag}$	29.7	$^{107}\text{Cd}(\beta^+)^{107}\text{Ag}$	10.9	$\text{C}_8\text{H}_{11}-^{107}\text{Ag}$
^{107}Cd	88.5	$^{107}\text{Cd}-^{85}\text{Rb}_{1.259}$	11.5	$^{107}\text{Cd}(\beta^+)^{107}\text{Ag}$		
^{107}Sb	58.9	$^{107}\text{Sb}-^{87}\text{Rb}_{1.230}$	21.1	$^{107}\text{Sb}-^{133}\text{Cs}_{.805}$	20.0	$^{111}\text{I}(\alpha)^{107}\text{Sb}$
^{108}Pd	40.8	$^{108}\text{Pd}-^{108}\text{Cd}$	40.0	$^{108}\text{Pd}-\text{u}$	19.1	$^{108}\text{Pd}(\text{n},\gamma)^{109}\text{Pd}$
^{108}Cd	45.7	$^{108}\text{Pd}-^{108}\text{Cd}$	27.5	$^{108}\text{Cd}-^{85}\text{Rb}_{1.271}$	25.1	$^{108}\text{Cd}-\text{u}$
^{108}In	88.6	$^{108}\text{In}(\beta^+)^{108}\text{Cd}$	11.4	$^{108}\text{Sn}(\beta^+)^{108}\text{In}$		
^{108}Sn	95.9	$^{108}\text{Sn}-^{87}\text{Rb}_{1.241}$	4.1	$^{108}\text{Sn}(\beta^+)^{108}\text{In}$		
^{108}Te	93.7	$^{108}\text{Te}-^{87}\text{Rb}_{1.241}$	6.3	$^{108}\text{Te}(\alpha)^{104}\text{Sn}$		
^{109}Rh	64.3	$^{110}\text{Pd}(\text{d},^3\text{He})^{109}\text{Rh}$	35.7	$^{109}\text{Rh}-^{120}\text{Sn}_{.908}$		
^{109}Pd	80.6	$^{108}\text{Pd}(\text{n},\gamma)^{109}\text{Pd}$	19.4	$^{109}\text{Pd}(\beta^-)^{109}\text{Ag}$		
^{109}Ag	56.6	$^{109}\text{Ag}(\text{n},\gamma)^{110}\text{Ag}$	29.8	$^{109}\text{Pd}(\beta^-)^{109}\text{Ag}$	13.7	$^{109}\text{Cd}(\epsilon)^{109}\text{Ag}$
^{109}Cd	75.3	$^{109}\text{Cd}-^{85}\text{Rb}_{1.282}$	21.5	$^{109}\text{Cd}(\epsilon)^{109}\text{Ag}$	3.1	$^{109}\text{In}(\beta^+)^{109}\text{Cd}$
^{109}In	70.0	$^{108}\text{Cd}(^3\text{He},\text{d})^{109}\text{In}-^{110}\text{Cd}()^{111}\text{In}$	30.0	$^{109}\text{In}(\beta^+)^{109}\text{Cd}$		
^{109}Sn	77.9	$^{112}\text{Sn}(^3\text{He},^6\text{He})^{109}\text{Sn}$	22.1	$^{109}\text{Sb}(\beta^+)^{109}\text{Sn}$		

Table II. Influences on primary nuclides (continued, Explanation of Table on page 030003-74)

Nuclide	Infl.	Equation	Infl.	Equation	Infl.	Equation
^{109}Sb	91.8	$^{109}\text{Sb}-^{87}\text{Rb}_{1.253}$	8.2	$^{109}\text{Sb}(\beta^+)^{109}\text{Sn}$		
^{109}Te	54.0	$^{109}\text{Te}-^{87}\text{Rb}_{1.253}$	32.1	$^{109}\text{Te}-^{133}\text{Cs}_{820}$	7.4	$^{109}\text{Te}(\alpha)^{105}\text{Sn}$
^{110}Ru	97.2	$^{110}\text{Ru}-^{105}\text{Ru}_{1.048}$	2.8	$^{110}\text{Ru}(\beta^-)^{110}\text{Rh}$		
^{110}Rh	87.7	$^{110}\text{Rh}(\beta^-)^{110}\text{Pd}$	12.3	$^{110}\text{Ru}(\beta^-)^{110}\text{Rh}$		
^{110}Pd	71.4	$^{110}\text{Pd}-^{110}\text{Cd}$	28.0	$^{110}\text{Pd}-\text{u}$	0.5	$^{110}\text{Pd}(\text{d},^3\text{He})^{109}\text{Rh}$
^{110}Ag	56.7	$^{110}\text{Ag}(\beta^-)^{110}\text{Cd}$	43.3	$^{109}\text{Ag}(\text{n},\gamma)^{110}\text{Ag}$		
^{110}Cd	77.2	$^{110}\text{Cd}(\text{n},\gamma)^{111}\text{Cd}$	12.0	$^{110}\text{Cd}-\text{u}$	8.6	$^{110}\text{Pd}-^{110}\text{Cd}$
^{110}Te	84.0	$^{110}\text{Te}-^{133}\text{Cs}_{827}$	16.0	$^{110}\text{Te}(\alpha)^{106}\text{Sn}$		
^{111}Cd	80.7	$^{111}\text{Cd}(\text{n},\gamma)^{112}\text{Cd}$	19.3	$^{110}\text{Cd}(\text{n},\gamma)^{111}\text{Cd}$		
^{111}In	69.0	$^{113}\text{In}(\text{p},\text{t})^{111}\text{In}-^{112}\text{Cd}()$	19.3	$^{108}\text{Cd}(\text{d},^3\text{He},\text{d})^{109}\text{In}-^{110}\text{Cd}()$	11.7	$^{113}\text{In}(\text{p},\text{t})^{111}\text{In}-^{115}\text{In}()$
^{111}I	70.0	$^{111}\text{I}-^{87}\text{Rb}_{1.276}$	30.0	$^{111}\text{I}(\alpha)^{107}\text{Sb}$		
^{112}Rh	65.7	$^{112}\text{Rh}(\beta^-)^{112}\text{Pd}$	18.5	$^{112}\text{Rh}-^{120}\text{Sn}_{933}$	15.8	$^{112}\text{Rh}-\text{u}$
^{112}Pd	88.8	$^{112}\text{Pd}-^{120}\text{Sn}_{933}$	10.7	$^{110}\text{Pd}(\text{t},\text{p})^{112}\text{Pd}$	0.5	$^{112}\text{Rh}(\beta^-)^{112}\text{Pd}$
^{112}Cd	48.4	$^{113}\text{In}-^{112}\text{Cd}_{1.009}$	35.2	$^{113}\text{Cd}-^{112}\text{Cd}_{1.009}$	8.3	$^{111}\text{Cd}(\text{n},\gamma)^{112}\text{Cd}$
^{112}In	50.0	$^{112}\text{Cd}(\text{p},\text{n})^{112}\text{In}$	50.0	$^{112}\text{In}(\beta^-)^{112}\text{Sn}$		
^{112}Sn	97.2	$^{112}\text{Sn}-^{112}\text{Cd}$	2.1	$^{112}\text{Sn}-^{120}\text{Sn}_{933}$	0.7	$^{112}\text{Sn}(\text{n},\gamma)^{113}\text{Sn}$
^{113}Ru	80.6	$^{113}\text{Ru}-^{105}\text{Ru}_{1.076}$	19.4	$^{113}\text{Ru}-\text{u}$		
^{113}Cd	59.5	$^{113}\text{Cd}-^{115}\text{In}_{983}$	29.7	$^{113}\text{Cd}-^{112}\text{Cd}_{1.009}$	5.4	$^{113}\text{Cd}(\text{n},\gamma)^{114}\text{Cd}$
^{113}In	77.1	$^{113}\text{In}-^{115}\text{In}_{983}$	16.6	$^{113}\text{In}-^{112}\text{Cd}_{1.009}$	6.2	$^{113}\text{In}(\text{n},\gamma)^{114}\text{In}$
^{113}Sn	69.3	$^{112}\text{Sn}(\text{n},\gamma)^{113}\text{Sn}$	16.7	$^{113}\text{Sn}(\beta^+)^{113}\text{In}$	14.1	$^{114}\text{Sn}(\text{d},\text{t})^{113}\text{Sn}$
^{113}Xe	82.2	$^{113}\text{Xe}-^{133}\text{Cs}_{850}$	17.8	$^{113}\text{Xe}(\alpha)^{109}\text{Te}$		
^{114}Rh	59.0	$^{114}\text{Rh}-^{120}\text{Sn}_{950}$	41.0	$^{114}\text{Rh}-\text{u}$		
^{114}Cd	92.9	$^{113}\text{Cd}(\text{n},\gamma)^{114}\text{Cd}$	7.1	$^{116}\text{Cd}-^{35}\text{Cl}-^{114}\text{Cd}-^{37}\text{Cl}$		
^{114}In	81.9	$^{113}\text{In}(\text{n},\gamma)^{114}\text{In}$	18.1	$^{114}\text{In}(\beta^-)^{114}\text{Sn}$		
^{114}Sn	99.9	$^{114}\text{Sn}(\text{n},\gamma)^{115}\text{Sn}$	0.1	$^{114}\text{In}(\beta^-)^{114}\text{Sn}$		
^{114}Sb	61.1	$^{114}\text{Sb}-\text{u}$	38.9	$^{114}\text{Sn}(\text{p},\text{n})^{114}\text{Sb}$		
^{115}Pd	93.6	$^{115}\text{Pd}-^{120}\text{Sn}_{958}$	6.4	$^{115}\text{Pd}(\beta^-)^{115}\text{Ag}$		
^{115}Ag	66.8	$^{115}\text{Ag}-^{133}\text{Cs}_{865}$	20.9	$^{115}\text{Ag}(\beta^-)^{115}\text{Cd}$	12.4	$^{115}\text{Pd}(\beta^-)^{115}\text{Ag}$
^{115}Cd	100.0	$^{114}\text{Cd}(\text{d},\text{p})^{115}\text{Cd}$				
^{115}In	100.0	$^{115}\text{In}-^{129}\text{Xe}$				
^{115}Sn	100.0	$^{115}\text{In}-^{115}\text{Sn}$				
^{116}Rh	62.8	$^{116}\text{Rh}-^{120}\text{Sn}_{967}$	37.2	$^{116}\text{Rh}-\text{u}$		
^{116}Cd	97.8	$^{116}\text{Cd}-^{116}\text{Sn}$	2.2	$^{116}\text{Cd}-^{35}\text{Cl}-^{114}\text{Cd}-^{37}\text{Cl}$		
^{116}Sn	99.1	$^{115}\text{Sn}(\text{n},\gamma)^{116}\text{Sn}$	0.8	$^{116}\text{Cd}-^{116}\text{Sn}$	0.1	$^{116}\text{Sn}(\text{n},\gamma)^{117}\text{Sn}$
^{116}Sb	75.2	$^{116}\text{Sn}(\text{p},\text{n})^{116}\text{Sb}$	24.8	$^{115}\text{Sn}(\text{d},^3\text{He},\text{d})^{116}\text{Sb}-^{120}\text{Sn}()$		
^{117}Pd	95.8	$^{117}\text{Pd}-^{120}\text{Sn}_{975}$	4.2	$^{117}\text{Pd}(\beta^-)^{117}\text{Ag}$		
^{117}Ag	82.9	$^{117}\text{Ag}-^{133}\text{Cs}_{880}$	17.1	$^{117}\text{Pd}(\beta^-)^{117}\text{Ag}$		
^{117}In	94.3	$^{117}\text{In}(\beta^-)^{117}\text{Sn}$	5.7	$^{120}\text{Sn}(\text{t},\alpha)^{119}\text{In}-^{118}\text{Sn}()$		
^{117}Sn	96.8	$^{116}\text{Sn}(\text{n},\gamma)^{117}\text{Sn}$	3.1	$^{117}\text{Sn}(\text{n},\gamma)^{118}\text{Sn}$		
^{117}Sb	71.2	$^{116}\text{Sn}(\text{d},^3\text{He},\text{d})^{117}\text{Sb}$	17.8	$^{117}\text{Sn}(\text{p},\text{n})^{117}\text{Sb}$	11.0	$^{117}\text{Te}(\beta^+)^{117}\text{Sb}$
^{117}Te	50.7	$^{117}\text{Te}(\beta^+)^{117}\text{Sb}$	46.4	$^{117}\text{Te}-\text{u}$	2.9	$^{117}\text{I}(\beta^+)^{117}\text{Te}$
^{117}I	87.9	$^{117}\text{I}-\text{u}$	12.1	$^{117}\text{I}(\beta^+)^{117}\text{Te}$		
^{118}Pd	61.3	$^{118}\text{Pd}-^{120}\text{Sn}_{983}$	38.7	$^{118}\text{Pd}-^{129}\text{Xe}_{915}$		
^{118}In	100.0	$^{119}\text{Sn}(\text{t},\alpha)^{118}\text{In}-^{118}\text{Sn}()$				
^{118}Sn	96.7	$^{117}\text{Sn}(\text{n},\gamma)^{118}\text{Sn}$	3.3	$^{118}\text{Sn}(\text{n},\gamma)^{119}\text{Sn}$		
^{119}Ag	97.3	$^{119}\text{Ag}-^{133}\text{Cs}_{895}$	2.7	$^{119}\text{Ag}(\beta^-)^{119}\text{Cd}$		
^{119}Cd	78.0	$^{119}\text{Ag}(\beta^-)^{119}\text{Cd}$	22.0	$^{119}\text{Cd}(\beta^-)^{119}\text{In}$		
^{119}In	86.2	$^{120}\text{Sn}(\text{t},\alpha)^{119}\text{In}-^{118}\text{Sn}()$	13.1	$^{120}\text{Sn}(\text{d},^3\text{He})^{119}\text{In}$	0.6	$^{119}\text{Cd}(\beta^-)^{119}\text{In}$
^{119}Sn	92.5	$^{118}\text{Sn}(\text{n},\gamma)^{119}\text{Sn}$	7.3	$^{120}\text{Sn}(\text{d},\text{t})^{119}\text{Sn}$	0.1	$^{119}\text{Sb}(\epsilon)^{119}\text{Sn}$
^{119}Sb	59.1	$^{118}\text{Sn}(\text{d},^3\text{He},\text{d})^{119}\text{Sb}$	40.9	$^{119}\text{Sb}(\epsilon)^{119}\text{Sn}$		
^{120}Pd	68.8	$^{120}\text{Pd}-^{120}\text{Sn}$	31.2	$^{120}\text{Pd}-^{129}\text{Xe}_{930}$		
^{120}Sn	21.7	$^{112}\text{Sn}-^{120}\text{Sn}_{933}$	21.2	$^{115}\text{Sn}-^{120}\text{Sn}_{958}$	18.6	$^{129}\text{Xe}-^{120}\text{Sn}_{1.075}$

Table II. Influences on primary nuclides (continued, Explanation of Table on page 030003-74)

Nuclide	Infl.	Equation	Infl.	Equation	Infl.	Equation
^{120}Te	80.2	$^{122}\text{Te}(p,t)^{120}\text{Te}-^{132}\text{Ba}()^{130}\text{Ba}$	19.6	$^{122}\text{Te}(p,t)^{120}\text{Te}-^{144}\text{Sm}()^{142}\text{Sm}$	0.2	$^{120}\text{Te}(\beta^+)^{121}\text{I}$
^{121}Sn	96.7	$^{120}\text{Sn}(n,\gamma)^{121}\text{Sn}$	3.3	$^{122}\text{Sn}(d,t)^{121}\text{Sn}$		
^{121}Sb	95.1	$^{121}\text{Sb}(n,\gamma)^{122}\text{Sb}$	4.8	$^{115}\text{Sn}(\beta^+)^{116}\text{Sb}-^{120}\text{Sn}()^{121}\text{Sb}$	0.1	$^{121}\text{Te}(\beta^+)^{121}\text{Sb}$
^{121}Te	73.6	$^{121}\text{Te}(\beta^+)^{121}\text{Sb}$	26.4	$^{121}\text{I}(\beta^+)^{121}\text{Te}$		
^{121}I	99.2	$^{120}\text{Te}(\beta^+)^{121}\text{I}$	0.8	$^{121}\text{I}(\beta^+)^{121}\text{Te}$		
^{121}Xe	85.0	$^{121}\text{Xe}-^{133}\text{Cs}_{910}$	15.0	$^{121}\text{Cs}(\beta^+)^{121}\text{Xe}$		
^{121}Cs	46.0	$^{121}\text{Cs}(\beta^+)^{121}\text{Xe}$	37.7	$^{121}\text{Cs}-^{133}\text{Cs}_{910}$	16.3	$^{121}\text{Cs}-u$
^{122}Cd	72.4	$^{122}\text{Cd}-^{130}\text{Xe}_{938}$	27.6	$^{122}\text{Cd}-^{133}\text{Cs}_{917}$		
^{122}Sn	56.8	$^{122}\text{Sn}(d,t)^{121}\text{Sn}$	43.2	$^{122}\text{Sn}(n,\gamma)^{123}\text{Sn}$		
^{122}Sb	67.2	$^{122}\text{Sb}(\beta^-)^{122}\text{Te}$	27.8	$^{123}\text{Sb}(\gamma,n)^{122}\text{Sb}$	4.9	$^{121}\text{Sb}(n,\gamma)^{122}\text{Sb}$
^{122}Te	98.3	$^{122}\text{Te}(n,\gamma)^{123}\text{Te}$	1.1	$^{122}\text{Sb}(\beta^-)^{122}\text{Te}$	0.6	$^{122}\text{Te}(\beta^+)^{123}\text{I}$
^{122}Cs	56.8	$^{122}\text{Cs}-^{133}\text{Cs}_{917}$	43.2	$^{122}\text{Cs}-u$		
^{123}Cd	99.6	$^{123}\text{Cd}-^{130}\text{Xe}_{946}$	0.4	$^{123}\text{Cd}(\beta^-)^{123}\text{In}$		
^{123}In	43.4	$^{123}\text{In}(\beta^-)^{123}\text{Sn}$	31.9	$^{123}\text{Cd}(\beta^-)^{123}\text{In}$	24.7	$^{124}\text{Sn}(d,\beta^+)^{123}\text{In}$
^{123}Sn	50.5	$^{122}\text{Sn}(n,\gamma)^{123}\text{Sn}$	38.5	$^{124}\text{Sn}(d,t)^{123}\text{Sn}$	10.7	$^{123}\text{Sn}(\beta^-)^{123}\text{Sb}$
^{123}Sb	96.0	$^{123}\text{Te}-^{123}\text{Sb}$	3.5	$^{123}\text{Sn}(\beta^-)^{123}\text{Sb}$	0.5	$^{123}\text{Sb}(\gamma,n)^{122}\text{Sb}$
^{123}Te	94.4	$^{123}\text{Te}(n,\gamma)^{124}\text{Te}$	3.9	$^{123}\text{Te}-^{123}\text{Sb}$	1.7	$^{122}\text{Te}(n,\gamma)^{123}\text{Te}$
^{123}I	96.2	$^{122}\text{Te}(\beta^+)^{123}\text{I}$	3.8	$^{123}\text{Xe}(\beta^+)^{123}\text{I}$		
^{123}Xe	62.0	$^{123}\text{Xe}-^{133}\text{Cs}_{925}$	38.0	$^{123}\text{Xe}(\beta^+)^{123}\text{I}$		
^{124}Cd	89.4	$^{124}\text{Cd}-^{130}\text{Xe}_{954}$	10.3	$^{124}\text{Cd}-^{133}\text{Cs}_{932}$	0.2	$^{124}\text{Cd}(\beta^-)^{124}\text{In}$
^{124}In	61.1	$^{124}\text{Cd}(\beta^-)^{124}\text{In}$	38.9	$^{124}\text{In}(\beta^-)^{124}\text{Sn}$		
^{124}Sn	37.2	$^{124}\text{Sn}-^{13}\text{C }^{37}\text{Cl}_3$	26.9	$^{124}\text{Sn}-^{129}\text{Xe}_{961}$	20.3	$^{124}\text{Sn}-^{120}\text{Sn}_{1,033}$
^{124}Te	40.7	$^{124}\text{Sn}-^{124}\text{Te}$	26.1	$^{124}\text{Te}-^{13}\text{C }^{37}\text{Cl}_3$	16.8	$^{124}\text{Te}(n,\gamma)^{125}\text{Te}$
^{124}Xe	58.9	$^{124}\text{Xe}-^{54}\text{Fe }^{35}\text{Cl}_2$	23.7	$^{124}\text{Xe}-^{13}\text{C }^{37}\text{Cl}_3$	16.3	$^{124}\text{Xe}-^{124}\text{Te}$
^{125}Cd	99.8	$^{125}\text{Cd}-^{130}\text{Xe}_{962}$	0.2	$^{125}\text{Cd}(\beta^-)^{125}\text{In}$		
^{125}In	81.0	$^{125}\text{In}(\beta^-)^{125}\text{Sn}$	19.0	$^{125}\text{Cd}(\beta^-)^{125}\text{In}$		
^{125}Sn	100.0	$^{124}\text{Sn}(n,\gamma)^{125}\text{Sn}$				
^{125}Te	83.1	$^{124}\text{Te}(n,\gamma)^{125}\text{Te}$	16.9	$^{125}\text{Te}(n,\gamma)^{126}\text{Te}$		
^{125}Xe	98.8	$^{124}\text{Xe}(n,\gamma)^{125}\text{Xe}$	1.2	$^{125}\text{Cs}(\beta^+)^{125}\text{Xe}$		
^{125}Cs	70.5	$^{125}\text{Cs}-^{133}\text{Cs}_{940}$	29.5	$^{125}\text{Cs}(\beta^+)^{125}\text{Xe}$		
^{125}Ba	97.9	$^{125}\text{Ba}-^{133}\text{Cs}_{940}$	2.1	$^{125}\text{La}(\beta^+)^{125}\text{Ba}$		
^{125}La	86.5	$^{125}\text{La}-u$	13.5	$^{125}\text{La}(\beta^+)^{125}\text{Ba}$		
^{126}Cd	64.9	$^{126}\text{Cd}-^{130}\text{Xe}_{969}$	34.9	$^{126}\text{Cd}-^{133}\text{Cs}_{947}$	0.2	$^{126}\text{Cd}(\beta^-)^{126}\text{In}$
^{126}In	55.7	$^{126}\text{Cd}(\beta^-)^{126}\text{In}$	44.3	$^{126}\text{In}(\beta^-)^{126}\text{Sn}$		
^{126}Sn	96.1	$^{124}\text{Sn}(t,p)^{126}\text{Sn}$	3.9	$^{126}\text{In}(\beta^-)^{126}\text{Sn}$		
^{126}Te	83.1	$^{125}\text{Te}(n,\gamma)^{126}\text{Te}$	12.3	$^{128}\text{Te }^{35}\text{Cl}-^{126}\text{Te }^{37}\text{Cl}$	2.5	$^{126}\text{I}(\beta^+)^{126}\text{Te}$
^{126}I	51.5	$^{126}\text{I}(\beta^+)^{126}\text{Te}$	48.5	$^{127}\text{I}(\gamma,n)^{126}\text{I}$		
^{126}Xe	97.8	$^{126}\text{Xe}-^{134}\text{Xe}_{940}$	2.2	$^{126}\text{Cs}(\beta^+)^{126}\text{Xe}$		
^{126}Cs	73.8	$^{126}\text{Cs}-^{133}\text{Cs}_{947}$	26.2	$^{126}\text{Cs}(\beta^+)^{126}\text{Xe}$		
$^{127}\text{Cd}^m$	60.9	$^{127}\text{Cd}^m-^{133}\text{Cs}_{955}$	37.6	$^{127}\text{Cd}^m-^{130}\text{Xe}_{977}$	1.4	$^{127}\text{Cd}^m(\beta^-)^{127}\text{In}$
^{127}In	88.9	$^{127}\text{In}(\beta^-)^{127}\text{Sn}$	11.1	$^{127}\text{Cd}^m(\beta^-)^{127}\text{In}$		
^{127}Sn	81.0	$^{127}\text{Sn }^{34}\text{S}-^{133}\text{Cs}_{1,211}$	16.8	$^{127}\text{Sn}(\beta^-)^{127}\text{Sb}$	2.3	$^{127}\text{In}(\beta^-)^{127}\text{Sn}$
^{127}Sb	96.2	$^{127}\text{Sb}(\beta^-)^{127}\text{Te}$	3.8	$^{127}\text{Sn}(\beta^-)^{127}\text{Sb}$		
^{127}Te	97.9	$^{126}\text{Te}(n,\gamma)^{127}\text{Te}$	1.8	$^{127}\text{Te}(\beta^-)^{127}\text{I}$	0.3	$^{127}\text{Sb}(\beta^-)^{127}\text{Te}$
^{127}I	35.0	$^{127}\text{I}(\gamma,n)^{126}\text{I}$	23.8	$^{127}\text{Te}(\beta^-)^{127}\text{I}$	21.2	$\text{C}_{10}\text{H}_7-^{127}\text{I}$
^{127}Xe	91.1	$^{127}\text{Xe}(\epsilon)^{127}\text{I}$	8.9	$^{127}\text{Cs}(\beta^+)^{127}\text{Xe}$		
^{127}Cs	81.7	$^{127}\text{Cs}-^{133}\text{Cs}_{955}$	18.3	$^{127}\text{Cs}(\beta^+)^{127}\text{Xe}$		
^{127}Ba	97.7	$^{127}\text{Ba}-^{133}\text{Cs}_{955}$	2.3	$^{127}\text{La}(\beta^+)^{127}\text{Ba}$		
^{127}La	86.6	$^{127}\text{La}-u$	13.4	$^{127}\text{La}(\beta^+)^{127}\text{Ba}$		
^{128}Cd	50.0	$^{128}\text{Cd}-^{133}\text{Cs}_{962}$	50.0	$^{128}\text{Cd}-^{130}\text{Xe}_{985}$		
^{128}In	72.0	$^{128}\text{In}(\beta^-)^{128}\text{Sn}$	28.0	$^{128}\text{Cd}(\beta^-)^{128}\text{In}$		
^{128}Sn	57.5	$^{128}\text{Sn}-u$	42.2	$^{128}\text{Sn}(\beta^-)^{128}\text{Sb}^m$	0.3	$^{128}\text{In}(\beta^-)^{128}\text{Sn}$

Table II. Influences on primary nuclides (continued, Explanation of Table on page 030003-74)

Nuclide	Infl.	Equation	Infl.	Equation	Infl.	Equation
$^{128}\text{Sb}^m$	54.9	$^{128}\text{Sb}^m(\beta^-)^{128}\text{Te}$	45.1	$^{128}\text{Sn}(\beta^-)^{128}\text{Sb}^m$		
^{128}Te	73.8	$^{130}\text{Te} \text{ } ^{35}\text{Cl} - ^{128}\text{Te} \text{ } ^{37}\text{Cl}$	20.7	$^{128}\text{Te} - ^{128}\text{Xe}$	3.7	$^{128}\text{Te} \text{ } ^{35}\text{Cl} - ^{126}\text{Te} \text{ } ^{37}\text{Cl}$
^{128}I	86.9	$^{127}\text{I}(\text{n},\gamma)^{128}\text{I}$	13.1	$^{128}\text{I}(\beta^-)^{128}\text{Xe}$		
^{128}Xe	56.1	$^{128}\text{Te} - ^{128}\text{Xe}$	42.3	$\text{C}_{10} \text{H}_8 - ^{128}\text{Xe}$	0.9	$^{128}\text{I}(\beta^-)^{128}\text{Xe}$
^{128}Cs	79.8	$^{128}\text{Cs}(\beta^+)^{128}\text{Xe}$	20.2	$^{128}\text{Cs} - ^{133}\text{Cs}_{,962}$		
^{128}Ba	78.1	$^{130}\text{Ba}(\text{p},\text{t})^{128}\text{Ba} - ^{144}\text{Sm}()^{142}\text{Sm}$	21.9	$^{128}\text{Ba} - ^{133}\text{Cs}_{,962}$		
^{129}In	99.4	$^{129}\text{In} - ^{130}\text{Xe}_{,992}$	0.6	$^{129}\text{In}(\beta^-)^{129}\text{Sn}$		
$^{129}\text{In}^m$	99.4	$^{129}\text{In}^m - ^{130}\text{Xe}_{,992}$	0.6	$^{129}\text{In}^m(\beta^-)^{129}\text{Sn}$		
^{129}Sn	43.7	$^{129}\text{In}(\beta^-)^{129}\text{Sn}$	35.8	$^{129}\text{Sn} - \text{u}$	20.5	$^{129}\text{In}^m(\beta^-)^{129}\text{Sn}$
^{129}Te	98.2	$^{128}\text{Te}(\text{n},\gamma)^{129}\text{Te}$	1.8	$^{129}\text{Te}(\beta^-)^{129}\text{I}$		
^{129}I	59.9	$^{129}\text{Te}(\beta^-)^{129}\text{I}$	40.1	$^{129}\text{I}(\beta^-)^{129}\text{Xe}$		
^{129}Xe	28.3	$^{132}\text{Xe} - ^{129}\text{Xe}$	15.1	$\text{C}_{10} \text{H}_{10} - ^{129}\text{Xe}$	14.1	$^{129}\text{Xe}_2 - ^{86}\text{Kr}_3$
^{129}Cs	83.0	$^{129}\text{Cs}(\beta^+)^{129}\text{Xe}$	12.2	$^{129}\text{Cs} - ^{133}\text{Cs}_{,970}$	4.8	$^{129}\text{Ba}(\beta^+)^{129}\text{Cs}$
^{129}Ba	48.3	$^{130}\text{Ba}(\text{d},\text{t})^{129}\text{Ba}$	45.3	$^{129}\text{Ba}(\beta^+)^{129}\text{Cs}$	6.4	$^{129}\text{La}(\beta^+)^{129}\text{Ba}$
^{129}La	58.4	$^{129}\text{La} - \text{u}$	41.6	$^{129}\text{La}(\beta^+)^{129}\text{Ba}$		
^{130}Sn	73.3	$^{130}\text{Sn} - ^{130}\text{Xe}$	26.6	$^{130}\text{Sn} - ^{133}\text{Cs}_{,977}$	0.2	$^{130}\text{Sn}(\beta^-)^{130}\text{Sb}$
^{130}Sb	90.0	$^{130}\text{Sn}(\beta^-)^{130}\text{Sb}$	10.0	$^{130}\text{Sb}(\beta^-)^{130}\text{Te}$		
^{130}Te	77.5	$^{130}\text{Te} - ^{129}\text{Xe}$	22.5	$^{130}\text{Te} - ^{130}\text{Xe}$		
^{130}Xe	49.5	$^{130}\text{Xe} - ^{129}\text{Xe}$	38.0	$^{132}\text{Xe} - ^{130}\text{Xe}$	12.5	$^{130}\text{Te} - ^{130}\text{Xe}$
^{130}Cs	47.6	$^{130}\text{Cs} - ^{133}\text{Cs}_{,977}$	34.9	$^{130}\text{Cs}(\beta^+)^{130}\text{Xe}$	17.5	$^{129}\text{Xe}(\text{}^3\text{He},\text{d})^{130}\text{Cs}$
^{130}Ba	65.0	$^{130}\text{Ba} - ^{85}\text{Rb}_{1,529}$	18.0	$^{122}\text{Te}(\text{p},\text{t})^{120}\text{Te} - ^{132}\text{Ba}()^{130}\text{Ba}$	10.3	$^{130}\text{Ba}(\text{p},\text{t})^{128}\text{Ba} - ^{144}\text{Sm}()^{142}\text{Sm}$
^{131}Sn	80.9	$^{131}\text{Sn} \text{ } ^{34}\text{S} - ^{133}\text{Cs}_{1,241}$	19.1	$^{131}\text{Sn}(\beta^-)^{131}\text{Sb}$		
^{131}Sb	94.6	$^{131}\text{Sb} - ^{130}\text{Xe}_{1,008}$	5.4	$^{131}\text{Sn}(\beta^-)^{131}\text{Sb}$		
^{131}Xe	62.0	$^{131}\text{Xe} - ^{129}\text{Xe}_{1,016}$	38.0	$^{131}\text{Xe} - ^{132}\text{Xe}_{,992}$		
^{131}Cs	60.5	$^{131}\text{Cs}(\text{e})^{131}\text{Xe}$	25.0	$^{131}\text{Ba}(\beta^+)^{131}\text{Cs}$	14.6	$^{131}\text{Cs} - ^{133}\text{Cs}_{,985}$
^{131}Ba	94.7	$^{130}\text{Ba}(\text{n},\gamma)^{131}\text{Ba}$	5.3	$^{131}\text{Ba}(\beta^+)^{131}\text{Cs}$		
^{131}Ce	95.7	$^{131}\text{Ce} - \text{u}$	4.3	$^{131}\text{Pr}(\beta^+)^{131}\text{Ce}$		
^{131}Pr	81.2	$^{131}\text{Pr} - \text{u}$	9.5	$^{131}\text{Nd}(\beta^+)^{131}\text{Pr}$	9.3	$^{131}\text{Pr}(\beta^+)^{131}\text{Ce}$
^{131}Nd	97.0	$^{131}\text{Nd} - \text{u}$	3.0	$^{131}\text{Nd}(\beta^+)^{131}\text{Pr}$		
^{132}Sn	61.1	$^{132}\text{Sn} - ^{133}\text{Cs}_{,992}$	38.9	$^{132}\text{Sn} - ^{132}\text{Xe}$		
^{132}Sb	83.4	$^{132}\text{Sb} - ^{130}\text{Xe}_{1,015}$	16.6	$^{132}\text{Sb} - ^{133}\text{Cs}_{,992}$		
^{132}Te	75.8	$^{132}\text{Te} - ^{130}\text{Xe}_{1,015}$	24.2	$^{132}\text{Te}(\beta^-)^{132}\text{I}$		
^{132}I	51.6	$^{132}\text{Te}(\beta^-)^{132}\text{I}$	48.4	$^{132}\text{I}(\beta^-)^{132}\text{Xe}$		
^{132}Xe	33.3	$^{132}\text{Xe} - \text{C}_{10} \text{H}_{10}$	19.5	$^{132}\text{Xe} - ^{129}\text{Xe}$	15.3	$^{132}\text{Xe} - \text{C}_3 \text{O}_6$
^{132}Cs	73.2	$^{132}\text{Cs} - ^{133}\text{Cs}_{,992}$	26.8	$^{133}\text{Cs}(\gamma,\text{n})^{132}\text{Cs}$		
^{132}Ba	98.3	$^{132}\text{Ba}(\text{n},\gamma)^{133}\text{Ba}$	1.7	$^{122}\text{Te}(\text{p},\text{t})^{120}\text{Te} - ^{132}\text{Ba}()^{130}\text{Ba}$		
^{132}La	66.1	$^{132}\text{La}(\beta^+)^{132}\text{Ba}$	33.9	$^{132}\text{La} - \text{u}$		
^{132}Ce	53.5	$^{132}\text{Ce} - \text{u}$	46.5	$^{132}\text{Ce} \text{ O} - ^{142}\text{Sm}_{1,042}$		
^{133}Sn	72.5	$^{133}\text{Sn} - ^{134}\text{Xe}_{,993}$	27.5	$^{133}\text{Sn} - ^{133}\text{Cs}$		
^{133}Sb	70.5	$^{133}\text{Sb} - ^{130}\text{Xe}_{1,023}$	18.3	$^{133}\text{Sb}(\beta^-)^{133}\text{Te}$	11.3	$^{133}\text{Sb} - ^{136}\text{Xe}_{,978}$
^{133}Te	93.0	$^{133}\text{Te} - ^{130}\text{Xe}_{1,023}$	7.0	$^{133}\text{Sb}(\beta^-)^{133}\text{Te}$		
^{133}Cs	45.2	$^{133}\text{Cs} - ^{132}\text{Xe}$	44.0	$^{133}\text{Cs} - ^{129}\text{Xe}$	10.8	$^{133}\text{Cs} - \text{C}_3 \text{O}_6$
^{133}Ba	98.5	$^{133}\text{Ba}(\text{e})^{133}\text{Cs}$	1.5	$^{132}\text{Ba}(\text{n},\gamma)^{133}\text{Ba}$		
^{134}Te	71.0	$^{134}\text{Te} - ^{130}\text{Xe}_{1,031}$	20.6	$^{134}\text{Te} - ^{136}\text{Xe}_{,985}$	8.5	$^{134}\text{Te}(\beta^-)^{134}\text{I}$
^{134}I	58.8	$^{134}\text{I} - ^{133}\text{Cs}_{1,008}$	41.2	$^{134}\text{Te}(\beta^-)^{134}\text{I}$		
^{134}Xe	100.0	$^{134}\text{Xe} - ^{132}\text{Xe}_{1,015}$				
^{134}Cs	99.9	$^{133}\text{Cs}(\text{n},\gamma)^{134}\text{Cs}$	0.1	$^{134}\text{Cs}(\beta^-)^{134}\text{Ba}$		
^{134}Ba	57.7	$^{134}\text{Cs}(\beta^-)^{134}\text{Ba}$	42.3	$^{134}\text{Ba}(\text{n},\gamma)^{135}\text{Ba}$		
^{135}Sb	83.6	$^{135}\text{Sb} - ^{130}\text{Xe}_{1,038}$	16.4	$^{135}\text{Sb} - ^{133}\text{Cs}_{1,015}$		
^{135}Te	59.4	$^{135}\text{Te} - ^{133}\text{Cs}_{1,015}$	40.6	$^{135}\text{Te} - ^{130}\text{Xe}_{1,038}$		
^{135}I	92.5	$^{135}\text{I} - ^{133}\text{Cs}_{1,015}$	7.5	$^{135}\text{I}(\beta^-)^{135}\text{Xe}$		
^{135}Xe	65.9	$^{135}\text{Xe}(\beta^-)^{135}\text{Cs}$	34.1	$^{135}\text{I}(\beta^-)^{135}\text{Xe}$		

Table II. Influences on primary nuclides (continued, Explanation of Table on page 030003-74)

Nuclide	Infl.	Equation	Infl.	Equation	Infl.	Equation
^{135}Cs	98.4	$^{134}\text{Cs}(n,\gamma)^{135}\text{Cs}$	1.6	$^{135}\text{Xe}(\beta^-)^{135}\text{Cs}$		
^{135}Ba	54.9	$^{134}\text{Ba}(n,\gamma)^{135}\text{Ba}$	45.1	$^{135}\text{Ba}(n,\gamma)^{136}\text{Ba}$		
^{135}La	88.9	$^{135}\text{La}(\beta^+)^{135}\text{Ba}$	11.1	$^{135}\text{Ce}(\beta^+)^{135}\text{La}$		
^{135}Ce	86.5	$^{135}\text{Ce}(\beta^+)^{135}\text{La}$	13.5	$^{135}\text{Ce}-u$		
^{136}Sb	84.7	$^{136}\text{Sb}-^{130}\text{Xe}_{1.046}$	15.3	$^{136}\text{Sb}-^{133}\text{Cs}_{1.023}$		
^{136}Te	62.4	$^{136}\text{Te}-^{130}\text{Xe}_{1.046}$	24.0	$^{136}\text{Te}-^{136}\text{Xe}$	13.0	$^{136}\text{Te}-^{133}\text{Cs}_{1.023}$
^{136}I	50.3	$^{136}\text{I}(\beta^-)^{136}\text{Xe}$	49.7	$^{136}\text{Te}(\beta^-)^{136}\text{I}$		
^{136}Xe	81.6	$^{136}\text{Xe}-^{13}\text{C}_3\text{O}_6$	18.3	$^{136}\text{Xe}-^{28}\text{Si}_4\text{D}_{12}$		
^{136}Ba	54.5	$^{135}\text{Ba}(n,\gamma)^{136}\text{Ba}$	44.8	$^{136}\text{Xe}-^{136}\text{Ba}$	0.6	$^{136}\text{Ba}(n,\gamma)^{137}\text{Ba}$
^{136}Ce	99.9	$^{136}\text{Ce}-^{136}\text{Ba}$	0.1	$^{136}\text{Ce}(n,\gamma)^{137}\text{Ce}$		
^{136}Pr	67.2	$^{136}\text{Pr}-^{133}\text{Cs}_{1.023}$	32.8	$^{136}\text{Pr}(\beta^+)^{136}\text{Ce}$		
^{137}Te	69.8	$^{137}\text{Te}-^{130}\text{Xe}_{1.054}$	30.2	$^{137}\text{Te}-^{133}\text{Cs}_{1.030}$		
^{137}Ba	99.4	$^{136}\text{Ba}(n,\gamma)^{137}\text{Ba}$	0.6	$^{137}\text{Ba}(n,\gamma)^{138}\text{Ba}$		
^{137}Ce	99.9	$^{136}\text{Ce}(n,\gamma)^{137}\text{Ce}$	0.1	$^{137}\text{Pr}(\beta^+)^{137}\text{Ce}$		
^{137}Pr	66.1	$^{137}\text{Pr}(\beta^+)^{137}\text{Ce}$	33.9	$^{137}\text{Pr}-^{133}\text{Cs}_{1.030}$		
^{137}Nd	81.0	$^{137}\text{Nd}-^{133}\text{Cs}_{1.030}$	17.6	$^{137}\text{Nd}-u$	1.4	$^{137}\text{Pm}^m(\beta^+)^{137}\text{Nd}$
$^{137}\text{Pm}^m$	69.9	$^{137}\text{Pm}^m(\beta^+)^{137}\text{Nd}$	30.1	$^{137}\text{Sm}(\beta^+)^{137}\text{Pm}^m$		
^{137}Sm	43.5	$^{137}\text{Sm}-u$	34.0	$^{137}\text{Sm}-^{133}\text{Cs}_{1.030}$	22.4	$^{137}\text{Sm}(\beta^+)^{137}\text{Pm}^m$
^{138}Te	74.8	$^{138}\text{Te}-^{130}\text{Xe}_{1.062}$	25.2	$^{138}\text{Te}-^{133}\text{Cs}_{1.038}$		
^{138}Xe	74.0	$^{138}\text{Xe}-^{133}\text{Cs}_{1.038}$	26.0	$^{138}\text{Xe}-^{136}\text{Xe}_{1.015}$		
^{138}Cs	50.7	$^{138}\text{Cs}(\beta^-)^{138}\text{Ba}$	49.3	$^{138}\text{Cs}-^{133}\text{Cs}_{1.038}$		
^{138}Ba	99.4	$^{137}\text{Ba}(n,\gamma)^{138}\text{Ba}$	0.6	$^{138}\text{Ba}(n,\gamma)^{139}\text{Ba}$		
^{138}La	94.2	$^{138}\text{La}(d,p)^{139}\text{La}$	5.8	$^{138}\text{La}(\beta^-)^{138}\text{Ce}$		
^{138}Ce	82.4	$^{138}\text{La}(\beta^-)^{138}\text{Ce}$	15.6	$^{138}\text{Ce}(t,p)^{140}\text{Ce}$	2.1	$^{138}\text{Pr}^m(\beta^+)^{138}\text{Ce}$
$^{138}\text{Pr}^m$	64.8	$^{138}\text{Pr}^m(\beta^+)^{138}\text{Ce}$	35.2	$^{138}\text{Pr}^m-u$		
^{138}Nd	96.4	$^{138}\text{Nd}-^{133}\text{Cs}_{1.038}$	3.6	$^{138}\text{Pm}(\beta^+)^{138}\text{Nd}$		
^{138}Pm	72.4	$^{138}\text{Pm}-u$	27.6	$^{138}\text{Pm}(\beta^+)^{138}\text{Nd}$		
^{139}Ba	99.4	$^{138}\text{Ba}(n,\gamma)^{139}\text{Ba}$	0.6	$^{139}\text{Ba}(\beta^-)^{139}\text{La}$		
^{139}La	57.4	$^{139}\text{La}(n,\gamma)^{140}\text{La}$	40.9	$^{139}\text{Ba}(\beta^-)^{139}\text{La}$	1.6	$^{138}\text{La}(d,p)^{139}\text{La}$
^{139}Ce	98.5	$^{139}\text{Ce}(\epsilon)^{139}\text{La}$	1.5	$^{139}\text{Pr}(\beta^+)^{139}\text{Ce}$		
^{139}Pr	98.3	$^{139}\text{Pr}(\beta^+)^{139}\text{Ce}$	1.7	$^{139}\text{Nd}(\beta^+)^{139}\text{Pr}$		
^{139}Nd	70.3	$^{139}\text{Pm}(\beta^+)^{139}\text{Nd}$	29.7	$^{139}\text{Nd}(\beta^+)^{139}\text{Pr}$		
^{139}Pm	94.6	$^{139}\text{Pm}-^{133}\text{Cs}_{1.045}$	5.4	$^{139}\text{Pm}(\beta^+)^{139}\text{Nd}$		
^{140}Cs	79.1	$^{140}\text{Cs}-^{133}\text{Cs}_{1.053}$	20.9	$^{140}\text{Cs}(\beta^-)^{140}\text{Ba}$		
^{140}Ba	37.5	$^{140}\text{Ba}(\beta^-)^{140}\text{La}$	37.0	$^{140}\text{Ba}-^{133}\text{Cs}_{1.053}$	19.1	$^{140}\text{Cs}(\beta^-)^{140}\text{Ba}$
^{140}La	55.9	$^{140}\text{La}(\beta^-)^{140}\text{Ce}$	42.6	$^{139}\text{La}(n,\gamma)^{140}\text{La}$	1.5	$^{140}\text{Ba}(\beta^-)^{140}\text{La}$
^{140}Ce	40.3	$^{140}\text{CeO}-^{133}\text{Cs}_{1.173}$	35.4	$^{140}\text{Ce}(n,\gamma)^{141}\text{Ce}$	18.7	$^{140}\text{La}(\beta^-)^{140}\text{Ce}$
$^{140}\text{Pm}^m$	77.9	$^{140}\text{Pm}^m-^{133}\text{Cs}_{1.053}$	22.1	$^{140}\text{Pm}^m-u$		
^{141}Cs	38.1	$^{141}\text{Cs}-^{133}\text{Cs}_{1.060}$	33.1	$^{141}\text{Cs}(\beta^-)^{141}\text{Ba}$	20.1	$^{141}\text{Cs}-^{136}\text{Xe}_{1.037}$
^{141}Ba	58.0	$^{141}\text{Ba}-u$	27.2	$^{141}\text{Ba}-^{133}\text{Cs}_{1.060}$	8.1	$^{141}\text{Cs}(\beta^-)^{141}\text{Ba}$
^{141}La	95.9	$^{141}\text{La}(\beta^-)^{141}\text{Ce}$	4.1	$^{141}\text{Ba}(\beta^-)^{141}\text{La}$		
^{141}Ce	64.5	$^{140}\text{Ce}(n,\gamma)^{141}\text{Ce}$	34.9	$^{141}\text{Ce}(\beta^-)^{141}\text{Pr}$	0.6	$^{141}\text{La}(\beta^-)^{141}\text{Ce}$
^{141}Pr	52.4	$^{141}\text{Pr}(n,\gamma)^{142}\text{Pr}$	47.6	$^{141}\text{Ce}(\beta^-)^{141}\text{Pr}$		
^{141}Sm	49.8	$^{144}\text{Sm}({}^3\text{He}, {}^6\text{He})^{141}\text{Sm}$	42.9	$^{141}\text{Sm}-^{133}\text{Cs}_{1.060}$	7.3	$^{141}\text{Eu}(\beta^+)^{141}\text{Sm}$
^{141}Eu	81.8	$^{141}\text{Eu}-^{133}\text{Cs}_{1.060}$	18.2	$^{141}\text{Eu}(\beta^+)^{141}\text{Sm}$		
^{142}Cs	47.6	$^{142}\text{Cs}-^{136}\text{Xe}_{1.044}$	33.4	$^{142}\text{Cs}-^{133}\text{Cs}_{1.068}$	18.8	$^{142}\text{Cs}(\beta^-)^{142}\text{Ba}$
^{142}Ba	48.8	$^{142}\text{Ba}-u$	33.7	$^{142}\text{Ba}-^{133}\text{Cs}_{1.068}$	12.2	$^{142}\text{Cs}(\beta^-)^{142}\text{Ba}$
^{142}La	94.0	$^{142}\text{La}(\beta^-)^{142}\text{Ce}$	6.0	$^{142}\text{Ba}(\beta^-)^{142}\text{La}$		
^{142}Ce	78.9	$^{142}\text{Ce}(n,\gamma)^{143}\text{Ce}$	20.2	$^{140}\text{Ce}(t,p)^{142}\text{Ce}$	0.9	$^{142}\text{La}(\beta^-)^{142}\text{Ce}$
^{142}Pr	52.4	$^{142}\text{Pr}(\beta^-)^{142}\text{Nd}$	47.6	$^{141}\text{Pr}(n,\gamma)^{142}\text{Pr}$		
^{142}Nd	79.1	$^{142}\text{Nd}(n,\gamma)^{143}\text{Nd}$	20.0	$^{142}\text{Pr}(\beta^-)^{142}\text{Nd}$	0.7	$^{146}\text{Sm}(\alpha)^{142}\text{Nd}$
^{142}Pm	88.7	$^{142}\text{Pm}-u$	11.3	$^{142}\text{Sm}(\beta^+)^{142}\text{Pm}$		

Table II. Influences on primary nuclides (continued, Explanation of Table on page 030003-74)

Nuclide	Infl.	Equation	Infl.	Equation	Infl.	Equation
^{142}Sm	78.7	$^{122}\text{Te}(\text{p,t})^{120}\text{Te}-^{144}\text{Sm}(\text{O})^{142}\text{Sm}$	10.7	$^{130}\text{Ba}(\text{p,t})^{128}\text{Ba}-^{144}\text{Sm}(\text{O})^{142}\text{Sm}$	2.9	$^{160}\text{Yb}-^{142}\text{Sm}_{1.127}$
^{143}Cs	91.5	$^{143}\text{Cs}-^{133}\text{Cs}_{1.075}$	8.5	$^{143}\text{Cs}(\beta^-)^{143}\text{Ba}$		
^{143}Ba	72.8	$^{143}\text{Ba}-\text{u}$	20.5	$^{143}\text{Ba}-^{133}\text{Cs}_{1.075}$	6.6	$^{143}\text{Cs}(\beta^-)^{143}\text{Ba}$
^{143}La	81.8	$^{143}\text{La}-\text{u}$	18.2	$^{143}\text{La}(\beta^-)^{143}\text{Ce}$		
^{143}Ce	77.2	$^{143}\text{Ce}(\beta^-)^{143}\text{Pr}$	21.1	$^{142}\text{Ce}(\text{n},\gamma)^{143}\text{Ce}$	1.8	$^{143}\text{La}(\beta^-)^{143}\text{Ce}$
^{143}Pr	90.1	$^{143}\text{Pr}(\beta^-)^{143}\text{Nd}$	9.9	$^{143}\text{Ce}(\beta^-)^{143}\text{Pr}$		
^{143}Nd	38.3	$^{143}\text{Nd}(\text{n},\gamma)^{144}\text{Nd}$	22.1	$^{147}\text{Sm}(\alpha)^{143}\text{Nd}$	20.8	$^{142}\text{Nd}(\text{n},\gamma)^{143}\text{Nd}$
^{143}Pm	49.3	$^{143}\text{Nd}(\text{}^3\text{He,d})^{144}\text{Pm}-^{142}\text{Nd}(\text{O})^{143}\text{Pm}$	28.6	$^{142}\text{Nd}(\text{}^3\text{He,d})^{143}\text{Pm}$	22.2	$^{147}\text{Eu}(\alpha)^{143}\text{Pm}$
^{143}Sm	100.0	$^{144}\text{Sm}(\text{p,d})^{143}\text{Sm}-^{148}\text{Gd}(\text{O})^{147}\text{Gd}$				
^{144}Cs	42.9	$^{144}\text{Cs}-^{133}\text{Cs}_{1.083}$	37.5	$^{144}\text{Cs}(\beta^-)^{144}\text{Ba}$	19.6	$^{144}\text{Cs}-^{145}\text{Cs}_{.662} \text{}^{142}\text{Cs}_{.338}$
^{144}Ba	70.9	$^{144}\text{Ba}-\text{u}$	26.1	$^{144}\text{Ba}-^{133}\text{Cs}_{1.083}$	3.0	$^{144}\text{Cs}(\beta^-)^{144}\text{Ba}$
^{144}Nd	61.2	$^{143}\text{Nd}(\text{n},\gamma)^{144}\text{Nd}$	26.1	$^{148}\text{Sm}(\alpha)^{144}\text{Nd}$	6.5	$^{144}\text{Nd}(\text{n},\gamma)^{145}\text{Nd}$
^{144}Pm	57.5	$^{144}\text{Nd}(\text{}^3\text{He,d})^{145}\text{Pm}-^{143}\text{Nd}(\text{O})^{144}\text{Pm}$	41.8	$^{143}\text{Nd}(\text{}^3\text{He,d})^{144}\text{Pm}-^{142}\text{Nd}(\text{O})^{143}\text{Pm}$	0.7	$^{148}\text{Eu}(\alpha)^{144}\text{Pm}$
^{144}Sm	85.4	$^{144}\text{Sm}-^{144}\text{Nd}$	6.8	$^{144}\text{Sm}(\text{n},\gamma)^{145}\text{Sm}$	3.6	$^{148}\text{Gd}(\alpha)^{144}\text{Sm}$
^{144}Eu	46.4	$^{144}\text{Eu}-^{133}\text{Cs}_{1.083}$	38.7	$^{144}\text{Eu}(\beta^+)^{144}\text{Sm}$	14.9	$^{144}\text{Eu}-\text{u}$
^{145}Cs	98.6	$^{145}\text{Cs}-^{133}\text{Cs}_{1.090}$	1.4	$^{144}\text{Cs}-^{145}\text{Cs}_{.662} \text{}^{142}\text{Cs}_{.338}$		
^{145}La	98.1	$^{145}\text{La}-\text{u}$	1.9	$^{145}\text{La}(\beta^-)^{145}\text{Ce}$		
^{145}Ce	66.9	$^{145}\text{Ce}(\beta^-)^{145}\text{Pr}$	17.5	$^{145}\text{La}(\beta^-)^{145}\text{Ce}$	15.6	$^{145}\text{Ce}-\text{u}$
^{145}Pr	49.5	$^{145}\text{Pr}(\beta^-)^{145}\text{Nd}$	49.5	$^{146}\text{Nd}(\text{d},\text{}^3\text{He})^{145}\text{Pr}$	1.0	$^{145}\text{Ce}(\beta^-)^{145}\text{Pr}$
^{145}Nd	89.0	$^{144}\text{Nd}(\text{n},\gamma)^{145}\text{Nd}$	11.0	$^{145}\text{Nd}(\text{n},\gamma)^{146}\text{Nd}$		
^{145}Pm	41.1	$^{145}\text{Sm}(\epsilon)^{145}\text{Pm}$	33.5	$^{144}\text{Nd}(\text{}^3\text{He,d})^{145}\text{Pm}-^{143}\text{Nd}(\text{O})^{144}\text{Pm}$	25.4	$^{144}\text{Nd}(\text{}^3\text{He,d})^{145}\text{Pm}$
^{145}Sm	92.4	$^{144}\text{Sm}(\text{n},\gamma)^{145}\text{Sm}$	2.9	$^{149}\text{Gd}(\alpha)^{145}\text{Sm}$	2.6	$^{145}\text{Sm}(\epsilon)^{145}\text{Pm}$
^{145}Eu	91.0	$^{144}\text{Sm}(\text{}^3\text{He,d})^{145}\text{Eu}$	9.0	$^{149}\text{Tb}(\alpha)^{145}\text{Eu}$		
^{145}Gd	99.5	$^{145}\text{Gd}-\text{u}$	0.5	$^{145}\text{Tb}(\beta^+)^{145}\text{Gd}$		
^{145}Tb	80.6	$^{145}\text{Tb}(\beta^+)^{145}\text{Gd}$	19.4	$^{145}\text{Tb}-\text{u}$		
^{146}Ba	89.3	$^{146}\text{Ba}-\text{u}$	10.7	$^{146}\text{Ba}(\beta^-)^{146}\text{La}$		
^{146}La	45.4	$^{146}\text{Ba}(\beta^-)^{146}\text{La}$	37.0	$^{146}\text{La}(\beta^-)^{146}\text{Ce}$	17.6	$^{146}\text{La}-\text{u}$
^{146}Ce	90.0	$^{146}\text{Ce}-\text{u}$	5.8	$^{146}\text{La}(\beta^-)^{146}\text{Ce}$	4.2	$^{146}\text{Ce}(\beta^-)^{146}\text{Pr}$
^{146}Pr	75.8	$^{146}\text{Ce}(\beta^-)^{146}\text{Pr}$	24.2	$^{146}\text{Pr}(\beta^-)^{146}\text{Nd}$		
^{146}Nd	88.4	$^{145}\text{Nd}(\text{n},\gamma)^{146}\text{Nd}$	10.1	$^{146}\text{Nd}(\text{n},\gamma)^{147}\text{Nd}$	1.5	$^{148}\text{Nd} \text{}^{35}\text{Cl}-^{146}\text{Nd} \text{}^{37}\text{Cl}$
^{146}Sm	46.1	$^{146}\text{Sm}(\alpha)^{142}\text{Nd}$	30.4	$^{146}\text{Sm}(\text{}^3\text{He},\alpha)^{145}\text{Sm}$	12.3	$^{148}\text{Sm}(\text{p,t})^{146}\text{Sm}$
^{146}Eu	45.9	$^{146}\text{Eu}(\beta^+)^{146}\text{Sm}$	24.1	$^{144}\text{Sm}(\text{}^3\text{He,p})^{146}\text{Eu}$	18.6	$^{146}\text{Eu}-^{133}\text{Cs}_{1.098}$
^{146}Gd	88.8	$^{148}\text{Gd}(\text{p,t})^{146}\text{Gd}-^{65}\text{Cu}(\text{O})^{63}\text{Cu}$	7.0	$^{150}\text{Dy}(\alpha)^{146}\text{Gd}$	4.0	$^{147}\text{Tb}(\text{p})^{146}\text{Gd}$
^{146}Tb	80.0	$^{146}\text{Tb}(\beta^+)^{146}\text{Gd}$	20.0	$^{146}\text{Dy}(\beta^+)^{146}\text{Tb}$		
^{146}Dy	99.6	$^{146}\text{Dy}-^{85}\text{Rb}_{1.718}$	0.4	$^{146}\text{Dy}(\beta^+)^{146}\text{Tb}$		
^{146}Ho	50.0	$^{146}\text{Ho}-^{133}\text{Cs}_{1.098}$	50.0	$^{146}\text{Ho}-^{85}\text{Rb}_{1.718}$		
^{146}Er	61.2	$^{146}\text{Er}-^{85}\text{Rb}_{1.718}$	38.8	$^{147}\text{Tm}(\text{p})^{146}\text{Er}$		
^{147}Ce	92.1	$^{147}\text{Ce}-\text{u}$	7.9	$^{147}\text{Ce}(\beta^-)^{147}\text{Pr}$		
^{147}Pr	52.4	$^{147}\text{Ce}(\beta^-)^{147}\text{Pr}$	47.6	$^{147}\text{Pr}(\beta^-)^{147}\text{Nd}$		
^{147}Nd	89.3	$^{146}\text{Nd}(\text{n},\gamma)^{147}\text{Nd}$	10.1	$^{147}\text{Nd}(\beta^-)^{147}\text{Pm}$	0.5	$^{148}\text{Nd}(\text{d,t})^{147}\text{Nd}$
^{147}Pm	86.9	$^{147}\text{Pm}(\beta^-)^{147}\text{Sm}$	13.1	$^{147}\text{Nd}(\beta^-)^{147}\text{Pm}$		
^{147}Sm	50.6	$^{147}\text{Sm}(\text{n},\gamma)^{148}\text{Sm}$	27.7	$^{147}\text{Sm}(\alpha)^{143}\text{Nd}$	14.2	$^{149}\text{Sm} \text{}^{35}\text{Cl}-^{147}\text{Sm} \text{}^{37}\text{Cl}$
^{147}Eu	56.9	$^{147}\text{Eu}(\beta^+)^{147}\text{Sm}$	18.8	$^{147}\text{Gd}(\beta^+)^{147}\text{Eu}$	14.4	$^{147}\text{Eu}(\alpha)^{143}\text{Pm}$
^{147}Gd	86.2	$^{148}\text{Gd}(\text{p,d})^{147}\text{Gd}-^{148}\text{Sm}(\text{O})^{147}\text{Sm}$	6.6	$^{147}\text{Gd}(\beta^+)^{147}\text{Eu}$	6.2	$^{104}\text{Ru}(\text{d,t})^{103}\text{Ru}-^{148}\text{Gd}(\text{O})^{147}\text{Gd}$
^{147}Tb	52.5	$^{147}\text{Tb}-^{133}\text{Cs}_{1.105}$	28.5	$^{147}\text{Tb}(\beta^+)^{147}\text{Gd}$	19.0	$^{147}\text{Tb}(\text{p})^{146}\text{Gd}$
^{147}Ho	52.6	$^{147}\text{Ho}-^{85}\text{Rb}_{1.729}$	47.4	$^{147}\text{Ho}-^{133}\text{Cs}_{1.105}$		
^{147}Tm	55.5	$^{147}\text{Tm}(\text{p})^{146}\text{Er}$	44.5	$^{147}\text{Tm}-^{85}\text{Rb}_{1.729}$		
^{148}Ce	85.5	$^{148}\text{Ce}-\text{u}$	14.5	$^{148}\text{Ce}(\beta^-)^{148}\text{Pr}$		
^{148}Pr	66.0	$^{148}\text{Ce}(\beta^-)^{148}\text{Pr}$	34.0	$^{148}\text{Pr}(\beta^-)^{148}\text{Nd}$		
^{148}Nd	60.7	$^{148}\text{Nd} \text{}^{35}\text{Cl}-^{146}\text{Nd} \text{}^{37}\text{Cl}$	16.7	$^{148}\text{Nd}(\text{d,t})^{147}\text{Nd}$	11.3	$^{148}\text{Nd} \text{}^{35}\text{Cl}_2-^{144}\text{Nd} \text{}^{37}\text{Cl}_2$
^{148}Sm	33.0	$^{147}\text{Sm}(\text{n},\gamma)^{148}\text{Sm}$	26.4	$^{150}\text{Sm} \text{}^{35}\text{Cl}-^{148}\text{Sm} \text{}^{37}\text{Cl}$	25.9	$^{148}\text{Sm}(\alpha)^{144}\text{Nd}$
^{148}Eu	51.4	$^{148}\text{Eu}-^{133}\text{Cs}_{1.113}$	38.3	$^{148}\text{Eu}-^{142}\text{Sm}_{1.042}$	10.4	$^{148}\text{Eu}(\alpha)^{144}\text{Pm}$

Table II. Influences on primary nuclides (continued, Explanation of Table on page 030003-74)

Nuclide	Infl.	Equation	Infl.	Equation	Infl.	Equation
^{148}Gd	96.4	$^{148}\text{Gd}(\alpha)^{144}\text{Sm}$	2.4	$^{148}\text{Gd}(p,d)^{147}\text{Gd}-^{148}\text{Sm}(\text{t})^{147}\text{Sm}$	0.9	$^{148}\text{Gd}(p,t)^{146}\text{Gd}-^{65}\text{Cu}(\text{t})^{63}\text{Cu}$
^{148}Tb	85.7	$^{148}\text{Dy}(\beta^+)^{148}\text{Tb}$	9.7	$^{148}\text{Tb}(\beta^+)^{148}\text{Gd}$	4.7	$^{152}\text{Ho}(\alpha)^{148}\text{Tb}$
^{148}Dy	79.0	$^{148}\text{Dy}-^{133}\text{Cs}_{1.113}$	14.5	$^{152}\text{Er}(\alpha)^{148}\text{Dy}$	6.4	$^{148}\text{Dy}(\beta^+)^{148}\text{Tb}$
^{149}Pm	86.7	$^{149}\text{Pm}(\beta^-)^{149}\text{Sm}$	13.3	$^{148}\text{Nd}(\text{d},^3\text{He},d)^{149}\text{Pm}$		
^{149}Sm	79.1	$^{149}\text{Sm}(n,\gamma)^{150}\text{Sm}$	10.0	$^{148}\text{Sm}(n,\gamma)^{149}\text{Sm}$	9.5	$^{149}\text{Sm}^{35}\text{Cl}-^{147}\text{Sm}^{37}\text{Cl}$
^{149}Eu	56.1	$^{151}\text{Eu}(p,t)^{149}\text{Eu}$	29.8	$^{149}\text{Gd}(\epsilon)^{149}\text{Eu}$	14.1	$^{149}\text{Eu}(\epsilon)^{149}\text{Sm}$
^{149}Gd	52.9	$^{149}\text{Gd}(\alpha)^{145}\text{Sm}$	21.1	$^{153}\text{Dy}(\alpha)^{149}\text{Gd}$	17.8	$^{149}\text{Gd}(\epsilon)^{149}\text{Eu}$
^{149}Tb	85.8	$^{149}\text{Tb}(\alpha)^{145}\text{Eu}$	10.5	$^{149}\text{Tb}(\beta^+)^{149}\text{Gd}$	3.7	$^{149}\text{Dy}(\beta^+)^{149}\text{Tb}$
^{149}Dy	46.0	$^{149}\text{Dy}(\beta^+)^{149}\text{Tb}$	36.1	$^{149}\text{Dy}-^{142}\text{Sm}_{1.049}$	15.3	$^{149}\text{Ho}(\beta^+)^{149}\text{Dy}$
^{149}Ho	53.4	$^{153}\text{Tm}(\alpha)^{149}\text{Ho}$	32.3	$^{149}\text{Ho}(\beta^+)^{149}\text{Dy}$	14.3	$^{149}\text{Ho}-u$
^{150}Ce	91.9	$^{150}\text{Ce}-u$	8.1	$^{150}\text{Ce}(\beta^-)^{150}\text{Pr}$		
^{150}Pr	83.4	$^{150}\text{Pr}-u$	12.0	$^{150}\text{Pr}(\beta^-)^{150}\text{Nd}$	4.6	$^{150}\text{Ce}(\beta^-)^{150}\text{Pr}$
^{150}Nd	99.5	$^{150}\text{Nd}-^{150}\text{Sm}$	0.2	$^{150}\text{Nd}(n,\gamma)^{151}\text{Nd}$	0.2	$^{150}\text{Pr}(\beta^-)^{150}\text{Nd}$
^{150}Sm	61.7	$^{150}\text{Sm}(n,\gamma)^{151}\text{Sm}$	16.1	$^{149}\text{Sm}(n,\gamma)^{150}\text{Sm}$	14.1	$^{150}\text{Sm}^{35}\text{Cl}-^{148}\text{Sm}^{37}\text{Cl}$
^{150}Eu	53.4	$^{150}\text{Eu}(\beta^-)^{150}\text{Gd}$	46.6	$^{151}\text{Eu}(p,d)^{150}\text{Eu}$		
^{150}Gd	39.4	$^{150}\text{Gd}(\alpha)^{146}\text{Sm}$	37.6	$^{150}\text{Eu}(\beta^-)^{150}\text{Gd}$	11.7	$^{150}\text{Tb}(\beta^+)^{150}\text{Gd}$
^{150}Tb	80.5	$^{150}\text{Tb}(\alpha)^{146}\text{Eu}$	19.5	$^{150}\text{Tb}(\beta^+)^{150}\text{Gd}$		
$^{150}\text{Tb}^m$	89.2	$^{150}\text{Tb}^m-u$	10.8	$^{154}\text{Ho}^m(\alpha)^{150}\text{Tb}^m$		
^{150}Dy	92.0	$^{150}\text{Dy}(\alpha)^{146}\text{Gd}$	6.2	$^{154}\text{Er}(\alpha)^{150}\text{Dy}$	1.9	$^{150}\text{Ho}(\epsilon)^{150}\text{Dy}$
^{150}Ho	53.2	$^{150}\text{Ho}-^{133}\text{Cs}_{1.128}$	26.8	$^{150}\text{Ho}(\epsilon)^{150}\text{Dy}$	20.0	$^{150}\text{Er}(\beta^+)^{150}\text{Ho}$
^{150}Er	62.1	$^{150}\text{Er}(\beta^+)^{150}\text{Ho}$	37.9	$^{150}\text{Er}-u$		
^{151}Pr	76.5	$^{151}\text{Pr}-u$	23.5	$^{151}\text{Pr}(\beta^-)^{151}\text{Nd}$		
^{151}Nd	99.8	$^{150}\text{Nd}(n,\gamma)^{151}\text{Nd}$	0.2	$^{151}\text{Pr}(\beta^-)^{151}\text{Nd}$		
^{151}Pm	80.0	$^{150}\text{Nd}(\text{d},^3\text{He},d)^{151}\text{Pm}$	20.0	$^{151}\text{Pm}(\beta^-)^{151}\text{Sm}$		
^{151}Sm	40.8	$^{151}\text{Sm}(n,\gamma)^{152}\text{Sm}$	37.8	$^{150}\text{Sm}(n,\gamma)^{151}\text{Sm}$	21.4	$^{151}\text{Sm}(\beta^-)^{151}\text{Eu}$
^{151}Eu	58.9	$^{151}\text{Sm}(\beta^-)^{151}\text{Eu}$	39.1	$^{151}\text{Eu}(n,\gamma)^{152}\text{Eu}$	0.8	$^{151}\text{Gd}(\epsilon)^{151}\text{Eu}$
^{151}Gd	85.0	$^{151}\text{Gd}(\epsilon)^{151}\text{Eu}$	15.0	$^{151}\text{Tb}(\beta^+)^{151}\text{Gd}$		
^{151}Tb	51.5	$^{151}\text{Tb}(\beta^+)^{151}\text{Gd}$	48.5	$^{151}\text{Tb}(\alpha)^{147}\text{Eu}$		
^{152}Nd	66.4	$^{150}\text{Nd}(t,p)^{152}\text{Nd}$	33.6	$^{152}\text{Nd}(\beta^-)^{152}\text{Pm}$		
^{152}Pm	51.4	$^{152}\text{Nd}(\beta^-)^{152}\text{Pm}$	48.6	$^{152}\text{Pm}(\beta^-)^{152}\text{Sm}$		
^{152}Sm	71.9	$^{152}\text{Gd}-^{152}\text{Sm}$	17.0	$^{151}\text{Sm}(n,\gamma)^{152}\text{Sm}$	6.3	$^{152}\text{Eu}(\beta^+)^{152}\text{Sm}$
^{152}Eu	60.4	$^{151}\text{Eu}(n,\gamma)^{152}\text{Eu}$	26.5	$^{152}\text{Eu}(\beta^+)^{152}\text{Sm}$	13.1	$^{152}\text{Eu}(n,\gamma)^{153}\text{Eu}$
^{152}Gd	73.6	$^{152}\text{Gd}(n,\gamma)^{153}\text{Gd}$	26.4	$^{152}\text{Gd}-^{152}\text{Sm}$		
^{152}Ho	95.3	$^{152}\text{Ho}(\alpha)^{148}\text{Tb}$	4.7	$^{156}\text{Tm}(\alpha)^{152}\text{Ho}$		
^{152}Er	85.0	$^{152}\text{Er}(\alpha)^{148}\text{Dy}$	15.0	$^{156}\text{Yb}(\alpha)^{152}\text{Er}$		
^{152}Tm	100.0	$^{152}\text{Tm}-u$				
^{152}Yb	100.0	$^{152}\text{Yb}(\beta^+)^{152}\text{Tm}$				
^{153}Pr	79.7	$^{153}\text{Pr}-u$	10.2	$^{153}\text{Pr}-^{86}\text{Kr}_{1.779}$	10.2	$^{153}\text{Pr}-^{80}\text{Kr}_{1.913}$
^{153}Nd	35.9	$^{153}\text{Nd}-^{80}\text{Kr}_{1.913}$	32.2	$^{153}\text{Nd}-u$	31.0	$^{153}\text{Nd}-^{86}\text{Kr}_{1.779}$
^{153}Pm	33.4	$^{154}\text{Sm}(d,^3\text{He})^{153}\text{Pm}$	17.9	$^{153}\text{Pm}-u$	17.9	$^{153}\text{Pm}-^{86}\text{Kr}_{1.779}$
^{153}Eu	86.5	$^{152}\text{Eu}(n,\gamma)^{153}\text{Eu}$	13.5	$^{153}\text{Eu}(n,\gamma)^{154}\text{Eu}$		
^{153}Gd	74.0	$^{153}\text{Gd}(n,\gamma)^{154}\text{Gd}$	25.4	$^{152}\text{Gd}(n,\gamma)^{153}\text{Gd}$	0.5	$^{153}\text{Tb}(\beta^+)^{153}\text{Gd}$
^{153}Tb	58.6	$^{153}\text{Tb}(\beta^+)^{153}\text{Gd}$	41.4	$^{153}\text{Dy}(\beta^+)^{153}\text{Tb}$		
^{153}Dy	52.1	$^{153}\text{Dy}(\beta^+)^{153}\text{Tb}$	47.9	$^{153}\text{Dy}(\alpha)^{149}\text{Gd}$		
^{153}Er	97.3	$^{153}\text{Er}(\alpha)^{149}\text{Dy}$	2.7	$^{157}\text{Yb}(\alpha)^{153}\text{Er}$		
^{153}Tm	53.8	$^{157}\text{Lu}^m(\alpha)^{153}\text{Tm}$	46.2	$^{153}\text{Tm}(\alpha)^{149}\text{Ho}$		
^{154}Sm	78.5	$^{154}\text{Sm}^{35}\text{Cl}-^{152}\text{Sm}^{37}\text{Cl}$	20.8	$^{154}\text{Sm}-^{154}\text{Gd}$	0.6	$^{154}\text{Sm}(d,^3\text{He})^{153}\text{Pm}$
^{154}Eu	85.2	$^{153}\text{Eu}(n,\gamma)^{154}\text{Eu}$	11.9	$^{154}\text{Eu}(\beta^-)^{154}\text{Gd}$	2.1	$^{154}\text{Eu}(n,\gamma)^{155}\text{Eu}$
^{154}Gd	72.6	$^{154}\text{Gd}(n,\gamma)^{155}\text{Gd}$	24.4	$^{153}\text{Gd}(n,\gamma)^{154}\text{Gd}$	2.4	$^{154}\text{Eu}(\beta^-)^{154}\text{Gd}$
^{154}Dy	81.5	$^{154}\text{Dy}(\alpha)^{150}\text{Gd}$	17.7	$^{154}\text{Dy}-^{133}\text{Cs}_{1.158}$	0.8	$^{154}\text{Ho}^m(\beta^+)^{154}\text{Dy}$
$^{154}\text{Ho}^m$	88.9	$^{154}\text{Ho}^m(\alpha)^{150}\text{Tb}^m$	11.1	$^{154}\text{Ho}^m(\beta^+)^{154}\text{Dy}$		
^{154}Er	91.6	$^{154}\text{Er}(\alpha)^{150}\text{Dy}$	8.4	$^{158}\text{Yb}(\alpha)^{154}\text{Er}$		

Table II. Influences on primary nuclides (continued, Explanation of Table on page 030003-74)

Nuclide	Infl.	Equation	Infl.	Equation	Infl.	Equation
^{160}Tm	88.9	$^{160}\text{Tm}-\text{u}$	11.1	$^{160}\text{Tm}(\beta^+)^{160}\text{Er}$		
^{160}Yb	85.4	$^{160}\text{Yb}-^{133}\text{Cs}_{1,203}$	14.6	$^{160}\text{Yb}-^{142}\text{Sm}_{1,127}$		
^{160}Hf	81.8	$^{160}\text{Hf}(\alpha)^{156}\text{Yb}$	18.2	$^{164}\text{W}(\alpha)^{160}\text{Hf}$		
^{160}W	100.0	$^{160}\text{W}(\alpha)^{156}\text{Hf}$				
^{161}Sm	36.6	$^{161}\text{Sm}-^{80}\text{Kr}_{2,013}$	31.7	$^{161}\text{Sm}-\text{u}$	31.7	$^{161}\text{Sm}-^{86}\text{Kr}_{1,872}$
^{161}Eu	34.5	$^{161}\text{Eu}-\text{u}$	34.3	$^{161}\text{Eu}-^{80}\text{Kr}_{2,013}$	31.2	$^{161}\text{Eu}-^{86}\text{Kr}_{1,872}$
^{161}Tb	74.2	$^{160}\text{Tb}(\text{n},\gamma)^{161}\text{Tb}$	25.8	$^{160}\text{Gd}(\alpha,\text{t})^{161}\text{Tb}-^{158}\text{Gd}()^{159}\text{Tb}$		
^{161}Dy	88.0	$^{161}\text{Dy}(\text{n},\gamma)^{162}\text{Dy}$	5.8	$^{160}\text{Dy}(\text{n},\gamma)^{161}\text{Dy}$	3.4	$^{161}\text{Dy } ^{35}\text{Cl}-^{159}\text{Tb } ^{37}\text{Cl}$
^{161}Ho	100.0	$^{160}\text{Dy}(\text{}^3\text{He},\text{d})^{161}\text{Ho}-^{164}\text{Dy}()^{165}\text{Ho}$				
^{161}Hf	65.1	$^{161}\text{Hf}-\text{u}$	19.4	$^{161}\text{Hf}(\alpha)^{157}\text{Yb}$	15.5	$^{165}\text{W}(\alpha)^{161}\text{Hf}$
$^{161}\text{Ta}^m$	56.4	$^{161}\text{Ta}^m(\alpha)^{157}\text{Lu}^m$	43.6	$^{165}\text{Re}^m(\alpha)^{161}\text{Ta}^m$		
^{161}Re	79.2	$^{161}\text{Re}(\text{p})^{160}\text{W}$	20.9	$^{161}\text{Re}^m(\text{IT})^{161}\text{Re}$		
$^{161}\text{Re}^m$	78.1	$^{161}\text{Re}^m(\text{IT})^{161}\text{Re}$	21.8	$^{165}\text{Ir}^m(\alpha)^{161}\text{Re}^m$		
^{162}Dy	100.0	$^{162}\text{Dy}(\text{n},\gamma)^{163}\text{Dy}$	12.0	$^{161}\text{Dy}(\text{n},\gamma)^{162}\text{Dy}$		
^{162}Ho	100.0	$^{161}\text{Dy}(\text{}^3\text{He},\text{d})^{162}\text{Ho}-^{164}\text{Dy}()^{165}\text{Ho}$				
^{162}Er	99.9	$^{162}\text{Er}-^{162}\text{Dy}$	0.1	$^{162}\text{Er}(\text{d},\text{p})^{163}\text{Er}$		
^{162}Hf	80.9	$^{162}\text{Hf}(\alpha)^{158}\text{Yb}$	19.1	$^{166}\text{W}(\alpha)^{162}\text{Hf}$		
^{162}W	100.0	$^{162}\text{W}(\alpha)^{158}\text{Hf}$				
^{163}Gd	36.4	$^{163}\text{Gd}-^{86}\text{Kr}_{1,895}$	32.0	$^{163}\text{Gd}-\text{u}$	31.7	$^{163}\text{Gd}-^{80}\text{Kr}_{2,038}$
^{163}Dy	40.5	$^{163}\text{Dy O}-\text{C}_{15}$	30.8	$^{163}\text{Ho}(\epsilon)^{163}\text{Dy}$	15.8	$^{163}\text{Dy}(\text{n},\gamma)^{164}\text{Dy}$
^{163}Ho	38.6	$^{163}\text{Ho}(\epsilon)^{163}\text{Dy}$	31.9	$^{163}\text{Ho O}-\text{C}_{15}$	17.0	$^{163}\text{Ho}-^{163}\text{Dy}$
^{163}Er	58.2	$^{163}\text{Er}(\beta^+)^{163}\text{Ho}$	20.9	$^{164}\text{Er}(\text{d},\text{t})^{163}\text{Er}$	20.9	$^{162}\text{Er}(\text{d},\text{p})^{163}\text{Er}$
^{163}Hf	78.6	$^{163}\text{Hf}-\text{u}$	21.4	$^{167}\text{W}(\alpha)^{163}\text{Hf}$		
^{164}Dy	83.7	$^{163}\text{Dy}(\text{n},\gamma)^{164}\text{Dy}$	12.6	$^{162}\text{Dy}(\text{}^3\text{He},\text{d})^{163}\text{Ho}-^{164}\text{Dy}()^{165}\text{Ho}$	3.1	$^{158}\text{Gd}(\alpha,\text{t})^{159}\text{Tb}-^{164}\text{Dy}()^{165}\text{Ho}$
^{164}Ho	67.1	$^{163}\text{Dy}(\text{}^3\text{He},\text{d})^{164}\text{Ho}-^{164}\text{Dy}()^{165}\text{Ho}$	32.9	$^{165}\text{Ho}(\gamma,\text{n})^{164}\text{Ho}$		
^{164}Er	100.0	$^{164}\text{Er}-^{164}\text{Dy}$	2.6	$^{164}\text{Er}(\text{n},\gamma)^{165}\text{Er}$		
^{164}Tm	76.2	$^{164}\text{Tm}-\text{u}$	23.8	$^{164}\text{Tm}(\beta^+)^{164}\text{Er}$		
^{164}Hf	68.0	$^{168}\text{W}(\alpha)^{164}\text{Hf}$	32.0	$^{164}\text{Hf}-\text{u}$		
^{164}W	81.2	$^{164}\text{W}(\alpha)^{160}\text{Hf}$	18.8	$^{168}\text{Os}(\alpha)^{164}\text{W}$		
^{164}Os	80.0	$^{164}\text{Os}(\alpha)^{160}\text{W}$	20.0	$^{165}\text{Ir}^m(\text{p})^{164}\text{Os}$		
^{165}Ho	55.6	$^{162}\text{Dy}(\text{}^3\text{He},\text{d})^{163}\text{Ho}-^{164}\text{Dy}()^{165}\text{Ho}$	23.4	$^{165}\text{Ho}(\text{n},\gamma)^{166}\text{Ho}$	11.4	$^{169}\text{Tm } ^{35}\text{Cl}_2-^{165}\text{Ho } ^{37}\text{Cl}_2$
^{165}Er	93.7	$^{164}\text{Er}(\text{n},\gamma)^{165}\text{Er}$	6.3	$^{165}\text{Tm}(\beta^+)^{165}\text{Er}$		
^{165}Tm	52.8	$^{165}\text{Tm}(\beta^+)^{165}\text{Er}$	47.2	$^{164}\text{Er}(\alpha,\text{t})^{165}\text{Tm}-^{168}\text{Er}()^{169}\text{Tm}$		
^{165}Yb	90.2	$^{165}\text{Yb}-\text{u}$	9.8	$^{165}\text{Lu}(\beta^+)^{165}\text{Yb}$		
^{165}Lu	90.2	$^{165}\text{Lu}-\text{u}$	9.8	$^{165}\text{Lu}(\beta^+)^{165}\text{Yb}$		
^{165}Ta	75.4	$^{169}\text{Re}^m(\alpha)^{165}\text{Ta}$	24.6	$^{165}\text{Ta}-\text{u}$		
^{165}W	79.9	$^{165}\text{W}-\text{u}$	20.1	$^{165}\text{W}(\alpha)^{161}\text{Hf}$		
$^{165}\text{Re}^m$	55.1	$^{165}\text{Re}^m(\alpha)^{161}\text{Ta}^m$	44.9	$^{169}\text{Ir}^m(\alpha)^{165}\text{Re}^m$		
$^{165}\text{Ir}^m$	51.6	$^{165}\text{Ir}^m(\text{p})^{164}\text{Os}$	48.4	$^{165}\text{Ir}^m(\alpha)^{161}\text{Re}^m$		
^{166}Ho	76.5	$^{165}\text{Ho}(\text{n},\gamma)^{166}\text{Ho}$	23.4	$^{166}\text{Ho}(\beta^-)^{166}\text{Er}$		
^{166}Er	54.4	$^{166}\text{Ho}(\beta^-)^{166}\text{Er}$	46.2	$^{166}\text{Er}(\text{n},\gamma)^{167}\text{Er}$		
^{166}W	77.8	$^{166}\text{W}(\alpha)^{162}\text{Hf}$	11.5	$^{166}\text{W}-\text{u}$	10.7	$^{170}\text{Os}(\alpha)^{166}\text{W}$
^{166}Os	100.0	$^{166}\text{Os}(\alpha)^{162}\text{W}$				
^{167}Er	53.1	$^{166}\text{Er}(\text{n},\gamma)^{167}\text{Er}$	32.3	$^{167}\text{Er}(\text{n},\gamma)^{168}\text{Er}$	14.6	$^{169}\text{Tm } ^{35}\text{Cl}-^{167}\text{Er } ^{37}\text{Cl}$
^{167}Tm	99.2	$^{166}\text{Er}(\alpha,\text{t})^{167}\text{Tm}-^{168}\text{Er}()^{169}\text{Tm}$	0.8	$^{167}\text{Yb}(\beta^+)^{167}\text{Tm}$		
^{167}Yb	89.3	$^{167}\text{Yb}(\beta^+)^{167}\text{Tm}$	10.7	$^{168}\text{Yb}(\text{d},\text{t})^{167}\text{Yb}$		
^{167}W	89.8	$^{171}\text{Os}(\alpha)^{167}\text{W}$	10.2	$^{167}\text{W}(\alpha)^{163}\text{Hf}$		
^{167}Ir	76.6	$^{167}\text{Ir}(\text{p})^{166}\text{Os}$	23.4	$^{167}\text{Ir}^m(\text{IT})^{167}\text{Ir}$		
$^{167}\text{Ir}^m$	70.3	$^{167}\text{Ir}^m(\text{IT})^{167}\text{Ir}$	29.7	$^{171}\text{Au}^m(\alpha)^{167}\text{Ir}^m$		
^{168}Er	67.4	$^{167}\text{Er}(\text{n},\gamma)^{168}\text{Er}$	16.7	$^{170}\text{Er}(\alpha,\text{t})^{171}\text{Tm}-^{168}\text{Er}()^{169}\text{Tm}$	11.5	$^{164}\text{Er}(\alpha,\text{t})^{165}\text{Tm}-^{168}\text{Er}()^{169}\text{Tm}$
^{168}Tm	100.0	$^{167}\text{Er}(\alpha,\text{t})^{168}\text{Tm}-^{168}\text{Er}()^{169}\text{Tm}$				
^{168}Yb	99.3	$^{168}\text{Yb}-^{168}\text{Er}$	0.7	$^{168}\text{Yb}(\text{d},\text{t})^{167}\text{Yb}$		

Table II. Influences on primary nuclides (continued, Explanation of Table on page 030003-74)

Nuclide	Infl.	Equation	Infl.	Equation	Infl.	Equation
^{168}W	58.5	$^{172}\text{Os}(\alpha)^{168}\text{W}$	22.6	$^{168}\text{W}-\text{u}$	18.9	$^{168}\text{W}(\alpha)^{164}\text{Hf}$
^{168}Os	80.0	$^{168}\text{Os}(\alpha)^{164}\text{W}$	20.0	$^{172}\text{Pt}(\alpha)^{168}\text{Os}$		
^{169}Tm	79.5	$^{169}\text{Tm}(\text{n},\gamma)^{170}\text{Tm}$	7.6	$^{170}\text{Er}(\alpha,\text{t})^{171}\text{Tm}-^{168}\text{Er}()^{169}\text{Tm}$	5.9	$^{169}\text{Tm}^{35}\text{Cl}_2-^{165}\text{Ho}^{37}\text{Cl}_2$
^{169}W	69.5	$^{173}\text{Os}(\alpha)^{169}\text{W}$	30.5	$^{169}\text{W}-\text{u}$		
$^{169}\text{Re}^m$	76.3	$^{173}\text{Ir}(\alpha)^{169}\text{Re}^m$	23.7	$^{169}\text{Re}^m(\alpha)^{165}\text{Ta}$		
$^{169}\text{Ir}^m$	53.7	$^{169}\text{Ir}^m(\alpha)^{165}\text{Re}^m$	46.3	$^{173}\text{Au}^m(\alpha)^{169}\text{Ir}^m$		
^{170}Er	53.1	$^{170}\text{Er}(\alpha,\text{t})^{171}\text{Tm}-^{168}\text{Er}()^{169}\text{Tm}$	36.3	$^{170}\text{Er}(\text{n},\gamma)^{171}\text{Er}$	8.9	$^{170}\text{Er}^{35}\text{Cl}-^{168}\text{Er}^{37}\text{Cl}$
^{170}Tm	80.2	$^{170}\text{Tm}(\beta^-)^{170}\text{Yb}$	19.8	$^{169}\text{Tm}(\text{n},\gamma)^{170}\text{Tm}$		
^{170}Yb	52.6	$^{170}\text{Yb}-^{129}\text{Xe}_{1.318}$	47.4	$^{170}\text{Yb}-^{132}\text{Xe}_{1.288}$		
^{170}W	77.7	$^{174}\text{Os}(\alpha)^{170}\text{W}$	22.3	$^{170}\text{W}-\text{u}$		
^{170}Re	80.3	$^{170}\text{Re}-\text{u}$	19.7	$^{174}\text{Ir}(\alpha)^{170}\text{Re}$		
^{170}Os	88.5	$^{170}\text{Os}(\alpha)^{166}\text{W}$	11.5	$^{170}\text{Os}-\text{u}$		
^{170}Pt	84.4	$^{170}\text{Pt}(\alpha)^{166}\text{Os}$	15.6	$^{171}\text{Au}^m(\text{p})^{170}\text{Pt}$		
^{171}Er	61.8	$^{170}\text{Er}(\text{n},\gamma)^{171}\text{Er}$	38.2	$^{171}\text{Er}(\beta^-)^{171}\text{Tm}$		
^{171}Tm	94.4	$^{171}\text{Tm}(\beta^-)^{171}\text{Yb}$	4.3	$^{170}\text{Er}(\alpha,\text{t})^{171}\text{Tm}-^{168}\text{Er}()^{169}\text{Tm}$	1.2	$^{171}\text{Er}(\beta^-)^{171}\text{Tm}$
^{171}Yb	100.0	$^{171}\text{Yb}-^{129}\text{Xe}_{1.326}$				
^{171}Lu	61.5	$^{170}\text{Yb}(\alpha,\text{t})^{171}\text{Lu}-^{174}\text{Yb}()^{175}\text{Lu}$	38.5	$^{171}\text{Lu}(\beta^+)^{171}\text{Yb}$		
^{171}Os	81.4	$^{171}\text{Os}-\text{u}$	9.6	$^{171}\text{Os}(\alpha)^{167}\text{W}$	9.0	$^{175}\text{Pt}(\alpha)^{171}\text{Os}$
$^{171}\text{Au}^m$	61.0	$^{171}\text{Au}^m(\text{p})^{170}\text{Pt}$	39.0	$^{171}\text{Au}^m(\alpha)^{167}\text{Ir}^m$		
^{172}Er	87.1	$^{170}\text{Er}(\text{t},\text{p})^{172}\text{Er}$	12.9	$^{172}\text{Er}(\beta^-)^{172}\text{Tm}$		
^{172}Tm	69.7	$^{172}\text{Er}(\beta^-)^{172}\text{Tm}$	30.3	$^{172}\text{Tm}(\beta^-)^{172}\text{Yb}$		
^{172}Yb	100.0	$^{172}\text{Yb}-^{132}\text{Xe}_{1.303}$				
^{172}Lu	100.0	$^{171}\text{Yb}(\alpha,\text{t})^{172}\text{Lu}-^{174}\text{Yb}()^{175}\text{Lu}$				
^{172}Re	54.4	$^{176}\text{Ir}(\alpha)^{172}\text{Re}$	45.6	$^{172}\text{Re}-\text{u}$		
^{172}Os	65.8	$^{176}\text{Pt}(\alpha)^{172}\text{Os}$	34.2	$^{172}\text{Os}(\alpha)^{168}\text{W}$		
^{172}Pt	77.2	$^{172}\text{Pt}(\alpha)^{168}\text{Os}$	22.8	$^{176}\text{Hg}(\alpha)^{172}\text{Pt}$		
^{173}Yb	55.8	$^{173}\text{Yb}-^{129}\text{Xe}_{1.341}$	44.2	$^{173}\text{Yb}-^{132}\text{Xe}_{1.311}$		
^{173}Lu	100.0	$^{172}\text{Yb}(\alpha,\text{t})^{173}\text{Lu}-^{174}\text{Yb}()^{175}\text{Lu}$				
^{173}Os	43.9	$^{177}\text{Pt}(\alpha)^{173}\text{Os}$	28.7	$^{173}\text{Os}-\text{u}$	27.4	$^{173}\text{Os}(\alpha)^{169}\text{W}$
^{173}Ir	86.4	$^{177}\text{Au}(\alpha)^{173}\text{Ir}$	13.6	$^{173}\text{Ir}(\alpha)^{169}\text{Re}^m$		
$^{173}\text{Au}^m$	52.2	$^{173}\text{Au}^m(\alpha)^{169}\text{Ir}^m$	47.8	$^{177}\text{Tl}^m(\alpha)^{173}\text{Au}^m$		
^{174}Yb	68.3	$^{174}\text{Yb}-^{129}\text{Xe}_{1.349}$	31.7	$^{174}\text{Yb}-^{132}\text{Xe}_{1.318}$		
^{174}Lu	100.0	$^{173}\text{Yb}(\alpha,\text{t})^{174}\text{Lu}-^{174}\text{Yb}()^{175}\text{Lu}$				
^{174}Hf	74.2	$^{176}\text{Hf}^{35}\text{Cl}-^{174}\text{Hf}^{37}\text{Cl}$	13.8	$^{174}\text{Hf}(\text{n},\gamma)^{175}\text{Hf}$	11.9	$^{176}\text{Hf}(\text{p},\text{t})^{174}\text{Hf}$
^{174}Os	74.7	$^{178}\text{Pt}(\alpha)^{174}\text{Os}$	13.5	$^{174}\text{Os}-\text{u}$	11.9	$^{174}\text{Os}(\alpha)^{170}\text{W}$
^{174}Ir	77.3	$^{174}\text{Ir}(\alpha)^{170}\text{Re}$	22.7	$^{178}\text{Au}(\alpha)^{174}\text{Ir}$		
^{175}Yb	99.9	$^{174}\text{Yb}(\text{n},\gamma)^{175}\text{Yb}$	0.1	$^{175}\text{Yb}(\beta^-)^{175}\text{Lu}$		
^{175}Lu	54.2	$^{175}\text{Yb}(\beta^-)^{175}\text{Lu}$	20.9	$^{175}\text{Lu}(\text{n},\gamma)^{176}\text{Lu}$	13.7	$^{175}\text{Lu}^{35}\text{Cl}-^{173}\text{Yb}^{37}\text{Cl}$
^{175}Hf	85.7	$^{174}\text{Hf}(\text{n},\gamma)^{175}\text{Hf}$	14.3	$^{177}\text{Hf}(\text{p},\text{t})^{175}\text{Hf}$		
^{175}Os	82.2	$^{179}\text{Pt}(\alpha)^{175}\text{Os}$	17.8	$^{175}\text{Os}-\text{u}$		
^{175}Ir	80.4	$^{179}\text{Au}(\alpha)^{175}\text{Ir}$	19.6	$^{175}\text{Ir}-\text{u}$		
^{175}Pt	90.6	$^{175}\text{Pt}(\alpha)^{171}\text{Os}$	9.4	$^{179}\text{Hg}(\alpha)^{175}\text{Pt}$		
^{176}Yb	73.0	$^{176}\text{Yb}-^{129}\text{Xe}_{1.364}$	27.0	$^{176}\text{Yb}-^{132}\text{Xe}_{1.333}$		
^{176}Lu	78.9	$^{175}\text{Lu}(\text{n},\gamma)^{176}\text{Lu}$	11.4	$^{176}\text{Lu}^{37}\text{Cl}-^{143}\text{Nd}^{35}\text{Cl}_2$	7.7	$^{176}\text{Lu}(\text{n},\gamma)^{177}\text{Lu}$
^{176}Hf	74.5	$^{176}\text{Lu}(\beta^-)^{176}\text{Hf}$	23.3	$^{180}\text{W}(\alpha)^{176}\text{Hf}$	1.9	$^{176}\text{Hf}^{35}\text{Cl}-^{174}\text{Hf}^{37}\text{Cl}$
^{176}Ir	59.3	$^{180}\text{Au}(\alpha)^{176}\text{Ir}$	35.9	$^{176}\text{Ir}-\text{u}$	4.8	$^{176}\text{Ir}(\alpha)^{172}\text{Re}$
^{176}Pt	66.4	$^{180}\text{Hg}(\alpha)^{176}\text{Pt}$	33.6	$^{176}\text{Pt}(\alpha)^{172}\text{Os}$		
^{176}Hg	71.9	$^{176}\text{Hg}(\alpha)^{172}\text{Pt}$	28.1	$^{177}\text{Tl}^m(\text{p})^{176}\text{Hg}$		
^{177}Lu	91.5	$^{176}\text{Lu}(\text{n},\gamma)^{177}\text{Lu}$	8.4	$^{177}\text{Lu}(\beta^-)^{177}\text{Hf}$	0.1	$^{179}\text{Hf}(\text{t},\alpha)^{178}\text{Lu}-^{178}\text{Hf}()^{177}\text{Lu}$
^{177}Hf	69.9	$^{177}\text{Lu}(\beta^-)^{177}\text{Hf}$	28.7	$^{177}\text{Hf}(\text{n},\gamma)^{178}\text{Hf}$	1.4	$^{177}\text{Hf}(\text{p},\text{t})^{175}\text{Hf}$
^{177}Pt	55.3	$^{177}\text{Pt}(\alpha)^{173}\text{Os}$	28.8	$^{177}\text{Pt}-\text{u}$	16.0	$^{181}\text{Hg}(\alpha)^{177}\text{Pt}$
^{177}Au	87.9	$^{181}\text{Tl}(\alpha)^{177}\text{Au}$	12.1	$^{177}\text{Au}(\alpha)^{173}\text{Ir}$		

Table II. Influences on primary nuclides (continued, Explanation of Table on page 030003-74)

Nuclide	Infl.	Equation	Infl.	Equation	Infl.	Equation
$^{177}\text{Tl}^m$	62.3	$^{177}\text{Tl}^m(\text{p})^{176}\text{Hg}$	37.7	$^{177}\text{Tl}^m(\alpha)^{173}\text{Au}^m$		
^{178}Lu	89.4	$^{179}\text{Hf}(\text{t},\alpha)^{178}\text{Lu}-^{178}\text{Hf}(\text{)}^{177}\text{Lu}$	10.6	$^{178}\text{Lu}^m(\text{IT})^{178}\text{Lu}$		
$^{178}\text{Lu}^m$	65.7	$^{178}\text{Lu}^m(\text{IT})^{178}\text{Lu}$	34.3	$^{176}\text{Lu}(\text{t,p})^{178}\text{Lu}^m$		
^{178}Hf	70.5	$^{177}\text{Hf}(\text{n},\gamma)^{178}\text{Hf}$	29.5	$^{178}\text{Hf}(\text{n},\gamma)^{179}\text{Hf}$		
^{178}Os	76.2	$^{182}\text{Pt}(\alpha)^{178}\text{Os}$	23.8	$^{178}\text{Os}-\text{u}$		
^{178}Pt	62.4	$^{182}\text{Hg}(\alpha)^{178}\text{Pt}$	24.5	$^{178}\text{Pt}(\alpha)^{174}\text{Os}$	13.1	$^{178}\text{Pt}-\text{u}$
^{178}Au	96.9	$^{178}\text{Au}-^{133}\text{Cs}_{1.338}$	3.1	$^{178}\text{Au}(\alpha)^{174}\text{Ir}$		
^{179}Lu	100.0	$^{180}\text{Hf}(\text{t},\alpha)^{179}\text{Lu}-^{178}\text{Hf}(\text{)}^{177}\text{Lu}$				
^{179}Hf	70.3	$^{178}\text{Hf}(\text{n},\gamma)^{179}\text{Hf}$	15.9	$^{179}\text{Hf}(\text{n},\gamma)^{180}\text{Hf}$	7.0	$^{181}\text{Ta } ^{35}\text{Cl}-^{179}\text{Hf } ^{37}\text{Cl}$
^{179}Ta	92.7	$^{179}\text{Ta}(\text{e})^{179}\text{Hf}$	7.3	$^{181}\text{Ta}(\text{p,t})^{179}\text{Ta}$		
^{179}W	93.5	$^{180}\text{W}(\text{d,t})^{179}\text{W}$	6.5	$^{179}\text{Re}(\beta^+)^{179}\text{W}$		
^{179}Re	77.7	$^{179}\text{Re}-\text{u}$	22.3	$^{179}\text{Re}(\beta^+)^{179}\text{W}$		
^{179}Os	65.1	$^{183}\text{Pt}(\alpha)^{179}\text{Os}$	34.9	$^{179}\text{Os}-\text{u}$		
^{179}Ir	87.8	$^{183}\text{Au}(\alpha)^{179}\text{Ir}$	12.2	$^{179}\text{Ir}-\text{u}$		
^{179}Pt	92.8	$^{183}\text{Hg}(\alpha)^{179}\text{Pt}$	7.2	$^{179}\text{Pt}(\alpha)^{175}\text{Os}$		
^{179}Au	66.6	$^{183}\text{Tl}^m(\alpha)^{179}\text{Au}$	16.9	$^{179}\text{Au}(\alpha)^{175}\text{Ir}$	16.4	$^{179}\text{Au}-\text{u}$
^{179}Hg	74.1	$^{179}\text{Hg}-^{208}\text{Pb}_{.861}$	25.9	$^{179}\text{Hg}(\alpha)^{175}\text{Pt}$		
^{180}Hf	83.5	$^{179}\text{Hf}(\text{n},\gamma)^{180}\text{Hf}$	16.5	$^{180}\text{W}-^{180}\text{Hf}$		
^{180}W	81.8	$^{180}\text{W}-^{180}\text{Hf}$	18.2	$^{180}\text{W}(\alpha)^{176}\text{Hf}$	0.1	$^{180}\text{W}(\text{d,t})^{179}\text{W}$
^{180}Os	65.6	$^{184}\text{Pt}(\alpha)^{180}\text{Os}$	34.4	$^{180}\text{Os}-\text{u}$		
^{180}Au	94.0	$^{180}\text{Au}-^{133}\text{Cs}_{1.353}$	4.0	$^{184}\text{Tl}(\alpha)^{180}\text{Au}$	2.0	$^{180}\text{Au}(\alpha)^{176}\text{Ir}$
^{180}Hg	38.0	$^{180}\text{Hg}-^{208}\text{Pb}_{.865}$	32.8	$^{180}\text{Hg}(\alpha)^{176}\text{Pt}$	29.2	$^{184}\text{Pb}(\alpha)^{180}\text{Hg}$
^{181}Ta	25.5	$^{181}\text{Ta}(\text{n},\gamma)^{182}\text{Ta}$	21.9	$^{181}\text{Ta O}-^{202}\text{Tl}_{.975}$	21.6	$^{183}\text{W } ^{35}\text{Cl}-^{181}\text{Ta } ^{37}\text{Cl}$
^{181}Os	64.0	$^{181}\text{Os}-\text{u}$	36.0	$^{185}\text{Pt}(\alpha)^{181}\text{Os}$		
^{181}Pt	52.0	$^{185}\text{Hg}(\alpha)^{181}\text{Pt}$	48.0	$^{181}\text{Pt}-\text{u}$		
^{181}Hg	83.0	$^{181}\text{Hg}(\alpha)^{177}\text{Pt}$	17.0	$^{181}\text{Hg}-^{208}\text{Pb}_{.870}$		
^{181}Tl	79.0	$^{181}\text{Tl}-^{133}\text{Cs}_{1.361}$	12.2	$^{185}\text{Bi}^m(\alpha)^{181}\text{Tl}$	8.8	$^{181}\text{Tl}(\alpha)^{177}\text{Au}$
^{182}Ta	74.4	$^{181}\text{Ta}(\text{n},\gamma)^{182}\text{Ta}$	25.6	$^{182}\text{Ta}(\beta^-)^{182}\text{W}$		
^{182}W	100.0	$^{182}\text{W}(\text{n},\gamma)^{183}\text{W}$	4.0	$^{182}\text{Ta}(\beta^-)^{182}\text{W}$		
^{182}Os	60.6	$^{182}\text{Os}-\text{u}$	39.4	$^{186}\text{Pt}(\alpha)^{182}\text{Os}$		
^{182}Ir	56.3	$^{182}\text{Ir}-\text{u}$	43.7	$^{186}\text{Au}(\alpha)^{182}\text{Ir}$		
^{182}Pt	56.8	$^{186}\text{Hg}(\alpha)^{182}\text{Pt}$	22.0	$^{182}\text{Pt}-\text{u}$	21.2	$^{182}\text{Pt}(\alpha)^{178}\text{Os}$
^{182}Hg	55.3	$^{182}\text{Hg}-^{208}\text{Pb}_{.875}$	32.4	$^{182}\text{Hg}(\alpha)^{178}\text{Pt}$	12.3	$^{182}\text{Hg}-\text{u}$
^{183}W	72.0	$^{183}\text{W}(\text{n},\gamma)^{184}\text{W}$	15.4	$^{183}\text{W O}-\text{C}_2 ^{35}\text{Cl}_5$	11.2	$^{199}\text{Hg}-^{183}\text{W O}$
^{183}Os	76.7	$^{183}\text{Os}-\text{u}$	23.3	$^{183}\text{Ir}(\beta^+)^{183}\text{Os}$		
^{183}Ir	76.2	$^{183}\text{Ir}-\text{u}$	19.3	$^{187}\text{Au}(\alpha)^{183}\text{Ir}$	4.5	$^{183}\text{Ir}(\beta^+)^{183}\text{Os}$
^{183}Pt	30.5	$^{187}\text{Hg}(\alpha)^{183}\text{Pt}$	27.9	$^{183}\text{Pt}(\alpha)^{179}\text{Os}$	27.2	$^{183}\text{Pt}-\text{u}$
^{183}Au	77.4	$^{187}\text{Tl}^m(\alpha)^{183}\text{Au}$	11.4	$^{183}\text{Au}-\text{u}$	11.2	$^{183}\text{Au}(\alpha)^{179}\text{Ir}$
^{183}Hg	62.6	$^{187}\text{Pb}(\alpha)^{183}\text{Hg}$	31.8	$^{183}\text{Hg}-^{208}\text{Pb}_{.880}$	5.6	$^{183}\text{Hg}(\alpha)^{179}\text{Pt}$
^{183}Tl	82.9	$^{183}\text{Tl}-^{133}\text{Cs}_{1.376}$	17.1	$^{183}\text{Tl}^m(\text{IT})^{183}\text{Tl}$		
$^{183}\text{Tl}^m$	82.9	$^{183}\text{Tl}^m(\text{IT})^{183}\text{Tl}$	17.1	$^{183}\text{Tl}^m(\alpha)^{179}\text{Au}$		
^{184}W	28.0	$^{184}\text{W}-\text{u}$	26.8	$^{183}\text{W}(\text{n},\gamma)^{184}\text{W}$	15.4	$^{184}\text{Os}-^{184}\text{W}$
^{184}Re	100.0	$^{185}\text{Re}(\text{d,t})^{184}\text{Re}-^{187}\text{Re}(\text{)}^{186}\text{Re}$				
^{184}Os	44.3	$^{184}\text{Os}(\text{n},\gamma)^{185}\text{Os}$	31.0	$^{184}\text{Os}-^{184}\text{W}$	24.3	$^{184}\text{Os}-\text{u}$
^{184}Pt	40.3	$^{188}\text{Hg}(\alpha)^{184}\text{Pt}$	31.1	$^{184}\text{Pt}-\text{u}$	28.6	$^{184}\text{Pt}(\alpha)^{180}\text{Os}$
^{184}Hg	38.9	$^{184}\text{Hg}-\text{u}$	32.1	$^{184}\text{Hg}-^{208}\text{Pb}_{.885}$	29.0	$^{184}\text{Hg}-^{204}\text{Pb}_{.902}$
^{184}Tl	78.5	$^{184}\text{Tl}(\alpha)^{180}\text{Au}$	21.5	$^{184}\text{Tl}-^{133}\text{Cs}_{1.383}$		
^{184}Pb	69.5	$^{184}\text{Pb}(\alpha)^{180}\text{Hg}$	30.5	$^{185}\text{Bi}^m(\text{p})^{184}\text{Pb}$		
^{185}W	84.7	$^{184}\text{W}(\text{n},\gamma)^{185}\text{W}$	15.3	$^{185}\text{W}(\beta^-)^{185}\text{Re}$		
^{185}Re	38.8	$^{185}\text{Os}(\text{e})^{185}\text{Re}$	28.5	$^{185}\text{W}(\beta^-)^{185}\text{Re}$	27.2	$^{185}\text{Re}(\text{n},\gamma)^{186}\text{Re}$
^{185}Os	51.0	$^{184}\text{Os}(\text{n},\gamma)^{185}\text{Os}$	49.0	$^{185}\text{Os}(\text{e})^{185}\text{Re}$		
^{185}Pt	60.3	$^{185}\text{Pt}(\alpha)^{181}\text{Os}$	39.7	$^{185}\text{Pt}-\text{u}$		

Table II. Influences on primary nuclides (continued, Explanation of Table on page 030003-74)

Nuclide	Infl.	Equation	Infl.	Equation	Infl.	Equation
^{203}Fr	84.5	$^{203}\text{Fr}(\alpha)^{199}\text{At}$	15.5	$^{203}\text{Fr}-^{133}\text{Cs}_{1.526}$		
^{204}Hg	79.2	$^{204}\text{Hg}-\text{u}$	10.8	$^{204}\text{Hg} \ ^{35}\text{Cl}_2-^{200}\text{Hg} \ ^{37}\text{Cl}_2$	9.4	$^{204}\text{Hg} \ ^{35}\text{Cl}-^{202}\text{Hg} \ ^{37}\text{Cl}$
^{204}Tl	68.0	$^{204}\text{Tl}(\beta^-)^{204}\text{Pb}$	28.3	$^{203}\text{Tl}(\text{n},\gamma)^{204}\text{Tl}$	3.7	$^{205}\text{Tl}(\text{d},\text{t})^{204}\text{Tl}$
^{204}Pb	69.5	$^{204}\text{Pb}(\text{n},\gamma)^{205}\text{Pb}$	29.1	$^{204}\text{Tl}(\beta^-)^{204}\text{Pb}$	1.1	$^{204}\text{Pb}(\text{p},\text{t})^{202}\text{Pb}$
^{204}At	81.2	$^{204}\text{At}-\text{u}$	18.8	$^{208}\text{Fr}(\alpha)^{204}\text{At}$		
^{204}Rn	80.6	$^{204}\text{Rn}-^{208}\text{Pb}_{.981}$	19.4	$^{204}\text{Rn}(\alpha)^{200}\text{Po}$		
^{205}Hg	52.5	$^{204}\text{Hg}(\text{d},\text{p})^{205}\text{Hg}$	47.5	$^{202}\text{Hg}(\text{d},\text{p})^{203}\text{Hg}-^{204}\text{Hg}(\text{)}^{205}\text{Hg}$		
^{205}Tl	60.2	$^{205}\text{Tl}(\text{d},\text{t})^{204}\text{Tl}$	14.9	$^{205}\text{Tl} \ ^{35}\text{Cl}-^{203}\text{Tl} \ ^{37}\text{Cl}$	12.2	$^{205}\text{Tl}(\text{ }^3\text{He},\text{d})^{206}\text{Pb}$
^{205}Pb	69.3	$^{205}\text{Pb}(\text{n},\gamma)^{206}\text{Pb}$	29.4	$^{204}\text{Pb}(\text{n},\gamma)^{205}\text{Pb}$	1.3	$^{205}\text{Bi}(\beta^+)^{205}\text{Pb}$
^{205}Bi	50.9	$^{205}\text{Bi}(\beta^+)^{205}\text{Pb}$	49.1	$^{209}\text{At}(\alpha)^{205}\text{Bi}$		
^{205}Po	75.5	$^{209}\text{Rn}(\alpha)^{205}\text{Po}$	19.3	$^{205}\text{Po}-\text{u}$	5.2	$^{205}\text{Po}(\alpha)^{201}\text{Pb}$
^{205}Rn	68.5	$^{205}\text{Rn}(\alpha)^{201}\text{Po}$	31.5	$^{205}\text{Rn}-^{208}\text{Pb}_{.986}$		
^{206}Tl	83.7	$^{205}\text{Tl}(\text{n},\gamma)^{206}\text{Tl}$	16.3	$^{210}\text{Bi}(\alpha)^{206}\text{Tl}$		
^{206}Pb	53.8	$^{206}\text{Pb} \ ^{35}\text{Cl}_2-^{202}\text{Hg} \ ^{37}\text{Cl}_2$	30.4	$^{205}\text{Pb}(\text{n},\gamma)^{206}\text{Pb}$	13.2	$^{206}\text{Pb}(\text{n},\gamma)^{207}\text{Pb}$
^{206}At	42.8	$^{210}\text{Fr}(\alpha)^{206}\text{At}$	29.0	$^{206}\text{At}-\text{u}$	28.1	$^{206}\text{At}(\alpha)^{202}\text{Bi}$
^{206}Rn	37.8	$^{206}\text{Rn}-^{133}\text{Cs}_{1.549}$	37.4	$^{206}\text{Rn}-^{208}\text{Pb}_{.990}$	24.8	$^{206}\text{Rn}(\alpha)^{202}\text{Po}$
^{207}Tl	44.9	$^{207}\text{Tl}(\beta^-)^{207}\text{Pb}$	42.4	$^{211}\text{Bi}(\alpha)^{207}\text{Tl}$	12.8	$^{205}\text{Tl}(\text{t},\text{p})^{207}\text{Tl}$
^{207}Pb	86.6	$^{206}\text{Pb}(\text{n},\gamma)^{207}\text{Pb}$	12.7	$^{207}\text{Pb}(\text{n},\gamma)^{208}\text{Pb}$	0.7	$^{207}\text{Tl}(\beta^-)^{207}\text{Pb}$
^{207}Bi	97.4	$^{209}\text{Bi}(\text{p},\text{t})^{207}\text{Bi}$	2.6	$^{207}\text{Po}(\beta^+)^{207}\text{Bi}$		
^{207}Po	58.8	$^{207}\text{Po}(\alpha)^{203}\text{Pb}$	41.2	$^{207}\text{Po}(\beta^+)^{207}\text{Bi}$		
^{207}Fr	88.3	$^{207}\text{Fr}-^{133}\text{Cs}_{1.556}$	11.7	$^{207}\text{Fr}(\alpha)^{203}\text{At}$		
^{208}Pb	87.3	$^{207}\text{Pb}(\text{n},\gamma)^{208}\text{Pb}$	9.0	$^{212}\text{Po}(\alpha)^{208}\text{Pb}$	1.1	$^{205}\text{Rn}-^{208}\text{Pb}_{.986}$
^{208}Fr	95.5	$^{208}\text{Fr}-^{133}\text{Cs}_{1.564}$	4.5	$^{208}\text{Fr}(\alpha)^{204}\text{At}$		
^{209}Pb	86.9	$^{209}\text{Pb}(\beta^-)^{209}\text{Bi}$	11.1	$^{208}\text{Pb}(\text{d},\text{p})^{209}\text{Pb}$	2.0	$^{213}\text{Po}(\alpha)^{209}\text{Pb}$
^{209}Bi	85.8	$^{209}\text{Bi}(\text{n},\gamma)^{210}\text{Bi}$	9.6	$^{209}\text{Bi}(\alpha)^{205}\text{Tl}$	4.3	$^{209}\text{Pb}(\beta^-)^{209}\text{Bi}$
^{209}At	53.1	$^{213}\text{Fr}(\alpha)^{209}\text{At}$	46.9	$^{209}\text{At}(\alpha)^{205}\text{Bi}$		
^{209}Rn	76.2	$^{213}\text{Ra}(\alpha)^{209}\text{Rn}$	23.8	$^{209}\text{Rn}(\alpha)^{205}\text{Po}$		
^{210}Pb	97.5	$^{210}\text{Pb}(\beta^-)^{210}\text{Bi}$	2.5	$^{214}\text{Po}(\alpha)^{210}\text{Pb}$		
^{210}Bi	50.3	$^{210}\text{Bi}(\beta^-)^{210}\text{Po}$	33.5	$^{210}\text{Bi}(\alpha)^{206}\text{Tl}$	14.1	$^{209}\text{Bi}(\text{n},\gamma)^{210}\text{Bi}$
^{210}Po	98.1	$^{210}\text{Po}(\alpha)^{206}\text{Pb}$	1.9	$^{210}\text{Bi}(\beta^-)^{210}\text{Po}$		
^{210}Fr	54.3	$^{210}\text{Fr}(\alpha)^{206}\text{At}$	45.7	$^{210}\text{Fr}-^{226}\text{Ra}_{.929}$		
^{211}Pb	95.8	$^{215}\text{Po}(\alpha)^{211}\text{Pb}$	4.2	$^{211}\text{Pb}(\beta^-)^{211}\text{Bi}$		
^{211}Bi	57.5	$^{211}\text{Bi}(\alpha)^{207}\text{Tl}$	42.5	$^{211}\text{Pb}(\beta^-)^{211}\text{Bi}$		
^{211}Fr	73.6	$^{211}\text{Fr}-^{133}\text{Cs}_{1.586}$	26.4	$^{211}\text{Fr}-^{226}\text{Ra}_{.934}$		
^{212}Pb	67.1	$^{216}\text{Po}(\alpha)^{212}\text{Pb}$	32.9	$^{212}\text{Pb}(\beta^-)^{212}\text{Bi}$		
^{212}Bi	66.3	$^{212}\text{Bi}(\beta^-)^{212}\text{Po}$	33.7	$^{212}\text{Pb}(\beta^-)^{212}\text{Bi}$		
^{212}Po	90.9	$^{212}\text{Po}(\alpha)^{208}\text{Pb}$	9.1	$^{212}\text{Bi}(\beta^-)^{212}\text{Po}$		
^{212}Fr	88.7	$^{212}\text{Fr}-^{133}\text{Cs}_{1.594}$	11.3	$^{212}\text{Fr}-^{226}\text{Ra}_{.938}$		
^{213}Bi	76.7	$^{217}\text{At}(\alpha)^{213}\text{Bi}$	23.3	$^{213}\text{Bi}(\beta^-)^{213}\text{Po}$		
^{213}Po	93.2	$^{213}\text{Po}(\alpha)^{209}\text{Pb}$	6.8	$^{213}\text{Bi}(\beta^-)^{213}\text{Po}$		
^{213}Fr	54.5	$^{213}\text{Fr}-^{133}\text{Cs}_{1.602}$	45.5	$^{213}\text{Fr}(\alpha)^{209}\text{At}$		
^{213}Ra	77.2	$^{213}\text{Ra}-^{133}\text{Cs}_{1.602}$	22.8	$^{213}\text{Ra}(\alpha)^{209}\text{Rn}$		
^{214}Pb	99.4	$^{218}\text{Po}(\alpha)^{214}\text{Pb}$	0.6	$^{214}\text{Pb}(\beta^-)^{214}\text{Bi}$		
^{214}Bi	68.9	$^{214}\text{Bi}(\beta^-)^{214}\text{Po}$	31.1	$^{214}\text{Pb}(\beta^-)^{214}\text{Bi}$		
^{214}Po	97.4	$^{214}\text{Po}(\alpha)^{210}\text{Pb}$	2.2	$^{218}\text{Rn}(\alpha)^{214}\text{Po}$	0.3	$^{214}\text{Bi}(\beta^-)^{214}\text{Po}$
^{215}Bi	85.8	$^{219}\text{At}(\alpha)^{215}\text{Bi}$	14.2	$^{215}\text{Bi}-^{133}\text{Cs}_{1.617}$		
^{215}Po	96.3	$^{219}\text{Rn}(\alpha)^{215}\text{Po}$	3.7	$^{215}\text{Po}(\alpha)^{211}\text{Pb}$		
^{216}Po	68.9	$^{220}\text{Rn}(\alpha)^{216}\text{Po}$	31.1	$^{216}\text{Po}(\alpha)^{212}\text{Pb}$		
^{217}At	77.7	$^{221}\text{Fr}(\alpha)^{217}\text{At}$	22.3	$^{217}\text{At}(\alpha)^{213}\text{Bi}$		
^{218}Po	99.4	$^{222}\text{Rn}(\alpha)^{218}\text{Po}$	0.6	$^{218}\text{Po}(\alpha)^{214}\text{Pb}$		
^{218}Rn	93.5	$^{218}\text{Rn}(\alpha)^{214}\text{Po}$	6.5	$^{222}\text{Ra}(\alpha)^{218}\text{Rn}$		
^{219}At	78.7	$^{223}\text{Fr}(\alpha)^{219}\text{At}$	17.1	$^{219}\text{At}-^{133}\text{Cs}_{1.647}$	4.2	$^{219}\text{At}(\alpha)^{215}\text{Bi}$

Table II. Influences on primary nuclides (continued, Explanation of Table on page 030003-74)

Nuclide	Infl.	Equation	Infl.	Equation	Infl.	Equation
^{219}Rn	96.4	$^{223}\text{Ra}(\alpha)^{219}\text{Rn}$	3.6	$^{219}\text{Rn}(\alpha)^{215}\text{Po}$		
^{220}Rn	68.9	$^{224}\text{Ra}(\alpha)^{220}\text{Rn}$	31.1	$^{220}\text{Rn}(\alpha)^{216}\text{Po}$		
^{221}Fr	79.1	$^{225}\text{Ac}(\alpha)^{221}\text{Fr}$	20.9	$^{221}\text{Fr}(\alpha)^{217}\text{At}$		
^{222}Rn	99.4	$^{226}\text{Ra}(\alpha)^{222}\text{Rn}$	0.6	$^{222}\text{Rn}(\alpha)^{218}\text{Po}$		
^{222}Ra	62.4	$^{222}\text{Ra}(\alpha)^{218}\text{Rn}$	37.6	$^{226}\text{Th}(\alpha)^{222}\text{Ra}$		
^{223}Rn	58.3	$^{223}\text{Rn}-^{133}\text{Cs}_{1.677}$	41.7	$^{223}\text{Rn}-\text{u}$		
^{223}Fr	93.6	$^{227}\text{Ac}(\alpha)^{223}\text{Fr}$	6.4	$^{223}\text{Fr}(\alpha)^{219}\text{At}$		
^{223}Ra	96.4	$^{227}\text{Th}(\alpha)^{223}\text{Ra}$	3.6	$^{223}\text{Ra}(\alpha)^{219}\text{Rn}$		
^{224}Rn	56.6	$^{224}\text{Rn}-\text{u}$	43.4	$^{224}\text{Rn}-^{133}\text{Cs}_{1.684}$		
^{224}Ra	69.1	$^{228}\text{Th}(\alpha)^{224}\text{Ra}$	30.9	$^{224}\text{Ra}(\alpha)^{220}\text{Rn}$		
^{225}Rn	73.0	$^{225}\text{Rn}-\text{u}$	27.0	$^{225}\text{Rn}-^{133}\text{Cs}_{1.692}$		
^{225}Fr	84.2	$^{225}\text{Fr}-\text{u}$	15.8	$^{225}\text{Fr}(\beta^-)^{225}\text{Ra}$	0.6	$^{225}\text{Fr}(\beta^-)^{225}\text{Ra}$
^{225}Ra	94.8	$^{229}\text{Th}(\alpha)^{225}\text{Ra}$	4.6	$^{225}\text{Ra}(\beta^-)^{225}\text{Ac}$	19.4	$^{225}\text{Ac}(\alpha)^{221}\text{Fr}$
^{225}Ac	60.1	$^{229}\text{Pa}(\alpha)^{225}\text{Ac}$	20.5	$^{225}\text{Ra}(\beta^-)^{225}\text{Ac}$		
^{226}Rn	56.2	$^{226}\text{Rn}-\text{u}$	43.8	$^{226}\text{Rn}-^{133}\text{Cs}_{1.699}$		
^{226}Fr	73.5	$^{226}\text{Fr}-^{133}\text{Cs}_{1.699}$	26.5	$^{226}\text{Fr}-\text{u}$		
^{226}Ra	98.2	$^{230}\text{Th}(\alpha)^{226}\text{Ra}$	0.6	$^{226}\text{Ra}(\alpha)^{222}\text{Rn}$	0.4	$^{211}\text{Fr}-^{226}\text{Ra}_{.934}$
^{226}Ac	87.1	$^{230}\text{Pa}(\alpha)^{226}\text{Ac}$	12.9	$^{226}\text{Ac}(\beta^-)^{226}\text{Th}$		
^{226}Th	61.1	$^{226}\text{Th}(\alpha)^{222}\text{Ra}$	38.9	$^{226}\text{Ac}(\beta^-)^{226}\text{Th}$		
^{227}Rn	63.4	$^{227}\text{Rn}-^{133}\text{Cs}_{1.707}$	36.6	$^{227}\text{Rn}-\text{u}$		
^{227}Fr	79.5	$^{227}\text{Fr}-^{133}\text{Cs}_{1.707}$	20.5	$^{227}\text{Fr}-\text{u}$		
^{227}Ac	90.7	$^{231}\text{Pa}(\alpha)^{227}\text{Ac}$	6.4	$^{227}\text{Ac}(\alpha)^{223}\text{Fr}$	3.0	$^{227}\text{Ac}(\beta^-)^{227}\text{Th}$
^{227}Th	96.4	$^{227}\text{Ac}(\beta^-)^{227}\text{Th}$	3.6	$^{227}\text{Th}(\alpha)^{223}\text{Ra}$		
^{228}Rn	62.5	$^{228}\text{Rn}-^{133}\text{Cs}_{1.714}$	37.5	$^{228}\text{Rn}-\text{u}$		
^{228}Fr	79.6	$^{228}\text{Fr}-^{133}\text{Cs}_{1.714}$	20.4	$^{228}\text{Fr}-\text{u}$		
^{228}Th	68.6	$^{230}\text{Th}(\text{p,t})^{228}\text{Th}-^{232}\text{Th}(\text{O})^{230}\text{Th}$	30.6	$^{228}\text{Th}(\alpha)^{224}\text{Ra}$	0.8	$^{232}\text{U}(\alpha)^{228}\text{Th}$
^{229}Fr	70.4	$^{229}\text{Fr}-^{133}\text{Cs}_{1.722}$	16.8	$^{229}\text{Fr}-^{238}\text{U}_{.962}$	12.8	$^{229}\text{Fr}-\text{u}$
^{229}Th	70.1	$^{233}\text{U}(\alpha)^{229}\text{Th}$	25.5	$^{230}\text{Th}(\text{d,t})^{229}\text{Th}$	4.3	$^{229}\text{Th}(\alpha)^{225}\text{Ra}$
^{229}Pa	87.4	$^{231}\text{Pa}(\text{p,t})^{229}\text{Pa}$	12.6	$^{229}\text{Pa}(\alpha)^{225}\text{Ac}$		
^{230}Fr	87.7	$^{230}\text{Fr}-^{133}\text{Cs}_{1.729}$	12.3	$^{230}\text{Fr}-\text{u}$		
^{230}Th	39.0	$^{234}\text{U}(\alpha)^{230}\text{Th}$	32.4	$^{230}\text{Th}(\text{p,t})^{228}\text{Th}-^{232}\text{Th}(\text{O})^{230}\text{Th}$	24.9	$^{230}\text{Th}(\text{n},\gamma)^{231}\text{Th}$
^{230}Pa	87.8	$^{230}\text{Pa}(\epsilon)^{230}\text{Th}$	12.2	$^{230}\text{Pa}(\alpha)^{226}\text{Ac}$		
^{231}Ra	66.2	$^{231}\text{Ra}-\text{u}$	33.8	$^{231}\text{Ra}-^{133}\text{Cs}_{1.737}$		
^{231}Th	73.2	$^{230}\text{Th}(\text{n},\gamma)^{231}\text{Th}$	20.8	$^{235}\text{U}(\alpha)^{231}\text{Th}$	6.0	$^{231}\text{Th}(\beta^-)^{231}\text{Pa}$
^{231}Pa	47.3	$^{231}\text{Th}(\beta^-)^{231}\text{Pa}$	42.2	$^{235}\text{Np}(\alpha)^{231}\text{Pa}$	7.7	$^{231}\text{Pa}(\alpha)^{227}\text{Ac}$
^{232}Ra	57.1	$^{232}\text{Ra}-^{133}\text{Cs}_{1.744}$	42.9	$^{232}\text{Ra}-\text{u}$		
^{232}Th	83.0	$^{236}\text{U}(\alpha)^{232}\text{Th}$	11.5	$\text{C}_{24}\text{H}_{16}-^{232}\text{Th}\ ^{37}\text{Cl}\ ^{35}\text{Cl}$	8.3	$^{232}\text{Th}(\text{n},\gamma)^{233}\text{Th}$
^{232}U	99.2	$^{232}\text{U}(\alpha)^{228}\text{Th}$	0.8	$^{236}\text{Pu}(\alpha)^{232}\text{U}$		
^{233}Ra	70.5	$^{233}\text{Ra}-^{133}\text{Cs}_{1.752}$	29.5	$^{233}\text{Ra}-\text{u}$		
^{233}Th	91.6	$^{232}\text{Th}(\text{n},\gamma)^{233}\text{Th}$	8.4	$^{233}\text{Th}(\beta^-)^{233}\text{Pa}$		
^{233}Pa	90.1	$^{237}\text{Np}(\alpha)^{233}\text{Pa}$	5.6	$^{233}\text{Th}(\beta^-)^{233}\text{Pa}$	4.3	$^{233}\text{Pa}(\beta^-)^{233}\text{U}$
^{233}U	51.3	$^{233}\text{Pa}(\beta^-)^{233}\text{U}$	23.3	$^{233}\text{U}(\alpha)^{229}\text{Th}$	14.6	$^{237}\text{Pu}(\alpha)^{233}\text{U}$
^{234}U	62.8	$^{234}\text{U}(\text{n},\gamma)^{235}\text{U}$	20.6	$^{238}\text{Pu}(\alpha)^{234}\text{U}$	16.3	$^{234}\text{U}(\alpha)^{230}\text{Th}$
^{235}U	41.2	$^{239}\text{Pu}(\alpha)^{235}\text{U}$	30.5	$^{235}\text{U}(\text{n},\gamma)^{236}\text{U}$	18.5	$^{234}\text{U}(\text{n},\gamma)^{235}\text{U}$
^{235}Np	88.0	$^{235}\text{Np}(\epsilon)^{235}\text{U}$	12.0	$^{235}\text{Np}(\alpha)^{231}\text{Pa}$		
^{236}U	76.9	$^{240}\text{Pu}(\alpha)^{236}\text{U}$	23.2	$^{235}\text{U}(\text{n},\gamma)^{236}\text{U}$	1.1	$^{236}\text{U}(\text{n},\gamma)^{237}\text{U}$
^{236}Pu	99.2	$^{236}\text{Pu}(\alpha)^{232}\text{U}$	0.8	$^{240}\text{Cm}(\alpha)^{236}\text{Pu}$		
^{237}U	84.3	$^{236}\text{U}(\text{n},\gamma)^{237}\text{U}$	15.7	$^{241}\text{Pu}(\alpha)^{237}\text{U}$		
^{237}Np	99.0	$^{241}\text{Am}(\alpha)^{237}\text{Np}$	1.0	$^{237}\text{Np}(\alpha)^{233}\text{Pa}$		
^{237}Pu	94.2	$^{241}\text{Cm}(\alpha)^{237}\text{Pu}$	5.8	$^{237}\text{Pu}(\alpha)^{233}\text{U}$		
^{238}U	77.9	$^{242}\text{Pu}(\alpha)^{238}\text{U}$	21.0	$\text{C}_{24}\text{H}_{20}-^{238}\text{U}\ ^{35}\text{Cl}_2$	1.2	$^{229}\text{Fr}-^{238}\text{U}_{.962}$
^{238}Pu	69.1	$^{238}\text{Pu}(\alpha)^{234}\text{U}$	30.6	$^{238}\text{Pu}(\text{n},\gamma)^{239}\text{Pu}$	0.3	$^{242}\text{Cm}(\alpha)^{238}\text{Pu}$

Table II. Influences on primary nuclides (continued, Explanation of Table on page 030003-74)

Nuclide	Infl.	Equation	Infl.	Equation	Infl.	Equation
^{239}Np	67.2	$^{239}\text{Np}(\beta^-)^{239}\text{Pu}$	32.8	$^{243}\text{Am}(\alpha)^{239}\text{Np}$		
^{239}Pu	46.2	$^{239}\text{Pu}(n,\gamma)^{240}\text{Pu}$	27.1	$^{239}\text{Pu}(\alpha)^{235}\text{U}$	19.4	$^{239}\text{Np}(\beta^-)^{239}\text{Pu}$
^{240}U	99.1	$^{244}\text{Pu}(\alpha)^{240}\text{U}$	0.9	$^{240}\text{U}(\beta^-)^{240}\text{Np}^m$		
^{240}Np	67.9	$^{240}\text{Np}^m(\text{IT})^{240}\text{Np}$	32.1	$^{240}\text{Np}(\beta^-)^{240}\text{Pu}$		
$^{240}\text{Np}^m$	42.7	$^{240}\text{Np}^m(\beta^-)^{240}\text{Pu}$	42.2	$^{240}\text{U}(\beta^-)^{240}\text{Np}^m$	15.2	$^{240}\text{Np}^m(\text{IT})^{240}\text{Np}$
^{240}Pu	60.8	$^{240}\text{Pu}(n,\gamma)^{241}\text{Pu}$	25.9	$^{239}\text{Pu}(n,\gamma)^{240}\text{Pu}$	13.3	$^{240}\text{Pu}(\alpha)^{236}\text{U}$
^{240}Cm	99.1	$^{240}\text{Cm}(\alpha)^{236}\text{Pu}$	0.9	$^{244}\text{Cf}(\alpha)^{240}\text{Cm}$		
^{241}Pu	39.2	$^{240}\text{Pu}(n,\gamma)^{241}\text{Pu}$	28.3	$^{245}\text{Cm}(\alpha)^{241}\text{Pu}$	18.4	$^{241}\text{Pu}(\beta^-)^{241}\text{Am}$
^{241}Am	80.9	$^{241}\text{Pu}(\beta^-)^{241}\text{Am}$	17.6	$^{241}\text{Am O-C}_{22}$	0.7	$^{241}\text{Am}(\alpha)^{237}\text{Np}$
^{241}Cm	94.1	$^{241}\text{Cm}(\epsilon)^{241}\text{Am}$	4.7	$^{241}\text{Cm}(\alpha)^{237}\text{Pu}$	1.2	$^{245}\text{Cf}(\alpha)^{241}\text{Cm}$
^{242}Pu	80.8	$^{241}\text{Pu}(n,\gamma)^{242}\text{Pu}$	13.9	$^{242}\text{Pu}(\alpha)^{238}\text{U}$	4.4	$^{242}\text{Pu}(n,\gamma)^{243}\text{Pu}$
^{242}Cm	99.7	$^{242}\text{Cm}(\alpha)^{238}\text{Pu}$	0.3	$^{246}\text{Cf}(\alpha)^{242}\text{Cm}$		
^{243}Pu	59.0	$^{242}\text{Pu}(n,\gamma)^{243}\text{Pu}$	19.1	$^{244}\text{Pu}(\text{d,t})^{243}\text{Pu}$	11.4	$^{243}\text{Pu}(\beta^-)^{243}\text{Am}$
^{243}Am	53.8	$^{243}\text{Am}(\alpha)^{239}\text{Np}$	43.9	$^{243}\text{Am O-C}_{22}$	2.3	$^{243}\text{Pu}(\beta^-)^{243}\text{Am}$
^{244}Pu	78.1	$^{244}\text{Pu O-C}_{22}$	15.3	$^{244}\text{Pu}(\text{d,t})^{243}\text{Pu}$	5.3	$^{248}\text{Cm}(\alpha)^{244}\text{Pu}$
^{244}Cf	98.3	$^{244}\text{Cf}(\alpha)^{240}\text{Cm}$	1.7	$^{248}\text{Fm}(\alpha)^{244}\text{Cf}$		
^{245}Cm	67.6	$^{245}\text{Cm}(\alpha)^{241}\text{Pu}$	32.4	$^{249}\text{Cf}(\alpha)^{245}\text{Cm}$		
^{245}Cf	97.2	$^{245}\text{Cf}(\alpha)^{241}\text{Cm}$	2.8	$^{249}\text{Fm}(\alpha)^{245}\text{Cf}$		
^{246}Pu	55.3	$^{244}\text{Pu}(\text{t,p})^{246}\text{Pu}$	44.7	$^{246}\text{Pu}(\beta^-)^{246}\text{Am}^m$		
$^{246}\text{Am}^m$	55.7	$^{246}\text{Am}^m(\beta^-)^{246}\text{Cm}$	44.3	$^{246}\text{Pu}(\beta^-)^{246}\text{Am}^m$		
^{246}Cm	98.1	$^{246}\text{Cm}(\alpha)^{242}\text{Pu}$	1.7	$^{246}\text{Cm}(\text{d,p})^{247}\text{Cm}$	0.2	$^{246}\text{Am}^m(\beta^-)^{246}\text{Cm}$
^{246}Cf	99.4	$^{246}\text{Cf}(\alpha)^{242}\text{Cm}$	0.6	$^{250}\text{Fm}(\alpha)^{246}\text{Cf}$		
^{247}Cm	60.2	$^{247}\text{Cm}(\alpha)^{243}\text{Pu}$	20.6	$^{246}\text{Cm}(\text{d,p})^{247}\text{Cm}$	19.2	$^{248}\text{Cm}(\text{d,t})^{247}\text{Cm}$
^{248}Cm	94.6	$^{248}\text{Cm}(\alpha)^{244}\text{Pu}$	5.4	$^{248}\text{Cm}(\text{d,t})^{247}\text{Cm}$		
^{248}Fm	76.8	$^{248}\text{Fm}(\alpha)^{244}\text{Cf}$	23.2	$^{252}\text{No}(\alpha)^{248}\text{Fm}$		
^{249}Cf	63.4	$^{249}\text{Cf}(\alpha)^{245}\text{Cm}$	36.6	$^{249}\text{Cf O-C}_{22}$		
^{249}Fm	76.9	$^{249}\text{Fm}(\alpha)^{245}\text{Cf}$	23.1	$^{253}\text{No}(\alpha)^{249}\text{Fm}$		
^{250}Fm	79.6	$^{250}\text{Fm}(\alpha)^{246}\text{Cf}$	20.4	$^{254}\text{No}(\alpha)^{250}\text{Fm}$		
^{252}No	69.3	$^{252}\text{No}(\alpha)^{248}\text{Fm}$	30.7	$^{252}\text{No}-^{133}\text{Cs}_{1.895}$		
^{253}No	67.4	$^{253}\text{No}(\alpha)^{249}\text{Fm}$	32.6	$^{253}\text{No}-^{133}\text{Cs}_{1.902}$		
^{254}No	58.0	$^{254}\text{No}(\alpha)^{250}\text{Fm}$	42.0	$^{254}\text{No}-^{133}\text{Cs}_{1.910}$		

Table III. Nuclear-reaction and separation energies

EXPLANATION OF TABLE

We present, for all nuclides for which such data can be derived, separation energies (in keV) of particles (or groups of particles) and nuclear-reaction energies obtained as the following combinations of atomic masses (see accompanying diagram):

$Q(\beta^-)$	=	$M(A, Z) - M(A, Z + 1)$ (in Part I)	(a)
$Q(2\beta^-)$	=	$M(A, Z) - M(A, Z + 2)$	(b)
$Q(4\beta^-)$	=	$M(A, Z) - M(A, Z + 4)$	(c)
$Q(\beta^-n)$	=	$M(A, Z) - M(A - 1, Z + 1) - n$	(d)
$S(n)$	=	$-M(A, Z) + M(A - 1, Z) + n$	(e)
$S(p)$	=	$-M(A, Z) + M(A - 1, Z - 1) + {}^1\text{H}$	(f)
$Q(\epsilon p)$	=	$M(A, Z) - M(A - 1, Z - 2) - {}^1\text{H}$	(g)
$S(2n)$	=	$-M(A, Z) + M(A - 2, Z) + 2n$	(h)
$Q(d, \alpha)$	=	$M(A, Z) - M(A - 2, Z - 1) - {}^2\text{H} - {}^4\text{He}$	(i)
$S(2p)$	=	$-M(A, Z) + M(A - 2, Z - 2) + 2{}^1\text{H}$	(j)
$Q(p, \alpha)$	=	$M(A, Z) - M(A - 3, Z - 1) - {}^4\text{He} + p$	(k)
$Q(n, \alpha)$	=	$M(A, Z) - M(A - 3, Z - 2) - {}^4\text{He} + n$	(l)
$Q(\alpha)$	=	$M(A, Z) - M(A - 4, Z - 2) - {}^4\text{He}$	(m)

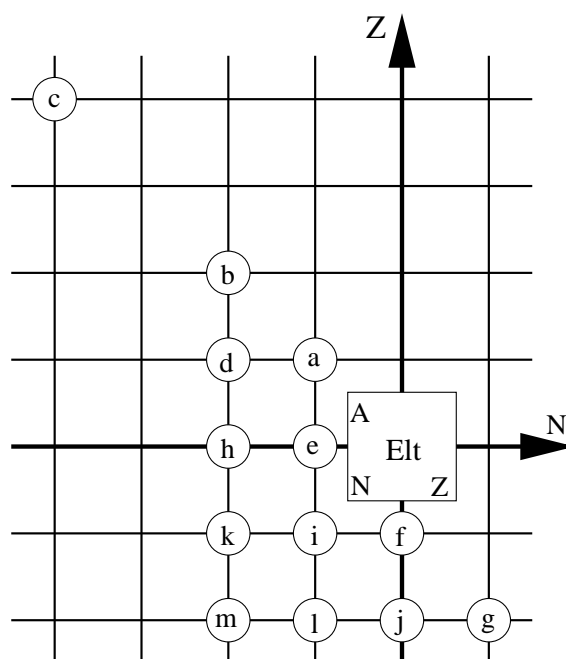

A Mass number.
 Elt. Element symbol (for $Z \geq 113$ see Part I, Section 6.8, p. 030002-31).
 Z Atomic number.

2224.57 0.04 2224.57 ± 0.04 keV. The uncertainties are derived from the adjusted masses and the correlation matrix. For the most precise very light nuclides the precisions are often better than 5 eV and could not be given conveniently in this table. In Table B, the correlation matrix for these nuclides allows easy derivation.

- * in place of value: not calculable from the present input data.
 # in place of decimal point: values and uncertainties estimated from TMS (see Part I, Section 4, p. 030002-9).
 a in place of uncertainty : uncertainty smaller than 5 eV.

Other reaction energies can be derived from the given data with the help of the following relations:

$$\begin{aligned}
 Q(\gamma, p) &= - S(p) \\
 Q(\gamma, n) &= - S(n) \\
 Q(\gamma, 2p) &= - S(2p) \\
 Q(\gamma, pn) &= Q(d, \alpha) - 26071.0939 \pm 0.0005 \\
 Q(\gamma, d) &= Q(d, \alpha) - 23846.5279 \pm 0.0002 \\
 Q(\gamma, 2n) &= - S(2n) \\
 Q(\gamma, t) &= Q(p, \alpha) - 19813.8649 \pm 0.0003 \\
 Q(\gamma, {}^3\text{He}) &= Q(n, \alpha) - 20577.6194 \pm 0.0005 \\
 Q(\gamma, \alpha) &= Q(\alpha) \\
 \\
 Q(p, n) &= Q(\beta^-) - 782.3465 \pm 0.0005 \\
 Q(p, 2p) &= - S(p) \\
 Q(p, pn) &= - S(n) \\
 Q(p, d) &= - S(n) + 2224.5660 \pm 0.0004 \\
 Q(p, 2n) &= Q(\beta^- n) - 782.3465 \pm 0.0005 \\
 Q(p, t) &= - S(2n) + 8481.7949 \pm 0.0009 \\
 Q(p, {}^3\text{He}) &= Q(d, \alpha) - 18353.0535 \pm 0.0003 \\
 \\
 Q(n, 2p) &= Q(\varepsilon p) + 782.3465 \pm 0.0005 \\
 Q(n, np) &= - S(p) \\
 Q(n, d) &= - S(p) + 2224.5660 \pm 0.0004 \\
 Q(n, 2n) &= - S(n) \\
 Q(n, t) &= Q(d, \alpha) - 17589.2989 \pm 0.0005 \\
 Q(n, {}^3\text{He}) &= - S(2p) + 7718.0404 \pm 0.0005 \\
 \\
 Q(d, pn) &= 0 - 2224.5660 \pm 0.0004 \\
 Q(d, t) &= - S(n) + 6257.2290 \pm 0.0005 \\
 Q(d, {}^3\text{He}) &= - S(p) + 5493.4744 \pm 0.0001 \\
 \\
 Q({}^3\text{He}, t) &= Q(\beta^-) - 18.5920 \pm 0.0001 \\
 Q({}^3\text{He}, \alpha) &= - S(n) + 20577.6194 \pm 0.0005 \\
 \\
 Q(t, \alpha) &= - S(p) + 19813.8649 \pm 0.0003
 \end{aligned}$$

Table III. Nuclear-reaction and separation energies (Explanation of Table on p.030003-98)

A	Elt.	Z	S(n)		S(p)		Q(4β ⁻)		Q(d,α)		Q(p,α)		Q(n,α)	
1	n	0	0.0	0.0	*	*	*	*	*	*	*	*	*	*
	H	1	*	*	0.0	0.0	*	*	*	*	*	*	*	*
2	H	1	2224.57	a	2224.57	a	*	23846.53	a	*	*	*	*	*
3	H	1	6257.23	a	*	*	*	17589.30	a	19813.86	a	*	*	*
	He	2	*	*	5493.47	a	*	18353.05	a	*	*	20577.62	a	*
	Li	3	*	*	*	*	*	*	*	*	*	*	*	*
4	H	1	-1600	100	*	*	*	*	*	21410	100	*	*	*
	He	2	20577.62	a	19813.86	a	*	0.0	0.0	0.0	0.0	0.0	0.0	0.0
	Li	3	11420#	2010#	-3100	210	*	*	*	*	*	23680	210	*
5	H	1	-200	130	*	*	*	*	*	*	*	*	*	*
	He	2	-735	20	20680	100	*	6992	20	2960	20	*	*	*
	Li	3	21720	220	-1960	50	*	7460	50	*	*	4190	50	*
	Be	4	*	*	-4530#	2010#	*	19180#	2830#	*	*	*	*	*
6	H	1	-910	270	*	*	-5440#	2020#	*	*	*	*	*	*
	He	2	1710	20	22590	90	*	3680	100	7506.34	0.05	*	*	*
	Li	3	5660	50	4433	20	*	22372.77	a	4019.72	a	4783.47	a	*
	Be	4	26840#	2000#	590	50	*	3760	210	-5430#	2000#	9090	5	*
	B	5	*	*	-2890#	2830#	*	*	*	*	*	24300#	2830#	*
7	H	1	810#	1040#	*	*	21460#	1000#	*	*	*	*	*	*
	He	2	-410	8	23090	250	*	3890	90	6320	100	*	*	*
	Li	3	7251.09	0.01	9973.96	0.05	*	14387	20	17346.24	a	-4070	100	*
	Be	4	10677	5	5606.85	0.07	*	14800	50	-4690	210	18990.48	0.07	*
	B	5	27720#	2000#	-2013	26	*	1250#	2000#	*	*	8000	210	*
8	He	2	2535	8	24810#	1000#	-3455	18	440	250	3580	90	*	*
	Li	3	2032.62	0.05	12416	8	*	*	14064.51	0.07	14579	20	-6300	90
	Be	4	18898.64	0.08	17254.40	0.04	*	*	1565.60	0.04	-1870	50	-643	20
	B	5	12826	25	136.4	1.0	*	*	15257	6	-9350#	2000#	16890	50
	C	6	*	*	-100	30	*	*	-1550#	2000#	*	*	3570#	2000#
9	He	2	-1250	50	*	*	12020	50	2510#	1010#	3920	260	*	*
	Li	3	4062.22	0.19	13943.75	0.21	*	*	9593	8	12226.86	0.19	-11270	250
	Be	4	1664.54	0.08	16886.32	0.09	*	*	7152.15	0.08	2125.63	0.08	-597.24	0.09
	B	5	18576.4	1.3	-185.8	0.9	*	*	7358.3	0.9	-1094	6	3976.0	0.9
	C	6	14225	18	1299.6	2.4	*	*	11945	25	-13550#	2000#	16182	6
10	He	2	-190	100	*	*	33500	90	*	*	4930#	1010#	*	*
	Li	3	-26	13	15170	50	-5750	400	12154	13	11844	15	-10440#	1000#
	Be	4	6812.28	0.05	19636.39	0.20	*	*	2372.49	0.09	2564.44	0.08	-7819	8
	B	5	8437.2	0.9	6586.81	0.08	*	*	17819.74	0.04	1145.67	0.07	2789.91	0.02
	C	6	21283.6	2.1	4006.8	0.9	*	*	3487.9	1.0	-7114	25	5576.07	0.10
	N	7	*	*	-2600	400	*	*	14450	400	*	*	16770	400
11	Li	3	396	13	15760	90	16420	50	10500	50	13982.6	0.6	*	*
	Be	4	501.64	0.25	20164	13	*	*	5933.1	0.3	4095.42	0.24	-5786.11	0.25
	B	5	11454.22	0.02	11228.75	0.08	*	*	8030.06	0.08	8590.09	0.04	-6631.70	0.05
	C	6	13120.59	0.09	8690.18	0.06	*	*	8943.7	0.9	-7408.1	1.0	11354.13	0.07
	N	7	22570	400	-1320	50	*	*	6100	50	-5900	50	7030	50
12	Li	3	-210	30	*	*	31670	30	10520	100	12940	60	*	*
	Be	4	3170.7	1.9	22939.5	2.0	-6837	24	2736	13	4986.9	1.9	-10210	50
	B	5	3369.6	1.3	14096.7	1.3	*	*	11472.7	1.3	6885.0	1.3	-5939.1	1.3
	C	6	18720.71	0.06	15956.68	0.01	*	*	-1339.80	0.02	-7552.4	0.9	-5702.05	0.08
	N	7	15040	50	600.3	1.0	*	*	12350.2	1.0	-6708.8	2.4	10568.0	1.3
	O	8	*	*	-320	50	*	*	3830	400	*	*	8650	24

Table III. Nuclear-reaction and separation energies (continued, Explanation of Table on p. 030003-98)

A	Elt.	Z	S(2n)		S(2p)		Q(α)		Q($2\beta^-$)		Q($\epsilon\beta$)		Q(β^-n)	
1	n	0	*		*		*		*		*		*	
	H	1	*		*		*		*		*		*	
2	H	1	*		*		*		*		*		*	
3	H	1	8481.79	<i>a</i>	*		*		-13720#	2000#	*		*	
	He	2	*		7718.04	<i>a</i>	*		*		*		*	
	Li	3	*		-6800#	2000#	*		*		8240#	2000#	*	
4	H	1	4660	100	*		*		-700	230	*		1620	100
	He	2	*		*		0.0	0.0	*		*		-34310#	2000#
	Li	3	*		2390	210	*		*		3080	210	*	
5	H	1	-1800	90	*		*		21210	100	*		22400	90
	He	2	19843	20	*		735	20	-25910#	2000#	*		-22160	210
	Li	3	33130#	2000#	17850	50	1960	50	*		-20230	110	*	
	Be	4	*		-7630#	2000#	*		*		27430#	2000#	*	
6	H	1	-1110	270	*		*		27790	250	*		22570	250
	He	2	975.45	0.05	*		*		-783	5	*		-2160	50
	Li	3	27380	210	25110	100	-1473.76	<i>a</i>	-33230#	2000#	-26090	90	-31120#	2000#
	Be	4	*		-1372	5	*		*		-145	21	*	
	B	5	*		-7420#	2010#	*		*		28350#	2000#	*	
7	H	1	-100#	1000#	*		*		34230#	1000#	*		23470#	1000#
	He	2	1301	21	*		*		10304	8	*		3915	8
	Li	3	12910	50	32560	90	-2467.62	<i>a</i>	-12769	25	-34260	250	-11539	5
	Be	4	37510#	2000#	10040	20	-1587.13	0.07	*		-9112.07	0.09	-39620#	2000#
	B	5	*		-1420	60	-3420#	2000#	*		6301	25	*	
8	He	2	2125.05	0.10	*		*		26668.01	0.10	*		8631.26	0.09
	Li	3	9283.71	0.05	35510	250	-6100	100	-1975.8	1.0	-35480#	1000#	-2894.51	0.09
	Be	4	29576	5	27228.37	0.06	91.84	0.04	-30123	18	-28420	8	-30806	25
	B	5	40540#	2000#	5743.3	1.0	-4830	210	*		725.5	1.0	*	
	C	6	*		-2111	19	*		*		12006	18	*	
9	He	2	1280	50	*		*		29590	50	*		11920	50
	Li	3	6094.84	0.19	38760#	1000#	-10360	90	12538.4	0.9	*		11941.91	0.19
	Be	4	20563.18	0.10	29303	8	-2308	20	-17562.5	2.1	-27550.20	0.12	-19644.4	1.0
	B	5	31403	25	17068.6	0.9	-1690	50	*		-15818.3	0.9	-30719	18
	C	6	*		1436.0	2.1	-10650#	2000#	*		16680.3	2.1	*	
10	He	2	-1440	90	*		*		36590	90	*		16170	90
	Li	3	4036	13	*		-11250	250	21002	13	*		13633	13
	Be	4	8476.82	0.09	33580.13	0.12	-7409.52	0.10	-3091.18	0.11	-35620	50	-7880.3	0.9
	B	5	27013.6	1.0	23473.14	0.05	-4461.19	0.02	-26750	400	-20193.26	0.19	-24931.7	2.1
	C	6	35508	18	3820.94	0.08	-5101	5	*		-2938.75	0.10	*	
	N	7	*		-1300	400	-10950#	2040#	*		19090	400	*	
11	Li	3	369.3	0.6	*		-10830#	1000#	32060.5	0.6	*		20049.4	0.6
	Be	4	7313.92	0.25	35340	50	-8321	8	9527.77	0.25	-36310	90	55.24	0.24
	B	5	19891.4	0.9	30865.14	0.19	-8664.31	0.01	-15640	50	-31674	13	-15102.28	0.07
	C	6	34404.2	2.1	15277.00	0.10	-7544.52	0.09	*		-9247.06	0.10	-36220	400
	N	7	*		2690	50	-5800	50	*		4960	50	*	
12	Li	3	190	30	*		*		35640	30	*		20760	30
	Be	4	3672.4	1.9	38700	90	-8956.8	1.9	25077.8	1.9	*		8338.7	1.9
	B	5	14823.8	1.3	34261	13	-10001.3	1.3	-3968.7	1.7	-34647.8	1.5	-5351.3	1.3
	C	6	31841.31	0.07	27185.43	0.08	-7366.59	0.04	-31915	24	-27466.14	0.24	-32370	50
	N	7	37600	400	9290.5	1.0	-8008.4	1.4	*		1381.4	1.0	*	
	O	8	*		-1638	24	-5570	30	*		13976	24	*	

Table III. Nuclear-reaction and separation energies (continued, Explanation of Table on p. 030003-98)

A	Elt.	Z	S(n)		S(p)		Q(4β ⁻)		Q(d,α)		Q(p,α)		Q(n,α)	
13	Li	3	100	80	*		51640	70	*		12650	120	*	
	Be	4	-510	10	22640	30	10544	14	3642	10	5471	16	-9890	90
	B	5	4878.8	1.7	15804.8	2.2	*		7095.6	1.0	8818.5	1.0	-10844	13
	C	6	4946.31	<i>a</i>	17533.4	1.3	*		5168.11	0.01	-4061.55	0.02	-3836.08	0.08
	N	7	20063.9	1.0	1943.49	0.27	*		5406.89	0.28	-5489.14	0.28	-1058.73	0.27
	O	8	16870	26	1512	10	*		9520	50	-10820	400	13063	10
14	Be	4	1780	130	24320	150	31950	130	1660	140	4090	130	*	
	B	5	970	21	17284	24	-8300	50	9297	21	8351	21	-11418	21
	C	6	8176.43	<i>a</i>	20831.0	1.0	*		361.3	1.3	-783.76	0.01	-11510.87	0.24
	N	7	10553.38	0.27	7550.56	<i>a</i>	*		13574.22	<i>a</i>	-2921.92	0.06	-157.89	0.01
	O	8	23179	10	4626.67	0.27	*		1380.5	1.0	-11430	50	3004.79	0.06
	F	9	*		-1560	40	*		10760	50	*		13310	60
15	Be	4	-1800	100	*		46970	170	3560	180	5680	170	*	
	B	5	2777	30	18290	130	12391	25	6010	23	8745	21	-14400	40
	C	6	1218.1	0.8	21080	21	-30340	70	4022.0	1.3	1367.8	1.5	-9558.2	2.1
	N	7	10833.30	<i>a</i>	10207.42	<i>a</i>	*		7687.24	<i>a</i>	4965.49	<i>a</i>	-7621.6	1.3
	O	8	13223.5	0.5	7296.8	0.5	*		8220.9	0.6	-9618.4	1.1	8502.0	0.5
	F	9	23470	40	-1270	14	*		4162	17	-10484	28	4875	14
Ne	10	*		-960	80	*		*		*		13950	70	
16	Be	4	450	140	*		62180	170	*		5330	180	*	
	B	5	-83	15	20000	170	26432	26	7870	130	8317	27	-14220	70
	C	6	4250	4	22553	21	-10293	21	741	22	1996	4	-14319	11
	N	7	2488.8	2.3	11478.2	2.4	*		13374.8	2.3	7423.0	2.3	-5231.6	2.5
	O	8	15663.9	0.5	12127.41	<i>a</i>	*		3110.39	<i>a</i>	-5218.43	0.27	-2215.61	<i>a</i>
	F	9	13958	16	-536	8	*		13383	8	-7571	13	10981	8
Ne	10	24300	70	-131	25	*		2730	50	*		6518	23	
17	B	5	1470	210	21020	260	41760	200	4600	260	8630	240	*	
	C	6	734	18	23370	30	4531	17	2784	27	2232	27	-13280	130
	N	7	5885	15	13113	15	-27300	1000	8708	15	9714	15	-10147	26
	O	8	4143.08	<i>a</i>	13781.6	2.3	*		9800.60	<i>a</i>	1191.87	<i>a</i>	1817.74	<i>a</i>
	F	9	16800	8	600.27	0.25	*		9806.9	0.5	-1192.02	0.25	4734.69	0.25
	Ne	10	15558	20	1469	8	*		10645	14	-10600	40	14139.1	0.4
Na	11	*		-3900	1000	*		5670	1000	*		8860	1000	
18	B	5	-5	5	*		50920	200	5060	260	6830	260	*	
	C	6	4180	30	26090	210	19600	30	-1480	40	830	40	-19260	170
	N	7	2828	24	15208	25	-11920	100	10130	19	8104	19	-10199	28
	O	8	8045.37	<i>a</i>	15942	15	*		4244.1	2.3	3979.80	<i>a</i>	-5009.6	0.8
	F	9	9149.9	0.5	5607.1	0.5	*		16320.9	0.5	2881.6	0.7	6418.1	0.5
	Ne	10	19254.2	0.5	3923.1	0.4	*		5348	8	-6385	14	8108.4	0.6
Na	11	18210	1010	-1250	90	*		11760	100	-10310	120	14120	90	
19	B	5	90	560	*		61260	530	*		7190	550	*	
	C	6	580	90	26670	230	30660	100	-590	230	170	100	-19390	190
	N	7	5328	25	16350	30	2927	19	5535	24	7026	17	-15610	30
	O	8	3955.6	2.6	17069	19	-28500	50	6174	15	2513	3	-4715	4
	F	9	10431.9	0.5	7993.60	<i>a</i>	*		10032.13	<i>a</i>	8113.61	<i>a</i>	-1524.9	2.3
	Ne	10	11636.9	0.4	6410.0	0.5	*		10511.15	0.30	-4064	8	12135.45	0.16
Na	11	20180	90	-323	11	*		7140	11	-6193	23	7896	13	
Mg	12	*		500	110	*		7370	1000	*		13490	50	

Table III. Nuclear-reaction and separation energies (continued, Explanation of Table on p. 030003-98)

A	Elt.	Z	S(2n)		S(2p)		Q(α)		Q($2\beta^-$)		Q(ϵp)		Q($\beta^- n$)	
13	Li	3	-110	70	*	*	*	40420	70	*	*	23830	70	
	Be	4	2661	10	*		-9700	50	30534	10	*	12218	10	
	B	5	8248.4	1.0	38744.2	1.2	-10817.9	1.0	11216.5	1.0	-39740	30	8490.6	1.0
	C	6	23667.02	0.06	31630.10	0.24	-10648.36	0.08	-19990	10	-29241.7	1.9	-22284.4	1.0
	N	7	35100	50	17900.17	0.27	-9495.9	0.9	*		-15312.9	1.3	-34640	24
	O	8	*		2112	10	-8220	10	*		15826	10	*	
14	Be	4	1270	130	*		-11670	160	36930	130	*		15320	130
	B	5	5848	21	39920	40	-11814	25	20800	21	-40610	70	12467	21
	C	6	13122.74	<i>a</i>	36635.8	1.9	-12012.51	0.08	-4987.89	0.03	-37928	10	-10396.91	0.27
	N	7	30617.3	1.0	25083.9	1.3	-11612.11	0.02	-29100	40	-20987.5	1.0	-28323	10
	O	8	40049	24	6570.16	0.03	-10115.81	0.07	*		-2406.20	0.03	*	
	F	9	*		-50	40	-9260	400	*		19330	40	*	
15	Be	4	-20	170	*		*	39950	170	*	*	18090	170	
	B	5	3746	21	42600	70	-14195	21	28857	21	*	17867	21	
	C	6	9394.5	0.8	38364	10	-12728.9	0.8	7017.5	0.9	-37370	130	-1061.6	0.8
	N	7	21386.68	0.27	31038.4	1.0	-10991.18	0.01	-16465	14	-30851	21	-15977.66	0.03
	O	8	36402	10	14847.3	0.5	-10218.7	0.5	-37360	70	-7453.3	0.5	-37180	40
	F	9	*		3357	14	-10160	50	*		6414	14	*	
Ne	10	*		-2520	70	*		*		24920	70	*		
16	Be	4	-1350	100	*		*	43750	170	*	*	20420	170	
	B	5	2690	30	*		-14320	40	31429	25	*	19168	25	
	C	6	5468	4	40840	130	-13809	4	18431	4	-43420	170	5521	4
	N	7	13322.1	2.3	32558	21	-10110.4	2.7	-4996	9	-30563	21	-5243.0	2.4
	O	8	28887.42	0.03	22334.83	<i>a</i>	-7161.92	<i>a</i>	-28724	20	-21899.1	0.8	-29375	14
	F	9	37430	40	6761	8	-9083	8	*		3290	8	-37610	70
Ne	10	*		-1401	20	-10350	30	*		13842	20	*		
17	B	5	1380	210	*		-15690	220	35850	200	*	21950	200	
	C	6	4984	17	43370	170	-15052	20	21841	17	-43700	170	7277	18
	N	7	8374	15	35666	26	-11117	15	5918	15	-36531	29	4536	15
	O	8	19807.0	0.5	25259.8	0.8	-6358.69	<i>a</i>	-17309.2	0.4	-21792	4	-19560	8
	F	9	30758	14	12727.68	0.25	-5818.7	0.4	-33220	1000	-11021.2	2.3	-30106	20
	Ne	10	39860	70	933.1	0.6	-9040	10	*		13948.5	0.4	*	
Na	11	*		-4030	1000	*		*		17200	1000	*		
18	B	5	1460	210	*		*	38680	210	*	*	22690	200	
	C	6	4920	30	47110	170	-17460	140	25700	30	*	8980	30	
	N	7	8713	19	38580	30	-12975	28	12240	19	-37890	200	5851	19
	O	8	12188.45	<i>a</i>	29055	4	-6227.62	<i>a</i>	-6100.4	0.4	-29104	17	-10805.83	0.25
	F	9	25950	8	19388.7	2.3	-4415.2	0.5	-24160	90	-14286	15	-23698.7	0.6
	Ne	10	34812	20	4523.3	0.4	-5115.1	0.4	*		-1162.6	0.4	-37930	1000
Na	11	*		220	90	-9350	100	*		15800	90	*		
19	B	5	90	560	*		*	43910	530	*	*	26780	530	
	C	6	4760	100	*		-19840	190	29080	100	*	11230	100	
	N	7	8156	22	42440	200	-15527	27	17344	16	-43230	200	8568	16
	O	8	12001.0	2.6	32277	18	-8965.2	2.8	1580.8	2.6	-28880	30	-5611.6	2.7
	F	9	19581.78	0.25	23935	15	-4013.80	<i>a</i>	-14417	11	-21890	19	-14876.4	0.4
	Ne	10	30891.0	0.4	12017.13	0.16	-3528.5	0.5	-30080	50	-4754.10	0.16	-31360	90
Na	11	38390	1000	3600	11	-6062	18	*		4767	11	*		
Mg	12	*		-750	50	-10810	80	*		19220	50	*		

Table III. Nuclear-reaction and separation energies (continued, Explanation of Table on p. 030003-98)

A	Elt.	Z	S(n)		S(p)		Q(4β ⁻)		Q(d,α)		Q(p,α)		Q(n,α)	
20	B	5	-610#	960#	*		68470#	800#	*		*		*	
	C	6	2980	250	29560	570	44550	230	-3580	310	-1350	310	*	
	N	7	2160	80	17940	130	14920	80	7560	80	5600	80	-16300	220
	O	8	7608.0	2.8	19349	16	-13681.5	2.1	1394	19	790	15	-11589	17
	F	9	6601.34	0.03	10639.3	2.6	*		11476.16	0.03	5655.35	0.03	-2241	15
	Ne	10	16865.30	0.16	12843.46	<i>a</i>	*		2795.8	0.5	-4129.58	0.25	-586.77	<i>a</i>
	Na	11	14150	11	2190.4	1.1	*		12243.8	1.2	-4785.8	1.2	10545.3	1.1
	Mg	12	22420	50	2741	11	*		3150	90	-12830	1000	6623.6	1.9
21	B	5	-810#	1200#	*		77380#	900#	*		*		*	
	C	6	-70#	640#	30100#	1000#	51380#	600#	-3420#	800#	-1290#	630#	*	
	N	7	4610	160	19560	270	27420	130	3530	170	5180	140	-20910	240
	O	8	3805	12	20990	80	-2842	12	2917	20	-187	22	-11210	30
	F	9	8101.5	1.8	11132.7	2.0	-27040#	600#	7330	3	5599.3	1.8	-7514	19
	Ne	10	6761.16	0.04	13003.28	0.05	*		6466.47	0.04	-1740.8	0.5	697.44	0.04
	Na	11	17106.6	1.1	2431.67	0.10	*		6774.12	0.19	-2638.2	0.4	2588.7	0.5
	Mg	12	14645.2	2.0	3235.7	1.3	*		8685	11	-9270	90	11232.6	0.8
Al	13	*		-2220#	600#	*		5870#	600#	*		7600#	600#	
22	C	6	100#	640#	31010#	930#	61640	230	-4130#	830#	-1290	570	*	
	N	7	1540	250	21170#	630#	36950	210	4970	310	4220	230	-22360	560
	O	8	6850	60	23240	150	9680	60	-1770	100	-1710	60	-17480	110
	F	9	5230	13	12558	17	-15410#	400#	9708	12	4325	13	-7417	21
	Ne	10	10364.26	0.04	15266.1	1.8	-41360#	500#	2703.55	0.03	-1673.22	0.02	-5711.2	2.6
	Na	11	11068.20	0.20	6738.71	0.18	*		12571.23	0.17	-2069.51	0.23	1952.33	0.17
	Mg	12	19375.1	0.8	5504.3	0.3	*		3460.3	1.2	-8465	11	3494.4	0.4
	Al	13	16860#	720#	-10#	400#	*		11440#	400#	-8760#	400#	10920#	400#
Si	14	*		940#	780#	*		*		*		7160#	510#	
23	C	6	-2490#	1020#	*		69330#	1000#	-2450#	1340#	590#	1280#	*	
	N	7	3120	470	24180	480	46250	420	1790#	730#	4080	480	-26080#	900#
	O	8	2730	130	24430	240	20090	120	100	180	-2280	150	-17240	260
	F	9	7580	40	13290	70	-3460	30	5930	40	4350	30	-12830	90
	Ne	10	5200.65	0.10	15236	12	-28850#	500#	5604.4	1.8	-272.53	0.11	-3303.8	0.9
	Na	11	12419.66	0.17	8794.11	0.02	*		6912.73	0.04	2376.13	<i>a</i>	-3865.99	0.03
	Mg	12	13144.9	0.4	7580.97	0.23	*		7421.92	0.19	-7460.1	1.1	7214.82	0.16
	Al	13	19530#	400#	141.0	0.5	*		6555.0	0.8	-5865.6	1.9	5543.9	1.2
Si	14	17710#	710#	1790#	640#	*		7420#	780#	*		11870#	500#	
24	N	7	-2150#	580#	24520#	1070#	55360#	400#	4040#	460#	6160#	720#	-24750#	990#
	O	8	4190	200	25510	450	32430	160	-2550	270	-1870	210	-21500#	620#
	F	9	3810	100	14370	160	7590	100	8970	110	4350	100	-12040	170
	Ne	10	8868.9	0.5	16530	30	-16697	19	1966	12	-1040.0	1.9	-8367	12
	Na	11	6959.37	0.02	10552.82	0.11	-41740#	500#	10317.62	0.02	2177.93	0.04	-2723.9	1.8
	Mg	12	16531.37	0.16	11692.69	0.01	*		1958.75	0.17	-6884.88	0.10	-2555.39	0.04
	Al	13	14868.3	0.4	1864.32	0.28	*		11061.9	0.4	-6088.7	0.8	7782.17	0.25
	Si	14	21020#	500#	3292	19	*		3260#	400#	-11380#	600#	5488	19
P	15	*		-2330#	710#	*		10690#	710#	*		11980#	780#	
25	N	7	-970#	640#	*		65340#	500#	2520#	1120#	7240#	550#	*	
	O	8	-757	8	26900#	430#	40520	170	1320	450	430	270	-20640	280
	F	9	4280	140	14460	190	20250	100	7420	160	6920	110	-14780	230
	Ne	10	4155	29	16870	100	-5860	30	5390	40	40	30	-5670	60
	Na	11	9011.2	1.2	10695.1	1.3	-29100#	400#	6507.0	1.2	3531.0	1.2	-6505	12
	Mg	12	7330.53	0.05	12063.85	0.05	*		7047.88	0.05	-3147.22	0.18	478.34	0.05
	Al	13	16938.43	0.24	2271.38	0.07	*		7268.34	0.17	-3652.0	0.3	1911.94	0.18
	Si	14	14989	22	3413	10	*		7790	10	-9510#	400#	9874	10
P	15	21650#	640#	-1700#	400#	*		6750#	640#	-8740#	640#	7180#	570#	

Table III. Nuclear-reaction and separation energies (continued, Explanation of Table on p. 030003-98)

A	Elt.	Z	S(2n)		S(2p)		Q(α)		Q(2 β^-)		Q(ϵp)		Q($\beta^- n$)	
20	B	5	-520#	830#	*	*	*	46680#	800#	*	*	27970#	810#	
	C	6	3560	230	*	*	-22370	280	33710	230	*	13580	230	
	N	7	7490	80	44600	220	-17770	80	21780	80	-45290	530	10360	80
	O	8	11563.6	0.9	35700	30	-12323	4	10838.1	0.9	-35910	100	-2787.7	0.9
	F	9	17033.2	0.5	27709	19	-8126.3	2.3	-6868.1	1.1	-23163	16	-9840.83	0.16
	Ne	10	28502.2	0.4	20837.06	<i>a</i>	-4729.84	<i>a</i>	-24519.6	1.9	-17663.8	2.6	-28043	11
	Na	11	34330	90	8600.5	1.2	-6255	8	*	*	1049.1	1.1	-33050	50
	Mg	12	*	*	2417.9	1.9	-8934	21	*	*	8436.7	1.9	*	*
21	B	5	-1420#	1040#	*	*	*	52100#	910#	*	*	31760#	930#	
	C	6	2910#	600#	*	*	*	37580#	600#	*	*	15810#	600#	
	N	7	6770	140	49120	540	-20910	240	25280	130	-50510#	810#	13360	130
	O	8	11413	12	38930	100	-15395	21	13794	12	-36730	230	8	12
	F	9	14702.8	1.8	30482	17	-10343	15	2137.0	1.8	-29100	80	-1077.0	1.8
	Ne	10	23626.46	0.16	23642.6	2.6	-7347.93	0.04	-16635.6	0.8	-16816.9	0.9	-20653.7	1.1
	Na	11	31257	11	15275.13	0.10	-6561.25	0.27	-29180#	600#	-9456.14	0.10	-27733.6	1.9
	Mg	12	37070	50	5426.1	0.8	-8021.5	0.8	*	*	10656.8	0.8	*	*
Al	13	*	*	520#	600#	-10610#	1170#	*	*	12850#	600#	*	*	
22	C	6	35	20	*	*	*	44330	240	*	*	20310	270	
	N	7	6140	220	51260#	830#	-22450	290	28970	210	-52850#	920#	15630	210
	O	8	10660	60	42800	240	-18060	60	17310	60	-43650#	600#	1260	60
	F	9	13332	12	33550	80	-12745	22	7975	12	-29730	130	454	12
	Ne	10	17125.42	0.02	26398.8	0.9	-9666.82	0.02	-7624.8	0.3	-23376	12	-13911.40	0.10
	Na	11	28174.7	1.1	19741.99	0.17	-8479.5	0.5	-23380#	400#	-12422.9	1.8	-24156.7	0.8
	Mg	12	34020.3	1.9	7935.9	0.3	-8142.5	0.5	-33740#	500#	-1957.1	0.3	-35460#	600#
	Al	13	*	*	3230#	400#	-9260#	410#	*	*	13100#	400#	*	*
Si	14	*	*	-1280#	500#	*	*	*	*	15150#	500#	*	*	
23	C	6	-2390#	1160#	*	*	*	49550#	1000#	*	*	24340#	1020#	
	N	7	4650	440	55190#	990#	-25470	670	33440	420	*	*	19370	420
	O	8	9580	120	45600#	610#	-20220	160	19780	120	-46280	260	3760	120
	F	9	12810	30	36520	140	-15000	40	12820	30	-35770	210	3240	30
	Ne	10	15564.91	0.11	27794	12	-10911.8	2.6	319.46	0.19	-21730	60	-8043.85	0.20
	Na	11	23487.86	0.10	24060.2	1.8	-10467.32	<i>a</i>	-16277.9	0.3	-19612	12	-17201.2	0.3
	Mg	12	32520.0	0.8	14319.68	0.16	-9650.48	0.23	-29170#	500#	-4737.76	0.16	-31750#	400#
	Al	13	36390#	600#	5645.2	0.4	-8606	11	*	*	4640.6	0.4	-34660#	500#
Si	14	*	*	1790#	500#	-10560#	510#	*	*	16810#	500#	*	*	
24	N	7	970#	450#	*	*	-23940#	900#	39390#	410#	*	*	24250#	420#
	O	8	6930	170	49690	280	-21430	280	24450	160	-52960#	1010#	7140	170
	F	9	11390	100	38800	230	-16650	130	15960	100	-36460	430	4630	100
	Ne	10	14069.6	0.5	29810	60	-12172.7	1.0	7981.9	0.5	-27860	120	-4493.1	0.5
	Na	11	19379.02	0.17	25789	12	-10825.35	0.03	-8369.04	0.23	-18990	30	-11015.71	0.16
	Mg	12	29676.3	0.3	20486.79	0.02	-9316.55	0.01	-24679	19	-16068.49	0.11	-28753.0	0.3
	Al	13	34390#	400#	9445.30	0.29	-9324.4	1.1	-33370#	500#	2192.02	0.23	-31820#	500#
	Si	14	38740#	500#	3433	19	-9157	20	*	*	8930	19	*	*
P	15	*	*	-540#	640#	*	*	*	*	19280#	500#	*	*	
25	N	7	-3120#	660#	*	*	-23770#	1030#	44650#	510#	*	*	29410#	530#
	O	8	3430	210	51420#	1010#	-20740#	620#	29360	170	*	*	11710	190
	F	9	8090	100	39960	430	-16320	170	20690	100	-42890#	410#	9210	100
	Ne	10	13024	29	31230	130	-12520	30	11157	29	-27820	170	-1689	29
	Na	11	15970.6	1.2	27220	30	-11735.1	2.2	-441.8	1.2	-24190	100	-3495.6	1.2
	Mg	12	23861.90	0.17	22616.68	0.11	-9885.92	0.06	-17020	10	-14530.1	0.5	-21215.23	0.24
	Al	13	31806.7	0.4	13964.06	0.06	-9156.26	0.12	-28650#	400#	-7787.04	0.07	-27732	19
	Si	14	36010#	500#	5277	10	-9501	10	*	*	10472	10	-37560#	500#
P	15	*	*	1590#	400#	-9680#	720#	*	*	12500#	400#	*	*	

Table III. Nuclear-reaction and separation energies (continued, Explanation of Table on p. 030003-98)

A	Elt.	Z	S(n)		S(p)		Q(4β ⁻)		Q(d,α)		Q(p,α)		Q(n,α)	
26	O	8	739	10	28610#	530#	50880	160	-1570#	430#	2800	450	-23860#	1010#
	F	9	760	150	15970	200	30860	110	10860	200	8890	160	-12430	440
	Ne	10	5550	30	18140	100	7622	18	3650	100	2060	40	-8490	120
	Na	11	5574	4	12114	29	-17830#	200#	9802	4	3157	4	-4500	30
	Mg	12	11093.08	0.04	14145.7	1.2	-43290#	600#	2914.16	0.03	-1820.63	0.03	-5414.09	0.11
	Al	13	11365.49	0.07	6306.34	0.06	*		12434.22	0.07	-1872.58	0.17	2966.10	0.07
	Si	14	19040	10	5514.01	0.11	*		3618.66	0.26	-9025.0	0.4	3978.90	0.19
	S	16	16840#	450#	140#	200#	*		10940#	200#	-7860#	540#	9870#	200#
27	O	8	-1940#	530#	*		59260#	500#	-600#	710#	2600#	640#	*	
	F	9	1270	410	16500	420	42650	390	8830	420	11810	420	-15840#	560#
	Ne	10	1500	90	18890	140	19440	90	6430	130	4370	130	-5800	190
	Na	11	6728	5	13288	19	-4795	27	7229	29	5298	4	-7420	100
	Mg	12	6443.39	0.04	15015	4	-31610#	400#	5482.0	1.2	-1304.66	0.05	-2988.6	0.5
	Al	13	13058.03	0.08	8271.29	0.06	*		6706.73	0.07	1600.76	0.05	-3132.56	0.05
	Si	14	13314.80	0.15	7463.32	0.13	*		7242.28	0.13	-7471.58	0.26	7195.47	0.11
	S	16	18120#	720#	1230#	450#	*		8000#	570#	-11430#	640#	11930#	400#
28	O	8	660#	860#	*		67100#	700#	*		960#	860#	*	
	F	9	-220	50	18220#	640#	50590	390	9790	430	11280	430	-16600#	640#
	Ne	10	3820	160	21440	410	32790	130	3360	170	4830	160	-10380	210
	Na	11	3542	11	15330	90	6159	10	9241	21	5910	30	-6680	100
	Mg	12	8503.6	2.0	16790	4	-19090	160	2553	4	-797.0	2.3	-7337	29
	Al	13	7725.10	0.06	9553.00	0.09	-44370#	600#	10074.70	0.08	1206.19	0.09	-1846.4	1.2
	Si	14	17179.61	0.11	11584.90	0.05	*		1428.16	0.07	-7712.76	0.06	-2653.61	0.05
	S	16	21030#	430#	2490	160	*		3810#	250#	-10800#	430#	5890	160
29	F	9	1660	660	19220#	870#	58360	530	6190#	730#	10350	550	*	
	Ne	10	970	200	22630	420	40290	150	3660	420	4610	190	-10610	220
	Na	11	4403	13	15910	130	19633	7	6340	90	7063	20	-10320	110
	Mg	12	3655	12	16903	15	-7450	50	5626	12	1122	12	-5438	22
	Al	13	9428.4	0.4	10477.9	2.0	-31370	190	7089.7	0.3	2870.8	0.3	-5701	4
	Si	14	8473.60	a	12333.40	0.08	*		6012.59	0.05	-4820.87	0.07	-34.13	0.03
	P	15	17876.4	1.2	2749.0	0.4	*		6142.5	0.4	-4947.8	0.4	903.7	0.4
	Cl	17	22430#	630#	-1800	100	*		6850#	440#	-9050#	630#	7840#	270#
30	F	9	110#	800#	*		63980#	600#	6740#	920#	8310#	780#	*	
	Ne	10	3190	290	24160	580	47710	250	250	470	2690	460	-15740#	560#
	Na	11	2277	9	17210	150	28676	5	7890	130	6290	90	-11330	390
	Mg	12	6352	12	18853	8	5175	3	2815	11	1498	5	-10290	90
	Al	13	5728.4	2.9	12551	12	-20310#	200#	9865	4	3585.8	2.9	-4701	5
	Si	14	10609.20	0.02	13514.2	0.3	-45360	210	3128.49	0.08	-2372.04	0.05	-4199.95	0.05
	P	15	11319.3	0.4	5594.75	0.07	*		12002.75	0.07	-2952.30	0.13	2642.41	0.08
	S	16	18970	50	4395.4	0.4	*		3799.3	1.2	-8473	26	3971.65	0.23
31	F	9	40#	810#	*		71090#	550#	*		8930#	890#	*	
	Ne	10	170	130	24220#	650#	54130	270	1740	590	2300	470	-15250#	750#
	Na	11	4300	15	18320	250	36687	14	4560	150	5810	130	-15850	390
	Mg	12	2310	5	18886	6	15920	3	4909	8	2730	11	-8780	130
	Al	13	7157	4	13356	4	-7916	4	6363	12	4932	3	-8316	10
	Si	14	6587.39	0.04	14373.2	2.9	-34270#	200#	5969.5	0.3	-1234.34	0.09	-2283.8	2.0
	P	15	12311.00	0.07	7296.55	0.02	*		8165.34	a	1916.31	a	-1943.49	0.08
	S	16	13054.6	0.3	6130.64	0.24	*		8621.1	0.4	-7030.7	1.2	8096.67	0.23

Table III. Nuclear-reaction and separation energies (continued, Explanation of Table on p. 030003-98)

A	Elt.	Z	S(2n)		S(2p)		Q(α)		Q(2 β^-)		Q(ϵp)		Q($\beta^- n$)	
26	O	8	-18	5	*		-21380	280	34180	170	*		15260	190
	F	9	5040	150	42870#	420#	-15540	240	25510	110	-44620#	520#	12610	110
	Ne	10	9710	18	32600	170	-11230	60	16696	18	-34140	170	1768	18
	Na	11	14586	4	28980	100	-12079	13	5349	4	-25480	100	-1739	4
	Mg	12	18423.61	0.03	24840.8	0.5	-10614.74	0.03	-9073.53	0.11	-21468	29	-15369.88	0.06
	Al	13	28303.92	0.24	18370.19	0.07	-9453.56	0.18	-23180#	200#	-10141.3	1.2	-24109	10
	Si	14	34029	19	7785.39	0.11	-9166.0	0.3	-34220#	600#	-1237.20	0.10	-34950#	400#
	S	16	38490#	540#	3560#	200#	-9650#	450#	*	*	12600#	200#	*	*
27	O	8	-1200#	530#	*		-21930#	1120#	37620#	510#	*		17950#	510#
	F	9	2030	400	45110#	640#	-13700	570	30970	390	*		16900	390
	Ne	10	7060	100	34860	190	-10000	150	21640	90	-34900	190	5840	90
	Na	11	12303	4	31430	100	-11230	30	11679	4	-31460	110	2625	4
	Mg	12	17536.46	0.06	27129	29	-11857.48	0.12	-2202.11	0.12	-22357	18	-10447.78	0.08
	Al	13	24423.52	0.08	22417.0	1.2	-10091.92	0.05	-16474	26	-17625	4	-18127.16	0.12
	Si	14	32354	10	13769.66	0.12	-9335.91	0.19	-29410#	400#	-3458.93	0.11	-31430#	200#
	S	16	36600#	400#	6384	26	-9895	26	*	*	4199	26	-35870#	600#
28	O	8	-1280#	720#	*		*		40780#	710#	*		18560#	800#
	F	9	1050	410	*		-15620#	560#	34730	390	*		18620	400
	Ne	10	5320	130	37940	210	-9630	210	26320	130	-40660#	520#	8750	130
	Na	11	10270	11	34220	110	-10960	100	15862	10	-33730	390	5527	10
	Mg	12	14946.9	2.0	30078	19	-11492.1	2.1	6473.9	2.0	-29360	90	-5893.3	2.0
	Al	13	20783.13	0.10	24568	4	-10857.66	0.08	-9702.9	1.2	-18622	4	-12537.46	0.11
	Si	14	30494.41	0.11	19856.19	0.03	-9984.14	0.01	-25570	160	-14195.15	0.05	-28842	26
	S	16	34260#	200#	9515.5	1.2	-9523.8	1.2	-34660#	600#	2760.2	1.2	-32250#	400#
29	F	9	1440	650	*		-18260#	730#	37470	530	*		20780	540
	Ne	10	4790	170	40850#	520#	-11350	220	29000	150	-40970#	710#	11320	150
	Na	11	7945	8	37350	390	-11080	100	20888	7	-38350	390	9628	8
	Mg	12	12159	11	32230	90	-10990	30	11292	11	-29190	130	-1824	11
	Al	13	17153.5	0.3	27268	4	-11274.9	1.2	-1254.9	0.5	-24508	10	-4786.3	0.3
	Si	14	25653.21	0.11	21886.41	0.05	-11127.21	0.05	-18740	50	-14165.2	2.0	-22818.7	1.2
	P	15	32373	26	14333.9	0.4	-10461.8	0.4	-30120	190	-7391.2	0.4	-29100	160
	Cl	17	36330#	400#	5350	50	-9410	50	*	*	11050	50	-38740#	600#
30	F	9	1770#	710#	*		*		39640#	600#	*		21640#	620#
	Ne	10	4160	280	43380#	740#	-13810	300	32160	250	*		12530	250
	Na	11	6680	11	39840	390	-12600	110	24340	6	-38960	530	11006	12
	Mg	12	10008	4	34760	130	-11790	19	15549	3	-34570	150	1253	3
	Al	13	15156.8	2.9	29454	11	-11429	5	4336.0	2.9	-25834	8	-2041.1	2.9
	Si	14	19082.80	0.02	23992.1	2.0	-10643.33	0.04	-10373.71	0.21	-21119	11	-15551.4	0.4
	P	15	29195.7	1.2	17928.15	0.10	-10415.62	0.09	-24640#	200#	-9282.1	0.4	-25120	50
	Cl	17	34280	160	7144.40	0.21	-9343.15	0.23	-34990	210	546.85	0.21	-35290	190
31	F	9	150#	150#	*		*		43900#	550#	*		24790#	600#
	Ne	10	3360	310	*		-15910#	570#	34300	270	*		14640	270
	Na	11	6577	16	42480	530	-15630	390	27197	14	-43160#	600#	13059	14
	Mg	12	8662	12	36100	150	-12600	90	19827	3	-33690	250	4671	4
	Al	13	12885.6	2.3	32209	8	-11858	4	9489.8	2.2	-30714	5	1410.9	2.2
	Si	14	17196.59	0.04	26924	11	-10787.34	0.07	-3906.51	0.23	-21354	3	-10819.50	0.07
	P	15	23630.3	0.4	20810.7	0.3	-9668.60	0.05	-17406	3	-15864.7	2.9	-18452.60	0.21
	S	16	32030	50	11725.39	0.23	-9082.94	0.25	-30370#	200#	-1898.54	0.23	-31560#	200#
Ar	17	36340	190	4660	3	-8737	27	*	*	5877	3	-36040	210	
	18	*		100#	210#	-8130#	450#	*	*	18100#	200#	*	*	

Table III. Nuclear-reaction and separation energies (continued, Explanation of Table on p. 030003-98)

A	Elt.	Z	S(n)		S(p)		Q(4β ⁻)		Q(d,α)		Q(p,α)		Q(n,α)	
32	Ne	10	2250#	570#	26430#	740#	61080#	500#	-400#	780#	1710#	730#	*	
	Na	11	1680	40	19830	270	42950	40	6070	260	5100	150	-15860	530
	Mg	12	5778	4	20364	14	25187	3	1407	6	1355	8	-13580	150
	Al	13	4220	8	15266	8	2235	7	8495	8	4368	13	-8133	10
	Si	14	9200.0	0.3	16416.0	2.3	-21877.3	1.8	2498.0	2.9	-1005.9	0.5	-7828	11
	P	15	7935.65	0.04	8644.81	0.06	-45400#	400#	10838.89	0.05	2454.26	0.04	-450.7	0.3
	S	16	15044.33	0.23	8863.96	<i>a</i>	*	*	4896.13	0.07	-4198.6	0.4	1525.95	<i>a</i>
	Cl	17	14371	3	1581.1	0.5	*	*	11435.4	0.6	-5310	50	9264.6	0.7
	Ar	18	21600#	200#	2455	4	*	*	4070#	200#	-10500	190	6600	50
	K	19	*	*	-2480#	450#	*	*	10880#	450#	*	*	13580#	440#
33	Ne	10	-930#	780#	*	*	66510#	600#	570#	810#	2750#	840#	*	
	Na	11	2930	450	20510#	680#	50120	450	3310	520	5360	520	-18690#	750#
	Mg	12	2280	4	20970	40	31548.2	2.9	3427	14	1352	6	-12670	250
	Al	13	5469	10	14957	8	12506	7	5336	8	5250	8	-11326	8
	Si	14	4508.0	0.8	16704	7	-11130.0	0.8	5147.2	2.3	214.6	3.0	-5984	4
	P	15	10103.8	1.1	9548.6	1.1	-33380#	200#	7322.5	1.1	2959.7	1.1	-4826	3
	S	16	8641.64	<i>a</i>	9569.95	0.04	*	*	8565.49	<i>a</i>	-1520.95	0.07	3493.51	0.02
	Cl	17	15740.0	0.7	2276.8	0.4	*	*	8750.0	0.5	-2080.0	0.4	4843.9	0.4
	Ar	18	15255.3	1.8	3338.6	0.7	*	*	8361	3	-8960#	200#	10321.4	0.5
	K	19	22130#	450#	-1950#	200#	*	*	6430#	280#	-9030#	280#	8250#	280#
34	Ne	10	1230#	790#	*	*	72800#	510#	*	*	1560#	750#	*	
	Na	11	170	750	21610#	850#	56230	600	5390#	780#	5360	660	-18820#	810#
	Mg	12	4710	29	22750	450	38255	29	390	50	940	30	-17210	270
	Al	13	2574	8	15252	4	21440	3	8539	4	4986	4	-9600	14
	Si	14	7514	14	18748	16	-1579	14	1853	16	-142	14	-11188	14
	P	15	6282.7	1.4	11323.3	1.1	-23330#	200#	10239.8	0.9	3264.4	0.8	-3951.6	2.4
	S	16	11417.15	0.04	10883.3	1.1	-43780#	300#	5083.99	0.06	-627.09	0.04	-1336.25	0.06
	Cl	17	11508.1	0.4	5143.20	0.05	*	*	12286.26	0.05	-533.50	0.23	5646.86	0.05
	Ar	18	17065.3	0.4	4663.9	0.4	*	*	5667.2	0.6	-6480	3	6310.64	0.24
	K	19	16330#	280#	-880#	200#	*	*	11690#	200#	-7680#	280#	11460#	200#
Ca	20	*	*	480#	360#	*	*	3460#	500#	*	*	8170#	360#	
35	Na	11	1520#	300#	21900#	840#	63090#	670#	2950#	900#	6100#	840#	*	
	Mg	12	750	270	23330	660	44490	270	2570	520	1860	270	-15710#	570#
	Al	13	5295	8	15836	30	28790	7	5525	8	5469	8	-13220	40
	Si	14	2510	40	18680	40	8660	40	4820	40	1570	40	-7920	40
	P	15	8380.4	2.0	12190	14	-13684.9	1.9	6367.3	2.0	4083.9	1.9	-8112	7
	S	16	6985.84	0.04	11586.5	0.8	-33630#	200#	8201.9	1.1	322.72	0.06	877.9	0.3
	Cl	17	12644.76	0.05	6370.81	0.04	*	*	8283.13	0.04	1866.06	0.04	937.75	0.05
	Ar	18	12740.3	0.7	5896.2	0.7	*	*	8666.9	0.8	-4848.6	0.9	8614.7	0.7
	K	19	18020#	200#	83.6	0.5	*	*	8922.2	0.7	-4108.5	1.8	7808.2	0.8
	Ca	20	17140#	360#	1280#	280#	*	*	8460#	280#	-11450#	450#	12640#	200#
36	Na	11	0#	100#	*	*	66550#	680#	4170#	850#	5170#	900#	*	
	Mg	12	3330	740	25140#	960#	51040	690	-590	910	1460	820	-19970#	910#
	Al	13	1900	150	16980	310	35470	150	8340	150	5850	150	-12180	470
	Si	14	6120	80	19500	70	17800	70	1270	70	930	70	-11750	70
	P	15	3465	13	13150	40	-2834	13	10417	19	5127	13	-6107	15
	S	16	9889.24	0.19	13095.3	1.9	-24210	40	4595.4	0.8	537.3	1.1	-4503.4	0.7
	Cl	17	8579.79	0.01	7964.77	0.03	-44870#	300#	11120.49	0.04	1927.90	0.04	2461.7	1.1
	Ar	18	15255.6	0.7	8506.98	0.04	*	*	4919.35	0.06	-4364.1	0.4	2000.72	0.03
	K	19	14315.5	0.6	1658.8	0.8	*	*	11672.0	0.3	-3168.7	0.5	9232.7	0.5
	Ca	20	19310#	200#	2570	40	*	*	5480#	200#	-8630#	200#	8580	40
Sc	21	*	*	-3270#	360#	*	*	12210#	420#	*	*	13960#	360#	

Table III. Nuclear-reaction and separation energies (continued, Explanation of Table on p. 030003-98)

A	Elt.	Z	S(2n)		S(2p)		Q(α)		Q($2\beta^-$)		Q($\epsilon\beta$)		Q(β^-n)	
32	Ne	10	2420#	560#	*		-17510#	860#	37830#	500#	*		16680#	500#
	Na	11	5980	40	44050#	600#	-17530	390	29740	40	-44790#	550#	13690	40
	Mg	12	8088	5	38690	250	-14550	130	23249	3	-39300	270	6050	4
	Al	13	11377	8	34152	9	-12536	13	13206	7	-30634	16	3778	7
	Si	14	15787.36	0.30	29772	3	-11483.8	2.0	1937.85	0.30	-28245	3	-7708.46	0.30
	P	15	20246.65	0.08	23018.0	2.9	-9879.14	0.09	-10970.2	0.6	-16643.1	2.2	-13333.67	0.23
	S	16	28098.91	0.21	16160.51	0.02	-6947.65	a	-23815.2	1.8	-10355.47	0.04	-27052	3
	Cl	17	33920#	200#	7711.8	0.6	-8611.9	1.3	-34430#	400#	3816.9	0.6	-32730#	200#
	Ar	18	39270	210	2719.0	1.8	-8700	160	*		9553.2	1.8	*	
	K	19	*		-2080#	450#	-8840#	720#	*		20840#	400#	*	
33	Ne	10	1330#	650#	*		*		41040#	600#	*		19290#	600#
	Na	11	4610	450	46940#	710#	-18790	690	32280	450	*		16540	450
	Mg	12	8058	4	40800	270	-15860	150	25476.6	3.0	-39330#	500#	7990	8
	Al	13	9689	7	35321	16	-13602	10	17840	7	-34430	40	7509	7
	Si	14	13707.9	0.7	31970	3	-12336	11	6071.5	0.7	-26974	3	-4280.8	0.7
	P	15	18039.4	1.1	25964.6	2.5	-10554.5	1.1	-5334.0	1.2	-22527	7	-8393.1	1.1
	S	16	23685.96	0.23	18214.76	0.04	-7115.69	a	-17201.6	0.4	-9797.14	0.30	-21322.5	0.6
	Cl	17	30111	3	11140.7	0.4	-6475.4	0.5	-28050#	200#	-3987.4	0.4	-26874.3	1.8
	Ar	18	36850#	200#	4919.7	0.5	-8650	50	*		9342.3	0.4	-38550#	400#
	K	19	*		500#	200#	-8550#	270#	*		13090#	200#	*	
34	Ne	10	300#	100#	*		*		44520#	510#	*		20990#	680#
	Na	11	3100	600	*		-18860#	850#	34680	600	*		18650	600
	Mg	12	6990	29	43250#	500#	-17380	250	28280	30	-44960#	600#	8749	30
	Al	13	8044	8	36220	40	-13900	6	21548	3	-34070	450	9443	3
	Si	14	12022	14	33706	14	-13498	15	9975	14	-32208	14	-1691	14
	P	15	16386.5	0.8	28027	7	-11108.8	3.0	-108.6	0.8	-23340	7	-6034.2	0.8
	S	16	20058.79	0.04	20431.9	0.3	-7923.64	0.05	-11553.40	0.07	-16706.3	0.7	-16999.7	0.4
	Cl	17	27248.0	0.6	14713.15	0.06	-6664.14	0.08	-23220#	200#	-5391.7	1.1	-23127.1	0.4
	Ar	18	32320.6	1.8	6940.70	0.08	-6743.95	0.22	-32230#	300#	918.59	0.08	-33490#	200#
	K	19	38460#	450#	2460#	200#	-8090#	280#	*		12490#	200#	*	
Ca	20	*		-1470#	300#	-9510#	360#	*		15950#	300#	*		
35	Na	11	1690#	810#	*		-20340#	870#	38460#	670#	*		21840#	670#
	Mg	12	5470	270	44940#	650#	-17970	380	30030	270	-44490#	580#	10570	270
	Al	13	7869	10	38580	450	-14895	16	24634	8	-39190	600	11662	16
	Si	14	10020	40	33930	40	-13690	40	14450	40	-30000	50	2090	40
	P	15	14663.1	2.2	30938	7	-12332.0	2.9	4155.7	1.9	-29146	4	-2997.4	1.9
	S	16	18402.99	0.04	22909.8	0.7	-8322.09	0.06	-5798.9	0.7	-16178	14	-12477.44	0.05
	Cl	17	24152.8	0.4	17254.1	1.1	-6997.90	0.04	-17840.6	0.5	-11753.8	0.8	-18706.56	0.08
	Ar	18	29805.6	0.8	11039.4	0.7	-6429.7	0.7	-27840#	200#	-404.6	0.7	-29900#	200#
	K	19	34360#	200#	4747.5	0.6	-6563	3	*		5978.2	0.5	-33100#	300#
	Ca	20	*		410#	200#	-8960#	280#	*		15880#	200#	*	
36	Na	11	1520#	320#	*		*		40350#	690#	*		22590#	730#
	Mg	12	4090	690	47040#	860#	-19040#	850#	32820	690	*		12530	690
	Al	13	7190	150	40310	620	-15110	150	26200	150	-39570#	690#	12270	150
	Si	14	8620	70	35340	80	-14030	70	18230	70	-35360	280	4350	70
	P	15	11845	13	31829	13	-11577	15	9271	13	-27316	15	524	13
	S	16	16875.08	0.19	25285	14	-9011.4	0.4	-432.59	0.19	-23560	40	-9721.92	0.19
	Cl	17	21224.56	0.05	19551.2	0.8	-7642.05	0.05	-12104.9	0.3	-11953.2	1.9	-14546.0	0.7
	Ar	18	27995.88	0.08	14877.80	0.05	-6640.92	0.03	-23780	40	-8674.30	0.05	-27130.0	0.5
	K	19	32340#	200#	7554.9	0.3	-6507.3	0.6	-32770#	300#	4307.5	0.3	-30280#	200#
	Ca	20	36450#	300#	2650	40	-6680	40	*		9310	40	*	
Sc	21	*		-1990#	360#	-8170#	500#	*		19240#	300#	*		

Table III. Nuclear-reaction and separation energies (continued, Explanation of Table on p. 030003-98)

A	Elt.	Z	S(n)	S(p)	$Q(4\beta^-)$	$Q(d,\alpha)$	$Q(p,\alpha)$	$Q(n,\alpha)$						
42	Al	13	1390#	780#	*	64930#	600#	2460#	780#	2690#	790#	*		
	Si	14	3720#	750#	24240#	710#	50890#	500#	-410#	640#	680#	640#	-20160#	720#
	P	15	2080	340	18400	640	36030	310	6290	470	3550	340	-13990#	510#
	S	16	6700	5	19950	120	20909.5	2.8	1190	150	0	110	-14310	140
	Cl	17	5600	90	13110	60	7290	60	8720	60	3190	80	-6410	130
	Ar	18	9426	6	14400	70	-9318	6	3850	30	242	6	-5610	50
	K	19	7533.80	0.11	9243.5	0.4	-27400#	200#	10728.67	0.11	3084	5	424.6	1.7
	Ca	20	11480.67	0.06	10276.67	0.15	-45280#	400#	5699.05	0.16	124.00	0.15	341	5
	Sc	21	11550.06	0.16	4272.23	0.10	*	*	13436.04	0.17	25.6	0.6	7332.44	0.17
	Ti	22	17478	28	3751.23	0.27	*	*	6129.5	2.8	-6068	24	7824.4	0.7
	V	23	16010#	280#	-790#	200#	*	*	11940#	250#	-4960#	280#	12200#	200#
	Cr	24	*	*	880#	450#	*	*	5270#	500#	*	*	10180#	450#
43	Al	13	1150#	1000#	*	71180#	800#	*	*	3530#	940#	*		
	Si	14	1440#	780#	24290#	850#	55110#	600#	390#	780#	380#	720#	-19600#	780#
	P	15	4400	640	19080#	750#	41260	550	3270	780	4110	650	-17260#	680#
	S	16	2629	6	20490	310	26213	5	3500	120	780	150	-11980	350
	Cl	17	7400	90	13810	60	12030	60	5560	60	3540	60	-10400	170
	Ar	18	5658	8	14470	60	-2689	9	6010	70	410	30	-3526	7
	K	19	9624.7	0.4	9442	6	-18660	40	7202.9	0.5	3328.6	0.4	-3370	30
	Ca	20	7932.89	0.17	10675.77	0.25	-36440#	400#	7861.53	0.23	-9.28	0.23	2277.47	0.23
	Sc	21	12138.3	1.9	4929.8	1.9	*	*	9660.6	1.9	3522.3	1.9	2993.8	1.9
	Ti	22	12288	7	4489	7	*	*	10032	7	-3934	8	11172	7
	V	23	18370#	200#	100	40	*	*	8490	50	-4200	170	8250	40
	Cr	24	16770#	570#	1640#	450#	*	*	8420#	450#	-9280#	500#	12530#	430#
44	Si	14	2660#	840#	25800#	1000#	61190#	600#	-880#	850#	-40#	780#	*	
	P	15	2300#	750#	19940#	780#	46230#	500#	4690#	710#	3200#	750#	-17320#	710#
	S	16	5080	7	21170	550	32264	5	500	310	640	120	-15680	550
	Cl	17	4300	150	15480	140	17430	140	7960	140	3490	140	-9760	180
	Ar	18	8735	6	15800	60	4875.3	1.7	2870	60	-500	70	-8018	4
	K	19	7277.4	0.6	11061	5	-11670	180	9352	6	2150.1	0.5	-2830	70
	Ca	20	11131.17	0.23	12182.3	0.5	-28110#	300#	4264.2	0.3	-1045.1	0.3	-2754.8	0.5
	Sc	21	9699.2	2.6	6696.1	1.7	-44850#	500#	11442.1	1.7	2186.0	1.8	3390.0	1.8
	Ti	22	16299	7	8649.4	2.0	*	*	5283.4	0.7	-4042.1	0.7	3235.7	0.7
	V	23	14270	190	2080	180	*	*	11700	180	-3550	180	10170	180
	Cr	24	19460#	500#	2730#	300#	*	*	4970#	360#	-8820#	360#	7980#	300#
	Mn	25	*	*	-1710#	640#	*	*	11010#	640#	*	*	12360#	540#
45	Si	14	-910#	920#	*	67260#	700#	1180#	1060#	2250#	920#	*		
	P	15	2920#	710#	20200#	780#	52220#	500#	3210#	780#	3990#	710#	-18850#	780#
	S	16	2860	1040	21730#	1150#	36820	1040	2040	1170	-140	1080	-14810#	1150#
	Cl	17	5950	190	16350	140	22810	140	4640	140	4240	140	-13630	340
	Ar	18	5168.9	1.7	16680	140	9239.0	1.0	5100	60	-70	60	-6486.6	2.8
	K	19	8905.5	0.7	11231.4	1.7	-4729.6	1.0	6105	5	2671	6	-6140	60
	Ca	20	7414.82	0.17	12319.7	0.6	-21300	40	6474.0	0.5	-926.1	0.4	-743	6
	Sc	21	11327.2	1.9	6892.2	0.7	-35820#	400#	8047.7	0.7	2339.4	0.7	-403.5	0.7
	Ti	22	9532.6	1.1	8482.8	1.9	-52770#	400#	7889.1	2.0	-2024.6	0.9	5183.8	0.9
	V	23	15840	180	1626.4	1.1	*	*	8146	7	-1917.3	0.9	5881.5	0.9
	Cr	24	14230#	300#	2690	190	*	*	9110	60	-7030#	200#	11240	40
	Mn	25	20350#	640#	-820#	500#	*	*	7430#	570#	-7120#	570#	8020#	450#
Fe	26	*	*	560#	640#	*	*	*	*	*	*	12680#	570#	

Table III. Nuclear-reaction and separation energies (continued, Explanation of Table on p. 030003-98)

A	Elt.	Z	S(2n)		S(2p)		Q(α)		Q($2\beta^-$)		Q(ϵp)		Q($\beta^- n$)	
42	Al	13	3630#	720#	*	*	*	39090#	680#	*	19910#	820#		
	Si	14	5100#	610#	46460#	710#	-20030#	710#	34110#	500#	*	13380#	510#	
	P	15	7020	350	41160#	510#	-17630	490	25840	320	-39700#	590#	11950	310
	S	16	10943	5	37650	350	-15890	100	16785	6	-37050	550	1600	70
	Cl	17	13420	70	31300	160	-12640	90	10190	60	-27140	130	160	60
	Ar	18	15525	6	26163	7	-9986	9	4125	6	-22703	7	-6934	6
	K	19	17629.17	0.12	22040	30	-7648.84	0.14	-2900.87	0.20	-15000	70	-7955.45	0.17
	Ca	20	19843.49	0.15	18085.29	0.15	-6257.34	0.25	-13442.57	0.24	-12768.7	0.4	-17976.15	0.16
	Sc	21	27740.5	2.8	13163.60	0.18	-5745.31	0.26	-24500#	200#	-3850.58	0.17	-24495	28
	Ti	22	32400	160	4836.23	0.28	-5471.1	0.3	-31840#	400#	2744.25	0.24	-33500#	200#
	V	23	35930#	360#	1670#	200#	-5800#	280#	*	*	13730#	200#	*	*
	Cr	24	*	*	-1000#	430#	-6560#	500#	*	*	15140#	400#	*	*
43	Al	13	2540#	940#	*	*	*	42340#	970#	*	22480#	940#		
	Si	14	5160#	810#	*	*	-21600#	790#	35300#	600#	*	14020#	670#	
	P	15	6480	570	43320#	750#	-18400#	680#	28840	560	-42710#	820#	14250	550
	S	16	9330	6	38890	550	-16940	140	19814	7	-35950#	500#	4560	60
	Cl	17	12990	90	33760	140	-13810	130	12420	60	-32460	320	2190	60
	Ar	18	15085	5	27579	7	-11270	50	6399	5	-21661	6	-5059	5
	K	19	17158.5	0.4	23850	70	-9200.1	1.8	-387.3	1.9	-19030	60	-6099.5	0.4
	Ca	20	19413.57	0.18	19919.3	0.4	-7592	5	-9088	7	-11275	6	-14358.99	0.20
	Sc	21	23688.3	1.9	15206.5	1.9	-4805.8	1.9	-18270	40	-8455.0	1.9	-19154.7	1.9
	Ti	22	29766	29	8761	7	-4463	7	-27350#	400#	1937	7	-29770#	200#
	V	23	34380#	210#	3850	40	-6170	50	*	*	6920	40	-32720#	400#
	Cr	24	*	*	850#	400#	-6600#	450#	*	*	15850#	400#	*	*
44	Si	14	4100#	780#	*	*	-22260#	780#	37720#	600#	*	15760#	810#	
	P	15	6700#	590#	44230#	780#	-19560#	640#	30840#	520#	-43860#	940#	14580#	500#
	S	16	7709	6	40250#	500#	-17060	350	23469	5	-39590#	600#	6880	60
	Cl	17	11700	150	35970	340	-14700	210	15400	140	-32350	570	3550	140
	Ar	18	14393	6	29613	3	-12260	4	8795.4	1.6	-27767	5	-4169.2	1.6
	K	19	16902.1	0.4	25530	60	-10650	30	2034.5	1.8	-18910	60	-5444.0	0.5
	Ca	20	19064.06	0.29	21624	6	-8853.7	0.3	-3920.1	0.8	-16748	5	-13351.9	1.9
	Sc	21	21837.5	1.8	17371.9	1.8	-6705.4	1.8	-13700	180	-8529.6	1.8	-16566	7
	Ti	22	28586.5	0.8	13579.3	0.7	-5127.1	0.7	-24190#	300#	-6428.7	0.7	-27700	40
	V	23	32640#	270#	6570	180	-6020	180	-31150#	530#	4780	180	-30220#	440#
	Cr	24	36230#	500#	2830#	300#	-6940#	340#	*	*	8670#	300#	*	*
	Mn	25	*	*	-70#	540#	-7570#	580#	*	*	17660#	500#	*	*
45	Si	14	1750#	920#	*	*	*	41480#	1250#	*	18970#	860#		
	P	15	5220#	750#	46000#	940#	-20250#	710#	33860#	520#	*	16730#	500#	
	S	16	7940	1040	41670#	1200#	-18530	1170	25780	1040	-39790#	1200#	8320	1040
	Cl	17	10250	150	37520	570	-15710	180	18350	140	-36000#	520#	6340	140
	Ar	18	13904	5	32153	5	-13187	4	11041.4	0.6	-27856	5	-2060.6	0.7
	K	19	16182.9	0.7	27030	60	-11730	70	4456.3	0.9	-23520	140	-3218.3	0.6
	Ca	20	18545.99	0.29	23380	5	-10169.6	0.5	-1802.3	0.9	-15427.9	1.6	-11067.5	1.8
	Sc	21	21026.4	2.0	19074.4	0.8	-7937.3	0.7	-9185.9	0.6	-12579.4	0.8	-11594.6	1.0
	Ti	22	25831	7	15179.0	0.9	-6296.9	0.9	-19500	40	-4830.1	0.9	-22960	180
	V	23	30110	40	10275.9	2.1	-5668.5	0.9	-26640#	400#	-1359.0	2.0	-26600#	300#
	Cr	24	33690#	400#	4770	40	-6240	50	-33280#	400#	10740	40	-34620#	500#
	Mn	25	*	*	1910#	400#	-8000#	450#	*	*	11580#	440#	*	*
Fe	26	*	*	-1154	16	*	*	*	*	19830#	500#	*	*	

Table III. Nuclear-reaction and separation energies (continued, Explanation of Table on p. 030003-98)

A	Elt.	Z	S(n)		S(p)		Q(4β ⁻)		Q(d,α)		Q(p,α)		Q(n,α)	
46	P	15	700#	860#	21810#	990#	58380#	700#	5170#	920#	4730#	920#	-18400#	1060#
	S	16	3740#	1150#	22550#	710#	43480#	500#	600#	710#	520#	750#	-17120#	780#
	Cl	17	3670	250	17160	1060	27900	210	6060	210	3200	210	-12890	590
	Ar	18	8073.4	1.2	18800	140	14354.9	1.1	1320	140	-750	60	-11931	5
	K	19	6869.6	0.9	12932.1	0.9	1661.4	0.8	7970.1	1.7	1460	5	-5610	60
	Ca	20	10398.5	2.3	13812.7	2.3	-13668	12	3352.9	2.3	-1699.9	2.3	-5483	6
	Sc	21	8760.64	0.10	8238.0	0.8	-29190#	400#	10418.3	0.7	1511.7	0.7	460.6	0.8
	Ti	22	13189.3	0.8	10344.9	0.7	-45040#	500#	4399.0	1.8	-3075.6	1.9	-72.58	0.28
	V	23	13260.7	0.9	5354.5	0.8	*	*	11184.0	0.7	-2890	7	4759.2	1.9
	Cr	24	18030	40	4875	11	*	*	5360	180	-6690	40	5496	14
	Mn	25	15390#	570#	340#	400#	*	*	11500#	500#	-5740#	570#	10990#	400#
	Fe	26	20920#	640#	1130#	640#	*	*	4590#	710#	*	*	8530#	640#
47	P	15	1330#	1060#	*	*	65420#	800#	2930#	1060#	6060#	1000#	*	*
	S	16	1040#	710#	22890#	860#	49710#	500#	2480#	710#	1780#	710#	-15500#	780#
	Cl	17	3990#	450#	17410#	640#	34560#	400#	4920#	1110#	4290#	400#	-14580#	640#
	Ar	18	3664.7	1.6	18800	210	19571.0	1.1	3610	140	-120	140	-10516	5
	K	19	8369.4	1.6	13228.0	1.8	6294.6	1.4	4769.6	1.5	1825.3	2.1	-9680	140
	Ca	20	7276.37	0.27	14219.5	2.3	-7782	6	4982.0	2.3	-1698.9	2.3	-4024.8	2.7
	Sc	21	10646.7	2.0	8486.2	1.2	-21770	30	7186.4	2.0	1996.1	2.0	-2908.7	2.0
	Ti	22	8880.88	0.13	10465.1	0.7	-38070#	500#	6845.3	0.7	-2257.3	1.8	2177.7	0.3
	V	23	13002.58	0.11	5167.79	0.07	-52380#	600#	7714.0	0.8	406.0	0.7	1455.8	1.8
	Cr	24	13162	13	4776	6	*	*	8034	6	-5580	180	8632	6
	Mn	25	18070#	400#	380	30	*	*	7660	50	-4340#	300#	7200	180
	Fe	26	15850#	710#	1590#	640#	*	*	9090#	640#	-9040#	710#	12140#	580#
	Co	27	*	*	-2170#	780#	*	*	7320#	720#	*	*	8990#	780#
48	S	16	2680#	780#	24240#	1000#	56990#	600#	500#	920#	2030#	780#	-19080#	920#
	Cl	17	2570#	640#	18940#	710#	40220#	500#	6090#	710#	4570#	1150#	-14230#	710#
	Ar	18	4990	310	19790#	500#	26210	310	2290	370	850	340	-12650	1080
	K	19	4643.8	1.6	14207.1	1.4	12193.2	1.2	8199.3	1.4	2350.4	0.9	-8380	140
	Ca	20	9951.5	2.2	15801.6	1.4	-1403	7	1900.1	0.7	-2744.9	0.5	-8807.4	0.5
	Sc	21	8239	5	9448	5	-15208	9	9346	5	1172	5	-2242	5
	Ti	22	11626.66	0.04	11445.1	1.9	-30490#	400#	3979.3	0.7	-2556.8	0.7	-2034.1	0.4
	V	23	10542.4	1.0	6829.3	1.0	-45980#	500#	10360.9	1.0	-603.8	1.3	2240.6	1.2
	Cr	24	16331	9	8104	7	-59620#	500#	4964	7	-6072	7	1834	7
	Mn	25	14800	30	2023	6	*	*	10886	13	-4920	40	8236	7
	Fe	26	19200#	640#	2720#	400#	*	*	5280#	570#	-7890#	570#	7160#	400#
	Co	27	16940#	780#	-1080#	710#	*	*	11300#	710#	-7400#	640#	12400#	640#
	Ni	28	*	*	870#	780#	*	*	*	*	*	*	8680#	640#
49	S	16	-260#	300#	*	*	62390#	670#	2090#	1040#	2990#	970#	*	*
	Cl	17	2850#	780#	19110#	850#	47500#	600#	4280#	780#	5460#	780#	-16380#	920#
	Ar	18	2980#	500#	20200#	640#	31370#	400#	3300#	570#	1530#	450#	-11880#	640#
	K	19	5398.3	1.1	14620	310	18350.4	1.2	6465.7	1.4	5025.5	1.4	-10110	210
	Ca	20	5146.45	0.18	16304.3	0.8	4033.3	2.3	5123.0	1.4	-1021.8	0.8	-5880.4	1.1
	Sc	21	10129	6	9625.6	2.7	-8941	4	6494	3	1442	4	-5500.9	2.8
	Ti	22	8142.40	0.03	11349	5	-23813	24	6483.6	1.9	-1938.5	0.7	222.0	2.2
	V	23	11555.6	1.3	6758.2	0.8	-38080#	500#	7686.2	0.8	1029.9	0.8	-554.3	1.1
	Cr	24	10582	8	8144.3	2.4	-53530#	600#	7384.4	2.2	-3393.7	2.3	4441.1	2.2
	Mn	25	16396	7	2088	8	*	*	7653	6	-3285	12	5101.1	2.3
	Fe	26	14820#	400#	2743	25	*	*	8530	40	-7320#	400#	10367	27
	Co	27	19450#	710#	-830#	640#	*	*	7700#	710#	-5930#	710#	8340#	640#
	Ni	28	16670#	780#	590#	780#	*	*	8540#	850#	*	*	12940#	780#

Table III. Nuclear-reaction and separation energies (continued, Explanation of Table on p. 030003-98)

A	Elt.	Z	S(2n)	S(2p)	$Q(\alpha)$	$Q(2\beta^-)$	$Q(\epsilon p)$	$Q(\beta^-n)$						
46	P	15	3620#	860#	*	-19560#	920#	36830#	730#	*	18890#	1250#		
	S	16	6600#	500#	42750#	780#	-18560#	710#	30110#	500#	-44440#	860#	10530#	520#
	Cl	17	9620	250	38890#	540#	-17290	380	21550	210	-36750#	540#	7840	210
	Ar	18	13242.3	1.9	35147	5	-14560	3	13366.4	2.5	-33070	1040	-1228.6	1.2
	K	19	15775.1	0.8	29610	140	-13010	60	6347.3	1.0	-24440	140	-2673.1	0.8
	Ca	20	17813.3	2.3	25044.0	2.7	-11142	6	988.4	2.2	-20657.5	2.3	-10138.8	2.3
	Sc	21	20087.9	1.9	20557.7	0.8	-9164.1	0.7	-4685.9	0.7	-12434.6	0.9	-10822.7	0.5
	Ti	22	22721.9	0.7	17237.1	0.4	-8005.47	0.22	-14656	11	-10604.6	0.4	-20313.1	0.9
	V	23	29100	180	13837.3	1.8	-7379.11	0.26	-24510#	400#	-3292.4	0.7	-25630	40
	Cr	24	32250#	300#	6501	11	-6792	11	-30380#	500#	2249	11	-32290#	400#
	Mn	25	35740#	640#	3030#	440#	-7380#	450#	*	*	12030#	400#	-34400#	570#
	Fe	26	*	*	310#	580#	-8250#	640#	*	*	13140#	500#	*	*
	47	P	15	2030#	940#	*	-19740#	1130#	39490#	890#	*	*	21300#	940#
		S	16	4780#	1150#	44700#	860#	-18160#	780#	32740#	500#	*	*	13160#
Cl		17	7660#	420#	39960#	640#	-16880#	680#	25930#	400#	-40040#	810#	11920#	400#
Ar		18	11738.2	1.2	35950	1040	-15596	5	16978.1	2.5	-33000#	500#	1976.3	1.3
K		19	15239.0	1.5	32030	140	-13980	60	8624.6	2.4	-29140	210	-643.9	2.6
Ca		20	17674.9	2.3	27151.6	2.3	-12760	6	2592.9	2.2	-19860.5	2.5	-8654.5	2.3
Sc		21	19407.3	2.0	22298.9	2.0	-10186.1	2.0	-2330.0	1.9	-16211.6	2.1	-8280.1	1.9
Ti		22	22070.2	0.8	18703.1	0.4	-8953.46	0.25	-10375	6	-9087.0	2.2	-15933.33	0.18
V		23	26263.2	0.9	15512.7	0.7	-8243.4	1.9	-19440	30	-7534.4	0.7	-20606	11
Cr		24	31190	40	10131	6	-7666	9	-27690#	500#	2276	6	-30060#	400#
Mn		25	33460#	400#	5260	30	-7070	50	-32940#	600#	7220	30	-31550#	500#
Fe		26	36770#	640#	1930#	500#	-7330#	640#	*	*	15310#	500#	*	*
Co		27	*	*	-1040#	720#	*	*	*	*	15650#	720#	*	*
48		S	16	3720#	780#	*	-18180#	840#	35040#	670#	*	*	14470#	720#
	Cl	17	6560#	540#	41830#	860#	-17160#	710#	28000#	500#	-41280#	940#	13020#	500#
	Ar	18	8650	310	37200#	590#	-15500	310	21940	310	-36940#	590#	5360	310
	K	19	13013.2	1.1	33000	210	-14320	140	12219	5	-29790#	400#	1988.6	2.4
	Ca	20	17227.9	2.2	29029.6	1.1	-13976.3	1.6	4268.08	0.08	-26147.3	1.1	-7959.4	1.9
	Sc	21	18885	5	23668	5	-11147	5	-26	5	-16081	5	-7638	5
	Ti	22	20507.54	0.14	19931.3	2.2	-9448.9	0.3	-5671	7	-13437.3	2.2	-14557.41	0.14
	V	23	23545.0	1.0	17294.4	1.2	-9086.6	2.0	-15181	7	-7430.1	2.2	-17986	6
	Cr	24	29493	14	13272	7	-7698	7	-24820#	400#	-5174	7	-28330	30
	Mn	25	32870#	400#	6799	7	-7600	180	-30800#	500#	5421	7	-30500#	500#
	Fe	26	35050#	640#	3110#	400#	-7070#	500#	-34790#	640#	9270#	400#	-36440#	720#
	Co	27	*	*	510#	640#	-7960#	710#	*	*	16780#	500#	*	*
	Ni	28	*	*	-1310	40	*	*	*	*	16370#	710#	*	*
	49	S	16	2420#	830#	*	-18820#	970#	38280#	780#	*	*	17300#	830#
Cl		17	5420#	720#	43350#	1000#	-17090#	780#	30550#	600#	*	*	15150#	670#
Ar		18	7970#	400#	39140#	640#	-15630#	1110#	24110#	400#	-37240#	720#	7020#	400#
K		19	10042.1	1.6	34410#	400#	-13770	140	16949.8	2.8	-32620#	500#	6541.8	0.8
Ca		20	15098.0	2.2	30511.4	1.1	-13953.9	0.6	7264.02	0.19	-26310	310	-4867	5
Sc		21	18367	3	25427	3	-12370.5	2.7	1400.7	2.8	-21565.8	2.8	-6139.9	2.7
Ti		22	19769.06	0.05	20797.3	2.2	-10176.5	0.4	-3230.7	2.2	-11628.13	0.08	-12157.4	1.0
V		23	22097.9	0.8	18203.3	2.1	-9315.0	1.1	-10341.3	2.4	-10747	5	-13211	7
Cr		24	26913	6	14973.6	2.2	-8748.1	2.4	-20582	24	-4129.3	2.2	-24108	7
Mn		25	31200	30	10192.0	2.3	-8159.5	2.4	-27740#	500#	-431.9	2.5	-27690#	400#
Fe		26	34020#	500#	4766	25	-7660	40	-32950#	600#	10782	25	-34320#	500#
Co		27	36390#	780#	1890#	500#	-7060#	640#	*	*	12130#	500#	-34750#	710#
Ni		28	*	*	-490#	780#	-7990#	720#	*	*	18910#	720#	*	*

Table III. Nuclear-reaction and separation energies (continued, Explanation of Table on p. 030003-98)

A	Elt.	Z	S(n)		S(p)		Q(4β ⁻)		Q(d,α)		Q(p,α)		Q(n,α)	
50	Cl	17	1270#	850#	20640#	900#	52290#	600#	5690#	850#	5230#	780#	-16320#	1000#
	Ar	18	4210#	640#	21560#	780#	38100#	500#	1660#	710#	1310#	640#	-15050#	710#
	K	19	4188	8	15830#	400#	23496	8	7260	310	4503	8	-10300#	400#
	Ca	20	6360.8	1.6	17266.7	1.8	10672.8	1.6	3406.1	1.8	986.8	2.1	-8576.5	1.9
	Sc	21	6057	15	10537	15	-1920	15	10388	15	2661	15	-3189	15
	Ti	22	10939.19	0.04	12159.4	2.7	-16955	8	3783	5	-2231.0	1.9	-3440.8	2.2
	V	23	9333.4	0.9	7949.2	0.4	-31590#	400#	9979.5	0.4	577.4	0.4	759.0	2.0
	Cr	24	13000.3	2.2	9589.1	0.9	-46140#	500#	4926.4	1.1	-3391.4	0.5	321.7	0.5
	Mn	25	13078.3	2.2	4583.5	2.2	*	*	10905	7	-3201	6	5025.4	0.5
	Fe	26	17797	26	4145	9	*	*	5531	11	-7050	30	5733	10
	Co	27	15820#	640#	170#	400#	*	*	11080#	570#	-5900#	640#	10580#	400#
	Ni	28	20390#	780#	1530#	710#	*	*	5090#	710#	-9630#	780#	8400#	710#
51	Cl	17	1520#	920#	*	*	57520#	700#	3910#	970#	6390#	920#	*	*
	Ar	18	1430#	780#	21720#	850#	43040#	600#	3080#	850#	2450#	780#	-13810#	850#
	K	19	4860	15	16480#	500#	29688	13	5380#	400#	4630	310	-12590#	500#
	Ca	20	4814.4	1.7	17893	8	15119.1	0.7	3990.0	1.0	816.2	0.9	-8400	310
	Sc	21	6753	25	10928	20	5015	20	8782	20	5860	20	-5298	20
	Ti	22	6372.5	0.5	12474	15	-9530	9	7539.2	2.7	-365	5	138.2	0.5
	V	23	11051.15	0.08	8061.2	0.4	-24860	50	7070.8	0.4	1152.9	0.4	-2054	5
	Cr	24	9260.64	0.20	9516.35	0.23	-39550#	500#	7221.3	0.9	-2109.6	1.1	2687.7	0.4
	Mn	25	13687.60	0.30	5270.78	0.29	*	*	7800.0	2.2	-558	7	1880.2	1.1
	Fe	26	13797	12	4864	9	*	*	8129	9	-6042	11	8266	12
	Co	27	17780#	400#	150	50	*	*	8120	50	-4480#	400#	7600	50
	Ni	28	15850#	710#	1560#	640#	*	*	8690#	710#	-8540#	710#	11750#	640#
52	Ar	18	2660#	850#	22860#	920#	48190#	600#	1690#	850#	2640#	850#	-16730#	900#
	K	19	2690	40	17740#	600#	34310	30	6900#	500#	4920#	400#	-12430#	600#
	Ca	20	6005.3	0.8	19039	13	21153.0	0.8	2172	8	209.3	1.0	-11430#	400#
	Sc	21	5290	80	11400	80	10260	80	9860	80	5720	80	-5190	80
	Ti	22	7808	7	13530	21	-1139	9	5788	17	1955	8	-2524	7
	V	23	7311.24	0.13	8999.9	0.7	-17083	8	10698.7	0.4	1984.1	0.4	763.9	2.7
	Cr	24	12039.2	0.5	10504.4	0.5	-33090#	400#	4515.6	0.5	-2593.3	0.9	-1209.1	0.4
	Mn	25	10534.7	1.9	6544.9	1.9	-48430#	600#	10265.6	1.9	-510.2	2.9	2901.0	2.0
	Fe	26	16199	10	7375	5	*	*	5008	5	-5846	6	2649	6
	Co	27	15090	50	1447	12	*	*	10826	12	-4746	26	8906	9
	Ni	28	18500#	640#	2280#	400#	*	*	6010#	570#	-7590#	640#	8070#	400#
	Cu	29	*	*	-2330#	780#	*	*	12550#	780#	-5620#	850#	13250#	780#
53	Ar	18	0#	920#	*	*	53620#	710#	3210#	990#	3920#	920#	*	*
	K	19	3230	120	18310#	610#	39560	110	5110#	610#	5900#	510#	-14390#	610#
	Ca	20	3190	40	19540	60	25900	40	3840	50	1200	40	-10410#	500#
	Sc	21	6530	120	11930	90	15780	90	8140	90	5550	90	-7530	90
	Ti	22	5430	100	13680	130	4120	100	7110	100	2580	100	-1600	100
	V	23	8479	3	9670	8	-9192	4	8593	3	4445	3	-1657	15
	Cr	24	7939.07	0.14	11132.2	0.5	-25656	25	7627.6	0.5	-1198.9	0.5	1791.1	0.4
	Mn	25	12054.1	1.9	6559.8	0.3	-41420#	500#	7472.1	0.6	436.0	0.6	180.3	0.6
	Fe	26	10688	5	7529.2	2.4	*	*	8007.2	1.7	-3455.9	1.7	4960.9	1.7
	Co	27	16370	9	1618	5	*	*	8254	9	-3319	9	5614.6	1.8
	Ni	28	15370#	400#	2559	27	*	*	8420	50	-7140#	400#	10492	27
	Cu	29	19060#	780#	-1770#	640#	*	*	9340#	710#	-4290#	710#	10010#	640#

Table III. Nuclear-reaction and separation energies (continued, Explanation of Table on p. 030003-98)

A	Elt.	Z	S(2n)		S(2p)		Q(α)		Q($2\beta^-$)		Q(ϵ_p)		Q(β^-n)	
50	Cl	17	4120#	780#	*		-17660#	920#	33470#	600#	*		16860#	720#
	Ar	18	7190#	590#	40670#	780#	-16100#	710#	26260#	500#	-41710#	830#	8210#	500#
	K	19	9586	8	36030#	500#	-14290	210	18820	17	-33960#	600#	7501	8
	Ca	20	11507.2	1.6	31890	310	-12241.2	1.9	11842.4	1.6	-29690#	400#	-1099	3
	Sc	21	16186	16	26841	15	-11558	15	4677	15	-22225	15	-4055	15
	Ti	22	19081.59	0.05	21784.97	0.09	-10717.2	2.2	-1169.6	0.5	-17420.87	0.20	-11541.0	0.8
	V	23	20889.0	1.1	19298	5	-9887.7	0.8	-6596.4	0.3	-9951.7	2.7	-11962.3	2.2
	Cr	24	23583	7	16347.3	0.4	-8559.2	0.5	-15786	8	-8987.3	0.5	-20712.8	2.2
	Mn	25	29474	7	12727.8	1.1	-7977.2	0.5	-25000#	400#	-1954.6	0.9	-25948	24
	Fe	26	32620#	400#	6232	11	-7430	14	-30360#	500#	3568	9	-32670#	500#
	Co	27	35270#	640#	2910#	400#	-7490#	570#	*		12700#	400#	-33900#	720#
	Ni	28	37060#	710#	700#	640#	-7460#	710#	*		13340#	500#	*	
	51	Cl	17	2790#	920#	*		-17850#	1060#	36810#	700#	*		19550#
Ar		18	5640#	720#	42360#	900#	-16490#	780#	29640#	600#	*		10970#	600#
K		19	9047	13	38030#	600#	-15160#	400#	20712	24	-37550#	600#	9002	13
Ca		20	11175.2	0.6	33720#	400#	-13390.9	1.2	13400.5	0.7	-30290#	500#	144	15
Sc		21	12810	20	28195	20	-9942	20	8975	20	-24790	21	132	20
Ti		22	17311.7	0.5	23011.0	0.5	-9813.3	2.3	1718.6	0.6	-17432.6	1.7	-8580.1	0.6
V		23	20384.5	0.9	20220.5	2.7	-10292.2	2.0	-3960.0	0.4	-14945	15	-10013.09	0.29
Cr		24	22261.0	2.2	17465.5	0.4	-8938.9	0.4	-11249	9	-7308.7	0.4	-16895.12	0.21
Mn		25	26765.9	2.2	14859.9	1.0	-8662.2	0.5	-20900	50	-6308.8	0.4	-21839	8
Fe		26	31594	26	9447	9	-8065	11	-28300#	500#	2771	9	-30640#	400#
Co		27	33600#	500#	4300	50	-7200	60	*		8000	50	-31290#	500#
Ni		28	36240#	780#	1730#	500#	-7460#	710#	*		15290#	500#	*	
52		Ar	18	4090#	780#	*		-16470#	850#	32990#	600#	*		13170#
	K	19	7550	30	39460#	600#	-15280#	500#	23310	90	-38720#	700#	11120	30
	Ca	20	10819.7	1.7	35520#	500#	-14410	310	15204	7	-34870#	600#	891	20
	Sc	21	12040	80	29290	80	-10580	80	11000	80	-25220	80	1220	80
	Ti	22	14181	7	24459	7	-7670	7	5949	7	-20426	7	-5337	7
	V	23	18362.39	0.15	21474	15	-9365	5	-736.5	1.9	-15504	20	-8063.69	0.25
	Cr	24	21299.8	0.5	18565.5	0.4	-9351.4	0.4	-7089	5	-12975.4	0.6	-15246.7	0.6
	Mn	25	24222.3	1.9	16061.2	1.9	-8654.5	2.1	-16346	9	-5792.4	1.9	-18576	9
	Fe	26	29997	10	12646	5	-7933	9	-26000#	400#	-4168	5	-29060	50
	Co	27	32870#	400#	6311	8	-7490	11	-32080#	600#	6594	8	-30530#	500#
	Ni	28	34350#	640#	2430#	400#	-6750#	570#	*		10580#	400#	*	
	Cu	29	*		-770#	720#	-6210#	780#	*		17770#	600#	*	
	53	Ar	18	2660#	920#	*		-16730#	970#	36180#	700#	*		15860#
K		19	5920	110	41160#	710#	-15660#	610#	26610	150	*		13900	110
Ca		20	9200	40	37280#	600#	-14620#	400#	17440	110	-35400#	600#	2980	90
Sc		21	11820	100	30970	90	-11720	90	12940	90	-29060	100	2490	90
Ti		22	13240	100	25080	100	-7960	100	8460	100	-19850	100	-3460	100
V		23	15790	3	23200	20	-7715	4	2839	3	-18700	80	-4503	3
Cr		24	19978.2	0.5	20132.1	0.6	-9148.1	0.4	-4339.5	1.7	-13106	7	-12651.0	1.9
Mn		25	22588.9	0.7	17064.2	0.6	-9153.1	0.9	-12030.7	1.7	-10535.3	0.6	-14431	5
Fe		26	26888	9	14074.1	1.7	-8039.4	2.8	-21317	25	-2817.3	1.7	-24658	9
Co		27	31460	50	8993.5	1.8	-7463.7	2.8	-29390#	500#	758.9	2.4	-28400#	400#
Ni		28	33870#	500#	4006	27	-7310	30	*		11411	26	-35420#	600#
Cu		29	*		510#	500#	-5820#	710#	*		13800#	500#	*	

Table III. Nuclear-reaction and separation energies (continued, Explanation of Table on p. 030003-98)

A	Elt.	Z	S(n)		S(p)		Q($4\beta^-$)		Q(d, α)		Q(p, α)		Q(n, α)	
54	K	19	780#	610#	19080#	920#	44890#	600#	6990#	850#	6550#	850#	-13650#	920#
	Ca	20	3840	70	20150	120	31770	50	2690	60	2220	50	-12820#	600#
	Sc	21	3060	290	11790	280	21670	270	11090	270	7310	270	-5730	270
	Ti	22	6860	130	14000	130	10630	80	5530	120	2470	80	-3640	80
	V	23	6113	15	10350	100	-1883	15	10287	17	4704	15	-1018	25
	Cr	24	9719.08	0.12	12373	3	-17656	5	5219.8	0.5	133.1	0.5	-1555.5	0.6
	Mn	25	8938.8	1.1	7559.6	1.0	-34150#	400#	10572.4	1.0	757.8	1.1	2292.6	1.1
	Fe	26	13378.3	1.6	8853.4	0.5	-49980#	400#	5163.6	1.8	-3146.6	0.6	843.3	0.5
	Co	27	13421.8	1.7	4351.4	1.6	*	*	11031	5	-2943	9	5880.3	0.6
	Ni	28	17719	26	3908	5	*	*	5793	10	-7070	50	6571	10
	Cu	29	16210#	640#	-930#	400#	*	*	11630#	570#	-4650#	640#	11580#	400#
	Zn	30	*	*	290#	640#	*	*	6720#	720#	*	*	11270#	640#
	55	K	19	2360#	920#	*	*	49850#	710#	4630#	990#	6850#	920#	*
Ca		20	1260#	300#	20640#	670#	36760#	300#	4660#	320#	3650#	300#	-11420#	670#
Sc		21	4340	530	12290	460	27550	450	9940	460	8970	450	-7380	460
Ti		22	4120	180	15070	320	15810	160	7950	190	3640	180	-1760	160
V		23	7320	100	10810	130	4890	100	8400	140	5190	100	-3050	130
Cr		24	6246.26	0.19	12506	15	-9773.9	0.8	7452	3	1198.1	0.6	7	7
Mn		25	10226.1	1.1	8066.6	0.3	-26080	160	8285.4	0.3	2570.9	0.3	-622.2	0.5
Fe		26	9298.12	0.19	9212.6	1.1	-42910#	400#	7919.6	0.5	-1910.0	1.8	3584.3	0.4
Co		27	14091.2	0.3	5064.35	0.30	*	*	7628.5	1.6	-835	5	2323.8	1.8
Ni		28	14129	5	4614.9	0.7	*	*	8034.4	1.8	-6111	8	8641	5
Cu		29	18300#	430#	-350	160	*	*	8710	160	-4440#	430#	8370	160
Zn		30	16370#	570#	450#	570#	*	*	9410#	640#	-7430#	720#	13410#	570#
56		K	19	850#	1060#	*	*	54080#	820#	*	*	6000#	1060#	*
	Ca	20	3620#	500#	21900#	810#	41390#	400#	1820#	720#	3260#	420#	-15040#	810#
	Sc	21	2760	740	13790#	660#	32060	590	11020	590	9400	590	-6910	600
	Ti	22	5720	200	16450	470	21290	120	5280	300	4450	150	-4290	130
	V	23	5080	200	11780	240	9890	180	10180	200	5540	200	-1600	200
	Cr	24	8246.6	0.6	13430	100	-1377.5	0.6	5319	15	1430	3	-2810	100
	Mn	25	7270.44	0.13	9090.8	0.4	-18269	15	10734.0	0.3	3239.5	0.3	586	3
	Fe	26	11197.10	0.23	10183.64	0.16	-35220#	400#	5661.4	1.1	-1052.9	0.4	326.3	0.3
	Co	27	10081.8	0.5	5848.1	0.4	-52650#	500#	10924.9	0.5	-228.8	1.7	4296.1	0.6
	Ni	28	16643.0	0.7	7166.6	0.3	*	*	4813.2	0.4	-6384.1	1.7	2686.4	1.7
	Cu	29	15080	160	596	15	*	*	11346	16	-4148	29	9663	15
	Zn	30	18890#	570#	1040#	430#	*	*	6730#	570#	-7260#	640#	9890#	400#
	Ga	31	*	*	-3890#	640#	*	*	13590#	640#	*	*	15530#	710#
57	Ca	20	1050#	570#	22090#	900#	45650#	400#	3130#	810#	2990#	720#	*	*
	Sc	21	4210	1430	14390#	1360#	36490	1300	8070#	1340#	9030	1300	-10350#	1430#
	Ti	22	2670	280	16350	640	26270	260	6950	520	4840	370	-3110	260
	V	23	6330	190	12380	150	14930	80	7970	180	6070	120	-4880	280
	Cr	24	5311.0	1.2	13660	180	3559.1	1.2	7330	100	2233	15	-1260	80
	Mn	25	8646.0	1.5	9490.2	1.6	-10177.4	1.6	8334.3	1.6	4312.6	1.5	-1947	15
	Fe	26	7646.07	0.04	10559.27	0.21	-27630#	200#	8241.38	0.16	239.8	1.1	2399.3	0.3
	Co	27	11376.5	0.6	6027.5	0.4	-44340#	400#	8846.5	0.5	1773.0	0.5	1858.5	1.1
	Ni	28	10247.6	0.5	7332.4	0.6	*	*	8656.9	0.6	-3209.8	0.6	5817.1	0.6
	Cu	29	16737	15	690.3	0.4	*	*	8737.8	0.8	-3167	5	6347.5	0.5
	Zn	30	15230#	450#	1200#	200#	*	*	9800#	250#	-6280#	450#	12380#	200#
	Ga	31	19690#	640#	-3090#	570#	*	*	10270#	570#	-3870#	570#	12050#	570#

Table III. Nuclear-reaction and separation energies (continued, Explanation of Table on p. 030003-98)

A	Elt.	Z	S(2n)		S(2p)		Q(α)		Q($2\beta^-$)		Q(ϵ_p)		Q(β^-n)	
54	K	19	4010#	600#	*		-15170#	850#	28890#	660#	*		16310#	600#
	Ca	20	7040	50	38460#	600#	-14260#	500#	20460	100	-39240#	700#	5670	110
	Sc	21	9590	280	31330	270	-10590	270	16000	270	-28880	290	4870	290
	Ti	22	12290	80	25930	80	-8460	80	11310	80	-23520	90	-1840	80
	V	23	14592	15	24030	80	-7771	21	5664	15	-18280	100	-2677	15
	Cr	24	17658.16	0.18	22043	7	-7928.0	0.4	-680.3	0.4	-17390	100	-10316.0	0.4
	Mn	25	20993.0	2.1	18691.8	1.1	-8758.5	1.1	-7547.7	1.1	-10996	3	-12681.4	1.9
	Fe	26	24067	5	15413.2	0.4	-8417.3	0.5	-16976	5	-8256.5	0.4	-21666.4	1.7
	Co	27	29792	8	11880.6	1.8	-7807.3	0.5	-26600#	400#	-608.8	0.5	-26450	25
	Ni	28	33090#	400#	5526	7	-7227	10	-33010#	400#	4380	5	-34080#	500#
	Cu	29	35270#	720#	1630#	400#	-6210#	570#	*	*	13960#	400#	*	*
	Zn	30	*	*	-1480	20	-4580#	640#	*	*	16070#	400#	*	*
	55	K	19	3140#	710#	*		-16010#	990#	30870#	830#	*		17800#
Ca		20	5110#	300#	39720#	760#	-14090#	670#	23320#	340#	*		7470#	410#
Sc		21	7400	460	32440	470	-10070	450	18990	460	-32450#	750#	7390	460
Ti		22	10980	190	26860	170	-7760	160	13440	160	-23800	170	150	160
V		23	13440	100	24820	130	-8340	100	8570	100	-22540	290	-280	100
Cr		24	15965.35	0.22	22860	100	-7801.8	0.6	2371.6	0.4	-16780	80	-7623.4	1.0
Mn		25	19164.9	0.4	20439	3	-7933.5	0.5	-3682.5	0.3	-15108	15	-9529.23	0.25
Fe		26	22676.4	1.6	16772.2	0.4	-8454.8	0.5	-12145.5	0.7	-7835.5	0.4	-17542.66	0.21
Co		27	27513.1	1.7	13917.7	0.5	-8210.9	0.6	-22390	160	-5761.2	1.1	-22823	5
Ni		28	31848	25	8966.3	1.7	-7558	9	-30770#	400#	3629.7	0.6	-32000#	400#
Cu		29	34510#	520#	3550	160	-6720	160	*	*	9090	160	-33440#	430#
Zn		30	*	*	-480#	400#	-5100#	640#	*	*	17420#	400#	*	*
56		K	19	3210#	1000#	*		*		32780#	990#	*		18210#
	Ca	20	4880#	400#	*		-15040#	720#	25420#	420#	*		8190#	610#
	Sc	21	7100	650	34430#	840#	-10140	590	21300	610	-32850#	910#	8740	610
	Ti	22	9840	150	28740	130	-7480	120	15960	120	-28260#	320#	1750	150
	V	23	12400	180	26840	330	-8140	190	10760	180	-23280	490	880	180
	Cr	24	14492.9	0.6	24240	80	-8240	7	5322.1	0.5	-20910	160	-5643.9	0.5
	Mn	25	17496.5	1.1	21596	15	-7892.7	0.5	-871.1	0.4	-15060	100	-7501.56	0.22
	Fe	26	20495.22	0.28	18250.3	0.3	-7612.8	0.3	-6699.5	0.3	-12786.3	0.4	-14648.5	0.3
	Co	27	24173.1	0.5	15060.7	1.1	-7758.0	1.9	-17397	15	-5617.0	0.4	-18775.9	0.7
	Ni	28	30772	5	12231.0	0.4	-8002	5	-28520#	400#	-3715.2	0.4	-30340	160
	Cu	29	33380#	400#	5211	15	-6707	17	-35250#	500#	8098	15	-32140#	400#
	Zn	30	35260#	570#	690#	400#	-5490#	570#	*	*	12660#	400#	*	*
	Ga	31	*	*	-3440#	640#	-3530#	780#	*	*	20960#	520#	*	*
57	Ca	20	4670#	500#	*		-16090#	810#	27040#	480#	*		9910#	710#
	Sc	21	6980	1380	36280#	1480#	-11130	1310	23420	1310	-36210#	1530#	10250	1310
	Ti	22	8390	300	30140#	400#	-6950	260	18610	260	-27310#	480#	4170	310
	V	23	11410	120	28830	460	-7930	120	13070	80	-26850	590	2800	80
	Cr	24	13557.6	1.1	25430	160	-8120	100	7657.1	1.1	-20490	120	-3684.5	1.1
	Mn	25	15916.5	1.5	22920	100	-8060	3	1859.3	1.6	-18620	180	-4950.5	1.5
	Fe	26	18843.17	0.23	19650.1	0.4	-7319.8	0.3	-4098.0	0.5	-12185.8	0.5	-12212.8	0.4
	Co	27	21458.3	0.5	16211.1	0.5	-7080.4	0.6	-12036.7	0.6	-9723.0	0.5	-13509.3	0.5
	Ni	28	26890.6	0.8	13180.5	0.5	-7561.2	1.7	-23530#	200#	-2765.7	0.5	-25512	15
	Cu	29	31820	160	7856.9	0.5	-7074.4	1.7	-32300#	400#	1442.5	0.5	-29990#	400#
	Zn	30	34120#	450#	1790#	200#	-5340#	200#	*	*	14070#	200#	-37230#	540#
	Ga	31	*	*	-2050#	430#	-4170#	640#	*	*	16340#	400#	*	*

Table III. Nuclear-reaction and separation energies (continued, Explanation of Table on p. 030003-98)

A	Elt.	Z	S(n)	S(p)	$Q(4\beta^-)$		$Q(d,\alpha)$		$Q(p,\alpha)$		$Q(n,\alpha)$			
58	Ca	20	3120#	640#	*	50070#	500#	870#	940#	2240#	860#	*		
	Sc	21	1950#	1360#	15290#	570#	40950#	400#	9730#	570#	8340#	500#	-9940#	810#
	Ti	22	5270#	330#	17400#	1320#	31050#	200#	4450#	620#	3910#	500#	-7110#	360#
	V	23	4060	120	13780	270	19450	90	9630	150	6130	180	-4600	460
	Cr	24	7538.4	1.8	14870	80	8236.9	1.5	4870	180	2020	100	-4680	160
	Mn	25	6413	3	10591.8	2.9	-4159.8	2.8	10168.2	2.8	4146.2	2.7	-1040	100
	Fe	26	10044.59	0.18	11957.8	1.5	-19860	50	5467.23	0.28	421.36	0.24	-1399.0	0.4
	Co	27	8572.9	1.2	6954.3	1.1	-36310#	300#	11470.7	1.1	2498.2	1.1	3511.7	1.1
	Ni	28	12216.2	0.5	8172.2	0.4	-53150#	500#	6522.5	0.4	-1334.8	0.4	2899.0	0.3
	Cu	29	12430.2	0.6	2872.9	0.7	*	*	12950.6	0.6	-1467.8	0.8	8008.6	0.6
	Zn	30	17820#	210#	2280	50	*	*	7060	50	-5800	160	8680	50
	Ga	31	16600#	500#	-1720#	360#	*	*	12560#	500#	-4110#	500#	13740#	340#
	Ge	32	*	*	-640#	640#	*	*	7020#	710#	*	*	13140#	640#
	59	Sc	21	3500#	570#	15670#	640#	45220#	400#	7280#	570#	8460#	570#	-12580#
Ti		22	2470#	280#	17920#	450#	35160#	200#	6200#	1320#	4210#	620#	-5970#	450#
V		23	5500	180	14010#	260#	24400	160	6790	300	6350	200	-7330	610
Cr		24	4170	220	14970	230	13070	220	7040	230	2930	280	-3120	250
Mn		25	7769	4	10822.5	2.8	833.0	2.4	7710.2	2.6	4623.7	2.4	-3720	180
Fe		26	6581.01	0.11	12126.2	2.7	-13449.3	0.7	7532.3	1.5	1110.79	0.29	266.6	0.6
Co		27	10453.9	1.1	7363.6	0.4	-28470#	170#	8662.9	0.3	3241.4	0.3	328.2	0.4
Ni		28	8999.28	0.05	8598.5	1.1	-45290#	400#	8899.7	0.4	-252.2	0.4	5096.78	0.26
Cu		29	12761.9	0.6	3418.6	0.4	*	*	10436.3	0.6	2413.3	0.5	5328.5	0.6
Zn		30	12990	50	2836.8	0.7	*	*	10804.1	0.8	-3708	15	12338.4	0.8
Ga		31	18290#	350#	-1250#	180#	*	*	9500#	260#	-3510#	430#	10530#	170#
Ge		32	16860#	640#	-380#	500#	*	*	9850#	570#	-7620#	640#	15170#	570#
60		Sc	21	1820#	640#	*	48920#	500#	8580#	710#	7690#	640#	*	
		Ti	22	4890#	360#	19320#	500#	39080#	300#	3260#	500#	3530#	1340#	-9810#
	V	23	3480	270	15020#	300#	28410	220	8580#	300#	5540	340	-6600	1320
	Cr	24	6660	290	16130	250	17800	190	4440	210	2610	210	-7110	320
	Mn	25	5514	3	12170	220	5377.2	2.8	9734.7	2.8	4420.8	2.6	-2910	80
	Fe	26	8820	3	13177	4	-7239	3	5125	4	937	4	-3242	4
	Co	27	7491.92	0.07	8274.5	0.4	-22060#	200#	11215.6	0.4	3395.6	0.3	1482.3	1.6
	Ni	28	11387.73	0.05	9532.38	0.20	-37380#	300#	6084.8	1.1	-263.5	0.4	1355.12	0.26
	Cu	29	10058.1	1.6	4477.4	1.6	-52880#	400#	12594.4	1.6	2602.8	1.7	6646.8	1.6
	Zn	30	15030.1	0.7	5105.0	0.4	*	*	8204.2	0.6	-2001.4	0.6	7555.9	0.6
	Ga	31	13900#	260#	-340#	200#	*	*	13420#	210#	-2180#	280#	13370#	200#
	Ge	32	19290#	500#	620#	350#	*	*	7160#	420#	-7220#	500#	11110#	360#
	As	33	*	*	-3110#	570#	*	*	12320#	640#	*	*	15190#	570#
	61	Sc	21	3090#	780#	*	52670#	600#	*	*	7710#	780#	*	
Ti		22	2090#	500#	19590#	640#	42570#	400#	4660#	570#	3390#	570#	-8780#	640#
V		23	5340	920	15470#	940#	32390	890	5710#	920#	5470#	920#	-9980#	980#
Cr		24	3880	220	16520	240	21750	100	6070	190	2790	140	-5720#	220#
Mn		25	6846	3	12360	190	10241.9	2.5	7050	220	5113.7	2.8	-5690	90
Fe		26	5579	4	13242	3	-2572	16	7316	3	1771	4	-1282	3
Co		27	9319.1	0.8	8774	3	-15760	40	8477.5	0.8	4121.1	0.8	-1424.1	2.8
Ni		28	7820.10	0.05	9860.57	0.22	-30860#	300#	8718.61	0.21	489.3	1.1	3579.6	0.3
Cu		29	11710.2	1.8	4799.9	1.0	-45080#	300#	9883.5	1.0	3108.7	1.0	3509.5	1.5
Zn		30	10246	16	5293	16	*	*	10720	16	183	16	9526	16
Ga		31	15620#	200#	250	40	*	*	10790	40	30	60	10180	40
Ge		32	14340#	420#	1060#	360#	*	*	11110#	350#	-4960#	420#	14590#	300#
As		33	19500#	500#	-2900#	420#	*	*	9680#	500#	-4960#	580#	12290#	420#

Table III. Nuclear-reaction and separation energies (continued, Explanation of Table on p. 030003-98)

A	Elt.	Z	S(2n)		S(2p)		Q(α)		Q($2\beta^-$)		Q(ϵp)		Q(β^-n)	
58	Ca	20	4160#	640#	*	*	*		29190#	540#	*		11010#	1400#
	Sc	21	6170#	710#	37380#	900#	-12300#	720#	25530#	410#	*		10970#	480#
	Ti	22	7930#	230#	31790#	450#	-8370#	210#	20880#	200#	-31530#	450#	5230#	220#
	V	23	10390	200	30130	590	-8940	290	15430	90	-26690	1310	4050	90
	Cr	24	12849.4	1.6	27250	120	-8790	80	10163.3	1.5	-25370	260	-2576.9	2.1
	Mn	25	15058.7	2.7	24250	180	-8359	15	4019.6	2.9	-18700	80	-3717.0	2.7
	Fe	26	17690.66	0.18	21448.1	0.6	-7645.3	0.4	-1926.4	0.3	-16919.4	1.1	-10880.9	0.5
	Co	27	19949.4	1.2	17513.6	1.1	-6714.4	1.5	-8179.4	1.2	-9649.9	1.9	-11834.6	1.2
	Ni	28	22463.8	0.3	14199.60	0.25	-6399.2	0.4	-17930	50	-7335.88	0.25	-20991.2	0.4
	Cu	29	29167	15	10205.3	0.6	-6082.7	0.6	-28130#	300#	388.9	0.6	-27190#	200#
	Zn	30	33050#	400#	2970	50	-5450	50	-35220#	500#	6500	50	-35360#	400#
	Ga	31	36290#	580#	-530#	300#	-4550#	500#	*		16480#	300#	*	
	Ge	32	*		-3730#	640#	-3230#	640#	*		18180#	540#	*	
59	Sc	21	5450#	1360#	*		-13440#	810#	27530#	430#	*		12740#	450#
	Ti	22	7740#	330#	33210#	450#	-9580#	360#	22580#	300#	-30880#	540#	6820#	220#
	V	23	9560	180	31410	1310	-10100	480	17690	160	-30250#	430#	6090	160
	Cr	24	11700	220	28750	340	-8840	270	12580	220	-24270#	300#	-330	220
	Mn	25	14181.7	2.8	25690	80	-8810	100	6704.4	2.4	-22410	90	-1441.5	2.4
	Fe	26	16625.60	0.21	22718.0	1.1	-7980.0	0.4	491.9	0.3	-15962.0	1.5	-8889.0	1.1
	Co	27	19026.8	0.4	19321.4	1.6	-6942.2	0.3	-5871.4	0.4	-13691.1	2.7	-10072.28	0.20
	Ni	28	21215.5	0.5	15552.81	0.26	-6100.3	0.3	-13941.2	0.7	-6290.6	0.3	-17560.3	0.4
	Cu	29	25192.1	0.6	11590.7	0.6	-4753.4	0.5	-22600#	170#	-3800.1	1.2	-22130	50
	Zn	30	30810#	200#	5709.7	0.8	-4304.6	1.0	-31350#	400#	5724.2	0.7	-31750#	300#
	Ga	31	34890#	430#	1030#	170#	-4550#	230#	*		10620#	170#	-34750#	530#
	Ge	32	*		-2100#	450#	-3720#	570#	*		19140#	400#	*	
60	Sc	21	5320#	640#	*		-14400#	940#	29190#	550#	*		13390#	540#
	Ti	22	7360#	360#	34990#	580#	-10860#	500#	24340#	360#	*		7430#	340#
	V	23	8980	240	32940#	460#	-10810	630	19730	220	-30230#	460#	6770	310
	Cr	24	10820	190	30140#	280#	-9770	230	14740	190	-28450#	280#	780	190
	Mn	25	13283	4	27140	90	-9240	180	8682.4	2.4	-22420	160	-374.4	2.4
	Fe	26	15401	3	23999	4	-8553	3	3060	3	-20620	220	-7255	3
	Co	27	17945.8	1.1	20400.7	2.7	-7163.7	0.4	-3305.2	1.6	-13414.0	2.4	-8564.92	0.21
	Ni	28	20387.01	0.07	16895.9	0.3	-6290.95	0.26	-10298.8	0.4	-11097.3	0.3	-16186.1	0.4
	Cu	29	22820.0	1.6	13075.9	1.9	-4729.6	1.6	-18760#	200#	-3404.4	1.6	-19200.9	1.7
	Zn	30	28020	50	8523.5	0.4	-2691.7	0.5	-27090#	300#	-306.6	0.4	-28490#	170#
	Ga	31	32190#	360#	2500#	200#	-3370#	200#	-34120#	450#	9480#	200#	-31790#	450#
	Ge	32	36150#	580#	-630#	300#	-4130#	500#	*		12840#	300#	*	
	As	33	*		-3490#	500#	-4510#	640#	*		21000#	430#	*	
61	Sc	21	4910#	720#	*		*		31440#	1080#	*		15190#	670#
	Ti	22	6980#	450#	*		-11900#	570#	26130#	410#	*		8820#	460#
	V	23	8820	910	34780#	980#	-11940	1580	21240	890	-33740#	1030#	8090	910
	Cr	24	10530	240	31540#	220#	-10980	280	16450	100	-27430#	320#	2420	100
	Mn	25	12359	3	28490	160	-9750	80	11155.9	2.5	-25790	220	1600	4
	Fe	26	14398.3	2.6	25410	220	-8820.7	2.8	5301.4	2.6	-19540	190	-5341.5	2.6
	Co	27	16811.0	0.8	21950.7	2.5	-7836.7	1.7	-914.0	1.2	-17219.1	2.5	-6496.3	0.8
	Ni	28	19207.83	0.07	18135.0	0.3	-6464.98	0.26	-7873	16	-10098	3	-13948.1	1.6
	Cu	29	21768.4	1.0	14332.3	1.0	-5063.4	1.0	-14850	40	-7622.7	1.0	-15881.0	1.1
	Zn	30	25276	16	9770	16	-2690	16	-22990#	300#	835	16	-24830#	200#
	Ga	31	29520#	180#	5350	40	-2250	40	-30240#	300#	3920	40	-28120#	300#
	Ge	32	33630#	500#	720#	300#	-3230#	360#	*		13530#	300#	-35960#	500#
	As	33	*		-2280#	350#	-4320#	500#	*		15400#	360#	*	

Table III. Nuclear-reaction and separation energies (continued, Explanation of Table on p. 030003-98)

A	Elt.	Z	S(n)		S(p)		$Q(4\beta^-)$		$Q(d,\alpha)$		$Q(p,\alpha)$		$Q(n,\alpha)$	
62	Ti	22	4220#	570#	20720#	720#	46380#	400#	2260#	640#	2670#	570#	*	
	V	23	3040#	940#	16420#	500#	35950#	300#	7560#	420#	4900#	360#	-9530#	500#
	Cr	24	6490	180	17680	910	25850	150	3060	270	1800	220	-9740#	250#
	Mn	25	4853	7	13340	100	14263	7	8860	190	4430	220	-5050	160
	Fe	26	8029	4	14425	4	2289.9	2.9	4801	4	1511	4	-5150	220
	Co	27	6598	19	9793	19	-9437	19	10700	19	4105	19	-253	19
	Ni	28	10595.7	0.3	11137.2	0.7	-25010#	140#	5614.8	0.4	347.4	0.4	-435.1	0.4
	Cu	29	8874.7	1.1	5854.5	0.6	-38470#	300#	12396.5	0.6	3233.3	0.6	5088.7	0.6
	Zn	30	12890	16	6472.9	1.1	*		7888.0	1.7	54.4	0.7	5635.1	0.5
	Ga	31	12920	40	2927	16	*		12898.2	0.7	92.7	0.9	10017.8	0.7
	Ge	32	16450#	330#	1900#	150#	*		8560#	240#	-3120#	220#	11120#	140#
	As	33	15490#	420#	-1750#	420#	*		13480#	420#	-3590#	500#	15090#	350#
	63	Ti	22	1320#	640#	*		49890#	500#	4030#	780#	3170#	710#	*
V		23	4490#	500#	16680#	570#	39960#	400#	5170#	570#	5300#	500#	-12190#	640#
Cr		24	3180	390	17820#	470#	29510	360	5210	960	2100	420	-8030#	470#
Mn		25	6434	8	13280	150	18693	4	6300	100	4650	190	-8000	220
Fe		26	4829	5	14401	8	6578	5	6817	5	2196	5	-3320	190
Co		27	8498	26	10262	19	-5304	19	7780	19	4426	19	-3237	19
Ni		28	6837.77	0.06	11377	19	-18590	40	8096.1	0.7	1001.6	0.4	1547	3
Cu		29	10863.6	0.5	6122.40	0.06	-32080#	200#	9353.0	0.3	3757.4	0.3	1717.0	0.4
Zn		30	9116.7	1.6	6714.9	1.6	*		10481.5	1.6	995.8	2.2	7906.1	1.6
Ga		31	12631.5	1.5	2668.1	1.4	*		10513	16	2491.3	1.4	7444.4	2.1
Ge		32	13250#	150#	2220	40	*		10920	50	-2470#	200#	12900	40
As		33	17250#	360#	-950#	240#	*		10570#	360#	-1550#	360#	11740#	280#
64		Ti	22	3350#	780#	*		53950#	600#	*		2910#	850#	*
	V	23	2500#	570#	17860#	640#	43470#	400#	6890#	570#	4890#	570#	-11610#	720#
	Cr	24	5540	570	18880#	590#	33620	440	2710#	530#	1890	1000	-11480#	590#
	Mn	25	4173	5	14270	360	22436	4	8620	150	4350	100	-6840	890
	Fe	26	7405	7	15371	6	11034	5	4265	8	1637	6	-6850	100
	Co	27	6012	27	11446	20	-960	20	9797	20	3992	20	-2404	20
	Ni	28	9657.46	0.20	12536	19	-12783	4	5036	19	663.2	0.7	-2532.0	2.7
	Cu	29	7916.11	0.10	7200.74	0.10	-25890#	200#	12032.58	0.11	3661.4	0.3	3119.9	0.7
	Zn	30	11861.9	1.5	7713.2	0.6	-39300#	500#	7494.2	0.8	844.1	0.7	3864.3	0.7
	Ga	31	10357.0	1.9	3908.4	2.1	*		13046.0	1.5	2380	16	8797.6	1.6
	Ge	32	15470	40	5057	4	*		8382	4	-2320	40	7680	16
	As	33	14100#	290#	-100#	200#	*		12920#	250#	-1310#	360#	13250#	210#
	Se	34	*		490#	540#	*		8330#	590#	-4940#	590#	12310#	590#
65	V	23	3530#	640#	18040#	780#	47410#	500#	4680#	710#	5580#	640#	*	
	Cr	24	2810#	530#	19190#	500#	36910#	300#	4380#	500#	2120#	420#	-10070#	500#
	Mn	25	6050	5	14780	440	26296	4	5750	360	4790	150	-9850#	300#
	Fe	26	4320	7	15518	6	14694	5	6380	6	2170	8	-4680	150
	Co	27	7464	20	11505	5	3472.3	2.2	7161	5	4557	3	-5015	7
	Ni	28	6098.08	0.14	12622	20	-8647.5	2.2	7437	19	1163	19	-601.2	2.8
	Cu	29	9910.4	0.7	7453.7	0.7	-20330	80	8959.9	0.7	4346.7	0.7	-193	19
	Zn	30	7979.32	0.17	7776.4	0.7	-32890#	300#	10378.5	0.7	1739.5	0.8	6480.7	0.7
	Ga	31	11896.0	1.6	3942.5	0.6	*		10266.7	1.6	3374.5	0.9	5776.3	1.0
	Ge	32	10234	4	4934.4	2.6	*		10779.7	2.5	372.7	2.3	10336.2	2.3
	As	33	15480#	220#	-90	80	*		10690	90	-330#	160#	10700	80
	Se	34	14390#	590#	780#	360#	*		11190#	360#	-3840#	420#	14370#	330#

Table III. Nuclear-reaction and separation energies (continued, Explanation of Table on p. 030003-98)

A	Elt.	Z	S(2n)		S(2p)		Q(α)		Q(2 β^-)		Q(ϵ_p)		Q(β^-n)		
62	Ti	22	6310#	500#	*		-13010#	640#	28400#	430#	*		9940#	980#	
	V	23	8380#	370#	36000#	580#	-13030#	500#	23050#	300#	-33700#	670#	8930#	320#	
	Cr	24	10370	240	33140#	340#	-12210#	250#	17980	150	-31830#	430#	2780	150	
	Mn	25	11699	7	29860	220	-10550	90	12900	20	-25310	890	2325	7	
	Fe	26	13608	4	26790	190	-9311	3	7868.3	2.8	-23690	100	-4051.3	2.9	
	Co	27	15917	19	23034	19	-8022	19	1363	19	-16971	19	-5274	19	
	Ni	28	18415.8	0.3	19911	3	-7016.1	0.4	-5578.4	0.4	-15114.8	2.6	-12833.6	1.0	
	Cu	29	20584.9	1.7	15715.1	0.6	-5365.2	1.2	-10800.5	0.7	-7178.3	0.9	-14510	16	
	Zn	30	23136.3	0.7	11272.8	0.5	-3364.1	0.5	-19430#	140#	-4235.0	0.5	-22100	40	
	Ga	31	28540#	200#	8219.7	1.7	-2744.1	0.7	-27670#	300#	2708.2	1.1	-26700#	300#	
	Ge	32	30790#	330#	2140#	140#	-1870#	150#	*		7320#	140#	-32910#	330#	
	As	33	34990#	500#	-690#	360#	-3210#	420#	*		15530#	300#	*		
	63	Ti	22	5540#	640#	*		*		30260#	620#	*		11660#	580#
		V	23	7530#	980#	37400#	720#	-14010#	570#	25000#	400#	*		10930#	430#
Cr		24	9670	370	34240#	540#	-12920#	410#	19630	360	-30800#	540#	4450	360	
Mn		25	11288	4	30960	890	-11480	160	14964	19	-28700#	300#	3920	5	
Fe		26	12858	5	27740	100	-9970	220	9877	4	-22030	150	-2283	19	
Co		27	15096	19	24687	19	-8751	19	3728	19	-20616	20	-3176	19	
Ni		28	17433.5	0.3	21170.2	2.6	-7272.9	0.4	-3299.4	1.5	-13923.7	2.8	-10796.7	0.5	
Cu		29	19738.3	1.0	17259.6	0.7	-5775.0	0.4	-9032.7	1.4	-11444	19	-12483.1	0.4	
Zn		30	22007	16	12569.4	1.6	-3481.6	1.6	-15290	40	-2756.0	1.5	-18297.8	1.6	
Ga		31	25560	40	9141.0	1.6	-2613.7	1.4	-23050#	200#	-1048.6	1.5	-22880#	140#	
Ge		32	29700#	300#	5150	40	-2130	40	*		6960	40	-30670#	300#	
As		33	32740#	360#	940#	200#	-2170#	260#	*		11200#	200#	*		
64		Ti	22	4670#	720#	*		*		32460#	740#	*		12790#	720#
		V	23	6990#	500#	*		-14690#	640#	26670#	400#	*		11620#	540#
	Cr	24	8730	460	35560#	590#	-13580#	530#	21490	440	-35020#	670#	5340	440	
	Mn	25	10608	7	32090#	300#	-12170	220	16803	20	-28390#	400#	4575	6	
	Fe	26	12234	6	28650	150	-10720	190	12129	5	-26250	360	-1189	19	
	Co	27	14511	27	25846	21	-9249	20	5632	20	-20194	20	-2351	20	
	Ni	28	16495.23	0.21	22798.8	2.8	-8111	3	-1094.9	0.7	-18752	4	-9590.49	0.20	
	Cu	29	18779.8	0.5	18578	19	-6199.2	0.4	-6591.7	1.5	-10862	19	-11282.5	1.5	
	Zn	30	20978.7	0.8	13835.6	0.6	-3955.8	0.7	-11689	4	-7780.2	0.6	-17528.2	1.5	
	Ga	31	22988.5	1.5	10623.3	1.5	-2912.6	2.1	-19300#	200#	-542.0	1.5	-19980	40	
	Ge	32	28720#	140#	7725	4	-2566	4	-27620#	500#	609	4	-28890#	200#	
	As	33	31360#	360#	2120#	200#	-2370#	290#	*		9730#	200#	*		
	Se	34	*		-460#	520#	-2040#	590#	*		12930#	500#	*		
	65	V	23	6030#	640#	*		-15140#	780#	29190#	500#	*		13630#	670#
Cr		24	8360#	470#	37050#	580#	-14300#	500#	23000#	300#	-34480#	670#	6700#	300#	
Mn		25	10223	5	33660#	400#	-12890	890	18218	4	-31940#	400#	5931	6	
Fe		26	11725	7	29790	360	-11170	100	13908	5	-25030	440	503	21	
Co		27	13476	19	26876	4	-9868	3	8078.5	2.2	-23485	4	-157.6	2.1	
Ni		28	15755.54	0.25	24068	4	-8630.1	2.7	786.3	0.7	-17445	5	-7772.46	0.26	
Cu		29	17826.5	0.7	19990	19	-6790.5	1.0	-4606.2	0.7	-14760	20	-9331.0	0.4	
Zn		30	19841.3	1.5	14977.2	0.7	-4115.0	0.7	-9433.8	2.3	-6102.1	0.7	-15150.5	1.5	
Ga		31	22253.0	1.5	11655.7	0.8	-3098.4	1.0	-15720	80	-4521.9	0.8	-16413	4	
Ge		32	25700	40	8842.8	2.7	-2554	16	-23460#	300#	2236.8	2.3	-25020#	200#	
As		33	29580#	220#	4970	80	-2230	90	*		4610	80	-28310#	510#	
Se		34	*		680#	300#	-2090#	420#	*		14010#	300#	*		

Table III. Nuclear-reaction and separation energies (continued, Explanation of Table on p. 030003-98)

A	Elt.	Z	S(n)		S(p)		$Q(4\beta^-)$		$Q(d,\alpha)$		$Q(p,\alpha)$		$Q(n,\alpha)$	
66	V	23	1900#	710#	*		50800#	500#	6130#	780#	5000#	710#	*	
	Cr	24	4570#	500#	20230#	640#	41290#	400#	2310#	570#	2030#	570#	-13320#	640#
	Mn	25	3854	12	15820#	300#	29508	11	7440	440	4120	360	-9210#	400#
	Fe	26	6921	7	16389	6	18831	4	3632	5	1683	6	-8410	360
	Co	27	5295	14	12480	15	7315	14	9272	15	4091	15	-3875	14
	Ni	28	8951.9	1.5	14110.1	2.5	-4399.3	2.8	4497	20	709	19	-4724	5
	Cu	29	7065.93	0.09	8421.6	0.7	-14233	6	11551.5	0.7	4118.6	0.7	1240	19
	Zn	30	11058.5	0.9	8924.5	0.9	-27240#	200#	7236.2	0.7	1544.6	0.7	2260.0	0.7
	Ga	31	9137.5	1.3	5100.6	1.2	*	*	12991.2	1.2	3353.8	1.9	7502.5	1.1
	Ge	32	13200	3	6238.5	2.5	*	*	7936.6	2.8	-195.9	2.7	6252.8	2.9
	As	33	13160	80	2836	6	*	*	13001	7	-240	40	10168	6
	Se	34	16710#	360#	2010#	220#	*	*	8580#	290#	-3300#	280#	10910#	200#
	67	V	23	3110#	780#	*		54670#	600#	*	*	5240#	850#	*
Cr		24	2030#	570#	20360#	640#	45060#	400#	3810#	640#	2500#	570#	-12010#	720#
Mn		25	4780#	300#	16030#	500#	33860#	300#	5470#	420#	4880#	530#	-11490#	500#
Fe		26	3610	270	16150	270	22270	270	6070	270	2240	270	-6480	520
Co		27	6985	15	12543	8	11557	7	6607	8	4512	8	-6686	7
Ni		28	5808	3	14623	14	-1084	5	6153	4	914	20	-3127	6
Cu		29	9132.6	1.1	8602.2	1.7	-10732.3	1.0	8517.0	0.9	4643.5	0.9	-1881	20
Zn		30	7052.47	0.23	8911.0	0.9	-21300	70	10094.2	0.9	2408.3	0.7	4865.0	0.7
Ga		31	11226.7	1.4	5268.9	1.1	-34090#	400#	9743.8	1.3	3989.0	1.3	4191.9	1.2
Ge		32	9123	5	6224	5	*	*	10710	5	1039	5	8992	5
As		33	12633	6	2269.2	2.4	*	*	10601.8	2.2	2592	4	7892.0	1.5
Se		34	12990#	210#	1840	70	*	*	11070	110	-2180#	210#	13380	70
Br		35	*	*	-1580#	450#	*	*	10940#	500#	-1230#	640#	12390#	450#
68	Cr	24	4190#	640#	21440#	780#	48660#	500#	1520#	710#	1840#	710#	*	
	Mn	25	2990#	500#	16990#	570#	37190#	400#	7050#	570#	4700#	500#	-10950#	640#
	Fe	26	5950	450	17320#	470#	26520	370	3970	370	2340	370	-9620#	470#
	Co	27	4680	190	13610	330	15160	190	8850	190	4150	190	-5320	190
	Ni	28	7792	4	15431	7	3515	4	3656	14	585	4	-6600	6
	Cu	29	6318.8	1.8	9113	3	-6672.5	2.4	11150.1	2.1	4422.7	1.7	-735.4	2.6
	Zn	30	10198.10	0.19	9976.6	0.9	-15817.7	0.9	6962.0	1.0	2120.6	1.0	765.0	0.8
	Ga	31	8278.3	1.7	6494.6	1.2	-28300#	260#	12524.0	1.2	3690.1	1.5	5824.1	1.5
	Ge	32	12392	5	7388.7	2.2	*	*	7455.7	2.2	542.8	2.0	4579.6	2.0
	As	33	10378.6	1.9	3525	5	*	*	13423	3	2447.8	2.8	9409.4	2.0
	Se	34	15680	70	4891.2	0.7	*	*	8546	6	-2390	80	7935.2	2.2
	Br	35	14070#	480#	-500#	250#	*	*	13580#	330#	-910#	400#	13790#	270#
	69	Cr	24	1850#	710#	*		51400#	500#	2780#	780#	1890#	710#	*
Mn		25	4460#	570#	17260#	640#	40970#	400#	4620#	570#	4810#	570#	-13510#	640#
Fe		26	3610#	540#	17940#	570#	29390#	400#	5140#	500#	2590#	400#	-8660#	570#
Co		27	6420	240	14080	390	19050	140	6040	300	4650	140	-7880	140
Ni		28	4586	5	15340	190	7122	4	6054	7	1294	14	-4264	6
Cu		29	8240.5	2.1	9561	3	-2620	30	8717	3	5134.1	2.0	-3681	14
Zn		30	6482.07	0.16	10139.8	1.8	-11983.1	1.7	9612.5	0.9	2704.5	1.0	3234.8	1.6
Ga		31	10313.1	1.9	6609.7	1.4	-23070	40	9263.3	1.4	4435.4	1.4	2576.9	1.4
Ge		32	8193.2	2.3	7303.6	1.9	-34670#	400#	10489.2	1.8	1487.1	1.7	7444.9	1.5
As		33	12290	30	3420	30	*	*	10260	30	3360	30	6260	30
Se		34	10316.6	1.6	4829.2	2.4	*	*	10863.3	1.6	454	6	10818.7	2.8
Br		35	15540#	260#	-640	40	*	*	11030	80	270#	210#	11410	40
Kr		36	*	*	930#	480#	*	*	11070#	570#	*	*	14870#	450#

Table III. Nuclear-reaction and separation energies (continued, Explanation of Table on p. 030003-98)

A	Elt.	Z	S(2n)		S(2p)		Q(α)		Q(2 β^-)		Q(ϵ p)		Q(β^- n)	
66	V	23	5430#	640#	*	*	*	31140#	500#	*		14540#	580#	
	Cr	24	7380#	590#	38270#	720#	-14650#	570#	25350#	400#	*	8180#	400#	
	Mn	25	9904	12	35010#	400#	-13700#	300#	19658	18	-32260#	500#	6396	12
	Fe	26	11241	6	31170	440	-11600	150	15938	4	-29140#	300#	1046	5
	Co	27	12759	24	27997	14	-10309	15	9850	14	-22730	14	646	14
	Ni	28	15050.0	1.5	25615	5	-9553	3	2892.9	1.6	-22077	5	-6813.9	1.5
	Cu	29	16976.4	0.7	21044	20	-7259	19	-2534.6	1.2	-14362.0	2.2	-8417.6	0.4
	Zn	30	19037.8	0.9	16378.2	0.7	-4577.8	0.7	-7292.1	2.5	-11062.4	0.7	-14313.0	1.1
	Ga	31	21033.5	1.8	12877.1	1.1	-3361.1	1.2	-11699	6	-3749.0	1.2	-15316.8	2.4
	Ge	32	23434	4	10181.0	2.5	-2864.0	2.5	-19950#	200#	-2984.0	2.5	-22740	80
As	33	28640#	200#	7770	6	-2463	6	*	*	3343	6	-27080#	300#	
Se	34	31100#	540#	1920#	200#	-2350#	240#	*	*	7530#	200#	*	*	
67	V	23	5010#	780#	*	*	*	32810#	670#	*		16000#	720#	
	Cr	24	6600#	500#	*		-15360#	640#	26930#	480#	*	10000#	400#	
	Mn	25	8640#	300#	36260#	580#	-14000#	500#	21860#	300#	-35140#	580#	8540#	300#
	Fe	26	10530	270	31970#	400#	-12030	450	18130	270	-28180#	480#	2730	270
	Co	27	12279	7	28932	7	-10860	7	11998	7	-25860	13	2613	7
	Ni	28	14759.6	2.9	27103	6	-10532	5	4137.6	3.0	-20964	5	-5555.7	3.0
	Cu	29	16198.5	1.1	22712.3	2.3	-7893	19	-440.5	1.3	-18200	14	-6491.7	0.8
	Zn	30	18110.9	0.9	17332.6	0.7	-4792.5	0.7	-5222	5	-9163.0	1.6	-12228.0	0.8
	Ga	31	20364.2	1.4	14193.3	1.3	-3724.2	1.2	-10291.8	1.3	-7909.7	1.3	-13343.3	2.7
	Ge	32	22323	5	11324	5	-2870	5	-16080	70	-1048	5	-18704	7
	As	33	25790	80	8507.7	0.9	-2465.0	1.4	-23800#	400#	-152.5	1.2	-23000#	200#
Se	34	29700#	310#	4680	70	-2080	80	*	*	7740	70	*	*	
Br	35	*		430#	410#	-1720#	450#	*	*	11950#	400#	*	*	
68	Cr	24	6220#	640#	*		-16200#	780#	28690#	620#	*	10590#	580#	
	Mn	25	7770#	400#	37350#	640#	-14490#	570#	23550#	440#	-35020#	720#	9160#	480#
	Fe	26	9560	370	33350#	540#	-12430	570	19980	370	-32100#	540#	3760	370
	Co	27	11660	190	29760	190	-11370	190	13640	190	-25760#	360#	3740	190
	Ni	28	13600	3	27974	5	-10919	6	6543	3	-25140	270	-4216	3
	Cu	29	15451.4	1.7	23736	14	-8200	20	1519.0	2.1	-17534	7	-5758.0	1.8
	Zn	30	17250.6	0.3	18578.7	1.6	-5333.1	0.8	-3028.3	2.0	-13553.4	3.0	-11199.4	1.1
	Ga	31	19505.0	1.5	15405.7	1.5	-4086.4	1.4	-8191.5	2.3	-7055.5	1.5	-12499	5
	Ge	32	21514	3	12657.6	2.0	-3399.7	2.0	-12789.3	1.9	-6387.4	2.0	-18462.9	1.9
	As	33	23012	6	9748.8	2.1	-2486.6	2.3	-20100#	260#	695.6	2.2	-20390	70
	Se	34	28670#	200#	7160.3	2.5	-2299	4	*	*	1180	5	-29470#	400#
Br	35	*		1340#	260#	-1680#	330#	*	*	10510#	260#	*	*	
69	Cr	24	6040#	640#	*		*	30450#	640#	*		11730#	640#	
	Mn	25	7450#	500#	38700#	720#	-15420#	640#	25510#	420#	*	10650#	540#	
	Fe	26	9560#	480#	34930#	570#	-13240#	500#	20950#	400#	-31520#	640#	4830#	440#
	Co	27	11100	140	31400#	330#	-11740	140	15460	140	-29190#	420#	5110	140
	Ni	28	12379	5	28950	270	-11186	6	8439	4	-23780	370	-2483	4
	Cu	29	14559.3	1.7	24992	7	-8975.9	2.5	3591.6	1.8	-21090	190	-3800.4	1.6
	Zn	30	16680.17	0.25	19253.1	3.0	-5717.1	0.8	-1317.2	1.5	-12243	3	-9403.2	1.2
	Ga	31	18591.4	1.7	16586.2	1.5	-4489.1	1.4	-6220	30	-11049.7	2.0	-10420.3	2.2
	Ge	32	20585	5	13798.3	1.5	-3613.6	1.5	-10666.0	2.0	-4382.5	1.5	-16277.5	2.3
	As	33	22670	30	10810	30	-2880	30	-16850	50	-3320	30	-16990	30
	Se	34	26000	70	8354	5	-2381.4	2.6	-24000#	400#	3255.1	2.4	-25720#	260#
Br	35	29610#	400#	4250	40	-1750	90	*	*	5350	40	*	*	
Kr	36	*		430#	410#	-1840#	500#	*	*	14470#	400#	*	*	

Table III. Nuclear-reaction and separation energies (continued, Explanation of Table on p. 030003-98)

A	Elt.	Z	S(n)		S(p)		$Q(4\beta^-)$		$Q(d,\alpha)$		$Q(p,\alpha)$		$Q(n,\alpha)$	
70	Cr	24	3970#	780#	*		54730#	600#	*	1040#	850#	*		
	Mn	25	2800#	640#	18210#	710#	43480#	500#	6010#	710#	4040#	640#	-13200#	780#
	Fe	26	5550#	570#	19030#	570#	33060#	400#	2580#	570#	1810#	500#	-12180#	570#
	Co	27	4420#	330#	14890#	500#	22280#	300#	7570#	470#	3850#	400#	-7520#	420#
	Ni	28	7307	4	16220	140	11348.0	2.3	3430	190	972	7	-7960	270
	Cu	29	5311.5	1.8	10287	4	1370	50	11198	3	5630	3	-2008	7
	Zn	30	9218.2	2.1	11117.5	2.4	-7634.8	2.5	6713.1	2.5	2618.8	2.1	-176	3
	Ga	31	7653.65	0.17	7781.3	1.4	-17485	15	11807.8	1.4	3834.2	1.4	4055.8	1.5
	Ge	32	11532.5	1.6	8523.0	1.5	-29460#	200#	7234.9	1.6	1181.2	1.2	2964.8	1.0
	As	33	9300	60	4530	50	*		13350	50	3180	50	8180	50
	Se	34	13566.5	2.2	6110	30	*		7675.4	2.4	-478.6	1.6	6375	5
	Br	35	13240	40	2280	15	*		13475	15	20	70	10808	15
Kr	36	16740#	450#	2130#	210#	*		8400#	330#	-3450#	450#	11130#	210#	
71	Mn	25	4140#	710#	18380#	780#	47140#	500#	3720#	710#	4090#	710#	*	
	Fe	26	2990#	570#	19220#	640#	35900#	400#	4050#	570#	1810#	570#	-10980#	640#
	Co	27	5810#	550#	15150#	610#	25770	470	5370#	610#	3980	590	-10340#	610#
	Ni	28	4264	3	16070#	300#	14500.3	2.4	5580	140	1390	190	-6270	370
	Cu	29	7806.1	1.8	10786.2	2.6	5182	4	7978	4	5617	3	-5130	190
	Zn	30	5835	3	11641.4	2.9	-4182	4	9118.2	3.0	3102	3	1781	4
	Ga	31	9300.3	1.4	7863.4	2.1	-13637	5	8989.5	1.1	4732.0	1.0	1074.3	1.8
	Ge	32	7415.94	0.11	8285.3	1.5	-23580	130	10132.1	1.5	2043.6	1.6	5747.0	1.1
	As	33	11620	50	4620	4	-35830#	400#	9918	4	3950	5	4839	4
	Se	34	9288	3	6090	50	*		10680	30	612	3	9479	3
	Br	35	13148	16	1861	6	*		10643	6	2551	5	8039	6
	Kr	36	13300#	240#	2190	130	*		10640	140	-2670#	290#	13510	130
Rb	37	*		-1750#	450#	*		11090#	570#	*		12380#	480#	
72	Mn	25	2400#	780#	*		49880#	600#	5290#	850#	3540#	780#	*	
	Fe	26	5070#	640#	20150#	710#	39720#	500#	1780#	710#	1200#	640#	-14200#	710#
	Co	27	3900#	610#	16060#	570#	28390#	400#	7020#	570#	3690#	570#	-9780#	570#
	Ni	28	6891	3	17150	470	18359.8	2.2	3110#	300#	920	140	-9550#	400#
	Cu	29	5143.2	2.0	11665.7	2.6	8447	4	10141.7	2.6	5060	4	-3860	140
	Zn	30	8888	3	12723.3	2.6	-277.3	2.9	5541.7	2.4	2454.8	2.6	-2520	4
	Ga	31	6520.47	0.19	8548.5	2.8	-9526.6	1.3	11687.2	2.1	4693.6	1.1	2794.3	1.6
	Ge	32	10750.7	0.8	9735.7	0.8	-18645	8	7035.0	1.2	1606.0	1.2	1478.3	0.8
	As	33	8408	6	5612	4	-29900#	500#	13043	4	3735	4	6744	4
	Se	34	12793	3	7264	5	*		7180	50	110	30	4878.9	2.4
	Br	35	10631	5	3204.2	3.0	*		13579.0	1.9	2237.0	1.8	9700	30
	Kr	36	15680	130	4727	10	*		8196	17	-2820	40	8141	8
Rb	37	14340#	640#	-710#	520#	*		13480#	540#	-1030#	640#	13580#	500#	
73	Fe	26	2540#	710#	20290#	780#	42690#	500#	3380#	710#	1460#	710#	-12770#	780#
	Co	27	5290#	570#	16280#	640#	32280#	400#	4720#	570#	3960#	570#	-12270#	640#
	Ni	28	3953	3	17200#	400#	21189.4	2.4	4970	470	1390#	300#	-7950#	400#
	Cu	29	7275.8	2.4	12050.3	3.0	11965	4	7129.6	3.0	5090.5	2.9	-6710#	300#
	Zn	30	5519.2	2.8	13099.4	2.3	2634	8	7828.5	2.4	2247.0	2.2	-733.1	2.8
	Ga	31	9182.4	1.9	8842.8	2.7	-6052	7	8340	3	4729.5	2.5	-1076.6	2.0
	Ge	32	6782.94	0.05	9998.2	0.8	-14746	7	9552.4	0.8	2476.7	1.2	3913.6	1.9
	As	33	10794	6	5656	4	-24870#	200#	9665	4	4473	4	3604	4
	Se	34	8431	8	7287	8	-36280#	400#	10377	9	980	50	7981	7
	Br	35	12657	7	3068	8	*		10210	8	3146	7	6340	50
	Kr	36	10682	10	4779	7	*		10661	9	-262	16	11025	7
	Rb	37	15820#	540#	-570#	200#	*		10960#	240#	-120#	280#	10990#	200#
Sr	38	*		910#	640#	*		10820#	570#	*		14800#	450#	

Table III. Nuclear-reaction and separation energies (continued, Explanation of Table on p. 030003-98)

A	Elt.	Z	S(2n)		S(2p)		Q(α)		Q($2\beta^-$)		Q(ϵp)		Q($\beta^- n$)	
70	Cr	24	5820#	780#	*	*	*	32030#	720#	*	*	12220#	720#	
	Mn	25	7260#	640#	*	*	-16310#	710#	27130#	580#	*	11460#	640#	
	Fe	26	9170#	540#	36290#	640#	-14220#	570#	22700#	400#	-35220#	640#	5700#	420#
	Co	27	10840#	360#	32830#	500#	-12300#	300#	16350#	300#	-29150#	500#	5280#	300#
	Ni	28	11893	4	30300	370	-11571	5	10350.9	2.9	-27470#	400#	-1549.0	2.6
	Cu	29	13552.0	1.9	25620	190	-8993	14	5933.8	1.6	-19990	140	-2629.8	1.3
	Zn	30	15700.3	2.0	20679	4	-5983.4	2.4	997.1	2.1	-16875	4	-8308.2	1.6
	Ga	31	17966.8	1.9	17921.0	2.0	-5076.8	1.4	-4570	50	-10462.9	1.8	-9880.8	0.6
	Ge	32	19725.7	2.1	15132.7	1.1	-4087.6	1.0	-8632.0	1.8	-9433.0	1.1	-15520	30
	As	33	21590	50	11830	50	-3040	50	-12920	50	-2300	50	-15980	50
	Se	34	23883.1	1.7	9529.0	2.5	-2747.8	2.9	-20830#	200#	-2118.2	2.1	-23740	40
	Br	35	28780#	260#	7109	15	-1825	16	*	*	4400	40	-27060#	400#
	Kr	36	*	*	1490#	200#	-1870#	280#	*	*	8050#	200#	*	*
71	Mn	25	6940#	640#	*	*	-17350#	780#	28800#	680#	*	*	12870#	640#
	Fe	26	8540#	570#	37430#	640#	-15170#	570#	23980#	400#	-34240#	720#	7130#	500#
	Co	27	10230	490	34180#	610#	-13340#	550#	18340	470	-32160#	680#	6770	470
	Ni	28	11570	4	30960#	400#	-12220	270	11923	3	-26190#	400#	-501.2	2.5
	Cu	29	13117.5	2.0	27010	140	-9814	7	7428.0	1.7	-23370#	300#	-1217.7	2.4
	Zn	30	15053.6	2.8	21928	5	-6011	4	2577.7	2.8	-15404	3	-6490.0	2.9
	Ga	31	16954.0	1.4	18980.9	1.6	-5244.5	1.2	-2246	4	-14451.7	1.4	-7648.58	0.25
	Ge	32	18948.5	1.6	16066.6	1.1	-4451.1	1.0	-6760.0	2.9	-7630.7	2.1	-13640	50
	As	33	20920	30	13143	4	-3439	4	-11391	7	-6272	4	-14035	4
	Se	34	22854	3	10624	3	-2913	5	-16820	130	126.4	2.9	-19792	15
	Br	35	26390	40	7970	30	-2340	5	-24440#	400#	550	50	-23470#	200#
	Kr	36	30040#	420#	4470	130	-2170	150	*	*	8310	130	*	*
	Rb	37	*	*	380#	400#	-1700#	570#	*	*	12080#	400#	*	*
72	Mn	25	6540#	780#	*	*	*	30300#	720#	*	*	13460#	720#	
	Fe	26	8060#	640#	38530#	780#	-16060#	710#	25800#	500#	*	*	7870#	680#
	Co	27	9710#	500#	35280#	640#	-14250#	570#	19580#	400#	-31920#	640#	7140#	400#
	Ni	28	11155	3	32290#	400#	-13160	370	13919	3	-30090#	400#	413.7	2.7
	Cu	29	12949.3	1.8	27730#	300#	-10280	190	8805.3	1.6	-22700	470	-525.5	3.0
	Zn	30	14723.4	2.9	23510	3	-7107	4	4440.4	2.1	-20028	3	-6077.7	2.3
	Ga	31	15820.8	1.5	20189.9	1.4	-5446.2	1.8	-358	4	-13166.1	1.7	-6753.11	0.29
	Ge	32	18166.7	0.8	17599.1	1.9	-5003.7	0.8	-4717.7	2.0	-12546.1	2.7	-12764	4
	As	33	20030	50	13898	4	-3569	4	-9168	4	-5380	4	-13155	5
	Se	34	22080.9	2.5	11884.2	2.1	-3314.3	2.7	-13928	8	-5250.7	2.1	-19437	6
	Br	35	23779	15	9300	50	-2592.1	2.1	-20730#	500#	1542	4	-20810	130
	Kr	36	28980#	200#	6589	8	-2176	8	*	*	1917	8	-29950#	400#
	Rb	37	*	*	1480#	500#	-1960#	560#	*	*	10880#	500#	*	*
73	Fe	26	7610#	640#	*	*	-16750#	710#	27210#	500#	*	*	9230#	640#
	Co	27	9190#	610#	36430#	640#	-15070#	570#	21570#	400#	-34810#	720#	8740#	400#
	Ni	28	10845	3	33260#	400#	-13500#	400#	15485	3	-28970#	500#	1603.5	2.8
	Cu	29	12418.9	2.4	29200	470	-11130	140	10711.9	2.6	-26080#	400#	1086.7	2.9
	Zn	30	14407	3	24765.1	2.9	-8040	4	5704.1	1.9	-18656.3	2.9	-5076.4	2.0
	Ga	31	15702.8	1.9	21566.1	2.2	-6388.0	2.2	1253	4	-17205.3	2.2	-5184.8	1.7
	Ge	32	17533.7	0.8	18546.7	2.7	-5304.6	0.8	-3070	7	-10441.0	2.1	-11139	4
	As	33	19202	6	15392	4	-4050	4	-7305	8	-9653	4	-11156	4
	Se	34	21224	8	12899	7	-3552	8	-11676	10	-2930	7	-17237	7
	Br	35	23288	9	10332	8	-2960	30	-17570#	200#	-2707	8	-17778	11
	Kr	36	26370	130	7983	7	-2542	7	-24600#	400#	4027	7	-26290#	500#
	Rb	37	30160#	450#	4160#	200#	-2250#	210#	*	*	5690#	200#	*	*
	Sr	38	*	*	200#	420#	-1940#	570#	*	*	14700#	400#	*	*

Table III. Nuclear-reaction and separation energies (continued, Explanation of Table on p. 030003-98)

A	Elt.	Z	S(n)		S(p)		Q(4β ⁻)		Q(d,α)		Q(p,α)		Q(n,α)	
74	Fe	26	4760#	780#	*		46170#	600#	1020#	850#	840#	780#	*	
	Co	27	3470#	640#	17210#	710#	35230#	500#	6320#	710#	3470#	640#	-11600#	710#
	Ni	28	6420#	200#	18330#	450#	24970#	200#	2450#	450#	780#	500#	-11380#	450#
	Cu	29	5090	6	13187	7	14854	6	8931	7	4264	7	-5990	470
	Zn	30	8235	3	14058	3	6456.5	2.5	4737.1	2.9	1818.5	2.9	-4704	3
	Ga	31	6422	3	9745	4	-2761	7	10807	4	4143	4	308	3
	Ge	32	10196.24	0.06	11012.1	1.7	-11090.6	2.0	5876.7	0.8	1580.7	0.8	-447.3	2.7
	As	33	7979	4	6851.5	1.7	-18944	3	12436.7	1.7	3910.5	1.9	4925.5	1.9
	Se	34	12057	7	8549	4	-31390#	100#	6727	4	544	4	3339.7	0.8
	Br	35	9712	9	4350	9	*		13291	6	2722	6	8251	7
	Kr	36	13851	7	5973	8	*		7440.7	2.3	-965	6	6461	3
Rb	37	13910#	200#	2653	7	*		12735	9	-720	130	10233	6	
Sr	38	16950#	410#	2040#	220#	*		8210#	510#	-3900#	410#	11150#	160#	
75	Fe	26	2120#	850#	*		48920#	600#	*		1120#	850#	*	
	Co	27	4900#	710#	17350#	780#	38820#	500#	3960#	710#	3650#	710#	-14100#	780#
	Ni	28	3650#	360#	18500#	580#	27830#	300#	4100#	500#	1030#	500#	-9950#	580#
	Cu	29	6536	7	13300#	200#	18562.9	2.5	6348	3	4619	3	-8630#	400#
	Zn	30	4874	3	13842	6	9610.6	2.0	7139.3	2.8	2088.1	2.4	-2686.4	3.0
	Ga	31	8486	4	9997	3	642	5	7840	3	4545	3	-3035.2	2.8
	Ge	32	6505.84	0.05	11096.3	3.0	-7533	8	8553.2	1.7	1595.4	0.8	1934.9	2.1
	As	33	10245.5	1.9	6900.7	0.9	-15815.5	1.5	8974.1	0.9	4415.8	0.9	1200.5	1.2
	Se	34	8027.60	0.07	8598.4	1.7	-25550	220	9494	4	924	4	6062.82	0.10
	Br	35	11890	7	4183	4	-37290#	300#	9831	9	3625	5	4769	6
	Kr	36	10063	8	6324	10	*		10035	11	-398	8	9191	8
Rb	37	13374	3	2175.8	2.3	*		10044	7	1586	8	7489.5	1.6	
Sr	38	13860#	240#	1990	220	*		10170#	300#	-3430#	550#	12970	220	
Y	39	*		-1720#	320#	*		10840#	500#	*		12160#	580#	
76	Co	27	2930#	780#	18160#	850#	41790#	600#	5790#	850#	3250#	780#	*	
	Ni	28	5670#	500#	19270#	640#	31580#	400#	1900#	640#	650#	570#	-13080#	640#
	Cu	29	4576	7	14240#	300#	21315	7	8190#	200#	3996	7	-7910#	400#
	Zn	30	7815.4	2.4	15120.6	2.7	12948.9	1.5	4414	6	1548.5	2.4	-6548.5	2.8
	Ga	31	5903	3	11026.7	2.8	3992	10	10171	3	4160.8	2.7	-1662.8	2.8
	Ge	32	9427.24	0.05	12037.3	2.4	-4199	4	5547.5	3.0	1350.5	1.7	-1973.1	1.9
	As	33	7328.50	0.07	7723.4	0.9	-11812.3	1.3	11841.9	0.9	3870.2	0.9	3054.4	1.9
	Se	34	11153.79	0.07	9506.7	0.9	-21000	30	6318.9	1.7	565	4	1691.97	0.06
	Br	35	9253	10	5409	9	-31810#	300#	12635	9	2802	12	6310	10
	Kr	36	12761	9	7196	6	*		6985	7	-502	8	4860	8
	Rb	37	11331.7	1.5	3444	8	*		12563.6	2.2	937	7	8815	7
Sr	38	15700	220	4320	30	*		8380	30	-3300#	200#	7950	40	
Y	39	14730#	420#	-850#	370#	*		13060#	320#	-1670#	500#	13250#	360#	
77	Co	27	4580#	850#	*		44980#	600#	3340#	850#	3440#	850#	*	
	Ni	28	3240#	640#	19580#	780#	34410#	500#	3560#	710#	890#	710#	-11560#	780#
	Cu	29	5720#	150#	14280#	430#	25290#	150#	6120#	340#	4700#	250#	-10160#	520#
	Zn	30	4557.5	2.5	15102	7	15810.3	2.0	6393	3	2081	6	-4690#	200#
	Ga	31	7767	3	10978.3	2.8	7242	4	7277	3	4628	3	-4340	7
	Ge	32	6071.29	0.05	12205.2	2.0	-1043.4	2.0	7962.5	2.4	1700.8	3.0	190.3	2.5
	As	33	9696.3	1.9	7992.4	1.7	-9085.8	2.1	8651.5	1.7	4370.2	1.7	-220	3
	Se	34	7418.86	0.06	9597.1	0.9	-16796	8	9145.5	0.9	1124.6	1.7	4469.35	0.06
	Br	35	11017	10	5271.8	2.8	-26800#	200#	9645.5	2.8	3842.4	2.8	3272	3
	Kr	36	9227	4	7169	10	-38130#	400#	9648	5	-17	6	7690.2	2.0
	Rb	37	12422.7	1.6	3106	4	*		10204	8	2365.4	2.4	6104	6
Sr	38	11630	40	4613	8	*		10126	8	-1023	8	10175	8	
Y	39	16030#	360#	-520#	200#	*		10890#	300#	-750#	230#	11120#	200#	
Zr	40	*		850#	500#	*		10490#	500#	*		14430#	410#	

Table III. Nuclear-reaction and separation energies (continued, Explanation of Table on p. 030003-98)

A	Elt.	Z	S(2n)	S(2p)	$Q(\alpha)$	$Q(2\beta^-)$	$Q(\epsilon p)$	$Q(\beta^- n)$						
74	Fe	26	7300#	780#	*	-17540#	850#	28870#	630#	*	9760#	720#		
	Co	27	8760#	640#	37500#	780#	-15750#	710#	23190#	500#	*	9220#	500#	
	Ni	28	10370#	200#	34600#	540#	-14370#	450#	17300#	200#	-32850#	540#	2460#	200#
	Cu	29	12366	6	30390#	400#	-11800#	300#	12043	7	-25880#	400#	1516	6
	Zn	30	13754	3	26109	3	-8968	3	7665.7	2.5	-22938	3	-4129	3
	Ga	31	15604	3	22845	3	-7498	3	2810	3	-16351	4	-4823.4	3.0
	Ge	32	16979.18	0.07	19854.9	2.1	-6282.6	1.9	-1209.24	0.01	-15118.0	1.9	-10541	4
	As	33	18773	4	16849.7	1.9	-4374.8	2.1	-5572	6	-8449.7	2.4	-10704	8
	Se	34	20487.7	2.0	14205.24	0.08	-4076.2	0.8	-9881.4	2.0	-8204.65	0.06	-16637	7
	Br	35	22369	6	11636	7	-3370	50	-13372	7	-1624	7	-16808	9
	Kr	36	24534	8	9041.6	2.8	-2826.9	2.6	-21500#	100#	-1393	8	-24320#	200#
	Rb	37	29730#	500#	7432	3	-2915	15	*	*	4442	8	-28040#	400#
	Sr	38	*		1470#	100#	-2150#	220#	*	*	8440#	100#	*	
75	Fe	26	6880#	780#	*	*	*	30390#	670#	*	*	11110#	780#	
	Co	27	8370#	640#	*	-16500#	710#	24820#	500#	*	*	10740#	540#	
	Ni	28	10060#	300#	35710#	580#	-15030#	500#	18530#	300#	-31730#	670#	3910#	300#
	Cu	29	11627	3	31630#	400#	-12530	470	13993	3	-28940#	500#	3214	3
	Zn	30	13108.1	2.7	27029	3	-9577.6	3.0	9298.1	2.0	-21390#	200#	-2581	4
	Ga	31	14907.9	2.9	24055	3	-8178.4	2.8	4569.6	2.6	-19747	7	-3113.5	2.4
	Ge	32	16702.08	0.07	20841.5	1.9	-6953.1	2.7	312.52	0.09	-13389.2	2.5	-9068.2	1.7
	As	33	18224	4	17912.8	1.9	-5320.0	1.2	-3927	4	-12274	3	-8892.3	0.9
	Se	34	20085	7	15449.90	0.09	-4687.9	0.8	-7846	8	-6036.01	0.07	-14953	6
	Br	35	21602	8	12732	6	-3639	6	-11888	4	-5536	5	-14846	5
	Kr	36	23915	10	10674	11	-3602	9	-17700	220	601	8	-20479	9
	Rb	37	27280#	200#	8149	7	-3141	6	-25400#	300#	780	6	-24460#	100#
	Sr	38	30810#	460#	4640	220	-2720	250	*	*	8420	220	*	
	Y	39	*		320#	360#	-2190#	500#	*	*	12810#	300#	*	
76	Co	27	7830#	780#	*	-17040#	850#	26470#	600#	*	*	11450#	670#	
	Ni	28	9320#	450#	36620#	720#	-15630#	640#	20670#	400#	-35280#	720#	4770#	400#
	Cu	29	11112	9	32730#	500#	-13200#	400#	15321	7	-28620#	500#	3512	7
	Zn	30	12688.9	2.9	28430#	200#	-10501.9	2.7	10909.9	1.5	-25560#	300#	-1909.8	2.8
	Ga	31	14390	4	24868	6	-8938.6	2.4	5994.7	2.1	-19114	3	-2511.0	2.0
	Ge	32	15933.08	0.02	22034.1	2.5	-7492.3	2.1	2039.06	0.01	-17943.0	2.0	-8250.0	0.9
	As	33	17574.0	1.9	18820	3	-6128.0	1.2	-2002	9	-11115.8	2.6	-8193.2	0.9
	Se	34	19181.38	0.02	16407.45	0.02	-5090.97	0.08	-6238	4	-10683.96	0.05	-14216	4
	Br	35	21144	11	14007	9	-4484	10	-9810	9	-4544	9	-14037	12
	Kr	36	22825	4	11378	4	-3570	4	-14770	30	-4133	4	-19866	4
	Rb	37	24706	3	9769	6	-3842.3	1.4	-22000#	300#	1339	4	-21930	220
	Sr	38	29560#	110#	6490	30	-2730	40	*	*	2790	40	-30500#	300#
	Y	39	*		1140#	300#	-2580#	580#	*	*	11450#	300#	*	
77	Co	27	7510#	780#	*	*	*	27610#	620#	*	*	12550#	720#	
	Ni	28	8910#	580#	37740#	780#	-16330#	710#	21990#	500#	*	*	6110#	500#
	Cu	29	10300#	150#	33550#	520#	-13630#	430#	17370#	150#	-31400#	620#	5610#	150#
	Zn	30	12372.9	2.8	29340#	300#	-11106	3	12423.7	2.0	-24450#	400#	-563.9	2.8
	Ga	31	13670	3	26099	3	-9430	3	7924.0	3.0	-22305	7	-850.8	2.4
	Ge	32	15498.53	0.07	23231.9	2.0	-8044.4	1.9	3386.63	0.08	-16198.8	1.5	-6992.8	0.9
	As	33	17024.8	1.9	20029.7	3.0	-6641.9	2.4	-682	3	-14908.6	2.6	-6735.7	1.7
	Se	34	18572.64	0.10	17320.47	0.08	-5726.88	0.08	-4430.0	2.0	-8675.57	0.06	-12382	9
	Br	35	20270	5	14778.6	2.9	-4707	5	-8404	3	-8232.4	2.9	-12292	5
	Kr	36	21988	8	12577.9	2.0	-4367	8	-12366	8	-2206.5	2.0	-17761.7	2.2
	Rb	37	23754.4	1.8	10301	4	-3608	7	-18390#	200#	-1830	9	-18650	30
	Sr	38	27330	220	8058	11	-3677	10	-25760#	400#	3921	9	-27400#	300#
	Y	39	30760#	360#	3800#	200#	-2780#	290#	*	*	6750#	200#	*	
	Zr	40	*		-0#	460#	-2510#	570#	*	*	14920#	400#	*	

Table III. Nuclear-reaction and separation energies (continued, Explanation of Table on p. 030003-98)

A	Elt.	Z	S(n)		S(p)		Q(4β ⁻)		Q(d,α)		Q(p,α)		Q(n,α)	
78	Ni	28	5160#	780#	20160#	850#	37970#	600#	1330#	850#	620#	780#	-14600#	850#
	Cu	29	3950#	530#	14990#	710#	28320	500	7840#	640#	4400#	590#	-9200#	710#
	Zn	30	6765.4	2.8	16150#	150#	19542.7	2.0	4204	7	1852	3	-7810#	300#
	Ga	31	5785	3	12205.7	2.7	9746	4	9307.9	2.4	3717.0	2.7	-3588	3
	Ge	32	8721	4	13159	4	2316	4	5145	4	1467	4	-3657	4
	As	33	6972	10	8893	10	-5882	10	11107	10	3904	10	1294	10
	Se	34	10497.77	0.17	10398.6	1.7	-13852	7	5976.2	0.9	872.3	0.9	477.42	0.19
	Br	35	8289	5	6142	4	-21280#	300#	12511	4	3581	4	5228	4
	Kr	36	12080.1	2.0	8232.4	2.8	-33330#	400#	6822	9	-207	4	3637.6	0.3
	Rb	37	10176	3	4055	4	*	*	12789	5	2252	9	7818	5
	Sr	38	13442	11	5632	8	*	*	8016	8	-1091	8	6796	11
	Y	39	13810#	360#	1660#	300#	*	*	12790#	300#	-690#	370#	10690#	300#
	Zr	40	16880#	570#	1700#	450#	*	*	8340#	500#	-4170#	500#	11420#	460#
	79	Ni	28	1750#	850#	*	*	41960#	600#	4160#	850#	1800#	850#	*
Cu		29	5310#	590#	15140#	670#	31900#	300#	5770#	580#	4750#	500#	-11580#	670#
Zn		30	4020.4	3.0	16220	500	22485.2	2.2	5900#	150#	2408	7	-6160#	400#
Ga		31	6913.0	2.7	12353.4	2.7	13520.4	2.1	6952.3	2.7	4619.4	2.4	-5925	7
Ge		32	5740	40	13110	40	4920	40	7180	40	1630	40	-1580	40
As		33	8890	11	9063	6	-2833	6	8288	5	4441	5	-1693	6
Se		34	6962.83	0.13	10389	10	-10441	8	8709.7	1.7	1238.0	0.9	2941.83	0.22
Br		35	10687	4	6331.1	1.0	-18250	80	9242.3	1.0	4048.0	1.0	1869.7	1.4
Kr		36	8335	3	8279	5	-27670#	300#	9503	4	711	10	6456	3
Rb		37	11939	4	3913.7	2.2	-39150#	500#	10077.3	2.9	3075	5	5132	10
Sr		38	10374	11	5830	9	*	*	10064	8	-134	8	9183	9
Y		39	13720#	310#	1930	80	*	*	10700	80	1290	90	8310	80
Zr		40	13990#	500#	1890#	420#	*	*	10380#	360#	-3430#	420#	13120#	300#
Nb		41	*	*	-1910#	640#	*	*	11100#	640#	*	*	12480#	580#
80	Ni	28	3130#	920#	*	*	46910#	700#	*	*	3250#	920#	*	*
	Cu	29	2530#	500#	15920#	720#	36020#	400#	8400#	720#	5460#	640#	-9540#	720#
	Zn	30	6288	3	17200#	300#	26110.8	2.8	3560	500	1840#	150#	-9200#	500#
	Ga	31	4747	3	13080	4	16665	3	8970	3	4430	3	-4950#	150#
	Ge	32	8080	40	14276.6	2.8	8358.0	2.2	4881.5	2.8	1321	3	-5099.7	2.8
	As	33	6650	6	9980	40	-39	4	10358	5	3862	3	-576	4
	Se	34	9913.3	1.0	11412	5	-7448	4	5768	10	1020.9	1.8	-900.2	1.0
	Br	35	7892.28	0.13	7260.5	1.0	-14741	6	11847.8	1.0	3574.6	1.0	3673.7	1.8
	Kr	36	11522	4	9114.3	1.2	-23530#	300#	6270	4	205.5	2.9	2352.5	0.7
	Rb	37	9443.8	2.8	5022	4	-33760#	400#	12713.6	1.9	2858.0	2.7	6706	3
	Sr	38	12906	9	6797	4	*	*	7335	5	-617	4	5504	4
	Y	39	11400	80	2960	10	*	*	12737	10	1519	10	9329	6
	Zr	40	15660#	420#	3830#	310#	*	*	8520#	420#	-3060#	360#	9090#	300#
	Nb	41	14840#	640#	-1060#	500#	*	*	13140#	570#	-1520#	570#	13670#	450#
81	Cu	29	3290#	640#	16080#	860#	41110#	500#	6860#	780#	7330#	780#	*	*
	Zn	30	2622	6	17290#	400#	30189	5	6250#	300#	3160	500	-6660#	600#
	Ga	31	6476	4	13268	4	20349	3	6515	4	4719	4	-7480	500
	Ge	32	4827.7	2.9	14357	4	11404.5	2.3	6966.8	2.8	2278.3	2.8	-3162.1	2.8
	As	33	8390	4	10287	3	2923	6	7700	40	4193	4	-3181	3
	Se	34	6700.8	0.3	11463	3	-4861	3	7958	5	1292	10	1119	4
	Br	35	10159.4	1.4	7506.5	1.4	-12264	5	8651.2	1.0	3913.0	1.0	486	10
	Kr	36	7874.2	1.2	9096.2	1.5	-20240	90	9082.7	1.5	620	4	4976.2	1.1
	Rb	37	11353	5	4852	5	-29100#	400#	9696	6	3586	5	3642	6
	Sr	38	9288	5	6642	4	-39780#	500#	9986	4	271	5	8297	3
	Y	39	12636	8	2690	6	*	*	10475	10	2325	9	6869	6
	Zr	40	11170#	310#	3600	90	*	*	11070	120	-420#	310#	11360	90
	Nb	41	16010#	570#	-710#	500#	*	*	11120#	500#	-650#	570#	11460#	500#
	Mo	42	*	*	620#	640#	*	*	10610#	710#	*	*	14750#	640#

Table III. Nuclear-reaction and separation energies (continued, Explanation of Table on p. 030003-98)

A	Elt.	Z	S(2n)	S(2p)	$Q(\alpha)$	$Q(2\beta^-)$	$Q(\epsilon p)$	$Q(\beta^-n)$						
78	Ni	28	8400#	720#	*	-16720#	850#	23590#	600#	*	6660#	620#		
	Cu	29	9660	500	34570#	780#	-14100#	710#	19210	500	-30770#	780#	6220	500
	Zn	30	11322.9	2.4	30430#	400#	-11450#	200#	14379	4	-27970#	500#	438	3
	Ga	31	13551.9	2.7	27308	7	-10125	6	9111	10	-22370#	150#	-564.4	1.9
	Ge	32	14792	4	24137	4	-8530	4	5164	4	-20362	4	-6017	4
	As	33	16668	10	21098	10	-7192	10	635	10	-14114	10	-6289	10
	Se	34	17916.63	0.18	18391.00	0.18	-6028.42	0.18	-2847.67	0.26	-13102.05	0.19	-11862.5	2.8
	Br	35	19306	10	15739	4	-5017	4	-6517	5	-6825	4	-11354	4
	Kr	36	21307	4	13504.3	0.3	-4390.0	0.3	-11004	7	-6867.8	0.3	-17419.1	1.3
	Rb	37	22599	3	11224	10	-4072	7	-14760#	300#	-990	4	-17203	9
	Sr	38	25070	40	8738	8	-3267	8	-22320#	400#	-293	8	-24810#	200#
	Y	39	29840#	420#	6270#	300#	-2680#	300#	*	5370#	300#	-28210#	500#	
	Zr	40	*		1180#	400#	-2450#	410#	*	9670#	400#	*		
79	Ni	28	6910#	780#	*	-16360#	850#	25860#	600#	*		8860#	780#	
	Cu	29	9260#	340#	35300#	670#	-14520#	580#	20810#	300#	*		7670#	300#
	Zn	30	10785.7	3.0	31210#	500#	-11830#	300#	16090	40	-26830#	600#	2202.3	2.9
	Ga	31	12698	3	28500#	150#	-10501.3	3.0	11088	6	-25340	500	1243	4
	Ge	32	14460	40	25320	40	-9390	40	6390	40	-19330	40	-4780	40
	As	33	15862	6	22222	6	-7596	6	2432	5	-17219	6	-4681	5
	Se	34	17460.60	0.21	19282.54	0.23	-6485.41	0.23	-1475	3	-11344	4	-10537	4
	Br	35	18975.9	3.0	16729.7	1.8	-5458.8	1.3	-5265.0	2.4	-10540	10	-9961.1	1.1
	Kr	36	20415	4	14421	3	-4698	3	-8965	9	-4705	3	-15578	5
	Rb	37	22115.1	2.5	12146	4	-4121	5	-12990	80	-4640	4	-15700	8
	Sr	38	23816	12	9885	9	-3578	12	-18710#	300#	1412	8	-21380#	300#
	Y	39	27520#	220#	7570	80	-3020	80	-26170#	510#	1830	80	-25040#	410#
	Zr	40	30870#	500#	3550#	300#	-2580#	370#	*	9120#	300#	*		
	Nb	41	*		-210#	540#	-2260#	580#	*	13230#	580#	*		
80	Ni	28	4880#	920#	*	*		29020#	700#	*		11040#	760#	
	Cu	29	7850#	640#	*	-14110#	720#	23020#	400#	*		9160#	400#	
	Zn	30	10308	3	32340#	600#	-12440#	400#	17887	3	-31370#	600#	2828	3
	Ga	31	11660	3	29300	500	-10673	7	12991	4	-24770#	300#	2230	40
	Ge	32	13816	4	26630.0	2.8	-9657.2	2.5	8224.2	2.3	-23392	3	-3971	6
	As	33	15540	10	23086	4	-8343	4	3675	3	-16956	4	-4368	3
	Se	34	16876.1	1.0	20475	4	-6971.5	1.0	133.9	1.1	-15520	40	-9762.7	0.3
	Br	35	18579	4	17650	10	-6022.5	1.3	-3713.5	2.1	-9542	5	-9518	3
	Kr	36	19857.7	0.8	15445.3	0.7	-5066.3	0.7	-7582	4	-9264.9	0.7	-15161.7	2.3
	Rb	37	21383	4	13301	4	-4311	10	-11027	7	-3396.4	2.1	-14770	9
	Sr	38	23280	8	10711	3	-3723	5	-15950#	300#	-3158	5	-20560	80
	Y	39	25120#	300#	8791	7	-3094	6	-22730#	400#	2366	7	-22450#	300#
	Zr	40	29650#	500#	5760#	300#	-2540#	300#	*	3830#	300#	-30780#	580#	
	Nb	41	*		830#	500#	-2370#	500#	*	12110#	410#	*		
81	Cu	29	5820#	580#	*	-12830#	780#	26210#	500#	*		12160#	500#	
	Zn	30	8910	6	33210#	600#	-11830#	500#	20092	5	-30860#	700#	4953	6
	Ga	31	11223	4	30470#	300#	-11430#	150#	14905	4	-28720#	400#	3836	4
	Ge	32	12910	40	27437	3	-9927.4	2.8	10097.3	2.3	-21932	3	-2149	4
	As	33	15040	6	24564	3	-8966	4	5443.7	2.8	-20599	4	-2845.2	2.8
	Se	34	16614.2	1.0	21440	40	-7601.0	1.0	1307.2	1.5	-14142.7	2.3	-8571.3	0.5
	Br	35	18051.6	1.4	18919	5	-6485.6	2.0	-2520	5	-13052	3	-8155.0	1.2
	Kr	36	19397	4	16356.7	1.1	-5521.6	1.1	-6168	3	-7225.7	1.4	-13592.0	2.2
	Rb	37	20796	5	13967	5	-4647	6	-9744	7	-6857	5	-13217	6
	Sr	38	22194	9	11664	5	-3784	4	-14070	90	-924	3	-18451	7
	Y	39	24040	80	9488	6	-3307	6	-19350#	400#	-826	6	-19420#	300#
	Zr	40	26830#	310#	6560	90	-2080	90	-25710#	510#	5560	90	-27110#	410#
	Nb	41	30850#	640#	3120#	410#	-2350#	450#	*	7500#	400#	*		
	Mo	42	*		-440#	580#	-2140#	640#	*	15320#	580#	*		

Table III. Nuclear-reaction and separation energies (continued, Explanation of Table on p. 030003-98)

A	Elt.	Z	S(n)		S(p)		Q($4\beta^-$)		Q(d, α)		Q(p, α)		Q(n, α)	
82	Cu	29	1970#	780#	*		44790#	600#	8020#	920#	7120#	850#	*	
	Zn	30	4186	6	18180#	500#	35280	3	4600#	400#	4290#	300#	-9100#	600#
	Ga	31	3374	4	14020	6	24567.9	2.6	9429	4	5366	3	-5540#	300#
	Ge	32	7195	3	15076	4	15176.7	2.2	4519	4	1996.7	2.9	-6336	3
	As	33	5643	5	11103	4	6082	5	10141	4	4290	40	-1911	4
	Se	34	9276.2	1.0	12349.5	2.7	-1584	6	5331	3	906	5	-2420	40
	Br	35	7592.94	0.12	8398.6	1.4	-9435	6	10971.6	1.4	3282.9	1.0	1784	5
	Kr	36	10966.9	1.1	9903.7	1.0	-16960	11	6008.0	1.0	340.3	1.0	972.08	0.22
	Rb	37	8802	6	5781	3	-24100#	300#	12416	3	3119	5	5527	3
	Sr	38	12553	7	7842	8	-35640#	400#	6876	6	-343	6	4079	7
	Y	39	10422	8	3825	6	*	*	12958	6	2277	10	8385	6
	Zr	40	14240	90	5207	12	*	*	8228	13	-950	80	7492	14
	Nb	41	13800#	500#	1920#	310#	*	*	12980#	420#	-460#	420#	11370#	310#
	Mo	42	16690#	640#	1300#	570#	*	*	8760#	570#	-3860#	640#	12050#	500#
83	Zn	30	2050#	300#	18260#	670#	39050#	300#	5840#	580#	4770#	500#	-8010#	760#
	Ga	31	4398	4	14232	4	29757	5	7653	6	7256	4	-7410#	400#
	Ge	32	3633	3	15335	3	19014.2	2.4	7362	4	3111	4	-3681	4
	As	33	7635	5	11543	4	9401	4	7333	3	4730	3	-4799	4
	Se	34	5818	3	12524	5	1457	7	7904	4	1738	5	-159	4
	Br	35	9586	4	8709	4	-6808	19	8086	4	3610	4	-1153	5
	Kr	36	7470.16	0.01	9780.9	1.0	-14079	6	8697.2	1.0	762.4	1.0	3415.2	1.0
	Rb	37	10954	4	5767.8	2.3	-21510	150	9336.4	2.6	3686.8	2.4	2464.8	2.5
	Sr	38	8859	9	7899	7	-30460#	400#	9370	8	242	7	6742	7
	Y	39	12213	19	3485	20	-40890#	500#	10033	19	2970	19	5616	19
	Zr	40	10352	13	5137	8	*	*	10512	8	101	9	10046	7
	Nb	41	13540#	340#	1210	150	*	*	10610	180	1670#	340#	9240	150
	Mo	42	14040#	570#	1540#	500#	*	*	10730#	570#	-3060#	570#	13670#	500#
	Tc	43	*		-1760#	640#	*	*	11140#	710#	*	*	12750#	640#
84	Zn	30	3710#	500#	*		44020#	400#	4100#	720#	4360#	640#	*	
	Ga	31	2900#	200#	15090#	360#	33700#	200#	8940#	200#	6980#	200#	-7020#	540#
	Ge	32	5243	4	16180	4	24291	3	5493	4	4344	5	-6302	6
	As	33	4256	4	12166	4	13905	4	10272	4	5302	4	-2579	5
	Se	34	8679	4	13567	3	4701.8	2.3	4869	4	1450	3	-4009.6	2.8
	Br	35	6841	26	9732	26	-3889	26	10522	26	3470	26	397	26
	Kr	36	10520.02	0.01	10715	4	-11018	5	5770.1	1.0	401.8	1.0	-403.9	1.0
	Rb	37	8760	3	7057.3	2.2	-18540	13	11543.6	2.2	2801.3	2.4	3864.5	2.4
	Sr	38	11923	7	8867.9	2.6	-26480#	300#	6249	3	-329	5	2693.0	1.6
	Y	39	9760	19	4386	8	-36190#	400#	12826	7	2498	5	7209	7
	Zr	40	13581	8	6505	19	*	*	7353	8	-845	8	5753	6
	Nb	41	11730	150	2596	15	*	*	13123	17	1110	90	10141	14
	Mo	42	15900#	500#	3900#	330#	*	*	8630#	420#	-2950#	500#	8940#	310#
	Tc	43	14450#	640#	-1350#	570#	*	*	13380#	570#	-1090#	640#	14310#	570#
85	Zn	30	1370#	640#	*		47180#	500#	*		4950#	780#	*	
	Ga	31	3830#	360#	15210#	500#	38730#	300#	7150#	420#	7330#	300#	-8880#	670#
	Ge	32	3046	5	16330#	200#	28357	4	6845	5	4671	4	-5163	5
	As	33	5407	4	12330	4	18978	3	8498	4	7090	4	-4612	4
	Se	34	4537	3	13849	4	8690	4	7966	4	2556	5	-1352	3
	Br	35	8864	26	9917	4	-733	19	7476	4	3882	3	-2824	5
	Kr	36	7112.3	2.0	10986	26	-8305	7	8244	4	882.4	2.2	1760.0	2.1
	Rb	37	10479.7	2.2	7016.97	<i>a</i>	-15888	4	8534.11	0.01	3288.51	0.01	977.7	1.0
	Sr	38	8525	3	8633	4	-23594	16	8678	4	-51	4	5134.9	2.8
	Y	39	12019	19	4482	19	-31990#	400#	9666	20	3032	20	3992	19
	Zr	40	9825	8	6570	8	-42230#	500#	9741	20	-247	8	8481	9
	Nb	41	13132	14	2147	7	*	*	10343	8	2216	12	7431	7
	Mo	42	11410#	300#	3580	21	*	*	10760	150	-560#	300#	11768	19
	Tc	43	16220#	570#	-1030#	500#	*	*	11200#	570#	-620#	570#	11890#	500#
	Ru	44	*		540#	640#	*	*	11080#	710#	*	*	15070#	640#

Table III. Nuclear-reaction and separation energies (continued, Explanation of Table on p. 030003-98)

A	Elt.	Z	S(2n)	S(2p)	$Q(\alpha)$	$Q(2\beta^-)$	$Q(\epsilon p)$	$Q(\beta^-n)$						
82	Cu	29	5260#	720#	*	*	27610#	600#	*	12810#	600#			
	Zn	30	6808	4	34260#	700#	-10850#	600#	23101	4	*	7243	4	
	Ga	31	9850	4	31310#	400#	-10860	500	17175	4	-28800#	500#	5290	3
	Ge	32	12022	3	28344	3	-10356.7	3.0	12178.8	2.3	-26504	6	-953	3
	As	33	14034	5	25460	5	-8824	4	7393	4	-19766	5	-1788	4
	Se	34	15977.1	0.9	22636.5	2.1	-8157	4	2997.9	0.5	-18591.2	2.1	-7688.2	1.1
	Br	35	17752.3	1.4	19862	3	-7107	10	-1311	3	-12254.3	2.8	-7873.8	0.5
	Kr	36	18841.1	0.7	17410.3	1.0	-5990.76	0.18	-4582	6	-11491.8	1.0	-13206	5
	Rb	37	20155	4	14877	3	-5161	5	-8124	6	-5500	3	-12731	4
	Sr	38	21841	7	12695	6	-4257	6	-12379	13	-5603	6	-18368	8
	Y	39	23059	8	10467	6	-3554	6	-15970#	300#	104	7	-18680	90
	Zr	40	25410#	300#	7898	12	-2882	13	-23260#	400#	608	12	-25340#	400#
	Nb	41	29810#	500#	5520#	300#	-2340#	420#	*		6330#	300#	-28410#	580#
	Mo	42	*		590#	500#	-1950#	570#	*		9800#	410#	*	
83	Zn	30	6230#	300#	*		-11150#	670#	24690#	300#	*		8570#	300#
	Ga	31	7772	4	32420#	500#	-9940#	300#	20412	4	-31230#	600#	8087	3
	Ge	32	10827	3	29355	6	-9969	3	14364	4	-25951	4	1058	4
	As	33	13279	4	26619	4	-9547	3	9344	5	-24028	4	-146.8	2.8
	Se	34	15094	3	23627	4	-8240	40	4650	3	-17214	4	-5913	3
	Br	35	17179	4	21058	5	-7803	7	57	4	-16197	5	-6493	4
	Kr	36	18437.1	1.1	18179.6	1.0	-6498.09	0.22	-3193	7	-9685.7	0.5	-11874	3
	Rb	37	19757	5	15671.5	2.5	-5427.5	2.5	-6865	19	-8860.9	2.5	-11132	6
	Sr	38	21412	8	13679	7	-4780	8	-10886	9	-3495	7	-16805	9
	Y	39	22635	19	11327	19	-3828	19	-14650	150	-3307	19	-16646	22
	Zr	40	24590	90	8961	7	-2860	11	-19570#	400#	2809	9	-21890#	300#
	Nb	41	27340#	430#	6420	150	-2160	170	-26240#	520#	3220	150	-25260#	430#
	Mo	42	30730#	640#	3460#	410#	-2000#	500#	*		10000#	400#	*	
	Tc	43	*		-460#	640#	-2090#	710#	*		13480#	580#	*	
84	Zn	30	5760#	400#	*		-11730#	810#	26220#	400#	*		9260#	400#
	Ga	31	7300#	200#	33350#	630#	-10310#	450#	21770#	200#	*		8820#	200#
	Ge	32	8876	4	30412	4	-8925	4	17799	4	-29150#	300#	3450	4
	As	33	11891	5	27501	4	-9055	4	11930	26	-23885	4	1416	4
	Se	34	14496.5	2.0	25110.6	3.0	-8837.3	2.8	6491.6	2.0	-22260	3	-5005	4
	Br	35	16427	26	22256	26	-7994	26	1976	26	-15403	26	-5864	26
	Kr	36	17990.18	<i>a</i>	19423.4	0.5	-7104.8	1.0	-1789.8	1.2	-14388	3	-11440.0	2.3
	Rb	37	19714	4	16838.2	2.4	-6294.9	2.4	-5865	5	-8034	4	-11033	7
	Sr	38	20782	6	14635.7	1.2	-5181.1	1.4	-9228	6	-7947.9	1.2	-16515	19
	Y	39	21973	7	12285	5	-4144	5	-12676	14	-2113	5	-16054	8
	Zr	40	23933	12	9990	8	-3535	6	-17250#	300#	-1913	9	-21940	150
	Nb	41	25270#	300#	7733	14	-2495	14	-23520#	400#	3698	23	-22950#	400#
	Mo	42	29940#	500#	5120#	300#	-2240#	420#	*		4450#	300#	-30920#	580#
	Tc	43	*		190#	500#	-1710#	570#	*		12570#	430#	*	
85	Zn	30	5080#	580#	*		*		27890#	500#	*		10790#	540#
	Ga	31	6740#	300#	*		-10850#	580#	23340#	300#	*		10230#	300#
	Ge	32	8290	4	31410#	300#	-9349	6	19290	5	-28480#	400#	4659	5
	As	33	9662	4	28510	4	-7986	4	15386	4	-26390#	200#	4687	4
	Se	34	13216	4	26015	4	-8547	3	9067	3	-21554	4	-2702	26
	Br	35	15704	5	23484	4	-8467	4	3592	3	-20011	4	-4207	3
	Kr	36	17632.3	2.0	20718	4	-7516.3	2.2	-377	3	-12821.6	2.8	-9792.7	3.0
	Rb	37	19239.3	2.3	17732	4	-6615.2	1.0	-4325	19	-11673	26	-9589.1	1.2
	Sr	38	20448	7	15690.6	2.8	-5832	3	-7928	7	-5952.9	2.8	-15280	5
	Y	39	21779	27	13349	19	-4810	20	-11562	19	-5372	19	-14492	20
	Zr	40	23406	9	10956	9	-4072	7	-15665	17	185	7	-20028	15
	Nb	41	24870	150	8652	19	-2992	7	-20430#	400#	326	6	-20180#	300#
	Mo	42	27310#	400#	6176	17	-2470	100	-26560#	500#	6623	17	-27880#	400#
	Tc	43	30670#	640#	2870#	430#	-1910#	570#	*		8080#	400#	*	
	Ru	44	*		-810#	640#	-1630#	710#	*		15930#	580#	*	

Table III. Nuclear-reaction and separation energies (continued, Explanation of Table on p. 030003-98)

A	Elt.	Z	S(n)	S(p)	$Q(4\beta^-)$	$Q(d,\alpha)$	$Q(p,\alpha)$	$Q(n,\alpha)$						
86	Ga	31	2300#	500#	16140#	640#	41550#	400#	8560#	570#	7070#	500#	*	
	Ge	32	4350	440	16840#	530#	33870	440	5400#	480#	4720	440	-7460#	530#
	As	33	3844	5	13128	5	23785	3	9897	5	6878	4	-4059	4
	Se	34	6161	4	14603	4	14019.9	2.5	6061	4	4030	4	-3880	3
	Br	35	5128	4	10508	4	3651	14	11026	4	4572	4	-317	4
	Kr	36	9856.7	2.0	11979	3	-5297	4	5228	26	612	4	-2279	3
	Rb	37	8650.98	0.20	8555.6	2.0	-13613	6	10403.15	0.20	2107.70	0.20	1913	4
	Sr	38	11491.1	2.8	9644.73	0.01	-20413	4	5946.7	2.2	-588.4	2.3	1113.95	0.01
	Y	39	9512	24	5469	14	-27710#	300#	12077	14	2379	16	5434	14
	Zr	40	12865	7	7416	19	-38200#	400#	6636	6	-899	19	4475	8
	Nb	41	10926	7	3248	8	*	*	12998	8	1642	8	8718	19
	Mo	42	14672	16	5120	6	*	*	7819	14	-1690	150	7448	7
	Tc	43	13790#	500#	1350#	300#	*	*	13310#	420#	-370#	500#	11630#	340#
	Ru	44	16890#	640#	1210#	570#	*	*	8640#	570#	-3590#	640#	12220#	570#
87	Ga	31	3240#	640#	*	*	44640#	500#	6690#	710#	7540#	640#	*	*
	Ge	32	2750#	530#	17290#	500#	36630#	300#	6480#	420#	4870#	360#	-6500#	500#
	As	33	4727	5	13510	440	28979.9	3.0	8216	5	7395	4	-5880#	200#
	Se	34	3994	3	14753	4	18453.9	2.2	7474	4	4291	4	-2631	4
	Br	35	6331	4	10677	4	9127	3	9233	4	6920	4	-2392	4
	Kr	36	5515.17	0.25	12366	3	-1362	4	8577	3	1938	26	884.6	2.0
	Rb	37	9922.11	0.20	8621.10	0.01	-10723	7	7593.3	2.0	2705.60	0.01	-1168	26
	Sr	38	8428.29	0.01	9422.04	0.20	-17995.3	2.9	7998.07	0.01	-257.0	2.2	3205.67	a
	Y	39	11807	14	5784.3	1.1	-25328	4	8796	3	2495.2	1.7	2387.0	2.5
	Zr	40	9449	5	7353	15	-33830#	400#	9206	19	-589	6	6949	4
	Nb	41	12812	9	3194	8	*	*	10012	9	2411	9	5666	8
	Mo	42	10846	5	5040	6	*	*	10106	5	-802	13	10183	6
	Tc	43	14190#	300#	869	6	*	*	10531	16	1340#	300#	9175	14
	Ru	44	13820#	570#	1240#	500#	*	*	11040#	570#	-2960#	570#	14300#	500#
88	Ge	32	4130#	500#	18180#	640#	39550#	400#	4650#	570#	4580#	500#	-9260#	640#
	As	33	3170#	200#	13930#	360#	31890#	200#	9390#	480#	7270#	200#	-5220#	360#
	Se	34	5529	4	15555	4	24037	3	5789	5	4169	5	-5114	5
	Br	35	4896	4	11579	4	13583	4	10498	4	6562	4	-1880	4
	Kr	36	7053.1	2.6	13089	4	3938	6	6652	4	3748	4	-1631	4
	Rb	37	6082.52	0.16	9188.44	0.29	-6440	60	11367.48	0.16	3735.4	2.0	1613	3
	Sr	38	11112.87	0.01	10612.80	0.01	-15235	4	5536.18	0.20	-890.23	0.01	-794.9	2.0
	Y	39	9352.0	1.9	6707.9	1.5	-22620	150	10934.9	1.5	1668	3	3514.7	1.5
	Zr	40	12353	7	7899	6	-29290#	300#	6365	15	-923	20	3121	6
	Nb	41	10370	60	4120	60	-39310#	400#	12510	60	1870	60	7310	60
	Mo	42	13873	5	6101	8	*	*	7158	7	-1543	6	6135	7
	Tc	43	12060	150	2090	150	*	*	13140	150	690	150	10240	150
	Ru	44	16890#	500#	3940#	300#	*	*	7940#	420#	-3630#	500#	8820#	300#
	Rh	45	*	*	-1370#	570#	*	*	13620#	570#	-1050#	640#	14640#	570#
89	Ge	32	1660#	570#	*	*	42810#	400#	6230#	640#	5210#	570#	*	*
	As	33	4150#	360#	13950#	500#	34910#	300#	7990#	420#	7470#	530#	-7070#	500#
	Se	34	3180	5	15560#	200#	27217	4	7336	5	4834	5	-3950	440
	Br	35	5630	5	11679	5	19434	4	8863	4	7093	4	-3666	5
	Kr	36	4916	3	13109	4	8340	4	8067	4	3961	4	-386	3
	Rb	37	7175	5	9310	6	-1087	24	9708	5	6417	5	-434	6
	Sr	38	6358.72	0.09	10888.99	0.18	-11194	4	9099.58	0.09	1402.03	0.22	2703.05	0.09
	Y	39	11480.7	2.2	7075.7	1.6	-20314	4	7882.5	1.6	1678.8	1.6	685.0	1.6
	Zr	40	9318	6	7866	3	-26620#	300#	8854	3	-728	14	5294	3
	Nb	41	12520	60	4285	24	-34770#	360#	9433	24	2208	24	4304	28
	Mo	42	10400	5	6130	60	*	*	9570	8	-1017	7	8600	5
	Tc	43	13780	150	1997	5	*	*	10201	5	1579	5	7386	7
	Ru	44	11990#	420#	3870#	330#	*	*	10140#	300#	-1830#	420#	11500#	300#
	Rh	45	17070#	540#	-1190#	200#	*	*	10370#	540#	-1230#	540#	11360#	470#

Table III. Nuclear-reaction and separation energies (continued, Explanation of Table on p. 030003-98)

A	Elt.	Z	S(2n)		S(2p)		Q(α)		Q($2\beta^-$)		Q(ϵ_p)		Q(β^-n)	
86	Ga	31	6140#	450#	*		-11190#	720#	24880#	400#	*		10970#	400#
	Ge	32	7390	440	32050#	590#	-9510	440	21100	440	-31460#	670#	5720	440
	As	33	9251	5	29450#	200#	-8456	4	16670	5	-26400#	300#	5380	4
	Se	34	10698	3	26933	4	-7513	3	12762.5	2.5	-24669	4	1	4
	Br	35	13992	26	24357	4	-7952	5	7115	3	-19732	4	-2223	4
	Kr	36	16968.96	<i>a</i>	21895.9	2.0	-8096.7	0.5	1257.42	<i>a</i>	-18141.0	2.6	-9169.65	<i>a</i>
	Rb	37	19130.7	2.2	19542	26	-7673.2	1.0	-3464	14	-11460	3	-9715.0	2.8
	Sr	38	20016.2	1.2	16661.70	<i>a</i>	-6356.22	0.01	-6554	4	-10331.7	2.0	-14752	19
	Y	39	21531	15	14102	14	-5520	14	-10149	15	-4405	14	-14179	16
	Zr	40	22690	7	11897	4	-4384	7	-13859	5	-4155	5	-19761	5
	Nb	41	24058	14	9818	7	-3495	8	-17560#	300#	1419	20	-19696	17
	Mo	42	26080#	300#	7267	7	-2904	12	-24340#	400#	1776	7	-26330#	400#
	Tc	43	30010#	500#	4930#	300#	-1910#	420#	*		7420#	300#	-28690#	580#
	Ru	44	*		180#	500#	-1830#	570#	*		10450#	400#	*	
87	Ga	31	5540#	580#	*		*		26370#	500#	*		12080#	670#
	Ge	32	7100#	300#	33430#	580#	-10210#	420#	22350#	300#	*		6810#	300#
	As	33	8571	4	30350#	300#	-8786	4	18274	4	-28830#	400#	6814	4
	Se	34	10155	3	27881	4	-7875	3	14283.4	2.3	-24320	440	1135	4
	Br	35	11459	4	25280	4	-6647	4	10706	3	-22219	5	1303	3
	Kr	36	15371.8	2.0	22873.8	2.6	-7794	3	4170.54	0.25	-17495.3	2.5	-6033.8	0.3
	Rb	37	18573.09	0.01	20600	3	-8009	4	-1579.4	1.1	-16255	3	-8146.02	0.01
	Sr	38	19919.4	2.8	17977.7	2.0	-7314.35	0.01	-5533	4	-8903.37	<i>a</i>	-13668	14
	Y	39	21319	19	15429.0	1.1	-6372.7	2.6	-9144	7	-7560.4	1.1	-13121	4
	Zr	40	22315	8	12822	5	-4974	8	-12462	5	-2113	4	-18284	7
	Nb	41	23737	8	10610	20	-4094	20	-16184	8	-1880	16	-17836	8
	Mo	42	25518	16	8288	7	-3398	7	-21370#	400#	3795	5	-23390#	300#
	Tc	43	27980#	400#	5988	6	-2560	150	*		4155	7	-25990#	400#
	Ru	44	30710#	640#	2590#	400#	-1610#	570#	*		11300#	400#	*	
88	Ge	32	6880#	590#	*		-10630#	570#	23750#	400#	*		7410#	400#
	As	33	7900#	200#	31220#	450#	-9060#	280#	20000#	200#	-28760#	540#	7640#	200#
	Se	34	9524	4	29060	440	-8161	5	15807	4	-27100#	300#	1936	5
	Br	35	11226	4	26332	5	-7287	4	11893	3	-22387	4	1922	3
	Kr	36	12568.3	2.6	23766	4	-6168	3	8230.3	2.6	-20554	3	-3164.8	2.6
	Rb	37	16004.64	0.26	21555	3	-7251	26	1690.0	1.5	-16006	3	-5800.25	0.16
	Sr	38	19541.16	0.01	19233.89	<i>a</i>	-7907.20	<i>a</i>	-4293	5	-14501.07	0.25	-12974.6	1.1
	Y	39	21159	14	16130.0	1.5	-6965.0	2.7	-8130	60	-6990.2	1.5	-13023	4
	Zr	40	21802	6	13684	5	-5404	6	-10942	7	-6038	5	-17826	9
	Nb	41	23180	60	11470	60	-4700	60	-14490	160	-440	60	-17360	60
	Mo	42	24719	5	9295	5	-3690	7	-18350#	300#	-628	6	-23068	6
	Tc	43	26250#	340#	7130	150	-2890	150	-24820#	430#	4900	150	-24230#	430#
	Ru	44	30710#	500#	4810#	300#	-2590#	420#	*		5260#	300#	*	
	Rh	45	*		-130#	500#	-1590#	570#	*		13540#	400#	*	
89	Ge	32	5790#	500#	*		-10920#	640#	25260#	400#	*		8920#	450#
	As	33	7320#	300#	32130#	580#	-9370#	420#	21480#	300#	*		9020#	300#
	Se	34	8709	4	29490#	300#	-8294	5	17543	4	-26140#	400#	3652	5
	Br	35	10525	5	27234	4	-7510	4	13438	6	-24840#	200#	3346	4
	Kr	36	11968.9	2.2	24688	3	-6547	3	9673.2	2.1	-19941	4	-1998.1	2.1
	Rb	37	13257	5	22399	6	-5562	6	5996	6	-18285	6	-1862	5
	Sr	38	17471.58	0.09	20077.44	0.26	-7153.6	2.0	-1333	3	-13806.7	2.6	-9981.3	1.5
	Y	39	20832.6	2.0	17688.5	1.6	-7965.9	1.6	-7083	24	-12388.3	1.6	-12151	6
	Zr	40	21671	5	14573	3	-6197	4	-9861	5	-4243	3	-16770	60
	Nb	41	22893	25	12185	24	-5210	30	-13230	24	-3615	24	-16010	24
	Mo	42	24273	5	10246	6	-4265	8	-16760#	300#	1325	7	-21400	150
	Tc	43	25847	6	8098	8	-3540	6	-21530#	360#	1490	60	-21130#	300#
	Ru	44	28880#	500#	5950#	300#	-3180#	300#	*		7140#	300#	-29470#	500#
	Rh	45	*		2750#	360#	-2440#	540#	*		8530#	390#	*	

Table III. Nuclear-reaction and separation energies (continued, Explanation of Table on p. 030003-98)

A	Elt.	Z	S(2n)		S(2p)		Q(α)		Q(2 β^-)		Q(ϵp)		Q($\beta^- n$)	
90	Ge	32	5230#	640#	*	*		26580#	600#	*		9510#	580#	
	As	33	6750#	450#	*		-9680#	570#	22670#	400#	*		9590#	400#
	Se	34	8060	330	30240#	520#	-8830	550	19160	330	-29360#	520#	4400	330
	Br	35	9427	5	27860#	200#	-7463	5	15364	7	-24490#	300#	4464	4
	Kr	36	11411	3	25653	4	-6881	3	10988.9	2.8	-23256	4	-1318	6
	Rb	37	12898	6	23226	7	-6157	7	7130	7	-18379	7	-1227	6
	Sr	38	14169.1	2.1	20835	3	-5107.4	2.1	2824.4	2.1	-16701	3	-6311.1	1.4
	Y	39	18337.7	2.2	18463.0	1.6	-6172.0	1.6	-3833	4	-12071	6	-9689.8	2.8
	Zr	40	21286	5	15428.86	0.12	-6674.36	0.12	-8600	3	-9852.49	0.15	-16219	24
	Nb	41	22630	60	12940	4	-5803	15	-11937	3	-2242	4	-15718	5
	Mo	42	23629	5	11122	6	-4628	5	-15289	5	-2586	5	-20849	5
	Tc	43	25190	150	9130	60	-4016	6	-19030#	300#	2612	24	-20540#	300#
	Ru	44	26690#	300#	6775	5	-3198	5	-25170#	400#	2842	5	-27090#	360#
	Rh	45	30980#	500#	4600#	340#	-2550#	420#	*		8410#	300#	*	
	Pd	46	*		-50#	500#	-2360#	570#	*		11260#	500#	*	
	91	As	33	6240#	500#	*		-10070#	640#	24210#	400#	*		10830#
Se		34	7730	430	31430#	590#	-8930#	530#	20390	430	-28650#	660#	5350	430
Br		35	8976	5	28890#	300#	-7914	5	16638	9	-27070#	400#	5781	4
Kr		36	10581	3	26560	4	-6973	3	12678	6	-22460	330	319	7
Rb		37	12175	9	24049	8	-6278	8	8606	8	-21034	8	132	8
Sr		38	13586	5	21694	6	-5367	5	4244	5	-15982	6	-5229	6
Y		39	14785.6	2.4	19217	6	-4178.4	1.8	287	3	-14276	7	-5650.1	1.8
Zr		40	19163	3	16264.49	0.14	-5440.42	0.10	-5687	6	-9236.4	2.1	-13305	3
Nb		41	22155	24	13508	3	-6045	3	-10651	4	-7433	3	-14537	5
Mo		42	23337	7	11911	7	-5287	7	-13969	7	-725	6	-19555	6
Tc		43	24734	4	9939	24	-4537	7	-17420#	300#	-614	4	-19174	4
Ru		44	26120#	300#	7803	4	-3780	4	-22310#	400#	4644	4	-24610#	300#
Rh		45	28850#	470#	5750#	300#	-3300#	300#	*		4870#	300#	-26930#	500#
Pd		46	*		2250#	500#	-2840#	570#	*		11670#	400#	*	
92	As	33	5790#	640#	*		*	25250#	500#	*		11530#	660#	
	Se	34	7070#	520#	32080#	640#	-9010#	570#	22050#	400#	*		6310#	400#
	Br	35	8375	7	29480#	400#	-7940#	200#	18540	9	-26630#	400#	6670	7
	Kr	36	9953	3	27550	330	-7310	4	14098	4	-25480	430	904	8
	Rb	37	11551	9	25350	7	-6481	7	10044	11	-20954	7	808	8
	Sr	38	13062	4	22486	4	-5601	4	5592	3	-19182	4	-4587	4
	Y	39	14465	9	20030	11	-4632	9	1637	9	-14360	12	-4992	9
	Zr	40	15829.13	0.15	17088.8	2.1	-2962.33	0.10	-1650.45	0.19	-12096	5	-9892.3	2.9
	Nb	41	19934	4	14537.2	2.4	-4579.2	2.3	-7528	4	-7391.0	2.6	-12316	6
	Mo	42	22779	3	12613.98	0.20	-5605	5	-12507.4	2.7	-6201.98	0.19	-18893.2	2.4
	Tc	43	24344	3	10842	5	-5180	60	-15927	5	423	4	-18757	4
	Ru	44	25560	5	8707	4	-4040	5	-19720#	300#	619	7	-23800#	300#
	Rh	45	27440#	300#	6852	4	-3740	150	-25870#	500#	5699	5	-25140#	400#
	Pd	46	31010#	500#	4270#	300#	-2670#	420#	*		6370#	300#	*	
	Ag	47	*		10#	580#	-2700#	640#	*		14150#	580#	*	
93	Se	34	6280#	590#	*		-9410#	570#	23420#	400#	*		7450#	400#
	Br	35	7930	430	30570#	590#	-8520#	520#	19730	430	-29200#	660#	7810	430
	Kr	36	9305	3	28130	430	-7569	4	15950	8	-24700#	400#	2565	7
	Rb	37	11017	11	26091	9	-6771	8	11607	13	-23676	10	2176	9
	Sr	38	12577	9	23690	8	-5975	8	7036	8	-18605	8	-3341	12
	Y	39	14018	11	21060	13	-4940	12	2986	11	-16744	12	-3839	10
	Zr	40	15369.1	0.5	18048	5	-3337.9	0.5	-315.0	0.5	-11544	3	-8740.1	1.8
	Nb	41	16717	3	15439.5	2.4	-1929.4	2.2	-3606.7	1.8	-9685	9	-8475.6	1.5
	Mo	42	20741	6	13489.44	0.21	-4356	3	-9590.4	2.1	-5637.01	0.21	-15953	3
	Tc	43	23762.1	2.6	11546	3	-5406	24	-14594.3	2.8	-4441.8	2.1	-17376.2	2.9
	Ru	44	25120	3	9586	7	-4627	4	-18220#	300#	2302.9	2.1	-22289	5
	Rh	45	26590#	300#	7603	4	-4042	5	-22740#	400#	2625	4	-22500#	300#
	Pd	46	29210#	500#	5340#	300#	-3170#	420#	*		8010#	300#	-29940#	580#
	Ag	47	*		2280#	500#	-2830#	540#	*		9440#	400#	*	

Table III. Nuclear-reaction and separation energies (continued, Explanation of Table on p. 030003-98)

A	Elt.	Z	S(n)		S(p)		Q(4β ⁻)		Q(d,α)		Q(p,α)		Q(n,α)	
94	Se	34	4160#	640#	*		42040#	500#	4890#	710#	4960#	640#	*	
	Br	35	2580#	530#	13970#	500#	34950#	300#	10040#	500#	8040#	530#	-4860#	500#
	Kr	36	5283	12	15750	430	25922	12	5596	14	4624	13	-5120	430
	Rb	37	4014	8	11716	3	17806.3	2.5	10917	3	7275	3	-1809	4
	Sr	38	6831	8	13515	8	9568.4	1.7	6638	6	3763	8	-2225.3	2.8
	Y	39	6196	12	9555	10	1807	8	11227	7	6165	8	1040	10
	Zr	40	8218.6	0.5	10331	10	-4686	3	8258	9	3946.0	1.9	2029	5
	Nb	41	7227.54	0.08	6536.0	1.5	-13461	4	12800.8	1.5	6390.6	1.5	5628.6	2.4
	Mo	42	9678.31	0.23	8490.2	1.5	-22312	4	8750.0	1.8	3088.0	2.9	5127.90	0.18
	Tc	43	8624	4	4640	4	-31750#	400#	13361	4	2915	7	8126	5
	Ru	44	13438	4	6266	3	-42440#	500#	7053	4	-1733	4	5272	7
	Rh	45	11967	4	2980	4	*		12104	4	196	4	8725	4
	Pd	46	15170#	300#	4379	5	*		7608	6	-2670#	300#	7784	5
	Ag	47	14210#	570#	700#	500#	*		12880#	500#	-1620#	570#	11810#	500#
Cd	48	*		1160#	640#	*		7700#	710#	*		11440#	640#	
95	Se	34	1730#	710#	*		44660#	500#	*		5390#	710#	*	
	Br	35	4440#	420#	14260#	580#	37440#	300#	7660#	500#	7820#	500#	-7140#	580#
	Kr	36	2882	22	16050#	300#	29501	19	7440	430	4938	20	-3790#	400#
	Rb	37	5400	20	11833	24	20895	20	8955	20	7742	20	-4012	21
	Sr	38	4345	6	13846	6	12592	6	8211	10	4517	8	-704	6
	Y	39	6929	9	9652	7	4812	8	9588	10	6523	8	-790	9
	Zr	40	6461.9	0.9	10597	6	-2202	10	9278	11	4021	9	2854	4
	Nb	41	8488.5	1.6	6805.9	0.5	-8446	4	11046.6	0.7	6536.8	0.5	3677	9
	Mo	42	7369.11	0.09	8631.8	1.5	-17746	3	10211.8	1.5	3605.5	1.8	6393.57	0.16
	Tc	43	9934	7	4896	5	-26420#	300#	11497	5	5651	5	6078	5
	Ru	44	8945	10	6588	10	-36830#	400#	10859	10	332	10	8997	10
	Rh	45	13504	5	3046	5	*		9587	4	825	5	6231	5
	Pd	46	11935	5	4347	5	*		9757	4	-2103	5	9982	4
	Ag	47	15260#	500#	780#	300#	*		10120#	420#	-150#	420#	9050#	300#
Cd	48	14560#	640#	1510#	570#	*		10350#	570#	-4640#	640#	13600#	500#	
96	Br	35	2460#	420#	14990#	580#	40170#	300#	9350#	580#	7420#	500#	*	
	Kr	36	4992	28	16600#	300#	32359	20	5030#	300#	4670	430	-6720#	400#
	Rb	37	3534	20	12484	19	24248	3	10704	13	7646	4	-2820	430
	Sr	38	5876	10	14322	22	15871	8	6349	9	4560	12	-3142	9
	Y	39	5198	9	10505	8	7486	8	11221	6	6614	10	-70	10
	Zr	40	7850.2	0.9	11519	7	641.53	0.14	7623	6	3652	10	293	8
	Nb	41	6887.9	0.5	7231.8	0.9	-5915	10	12377.31	0.22	6383.3	0.5	4271	10
	Mo	42	9154.33	0.05	9297.6	0.5	-12611	4	8285.0	1.5	3282.0	1.5	3973.6	0.5
	Tc	43	7872	7	5399	5	-21310	90	13303	5	5849	5	7038	5
	Ru	44	10694	10	7348	5	-30510#	400#	8789	4	2389.8	1.0	6373.10	0.25
	Rh	45	9418	11	3519	14	-41800#	500#	13607	10	2393	10	9565	10
	Pd	46	14289	5	5132	6	*		7435	5	-2308	5	6680	5
	Ag	47	12990#	310#	1830	90	*		12300	90	-650#	310#	10150	90
	Cd	48	17010#	570#	3270#	500#	*		7550#	570#	-4440#	570#	9070#	500#
In	49	*		-1450#	640#	*		12960#	710#	*		14020#	640#	

Table III. Nuclear-reaction and separation energies (continued, Explanation of Table on p. 030003-98)

A	Elt.	Z	S(2n)		S(2p)		Q(α)		Q($2\beta^-$)		Q(ϵp)		Q($\beta^- n$)	
94	Se	34	6220#	640#	*		-10010#	710#	24540#	500#	*		8020#	660#
	Br	35	7310#	300#	31000#	580#	-8500#	500#	21160#	300#	*		8670#	300#
	Kr	36	8721	12	29200#	400#	-7970	330	17498	12	-27920#	400#	3201	14
	Rb	37	9933	6	26908	7	-6987	4	13789	7	-22960	430	3452	8
	Sr	38	12121	4	24654	3	-6311.4	2.5	8423.6	1.7	-21999	3	-2690	11
	Y	39	13678	11	22157	9	-5412	9	4018	7	-17021	10	-3301	6
	Zr	40	14952.93	0.19	18980	3	-3746.1	2.1	1144.74	0.22	-14472	8	-8127.8	1.5
	Nb	41	16058.4	2.0	16131	9	-2299.9	2.2	-2211	4	-9431	11	-7633.3	1.5
	Mo	42	17748.12	0.21	14532.98	0.17	-2066.45	0.18	-5830	3	-8581.0	0.5	-12879.3	1.0
	Tc	43	21375	5	12283	4	-3922	5	-11251	5	-4234	4	-15013	5
	Ru	44	24425	4	10353	3	-4836	5	-16481	5	-3065	3	-21643	4
	Rh	45	26051	6	8560	5	-4608	4	-20500#	400#	3410	4	-21980#	300#
	Pd	46	27670#	300#	6379	5	-3643	6	-25960#	500#	3825	5	-27910#	400#
	Ag	47	31420#	640#	3990#	400#	-3140#	500#	*		9310#	400#	*	
Cd	48	*		140#	580#	-2860#	640#	*		11570#	580#	*		
95	Se	34	5890#	640#	*		*		25700#	500#	*		8870#	580#
	Br	35	7020#	520#	*		-9300#	500#	22120#	300#	*		9510#	300#
	Kr	36	8166	19	30020#	400#	-8000	430	18961	20	-26650#	500#	4333	19
	Rb	37	9414	22	27580	430	-7209	21	15317	21	-25780#	300#	4883	20
	Sr	38	11176	10	25561	6	-6571	6	10540	6	-21061	13	-839	9
	Y	39	13124	12	23167	10	-5889	10	5577	7	-19935	7	-2011	7
	Zr	40	14680.5	1.0	20152	8	-4433	6	2051.9	0.9	-14103.2	1.9	-7362.2	1.7
	Nb	41	15716.1	1.6	17137	11	-2859.9	1.9	-765	5	-11724	6	-6443.5	0.5
	Mo	42	17047.42	0.22	15167.8	0.5	-2241.21	0.16	-4254	10	-7731.51	0.20	-11625	4
	Tc	43	18558	5	13386	5	-1808	6	-7681	6	-6941	5	-11509	6
	Ru	44	22384	10	11229	10	-3674	11	-13492	10	-2333	10	-18621	10
	Rh	45	25471	5	9312	4	-4779	5	-18740#	300#	-1471	6	-20310	6
	Pd	46	27110#	300#	7327	4	-4151	4	-23340#	400#	5329	4	-25630#	400#
	Ag	47	29470#	500#	5160#	300#	-3450#	420#	*		6020#	300#	-27530#	580#
Cd	48	*		2210#	500#	-3130#	570#	*		12180#	400#	*		
96	Br	35	6910#	420#	*		-9610#	580#	23190#	300#	*		9920#	300#
	Kr	36	7875	24	30850#	500#	-8780#	400#	19844	22	-29910#	500#	4740	29
	Rb	37	8934	4	28530#	300#	-7546	7	16982	7	-24870#	300#	5694	7
	Sr	38	10221	9	26154	15	-6580	9	12515	8	-24054	20	213	11
	Y	39	12127	9	24351	6	-5988	9	7267	6	-19733	21	-747	6
	Zr	40	14312.16	0.20	21171.1	1.7	-4996	3	3356.03	0.07	-17608	6	-6723.9	0.5
	Nb	41	15376.4	1.5	17829	6	-3211	9	219	5	-11683	7	-5962.28	0.12
	Mo	42	16523.45	0.10	16103.49	0.20	-2760.76	0.16	-2714.50	0.12	-10423.9	0.9	-10845	5
	Tc	43	17806	7	14031	5	-1793	5	-6134	11	-6324	5	-10435	11
	Ru	44	19639	3	12244.25	0.16	-1696.71	0.23	-9897	4	-5657.48	0.13	-15811	4
	Rh	45	22923	11	10107	11	-3187	10	-15180	90	-955	11	-17793	10
	Pd	46	26224	6	8178	5	-4307	5	-20610#	400#	-15	10	-24660#	300#
	Ag	47	28250#	410#	6180	90	-3940	90	-26620#	510#	6540	90	-25950#	410#
	Cd	48	31580#	640#	4050#	400#	-3420#	500#	*		7100#	400#	*	
In	49	*		60#	640#	-3190#	710#	*		14420#	580#	*		

Table III. Nuclear-reaction and separation energies (continued, Explanation of Table on p. 030003-98)

A	Elt.	Z	S(n)	S(p)	$Q(4\beta^-)$	$Q(d,\alpha)$	$Q(p,\alpha)$	$Q(n,\alpha)$						
97	Br	35	3960#	500#	*	42070#	400#	7120#	640#	7610#	640#	*		
	Kr	36	2420	130	16550#	330#	35520	130	7060#	330#	4840#	330#	-4970#	520#
	Rb	37	5236	4	12728	21	27087	5	8351	19	7693	12	-5470#	300#
	Sr	38	3729	9	14516	5	18963	3	8021	21	4845	4	-1587	13
	Y	39	5857	9	10486	11	11103	8	9709	9	7588	7	-1912	7
	Zr	40	5575.1	0.4	11896	6	3177.9	2.8	8977	7	4273	6	1549.5	1.7
	Nb	41	8074	4	7456	4	-3010	40	10765	4	6528	4	2392	8
	Mo	42	6821.13	0.16	9230.85	0.19	-9739	5	9952.4	0.5	3688.4	1.5	5371.03	0.23
	Tc	43	9474	7	5719	4	-16400	110	11198	4	6054	4	4791	4
	Ru	44	8111.5	2.8	7588	6	-25670#	300#	10612	6	2902	5	7939.9	2.8
	Rh	45	10980	40	3810	40	-35410#	400#	11570	40	4850	40	7210	40
	Pd	46	9694	6	5407	11	*		11246	6	-34	6	10424	6
	Ag	47	14390	140	1930	110	*		9850	110	140	110	7730	110
	Cd	48	12950#	500#	3230#	310#	*		9850#	420#	-3180#	500#	11300#	300#
In	49	17370#	640#	-1090#	570#	*		10150#	570#	-2190#	640#	10870#	570#	
98	Br	35	2270#	570#	*	44040#	400#	*		7070#	640#	*		
	Kr	36	4960#	330#	17550#	500#	36980#	300#	4560#	420#	4320#	420#	-8210#	580#
	Rb	37	3921	16	14230	130	29155	17	9421	26	6654	25	-4950#	300#
	Sr	38	5913	5	15193	4	21693	3	5642	5	4332	21	-4618	19
	Y	39	4245	10	11002	9	14137	9	11340	12	7689	10	-757	22
	Zr	40	6415	8	12454	11	6938	11	7760	10	4786	11	-521	10
	Nb	41	5990	7	7871	5	-349	13	12625	5	6999	5	3331	8
	Mo	42	8642.60	0.06	9799	4	-6795	5	8197.65	0.20	3534.3	0.5	3190.4	0.9
	Tc	43	7279	5	6176	3	-13370	30	13073	3	6144	3	6000	3
	Ru	44	10176	7	8289	8	-20590	50	8308	8	2661	8	5133	6
	Rh	45	8650	40	4344	12	-29280#	300#	13616	12	5147	15	8493	13
	Pd	46	11586	7	6010	40	*		9078	11	1884	6	7783	11
	Ag	47	10310	110	2550	30	*		13830	30	1760	30	10920	30
	Cd	48	15250#	300#	4100	120	*		7590	100	-3180#	300#	7980	50
In	49	14780#	500#	730#	420#	*		12390#	500#	-2400#	500#	11350#	420#	
99	Kr	36	2520#	500#	17800#	570#	38860#	400#	6010#	570#	4270#	500#	*	
	Rb	37	4823	17	14100#	300#	31214	13	7010	130	6823	21	-7310#	300#
	Sr	38	4170	6	15441	17	23449	5	6709	5	3697	6	-3795	21
	Y	39	6426	10	11516	7	16678	7	8642	7	7138	11	-3649	7
	Zr	40	4405	13	12615	13	10005	11	9212	12	5579	12	950	13
	Nb	41	6882	13	8338	15	3246	14	11318	12	7968	12	1647	13
	Mo	42	5925.44	0.15	9734	5	-3787	5	10346	4	4496.77	0.25	5115.15	0.23
	Tc	43	8967	3	6500.9	0.9	-10615	6	10927.6	0.9	6331.1	0.9	3921.4	0.9
	Ru	44	7472	6	8482	3	-17694.3	1.6	10310	4	3060	5	6815.9	0.4
	Rh	45	10477	14	4645	9	-24210#	300#	11250	7	5363	7	5887	8
	Pd	46	8933	7	6296	13	-34240#	500#	11130	40	2369	11	9544	5
	Ag	47	11720	30	2680	8	*		11804	8	4335	8	8622	12
	Cd	48	10370	50	4150	30	*		11610	110	-560	90	11899	4
	In	49	15550#	420#	1030#	300#	*		9790#	420#	-940#	500#	8780#	310#
Sn	50	*		1340#	590#	*		9960#	640#	-5190#	710#	13280#	640#	

Table III. Nuclear-reaction and separation energies (continued, Explanation of Table on p. 030003-98)

A	Elt.	Z	S(2n)		S(2p)		Q(α)		Q(2 β^-)		Q(ϵp)		Q($\beta^- n$)	
97	Br	35	6430#	500#	*	*	*	24460#	400#	*		10950#	400#	
	Kr	36	7410	130	31540#	520#	-9130#	420#	21160	130	*		5860	130
	Rb	37	8770	20	29330#	300#	-8050	430	17602	7	-27650#	300#	6334	9
	Sr	38	9605	7	27000	19	-6870	4	14361	3	-22791	21	1683	7
	Y	39	11055	10	24808	21	-5926	10	9484	8	-22056	8	1246	7
	Zr	40	13425.4	1.0	22401	6	-5282	8	4602.0	0.4	-17307	8	-5411.2	0.4
	Nb	41	14962	4	18975	8	-3804	11	1619	6	-14559	7	-4882	4
	Mo	42	15975.47	0.17	16462.7	0.9	-2847.6	0.5	-1424.1	2.8	-9394.82	0.17	-9794	5
	Tc	43	17346	7	15016	4	-2437	4	-4630	40	-8911	4	-9215	4
	Ru	44	18805	10	12986.6	2.8	-1738.4	2.8	-8315	6	-4614.6	2.8	-14504	10
	Rh	45	20400	40	11150	40	-1420	40	-11770	120	-4060	40	-14490	40
	Pd	46	23983	6	8926	11	-3014	5	-17350#	300#	986	5	-21370	90
	Ag	47	27370#	320#	7060	110	-4240	110	-23640#	420#	1570	110	-23320#	420#
	Cd	48	29970#	500#	5070#	300#	-3880#	420#	*		8440#	300#	-30640#	580#
In	49	*		2170#	500#	-3350#	570#	*		10030#	410#	*		
98	Br	35	6230#	500#	*	*	*	26120#	400#	*		11100#	420#	
	Kr	36	7370#	300#	*		-9930#	580#	22110#	300#	*		6140#	300#
	Rb	37	9157	16	30780#	300#	-9390#	300#	17926	18	-27600#	400#	6141	16
	Sr	38	9642	9	27921	21	-7500	13	14864	9	-26290	130	1627	7
	Y	39	10102	10	25518	9	-6157	8	11230	9	-21065	8	2577	8
	Zr	40	11990	8	22940	12	-4866	9	6829	8	-19994	9	-3752	9
	Nb	41	14064	5	19767	8	-3598	8	2908	6	-14692	8	-4051	5
	Mo	42	15463.73	0.17	17255.07	0.18	-3271.57	0.24	109	6	-12462.3	0.4	-8963	4
	Tc	43	16753	6	15407	3	-2488	4	-3257	12	-8115	5	-8383	4
	Ru	44	18287	6	14008	6	-2236	6	-6904	8	-7969	6	-13700	40
	Rh	45	19630	16	11932	13	-1442	13	-10110	30	-3240	13	-13441	13
	Pd	46	21280	6	9819	5	-1162	6	-13680	50	-2489	5	-18570	110
	Ag	47	24700	100	7960	30	-2580	30	-19170#	300#	2240	50	-20680#	300#
	Cd	48	28210#	400#	6030	50	-3960	50	*		2880	50	-28520#	400#
In	49	32150#	580#	3960#	310#	-3910#	500#	*		9640#	320#	*		
99	Kr	36	7480#	420#	*		-10730#	640#	23760#	400#	*		7540#	400#
	Rb	37	8745	4	31640#	400#	-9780#	300#	19529	8	-30160#	400#	7231	5
	Sr	38	10083	6	29680	130	-8787	19	15099	12	-25500#	300#	1702	9
	Y	39	10671	9	26709	7	-7183	21	11686	14	-23570	17	2566	11
	Zr	40	10821	10	23617	11	-4926	12	8349	11	-18486	11	-2167	12
	Nb	41	12872	13	20792	14	-3551	14	4993	12	-17330	14	-2291	12
	Mo	42	14568.04	0.16	17605.4	0.5	-2735.1	0.9	1655.3	0.4	-11972	8	-7609	3
	Tc	43	16246	4	16300	4	-2966.5	1.0	-1747	7	-11092	5	-7174	7
	Ru	44	17647.5	2.8	14658.6	0.4	-2338.4	0.4	-5443	5	-6798.4	0.4	-12521	12
	Rh	45	19130	40	12935	8	-1985	8	-8869	9	-6438	7	-12332	8
	Pd	46	20519	7	10640	6	-1150	11	-12252	5	-1247	8	-17190	30
	Ag	47	22030	110	8690	40	-797	7	-15340#	300#	-826	13	-17150	50
	Cd	48	25620#	300#	6703	5	-2390	3	-21990#	500#	4101	5	-24110#	300#
	In	49	30330#	500#	5130#	320#	-4200#	420#	*		4400#	300#	*	
Sn	50	*		2070#	590#	-3740#	640#	*		12400#	510#	*		

Table III. Nuclear-reaction and separation energies (continued, Explanation of Table on p.030003-98)

A	Elt.	Z	S(2n)	S(2p)	Q(α)	Q($2\beta^-$)	Q(ϵp)	Q($\beta^- n$)						
100	Kr	36	6880#	500#	*	*	24770#	400#	*	8000#	400#			
	Rb	37	8021	25	32580#	400#	-10510#	300#	21080	23	*	8203	20	
	Sr	38	9540	8	30090#	300#	-9166	22	16557	11	-28350#	400#	2758	10
	Y	39	11175	14	27536	20	-8398	12	12470	14	-23495	12	2222	15
	Zr	40	11233	12	24532	9	-5878	12	9816	8	-21145	9	-2113	15
	Nb	41	12415	9	22081	11	-3886	10	6224	8	-16437	10	-1899	8
	Mo	42	14219.7	0.3	19484	8	-3179.1	0.3	3034.36	0.17	-15861	11	-6936.5	0.9
	Tc	43	15731	4	17074	5	-2843.0	1.4	-430	18	-10975	12	-6466.9	1.4
	Ru	44	17145	6	15689.4	0.4	-2857.4	0.4	-4015	18	-10546.3	0.4	-11717	7
	Rh	45	18559	22	13737	18	-2194	19	-7453	19	-5552	18	-11480	19
	Pd	46	20034	18	11566	19	-1557	18	-11018	18	-4876	18	-16572	19
	Ag	47	21210	30	9541	13	-875	11	-13820	180	154	8	-16278	5
Cd	48	22700	50	7452	5	-436	5	-16910	300	699	5	-20890#	300#	
In	49	26560#	350#	5820	190	-2230	200	*	*	5110	180	-24440#	540#	
Sn	50	*	*	4220	310	-4140#	500#	*	*	5360	300	*	*	
101	Kr	36	6510#	640#	*	*	26200#	500#	*	*	9050#	500#		
	Rb	37	7870#	200#	*	-11210#	450#	22220#	200#	*	*	8910#	200#	
	Sr	38	8946	10	31140#	400#	-10330	130	17841	12	-27560#	400#	3931	14
	Y	39	10554	10	28518	8	-8967	7	13830	8	-26103	21	3245	11
	Zr	40	11688	13	25222	10	-7009	9	10354	8	-20634	11	-1440	12
	Nb	41	12699	13	22820	8	-5195	8	7453	24	-18853	12	-770	4
	Mo	42	13692.5	0.4	20477	11	-3002.2	0.5	4438.16	0.30	-14431	8	-5570.3	1.4
	Tc	43	15159	24	18587	27	-3164	24	1068	25	-13836	25	-5189	24
	Ru	44	16475.37	0.24	16566.0	0.5	-2838.3	0.4	-2526	5	-9054.06	0.29	-10438	18
	Rh	45	17974	9	14662	6	-2613	7	-6078	8	-8680	6	-10271	19
	Pd	46	19392	7	12385	5	-1736	5	-9596	5	-3494	5	-15365	7
	Ag	47	20765	8	10331	8	-1160	40	-12720#	200#	-3032	19	-15211	5
Cd	48	22048.0	2.2	8232	5	-456	5	-15530	300	2087	18	-19590	180	
In	49	23380#	360#	6480#	200#	-210#	220#	*	*	2240#	200#	-19400#	360#	
Sn	50	28500#	590#	4950	300	-2280#	420#	*	*	6600	300	*	*	
102	Rb	37	7600#	300#	*	-11880#	500#	23470#	300#	*	*	9550#	300#	
	Sr	38	8480	70	31690#	410#	-10270#	310#	19430	70	-30320#	510#	4830	70
	Y	39	9988	12	29504	20	-9229	17	15131	5	-25620#	200#	3921	9
	Zr	40	11353	12	26345	11	-7590	9	11978	12	-23552	12	-768	10
	Nb	41	12650	8	23555	11	-6435	8	8268	10	-18533	8	-855.9	2.6
	Mo	42	13516	8	21767	12	-4704	12	5540	8	-17689	12	-5293	25
	Tc	43	14695	9	19353	12	-3473	10	2210	11	-12970	10	-4686	9
	Ru	44	16021.68	0.24	17491.35	0.29	-3415.4	0.5	-1203.3	0.4	-12875.5	0.3	-9765	6
	Rh	45	17335	19	15340	7	-2776	7	-4537	10	-7728	25	-9423	8
	Pd	46	18833	18	13253.7	0.4	-2103	6	-8243.5	1.8	-7234.0	0.4	-14640	5
	Ag	47	20251	10	11234	20	-1496	14	-11552	9	-2123	10	-14482	8
	Cd	48	21607.7	2.4	9025	18	-764	5	-14720	100	-1517	5	-19120#	200#
In	49	22520	180	7135	7	-50	30	*	*	3351	7	-18460	300	
Sn	50	23790	320	5320	100	280	110	*	*	3610	100	*	*	
103	Rb	37	6910#	450#	*	*	24850#	400#	*	*	10480#	410#		
	Sr	38	8240#	200#	32870#	540#	-11090#	450#	20390#	200#	*	*	5680#	200#
	Y	39	9539	13	30190#	200#	-9761	12	16571	12	-28040#	300#	5059	14
	Zr	40	10792	12	27068	13	-7719	10	13145	13	-22950	70	418	10
	Nb	41	12280	5	24546	8	-6804	8	9575	11	-21144	6	466	9
	Mo	42	13583	9	22373	12	-5765	14	6307	9	-16662	13	-4459	13
	Tc	43	14402	26	20290	10	-4693	15	3428	10	-15588	10	-3569	10
	Ru	44	15451.69	0.16	18325.2	0.3	-3722.0	0.5	190.0	0.9	-10990	8	-8555	6
	Rh	45	16762	6	16265	24	-3128.8	2.5	-3229	5	-10748	9	-8199.9	2.3
	Pd	46	18168	5	14077.0	0.9	-2256.7	0.9	-6805.6	2.0	-5639.7	0.9	-13282	8
	Ag	47	19611	6	11968	7	-1646	8	-10170	10	-5308	8	-13214	4
	Cd	48	20957.8	2.3	9797	5	-894	5	-13680	70	-37.4	1.9	-18028	5
In	49	22160#	200#	7876	11	-345	11	-18450#	300#	325	13	-17770	100	
Sn	50	22810	310	5710	70	530	70	*	*	5400	70	*	*	
Sb	51	*	*	2140#	360#	2770#	420#	*	*	7230#	300#	*	*	

Table III. Nuclear-reaction and separation energies (continued, Explanation of Table on p. 030003-98)

A	Elt.	Z	S(n)	S(p)	$Q(4\beta^-)$	$Q(d,\alpha)$	$Q(p,\alpha)$	$Q(n,\alpha)$						
104	Sr	38	4760#	360#	17790#	500#	36240#	300#	4310#	420#	3600#	360#	-9330#	590#
	Y	39	3680#	400#	13930#	450#	28440#	400#	8810#	410#	6130#	400#	-5570#	450#
	Zr	40	5980	13	14555	15	22372	10	6160	10	4201	12	-4753	13
	Nb	41	4862	5	11293	10	15140	4	10480	9	6211	9	-1112	8
	Mo	42	7461	13	12610	10	9045	9	6665	9	3406	10	-1538	12
	Tc	43	5971	27	8832	27	2613	25	11773	26	5881	25	2034	25
	Ru	44	8899.9	2.5	10781	9	-4127	3	7188	9	3113	24	1070.6	2.5
	Rh	45	6998.96	0.08	6981.1	2.3	-10777	6	12857.9	2.3	5862.8	2.3	5032	24
	Pd	46	10009.2	1.6	8652.4	2.7	-17768	6	8099	7	2881	6	4209.4	1.4
	Ag	47	8385	6	4948	4	-25940	120	13498	4	5180	6	7942	7
	Cd	48	11388.1	2.5	6455	4	*	*	8989	8	2230	5	7110	5
	In	49	9621	11	2820	6	*	*	14188	6	4518	6	10798	8
	Sn	50	12730	70	4283	11	*	*	9779	7	1850#	200#	9856	6
	Sb	51	11070#	320#	-510	100	*	*	16470	160	6000	320	15090#	230#
105	Sr	38	2580#	590#	*		38730#	500#	5710#	640#	3960#	590#	*	
	Y	39	5280#	1400#	14450#	1370#	31020	1340	6860#	1350#	5750	1340	-7920#	1370#
	Zr	40	3812	15	14690#	400#	24470	12	7704	17	4572	13	-3660	70
	Nb	41	6168	5	11480	10	17936	5	8611	10	6536	10	-3096	6
	Mo	42	5058	13	12807	9	11081	9	8402	10	3831	9	-103	13
	Tc	43	7860	40	9230	40	4780	40	9380	40	6140	40	-340	40
	Ru	44	5910.10	0.11	10720	25	-1600.7	2.9	9380	9	3502	9	3278	9
	Rh	45	8963	3	7044.5	2.9	-8211	11	10126.7	2.5	6119.2	2.5	2368	9
	Pd	46	7094.1	0.7	8747.5	2.6	-15080	4	10324.6	2.6	3229	7	6335.0	1.2
	Ag	47	10026	6	4965	5	-23055	22	11097	5	5696	5	5359	8
	Cd	48	8436.8	2.2	6506	4	-31520	300	11180	4	2777	8	9215.7	1.5
	In	49	11529	12	2961	10	*	*	11722	10	4883	10	8253	13
	Sn	50	9782	7	4444	7	*	*	12005	10	2221	6	11968	4
	Sb	51	12910	120	-323	22	*	*	13670	70	5780	100	12326	22
Te	52	*		930	320	*	*	14080#	420#	*		17770	320	
106	Sr	38	4250#	780#	*		41340#	600#	*		3680#	720#	*	
	Y	39	2850#	1430#	14730#	710#	33720#	500#	8760#	590#	6230#	540#	-6800#	640#
	Zr	40	5160	430	14570	1410	27770	430	6230#	590#	4770	430	-5480#	480#
	Nb	41	4359	6	12028	13	20159	7	10232	10	6476	10	-2099	12
	Mo	42	6869	13	13508	10	13773	9	6395	10	3758	10	-2673	13
	Tc	43	5560	40	9728	15	7166	13	11285	15	6049	15	899	13
	Ru	44	8460	5	11320	40	809	5	6891	25	3145	11	284	11
	Rh	45	6583	6	7717	5	-5754	13	12444	5	5769	5	3888	11
	Pd	46	9560.96	0.28	9345.3	2.4	-12554	5	7762.6	2.6	2988.2	2.6	3006.0	1.2
	Ag	47	7943	5	5813.5	2.8	-20469	8	13163.5	2.9	5379	3	6736	4
	Cd	48	10869.6	1.8	7350	5	-28910	100	8695	4	2535	4	5971.5	1.5
	In	49	9039	16	3563	12	*	*	14071	12	4908	12	9841	13
	Sn	50	12087	6	5002	11	*	*	9540	8	2143	11	8944	5
	Sb	51	10529	23	424	8	*	*	15865	9	5360	70	13806	12
Te	52	13480	320	1490	100	*	*	11660	160	2820#	320#	14400	120	

Table III. Nuclear-reaction and separation energies (continued, Explanation of Table on p. 030003-98)

A	Elt.	Z	S(2n)		S(2p)		Q(α)		Q($2\beta^-$)		Q(ϵp)		Q($\beta^- n$)	
104	Sr	38	8090#	310#	*		-11480#	500#	21620#	300#	*		6280#	300#
	Y	39	9030#	400#	30940#	500#	-10240#	400#	17760#	400#	-27750#	570#	5680#	400#
	Zr	40	10279	13	28140	70	-8328	12	14626	13	-25590#	200#	1233	10
	Nb	41	11657	4	25224	5	-6917	11	10684	25	-20650	12	1070	10
	Mo	42	12927	12	23340	12	-6397	12	7746	9	-19824	13	-3817	13
	Tc	43	14073	26	20777	25	-5131	26	4456	25	-14764	25	-3308	25
	Ru	44	15131.9	2.5	19108	9	-4327.6	2.5	1299.4	2.7	-14424	10	-8135	3
	Rh	45	16319	7	16964	9	-3363.3	2.7	-1843	5	-9644	10	-7573.5	2.4
	Pd	46	17634.6	1.4	14866.6	1.4	-2592.6	1.4	-5426.7	2.1	-9416.9	1.4	-12664	4
	Ag	47	19012	9	12911	8	-1950	19	-8934	7	-4374	5	-12536	5
	Cd	48	20451.3	2.4	10643.2	1.8	-1181	18	-12341	6	-3800.2	1.9	-17407	10
	In	49	21630	7	8514	10	-470	8	-17010	120	1331	7	-17280	70
	Sn	50	22830	100	6545	6	143	6	*		1736	6	-23520#	300#
	Sb	51	*		3060	120	2710	220	*		8170	120	*	
105	Sr	38	7330#	540#	*		-11910#	710#	22850#	500#	*		7380#	640#
	Y	39	8960	1340	32240#	1400#	-10850#	1350#	18650	1340	*		6380	1340
	Zr	40	9792	15	28620#	200#	-8565	15	15872	15	-24650#	300#	2283	12
	Nb	41	11030	6	26036	12	-7279	8	12370	40	-23140#	400#	2363	10
	Mo	42	12519	13	24100	13	-6596	12	8597	9	-18902	13	-2905	26
	Tc	43	13830	40	21840	40	-5820	40	5560	40	-17760	40	-2270	40
	Ru	44	14810.0	2.5	19552	10	-4839.5	2.5	2483.4	2.6	-12873	9	-7046	3
	Rh	45	15962	3	17825	10	-3932	24	-780	5	-12637	25	-6527.5	2.4
	Pd	46	17103.3	1.5	15728.7	1.2	-2884.7	1.2	-4084.0	1.8	-7611.1	2.6	-11373	4
	Ag	47	18411	6	13617	5	-2083	7	-7430	11	-7400	5	-11174	5
	Cd	48	19824.9	2.3	11454.6	1.7	-1327	5	-10996	4	-2227.7	1.9	-16222	6
	In	49	21151	14	9416	11	-731	11	-15625	24	-1813	11	-16085	12
	Sn	50	22510	70	7264	4	74	4	-20530	300	3341	4	-22240	120
	Sb	51	23980#	300#	3961	24	2170#	200#	*		4878	23	*	
Te	52	*		420	310	5069	3	*		11530	300	*		
106	Sr	38	6830#	670#	*		*		23760#	740#	*		8410#	1470#
	Y	39	8130#	640#	*		-10770#	590#	20150#	500#	*		7340#	500#
	Zr	40	8970	430	29020#	530#	-8820	440	17580	430	-27230#	660#	3290	430
	Nb	41	10527	5	26720#	400#	-7455	6	13573	13	-22220	1340	3062	10
	Mo	42	11927	13	24988	13	-6972	13	10189	11	-21959	15	-1920	40
	Tc	43	13415	28	22535	13	-5897	13	6586	11	-17150	13	-1913	12
	Ru	44	14370	5	20551	10	-5182	10	3584	5	-16275	11	-6543	6
	Rh	45	15546	6	18437	25	-4215	10	580	6	-11360	40	-6016	5
	Pd	46	16655.1	0.8	16389.8	2.6	-3226.0	1.2	-2775.39	0.10	-11262.0	2.6	-10908	5
	Ag	47	17969	5	14561	4	-2584	7	-6334	12	-6380	4	-10680	3
	Cd	48	19306.4	2.0	12315.0	0.8	-1653.9	1.2	-9778	5	-6003.2	0.3	-15563	10
	In	49	20568	14	10070	13	-786	15	-14135	14	-826	13	-15341	13
	Sn	50	21869	8	7963	5	-119	5	-19130	100	-309	5	-21410	22
	Sb	51	23440	120	4869	9	1797	9	*		5878	13	-21730	300
Te	52	*		1170	100	4290	9	*		7830	100	*		

Table III. Nuclear-reaction and separation energies (continued, Explanation of Table on p. 030003-98)

A	Elt.	Z	S(n)	S(p)	Q($4\beta^-$)	Q(d, α)	Q(p, α)	Q(n, α)						
107	Sr	38	2180#	920#	*	43650#	700#	*	*	*	*	*		
	Y	39	4380#	710#	14860#	780#	36390#	500#	6960#	710#	6610#	590#	*	
	Zr	40	3900	1200	15620#	1230#	29480	1120	7600	1750	4550#	1190#	-4630#	1160#
	Nb	41	5592	9	12460	430	23140	14	8452	15	6864	12	-4010#	400#
	Mo	42	4488	13	13637	10	15821	9	8075	10	4132	10	-1181	13
	Tc	43	7045	15	9904	13	9657	9	9298	13	6464	12	-1285	9
	Ru	44	5611	10	11375	15	3128	9	9140	40	3505	26	2134	12
	Rh	45	8572	13	7829	13	-3299	16	9782	12	6096	12	1286	28
	Pd	46	6536.4	0.5	9299	5	-9860	5	10189.4	2.4	3450.8	2.6	5369.5	2.6
	Ag	47	9536	4	5788.1	2.3	-17753	5	10722.0	2.3	5852.5	2.4	4199	3
	Cd	48	7929.4	1.9	7337	3	-26450	70	10791	5	2990	5	8051.2	2.1
	In	49	11027	17	3721	11	-34140#	300#	11480	11	5268	11	7199	12
	Sn	50	9230	7	5193	13	*	*	11839	12	2534	8	11103	6
	Sb	51	12251	9	589	7	*	*	13396	6	5838	7	11176	7
Te	52	10390	120	1360	70	*	*	14190	70	3500	100	16730	70	
I	53	*	*	-1500#	320#	*	*	14090#	420#	*	*	15390#	320#	
108	Y	39	3000#	780#	15690#	920#	38630#	600#	8200#	850#	6180#	780#	*	*
	Zr	40	5050#	1190#	16280#	640#	32310#	400#	5410#	640#	4780#	1400#	-7100#	640#
	Nb	41	3893	11	12460	1120	25486	16	9720	430	6783	15	-2630	1340
	Mo	42	6276	13	14321	12	18768	9	6158	10	4024	10	-3645	15
	Tc	43	5244	12	10660	13	11684	9	10923	13	6278	13	-361	10
	Ru	44	7870	12	12200	12	5591	9	6826	15	3490	40	-678	13
	Rh	45	6239	18	8458	16	-912	16	12002	15	5767	14	2900	40
	Pd	46	9222.9	1.6	9949	12	-7454	5	7549	6	3191.1	2.7	2056.7	2.7
	Ag	47	7271.41	0.17	6523.1	2.3	-15161	6	13011.6	2.3	5675.2	2.3	5891	3
	Cd	48	10333.5	2.0	8134.7	2.6	-23471	6	8401	3	2682	5	4811.9	1.6
	In	49	8627	14	4419	9	-31470	130	13723	9	5078	9	8597	10
	Sn	50	11629	8	5795	12	*	*	9249	13	2435	12	7910	6
	Sb	51	9863	7	1222	8	*	*	15619	7	5757	7	12842	12
	Te	52	13310	70	2417	7	*	*	11402	9	3098	21	13203	7
I	53	11290#	330#	-600	110	*	*	16280	170	5030	330	17010	130	
109	Y	39	3980#	920#	*	41080#	700#	6410#	990#	6450#	920#	*	*	
	Zr	40	2910#	640#	16190#	780#	34550#	500#	6880#	710#	4720#	710#	-5760#	780#
	Nb	41	5220	260	12630#	480#	28310	260	8400	1150	6720	500	-4990#	570#
	Mo	42	3981	14	14409	14	20940	11	7769	14	4401	12	-2470	430
	Tc	43	6431	13	10816	13	14437	10	8980	13	6716	13	-2433	11
	Ru	44	5148	12	12105	12	7766	9	8722	12	3902	15	1043	13
	Rh	45	8039	15	8627	10	1490	6	9574	10	6188	7	423	13
	Pd	46	6153.59	0.15	9864	14	-4976	8	9968	12	3620	6	4363	6
	Ag	47	9184.0	2.7	6484.2	1.4	-12468	5	10364.0	1.8	6052.2	1.7	3290	6
	Cd	48	7323.2	1.8	8186.5	2.8	-20789	5	10613.2	2.8	3302	3	7049.6	1.9
	In	49	10441	9	4526	4	-28817	8	11212	4	5507	4	6099	5
	Sn	50	8632	10	5799	12	-36460	300	11645	14	2842	15	10148	8
	Sb	51	11877	8	1470	8	*	*	12972	7	5967	7	10004	13
	Te	52	10005	7	2559	7	*	*	13649	6	3622	9	15285	7
I	53	13090	130	-820	4	*	*	13580	70	5410	100	14447	10	
Xe	54	*	*	810	330	*	*	13970#	420#	*	*	17700	320	

Table III. Nuclear-reaction and separation energies (continued, Explanation of Table on p. 030003-98)

A	Elt.	Z	S(2n)		S(2p)		Q(α)		Q($2\beta^-$)		Q($\epsilon\beta$)		Q(β^-n)	
107	Sr	38	6430#	860#	*	*		25480#	1320#	*		9080#	860#	
	Y	39	7240#	1430#	*	*	-11180#	640#	21360#	500#	*	8110#	660#	
	Zr	40	9060	1120	30350#	1230#	-9380#	1140#	18170	1120	-26880#	1270#	3750	1120
	Nb	41	9951	9	27030	1340	-7691	14	15026	12	-24960#	500#	4339	12
	Mo	42	11357	13	25665	15	-7161	13	11311	13	-21290	430	-847	15
	Tc	43	12600	40	23412	10	-6146	10	8114	15	-19836	10	-498	10
	Ru	44	14071	8	21103	13	-5327	13	4510	9	-15017	13	-5571	10
	Rh	45	15155	12	19150	40	-4685	16	1543	12	-14376	17	-5027	12
	Pd	46	16097.4	0.6	17016.1	2.6	-3530.4	1.3	-1382.4	2.0	-9338	5	-9501.6	2.9
	Ag	47	17478	5	15133	3	-2800	3	-4842	11	-9333	6	-9345.8	2.3
	Cd	48	18799.1	2.2	13150.3	2.0	-1958.0	1.9	-8478	6	-4371.7	1.9	-14453	12
	In	49	20066	15	11071	12	-1186	12	-12911	12	-3911	12	-14282	12
	Sn	50	21317	7	8756	5	-286	6	-17970	70	1331	5	-20110	9
Sb	51	22780	22	5591	11	1554	10	-21220#	300#	2666	13	-20500	100	
Te	52	23870	310	1780	70	4008	5	*	*	9530	70	*	*	
I	53	*	*	-10#	300#	4320#	420#	*	*	9760#	300#	*	*	
108	Y	39	7390#	780#	*	*	*	22250#	600#	*	*	9010#	1270#	
	Zr	40	8950#	590#	31140#	720#	-9670#	500#	19400#	400#	-29740#	810#	4300#	400#
	Nb	41	9485	9	28070#	500#	-7910#	400#	16377	12	-24470#	500#	4934	12
	Mo	42	10764	13	26780	430	-7457	13	12905	13	-23670	1120	-77	13
	Tc	43	12289	15	24297	10	-6529	9	9109	17	-19488	12	-132	12
	Ru	44	13481	10	22105	13	-5736	12	5863	9	-18399	13	-4869	15
	Rh	45	14812	15	19833	19	-4953	29	2575	14	-13571	16	-4730	14
	Pd	46	15759.3	1.6	17779	6	-3853.4	2.7	-271.8	0.8	-12951	9	-9188.9	2.6
	Ag	47	16807	4	15822	6	-3072	3	-3487	9	-8032	12	-8687.8	2.6
	Cd	48	18262.9	1.6	13922.8	1.6	-2282.2	1.7	-7182	5	-8168.7	1.6	-13759	11
	In	49	19654	15	11755	9	-1428	10	-11674	10	-3002	9	-13679	10
	Sn	50	20859	7	9516	5	-526	6	-16288	8	-2369	6	-19488	7
	Sb	51	22115	9	6415	13	1312	8	-19800	130	3830	12	-19980	70
Te	52	23700	100	3006	7	3420	8	*	*	5442	8	-24420#	300#	
I	53	*	*	750	130	4100	50	*	*	10710	130	*	*	
109	Y	39	6980#	860#	*	*	*	23490#	750#	*	*	10080#	810#	
	Zr	40	7960#	1230#	31870#	860#	-10010#	710#	20470#	500#	*	*	5280#	500#
	Nb	41	9110	260	28900#	570#	-7840	1360	17590	260	-26680#	650#	5990	260
	Mo	42	10257	14	26860	1120	-7626	16	14072	14	-22600#	400#	1185	14
	Tc	43	11675	12	25137	13	-6792	10	10717	10	-22026	13	1307	12
	Ru	44	13019	12	22765	13	-5826	13	6868	9	-17271	13	-3778	17
	Rh	45	14278	13	20827	10	-5130	40	3720	4	-16366	10	-3547	4
	Pd	46	15376.5	1.6	18322	9	-4096.9	2.7	897.8	1.8	-11234	9	-8071.0	2.6
	Ag	47	16455.4	2.7	16434	12	-3293.1	2.8	-2230	4	-10977	14	-7538.3	1.5
	Cd	48	17656.7	2.3	14709.6	2.0	-2511.3	1.9	-5874	8	-6269.1	1.8	-12456	9
	In	49	19068	12	12661	5	-1844	6	-10239	7	-6172	5	-12491	7
	Sn	50	20261	10	10218	8	-721	8	-14915	9	-667	8	-18256	10
	Sb	51	21740	7	7265	12	965	12	-18578	9	580	10	-18541	8
Te	52	23320	70	3781	7	3198	6	-21550	300	7066	7	-23140	130	
I	53	24390#	300#	1597	8	3918	21	*	*	7484	9	*	*	
Xe	54	*	*	210	310	4217	7	*	*	12320	300	*	*	

Table III. Nuclear-reaction and separation energies (continued, Explanation of Table on p. 030003-98)

A	Elt.	Z	S(n)	S(p)	$Q(4\beta^-)$		$Q(d,\alpha)$		$Q(p,\alpha)$		$Q(n,\alpha)$			
110	Zr	40	4770#	780#	16980#	920#	37190#	600#	5120#	840#	4340#	780#	-8340#	920#
	Nb	41	3690	880	13410#	980#	30520	840	9750#	930#	6930	1400	-4300#	980#
	Mo	42	5948	27	15140	260	23788	24	5714	26	4045	26	-4520	1120
	Tc	43	4823	13	11657	15	16423	10	10432	13	6381	13	-1664	12
	Ru	44	7405	12	13079	13	10275	9	6561	12	3541	12	-1875	13
	Rh	45	5901	18	9379	20	3641	21	11543	20	5898	20	1568	20
	Pd	46	8795.7	1.3	10620	4	-2489	14	7412	14	3397	12	1178	9
	Ag	47	6809.19	0.10	7139.8	1.4	-10008	6	12777.7	1.4	5779.4	1.8	5053	12
	Cd	48	9915.0	1.6	8917.5	1.3	-18118	7	7969.6	2.4	2922.8	2.4	3671.1	1.3
	In	49	8052	12	5255	12	-26010	50	13493	12	5384	12	7583	12
	Sn	50	11283	16	6641	14	-33920	100	8989	16	2586	18	6795	14
	Sb	51	9270	8	2109	10	*	*	15331	8	5927	8	11761	13
	Te	52	12586	8	3268	8	*	*	10926	9	3287	8	11929	8
	I	53	10860	50	40	50	*	*	16030	50	4940	90	15840	50
Xe	54	13820	320	1540	100	*	*	11440	170	2370#	320#	14260	120	
111	Zr	40	2750#	920#	*	*	39230#	700#	6350#	990#	4600#	920#	*	*
	Nb	41	4640#	890#	13280#	670#	33430#	300#	8030#	590#	7340#	500#	-5930#	670#
	Mo	42	3468	27	14920	840	26046	13	7460	260	4470	15	-2940#	400#
	Tc	43	6061	14	11771	26	19191	11	8352	15	6595	14	-3832	13
	Ru	44	4784	13	13040	13	12467	10	8208	13	4002	13	-383	13
	Rh	45	7547	19	9521	11	6088	8	9145	11	6221	11	-735	11
	Pd	46	5726.3	0.4	10446	18	-47	5	9724	4	3910	14	3322	9
	Ag	47	8829.5	1.9	7173.5	1.5	-7379	9	10101.8	1.8	6172.8	1.8	2463	14
	Cd	48	6975.60	0.17	9083.9	1.3	-15665	6	10178.0	1.3	3218.6	2.4	5918.4	1.1
	In	49	9993	12	5333	3	-23438	6	10823	4	5724	4	4861	4
	Sn	50	8168	15	6758	13	-31540	90	11262	7	3045	10	8960	5
	Sb	51	11458	11	2284	16	-38020#	200#	12504	12	6097	10	8929	12
	Te	52	9429	9	3427	9	*	*	13374	8	3722	8	14129	8
	I	53	12560	50	13	8	*	*	13472	6	5692	7	13138	7
Xe	54	10540	130	1220	100	*	*	13990	90	3120	120	17030	90	
Cs	55	*	*	-1810#	220#	*	*	14060#	360#	*	*	15480#	240#	
112	Zr	40	4320#	990#	*	*	41820#	700#	*	*	4250#	990#	*	*
	Nb	41	3470#	420#	14000#	760#	35460#	300#	9320#	670#	6780#	590#	-5430#	760#
	Mo	42	5600#	200#	15880#	360#	28860#	200#	5560#	860#	4090#	320#	-5630#	540#
	Tc	43	4306	12	12608	14	21325	6	9994	25	6271	12	-2920	260
	Ru	44	6917	13	13895	14	14944	10	6114	13	3516	13	-3318	15
	Rh	45	5500	40	10240	50	8260	40	11050	40	5870	40	200	50
	Pd	46	8407	7	11306	9	2333	7	7218	19	3542	8	63	11
	Ag	47	6439.6	2.8	7886.8	2.5	-4985	18	12458.0	2.5	5886.8	2.7	4062	5
	Cd	48	9393.93	0.28	9648.4	1.4	-13007	8	7593.2	1.3	3008.6	1.3	2678.0	1.1
	In	49	7669	5	6027	4	-20927	11	13069	4	5378	5	6376	4
	Sn	50	10788	5	7552	3	-28629	8	8526	12	2699	4	5495.7	1.6
	Sb	51	8834	20	2949	19	-35310	90	14954	23	5895	20	10537	18
	Te	52	12051	11	4020	12	*	*	10593	10	3548	10	10709	12
	I	53	10181	11	765	12	*	*	15877	12	5516	11	14834	12
Xe	54	13700	90	2362	10	*	*	11150	50	2510	7	13335	9	
Cs	55	11540#	210#	-816	4	*	*	16340	130	4740	310	17030	90	

Table III. Nuclear-reaction and separation energies (continued, Explanation of Table on p. 030003-98)

A	El.	Z	S(2n)		S(2p)		Q(α)		Q($2\beta^-$)		Q(ϵ_p)		Q(β^-n)	
110	Zr	40	7680#	720#	*		-10520#	850#	21660#	600#	*		5730#	650#
	Nb	41	8910	840	29590#	1030#	-8680#	980#	18720	840	-26400#	1090#	6280	840
	Mo	42	9929	26	27770#	400#	-8420	430	15530	26	-25640#	500#	1669	26
	Tc	43	11254	12	26067	13	-7256	10	11794	20	-21630	260	1633	13
	Ru	44	12554	12	23895	13	-6363	13	8258	9	-20696	14	-3144	10
	Rh	45	13940	23	21484	20	-5477	22	4629	18	-15835	20	-3294	18
	Pd	46	14949.3	1.3	19247	9	-4433	5	2017.1	0.5	-14881	9	-7682.8	1.4
	Ag	47	15993.2	2.7	17004	14	-3520	6	-987	12	-9747	4	-7024.3	1.8
	Cd	48	17238.2	1.2	15401.7	1.2	-2865.4	1.2	-4506	14	-10030.5	1.2	-11930	4
	In	49	18493	14	13441	12	-1953	12	-9020	13	-5040	12	-11911	14
	Sn	50	19915	15	11168	14	-1135	14	-13612	15	-4627	14	-17662	15
	Sb	51	21147	8	7908	10	733	14	-16990	50	1751	7	-17806	7
	Te	52	22591	9	4738	8	2699	8	-20310	100	3111	10	-22629	9
	I	53	23960	140	2600	50	3580	50	*		8500	50	-22370	300
Xe	54	*		720	100	3872	9	*		8500	100	*		
111	Zr	40	7510#	860#	*		-11090#	990#	22380#	700#	*		6680#	1090#
	Nb	41	8330#	400#	30250#	760#	-8940#	590#	20150#	300#	*		7600#	300#
	Mo	42	9416	17	28330#	500#	-7980	1120	16846	15	-24340#	600#	3023	15
	Tc	43	10884	14	26910	260	-7726	13	13280	13	-24000	840	2977	13
	Ru	44	12190	13	24697	15	-6659	13	9201	10	-19532	26	-2028	20
	Rh	45	13448	8	22600	12	-5979	11	5911	7	-18559	12	-2045	7
	Pd	46	14522.0	1.3	19825	9	-4548	9	3266.4	0.7	-13202	9	-6599.9	1.4
	Ag	47	15638.7	1.9	17794	4	-3777	12	177	4	-12676	18	-5938.8	1.4
	Cd	48	16890.6	1.6	16223.7	1.2	-3304.5	1.3	-3314	5	-8210.3	0.6	-10854	12
	In	49	18045.2	2.7	14251	4	-2410	4	-7555	9	-8224	4	-10621	14
	Sn	50	19451	10	12012	6	-1373	6	-12351	8	-2880	5	-16560	8
	Sb	51	20728	10	8925	10	303	14	-15883	10	-1656	15	-16678	11
	Te	52	22015	8	5535	10	2500	8	-19190	90	4966	15	-21190	50
	I	53	23424	8	3281	7	3275	5	-22130#	200#	5207	8	-21100	100
Xe	54	24370	310	1260	90	3720	50	*		10550	90	*		
Cs	55	*		-270#	200#	4180#	360#	*		10350#	200#	*		
112	Zr	40	7070#	920#	*		*		23650#	730#	*		6990#	760#
	Nb	41	8110#	890#	*		-9400#	670#	20990#	300#	*		7600#	300#
	Mo	42	9060#	200#	29160#	630#	-8540#	450#	18170#	200#	-27190#	730#	3490#	200#
	Tc	43	10367	11	27530	840	-8138	10	14470	40	-23670#	300#	3455	11
	Ru	44	11701	13	25666	26	-7300	13	10691	12	-22980	15	-1398	12
	Rh	45	13050	50	23270	50	-6230	40	6850	40	-18000	50	-1820	40
	Pd	46	14133	7	20827	11	-5085	11	4253	7	-16825	12	-6177	7
	Ag	47	15269.1	2.7	18333	18	-3977	14	1406	5	-11568	7	-5402.8	2.4
	Cd	48	16369.5	0.3	16821.9	0.6	-3475.6	1.1	-1919.80	0.16	-11877.9	0.7	-10254	3
	In	49	17663	12	15111	4	-2808	5	-6391	18	-7064	4	-10123	7
	Sn	50	18956	14	12885.0	0.4	-1827.6	1.2	-11088	8	-6691.8	0.3	-15890	9
	Sb	51	20292	19	9707	21	96	20	-14536	21	-496	18	-16083	19
	Te	52	21480	11	6303	16	2078	10	-17541	12	1082	10	-20685	10
	I	53	22740	50	4192	12	2957	12	-20770	90	6484	14	-20740	90
Xe	54	24250	100	2374	11	3330	6	*		6272	10	-25280#	200#	
Cs	55	*		400	100	3930	120	*		11370	90	*		

Table III. Nuclear-reaction and separation energies (continued, Explanation of Table on p. 030003-98)

A	Elt.	Z	S(n)	S(p)	$Q(4\beta^-)$	$Q(d,\alpha)$	$Q(p,\alpha)$	$Q(n,\alpha)$						
113	Nb	41	4310#	500#	13990#	810#	38260#	400#	7760#	810#	7240#	720#	*	
	Mo	42	3100#	360#	15510#	420#	31100#	300#	7100#	420#	4680#	890#	-3960#	670#
	Tc	43	5624	6	12640#	200#	24215	17	7839	13	6595	24	-4860	840
	Ru	44	4310	40	13900	40	17180	40	7870	40	4030	40	-1680	40
	Rh	45	7110	40	10426	12	10600	7	8729	12	6169	11	-2087	12
	Pd	46	5341	9	11150	40	4737	7	9424	10	4102	19	2128	11
	Ag	47	8514	17	7994	18	-2610	24	9670	17	6168	17	1448	24
	Cd	48	6539.74	0.22	9748.5	2.4	-10696	28	9883.0	1.5	3278.1	1.3	4934.0	0.6
	In	49	9448	4	6081.23	0.24	-18248	8	10595.9	0.4	5844.9	0.4	3736.6	1.3
	Sn	50	7744.4	1.6	7627	5	-26125	7	10775	4	3006	12	7666.2	1.6
	Sb	51	10889	25	3051	17	-32652	19	12232	18	6289	22	7699	21
	Te	52	8851	29	4040	30	-38560#	300#	13201	29	3967	29	13140	30
	I	53	12127	13	841	12	*	*	13179	10	5974	10	11977	10
	Xe	54	10249	11	2429	12	*	*	13461	8	3120	50	15673	9
	Cs	55	13550	90	-972.8	2.2	*	*	13340	90	5020	100	14350	50
Ba	56	*	*	780#	310#	*	*	13750#	360#	*	*	17790#	320#	
114	Nb	41	2950#	640#	*	*	40320#	510#	9130#	860#	7040#	860#	*	
	Mo	42	5390#	420#	16590#	500#	33680#	300#	5180#	420#	3930#	420#	-6600#	760#
	Tc	43	3860	430	13400#	530#	26330	430	9570#	480#	6200	430	-4080#	530#
	Ru	44	6430	40	14699	5	19793	4	5748	7	3667	11	-4636	13
	Rh	45	5010	70	11130	80	12860	70	10630	70	5940	70	-1040	70
	Pd	46	7971	10	12012	10	7069	7	6950	40	3678	10	-1059	12
	Ag	47	5975	17	8629	8	-434	22	12102	8	5919	5	3020	8
	Cd	48	9042.97	0.14	10277	17	-8126	28	7279.6	2.4	3064.6	1.5	1617.4	0.7
	In	49	7274.00	0.25	6815.5	0.4	-15770#	150#	12715.9	0.3	5546.5	0.4	5292.0	1.5
	Sn	50	10302.9	1.6	8481.58	0.19	-23474	11	8141	4	2696	3	4338.9	0.4
	Sb	51	8151	28	3457	22	-29810	70	14869	22	6306	22	9542	22
	Te	52	11610	40	4760	30	-35980	110	10420	30	3812	29	9696	28
	I	53	9750#	150#	1740#	150#	*	*	15480#	150#	5660#	150#	13690#	150#
	Xe	54	12954	13	3255	14	*	*	10688	15	2732	12	12148	13
	Cs	55	10990	70	-230	70	*	*	16050	70	4580	110	15920	70
Ba	56	14190#	320#	1430	100	*	*	11100	130	1780#	220#	14140	130	
115	Nb	41	4040#	710#	*	*	42880#	500#	*	*	7320#	860#	*	
	Mo	42	3010#	500#	16650#	640#	35680#	400#	6470#	570#	4390#	500#	-5290#	810#
	Tc	43	5790	900	13800#	840#	28660	790	6880#	850#	6010#	810#	-6400#	840#
	Ru	44	4040	90	14880	440	21890	90	7330	90	3930	90	-3080#	220#
	Rh	45	6590	70	11297	8	15307	7	8350	40	6265	12	-3324	9
	Pd	46	5007	15	12000	70	9607	14	9052	15	4170	50	851	17
	Ag	47	8123	19	8781	20	2021	24	9319	20	6203	19	400	50
	Cd	48	6140.9	0.6	10443	5	-6022	28	9653	17	3363.3	2.5	3883	7
	In	49	9037.9	0.3	6810.38	0.28	-13199	29	10217.74	0.24	5902.57	0.25	2693.8	2.4
	Sn	50	7545.43	0.03	8753.0	0.3	-21377	12	10044.09	0.19	2820	4	6187.43	0.25
	Sb	51	10578	27	3733	16	-27300#	100#	12036	16	6516	16	6633	17
	Te	52	8250	40	4860	40	-33040#	200#	13070	30	4400	30	12239	28
	I	53	11610#	150#	1740	40	*	*	12720	40	6090	30	10910	30
	Xe	54	9642	16	3150#	150#	*	*	13174	15	3271	16	14557	15
	Cs	55	13090#	130#	-100#	100#	*	*	13220#	100#	5190#	100#	13010#	100#
Ba	56	11190#	230#	1630#	210#	*	*	13460#	200#	2130#	220#	16650#	200#	

Table III. Nuclear-reaction and separation energies (continued, Explanation of Table on p. 030003-98)

A	Elt.	Z	S(2n)		S(2p)		Q(α)		Q(2 β^-)		Q(ϵp)		Q($\beta^- n$)	
113	Nb	41	7780#	500#	*	-9740#	810#	22300#	400#	*		8880#	450#	
	Mo	42	8690#	300#	29510#	760#	-8720#	590#	19380#	300#	-25970#	760#	4700#	300#
	Tc	43	9930	11	28510#	300#	-8550	260	15956	8	-25830#	300#	4748	10
	Ru	44	11230	40	26510	40	-7630	40	11720	40	-21690#	200#	-210	60
	Rh	45	12606	10	24321	13	-6910	12	8259	18	-20798	9	-517	10
	Pd	46	13748	7	21384	12	-5278	11	5452	7	-15249	12	-5079	7
	Ag	47	14954	17	19300	18	-4452	17	2340	17	-14580	50	-4523	17
	Cd	48	15933.7	0.3	17635.3	0.7	-3861.7	1.1	-715.2	1.6	-10011	7	-9124	4
	In	49	17118	3	15729.6	1.5	-3072.6	1.3	-4950	17	-10072.4	2.4	-8783.38	0.28
	Sn	50	18532	6	13653.8	1.6	-2248.7	2.2	-9981	28	-5042.2	1.6	-14800	18
	Sb	51	19723	19	10603	18	-352	18	-13297	19	-3716	18	-14921	19
	Te	52	20902	29	6986	28	1858	29	-16143	29	3019	28	-19355	30
	I	53	22308	9	4861	12	2707	10	-19355	12	3190	20	-19164	12
Xe	54	23950	90	3194	9	3087	8	-22420#	300#	8075	11	-23980	90	
Cs	55	25090#	200#	1389	10	3483	8	*	*	8010	13	*	*	
Ba	56	*		-30#	310#	3960#	420#	*	*	12950#	300#	*	*	
114	Nb	41	7260#	590#	*	*		23210#	660#	*		9030#	590#	
	Mo	42	8490#	360#	30570#	760#	-9350#	670#	20420#	300#	*	4930#	300#	
	Tc	43	9480	430	28900#	530#	-8720	940	17110	440	-25380#	590#	5200	430
	Ru	44	10734	10	27340#	200#	-8104	24	13269	8	-25020#	300#	474	8
	Rh	45	12120	80	25030	70	-7100	70	9220	70	-20190	70	-190	70
	Pd	46	13312	9	22438	12	-5843	11	6524	7	-18910	40	-4535	18
	Ag	47	14490	5	19780	40	-4527	18	3639	5	-13452	8	-3959	5
	Cd	48	15582.71	0.25	18271	7	-4108.9	0.6	544.79	0.28	-13713	7	-8719.13	0.30
	In	49	16722	4	16564.0	2.4	-3537.4	1.3	-4073	22	-8832	17	-8313.0	1.6
	Sn	50	18047.30	0.30	14562.81	0.25	-2636.7	0.4	-8671	28	-8805.41	0.25	-14214	17
	Sb	51	19040	28	11084	22	-452	25	-11700#	150#	-2418	22	-14220	40
	Te	52	20464	29	7811	28	1530	30	-14800	30	-849	28	-18840	29
	I	53	21880#	150#	5780#	150#	2230#	150#	-18110#	170#	4330#	150#	-18660#	150#
Xe	54	23202	14	4096	14	2719	13	-21180	100	3970	30	-23393	14	
Cs	55	24530	110	2200	70	3360	50	*	*	9150	70	-22970#	310#	
Ba	56	*		460	100	3592	19	*	*	9010	100	*	*	
115	Nb	41	6990#	640#	*	*		24970#	940#	*		10380#	590#	
	Mo	42	8400#	500#	*	-9610#	810#	21440#	410#	*		5780#	590#	
	Tc	43	9650	790	30390#	890#	-9870#	840#	17910	790	-28220#	940#	5830	790
	Ru	44	10460	100	28280#	310#	-8670	90	14240	90	-23670#	310#	1450	110
	Rh	45	11605	10	25996	8	-7630	13	10753	20	-22920	430	1190	10
	Pd	46	12978	15	23140	40	-6066	17	7658	14	-17494	14	-3567	14
	Ag	47	14098	25	20793	20	-5103	20	4554	18	-16560	70	-3039	18
	Cd	48	15183.8	0.6	19071	7	-4523.5	1.0	1949.4	0.7	-11883	7	-7586.0	0.7
	In	49	16311.86	0.19	17087	17	-3745.8	1.5	-2533	16	-11895	5	-7047.94	0.03
	Sn	50	17848.3	1.6	15568.49	0.24	-3206.5	0.4	-7971	28	-7307.87	0.28	-13609	22
	Sb	51	18729	24	12214	16	-1036	16	-10670	30	-5723	16	-13190	30
	Te	52	19860	40	8313	28	1451	28	-13410	30	1208	28	-17340#	150#
	I	53	21361	30	6500	30	2070	30	-16640#	110#	870	40	-17320	30
Xe	54	22596	14	4890	30	2506	14	-19640#	200#	5940	30	-22050	70	
Cs	55	24080#	100#	3160#	100#	2830#	100#	*	*	5810#	180#	-21870#	150#	
Ba	56	25380#	360#	1390#	200#	2950#	220#	*	*	10780#	200#	*	*	

Table III. Nuclear-reaction and separation energies (continued, Explanation of Table on p. 030003-98)

A	Elt.	Z	S(n)	S(p)	$Q(4\beta^-)$	$Q(d,\alpha)$	$Q(p,\alpha)$	$Q(n,\alpha)$						
116	Mo	42	4820#	640#	17440#	710#	38330#	500#	4600#	710#	3880#	640#	*	
	Tc	43	3210#	840#	14000#	500#	31090#	300#	9060#	420#	5900#	420#	-5300#	500#
	Ru	44	5950	90	15040	790	24644	4	5240	430	3607	5	-5930#	300#
	Rh	45	4580	70	11840	120	17510	70	10200	70	6000	80	-2280	70
	Pd	46	7477	15	12891	10	11694	7	6590	70	3800	10	-2320	40
	Ag	47	5631	19	9405	14	4279	6	11659	8	5912	8	1871	8
	Cd	48	8699.3	0.7	11019	18	-3444	28	6929	5	3178	17	525	7
	In	49	6784.72	0.22	7454.2	0.7	-10760	100	12476.0	0.4	5657.6	0.3	4423	17
	Sn	50	9563.45	0.09	9278.59	0.10	-18479	13	7754.6	0.3	2705.20	0.21	3163.72	0.26
	Sb	51	7890	17	4077	5	-24780#	100#	14448	5	6370	5	8191	5
	Te	52	11280	40	5550	30	-30690#	200#	9940	40	4010	30	8706	28
	I	53	9230	100	2720	100	-36850#	330#	15110	100	5720	100	12570	100
	Xe	54	12461	18	4000	30	*		10460#	150#	2937	15	10950	30
	Cs	55	10410#	140#	680#	100#	*		15750#	100#	5030#	100#	14720#	100#
Ba	56	13630#	280#	2170#	230#	*		10810#	210#	2050#	200#	13270#	200#	
La	57	*		-1090#	370#	*		15970#	330#	4000#	430#	16770#	310#	
117	Mo	42	2740#	710#	*		40260#	500#	5900#	710#	4080#	710#	*	
	Tc	43	5000#	500#	14170#	640#	33800#	400#	7080#	570#	6290#	500#	-7350#	640#
	Ru	44	3490	430	15320#	530#	26930	430	7540	900	3970	610	-4040#	530#
	Rh	45	6230	70	12117	10	20046	10	8000	90	6188	9	-4650	430
	Pd	46	4664	10	12980	70	13973	7	8516	10	4150	70	-556	8
	Ag	47	7711	14	9639	15	6458	16	8955	19	6173	15	-820	70
	Cd	48	5777.2	1.0	11165	3	-1323	13	9275	18	3376	5	2719	7
	In	49	8765	5	7520	5	-8507	27	9852	5	5936	5	1634	7
	Sn	50	6943.1	0.5	9437.0	0.5	-16212	10	9849.4	0.5	3036.1	0.6	5263.6	0.6
	Sb	51	9889	10	4403	8	-22150	60	12105	8	6784	8	5577	8
	Te	52	7900	30	5562	14	-27640	250	12619	21	4265	26	11111	13
	I	53	11020	100	2460	40	-33970#	200#	12340	40	6320	40	9710	30
	Xe	54	9210	17	3980	100	*		12860	30	3480#	150#	13350	30
	Cs	55	12520#	120#	740	60	*		12870	60	5460	60	11950#	160#
Ba	56	10950#	320#	2700#	270#	*		12950#	270#	2090	260	15270	250	
La	57	13900#	370#	-820	3	*		13260#	280#	4300#	230#	13860#	210#	
118	Mo	42	4530#	710#	*		42760#	500#	*		3590#	710#	*	
	Tc	43	3480#	570#	14910#	640#	35760#	400#	8420#	640#	5820#	570#	-6790#	640#
	Ru	44	5840#	480#	16170#	450#	29440#	200#	4910#	360#	3920#	810#	-6860#	450#
	Rh	45	4061	26	12690	430	22341	25	9892	25	6170	90	-2920	790
	Pd	46	7036	8	13780	9	16264.1	2.5	6060	70	3705	8	-3550	90
	Ag	47	5443	14	10418	8	8442	4	10989	8	5737	14	322	8
	Cd	48	8355	20	11809	24	995	27	6552	20	3145	27	-629	24
	In	49	6356	6	8099	8	-6257	21	12195	8	5720	8	3401	20
	Sn	50	9326.42	0.13	9999	5	-13574	10	7307.7	0.5	2747.5	0.5	2078.0	0.8
	Sb	51	7428	9	4887.4	3.0	-19587	13	14241	3	6902	3	7187	3
	Te	52	10672	23	6346	20	-25340#	200#	9836	19	4171	24	7984	18
	I	53	8610	30	3165	24	-31410#	300#	15010	30	5960	30	11679	25
	Xe	54	11965	15	4932	28	*		10120	100	3120	30	9630	30
	Cs	55	9990	60	1513	16	*		15348	18	5111	18	13570	30
Ba	56	12970#	320#	3150#	210#	*		10400#	220#	2210#	220#	11950#	200#	
La	57	11160#	360#	-610#	390#	*		15730#	360#	4320#	360#	15790#	320#	

Table III. Nuclear-reaction and separation energies (continued, Explanation of Table on p. 030003-98)

A	El.	Z	S(2n)		S(2p)		Q(α)		Q($2\beta^-$)		Q(ϵ_p)		Q(β^-n)	
116	Mo	42	7840#	580#	*		-10110#	860#	22570#	500#	*		6750#	940#
	Tc	43	9000#	530#	30650#	590#	-9610#	420#	19280#	310#	-27390#	590#	6660#	310#
	Ru	44	9990	5	28840#	300#	-9030#	200#	15763	8	-26610#	400#	2090	8
	Rh	45	11170	100	26710	440	-7900	70	11810	70	-21710	790	1620	80
	Pd	46	12483	10	24188	8	-6626	12	8881	7	-20930	90	-2920	20
	Ag	47	13754	6	21410	70	-5240	40	5707	3	-15602	8	-2529	3
	Cd	48	14840.2	0.3	19799	7	-4816	7	2813.49	0.13	-15575	14	-7247.45	0.16
	In	49	15822.6	0.4	17897	5	-4090.9	2.4	-1428	5	-10556	18	-6287.23	0.22
	Sn	50	17108.88	0.10	16088.98	0.29	-3376.03	0.27	-6257	28	-10730.5	0.7	-12594	16
	Sb	51	18468	22	12830	5	-1257	7	-9330	100	-4575	5	-12831	28
	Te	52	19520	40	9287	28	961	28	-12220	30	-2524	28	-17000	40
	I	53	20840#	180#	7570	100	1680	100	-15450#	140#	2220	100	-16910	100
	Xe	54	22103	17	5740	30	2096	16	-18470#	200#	1730	30	-21420#	100#
	Cs	55	23500#	120#	3820#	180#	2600#	100#	-21400#	330#	7010#	100#	-21090#	220#
Ba	56	24820#	230#	2070#	200#	3020#	200#	*	*	6790#	200#	*	*	
La	57	*		540#	320#	3220#	300#	*	*	11770#	330#	*	*	
117	Mo	42	7560#	640#	*		*		23320#	660#	*		7210#	580#
	Tc	43	8200#	890#	31610#	640#	-10300#	570#	20520#	400#	*		7620#	400#
	Ru	44	9440	440	29320#	590#	-9430#	530#	16930	430	-25280#	660#	3170	440
	Rh	45	10810	11	27160	790	-8511	10	13285	16	-24730#	300#	2863	11
	Pd	46	12141	15	24810	90	-6980	40	9994	7	-19645	8	-1953	8
	Ag	47	13342	23	22530	15	-5839	15	6761	14	-18730	80	-1541	14
	Cd	48	14476.5	1.2	20570	14	-5252	7	3979.4	1.1	-13876	7	-6240.0	1.0
	In	49	15549	5	18538	19	-4341	17	-304	10	-13689	6	-5488	5
	Sn	50	16506.5	0.5	16891.2	0.8	-3779.4	0.5	-5302	13	-8974.2	0.5	-11647	5
	Sb	51	17779	18	13681	8	-1697	8	-8203	27	-7679	8	-11442	29
	Te	52	19180	30	9640	13	808	14	-10910	17	-858	13	-15670	100
	I	53	20240	40	8010	30	1560	30	-13940	70	-903	27	-15461	29
	Xe	54	21671	16	6701	30	1737	30	-16730	250	3795	30	-20210#	100#
	Cs	55	22940#	120#	4730	70	2200	60	-20020#	210#	3710	110	-19980#	210#
Ba	56	24580#	320#	3380	250	2320	250	*	*	8300	250	-24880#	400#	
La	57	*		1350#	230#	2870#	200#	*	*	8280#	220#	*	*	
118	Mo	42	7270#	710#	*		*		24630#	540#	*		7680#	640#
	Tc	43	8480#	500#	*		-10830#	640#	21100#	400#	*		7630#	590#
	Ru	44	9330#	200#	30340#	540#	-9880#	360#	18130#	200#	-28380#	540#	3570#	200#
	Rh	45	10290	80	28010#	300#	-8710	430	14666	24	-23800#	400#	3466	25
	Pd	46	11700	7	25898	4	-7592	4	11313	20	-23190	430	-1278	14
	Ag	47	13154	4	23400	70	-6270	70	7674	8	-17945	9	-1206.7	2.7
	Cd	48	14132	20	21448	21	-5636	21	4951	20	-17566	21	-5830	21
	In	49	15121	8	19263	8	-4722	9	768	8	-12335	16	-4902	8
	Sn	50	16269.5	0.5	17518.3	0.5	-4062.8	0.6	-3956	18	-12523.4	1.1	-11085	8
	Sb	51	17317	6	14324	3	-1851	3	-7025	20	-6342	6	-10972	14
	Te	52	18570	30	10749	18	438	18	-9618	21	-4588	18	-15330	30
	I	53	19620	100	8727	20	1101	29	-12562	24	380	21	-14857	22
	Xe	54	21175	17	7388	30	1385	30	-15730#	200#	-273	17	-19660	60
	Cs	55	22510#	100#	5500	100	1960#	150#	-18850#	300#	4738	29	-19020	250
Ba	56	23920#	280#	3890#	200#	2310#	200#	*	*	4540#	200#	-23960#	280#	
La	57	25060#	430#	2100#	320#	2700#	310#	*	*	9640#	310#	*	*	

Table III. Nuclear-reaction and separation energies (continued, Explanation of Table on p. 030003-98)

A	Elt.	Z	S(n)		S(p)		Q(4β ⁻)		Q(d,α)		Q(p,α)		Q(n,α)	
119	Tc	43	4650#	640#	15030#	710#	38280#	500#	6510#	710#	5990#	710#	*	
	Ru	44	3380#	360#	16060#	500#	31410#	300#	6530#	500#	3760#	420#	-5420#	580#
	Rh	45	6007	26	12850#	200#	24876	12	7380	430	6110	10	-5720#	300#
	Pd	46	4090	9	13809	26	18657	8	8200	12	4190	70	-1693	9
	Ag	47	7163	15	10546	15	10828	17	8490	16	6050	16	-2260	80
	Cd	48	5350	40	11710	40	3200	40	8920	40	3430	40	1500	40
	In	49	8542	8	8287	21	-3934	29	9430	7	5877	7	490	8
	Sn	50	6483.5	0.5	10126	8	-11271	10	9589	5	3048.8	0.8	4293.9	0.7
	Sb	51	9549	8	5110	8	-17169	16	11634	8	6916	8	4422	8
	Te	52	7556	20	6474	8	-22590	200	12169	12	4505	9	9991	8
	I	53	10870	30	3360	30	-28980#	300#	12040	30	6370	40	8703	28
	Xe	54	8787	15	5112	22	-34850#	500#	12352	28	3560	100	12121	30
	Cs	55	11967	19	1515	17	*		12591	17	5606	19	10830	100
	Ba	56	10310#	280#	3470	200	*		12610	210	2320#	220#	14100	200
La	57	13300#	420#	-280#	360#	*		13380#	390#	4650#	360#	12900#	320#	
Ce	58	*		1670#	580#	*		13240#	540#	1570#	590#	16290#	540#	
120	Tc	43	3220#	710#	*		40130#	500#	7820#	710#	5520#	710#	*	
	Ru	44	5520#	500#	16930#	640#	33950#	400#	4490#	570#	3230#	570#	-8200#	640#
	Rh	45	4060#	200#	13540#	360#	26910#	200#	9160#	280#	5540#	480#	-4790#	450#
	Pd	46	6943	8	14746	10	20818.3	2.2	5318	24	3481	9	-5140	430
	Ag	47	5077	15	11533	9	12766	8	10448	5	5637	9	-1108	10
	Cd	48	8050	40	12601	15	5411	5	6307	4	3089	14	-1886	8
	In	49	6100	40	9040	50	-1980	40	11680	40	5550	40	2100	40
	Sn	50	9104.7	1.1	10688	7	-8926	12	6841	8	2709	5	966.4	1.4
	Sb	51	7015	11	5642	7	-14529	12	13946	7	6844	7	6172	9
	Te	52	10258	9	7183	8	-20480	300	9339	4	4136	9	6676	3
	I	53	8060	30	3861	17	-26180#	300#	14654	24	6206	20	10533	17
	Xe	54	11449	16	5700	30	-32570#	500#	9509	23	3128	29	8569	18
	Cs	55	9655	17	2383	14	*		14901	14	5161	14	12194	28
	Ba	56	12370	360	3870	300	*		10230	300	2470	310	10940	300
La	57	10850#	420#	270#	360#	*		15500#	360#	4750#	390#	14570#	310#	
Ce	58	13730#	710#	2100#	580#	*		10670#	580#	1740#	540#	13500#	560#	
121	Tc	43	4330#	710#	*		42620#	500#	*		5720#	710#	*	
	Ru	44	3110#	570#	16820#	640#	36030#	400#	6040#	640#	3610#	570#	-6770#	640#
	Rh	45	5510#	650#	13530#	740#	29590	620	7030#	690#	5870#	650#	-6810#	740#
	Pd	46	3974	4	14660#	200#	23015	3	7351	10	3569	24	-3280#	200#
	Ag	47	6823	13	11412	12	15198	12	7716	15	5850	12	-3869	27
	Cd	48	5188	4	12711	5	7472	26	8283	15	3344	3	-39	3
	In	49	8180	50	9168	28	415	28	8850	50	5730	30	-636	28
	Sn	50	6170.2	0.3	10760	40	-6716	10	9213	7	2895	8	3151	20
	Sb	51	9254	8	5790.9	2.7	-12498	15	11175.5	2.7	6916.6	2.6	3274	8
	Te	52	7249	26	7417	27	-17800	140	11639	27	4315	26	8754	26
	I	53	10570	16	4172	4	-24060#	300#	11641	10	6309	19	7391	6
	Xe	54	8380	16	6017	18	-29790#	400#	11995	30	3354	22	10862	21
	Cs	55	11285	17	2219	19	-35680#	500#	12403	18	5841	18	9515	24
	Ba	56	9930	330	4150	140	*		12270	140	2530	140	12980	140
La	57	12690#	420#	590#	420#	*		13110#	360#	5030#	360#	11870#	300#	
Ce	58	11160#	640#	2410#	500#	*		12810#	500#	1730#	500#	15310#	450#	
Pr	59	*		-890	10	*		13230#	710#	*		13790#	580#	

Table III. Nuclear-reaction and separation energies (continued, Explanation of Table on p. 030003-98)

A	El.	Z	S(2n)		S(2p)		Q(α)		Q($2\beta^-$)		Q($\epsilon\beta$)		Q(β^-n)	
119	Tc	43	8130#	640#	*		-11440#	710#	22450#	500#	*		8820#	540#
	Ru	44	9220#	530#	30970#	580#	-10240#	500#	18840#	300#	-27220#	580#	4250#	300#
	Rh	45	10068	13	29020#	400#	-8930	790	15823	17	-26320#	400#	4495	10
	Pd	46	11126	11	26500	430	-7640	90	12570	40	-21440#	200#	75	9
	Ag	47	12606	20	24326	17	-6841	16	9054	16	-21047	28	-15	25
	Cd	48	13700	40	22130	40	-5980	40	6090	40	-15880	40	-4820	40
	In	49	14899	6	20095	15	-5142	20	1775	11	-15434	8	-4118	7
	Sn	50	15809.9	0.6	18224.6	1.2	-4405.5	1.0	-2884	8	-10652	20	-10140	3
	Sb	51	16977	11	15109	9	-2363	8	-5709	29	-9535	11	-9849	20
	Te	52	18228	16	11361	8	428	8	-8387	13	-2817	8	-14281	21
	I	53	19470	40	9704	29	810	30	-11460	30	-3058	28	-13758	30
	Xe	54	20752	15	8277	17	843	30	-14200	200	1613	21	-18456	16
	Cs	55	21950	60	6447	30	1610	30	-17520#	300#	1377	24	-18020#	200#
	Ba	56	23270	320	4980	200	1640	200	-20650#	540#	6200	200	-23100#	360#
La	57	24460#	360#	2870#	310#	2490#	320#	*		6330#	300#	*		
Ce	58	*		1060#	560#	2660#	540#	*		11130#	540#	*		
120	Tc	43	7870#	640#	*		*		23300#	540#	*		8980#	590#
	Ru	44	8900#	450#	31960#	640#	-10940#	640#	20270#	400#	*		4740#	400#
	Rh	45	10070#	200#	29600#	450#	-9780#	360#	16840#	200#	-25730#	540#	4520#	200#
	Pd	46	11034	3	27600#	200#	-8636	4	13677	4	-25010#	300#	294	15
	Ag	47	12240	5	25342	25	-7340	70	10080	40	-20118	10	250	40
	Cd	48	13398	20	23147	4	-6551	8	7141	4	-19838	9	-4329	8
	In	49	14640	40	20750	40	-5610	40	2690	40	-14370	40	-3730	40
	Sn	50	15588.1	1.0	18975	20	-4810.8	0.9	-1730	3	-14410	40	-9696	8
	Sb	51	16564	8	15767	11	-2593	7	-4665	17	-8007	10	-9308	11
	Te	52	17814	18	12293	3	-267	3	-7196	12	-6592	3	-13674	28
	I	53	18925	25	10335	16	644	16	-9864	18	-1568	17	-13030	18
	Xe	54	20236	16	9054	22	670	30	-13280	300	-2280	14	-17939	18
	Cs	55	21622	16	7496	22	1180	100	-16320#	300#	2588	30	-17370	200
	Ba	56	22680#	360#	5390	300	1730	300	-19290#	580#	2620	300	-22170#	420#
La	57	24150#	420#	3740#	300#	2050#	320#	*		7450#	300#	-21700#	580#	
Ce	58	*		1820#	540#	2560#	540#	*		7700#	540#	*		
121	Tc	43	7550#	710#	*		*		24470#	800#	*		10160#	640#
	Ru	44	8630#	500#	*		-11300#	640#	21140#	400#	*		5700#	450#
	Rh	45	9570	620	30460#	800#	-10290#	740#	18150	620	-28020#	800#	5960	620
	Pd	46	10917	9	28200#	300#	-9120	430	14891	4	-23460#	400#	1398	6
	Ag	47	11900	19	26158	15	-7930	15	11433	30	-22880#	200#	1483	13
	Cd	48	13240	40	24244	8	-7074	8	8123.4	2.2	-18083	3	-3420	40
	In	49	14279	28	21770	30	-6080	30	3764	28	-17473	28	-2809	27
	Sn	50	15274.9	1.1	19800	40	-5203.8	1.4	-652	26	-12529	4	-8851	7
	Sb	51	16269	8	16479	8	-3082	6	-3349	6	-11160	40	-8304	3
	Te	52	17507	27	13058	26	-573	26	-6065	28	-4736	26	-12864	30
	I	53	18629	28	11355	9	-37	10	-9149	15	-5123	9	-12150	13
	Xe	54	19829	15	9878	13	190	17	-11740	140	-402	11	-16664	14
	Cs	55	20940	20	7910	30	909	30	-14910#	300#	-638	21	-16290	300
	Ba	56	22300	250	6530	140	1020	140	-18060#	430#	4140	140	-21250#	330#
La	57	23540#	420#	4460#	300#	1880#	310#	-20770#	580#	4410#	300#	-20660#	580#	
Ce	58	24890#	640#	2680#	450#	2340#	470#	*		8910#	500#	*		
Pr	59	*		1210#	580#	2620#	540#	*		8860#	580#	*		

Table III. Nuclear-reaction and separation energies (continued, Explanation of Table on p. 030003-98)

A	El.	Z	S(n)	S(p)	Q(4β ⁻)		Q(d,α)		Q(p,α)		Q(n,α)		
122	Ru	44	5170#	640#	17660#	710#	38460#	500#	4080#	710#	3090#	710#	*
	Rh	45	3900#	690#	14320#	500#	31490#	300#	8640#	500#	5350#	420#	-6060# 590#
	Pd	46	6505	20	15660	620	25325	20	4910#	200#	3071	22	-6410# 300#
	Ag	47	4770	40	12210	40	17230	40	9880	40	5170	40	-2640 40
	Cd	48	7610	3	13499	12	9702.1	2.7	5750	5	2897	15	-3558 9
	In	49	5810	60	9790	50	2510	50	11100	50	5270	60	720 50
	Sn	50	8815.4	2.3	11394	27	-4586	11	6500	40	2622	8	-320 40
	Sb	51	6806.37	0.13	6427.1	2.7	-10190	30	13473.8	2.7	6593.7	2.7	5010 8
	Te	52	9840	26	8003.1	2.1	-15706	28	8814	7	4024	8	5397.0 1.7
	I	53	7900	7	4824	26	-21540#	300#	13998	6	5965	10	9040 9
	Xe	54	10945	15	6392	12	-27480#	400#	9109	19	3270	30	7473 14
	Cs	55	9110	40	2950	40	-33370#	500#	14740	40	5510	40	11270 40
	Ba	56	11940	140	4800	30	*	*	9991	30	2560	30	9832 30
	La	57	10420#	420#	1090#	330#	*	*	15060#	420#	4910#	360#	13410# 300#
	Ce	58	13260#	570#	2970#	500#	*	*	10410#	500#	1780#	500#	12360# 450#
Pr	59	11430#	710#	-620#	640#	*	*	15530#	710#	4030#	710#	15660# 580#	
123	Ru	44	3000#	710#	*	*	40330#	500#	5410#	710#	3300#	710#	*
	Rh	45	5350#	500#	14500#	640#	34070#	400#	6400#	570#	5520#	570#	-8200# 640#
	Pd	46	3880	790	15640#	850#	27390	790	6530	1000	3250#	810#	-4770# 890#
	Ag	47	6510	50	12220	40	19680	30	7350	30	5600	30	-5090# 200#
	Cd	48	4873	4	13600	40	11758	3	7699	12	3101	5	-1488 4
	In	49	7930	50	10107	20	4513	20	8354	20	5391	20	-2132 20
	Sn	50	5946.2	1.2	11530	50	-2567	10	8731	27	2780	40	1788 4
	Sb	51	8960.0	2.1	6571.7	2.7	-8180	12	10684.0	1.7	6738.4	1.7	2150 40
	Te	52	6929.01	0.08	8125.8	2.1	-13517	12	11139.0	2.1	4110	7	7572.6 1.7
	I	53	9935	6	4918	3	-19290#	200#	11313	26	6288	4	6120 8
	Xe	54	7965	15	6457	11	-24960#	300#	11714	11	3368	18	9766 10
	Cs	55	10970	40	2978	16	-30810#	400#	12148	16	5993	17	8356 20
	Ba	56	9120	30	4800	40	*	*	12158	19	3098	16	12164 17
	La	57	12180#	360#	1330#	200#	*	*	12810#	240#	5100#	360#	10880# 200#
	Ce	58	10480#	500#	3030#	420#	*	*	12620#	420#	2150#	420#	14250# 420#
Pr	59	13520#	640#	-360#	570#	*	*	13170#	570#	4230#	640#	12990# 500#	
124	Ru	44	4950#	780#	*	*	42740#	600#	*	2680#	780#	*	
	Rh	45	3600#	570#	15100#	640#	35980#	400#	7970#	640#	5020#	570#	-7460# 640#
	Pd	46	6030#	840#	16320#	500#	29840#	300#	4400#	420#	2720#	690#	-7700# 500#
	Ag	47	4720	250	13060	830	21420	250	9130	250	4850	250	-4300 670
	Cd	48	7359	4	14440	30	13824	3	5120	40	2565	12	-4873 4
	In	49	5510	40	10740	30	6500	30	10450	30	5070	30	-820 30
	Sn	50	8489.3	2.4	12093	20	-572.8	2.0	6050	50	2466	27	-1514.0 2.2
	Sb	51	6467.50	0.06	7093.0	2.7	-5889	8	13031.9	2.7	6441.1	1.7	3862 27
	Te	52	9424.48	0.09	8590.22	0.12	-11436	13	8520.9	2.1	3939.1	2.1	4318.3 1.7
	I	53	7493	4	5482.5	1.9	-17110	60	13659.5	1.9	6044	26	7881.0 2.8
	Xe	54	10484	10	7007	4	-22750#	300#	9130	5	3454	6	6530 26
	Cs	55	8759	15	3772	13	-28580#	400#	14334	14	5614	13	10167 10
	Ba	56	11506	17	5335	17	-34560#	500#	9770	40	2877	19	9038 16
	La	57	9680#	200#	1890	60	*	*	15060	60	5350	150	12490 60
	Ce	58	12700#	420#	3550#	360#	*	*	10340#	420#	2140#	420#	11480# 330#
Pr	59	10990#	570#	150#	500#	*	*	15430#	570#	4400#	570#	14690# 500#	
Nd	60	*	*	1590#	640#	*	*	10970#	710#	1760#	710#	13810# 640#	

Table III. Nuclear-reaction and separation energies (continued, Explanation of Table on p. 030003-98)

A	Elt.	Z	S(2n)		S(2p)		Q(α)		Q(2 β^-)		Q(ϵ_p)		Q(β^-n)	
122	Ru	44	8280#	640#	*		-11950#	710#	22470#	500#	*		6030#	800#
	Rh	45	9410#	360#	31140#	590#	-10720#	500#	19030#	300#	-27590#	580#	6030#	300#
	Pd	46	10479	20	29180#	400#	-9780#	200#	15996	20	-26860#	400#	1715	23
	Ag	47	11600	40	26870#	200#	-8640	50	12470	60	-22140	620	1900	40
	Cd	48	12798	4	24910	3	-7649	3	9329	3	-21719	4	-2848	28
	In	49	13990	60	22500	50	-6440	50	4760	50	-16460	50	-2450	50
	Sn	50	14985.6	2.3	20562	4	-5665	20	373.1	2.7	-16156	3	-8412	3
	Sb	51	16060	8	17180	40	-3532	8	-2255	5	-9788	28	-7861	26
	Te	52	17089.1	2.7	13794.0	1.7	-1086.5	1.6	-4959	11	-8406.2	1.7	-12134	5
	I	53	18470	16	12241	9	-509	6	-7940	30	-3769	5	-11671	11
	Xe	54	19325	16	10565	12	-83	22	-10750	30	-4098	28	-16324	18
	Cs	55	20400	40	8970	40	400	40	-13600#	300#	820	30	-15470	150
	Ba	56	21860	300	7010	30	1045	30	-16740#	400#	583	30	-20490#	300#
	La	57	23120#	420#	5230#	300#	1440#	300#	-19760#	580#	5270#	300#	-19930#	500#
Ce	58	24420#	640#	3560#	500#	2060#	450#	*	*	5580#	430#	-24520#	640#	
Pr	59	*		1790#	580#	2360#	580#	*	*	10120#	580#	*	*	
123	Ru	44	8180#	640#	*		*	23350#	940#	*		6930#	580#	
	Rh	45	9250#	740#	32160#	640#	-11410#	640#	20190#	400#	*		7190#	400#
	Pd	46	10390	790	29960#	890#	-10290#	840#	16980	790	-25570#	940#	2610	790
	Ag	47	11290	30	27880	620	-9150	30	13880	40	-24760#	300#	2990	30
	Cd	48	12483	3	25810	4	-8431	9	10402	4	-20087	20	-1910	50
	In	49	13740	30	23605	23	-7210	25	5794	20	-19610	40	-1560	20
	Sn	50	14761.6	2.4	21320	3	-6260	40	1356.0	2.7	-14493	3	-7552	3
	Sb	51	15766.4	2.1	17966	27	-3950	7	-1280	3	-12940	50	-6980.93	0.10
	Te	52	16769	26	14552.8	1.7	-1532.0	1.7	-3923	10	-6519.8	2.7	-11163	5
	I	53	17835	6	12921	4	-894	9	-6900	13	-6897	4	-10660	12
	Xe	54	18910	14	11281	28	-492	12	-9594	15	-2223	10	-15180	40
	Cs	55	20084	19	9370	13	300	30	-12390#	200#	-2252	13	-14510	30
	Ba	56	21050	140	7752	16	715	16	-15370#	300#	2411	16	-19180#	300#
	La	57	22600#	360#	6130#	200#	1230#	200#	-18420#	450#	2210#	200#	-18850#	450#
Ce	58	23740#	500#	4120#	330#	1880#	360#	*	*	7030#	300#	-23580#	580#	
Pr	59	24950#	640#	2620#	500#	2140#	500#	*	*	7020#	500#	*	*	
124	Ru	44	7950#	780#	*		*	24430#	670#	*		7330#	720#	
	Rh	45	8950#	500#	*		-11800#	640#	21310#	470#	*		7470#	890#
	Pd	46	9920#	300#	30820#	580#	-10800#	500#	18310#	300#	-28600#	580#	3090#	300#
	Ag	47	11240	250	28700#	390#	-9810#	320#	14670	250	-24130#	470#	3140	250
	Cd	48	12232	4	26663	20	-8847	4	11533	3	-23560	790	-1343	20
	In	49	13440	60	24340	50	-7640	30	6750	30	-18610	40	-1130	30
	Sn	50	14435.5	2.4	22199.8	2.5	-6702	4	2291.1	1.5	-18109.0	2.9	-7081.4	1.5
	Sb	51	15427.5	2.1	18630	50	-4320	40	-254.5	1.9	-11479	20	-6519.41	0.09
	Te	52	16353.50	0.12	15161.9	2.7	-1851.9	1.7	-2863.9	2.2	-9998.1	2.7	-10653	3
	I	53	17428	5	13608.3	2.8	-1373	8	-5634	9	-5430.6	1.9	-10188	10
	Xe	54	18449	11	11924.9	2.2	-718	3	-8572	13	-5778.2	2.2	-14689	12
	Cs	55	19730	30	10229	10	-403	17	-11470	60	-1077	9	-14148	15
	Ba	56	20620	30	8313	17	658	17	-14170#	300#	-1130	16	-18510#	200#
	La	57	21860#	300#	6690	70	1210	60	-17110#	410#	3500	60	-18040#	300#
Ce	58	23190#	500#	4890#	300#	1550#	420#	-20390#	590#	3450#	300#	-22760#	500#	
Pr	59	24510#	640#	3190#	500#	1990#	500#	*	*	8210#	450#	*	*	
Nd	60	*		1230#	640#	2650#	710#	*	*	8470#	590#	*	*	

Table III. Nuclear-reaction and separation energies (continued, Explanation of Table on p. 030003-98)

A	El.	Z	S(n)		S(p)		Q(4β ⁻)		Q(d,α)		Q(p,α)		Q(n,α)	
125	Rh	45	5180#	640#	15330#	780#	38480#	500#	5790#	710#	5010#	710#	*	
	Pd	46	3800#	500#	16520#	570#	31780#	400#	5950#	570#	2820#	500#	-6320#	640#
	Ag	47	6390	500	13420#	530#	23740	430	6620	900	4960	430	-6790#	530#
	Cd	48	4718	4	14440	250	15675	3	6910	30	2620	40	-3086	20
	In	49	7680	40	11064	27	8360	27	7648	27	5000	27	-3720	50
	Sn	50	5733.50	0.20	12320	30	1297.0	2.1	8245	20	2540	50	362.4	2.5
	Sb	51	8707.3	2.1	7311.1	2.6	-4168	8	10271	3	6549	3	960	50
	Te	52	6568.97	0.03	8691.70	0.14	-9354	11	10911.90	0.12	4176.5	2.1	6564.8	2.7
	I	53	9542.8	1.9	5600.85	0.07	-15078	26	11045.76	0.12	6341.31	0.14	5144.6	2.1
	Xe	54	7603.3	0.4	7116.6	2.9	-20540#	200#	11461	4	3751	5	8767.5	2.2
	Cs	55	10428	11	3716	8	-26150#	300#	11872	12	6131	14	7639	9
	Ba	56	8651	17	5227	14	-32070#	400#	12085	16	3340	40	11332	16
	La	57	11570	60	1959	29	*		12606	29	5710	40	10030	40
	Ce	58	9810#	360#	3690#	200#	*		12700#	280#	2750#	360#	13600#	200#
Pr	59	12860#	500#	310#	420#	*		13060#	420#	4800#	500#	12250#	420#	
Nd	60	11150#	640#	1740#	570#	*		13340#	570#	2040#	640#	15920#	570#	
126	Rh	45	3370#	710#	*		40470#	500#	7370#	780#	4640#	710#	*	
	Pd	46	5810#	570#	17150#	640#	34160#	400#	3740#	570#	2360#	570#	-9130#	640#
	Ag	47	4230#	480#	13850#	450#	25710#	200#	8420#	360#	4610#	810#	-5670#	450#
	Cd	48	6980	4	15030	430	17808.5	2.9	4650	250	2160	30	-6180	790
	In	49	5370	40	11714	27	10138	27	9640	27	4505	27	-2580	40
	Sn	50	8190	10	12827	29	3132	11	5570	30	2279	22	-2955	11
	Sb	51	6210	30	7790	30	-2040	30	12550	30	6290	30	2680	40
	Te	52	9113.69	0.08	9098.0	2.1	-7395	13	8265.71	0.16	4022.78	0.14	3397.2	2.7
	I	53	7145	4	6177	4	-12940	90	13325	4	6125	4	6959	4
	Xe	54	10025	4	7599	4	-18326	28	8930	4	3661	5	5672	4
	Cs	55	8334	13	4446	11	-24030#	200#	14021	11	5762	14	9239	11
	Ba	56	11072	17	5871	15	-29680#	300#	9772	15	3238	17	8225	16
	La	57	9290	90	2590	90	-35620#	510#	14830	90	5550	90	11720	90
	Ce	58	12230#	200#	4350	40	*		10150	60	2700#	200#	10480	30
	Pr	59	10460#	360#	960#	280#	*		15300#	360#	4830#	360#	13970#	280#
	Nd	60	13470#	500#	2340#	420#	*		10870#	500#	2100#	500#	12940#	420#
Pm	61	*		-960#	640#	*		15890#	710#	*		16530#	640#	
127	Rh	45	4800#	780#	*		42870#	600#	*		4790#	850#	*	
	Pd	46	3390#	640#	17170#	710#	36290#	500#	5530#	710#	2570#	640#	-7570#	780#
	Ag	47	5830#	280#	13870#	450#	28260#	200#	6390#	450#	4810#	360#	-7900#	450#
	Cd	48	4562	12	15360#	200#	19534	12	6480	430	2320	250	-4710#	300#
	In	49	7190	30	11928	21	12088	21	7163	21	4670	21	-5050	250
	Sn	50	5527	14	12987	29	4851	11	7717	29	2260	30	-1123	10
	Sb	51	8380	30	7973	12	-459	8	9908	5	6399	5	-180	30
	Te	52	6287.65	0.18	9180	30	-5464	11	10685.4	2.1	4202.63	0.24	5598.9	1.5
	I	53	9143.9	2.7	6208	4	-11088	26	10750	4	6405	4	4283	4
	Xe	54	7246	5	7699	3	-16342	29	11226	4	3908	4	7850	4
	Cs	55	9961	12	4382	7	-21700#	200#	11664	6	6285	6	6772	6
	Ba	56	8219	17	5756	15	-27280#	300#	11981	14	3777	14	10490	11
	La	57	10990	90	2515	29	-33110#	400#	12484	28	6058	29	9482	27
	Ce	58	9230	40	4290	100	*		12490	40	3140	60	12760	30
	Pr	59	12290#	280#	1010#	200#	*		12830#	280#	5240#	360#	11360#	200#
	Nd	60	10610#	420#	2500#	360#	*		13120#	420#	2480#	500#	15030#	420#
Pm	61	13510#	640#	-920#	500#	*		13520#	570#	4600#	640#	14010#	570#	

Table III. Nuclear-reaction and separation energies (continued, Explanation of Table on p. 030003-98)

A	El.	Z	S(2n)		S(2p)		$Q(\alpha)$		$Q(2\beta^-)$		$Q(\epsilon p)$		$Q(\beta^- n)$	
125	Rh	45	8780#	640#	*		-12650#	710#	22520#	660#	*		8320#	580#
	Pd	46	9830#	890#	31620#	640#	-11500#	570#	19230#	400#	-27450#	720#	4010#	470#
	Ag	47	11110	430	29740#	590#	-10690	760	15960	430	-26920#	590#	4110	430
	Cd	48	12077	4	27500	790	-9591	4	12548	3	-22250#	300#	-550	30
	In	49	13190	30	25510	40	-8499	30	7779	27	-21570	250	-314	27
	Sn	50	14222.8	2.4	23060.1	2.9	-7247.5	2.2	3126.6	1.5	-16484	3	-6347.4	1.5
	Sb	51	15174.8	2.1	19404	20	-4845	28	580.9	2.1	-14680	30	-5802.3	2.1
	Te	52	15993.45	0.10	15784.7	2.7	-2250.6	1.7	-1829.6	2.2	-8077.8	1.5	-9728.6	1.9
	I	53	17036	3	14191.08	0.13	-1661.8	2.1	-4749	8	-8505.93	0.15	-9247.1	2.2
	Xe	54	18087	10	12599.2	2.2	-1073	26	-7524	11	-3957.0	2.2	-13533	9
	Cs	55	19187	14	10722	9	-261	9	-10328	27	-4011	8	-13069	15
	Ba	56	20157	16	8998	15	387	15	-13010#	200#	703	11	-17480	60
	La	57	21250#	200#	7294	29	918	30	-15820#	300#	683	27	-16920#	300#
	Ce	58	22510#	360#	5580#	200#	1660#	240#	-19060#	450#	5140#	200#	-21580#	450#
	Pr	59	23850#	500#	3870#	360#	1830#	420#	*		5030#	310#	-21490#	590#
	Nd	60	*		1890#	500#	2670#	570#	*		10030#	500#	*	
126	Rh	45	8550#	640#	*		*		23380#	540#	*		8750#	640#
	Pd	46	9610#	500#	32480#	720#	-12140#	640#	20400#	400#	*		4590#	590#
	Ag	47	10620#	320#	30370#	450#	-11030#	360#	17090#	200#	-25970#	540#	4600#	200#
	Cd	48	11698	4	28450#	300#	-10066	20	13758	11	-25430#	400#	149	27
	In	49	13050	40	26150	250	-9090	50	8620	40	-20540	430	52	27
	Sn	50	13924	10	23892	11	-7828	11	4050	11	-19956	11	-5830	11
	Sb	51	14920	30	20100	40	-5250	60	1520	30	-13210	40	-5440	30
	Te	52	15682.66	0.09	16409.1	1.5	-2548.9	2.7	-918	4	-11457.9	1.5	-9299.46	0.10
	I	53	16688	4	14869	4	-2001	4	-3560	11	-6944	4	-8789	4
	Xe	54	17628	4	13200	4	-1257	4	-6477	13	-7413	4	-13130	8
	Cs	55	18762	13	11563	11	-695	12	-9380	90	-2803	11	-12753	15
	Ba	56	19723	18	9586	13	260	17	-11850	30	-2765	13	-16982	29
	La	57	20860	110	7820	90	750	100	-14650#	220#	1830	90	-16390#	220#
	Ce	58	22050#	300#	6310	30	1360	40	-17830#	300#	1560	30	-20950#	300#
	Pr	59	23320#	450#	4640#	200#	1800#	360#	-20970#	540#	6150#	200#	-20800#	450#
	Nd	60	24610#	590#	2660#	420#	2460#	500#	*		6380#	360#	*	
	Pm	61	*		780#	640#	3010#	710#	*		11300#	580#	*	
127	Rh	45	8170#	780#	*		*		24410#	630#	*		9760#	720#
	Pd	46	9200#	640#	*		-12530#	710#	21570#	500#	*		5430#	540#
	Ag	47	10060#	480#	31020#	540#	-11510#	450#	18460#	200#	-28430#	540#	5750#	200#
	Cd	48	11542	12	29210#	400#	-10740	790	14723	16	-24180#	400#	954	30
	In	49	12560	30	26950	430	-9770	40	9803	22	-23510#	200#	1048	24
	Sn	50	13717	10	24701	10	-8482	10	4811	10	-18503	10	-5150	30
	Sb	51	14586	5	20801	27	-5694	20	2284	6	-16216	27	-4705	5
	Te	52	15401.34	0.20	16963.2	1.5	-2890.4	2.7	40	4	-9555	11	-8442	4
	I	53	16289	4	15306	4	-2185	4	-2744	6	-9880	30	-7908	5
	Xe	54	17271	4	13877	4	-1574	4	-5504	12	-5545	4	-12042	11
	Cs	55	18295	10	11981	6	-721	7	-8344	27	-5618	6	-11642	14
	Ba	56	19292	16	10203	12	6	15	-10840	30	-960	12	-15920	90
	La	57	20280	40	8386	27	723	29	-13350#	200#	-834	28	-15150	40
	Ce	58	21460#	200#	6890	30	1250	30	-16440#	300#	3400	30	-19730#	200#
	Pr	59	22750#	360#	5360#	200#	1680#	280#	-19760#	450#	3140#	220#	-19620#	360#
	Nd	60	24080#	500#	3460#	360#	2330#	420#	*		8000#	300#	-24260#	580#
Pm	61	*		1420#	500#	3020#	570#	*		8250#	450#	*		

Table III. Nuclear-reaction and separation energies (continued, Explanation of Table on p. 030003-98)

A	Elt.	Z	S(n)		S(p)		Q(4β ⁻)		Q(d,α)		Q(p,α)		Q(n,α)	
128	Pd	46	5380#	710#	17750#	780#	38870#	500#	3520#	710#	2370#	710#	*	
	Ag	47	4250#	360#	14730#	580#	30010#	300#	7950#	500#	4360#	500#	-6970#	580#
	Cd	48	6566	14	16090#	200#	21752	7	4150#	200#	2140	430	-7480#	400#
	In	49	5320	150	12690	150	13590	150	8820	150	4070	150	-3980	460
	Sn	50	7963	20	13755	28	6498	18	5120	30	1980	30	-4368	18
	Sb	51	6002	20	8448	22	1301	20	12096	22	6130	19	1490	30
	Te	52	8783.4	1.7	9583	5	-3615	5	8110	30	4126.6	2.7	2549.1	1.3
	I	53	6826.13	0.05	6746	4	-9110	50	13037	4	6148	4	6164	4
	Xe	54	9610	4	8165	4	-14326	28	8762	4	3841.0	1.8	4809.1	1.8
	Cs	55	7763	8	4899	7	-19600	30	13926	6	6126	6	8552	6
	Ba	56	10632	12	6427	8	-25060#	200#	9683	12	3574	9	7461	6
	La	57	8800	60	3100	60	-30840#	300#	14760	60	5910	60	11110	50
	Ce	58	11630	40	4930	40	-36860#	500#	10150	90	3090	40	9780	30
	Pr	59	9860#	200#	1640	40	*	*	15200	40	5190#	200#	13080	40
	Nd	60	12850#	360#	3060#	280#	*	*	10720#	280#	2490#	360#	11990#	280#
	Pm	61	11070#	500#	-460#	420#	*	*	15920#	420#	4680#	500#	15800#	420#
Sm	62	*		1170#	640#	*	*	11390#	710#	*		14580#	640#	
129	Pd	46	1190#	780#	*		42980#	600#	7130#	850#	4550#	780#	*	
	Ag	47	5430#	500#	14780#	640#	32650#	400#	5910#	640#	4740#	570#	-9030#	640#
	Cd	48	3887	18	15730#	300#	23947	17	6090#	200#	2490#	200#	-5550#	400#
	In	49	6760	150	12885	8	15669	4	6620	12	4283	4	-6510#	200#
	Sn	50	5300	25	13730	150	8105	17	7016	27	2050	30	-2688	17
	Sb	51	8070	29	8556	28	2870	22	9552	23	6250	24	-1210	30
	Te	52	6082.41	0.08	9663	19	-1942	11	10405	5	4250	30	4657	10
	I	53	8840	5	6802	3	-7183	22	10485	3	6422	3	3530	30
	Xe	54	6907.1	1.1	8246	4	-12409	28	10999	4	4079	4	7015.7	1.5
	Cs	55	9639	7	4928	5	-17730	30	11533	6	6512	6	6058	6
	Ba	56	7756	11	6421	12	-22750#	200#	11888	12	4152	15	9730	11
	La	57	10770	60	3235	22	-28440#	300#	12204	24	6209	25	8673	24
	Ce	58	8820	40	4950	60	-34290#	500#	12320	40	3550	90	12030	30
	Pr	59	11510	40	1530	40	*	*	12920	40	5910	40	10850	100
	Nd	60	10070#	280#	3270#	200#	*	*	12940#	280#	2870#	280#	14150#	200#
	Pm	61	13170#	420#	-140#	360#	*	*	13370#	420#	4980#	420#	13090#	360#
Sm	62	11400#	710#	1500#	580#	*	*	13500#	640#	2210#	710#	16640#	580#	
130	Ag	47	1790#	640#	15380#	780#	36590#	500#	9500#	710#	6350#	710#	-6020#	780#
	Cd	48	6131	28	16430#	400#	26235	22	4210#	300#	2190#	200#	-8290#	500#
	In	49	5120	40	14110	40	17050	40	8070	40	3730	40	-5800#	200#
	Sn	50	7613	17	14583	3	9748.3	1.9	4720	150	1628	21	-5738	12
	Sb	51	5728	26	8984	22	4614	16	11787	23	6049	17	257	25
	Te	52	8419.5	0.9	10013	21	-91.4	2.6	7988	19	4211	5	1764	10
	I	53	6500.33	0.04	7220	3	-5309	26	12768	3	6210	3	5410	6
	Xe	54	9255.72	0.01	8662	3	-10458	28	8569	4	3968	4	4047.6	1.5
	Cs	55	7472	10	5493	8	-15720	60	13671	8	6286	9	7731	9
	Ba	56	10270	11	7051	5	-20665	28	9381	6	3843	6	6706	5
	La	57	8370	30	3853	28	-26230#	200#	14462	26	6055	28	10259	27
	Ce	58	11210	40	5390	40	-31920#	400#	9910	60	3340	40	9040	30
	Pr	59	9470	70	2180	70	-37490#	510#	15070	70	5670	70	12370	70
	Nd	60	12350#	200#	4110	40	*	*	10450	40	2810#	200#	11030	40
	Pm	61	10590#	360#	370#	280#	*	*	15630#	280#	5000#	360#	14790#	280#
	Sm	62	13580#	640#	1910#	500#	*	*	10990#	500#	2140#	570#	13680#	500#
Eu	63	*		-1028	15	*	*	15700#	710#	*		16750#	640#	

Table III. Nuclear-reaction and separation energies (continued, Explanation of Table on p. 030003-98)

A	Elt.	Z	S(2n)		S(2p)		Q(α)		Q($2\beta^-$)		Q(ϵ_p)		Q(β^-n)	
128	Pd	46	8770#	640#	*		-12960#	780#	22750#	500#	*		5880#	540#
	Ag	47	10080#	360#	31900#	580#	-12160#	500#	19530#	340#	-27880#	670#	6060#	300#
	Cd	48	11128	8	29960#	400#	-11280#	300#	16120	19	-27350#	500#	1583	22
	In	49	12520	160	28040#	250#	-10370	290	10480	150	-23000#	250#	1250	150
	Sn	50	13489	21	25683	18	-9085	18	5632	18	-21904	21	-4734	18
	Sb	51	14380	40	21440	30	-6190	40	3108	19	-15023	29	-4420	19
	Te	52	15071.0	1.7	17556	10	-3184.4	1.3	866.6	0.9	-12812	10	-8081	4
	I	53	15970.0	2.7	15920	30	-2543	4	-1807	7	-8328	6	-7488.5	2.0
	Xe	54	16856	4	14372.9	1.8	-1759.9	1.8	-4482	5	-8867.6	1.8	-11691	6
	Cs	55	17723	12	12598	7	-991	6	-7310	50	-4237	7	-11185	13
	Ba	56	18851	14	10809	6	-142	5	-9845	28	-4346	7	-15554	27
	La	57	19790	110	8850	60	680	60	-12290	60	330	50	-14720	60
	Ce	58	20860	40	7440	30	1130	30	-15220#	200#	-0	30	-19060#	200#
	Pr	59	22150#	200#	5940	100	1500	60	-18550#	300#	4280	40	-18870#	300#
	Nd	60	23460#	360#	4070#	200#	2180#	360#	-21640#	540#	4380#	200#	-23600#	450#
	Pm	61	24580#	580#	2040#	360#	2940#	500#	*	*	9470#	360#	*	*
Sm	62	*		260#	580#	3430#	710#	*	*	9580#	580#	*	*	
129	Pd	46	6570#	780#	*		*		25450#	600#	*		8940#	670#
	Ag	47	9680#	450#	32530#	720#	-12410#	640#	20860#	400#	*		7190#	400#
	Cd	48	10453	21	30460#	500#	-11360#	400#	17533	24	-25860#	500#	3020	150
	In	49	12084	21	28980#	200#	-10740	430	11792	21	-25510#	300#	2453	18
	Sn	50	13263	20	26421	21	-9668	18	6414	17	-20638	19	-4032	26
	Sb	51	14072	22	22311	30	-6580	30	3878	21	-17770	150	-3707	21
	Te	52	14865.8	1.7	18112	10	-3533.3	1.3	1691.3	0.9	-10932	18	-7337	4
	I	53	15666	5	16386	6	-2676	4	-1008	6	-11166	19	-6718	3
	Xe	54	16517	4	14992.3	1.5	-2098.0	1.5	-3633	11	-6991.3	0.9	-10836	5
	Cs	55	17402	7	13093	6	-1087	5	-6175	22	-7049	6	-10192	7
	Ba	56	18388	16	11320	11	-295	11	-8776	30	-2492	11	-14510	60
	La	57	19570	30	9662	22	338	23	-11550	40	-2682	22	-13860	40
	Ce	58	20450	40	8050	30	960	30	-13970#	200#	1802	28	-18030	40
	Pr	59	21370#	200#	6460	40	1560	40	-16890#	300#	1560	60	-17530#	200#
	Nd	60	22920#	360#	4910#	200#	1920#	280#	-20320#	540#	5930#	200#	-22600#	360#
	Pm	61	24240#	500#	2920#	360#	2630#	420#	*	*	6160#	300#	-22280#	580#
Sm	62	*		1040#	580#	3170#	640#	*	*	11030#	540#	*	*	
130	Ag	47	7220#	400#	*		-10820#	710#	24190#	500#	*		9290#	500#
	Cd	48	10018	24	31210#	500#	-11680#	400#	19015	22	-30800#	600#	3649	23
	In	49	11880	160	29840#	300#	-11630#	200#	12400	40	-25190#	400#	2640	40
	Sn	50	12913	18	27468	7	-10300	3	7220.7	1.9	-24363	17	-3574	21
	Sb	51	13798	24	22720	150	-6940	30	4650	15	-16737	14	-3352	14
	Te	52	14501.9	0.9	18569	18	-3763	10	2527.51	0.01	-14051	17	-6917	3
	I	53	15340	5	16884	19	-2970	30	-36	9	-9596	21	-6311	3
	Xe	54	16162.8	1.1	15464.7	0.9	-2240.0	1.5	-2618.9	2.6	-10164.6	0.9	-10453	5
	Cs	55	17111	10	13739	9	-1413	9	-5272	27	-5682	9	-9908	13
	Ba	56	18025.7	2.8	11979.2	2.8	-539	4	-7839	28	-5854.5	2.6	-14008	21
	La	57	19140	60	10274	27	299	28	-10450	70	-1417	26	-13410	40
	Ce	58	20030	40	8622	28	820	30	-12830	40	-1649	30	-17720	40
	Pr	59	20990	70	7130	80	1370	110	-15780#	210#	2860	70	-16930#	210#
	Nd	60	22430#	200#	5640	40	1800	40	-19090#	400#	2400	40	-21790#	300#
	Pm	61	23750#	360#	3640#	200#	2500#	280#	-21710#	540#	7090#	200#	-21470#	540#
	Sm	62	24980#	640#	1770#	450#	3060#	500#	*	*	7520#	450#	*	*
Eu	63	*		480#	580#	3240#	710#	*	*	11910#	580#	*	*	

Table III. Nuclear-reaction and separation energies (continued, Explanation of Table on p. 030003-98)

A	Elt.	Z	S(n)	S(p)	$Q(4\beta^-)$	$Q(d,\alpha)$	$Q(p,\alpha)$	$Q(n,\alpha)$						
131	Ag	47	2750#	710#	*	41600#	500#	7940#	780#	8970#	710#	*		
	Cd	48	2170	100	16810#	510#	29990	100	7470#	410#	4270#	320#	-5080#	510#
	In	49	6210	40	14196	23	19417.7	2.8	5744	17	4081	8	-7760#	300#
	Sn	50	5204	4	14670	40	11149	4	6284	5	1750	150	-4376	8
	Sb	51	7767	14	9138.2	2.8	6077	5	9320	17	6245	18	-2190	150
	Te	52	5929.38	0.06	10214	14	1472.7	2.6	10129	21	4283	19	3797	18
	I	53	8578	3	7378.7	0.6	-3673	28	10272.9	1.1	6415.1	1.1	2834	19
	Xe	54	6604.41	0.01	8766	3	-8710	30	10804	3	4189	4	6226.6	0.9
	Cs	55	9230	10	5467	5	-13760	50	11348	5	6666	5	5326	6
	Ba	56	7493.50	0.30	7073	9	-18916	28	11526	5	4112	6	8823.0	2.8
	La	57	10210	40	3797	28	-24110#	200#	12005	30	6473	28	7809	28
	Ce	58	8360	40	5370	40	-29580#	400#	12330	40	3780	60	11320	30
	Pr	59	11200	80	2170	50	-35030#	400#	12700	50	6100	50	9970	70
	Nd	60	9240	40	3880	70	*	*	12720	40	3430	40	13410	40
	Pm	61	12340#	280#	350#	200#	*	*	13370#	280#	5520#	280#	12320#	200#
	Sm	62	10700#	570#	2030#	450#	*	*	13460#	500#	2520#	500#	15830#	450#
Eu	63	13660#	640#	-947	5	*	*	13440#	640#	4260#	640#	14160#	500#	
132	Ag	47	1480#	710#	*	45850#	500#	*	*	8680#	780#	*		
	Cd	48	3120#	220#	17170#	540#	34930#	200#	6150#	540#	6580#	450#	-7010#	630#
	In	49	2460	60	14480	120	23290	60	9420	60	5510	60	-4790#	400#
	Sn	50	7353	4	15810	3	12732.4	2.0	4050	40	1155	3	-7842	17
	Sb	51	5725	3	9660	4	7517.4	2.7	11208	3	5820	17	-1151	4
	Te	52	8048	3	10496	4	3247	4	7808	15	4305	22	1049	18
	I	53	6332	4	7781	4	-1980	40	12360	4	6165	4	4572	22
	Xe	54	8936.72	0.01	9125.2	0.6	-6808	20	8368	3	4092	3	3372.2	0.9
	Cs	55	7165	5	6028.1	1.0	-11925	29	13438.6	1.0	6407.4	1.0	7001	3
	Ba	56	9822.6	2.7	7665	5	-17009	24	9176	8	3928	5	5907.4	1.1
	La	57	8030	50	4330	40	-22100#	150#	14250	40	6200	40	9420	40
	Ce	58	10830	40	5990	30	-27390#	300#	9870	30	3718	30	8239	23
	Pr	59	9000	60	2810	40	-33030#	400#	14910	40	5920	40	11740	40
	Nd	60	11730	40	4410	50	*	*	10460	70	3210	40	10510	40
	Pm	61	10040#	250#	1150#	150#	*	*	15680#	150#	5550#	250#	13790#	150#
	Sm	62	13020#	500#	2710#	360#	*	*	11030#	360#	2670#	420#	12880#	360#
Eu	63	11000#	570#	-640#	570#	*	*	16020#	570#	4660#	640#	16330#	500#	
133	Cd	48	1730#	360#	17420#	580#	39020#	300#	7170#	580#	6640#	580#	*	
	In	49	3120#	210#	14490#	280#	28390#	200#	8470#	220#	8520#	200#	-6120#	540#
	Sn	50	2398.7	2.7	15750	60	16770	3	7862	3	3870	40	-4110	22
	Sb	51	7360	4	9666	4	9147	3	9052	5	6073	4	-3390	40
	Te	52	5820	4	10591	3	4616.5	2.3	9755.1	2.9	4213	14	2841.5	2.8
	I	53	8226	8	7959	7	-364	29	10064	6	6359	6	2074	16
	Xe	54	6435.9	2.4	9229	5	-5225	17	10509.9	2.5	4157	4	5355.8	2.4
	Cs	55	8989.6	1.0	6080.94	0.01	-10133	12	11053.43	0.01	6673.59	0.01	4512	3
	Ba	56	7189.9	0.4	7689.9	1.4	-15220	50	11216	5	4210	8	7973.3	1.0
	La	57	9840	50	4348	28	-20090	60	11900	28	6631	28	7052	29
	Ce	58	8019	26	5980	40	-25190#	300#	12060	30	4070	30	10490	17
	Pr	59	10780	30	2756	24	-30700#	300#	12480	40	6350	30	9336	29
	Nd	60	8980	50	4390	50	-36470#	500#	12680	70	3710	80	12740	50
	Pm	61	11850#	160#	1270	60	*	*	13070	60	6050	60	11410	80
	Sm	62	10220#	420#	2890#	330#	*	*	13140#	360#	3030#	360#	15010#	300#
	Eu	63	13110#	500#	-550#	420#	*	*	13610#	500#	5130#	500#	13810#	360#
Gd	64	*	*	950#	640#	*	*	14120#	640#	2690#	710#	17290#	640#	

Table III. Nuclear-reaction and separation energies (continued, Explanation of Table on p. 030003-98)

A	Elt.	Z	S(2n)		S(2p)		Q(α)		Q(2 β^-)		Q(ϵp)		Q($\beta^- n$)	
131	Ag	47	4540#	640#	*		-8780#	780#	27650#	500#	*		12670#	500#
	Cd	48	8300	100	32190#	610#	-10460#	510#	22050	100	*		6590	110
	In	49	11330	4	30620#	400#	-12010#	200#	13956	3	-29620#	500#	4036	3
	Sn	50	12816	18	28784	17	-10942	13	7946	4	-23436	23	-3050	15
	Sb	51	13495	21	23722	3	-7510	21	5461.3	2.2	-19390	40	-2699.8	2.1
	Te	52	14348.8	0.9	19198	17	-4165	10	3202.55	0.06	-12367.8	1.9	-6346	3
	I	53	15078	3	17391	21	-3168	5	616	5	-12446	14	-5633.6	0.6
	Xe	54	15860.13	0.01	15986.7	0.9	-2556.8	1.5	-1729.8	2.6	-8349.58	0.01	-9585	8
	Cs	55	16702	7	14130	6	-1500	6	-4290	28	-8412	6	-8869	5
	Ba	56	17763	11	12565.6	2.6	-787	5	-6980	30	-4092.2	2.6	-13128	26
	La	57	18590	40	10848	28	46	28	-9470	50	-4158	29	-12420	40
	Ce	58	19560	40	9220	30	680	30	-11940	40	260	30	-16600	70
	Pr	59	20670	60	7550	50	1170	50	-14640#	210#	40	50	-15780	50
	Nd	60	21600#	200#	6060	40	1790	40	-17640#	400#	4370	40	-20440#	200#
	Pm	61	22920#	360#	4470#	200#	2460#	280#	-20390#	450#	4230#	210#	-20230#	450#
	Sm	62	24280#	640#	2400#	450#	2980#	500#	*	*	9170#	400#	-24520#	640#
Eu	63	*		970#	500#	3090#	570#	*	*	8840#	450#	*	*	
132	Ag	47	4240#	710#	*		*	28620#	500#	*		13360#	510#	
	Cd	48	5290#	200#	*		-8200#	540#	26280#	200#	*		9690#	200#
	In	49	8670	70	31290#	500#	-10220#	310#	17220	60	-29320#	500#	6780	60
	Sn	50	12557.0	2.7	30007	22	-11730	8	8642	4	-28620	100	-2636.5	2.9
	Sb	51	13492	14	24330	40	-7910	150	6068	5	-18899	4	-2495.6	2.5
	Te	52	13978	3	19634	4	-4251	18	4091	3	-15213	5	-5817	4
	I	53	14910	5	17996	15	-3498	20	1449	4	-11011	5	-5361	4
	Xe	54	15541.13	0.01	16503.95	0.01	-2710.2	0.9	-843.9	1.1	-11356.92	0.06	-9291	5
	Cs	55	16396	8	14794	3	-1839	4	-3430	40	-6998.9	1.2	-8540.3	2.8
	Ba	56	17316.1	2.7	13132.5	1.1	-999.6	1.5	-5964	20	-7310.4	1.1	-12737	28
	La	57	18240	40	11400	40	-220	40	-8500	50	-2950	40	-12090	50
	Ce	58	19190	30	9787	20	483	21	-11050	30	-3076	20	-16240	50
	Pr	59	20190	70	8180	40	970	60	-13600#	150#	1250	40	-15530	40
	Nd	60	20970	40	6580	40	1680	40	-16350#	300#	990	40	-19840#	200#
	Pm	61	22370#	250#	5030#	160#	2280#	150#	-19430#	430#	5380#	160#	-19570#	430#
	Sm	62	23720#	500#	3060#	300#	2810#	360#	*	*	5400#	300#	-23880#	500#
Eu	63	24660#	640#	1380#	450#	3160#	500#	*	*	10170#	450#	*	*	
133	Cd	48	4840#	320#	*		-8740#	670#	26950#	300#	*		10420#	300#
	In	49	5580#	200#	31660#	540#	-7910#	450#	21460#	200#	-30960#	540#	11010#	200#
	Sn	50	9752	4	30230	100	-10241	17	12063.2	2.8	-27900#	200#	690	3
	Sb	51	13085	4	25476	4	-8511	4	6935	7	-23800	60	-1807	5
	Te	52	13868.7	2.1	20250	4	-4771	17	4706	3	-13679.6	2.9	-5305	5
	I	53	14558	6	18455	7	-3654	22	2213	6	-13512	7	-4651	6
	Xe	54	15372.6	2.4	17010.5	2.4	-3063.7	2.6	-90.0	2.6	-9744	4	-8562.2	2.6
	Cs	55	16155	5	15206.2	0.6	-1989	3	-2577	28	-9656	4	-7707.2	1.1
	Ba	56	17012.5	2.7	13718.0	1.0	-1282.5	1.0	-5135	16	-5563.6	1.0	-11900	40
	La	57	17870	40	12014	28	-420	28	-7560	30	-5631	28	-11090	30
	Ce	58	18850	40	10312	17	220	19	-10090	50	-1272	16	-15260	30
	Pr	59	19780	50	8750	30	962	25	-12530	50	-1500	40	-14583	27
	Nd	60	20710	50	7200	60	1530	50	-15100#	300#	2850	50	-18780#	160#
	Pm	61	21890#	210#	5680	70	1940	60	-18170#	300#	2530	60	-18400#	300#
	Sm	62	23240#	500#	4040#	300#	2660#	360#	-21370#	580#	6910#	300#	-23100#	500#
	Eu	63	24110#	500#	2150#	360#	3220#	420#	*	*	7100#	330#	*	*
Gd	64	*		310#	640#	3720#	710#	*	*	11930#	580#	*	*	

Table III. Nuclear-reaction and separation energies (continued, Explanation of Table on p. 030003-98)

A	Elt.	Z	S(n)		S(p)		Q(4β ⁻)		Q(d,α)		Q(p,α)		Q(n,α)	
134	Cd	48	3070#	500#	*		43610#	400#	5580#	640#	6330#	640#	*	
	In	49	2270#	360#	15030#	420#	32380#	300#	9310#	360#	8420#	320#	-5630#	580#
	Sn	50	3631	4	16260#	200#	21692	3	6690	60	6455	4	-5570	100
	Sb	51	3168	4	10435.6	2.6	12870.6	1.7	13236.8	2.6	8108	4	-349	3
	Te	52	7668	3	10899	4	6416.1	2.8	7812	4	4312	3	377	5
	I	53	6256	8	8395	5	1175	21	11856	6	6032	5	3584	5
	Xe	54	8553.6	2.4	9557	6	-3293	20	8288	4	4180.9	0.6	2731.59	0.06
	Cs	55	6891.54	0.01	6536.6	2.4	-8363	20	13098.61	0.02	6386.46	0.02	6198.0	0.6
	Ba	56	9467.6	1.0	8167.9	0.3	-13303	12	8913.6	1.1	3973	5	5110.1	0.3
	La	57	7800	30	4954	20	-18480	60	13927	20	6329	20	8487	21
	Ce	58	10486	26	6630	30	-23460#	200#	9600	40	3800	30	7497	21
	Pr	59	8662	24	3399	26	-28600#	300#	14654	29	6040	40	10890	30
	Nd	60	11390	50	4998	17	-34340#	400#	10290	30	3520	50	9710	30
	Pm	61	9400	80	1700	70	*		15400	60	5890	60	13210	70
	Sm	62	12220#	360#	3260#	200#	*		10960#	250#	3150#	280#	12040#	200#
	Eu	63	10760#	420#	-10#	420#	*		15860#	420#	5070#	500#	15380#	360#
Gd	64	13510#	640#	1360#	500#	*		11610#	570#	2830#	570#	14480#	570#	
135	In	49	2940#	500#	14900#	570#	37250#	400#	8100#	500#	8600#	450#	-7090#	640#
	Sn	50	2270	4	16260#	300#	25781	5	7540#	200#	6640	60	-4720#	200#
	Sb	51	3741	3	10546	4	17891.3	2.8	11894	3	11720	3	-1630	60
	Te	52	3266	3	10997.2	2.4	10121.7	1.7	11906	4	6771	3	4464.2	2.6
	I	53	7807	5	8534	3	2864	10	9868.8	2.9	6273	4	1503	3
	Xe	54	6359	4	9659	6	-1797	11	10156	7	4154	6	4421	5
	Cs	55	8761.8	1.0	6744.8	1.0	-6646	12	10772.7	2.6	6561.4	1.0	3768	4
	Ba	56	6971.96	0.10	8248.3	0.3	-11637	19	10931.2	0.3	4166.2	1.1	7074.9	0.3
	La	57	9496	22	4982	9	-16590	80	11621	9	6656	9	6156	9
	Ce	58	7855	23	6686	22	-21760	150	11589	30	3970	40	9465	10
	Pr	59	10479	24	3392	24	-26790#	200#	12193	20	6399	24	8430	40
	Nd	60	8638	22	4975	28	-31820#	400#	12435	23	3880	30	11904	28
	Pm	61	11380	100	1690	80	-37230#	410#	12990	90	6240	80	10820	80
	Sm	62	9550#	250#	3410	170	*		13260	160	3630#	220#	14210	160
	Eu	63	12290#	360#	60#	280#	*		13790#	360#	5800#	360#	13130#	250#
	Gd	64	11160#	570#	1750#	500#	*		13560#	500#	2670#	570#	16340#	500#
Tb	65	*		-1188	7	*		13750#	640#	*		15020#	570#	
136	In	49	2050#	570#	*		39040#	400#	9120#	570#	8270#	500#	*	
	Sn	50	3340#	300#	16660#	500#	30530#	300#	6470#	420#	6430#	360#	-6330#	420#
	Sb	51	2888	6	11164	7	21832	6	12638	7	11231	6	-1400#	200#
	Te	52	4767.8	2.9	12024	3	14461.7	2.3	10306.1	2.8	9362	4	2095.0	3.0
	I	53	3837	14	9105	14	6490	60	13699	14	8256	14	5025	15
	Xe	54	8087	4	9939.0	2.1	79.2	0.4	8325	5	4293	6	2154.4	2.1
	Cs	55	6828.4	2.1	7215	4	-4998	12	12497.9	1.9	6169	3	5166	7
	Ba	56	9107.74	0.04	8594.2	1.0	-9688	12	8715.0	0.3	4048.1	0.3	4403.1	2.4
	La	57	7470	50	5480	50	-14870	90	13620	50	6380	50	7680	50
	Ce	58	9964	10	7154	9	-19697	13	9421	20	3850	28	6691.6	1.1
	Pr	59	8476	16	4013	15	-25100#	200#	14203	23	5942	20	9800	30
	Nd	60	11057	22	5552	17	-30110#	300#	10040	24	3602	17	8865	20
	Pm	61	9190	100	2250	70	-35040#	510#	15190	70	6030	80	12410	70
	Sm	62	12020	160	4050	80	*		10640	60	3460	50	11170	50
	Eu	63	10170#	280#	680#	250#	*		15840#	280#	5850#	360#	14810#	200#
	Gd	64	12770#	500#	2230#	360#	*		11550#	420#	3010#	420#	13790#	420#
Tb	65	11380#	640#	-970#	640#	*		15880#	640#	4590#	710#	16750#	580#	

Table III. Nuclear-reaction and separation energies (continued, Explanation of Table on p. 030003-98)

A	Elt.	Z	S(2n)		S(2p)		Q(α)		Q($2\beta^-$)		Q($\epsilon\beta$)		Q(β^-n)	
134	Cd	48	4800#	450#	*	*	*	27510#	400#	*	*	10470#	450#	
	In	49	5390#	300#	32450#	580#	-8390#	580#	22360#	300#	*	11140#	300#	
	Sn	50	6030	4	30750#	200#	-7741	23	16100	4	-29800#	300#	4418	4
	Sb	51	10527.9	3.0	26190	60	-6560	40	10023	5	-23850#	200#	845.3	2.7
	Te	52	13488	4	20565	3	-4826	3	5592.1	2.7	-18949	3	-4747	7
	I	53	14483	6	18986	5	-4183	15	2848	5	-12409	6	-4471	5
	Xe	54	14989.49	0.01	17516	3	-3197.79	0.01	824.0	0.3	-12477.7	2.1	-8126.21	0.01
	Cs	55	15881.1	1.0	15766	4	-2380	3	-1673	20	-8322	6	-7408.9	1.0
	Ba	56	16657.5	1.1	14248.8	0.3	-1494.3	0.3	-4117	20	-8595.3	2.4	-11527	28
	La	57	17640	40	12644	20	-744	22	-6691	28	-4437	20	-10872	26
	Ce	58	18505	29	10976	20	4	21	-9186	24	-4568	20	-14967	24
	Pr	59	19440	40	9380	40	670	30	-11790	60	-320	30	-14270	50
	Nd	60	20363	27	7753	24	1350	30	-14270#	200#	-517	20	-18310	50
	Pm	61	21250#	160#	6090	60	2010	90	-16810#	300#	3910	60	-17580#	300#
	Sm	62	22440#	360#	4530#	200#	2800#	200#	-20070#	450#	3670#	200#	-22210#	360#
	Eu	63	23870#	500#	2880#	330#	3040#	360#	*	*	8190#	300#	-22140#	580#
Gd	64	*	*	800#	500#	3780#	570#	*	*	8640#	500#	*	*	
135	In	49	5210#	450#	*	*	-8570#	640#	23160#	400#	*	11830#	400#	
	Sn	50	5901	4	31290#	300#	-7840	100	17097	4	-29000#	400#	5317	4
	Sb	51	6909	4	26800#	200#	-4090	4	14089	3	-25320#	300#	4772	4
	Te	52	10934.3	2.7	21432.8	2.6	-2889	4	8684	4	-18584	4	-1757	5
	I	53	14064	7	19434	4	-4222.7	2.9	3802.5	2.3	-17047.6	2.7	-3724.6	2.1
	Xe	54	14912	4	18054	4	-3627	4	1437	4	-11168	5	-7593	4
	Cs	55	15653.3	1.0	16301	7	-2563.8	1.2	-938	9	-10827	5	-6703.1	1.0
	Ba	56	16439.5	1.0	14784.9	2.4	-1861.9	0.3	-3234	10	-7013.6	0.3	-10703	20
	La	57	17292	29	13150	9	-1009	11	-5707	15	-7041	9	-9882	22
	Ce	58	18341	19	11640	10	-357	11	-8403	22	-2955	10	-14159	23
	Pr	59	19141	17	10020	30	410	30	-10880	80	-3006	23	-13361	17
	Nd	60	20020	50	8373	25	1070	40	-13360	160	1330	28	-17550	60
	Pm	61	20790	90	6690	80	1820	90	-15900#	210#	1190	80	-16750#	210#
	Sm	62	21770#	340#	5100	160	2490	160	-18470#	430#	5500	160	-21000#	340#
	Eu	63	23050#	360#	3320#	200#	3090#	280#	-21320#	450#	5300#	200#	-20920#	450#
	Gd	64	24670#	640#	1740#	500#	3320#	570#	*	*	9700#	450#	*	*
Tb	65	*	*	170#	500#	4020#	570#	*	*	9810#	500#	*	*	
136	In	49	4990#	500#	*	*	-9150#	640#	24000#	400#	*	12050#	400#	
	Sn	50	5610#	300#	31560#	500#	-8060#	360#	18530#	300#	*	5720#	300#	
	Sb	51	6629	6	27420#	300#	-4520	60	15038	15	-25270#	400#	5151	6
	Te	52	8034	4	22569	4	-304	3	12003.9	2.3	-21082	4	1283	3
	I	53	11644	15	20103	14	-2335	14	6793	14	-17144	14	-1203	15
	Xe	54	14445.97	0.01	18473.4	2.7	-3666	3	2457.8	0.3	-15989.3	1.7	-6918.8	1.0
	Cs	55	15590.2	1.9	16873	5	-3060	4	-300	50	-9848.5	2.8	-6559.5	1.9
	Ba	56	16079.70	0.11	15339.0	0.3	-2032.9	0.3	-2378.55	0.27	-9763	4	-10315	9
	La	57	16960	60	13720	50	-1310	50	-4700	50	-5740	50	-9490	50
	Ce	58	17818	20	12136.46	0.29	-498.3	1.1	-7309	12	-5946.84	0.27	-13644	12
	Pr	59	18955	23	10700	23	-40	40	-10170	70	-1986	15	-13198	22
	Nd	60	19695	17	8944	24	847	24	-12388	17	-1872	16	-17220	80
	Pm	61	20570	90	7220	70	1630	70	-14930#	210#	2480	70	-16380	170
	Sm	62	21580#	200#	5742	17	2190	27	-17720#	300#	2114	23	-20730#	200#
	Eu	63	22460#	360#	4080#	200#	2960#	250#	-20110#	540#	6520#	210#	-19930#	450#
	Gd	64	23930#	500#	2290#	360#	3570#	420#	*	*	6480#	340#	-24340#	500#
Tb	65	*	*	780#	580#	3650#	640#	*	*	10730#	540#	*	*	

Table III. Nuclear-reaction and separation energies (continued, Explanation of Table on p. 030003-98)

A	El.	Z	S(n)	S(p)	$Q(4\beta^-)$	$Q(d,\alpha)$	$Q(p,\alpha)$	$Q(n,\alpha)$						
140	Sb	51	2220#	720#	12790#	780#	33110#	600#	11630#	780#	10710#	720#	-3250#	780#
	Te	52	4440	60	14080#	410#	26690	60	8350	1070	8350	80	-1140#	410#
	I	53	3207	13	10690	13	20710	12	12801	13	10562	12	2100	50
	Xe	54	5413	3	11804	5	15089.6	2.8	9704	6	8234	9	1964	3
	Cs	55	4421	9	8694	8	7638	10	13633	9	10197	8	4953	12
	Ba	56	6427	8	9857	9	990	9	10328	12	8140	8	4760	8
	La	57	5160.98	0.04	6691.1	2.0	-6102	24	14656.6	2.0	8269.4	2.0	7876.1	2.0
	Ce	58	9200	7	8138.8	1.7	-12620	13	9154	3	3928.7	2.3	5291.5	1.6
	Pr	59	7941	10	5029	9	-17700	50	13594	8	6095	6	8099	6
	Nd	60	10316	28	6729	9	-22477	28	9586	12	3807	9	7306	3
	Pm	61	8785	28	3490	40	-27730	800	14515	27	6235	27	10634	26
	Sm	62	11147	17	5244	18	-32630#	400#	10200	30	3481	18	9775	17
	Eu	63	9660	50	1890	50	-37730#	510#	15220	50	5900	70	12730	50
	Gd	64	12220#	200#	3670	30	*	*	10680	40	3228	28	11890	50
	Tb	65	10420#	850#	140#	820#	*	*	16030#	820#	5600#	850#	15310	800
	Dy	66	13260#	640#	1990#	500#	*	*	11550#	500#	3000#	570#	14030#	500#
Ho	67	*	*	-1094	10	*	*	16380#	710#	*	*	17360#	640#	
141	Sb	51	3240#	780#	*	*	35370#	500#	10040#	710#	10620#	710#	*	*
	Te	52	1980#	410#	13840#	720#	29250#	400#	10010#	570#	8600#	1140#	20#	640#
	I	53	4392	20	10640	60	23005	16	10989	16	10633	16	-60	1060
	Xe	54	3282	4	11880	12	17236	3	10984	5	8647	7	3145	5
	Cs	55	5499	12	8780	9	11538	9	11878	9	10359	10	3149	11
	Ba	56	4535	9	9971	10	4460	6	11679	6	8018	11	5886	6
	La	57	6687	4	6951	9	-2409	15	12693	4	10194	4	5602	10
	Ce	58	5428.14	0.10	8406.0	1.7	-9499	9	12504.1	1.7	5950	3	8475.1	1.6
	Pr	59	9399	6	5228.5	1.2	-16090	13	11643	7	6419	5	6150	3
	Nd	60	8005	5	6794	7	-20968	20	11337	8	3805	11	9025	6
	Pm	61	10381	28	3553	14	-25980	110	12200	30	6359	18	8257	18
	Sm	62	8549	15	5009	26	-30550#	300#	12277	16	3871	29	11731	14
	Eu	63	11010	50	1759	18	-35560#	400#	13165	17	6436	17	10660	30
	Gd	64	9510	30	3530	60	*	*	12885	24	3390	30	13920	23
	Tb	65	12130	810	50	110	*	*	13800#	220#	6120#	220#	12860	110
	Dy	66	10620#	500#	2190#	850#	*	*	13460#	420#	3150#	420#	16060#	360#
Ho	67	13180#	640#	-1177	7	*	*	13990#	640#	5430#	640#	14950#	500#	
142	Te	52	3950#	640#	14550#	710#	31470#	500#	8280#	780#	8280#	640#	-2280#	710#
	I	53	2910	370	11570#	550#	25250	370	12520	380	10300	370	670#	550#
	Xe	54	5104	4	12592	16	19304	4	9087	12	8105	5	622	4
	Cs	55	4108	12	9606	8	13273	7	13183	7	9994	7	3603	8
	Ba	56	6181	8	10654	11	8108	6	9919	10	7723	7	3449	6
	La	57	5164	7	7581	8	1118	24	13956	10	9754	6	6323	7
	Ce	58	7171.6	2.5	8891	5	-5547	4	10493.5	2.9	7557.1	2.9	6027.0	2.5
	Pr	59	5843.15	0.08	5643.5	1.2	-12470	30	14999.4	1.2	8024	7	9085.1	2.0
	Nd	60	9829	3	7223.3	1.4	-18990	28	9449	6	3733	8	6644	7
	Pm	61	8690	27	4238	24	-24580	700	13828	24	5740	40	9323	25
	Sm	62	11124	9	5753	14	-28870#	730#	9938	24	3378	14	8674	28
	Eu	63	9460	30	2670	30	-34060#	400#	14850	30	5930	30	11830	30
	Gd	64	11810	30	4320	30	-38930#	500#	10740	60	3300	30	11067	30
	Tb	65	10090	710	620	700	*	*	15930	700	5940#	730#	14480	700
	Dy	66	12810#	790#	2870#	740#	*	*	11070#	1080#	2880#	790#	13160#	750#
	Ho	67	10960#	570#	-840#	500#	*	*	16290#	570#	5260#	640#	16530#	500#
Er	68	*	*	950#	640#	*	*	11940#	710#	*	*	15260#	710#	

Table III. Nuclear-reaction and separation energies (continued, Explanation of Table on p.030003-98)

A	Elt.	Z	S(2n)		S(2p)		Q(α)		Q(2 β^-)		Q(ϵ p)		Q(β^- n)	
140	Sb	51	5860#	1220#	*		-5850#	720#	19670#	600#	*		8200#	600#
	Te	52	7020	60	26290#	510#	-3100#	310#	16410	60	-25430#	500#	3820	60
	I	53	7769	13	23960	1060	-1524	13	13444	15	-21110#	400#	3967	12
	Xe	54	9157	4	21868	4	-986	3	10283	8	-20070	4	-357	4
	Cs	55	10306	12	19648	10	70	16	7266	8	-15868	9	-208	8
	Ba	56	11150	8	17875	8	735	8	4807	8	-14914	8	-4114	8
	La	57	13939.3	2.5	16007	9	-402.1	2.7	372	6	-10904	4	-5439	7
	Ce	58	16648	5	14392.4	1.6	-1614.1	1.6	-3817	4	-10451.3	1.6	-11329	8
	Pr	59	17697	13	12747	7	-1080	50	-6474	25	-4751	6	-10745	28
	Nd	60	18383	12	11266	6	-175	3	-8803	13	-4600	8	-14830	14
	Pm	61	19420	40	9658	27	702	27	-11230	60	-684	25	-13905	27
	Sm	62	20101	17	8016	17	1318	17	-13670	30	-730	30	-18129	18
	Eu	63	21380	60	6620	60	1760	90	-16500	800	3230	50	-17430#	200#
	Gd	64	22130#	200#	4860	30	2600	30	-18950#	400#	3309	30	-21720#	300#
	Tb	65	22960#	850#	3310	800	3340#	820#	-21220#	950#	7630	800	-20910#	950#
	Dy	66	24040#	640#	1610#	450#	3840#	500#	*	*	7510#	450#	*	*
	Ho	67	*		170#	590#	4450#	710#	*	*	11580#	590#	*	*
141	Sb	51	5460#	640#	*		-6500#	710#	20820#	500#	*		9400#	500#
	Te	52	6430#	400#	26630#	640#	-3120#	570#	17710#	400#	*		5050#	400#
	I	53	7598	16	24720#	400#	-2290	50	14551	18	-23280#	600#	4988	16
	Xe	54	8695	4	22570	5	-1318	4	11535	6	-18910	60	781	9
	Cs	55	9919	10	20585	10	-546	12	8454	10	-18160	15	721	12
	Ba	56	10962	5	18666	6	226	5	5700	6	-14035	6	-3488	6
	La	57	11848	4	16809	5	1189	4	3084	4	-13171	9	-2927	4
	Ce	58	14628	7	15097.1	1.6	-136.6	1.6	-1240	3	-9453	8	-8816	6
	Pr	59	17339	8	13367.4	2.0	-1299.9	2.3	-5493	14	-8988.7	2.0	-9828	4
	Nd	60	18321	28	11823	8	-699	3	-8259	9	-3406	3	-14050	24
	Pm	61	19165	19	10282	16	254	16	-10597	19	-3124	15	-13138	19
	Sm	62	19696	14	8498	29	1226	15	-12710	22	1036	9	-17020	50
	Eu	63	20670	18	7003	19	1722	18	-15380	110	999	27	-16210	30
	Gd	64	21740#	200#	5422	23	2380	50	-17840#	300#	4943	23	-20810	800
	Tb	65	22550#	320#	3720	110	3180	110	-20180#	410#	5160	120	-19780#	410#
	Dy	66	23880#	590#	2330#	360#	3410#	420#	*	*	9110#	300#	-24200#	590#
	Ho	67	*		810#	500#	4180#	570#	*	*	8830#	900#	*	*
142	Te	52	5940#	510#	*		-3930#	710#	18860#	500#	*		5490#	500#
	I	53	7310	370	25410#	700#	-2970	1130	15740	370	-22950#	630#	5360	370
	Xe	54	8386	4	23230	60	-1959	5	12613	7	-22030#	400#	1177	10
	Cs	55	9607	11	21486	14	-960	9	9510	9	-17877	17	1147	9
	Ba	56	10716	10	19434	6	-295	7	6691	6	-16934	7	-2982	7
	La	57	11851	6	17552	10	438	11	3763	6	-12836	11	-2663	6
	Ce	58	12599.7	2.5	15842	8	1303.5	2.5	1416.8	2.2	-12090	6	-6588.9	2.5
	Pr	59	15242	6	14049.5	2.0	307	3	-2645	24	-8145	4	-7666.2	2.8
	Nd	60	17834	4	12451.8	1.6	-804	5	-6963.5	2.8	-7806.0	1.6	-13498	14
	Pm	61	19070	30	11032	24	-433	26	-9830	40	-2415	24	-13279	25
	Sm	62	19673	13	9305	5	607	12	-12027	28	-2083	4	-17132	13
	Eu	63	20470	60	7680	40	1200	40	-14750	700	1920	30	-16160	40
	Gd	64	21320	40	6080	30	2110	30	-16840#	730#	1685	29	-20490	110
	Tb	65	22220	1060	4150	700	2770	700	-19310#	810#	6080	700	-19250#	760#
	Dy	66	23430#	830#	2920#	730#	3260#	750#	-22090#	880#	5820#	730#	-23830#	830#
	Ho	67	24130#	640#	1350#	900#	3990#	500#	*	*	10000#	410#	*	*
	Er	68	*		-220#	640#	4480#	710#	*	*	10060#	580#	*	*

Table III. Nuclear-reaction and separation energies (continued, Explanation of Table on p. 030003-98)

A	Elt.	Z	S(n)	S(p)	$Q(4\beta^-)$		$Q(d,\alpha)$		$Q(p,\alpha)$		$Q(n,\alpha)$			
143	Te	52	1980#	710#	*	33660#	500#	9540#	710#	8530#	780#	*		
	I	53	3930#	430#	11550#	540#	27540#	200#	10570#	450#	10810#	210#	-1050#	630#
	Xe	54	3045	5	12720	370	21404	5	10435	17	8267	13	2020	60
	Cs	55	5232	10	9735	8	15393	8	11233	8	10175	8	1577	14
	Ba	56	4166	9	10712	10	10065	7	11251	11	7977	11	4696	7
	La	57	6219	10	7618	9	4789	8	12272	9	9962	11	4525	11
	Ce	58	5144.80	0.09	8871	6	-2090	3	12036	5	7573.3	2.9	7309	8
	Pr	59	7352.1	1.9	5824.0	1.9	-8827	11	13075.5	2.0	9871.9	2.0	6894.0	2.5
	Nd	60	6123.57	0.07	7503.7	1.4	-15770	200	12724.2	1.4	5550	6	9720.3	1.6
	Pm	61	9890	24	4299.6	2.7	-22540	50	11943	4	6162	5	7374	7
	Sm	62	8602	4	5664	24	-27348	13	11717	14	3561	24	10388	4
	Eu	63	11000	30	2544	11	-32190#	300#	12403	14	6079	17	9619	27
	Gd	64	9340	200	4210	200	-36970#	450#	12410	200	3620	210	12870	200
	Tb	65	11930	700	750	60	*	*	13520	50	6230	60	12210	70
	Dy	66	10120#	730#	2900	700	*	*	13080	110	3180	800	15260	30
	Ho	67	12870#	500#	-780#	790#	*	*	14050#	420#	5650#	500#	14080#	850#
Er	68	11300#	640#	1300#	570#	*	*	13820#	570#	2860#	640#	17220#	570#	
144	I	53	2720#	450#	12290#	640#	29570#	400#	11800#	640#	10070#	570#	-520#	640#
	Xe	54	4741	7	13530#	200#	23560	6	8610	370	7918	17	-740#	400#
	Cs	55	3667	22	10357	21	17479	20	12669	20	9790	20	2302	26
	Ba	56	5901	10	11381	10	11981	7	9458	10	7574	12	2077	8
	La	57	4749	15	8201	15	6566	13	13703	14	9747	14	5274	16
	Ce	58	6897	3	9549	8	1533.7	2.7	10303	7	7364	5	4947	6
	Pr	59	5753.6	2.8	6433	3	-5131	11	14493	3	9546.5	2.9	7828	5
	Nd	60	7817.04	0.05	7968.7	1.4	-11988	28	10750.3	1.4	7131.7	1.4	7331.4	1.6
	Pm	61	6526.8	1.5	4702.8	2.6	-19048	28	15244.7	2.6	7641	4	10246.0	3.0
	Sm	62	10519.7	2.3	6293.9	2.7	-25395	7	9887	24	3421	14	7873	3
	Eu	63	9449	15	3391	11	-31010	14	14078	11	5179	14	10550	18
	Gd	64	11600	200	4810	30	-35150#	200#	10260	40	3030	30	9821	29
	Tb	65	10020	60	1430	200	-40110#	400#	15300	40	5720	30	13200	30
	Dy	66	12472	15	3440	50	*	*	10700	700	2830	110	12301	21
	Ho	67	10630#	300#	-270	16	*	*	16220#	730#	5640#	300#	15580	110
	Er	68	13420#	450#	1850#	360#	*	*	11350#	450#	2620#	450#	14420#	360#
Tm	69	*	*	-1712	16	*	*	16480#	640#	*	*	17750#	570#	
145	I	53	3730#	640#	*	31900#	500#	10050#	710#	10300#	710#	*		
	Xe	54	2692	12	13500#	400#	25570	40	9850#	200#	8140	370	520#	500#
	Cs	55	4854	22	10471	11	19572	12	10859	10	10039	9	360	370
	Ba	56	3820	11	11534	22	13916	9	10870	11	7862	11	3360	9
	La	57	6057	18	8357	14	8432	13	11813	14	9871	14	3326	14
	Ce	58	4710	30	9510	40	3580	30	11820	30	7820	30	6420	30
	Pr	59	6947	7	6483	7	-1634	8	12692	7	9771	7	6045	9
	Nd	60	5755.31	0.23	7970.4	2.4	-8506	20	12347.1	1.4	7219.6	1.4	8747.6	2.2
	Pm	61	7922.7	1.5	4808.5	2.5	-14880	110	13445.6	2.5	9546.6	2.5	8166.4	2.9
	Sm	62	6757.10	0.30	6524.2	2.7	-22409	7	13020.1	2.7	5355	24	10945.1	0.8
	Eu	63	10444	11	3314.9	2.7	-28871	8	12236	4	5859	4	8797	24
	Gd	64	9240	30	4596	22	-33690#	200#	12026	23	3250	40	11707	20
	Tb	65	12090	110	1920	110	-38810#	220#	12550	230	5440	110	10570	110
	Dy	66	9744	10	3163	29	*	*	12890	50	3180	700	14363	29
	Ho	67	12582	11	-161	10	*	*	13760	15	5860#	730#	13090	700
	Er	68	10700#	280#	1920#	200#	*	*	13520#	360#	2870#	450#	16530#	760#
Tm	69	13400#	450#	-1736	7	*	*	14390#	450#	5310#	540#	15310#	450#	

Table III. Nuclear-reaction and separation energies (continued, Explanation of Table on p. 030003-98)

A	Elt.	Z	S(2n)	S(2p)	$Q(\alpha)$	$Q(2\beta^-)$	$Q(\epsilon p)$	$Q(\beta^- n)$						
143	Te	52	5930#	640#	*	-4260#	710#	19930#	500#	*	6420#	630#		
	I	53	6850#	200#	26100#	540#	-3270#	450#	17050#	200#	*	6530#	200#	
	Xe	54	8148	5	24290#	400#	-2423	6	13734	8	-21120#	500#	2240	8
	Cs	55	9341	12	22327	18	-1629	9	10496	11	-20190	370	2095	10
	Ba	56	10347	9	20318	7	-718	7	7669	7	-15997	7	-1984	9
	La	57	11383	8	18272	12	104	8	4897	7	-14946	10	-1710	8
	Ce	58	12316.4	2.5	16452	6	882.2	2.5	2395.6	2.2	-11053	6	-5890.5	2.5
	Pr	59	13195.2	1.9	14715	4	1733.1	2.5	-108	3	-10333	6	-5189.6	1.4
	Nd	60	15952	3	13147.3	1.6	521	7	-4485.1	2.5	-6758.0	2.2	-10932	24
	Pm	61	18580	14	11523	3	-567	8	-8719	11	-6462	3	-12045	4
	Sm	62	19726	9	9902	4	72	28	-11290	200	-856.1	2.5	-16270	30
	Eu	63	20458	17	8296	18	834	17	-13820	50	-388	26	-15350	30
	Gd	64	21150	200	6880	200	1720	200	-16060	200	3470	200	-19740	730
	Tb	65	22020	120	5070	50	2550	50	-18370#	300#	3610	60	-18370#	730#
	Dy	66	22930#	300#	3523	24	3040#	200#	-20910#	400#	7500	30	-22990#	400#
	Ho	67	23830#	500#	2090#	320#	3660#	420#	*	*	7220#	760#	-22090#	580#
	Er	68	*	460#	500#	3960#	640#	*	*	11570#	830#	*	*	*
144	I	53	6650#	550#	*	-3770#	720#	17990#	400#	*	*	6850#	400#	
	Xe	54	7785	6	25080#	500#	-2720	60	14895	9	-23880#	500#	2732	9
	Cs	55	8899	21	23080	380	-2090	23	11578	24	-19930#	200#	2595	21
	Ba	56	10067	9	21115	8	-1206	8	8665	8	-18853	9	-1667	10
	La	57	10968	14	18913	15	-224	15	5901	13	-14463	15	-1314	13
	Ce	58	12041	3	17168	7	413	8	3316.1	2.5	-13784	7	-5434.9	2.9
	Pr	59	13105.7	2.8	15304	7	1140	3	666	4	-9868	8	-4819.6	2.4
	Nd	60	13940.61	0.09	13792.7	2.2	1903.2	1.6	-1782.4	0.8	-9430.3	2.2	-8858.6	2.7
	Pm	61	16417	24	12206.6	3.0	847	7	-5797	11	-5636.8	3.0	-9970	4
	Sm	62	19121.7	2.7	10593.5	0.8	-132	4	-10206	28	-5252.3	0.8	-15796	11
	Eu	63	20450	30	9055	26	170	27	-13251	30	53	11	-15460	200
	Gd	64	20940	40	7351	28	1270	30	-15189	29	469	28	-19410	60
	Tb	65	21950	700	5630	40	2190	60	-17759	29	4580	30	-18270	30
	Dy	66	22590#	730#	4189	29	2787	29	-19960#	200#	4370	200	-22590#	300#
	Ho	67	23500#	400#	2630	700	3450	800	-22350#	400#	8520	50	-21420#	400#
	Er	68	24720#	540#	1070#	750#	3800#	450#	*	*	8270#	200#	*	*
	Tm	69	*	-410#	570#	4580#	640#	*	*	12500#	500#	*	*	*
145	I	53	6450#	540#	*	-4250#	710#	19120#	500#	*	*	7860#	500#	
	Xe	54	7433	12	25790#	500#	-3430#	400#	16023	14	*	*	3707	23
	Cs	55	8522	12	24000#	200#	-2553	18	12781	15	-22060#	400#	3641	11
	Ba	56	9722	11	21891	10	-1744	9	9550	30	-17933	10	-738	15
	La	57	10806	14	19738	14	-783	15	6791	14	-16853	24	-475	13
	Ce	58	11600	30	17710	30	240	30	4360	30	-12590	30	-4390	30
	Pr	59	12700	7	16032	10	881	8	1642	7	-12065	15	-3949	7
	Nd	60	13572.35	0.24	14403.2	2.2	1576.0	1.6	-780.6	0.9	-8289.1	2.6	-8087.2	2.7
	Pm	61	14449.5	2.1	12777.2	2.9	2323.3	2.9	-3276	4	-7806	3	-7373.3	2.5
	Sm	62	17276.8	2.4	11227.0	0.8	1116	3	-7725	20	-4192.3	0.8	-13104	11
	Eu	63	19893	11	9609	4	106	14	-11600	110	-3864	4	-14303	28
	Gd	64	20840	200	7987	20	583	21	-14684	21	1750	20	-18630	30
	Tb	65	22110	120	6730	110	1110	110	-17270	110	1940	110	-17890	110
	Dy	66	22216	15	4590	200	2557	21	-19000#	200#	6228	29	-21704	11
	Ho	67	23220#	300#	3280	50	3000	110	-21540#	200#	5959	29	-20580#	200#
	Er	68	24120#	450#	1650#	200#	3720#	360#	*	*	10040#	200#	-25050#	450#
	Tm	69	*	110#	360#	4360#	450#	*	*	9740#	200#	*	*	*

Table III. Nuclear-reaction and separation energies (continued, Explanation of Table on p.030003-98)

A	Elt.	Z	S(n)	S(p)	$Q(4\beta^-)$	$Q(d,\alpha)$	$Q(p,\alpha)$	$Q(n,\alpha)$						
146	Xe	54	4533	27	14310#	500#	27680	29	8040#	400#	7540#	200#	-2030#	500#
	Cs	55	3327	10	11106	12	21370	30	12273	6	9757	5	970#	200#
	Ba	56	5502	23	12182	23	15979	21	9035	29	7592	22	902	21
	La	57	4290	40	8820	30	10400	30	13430	30	9750	30	4270	30
	Ce	58	6640	40	10089	20	5361	17	9925	21	7400	18	3948	18
	Pr	59	5130	40	6900	50	440	40	14460	30	9790	30	7140	40
	Nd	60	7565.23	0.09	8589	7	-4840	4	10535.5	2.4	7006.4	1.4	6327.2	2.2
	Pm	61	6258	5	5311	4	-11690	50	15004	4	9412	4	9260	4
	Sm	62	8416.3	2.9	7018	4	-18441	7	11131	4	6828	4	8652.3	2.8
	Eu	63	7197	7	3755	6	-25879	9	15559	6	7264	6	11490	7
	Gd	64	11231	20	5383	5	-31764	8	10244	11	3020	12	9078	4
	Tb	65	9450	120	2130	50	-36710#	210#	14710	50	5330	210	12120	50
	Dy	66	12384	9	3460	110	*	*	10524	29	2730	50	11320	200
	Ho	67	10189	10	285	9	*	*	16043	10	5795	15	14830	50
	Er	68	13150#	200#	2491	10	*	*	10998	11	2590#	300#	13493	15
	Tm	69	11540#	280#	-896	6	*	*	16260#	280#	5070#	450#	16640#	360#
147	Xe	54	2480#	200#	*		29650#	200#	9290#	540#	7780#	450#	*	
	Cs	55	4681	9	11254	26	23524	18	10284	14	9816	10	-990#	400#
	Ba	56	3388	29	12243	20	17883	20	10501	22	7871	28	2255	20
	La	57	5700	40	9020	23	12364	11	11549	14	9953	13	2239	23
	Ce	58	4450	18	10250	30	7252	9	11532	15	7700	16	5400	11
	Pr	59	6830	40	7098	23	2101	16	12330	40	9852	16	5052	20
	Nd	60	5292.20	0.09	8750	30	-2789.8	1.5	12190	7	7467.8	2.4	7931.5	2.6
	Pm	61	7659	4	5405.4	0.5	-8300	8	13100.5	0.5	9569.8	0.4	7354.7	2.4
	Sm	62	6341.4	2.8	7101	4	-15070	9	12711.9	2.5	7013.8	2.7	10128.0	0.4
	Eu	63	8499	6	3837	4	-21788	6	13817.4	2.4	9284.8	2.4	9518	3
	Gd	64	7342	4	5528	6	-28750	40	13345.4	3.0	5126	11	12255.0	1.2
	Tb	65	11050	50	1946	9	-34768	11	12894	21	5881	29	10523	13
	Dy	66	9712	11	3720	50	*	*	12900	110	3036	29	13210	29
	Ho	67	12590	8	491	8	*	*	13196	8	5677	9	12257	28
	Er	68	10360	40	2660	40	*	*	13220	40	2870	40	15610	40
	Tm	69	12990#	200#	-1059	3	*	*	13980#	200#	5500#	200#	14282	11
148	Xe	54	4310#	360#	*		31800#	300#	*		7200#	590#	*	
	Cs	55	3062	16	11840#	200#	25624	20	11755	28	9446	17	-330#	500#
	Ba	56	5400	70	12960	60	19810	60	8430	60	7320	60	-450	60
	La	57	4102	22	9734	28	14157	20	12949	29	9671	21	2992	21
	Ce	58	6456	14	11009	15	8938	11	9360	40	7301	17	2764	14
	Pr	59	5163	22	7811	17	3764	18	13811	22	9400	40	5946	19
	Nd	60	7332.6	1.7	9253	16	-1138.7	1.8	9980	30	7082	7	5310	30
	Pm	61	5895	6	6008	6	-6329	14	14771	6	9430	6	8407	9
	Sm	62	8141.23	0.26	7583.0	0.4	-11477	9	10829	4	6795.3	2.5	7742.1	0.4
	Eu	63	6826	10	4322	10	-18310	80	15408	10	9216	10	10615	10
	Gd	64	8983.7	1.2	6013.5	2.4	-24790	10	11559	6	6586.2	2.7	10028.4	0.3
	Tb	65	7866	15	2469	13	-31772	16	16260	13	7253	23	13101	13
	Dy	66	11735	12	4406	12	-37530#	400#	10610	50	3390	110	10713	22
	Ho	67	10310	80	1080	80	*	*	15270	80	5120	80	14040	140
	Er	68	12940	40	3011	11	*	*	10470	12	2505	13	12410	12
	Tm	69	10862	12	-550	40	*	*	16268	12	5340#	200#	16001	13
Yb	70	*		1650#	400#	*	*	11440#	450#	2120#	450#	14560#	450#	

Table III. Nuclear-reaction and separation energies (continued, Explanation of Table on p.030003-98)

A	Elt.	Z	S(2n)	S(2p)	Q(α)	Q($2\beta^-$)	Q(ϵp)	Q($\beta^- n$)						
146	Xe	54	7225	25	*	-4010#	500#	16990	30	*	4028	26		
	Cs	55	8182	20	24610#	400#	-2970	370	13740	30	-21660#	500#	4134	9
	Ba	56	9323	22	22653	22	-2142	21	10688	26	-20743	24	-183	24
	La	57	10340	40	20360	40	-960	30	7630	50	-16280	30	-50	50
	Ce	58	11346	17	18446	18	-218	17	5290	16	-15408	18	-4081	18
	Pr	59	12070	30	16410	40	920	40	2770	40	-11130	40	-3320	30
	Nd	60	13320.54	0.24	15071.9	2.6	1182.4	2.2	70.4	2.8	-11150	30	-7729.7	2.5
	Pm	61	14181	5	13282	5	1908	4	-2337	7	-7117	8	-6874	4
	Sm	62	15173.4	2.8	11826.3	2.8	2528.8	2.8	-4911	5	-6853.3	2.8	-11076	4
	Eu	63	17641	12	10279	6	1600	24	-9350	50	-3139	6	-12263	21
	Gd	64	20469	28	8698	4	476	5	-13531	8	-2723	4	-17770	110
	Tb	65	21540	50	6720	50	1120	50	-16530	50	2940	40	-17590	50
	Dy	66	22127	10	5373	29	1980	29	-18233	9	3082	21	-21506	10
	Ho	67	22771	11	3448	29	2900	700	-20180#	200#	7860	110	-20070#	200#
Er	68	23860#	200#	2330	10	3370#	730#	*		6632	9	-24810#	200#	
Tm	69	24940#	450#	1020#	200#	3770#	450#	*		10780#	200#	*		
147	Xe	54	7010#	200#	*	-4510#	540#	17900#	200#	*	4880#	200#		
	Cs	55	8008	12	25560#	500#	-3720#	200#	14758	14	*	4956	22	
	Ba	56	8890	21	23349	23	-2486	20	11750	22	-19600	30	710	40
	La	57	9986	16	21202	14	-1428	13	8766	19	-18657	11	886	20
	Ce	58	11090	30	19076	12	-502	11	6133	9	-14356	23	-3400	40
	Pr	59	11961	17	17187	20	303	17	3598	16	-13680	40	-2590	16
	Nd	60	12857.43	0.12	15660	30	1035.0	2.2	1119.6	0.4	-9800	16	-6764	4
	Pm	61	13917.4	2.6	13994	7	1601.1	1.4	-1497.5	2.3	-9650	30	-6117.3	2.8
	Sm	62	14757.7	0.9	12412.3	0.4	2311.0	0.4	-3909.4	1.5	-5629.5	0.4	-10220	6
	Eu	63	15696	4	10855	3	2991	3	-6802	8	-5379	5	-9530	4
	Gd	64	18573	20	9283.6	1.3	1735.3	2.0	-11161	9	-1650	3	-15660	40
	Tb	65	20500	110	7329	9	1074	14	-14986	10	-914	10	-16259	11
	Dy	66	22096	11	5848	22	1610	200	-17590	40	4601	10	-21029	11
	Ho	67	22780	9	3950	110	2240	50	-19783	8	4720	50	-19506	8
Er	68	23510#	200#	2940	40	3140	40	*		8660	40	-23620#	200#	
Tm	69	24530#	200#	1432	10	3650#	300#	*		7975	9	*		
148	Xe	54	6790#	300#	*	*		18990#	310#	*	5250#	300#		
	Cs	55	7743	13	*	-4060#	400#	15798	23	*	5282	24		
	Ba	56	8790	70	24220	70	-3150	60	12800	60	-22520#	210#	1010	60
	La	57	9800	40	21976	20	-1862	28	9827	25	-18078	21	1234	21
	Ce	58	10906	20	20029	24	-1056	13	7010	11	-17423	23	-3026	19
	Pr	59	12000	40	18060	40	-111	20	4330	16	-13146	18	-2460	15
	Nd	60	12624.8	1.7	16351	16	599	3	1928.3	1.7	-12683	9	-6437.1	1.7
	Pm	61	13554	7	14760	40	1460	6	-566	11	-8711	17	-5671	6
	Sm	62	14482.6	2.8	12988.3	0.4	1986.8	0.4	-3066.9	0.9	-8478.5	0.4	-9862.8	2.3
	Eu	63	15324	12	11423	11	2692	10	-5762	16	-4546	10	-9014	10
	Gd	64	16326	4	9851.0	2.8	3271.29	0.03	-8410	9	-4291.9	0.9	-13598	8
	Tb	65	18920	50	7997	14	2657	16	-12550	80	-281	13	-14412	15
	Dy	66	21447	11	6352	10	1475	29	-16381	13	208	9	-20174	10
	Ho	67	22900	80	4810	100	1950	90	-19230	80	5460	80	-19450	90
Er	68	23300	12	3502	12	2666	13	-21150#	400#	5428	14	-23576	12	
Tm	69	23850#	200#	2105	12	3420	13	*		9703	11	*		
Yb	70	*		590#	400#	3850#	450#	*		8990#	400#	*		

Table III. Nuclear-reaction and separation energies (continued, Explanation of Table on p.030003-98)

A	Elt.	Z	S(n)	S(p)	$Q(4\beta^-)$	$Q(d,\alpha)$	$Q(p,\alpha)$	$Q(n,\alpha)$						
149	Cs	55	4410#	400#	11940#	500#	27790#	400#	9820#	450#	9570#	400#	*	
	Ba	56	3600	440	13500	440	21260	440	9510	440	7050	440	480	440
	La	57	5580	200	9920	210	15840	200	10750	200	9590	200	740	200
	Ce	58	4343	15	11250	22	10466	10	10719	15	7240	40	3924	23
	Pr	59	6575	18	7930	15	5402	11	11685	13	9460	19	3660	40
	Nd	60	5038.79	0.07	9129	15	752	4	11779	16	7170	30	6906	16
	Pm	61	7270	6	5945.2	2.5	-4576	4	12793.3	2.1	9725.7	2.1	6260	30
	Sm	62	5870.8	0.9	7559	6	-9440	9	12617.3	1.0	7183	4	9436.5	1.0
	Eu	63	8213	11	4394	4	-14795	13	13536	4	9419	5	8660	6
	Gd	64	6929	3	6117	10	-21385	28	13129	4	6855	7	11516	4
	Tb	65	9023	13	2508	3	-27610#	200#	14579	4	9461	5	11275	7
	Dy	66	7908	12	4448	15	-34500#	300#	13758	12	4930	50	14036	10
	Ho	67	11730	80	1076	12	*	*	13260	15	5772	14	11760	50
	Er	68	10334	30	3040	90	*	*	12726	28	2361	29	14460	29
Tm	69	13190#	200#	-310#	200#	*	*	13440#	200#	5300#	200#	13000#	200#	
Yb	70	10940#	500#	1720#	300#	*	*	13490#	300#	2720#	360#	16770#	300#	
150	Cs	55	2990#	570#	*	*	30130#	400#	11140#	500#	9050#	450#	*	
	Ba	56	4850#	530#	13940#	500#	23780#	300#	7720#	300#	6880#	300#	-1890#	360#
	La	57	3980	480	10300	620	17470	440	12170	440	9000	440	1440	440
	Ce	58	6248	16	11920	200	12204	12	8573	23	6696	16	1064	23
	Pr	59	5332	13	8920	14	6492	11	12809	14	8577	12	4024	14
	Nd	60	7375.6	1.9	9929	10	2084	6	9566	15	6628	16	3981	9
	Pm	61	5604	20	6511	20	-2491	21	14522	20	9414	20	7493	26
	Sm	62	7986.7	0.4	8275.9	1.9	-7742	4	10525	6	6855.2	0.9	6742.0	1.0
	Eu	63	6422	7	4945	6	-12846	15	15255	6	9338	6	9896	6
	Gd	64	8708	7	6612	7	-17933	18	11246	12	6645	6	9149	6
	Tb	65	7688	8	3268	8	-24620#	200#	15874	7	9115	7	12085	8
	Dy	66	9685	10	5110	5	-30670#	300#	11938	13	6297	9	11694	4
	Ho	67	8371	19	1539	17	-37310#	300#	16624	17	7114	17	14443	16
	Er	68	12160	30	3474	21	*	*	10870	90	2790	18	12011	19
Tm	69	10680#	280#	40#	200#	*	*	15700#	200#	4980#	200#	14910#	200#	
Yb	70	13510#	420#	2050#	360#	*	*	10840#	300#	2200#	300#	13620#	300#	
Lu	71	*	*	-1269.6	2.3	*	*	16400#	500#	*	*	16980#	300#	
151	Cs	55	4130#	640#	*	*	32550#	500#	*	*	9240#	580#	*	
	Ba	56	3110#	500#	14060#	570#	26000#	400#	9020#	570#	6840#	400#	-690#	500#
	La	57	5250	620	10700#	530#	20080	440	10520	620	9150	440	-750	440
	Ce	58	4450	21	12380	440	13351	18	9710	200	6348	26	2020	70
	Pr	59	6550	15	9222	17	7873	12	10601	16	8483	16	1576	23
	Nd	60	5334.55	0.10	9931	9	3245.7	2.8	10807	10	6456	15	5102	11
	Pm	61	7860	20	6995	4	-1763	6	11700	5	8886	5	4796	16
	Sm	62	5596.46	0.11	8268	20	-5824	3	12198.8	1.9	7153	6	8478.1	1.9
	Eu	63	7932	6	4890.7	0.5	-11030	8	13193.7	0.7	9547.5	1.0	7859	6
	Gd	64	6496	7	6685	7	-15922	17	12963	5	6975	10	10793.9	2.9
	Tb	65	8589	8	3149	7	-20851	20	14214	5	9510	4	10322	11
	Dy	66	7514	5	4936	8	-27210	300	13447	4	6649	13	13163.3	2.9
	Ho	67	9748	16	1602	9	-33510#	300#	14784	12	9101	12	12561	15
	Er	68	8506	24	3609	22	*	*	14091	20	4590	90	15240	19
Tm	69	12350#	200#	230	9	*	*	13680	30	5570	22	12860	90	
Yb	70	10980#	430#	2340#	360#	*	*	13050#	360#	2090	300	15580	300	
Lu	71	13540#	420#	-1241.0	1.8	*	*	13800#	420#	5090#	500#	14300#	300#	

Table III. Nuclear-reaction and separation energies (continued, Explanation of Table on p. 030003-98)

A	Elt.	Z	S(2n)		S(2p)		Q(α)		Q(2 β^-)		Q(ϵp)		Q($\beta^- n$)	
149	Cs	55	7470#	400#	*		-4740#	640#	16970#	450#	*		6270#	410#
	Ba	56	9000	440	25340#	480#	-4050	440	13550	440	-21810#	530#	1520	440
	La	57	9680	200	22880	200	-2590	200	10820	200	-20600	200	2110	200
	Ce	58	10799	13	20984	22	-1579	13	7706	10	-16370	60	-2206	18
	Pr	59	11738	19	18939	15	-629	16	5025	10	-15620	22	-1703	10
	Nd	60	12371.4	1.7	16940	9	270	30	2760.3	1.9	-11266	11	-5581	6
	Pm	61	13164.6	2.1	15198	16	1137	7	377	4	-10818	15	-4799.3	2.0
	Sm	62	14012.0	0.9	13566.9	1.0	1871.3	1.0	-2009	3	-7016.7	1.9	-8908	10
	Eu	63	15039	4	11977	4	2401	5	-4952	5	-6864	7	-8243	4
	Gd	64	15913	3	10439	3	3099	3	-7431	10	-3080	3	-12661	13
	Tb	65	16889	9	8522	4	4077.9	2.2	-9842	12	-2478	11	-11700	9
	Dy	66	19643	13	6917	9	2805	22	-13954	29	1284	9	-17780	80
	Ho	67	22032	13	5482	14	2320	110	-17760#	200#	1602	15	-18239	16
	Er	68	23280	50	4124	29	2076	29	-20540#	300#	6829	29	-23048	30
Tm	69	24050#	200#	2700#	200#	2810#	200#	*	*	6820#	210#	-21620#	450#	
Yb	70	*		1170#	300#	3620#	360#	*	*	10990#	300#	*	*	
150	Cs	55	7400#	400#	*		*		17960#	590#	*		6880#	590#
	Ba	56	8450#	310#	25880#	420#	-4370#	300#	14950#	300#	*		2250#	360#
	La	57	9560	440	23800	440	-3240	440	12170	440	-20170#	590#	2470	440
	Ce	58	10591	16	21830	60	-2325	24	8833	12	-19020	440	-1879	15
	Pr	59	11908	18	20170	21	-1680	30	5297	22	-15370	200	-1996	9
	Nd	60	12414.4	1.9	17859	11	-469	16	3371.38	0.20	-14299	10	-5686.8	1.9
	Pm	61	12874	21	15640	25	660	40	1195	21	-9847	22	-4533	20
	Sm	62	13857.5	0.9	14221.1	1.9	1449.8	1.0	-1287	6	-9964.6	1.9	-8681	4
	Eu	63	14636	12	12504	8	2237	7	-3687	9	-6017	6	-7737	7
	Gd	64	15637	6	11006	6	2807	6	-6454	7	-5917	6	-12347	7
	Tb	65	16711	14	9384	12	3587	5	-9160	16	-1954	8	-11481	12
	Dy	66	17593	10	7618	4	4351.3	1.5	-11478	18	-1472	5	-15734	13
	Ho	67	20100	90	5987	19	3390	50	-15460#	200#	2254	15	-16280	30
	Er	68	22495	20	4550	19	2299	18	-19190#	300#	2576	19	-22020#	200#
	Tm	69	23870#	200#	3080#	210#	2320#	200#	-21850#	360#	7870#	200#	-21360#	360#
	Yb	70	24450#	500#	1740#	300#	3260#	300#	*	*	7810#	300#	*	*
Lu	71	*		450#	300#	3990#	360#	*	*	11950#	360#	*	*	
151	Cs	55	7120#	640#	*		*		19080#	660#	*		7600#	580#
	Ba	56	7960#	590#	*		-5010#	450#	16290#	400#	*		3120#	590#
	La	57	9230	480	24640#	590#	-3820	440	13470	440	-22430#	590#	3470	440
	Ce	58	10698	20	22680	440	-3386	27	9718	18	-18610#	300#	-996	20
	Pr	59	11883	15	21140	200	-2526	16	6606	13	-17940	440	-1171	12
	Nd	60	12710.2	1.9	18851	10	-1354	9	3633.29	0.24	-13385	12	-5417	20
	Pm	61	13464	5	16925	11	-367	16	1267	5	-12375	10	-4406	4
	Sm	62	13583.2	0.4	14778.8	1.9	1145.6	1.0	-387.5	2.8	-8185.50	0.22	-7855	6
	Eu	63	14354	4	13166.5	2.0	1964.5	1.1	-3029	4	-8345	20	-6960	6
	Gd	64	15204	4	11630.9	2.8	2652.7	2.9	-5436	4	-4426.6	2.8	-11154	8
	Tb	65	16277	5	9760	5	3496	4	-8001	9	-4120	7	-10385	6
	Dy	66	17199	10	8203	4	4179.6	2.6	-10486	17	-277	7	-14878	15
	Ho	67	18119	15	6712	9	4695.0	1.8	-12850	21	194	11	-13863	19
	Er	68	20670	30	5148	19	3505	19	-16720	300	3754	17	-19850#	200#
	Tm	69	23030#	200#	3704	23	2559	20	-20660#	300#	3884	16	-20210#	300#
	Yb	70	24490#	430#	2380	300	2640	300	*	*	9000	300	-24970#	430#
Lu	71	*		800#	360#	3440#	300#	*	*	9090#	360#	*	*	

Table III. Nuclear-reaction and separation energies (continued, Explanation of Table on p. 030003-98)

A	Elt.	Z	S(n)	S(p)	$Q(4\beta^-)$	$Q(d,\alpha)$	$Q(p,\alpha)$	$Q(n,\alpha)$						
152	Cs	55	2770#	710#	*	34830#	500#	*	*	*				
	Ba	56	4840#	570#	14770#	640#	28440#	400#	7170#	570#	6400#	570#	*	
	La	57	4050#	530#	11640#	500#	21960#	300#	11320#	420#	8690#	530#	-390#	500#
	Ce	58	5830#	200#	12960#	480#	15780#	200#	7860#	480#	6100#	280#	-210#	480#
	Pr	59	5050	22	9822	26	9130	19	11800	22	7776	21	2110	200
	Nd	60	7278	24	10659	27	4558	24	8862	26	5754	26	2167	27
	Pm	61	5939	26	7600	26	-540	50	13136	26	7985	26	5432	28
	Sm	62	8257.6	0.6	8666	5	-4645	5	9545	20	6165.7	2.0	5259.3	1.9
	Eu	63	6306.72	0.10	5600.9	0.5	-9283	13	14873.7	0.6	9111.5	0.7	8822.4	2.0
	Gd	64	8589.5	2.9	7343.0	0.7	-14207	9	10796	6	6598	4	8075.2	0.7
	Tb	65	7160	40	3820	40	-19000	70	15760	40	9270	40	11370	40
	Dy	66	9437	5	5783	6	-23850	150	11699	9	6235	5	10656	5
	Ho	67	8053	15	2141	13	-30180#	200#	16416	13	8955	15	13530	13
	Er	68	10305	19	4167	12	*	*	12156	17	6010	12	12842	12
	Tm	69	9020	60	740	60	*	*	16820	60	6890	60	15570	60
	Yb	70	12800	340	2790	150	*	*	10930#	250#	2480#	250#	13120	150
	Lu	71	11390#	360#	-830#	360#	*	*	15930#	360#	4640#	360#	16110#	280#
153	Ba	56	2830#	570#	14830#	640#	30860#	400#	8470#	640#	6560#	570#	*	
	La	57	4840#	420#	11640#	500#	24590#	300#	9590#	500#	8710#	420#	-2240#	500#
	Ce	58	4000#	280#	12910#	360#	17650#	200#	9110#	480#	6080#	480#	640#	360#
	Pr	59	5882	22	9880#	200#	11799	12	10367	21	8142	17	210	440
	Nd	60	5252	25	10861	19	5552.3	3.0	10160	12	5834	9	3163	12
	Pm	61	7465	27	7787	26	666	10	11006	9	7896	9	3299	13
	Sm	62	5868.40	0.13	8594	26	-3417	4	11537	5	5902	20	6766.5	0.7
	Eu	63	8550.28	0.12	5893.6	0.7	-8355	5	11919.9	0.6	8548.0	0.6	5876	20
	Gd	64	6246.95	0.13	7283.3	0.7	-12414	9	12481.1	0.7	6774	6	9815.0	0.6
	Tb	65	8670	40	3895	4	-17340	13	13586	5	9315	7	9125	7
	Dy	66	7096	6	5710	40	-21940#	200#	13191	6	6827	8	12267	7
	Ho	67	9479	13	2183	7	-26640	150	14451	6	9162	6	11740	9
	Er	68	8040	12	4153	15	-33170#	300#	13865	12	6341	17	14487	10
	Tm	69	10320	60	762	12	*	*	15004	20	8722	21	13619	19
	Yb	70	9010#	250#	2780#	200#	*	*	14280#	200#	4150#	280#	16270#	200#
	Lu	71	13020#	250#	-609	10	*	*	13880	340	5130#	340#	13760#	250#
	Hf	72	*	*	1170#	360#	*	*	13520#	420#	2200#	420#	16990#	420#
154	Ba	56	4420#	640#	*	33010#	500#	6820#	710#	6270#	710#	*		
	La	57	3540#	420#	12350#	500#	26980#	300#	10890#	500#	8270#	500#	-1650#	580#
	Ce	58	5380#	280#	13450#	360#	20240#	200#	7780#	360#	5960#	480#	-1630#	450#
	Pr	59	4610	110	10480#	230#	13630	110	11590#	230#	7980	110	850	450
	Nd	60	6570	50	11550	50	7880	50	8640	60	5820	50	1050	60
	Pm	61	5940	50	8470	50	1640	60	12350	50	7300	50	3910	50
	Sm	62	7966.8	0.8	9096	9	-2061	7	9510	26	5795	5	4134.2	1.1
	Eu	63	6442.22	0.24	6467.4	0.7	-7099	8	13735.3	0.7	7702.2	0.6	7294	5
	Gd	64	8894.72	0.17	7627.7	0.7	-11101	5	9893.1	0.7	5811.0	0.7	6516.7	0.7
	Tb	65	6910	50	4560	50	-15730	50	15260	50	8900	50	10140	50
	Dy	66	9322	8	6370	8	-20462	19	11030	40	6094	8	9441	8
	Ho	67	7699	10	2785	9	-24920#	200#	16189	9	8977	9	12631	9
	Er	68	10208	10	4882	7	-29940#	300#	11711	13	5882	9	11794	6
	Tm	69	8525	19	1247	17	*	*	16784	17	8703	22	14842	17
	Yb	70	10800#	200#	3248	21	*	*	12500	60	5705	9	13981	24
	Lu	71	9410#	250#	-204	14	*	*	17270#	250#	6690#	360#	16700#	200#
	Hf	72	13440#	420#	1590#	340#	*	*	11460#	360#	2300#	420#	14520#	430#

Table III. Nuclear-reaction and separation energies (continued, Explanation of Table on p. 030003-98)

A	Elt.	Z	S(2n)		S(2p)		Q(α)		Q(2 β^-)		Q(ϵp)		Q($\beta^- n$)	
152	Cs	55	6900#	640#	*	*	*	20360#	580#	*	7940#	640#		
	Ba	56	7950#	500#	*	*	-5540#	500#	17270#	450#	*	3530#	590#	
	La	57	9300#	530#	25700#	500#	-4800#	300#	14470#	300#	-22350#	580#	3860#	300#
	Ce	58	10280#	200#	23660#	360#	-3810#	210#	11170#	200#	-21330#	450#	-270#	200#
	Pr	59	11600	21	22210	440	-3474	27	7500	30	-17740	440	-886	19
	Nd	60	12612	24	19880	27	-2176	27	4613	24	-16210	30	-4835	25
	Pm	61	13800	30	17532	27	-1144	30	1634	26	-11764	28	-4749	26
	Sm	62	13854.1	0.6	15660.8	0.6	220.5	1.9	-55.69	0.18	-11108.6	0.7	-8181.1	0.7
	Eu	63	14239	6	13869	20	1553	6	-2170	40	-6791	5	-6770.8	2.8
	Gd	64	15086	6	12233.7	0.6	2204.4	1.0	-4589	5	-7419.6	0.6	-11155	4
	Tb	65	15750	40	10500	40	3160	40	-7110	40	-3350	40	-10040	40
	Dy	66	16951	6	8932	7	3727	4	-9617	10	-3218	5	-14566	9
	Ho	67	17802	19	7077	15	4507.4	1.3	-11880	60	730	13	-13410	21
	Er	68	18812	19	5769	10	4934.3	1.6	-14230	150	963	9	-17799	21
Tm	69	21370#	200#	4350	60	3850	100	-18300#	200#	4610	50	-18250	310	
Yb	70	23780#	340#	3020	150	2780	150	*	*	4710	150	-24230#	340#	
Lu	71	24930#	360#	1510#	280#	2920#	200#	*	*	10060#	200#	*	*	
153	Ba	56	7670#	570#	*	*	*	18440#	450#	*	4750#	500#		
	La	57	8890#	530#	26410#	580#	-5230#	500#	15510#	300#	-24420#	580#	4850#	360#
	Ce	58	9830#	200#	24550#	450#	-4210#	480#	12420#	200#	-20490#	450#	780#	200#
	Pr	59	10931	17	22840	440	-3770	200	9079	15	-19570#	300#	510	27
	Nd	60	12530	3	20683	18	-3085	11	5229	3	-15640#	200#	-4147	26
	Pm	61	13404	10	18446	15	-2033	13	2719	9	-14179	21	-3957	9
	Sm	62	14126.0	0.6	16194.6	0.7	-609.1	1.9	322.87	0.25	-9699	24	-7742.7	0.7
	Eu	63	14857.00	0.16	14559	5	272.1	2.0	-2054	4	-9402	26	-6731.6	0.7
	Gd	64	14836.4	2.9	12884.2	0.6	1828.3	0.7	-3740	4	-5408.92	0.22	-10240	40
	Tb	65	15832	6	11238	4	2703	5	-6301	6	-5714	4	-9267	6
	Dy	66	16533	5	9532	5	3559	4	-8674	10	-1725	4	-13609	13
	Ho	67	17532	10	7967	6	4052	4	-11039	13	-1580	40	-12583	10
	Er	68	18345	19	6294	10	4802.4	1.4	-13260#	200#	2360	10	-16820	50
	Tm	69	19343	23	4929	15	5248.3	1.5	-15600	150	2342	16	-15770	150
Yb	70	21810#	360#	3520#	200#	4110#	200#	-19910#	360#	6000#	200#	-21860#	280#	
Lu	71	24410#	340#	2180	150	3090#	250#	*	*	6060	140	*	*	
Hf	72	*	*	340#	430#	3470#	420#	*	*	11680#	340#	*	*	
154	Ba	56	7250#	640#	*	*	*	19400#	540#	*	5170#	580#		
	La	57	8380#	420#	27180#	580#	-5790#	500#	16580#	320#	*	5310#	360#	
	Ce	58	9380#	280#	25090#	450#	-4740#	360#	13610#	210#	-23040#	450#	1280#	200#
	Pr	59	10490	110	23390#	320#	-4400	450	10410	100	-19330#	320#	1150	110
	Nd	60	11820	60	21420#	210#	-3400	50	6630	50	-18200#	210#	-3250	50
	Pm	61	13400	50	19330	50	-2640	50	3230	50	-14230	50	-4020	50
	Sm	62	13835.2	0.8	16884	24	-1200.3	1.1	1250.8	0.9	-12414	3	-7159.3	1.1
	Eu	63	14992.50	0.27	15062	26	-566	20	-1580	50	-8379	9	-6926.9	0.7
	Gd	64	15141.67	0.21	13521.29	0.27	920.3	0.7	-3312	7	-8435.2	0.3	-10464	4
	Tb	65	15580	60	11850	50	2210	50	-5520	50	-4080	50	-9080	50
	Dy	66	16419	9	10265	7	2945	5	-7789	9	-4800	7	-13453	9
	Ho	67	17177	15	8500	40	4041	4	-10212	17	-615	9	-12242	12
	Er	68	18247	10	7065	6	4279.7	2.6	-12673	18	-751	6	-16703	13
	Tm	69	18850	60	5400	19	5093.8	2.6	-14710#	200#	3296	15	-15290#	200#
Yb	70	19800	150	4010	19	5474.3	1.7	-17260#	300#	3248	20	-19630	150	
Lu	71	22440#	280#	2570#	200#	4350#	280#	*	*	6970#	200#	-20490#	360#	
Hf	72	*	*	980#	340#	3540#	420#	*	*	7250#	360#	*	*	

Table III. Nuclear-reaction and separation energies (continued, Explanation of Table on p. 030003-98)

A	El.	Z	S(n)	S(p)	$Q(4\beta^-)$	$Q(d,\alpha)$	$Q(p,\alpha)$	$Q(n,\alpha)$						
155	La	57	4470#	500#	12400#	640#	29010#	400#	9250#	570#	8640#	570#	-3350#	640#
	Ce	58	3630#	360#	13540#	420#	22410#	300#	8990#	420#	6370#	420#	-420#	500#
	Pr	59	5380	110	10490#	200#	16403	17	10210#	200#	8430#	200#	-480#	300#
	Nd	60	4530	50	11470	110	9786	9	9996	15	6338	21	2340#	200#
	Pm	61	6500	50	8400	50	4310	11	11101	5	8074	25	2465	19
	Sm	62	5806.96	0.27	8970	50	-1035	10	11168	9	5927	26	5605	24
	Eu	63	8151.3	0.4	6651.9	1.2	-5779	17	11452.4	0.8	7808.6	0.8	5082	26
	Gd	64	6435.24	0.18	7620.7	0.8	-9861	6	12008.1	0.7	5682.4	0.7	8339.1	0.3
	Tb	65	9170	50	4833	10	-14624	14	12343	10	8321	10	7285	10
	Dy	66	6833	12	6290	50	-18653	19	12869	10	6430	40	11198	10
	Ho	67	9472	19	2935	19	-23494	26	13814	18	8942	18	10320	40
	Er	68	7675	8	4859	10	-28040#	300#	13514	8	6260	14	13555	7
	Tm	69	10270	17	1310	11	-32700#	300#	14553	14	8739	13	12625	16
	Yb	70	8642	24	3364	22	*	*	14182	20	6080	60	15644	19
	Lu	71	10900#	200#	-98	8	*	*	15370#	200#	8590	150	14820	60
	Hf	72	9570#	420#	1740#	360#	*	*	14910#	330#	4120#	360#	17750#	330#
Ta	73	*	*	-1453	15	*	*	14080#	420#	*	*	15140#	360#	
156	La	57	3190#	570#	*	*	31110#	400#	10480#	640#	8280#	570#	*	*
	Ce	58	5110#	420#	14180#	500#	24540#	300#	7420#	420#	6100#	420#	-2700#	500#
	Pr	59	4220#	200#	11080#	360#	18520#	200#	11360#	280#	8210#	280#	140#	360#
	Nd	60	6260	200	12350	200	12060	200	8340	230	5960	200	80#	280#
	Pm	61	5295	6	9169	10	5927	5	12370	50	8031	4	3051	12
	Sm	62	7241	9	9709	10	1169	8	9860	50	6151	12	3616	9
	Eu	63	6336	3	7181	4	-4600	60	13083	4	7341	3	6212	10
	Gd	64	8536.35	0.07	8005.8	0.9	-8323	25	9914.0	0.8	5696.4	0.8	5671.2	0.4
	Tb	65	6912	10	5310	4	-13256	15	14326	4	7656	4	8923	4
	Dy	66	9445	10	6568	10	-17263	9	10340	50	5648	4	7999.99	0.27
	Ho	67	7510	60	3610	60	-21780	80	15630	60	8530	60	11480	60
	Er	68	10074	25	5460	30	-26390	150	11138	26	5664	25	10578	25
	Tm	69	8280	17	1914	16	-30970#	300#	16481	15	8498	17	13824	15
	Yb	70	10834	19	3929	14	*	*	11872	17	5572	12	12849	12
	Lu	71	9230	60	490	60	*	*	16940	60	8370#	200#	15920	60
	Hf	72	11720#	330#	2560	150	*	*	12610#	250#	5420	9	15040#	250#
Ta	73	10000#	420#	-1020	4	*	*	17520#	420#	6300#	420#	18160#	330#	
157	Ce	58	3180#	500#	14170#	570#	26750#	400#	8710#	570#	6460#	500#	-1460#	640#
	Pr	59	5040#	360#	11010#	420#	20920#	300#	9950#	420#	8540#	360#	-1360#	420#
	Nd	60	4060	200	12180#	200#	14362	25	9660	30	6510	120	1400#	200#
	Pm	61	6205	8	9110	200	8466	7	10697	12	8390	50	1450	110
	Sm	62	5388	10	9803	6	2747	7	10973	6	6700	50	4790	50
	Eu	63	7448	5	7387	9	-2626	24	11443	4	7860	4	4700	50
	Gd	64	6359.88	0.15	8030	3	-7410	27	11705.4	0.9	5778.7	0.8	7278.1	0.9
	Tb	65	8744	4	5517.5	0.3	-12054	28	12017.3	0.3	7806.6	0.4	6621.1	0.8
	Dy	66	6967	5	6623	6	-16003	12	12536	11	5600	50	9928	5
	Ho	67	9430	60	3593	23	-20392	26	13034	25	8425	25	8970	50
	Er	68	7270	40	5220	70	-24510#	200#	13340	30	6090	28	12627	28
	Tm	69	9950	30	1790	40	-29120	150	14211	29	8760	28	11576	29
	Yb	70	8227	14	3876	18	-33950#	400#	13915	15	5869	18	14830	12
	Lu	71	10810	60	464	12	*	*	14773	21	8356	21	13633	19
	Hf	72	9160#	250#	2490#	200#	*	*	14350#	200#	5676	14	16680#	200#
	Ta	73	11800#	330#	-935	10	*	*	15290#	330#	7940#	340#	15770#	250#
W	74	*	*	900#	500#	*	*	15170#	500#	*	*	18850#	500#	

Table III. Nuclear-reaction and separation energies (continued, Explanation of Table on p. 030003-98)

A	Elt.	Z	S(2n)		S(2p)		Q(α)		Q($2\beta^-$)		Q(ϵp)		Q($\beta^- n$)	
155	La	57	8010#	500#	*		-6130#	640#	17490#	400#	*		6220#	450#
	Ce	58	9010#	360#	25890#	500#	-5270#	500#	14500#	300#	-22250#	580#	2250#	320#
	Pr	59	9989	21	23930#	300#	-4530	440	11525	18	-21180#	300#	2340	60
	Nd	60	11096	10	21950#	200#	-3484	20	7907	9	-17350#	200#	-1840	50
	Pm	61	12435	10	19949	13	-2585	13	4878	5	-16120	110	-2556	5
	Sm	62	13773.8	0.9	17438	3	-1672.7	1.1	1879.1	0.9	-11650	50	-6524.0	1.1
	Eu	63	14593.5	0.5	15748	9	-857	5	-568	10	-10600	50	-6183.5	0.9
	Gd	64	15329.96	0.25	14088.1	0.4	81.5	0.7	-2914	10	-6903.7	0.9	-9980	50
	Tb	65	16079	11	12461	10	978	10	-5211	17	-6801	10	-8927	12
	Dy	66	16155	10	10851	10	2608	10	-6946	11	-2739	10	-12588	13
	Ho	67	17170	18	9304	18	3159	18	-9414	20	-3170	50	-11506	18
	Er	68	17883	11	7644	7	4118	5	-11707	18	896	9	-15853	16
	Tm	69	18795	16	6192	11	4572	5	-14081	22	724	13	-14765	20
	Yb	70	19440#	200#	4612	19	5338.8	2.1	-16330#	300#	4813	17	-18860#	200#
Lu	71	20310	150	3150	23	5802.8	2.6	-18620#	300#	4593	16	-17950#	300#	
Hf	72	23010#	420#	1540#	360#	4950#	420#	*	*	8470#	300#	*	*	
Ta	73	*		130#	340#	3760#	420#	*	*	8500#	360#	*	*	
156	La	57	7660#	500#	*		-6550#	640#	18520#	450#	*		6660#	500#
	Ce	58	8740#	360#	26580#	580#	-5530#	500#	15650#	360#	*		2520#	300#
	Pr	59	9610#	230#	24620#	360#	-4700#	360#	12600#	200#	-20930#	450#	2650#	200#
	Nd	60	10790	210	22830#	280#	-3920#	280#	8890	200	-19980#	360#	-1610	200
	Pm	61	11790	50	20640	110	-2830	19	5919	5	-16037	18	-2044	4
	Sm	62	13048	9	18110	50	-1636	26	3174	8	-14366	13	-5614	8
	Eu	63	14487	3	16150	50	-1253	26	8	5	-10432	6	-6084	3
	Gd	64	14971.59	0.19	14657.7	0.9	-197.2	0.3	-2005.95	0.10	-9633.1	0.9	-9356	10
	Tb	65	16080	50	12931	4	373	4	-4610	60	-5562	4	-9007	10
	Dy	66	16278	7	11400.95	0.22	1753.0	0.3	-6317	25	-5748.05	0.12	-12561	17
	Ho	67	16980	60	9900	80	2810	70	-8640	60	-1520	60	-11340	60
	Er	68	17749	25	8396	26	3481	25	-10946	26	-2345	26	-15657	27
	Tm	69	18550	20	6773	16	4345	7	-13140	60	1916	23	-14403	22
	Yb	70	19476	20	5239	11	4810	4	-15450	150	1654	11	-18792	21
Lu	71	20130#	200#	3850	60	5596	3	-17840#	300#	5640	60	-17600#	300#	
Hf	72	21290#	340#	2460	150	6029	4	*	*	5400	150	-21960#	340#	
Ta	73	*		720#	360#	5140#	360#	*	*	9400#	300#	*	*	
157	Ce	58	8290#	500#	*		-5890#	570#	16530#	400#	*		3570#	450#
	Pr	59	9270#	300#	25190#	500#	-4910#	420#	13760#	300#	-22780#	500#	3860#	360#
	Nd	60	10320	27	23260#	300#	-3980#	200#	10216	25	-18930#	300#	-369	25
	Pm	61	11500	8	21460	19	-3153	14	7162	8	-18020#	200#	-1008	11
	Sm	62	12629	5	18972	10	-1772	5	4146	5	-13490	200	-4666	6
	Eu	63	13783	4	17097	6	-1236	10	1305	4	-12584	6	-4995	4
	Gd	64	14896.23	0.16	15210.6	0.9	-688.7	0.4	-1399	5	-8752	8	-8804	4
	Tb	65	15656	10	13523.3	0.9	178.9	0.8	-3931	23	-7970	3	-8305.8	0.3
	Dy	66	16412	11	11933	5	1033	5	-6011	27	-4179	5	-12020	60
	Ho	67	16936	29	10161	25	2056	24	-8120	40	-4031	24	-10690	30
	Er	68	17347	27	8836	28	3304	27	-9992	29	-174	27	-14650	30
	Tm	69	18226	30	7250	30	3878	28	-12270	30	-520	70	-13515	29
	Yb	70	19062	20	5791	12	4622	6	-14520#	200#	3501	27	-17790	60
	Lu	71	20038	23	4393	16	5107.9	2.9	-16850	150	3105	17	-16690	150
Hf	72	20880#	360#	2980#	200#	5880	3	-19430#	450#	7070#	200#	-21110#	360#	
Ta	73	21810#	340#	1630	150	6355	6	*	*	6820	140	*	*	
W	74	*		-120#	500#	5410#	500#	*	*	11060#	430#	*	*	

Table III. Nuclear-reaction and separation energies (continued, Explanation of Table on p. 030003-98)

A	Elt.	Z	S(n)	S(p)	$Q(4\beta^-)$	$Q(d,\alpha)$	$Q(p,\alpha)$	$Q(n,\alpha)$						
158	Ce	58	4800#	570#	*	28590#	400#	7100#	570#	6140#	570#	*		
	Pr	59	3860#	420#	11690#	500#	22930#	300#	11200#	420#	8310#	420#	-750#	500#
	Nd	60	5660#	200#	12800#	360#	16640#	200#	8220#	280#	6230#	200#	-630#	360#
	Pm	61	4863	15	9917	28	10381	14	12100	200	8059	16	1972	22
	Sm	62	6644	7	10242	9	5157	5	9624	6	6554	7	2680	10
	Eu	63	5868	11	7867	11	-1068	29	12816	13	7800	10	5331	11
	Gd	64	7937.39	0.06	8520	4	-5386	25	10104	3	5992.6	0.9	5147.7	0.9
	Tb	65	6778.6	1.0	5936.2	1.0	-10767	25	13775.1	1.0	7463.3	1.0	7993.8	1.3
	Dy	66	9054	5	6932.9	2.4	-14397	8	10394	4	5707	10	7308.9	2.4
	Ho	67	7430	40	4052	27	-18980	30	15052	27	7832	29	10709	29
	Er	68	9960	40	5760	30	-23200	30	10890	70	5600	30	9498	27
	Tm	69	8070	40	2580	40	-27540#	200#	16220	40	8370	26	12980	30
	Yb	70	10660	13	4590	29	-32380#	300#	11535	16	5480	12	11845	10
	Lu	71	8843	19	1079	19	*	*	16764	18	8154	22	15060	18
	Hf	72	11270#	200#	2951	21	*	*	12310	60	5307	8	14047	24
Ta	73	9650#	250#	-448	13	*	*	17360#	250#	7870#	360#	17030#	200#	
W	74	12230#	500#	1330#	340#	*	*	12940#	420#	5160	15	16180#	420#	
159	Pr	59	4830#	500#	11720#	570#	24960#	400#	9550#	570#	8600#	500#	-2390#	570#
	Nd	60	3820#	360#	12770#	420#	18750#	300#	9440#	420#	6630#	360#	660#	420#
	Pm	61	5536	17	9790#	200#	12978	10	10618	27	8780	200	660#	200#
	Sm	62	5029	8	10408	15	6959	6	10800	9	6820	7	3910	200
	Eu	63	6859	11	8082	7	1286	5	11345	6	8181	10	3767	6
	Gd	64	5943.21	0.08	8595	10	-4000	4	11608	4	6385	3	6445	8
	Tb	65	8133.0	0.6	6131.8	0.8	-8962	28	12001.9	0.8	7866.6	0.8	6197	3
	Dy	66	6831.1	2.6	6985.4	1.3	-13329	18	12307.1	1.3	5788	4	9014.2	1.3
	Ho	67	9213	27	4211	4	-17620	40	12806	6	8063.5	3.0	8408	5
	Er	68	7329	25	5662	27	-21708	17	12983	24	5780	60	11614	4
	Tm	69	9940	40	2560	40	-26130	30	13550	40	8510	40	10550	70
	Yb	70	7900	19	4420	30	-30540#	300#	13580	30	5860	23	14020	30
	Lu	71	10570	40	990	40	-34960#	310#	14420	40	8420	40	12770	40
	Hf	72	8822	24	2929	23	*	*	14299	21	5710	60	16060	19
	Ta	73	11340#	200#	-374	9	*	*	15180#	200#	8240	150	14910	60
W	74	9730#	420#	1420#	360#	*	*	15010#	330#	5431	6	18170#	330#	
Re	75	*	*	-1600#	50#	*	*	15440#	500#	*	*	16760#	430#	
160	Pr	59	3500#	570#	*	26960#	400#	10850#	570#	8270#	570#	*		
	Nd	60	5400#	420#	13330#	500#	20810#	300#	7910#	420#	6270#	420#	-1560#	500#
	Pm	61	4520#	200#	10480#	360#	14830#	200#	11760#	280#	8320#	200#	1190#	360#
	Sm	62	6098	8	10969	12	9438	6	9565	15	6926	9	1873	26
	Eu	63	5508	10	8562	11	2902	18	12481	11	8061	10	4463	12
	Gd	64	7451.6	0.7	9187	4	-1878	24	10024	10	6381	4	4382	5
	Tb	65	6375.21	0.13	6563.8	0.8	-7530	30	13564.1	0.8	7851.3	0.8	7269	4
	Dy	66	8576.9	1.4	7429.3	1.2	-11510	7	10508.7	1.3	5954.8	1.2	6797.1	1.1
	Ho	67	7125	15	4505	15	-16110	60	14735	15	7906	16	10027	15
	Er	68	9575	25	6024	24	-20125	26	10830	40	5630	30	9007	25
	Tm	69	7800	40	3030	30	-24480	60	15710	40	7980	40	12180	40
	Yb	70	10395	19	4881	29	-28840	150	11251	26	5411	29	10897	27
	Lu	71	8630	70	1720	60	-33530#	300#	16450	60	8020	60	14090	60
	Hf	72	11158	19	3520	40	*	*	11984	18	5366	12	13129	14
	Ta	73	9460	60	260	60	*	*	16990	60	7940#	200#	16260	60
W	74	12100#	330#	2180	150	*	*	12550#	250#	5131	9	15220#	250#	
Re	75	10070#	430#	-1267	7	*	*	17610#	420#	7600#	500#	18500#	330#	

Table III. Nuclear-reaction and separation energies (continued, Explanation of Table on p. 030003-98)

A	Elt.	Z	S(2n)	S(2p)	$Q(\alpha)$	$Q(2\beta^-)$	$Q(\epsilon p)$	$Q(\beta^- n)$						
158	Ce	58	7980#	500#	*	-6270#	640#	17400#	450#	*	3810#	500#		
	Pr	59	8910#	360#	25860#	500#	-5230#	420#	14760#	300#	*	4060#	300#	
	Nd	60	9720#	280#	23810#	360#	-4260#	280#	11200#	200#	-21410#	450#	170#	200#
	Pm	61	11068	14	22100#	200#	-3410	110	8166	17	-17840#	300#	-483	14
	Sm	62	12032	10	19350	200	-1850	50	5439	5	-16078	25	-3863	6
	Eu	63	13315	11	17669	11	-1170	50	2215	10	-12247	12	-4503	10
	Gd	64	14297.27	0.16	15907	8	-659.3	0.9	-282.2	2.4	-11301	5	-7997.4	0.3
	Tb	65	15523	4	13966	4	-157.5	1.2	-3283	27	-7301	4	-8117	5
	Dy	66	16021.0	2.4	12450.4	2.4	873.7	2.4	-5104	25	-6872.8	2.4	-11646	24
	Ho	67	16850	70	10675	27	1540	50	-7480	40	-2713	27	-10850	40
	Er	68	17230	40	9353	25	2665	26	-9294	26	-3168	26	-14670	40
	Tm	69	18011	29	7800	70	3511	27	-11491	29	840	30	-13353	27
	Yb	70	18887	12	6376	26	4170	7	-13908	19	114	28	-17641	14
	Lu	71	19660	60	4956	21	4790	5	-16050#	200#	4210	30	-16380#	200#
	Hf	72	20430	150	3415	20	5404.8	2.7	-18470#	300#	4031	21	-20580	150
	Ta	73	21450#	360#	2050#	200#	6124	4	*	*	7990#	200#	-19770#	450#
	W	74	*	*	390#	340#	6613	3	*	*	7980#	360#	*	*
159	Pr	59	8690#	500#	*	-5580#	570#	15470#	400#	*	4900#	450#		
	Nd	60	9490#	300#	24460#	500#	-4450#	420#	12400#	300#	-20440#	500#	1210#	300#
	Pm	61	10400	12	22590#	300#	-3564	20	9489	11	-19510#	300#	625	11
	Sm	62	11673	7	20324	26	-2349	11	6354	6	-15440#	200#	-3024	12
	Eu	63	12727	4	18324	8	-1528	6	3489	4	-14243	14	-3425	4
	Gd	64	13880.60	0.11	16462	5	-795.5	0.9	605.7	1.3	-10600	5	-7162.1	1.0
	Tb	65	14911.6	0.8	14651	4	-139.2	1.1	-2202.8	2.9	-9566	10	-7196.3	2.4
	Dy	66	15885	5	12921.6	1.3	477.8	1.3	-4606	3	-5766.6	1.3	-11051	27
	Ho	67	16639	24	11144	3	1496	10	-6759	28	-5147.8	3.0	-10097	25
	Er	68	17290	27	9714	6	2170	10	-8722	18	-1443	4	-13929	25
	Tm	69	18000	40	8320	40	3040	30	-10860	50	-1670	40	-12631	29
	Yb	70	18559	21	7000	30	3946	19	-12986	24	2180	30	-16698	23
	Lu	71	19410	40	5580	50	4490	40	-15270	40	1710	50	-15680	40
	Hf	72	20090#	200#	4009	20	5225.1	2.7	-17560#	300#	5869	19	-19760#	200#
	Ta	73	20990	150	2577	23	5681	6	-19690#	310#	5484	17	-18880#	300#
	W	74	21970#	500#	970#	360#	6450	4	*	*	9520#	300#	*	*
	Re	75	*	*	-270#	340#	6760#	60#	*	*	9130#	360#	*	*
160	Pr	59	8330#	500#	*	-5900#	570#	16480#	450#	*	5220#	500#		
	Nd	60	9220#	360#	25050#	500#	-4740#	420#	13100#	300#	*	1350#	300#	
	Pm	61	10060#	200#	23250#	360#	-3860#	280#	10480#	200#	-19200#	450#	1130#	200#
	Sm	62	11127	8	20760#	200#	-2190	200	7707	6	-17720#	300#	-2263	7
	Eu	63	12368	14	18969	16	-1742	10	4356	10	-14215	14	-2990	10
	Gd	64	13394.8	0.7	17269	5	-1006	9	1731.0	1.2	-13023	6	-6480.7	1.0
	Tb	65	14508.2	0.7	15159	10	-179	3	-1454	15	-9082	4	-6740.4	1.2
	Dy	66	15408.0	2.3	13561.1	1.1	437.3	1.1	-3609	24	-8400.3	1.1	-10415	3
	Ho	67	16340	30	11490	15	1283	15	-6080	40	-4139	15	-9893	15
	Er	68	16900	30	10235	24	2040	24	-7902	25	-4186	24	-13570	40
	Tm	69	17740	40	8690	40	2750	70	-10030	70	-260	30	-12530	40
	Yb	70	18295	11	7437	26	3624	26	-12224	12	-891	8	-16530	40
	Lu	71	19200	60	6140	60	4140	60	-14450	80	3010	60	-15490	60
	Hf	72	19979	20	4507	12	4901.9	2.6	-16610	150	2611	20	-19571	22
	Ta	73	20800#	200#	3190	60	5451	5	-19090#	300#	6600	70	-18600#	300#
	W	74	21840#	340#	1800	150	6066	5	*	*	6240	150	-22650#	340#
	Re	75	*	*	150#	360#	6698	4	*	*	10410#	300#	*	*

Table III. Nuclear-reaction and separation energies (continued, Explanation of Table on p.030003-98)

A	Elt.	Z	S(n)	S(p)	$Q(4\beta^-)$	$Q(d,\alpha)$	$Q(p,\alpha)$	$Q(n,\alpha)$						
161	Nd	60	3530#	500#	13360#	570#	22920#	400#	9210#	570#	6610#	500#	-280#	570#
	Pm	61	5310#	360#	10390#	420#	17230#	300#	10280#	420#	8680#	360#	-260#	420#
	Sm	62	4508	9	10960#	200#	11384	7	10593	12	7281	15	3030#	200#
	Eu	63	6382	14	8846	12	5406	11	11127	12	8323	11	2944	17
	Gd	64	5635.4	1.0	9314	10	-304	9	11248	4	6613	10	5391	5
	Tb	65	7696.6	0.6	6808.8	1.0	-5563	28	11810.7	1.0	8092.0	1.0	5440	10
	Dy	66	6454.39	0.08	7508.5	1.2	-10216	15	12187.4	1.2	6278.9	1.3	8280.1	1.1
	Ho	67	8886	15	4813.5	2.2	-14635	28	12680.7	2.6	8074	3	7919.8	2.5
	Er	68	7209	26	6108	17	-18887	24	12839	9	5850	28	10852	9
	Tm	69	9670	40	3120	40	-23120	40	13373	28	8270	40	9940	40
	Yb	70	7748	17	4830	40	-27280#	200#	13440	30	5728	30	13111	30
	Lu	71	10360	60	1689	29	-31720	150	13990	30	8312	29	11790	40
	Hf	72	8447	24	3330	60	-36340#	400#	14100	40	5762	27	15342	24
	Ta	73	11030	60	129	23	*		14784	30	8190	30	14080	29
	W	74	9300#	250#	2020#	200#	*		14600#	200#	5475	12	17190#	200#
Re	75	12170#	330#	-1197	5	*		15170#	330#	7660#	340#	15970#	250#	
Os	76	*		530#	500#	*		15480#	500#	*		19300#	500#	
162	Nd	60	5030#	570#	*		24730#	400#	7680#	570#	6400#	570#	*	
	Pm	61	4210#	420#	11070#	500#	19310#	300#	11480#	420#	8300#	420#	370#	500#
	Sm	62	5930#	200#	11580#	360#	13650#	200#	9180#	280#	6890#	200#	920#	360#
	Eu	63	4980	40	9320	40	7340	40	12240	40	8370	40	3500	40
	Gd	64	6846	4	9778	11	2054	4	9911	10	6627	6	3574	7
	Tb	65	6290	40	7460	40	-4200	40	12980	40	7750	40	6010	40
	Dy	66	8196.99	0.06	8008.9	1.3	-8355	15	10365.6	1.2	6214.9	1.2	6026.4	1.1
	Ho	67	6916	4	5275	3	-13210	80	14342	3	7990	3	9137	3
	Er	68	9204	9	6426.2	2.2	-17166	9	10759	15	5859	3	8479.0	1.5
	Tm	69	7650	40	3565	27	-21700	60	15300	40	7947	26	11498	26
	Yb	70	10058	21	5220	30	-25827	23	11190	40	5610	30	10381	16
	Lu	71	8340	80	2280	80	-30330#	210#	16040	80	7870	80	13390	80
	Hf	72	10926	24	3896	29	-34730#	300#	11810	60	5400	40	12316	20
	Ta	73	9070	60	750	60	*		16870	50	7940	50	15570	60
	W	74	11520#	200#	2510	30	*		12540	60	5304	9	14500	24
Re	75	9730#	250#	-765	11	*		17540#	250#	7660#	360#	17580#	200#	
Os	76	12530#	500#	890#	340#	*		13010#	420#	5170#	50#	16500#	420#	
163	Pm	61	4950#	500#	10990#	570#	21350#	400#	10050#	570#	8750#	500#	-1080#	570#
	Sm	62	4260#	360#	11640#	420#	15660#	300#	10230#	420#	7150#	360#	2060#	420#
	Eu	63	5850	70	9240#	210#	9890	70	10900	70	8610	70	2160#	210#
	Gd	64	5105	9	9900	40	3854	10	11188	13	7031	13	4567	10
	Tb	65	6990	40	7605	6	-1867	7	11621	4	8210	4	4531	10
	Dy	66	6271.01	0.05	7990	40	-7082	15	11791.2	1.3	6319.1	1.2	7207.0	1.2
	Ho	67	8408	3	5485.83	0.05	-11587	28	12388.27	0.08	8158.45	0.11	7104.3	1.2
	Er	68	6905	5	6415	6	-15904	25	12740	5	6079	16	10151	5
	Tm	69	9322	27	3683	5	-20190	40	13184	10	8200	25	9300	16
	Yb	70	7544	21	5110	30	-24390	50	13310	30	5870	40	12412	29
	Lu	71	10030	80	2250	30	-28790	30	13760	30	8235	29	11160	40
	Hf	72	8166	26	3720	80	-33070#	300#	14010	40	5870	60	14545	26
	Ta	73	10830	60	650	40	*		14490	40	8270	40	13380	70
	W	74	8980	60	2420	70	*		14580	60	5780	80	16680	50
	Re	75	11570#	200#	-708	6	*		15260#	200#	8190	150	15470	60
Os	76	9820#	420#	980#	360#	*		15360#	330#	5410	11	18780#	330#	

Table III. Nuclear-reaction and separation energies (continued, Explanation of Table on p.030003-98)

A	Elt.	Z	S(2n)		S(2p)		Q(α)		Q(2 β^-)		Q(ϵp)		Q($\beta^- n$)	
161	Nd	60	8920#	500#	*		-5080#	570#	14080#	400#	*		2340#	450#
	Pm	61	9820#	300#	23730#	500#	-4120#	420#	11560#	300#	-21000#	500#	1930#	300#
	Sm	62	10607	9	21440#	300#	-2635	26	8834	7	-16830#	300#	-1263	12
	Eu	63	11891	11	19815	14	-1919	13	5670	10	-16080#	200#	-1921	10
	Gd	64	13087.0	1.2	17876	6	-1253	5	2550.0	1.6	-12560	6	-5740.9	1.4
	Tb	65	14071.9	0.6	15996	4	-428	4	-264.3	2.5	-11270	10	-5860.2	1.3
	Dy	66	15031.3	1.4	14072.3	1.1	342.8	1.1	-2854	9	-7403.0	1.2	-9744	15
	Ho	67	16010	4	12242.8	2.4	1141.2	2.4	-5299	28	-6650.0	2.4	-9204	24
	Er	68	16783	9	10612	9	1798	10	-7362	18	-2818	9	-12970	40
	Tm	69	17470	40	9147	28	2510	40	-9340	40	-2800	30	-11807	29
	Yb	70	18143	23	7856	16	3150	30	-11525	27	936	29	-15640	60
	Lu	71	19000	50	6570	40	3720	40	-13780	40	450	40	-14695	30
	Hf	72	19605	28	5054	29	4682	24	-15760#	200#	4559	24	-18560	60
	Ta	73	20480	30	3650	40	5237	24	-17940	150	4200	60	-17520	150
	W	74	21400#	360#	2280#	200#	5923	4	-20580#	450#	8100#	200#	-21890#	360#
	Re	75	22240#	340#	980	150	6328	7	*	*	7690	140	*	*
Os	76	*		-740#	500#	7066	12	*	*	12060#	430#	*	*	
162	Nd	60	8560#	500#	*		-5320#	570#	14980#	450#	*		2610#	500#
	Pm	61	9510#	360#	24430#	500#	-4470#	420#	12330#	300#	*		2230#	300#
	Sm	62	10440#	200#	21970#	360#	-2900#	280#	9750#	200#	-19230#	450#	-810#	200#
	Eu	63	11370	40	20280#	200#	-2040	40	6970	50	-15760#	300#	-1270	40
	Gd	64	12481	4	18624	7	-1455	6	3901	4	-14897	8	-4890	4
	Tb	65	13980	40	16770	40	-850	40	370	40	-11170	40	-5690	40
	Dy	66	14651.38	0.10	14817.7	1.2	83.2	1.1	-1846.96	0.30	-9964.6	1.6	-9055.5	2.2
	Ho	67	15801	15	12783	3	1004	3	-4564	26	-5869	3	-8911	9
	Er	68	16413	24	11239.7	0.3	1647.9	2.3	-6508	15	-5567.7	0.3	-12507	28
	Tm	69	17320	40	9670	30	2280	40	-8650	80	-1569	26	-11710	30
	Yb	70	17806	17	8340	29	3053	30	-10657	18	-1914	18	-15340	30
	Lu	71	18700	90	7110	80	3450	80	-13050	90	1780	80	-14590	80
	Hf	72	19373	13	5584	11	4416	5	-15170	20	1381	18	-18461	26
	Ta	73	20100	80	4090	80	5010	50	-17280#	200#	5490	60	-17300#	200#
	W	74	20820	150	2638	20	5678.3	2.4	-19560#	300#	5026	29	-21230	150
	Re	75	21910#	360#	1260#	200#	6240	5	*	*	8990#	200#	-20590#	450#
Os	76	*		-310#	340#	6767	3	*	*	8830#	360#	*	*	
163	Pm	61	9160#	500#	*		-4590#	570#	13240#	410#	*		3210#	450#
	Sm	62	10190#	300#	22710#	500#	-3340#	420#	10590#	300#	-18460#	500#	-90#	300#
	Eu	63	10840	70	20830#	310#	-2360	70	8110	70	-17400#	310#	-280	70
	Gd	64	11951	9	19220	11	-1531	10	5067	8	-14070#	200#	-3710	40
	Tb	65	13277	4	17382	11	-978	6	1782	4	-13180	40	-4486	4
	Dy	66	14468.00	0.08	15453.3	1.6	-244.6	1.1	-1213	5	-9390	4	-8411	3
	Ho	67	15323.7	2.2	13494.7	1.3	729.1	1.2	-3650	5	-7990	40	-8115.1	0.3
	Er	68	16109	10	11690	5	1574	5	-5869	16	-4275	5	-11761	26
	Tm	69	16973	28	10109	6	2176	6	-7937	28	-3976	6	-10974	16
	Yb	70	17602	21	8675	18	2837	16	-10035	29	-254	15	-14540	80
	Lu	71	18370	40	7470	40	3350	40	-12260	50	-600	40	-13694	29
	Hf	72	19090	30	6002	29	4150	30	-14360	60	3274	29	-17550	60
	Ta	73	19900	50	4550	50	4749	5	-16530	40	3010	80	-16610	40
	W	74	20500#	200#	3170	60	5520	50	-18720#	300#	6970	50	-20480#	200#
	Re	75	21300	150	1800	30	6012	8	*	*	6490	50	-19630#	300#
	Os	76	22360#	500#	220#	360#	6677	8	*	*	10520#	300#	*	*

Table III. Nuclear-reaction and separation energies (continued, Explanation of Table on p. 030003-98)

A	Elt.	Z	S(n)	S(p)	$Q(4\beta^-)$	$Q(d,\alpha)$	$Q(p,\alpha)$	$Q(n,\alpha)$						
164	Pm	61	3690#	570#	*	23210#	410#	11390#	570#	8580#	570#	*		
	Sm	62	5450#	420#	12140#	500#	17870#	300#	8980#	420#	7000#	420#	130#	500#
	Eu	63	4970#	130#	9950#	320#	11600#	110#	11860#	230#	8160#	110#	2500#	320#
	Gd	64	6530#	100#	10580#	120#	6170#	100#	9640#	110#	6880#	100#	2540#	100#
	Tb	65	5550	100	8050	100	-170	100	12910	100	8290	100	5360	100
	Dy	66	7658.11	0.07	8661	4	-4951	15	10420	40	6357.7	1.3	5184.3	1.6
	Ho	67	6674.5	1.4	5889.3	1.4	-10339	28	13910.8	1.4	7938.4	1.4	8126.5	1.8
	Er	68	8846	5	6853.52	0.13	-14124	16	10809	3	6118.4	2.2	7759.31	0.15
	Tm	69	7247	25	4025	25	-18620	40	15141	24	8162	26	10940	24
	Yb	70	9790	21	5578	16	-22782	18	11170	30	5750	30	9831	18
	Lu	71	7920	40	2630	30	-27170	60	15890	30	8060	30	12900	40
	Hf	72	10626	29	4320	30	-31400	150	11720	80	5610	30	11667	22
	Ta	73	8820	50	1310	40	-35940#	320#	16597	29	7900	40	14930	40
	W	74	11400	50	2990	40	*	*	12260	50	5407	23	13725	24
	Re	75	9540	60	-150	80	*	*	17240	60	7950#	200#	16950	60
	Os	76	12300#	330#	1710	150	*	*	12790#	250#	5282	6	15780#	250#
	Ir	77	*	*	-1560#	100#	*	*	17810#	440#	7500#	510#	19140#	350#
165	Sm	62	3780#	500#	12230#	570#	19800#	400#	10150#	570#	7430#	500#	1390#	570#
	Eu	63	5410#	180#	9910#	330#	14180#	140#	10710#	330#	8670#	240#	1290#	330#
	Gd	64	4750#	160#	10360#	170#	8070#	120#	10740#	140#	7120#	130#	3720#	230#
	Tb	65	6560#	140#	8080#	150#	2360#	100#	11460#	100#	8580#	100#	3780#	110#
	Dy	66	5715.96	0.05	8820	100	-3317	27	11694	4	6930	40	6314	4
	Ho	67	7988.8	1.1	6220.0	0.8	-8457	27	12193.0	0.8	8146.5	0.8	6420	40
	Er	68	6650.0	0.6	6829.1	1.5	-12886	28	12567.5	0.6	6384	3	9306.3	0.6
	Tm	69	9097	24	4275.7	1.6	-17082	14	12949	5	8269.0	1.6	8758	4
	Yb	70	7350	30	5680	40	-21430	40	13144	27	6050	40	11686	27
	Lu	71	9870	40	2710	30	-25780	40	13570	30	8250	30	10680	40
	Hf	72	7890	30	4280	40	-29840#	200#	13870	40	6060	80	13840	30
	Ta	73	10640	30	1318	20	-34260#	160#	14127	28	8185	17	12630	80
	W	74	8697	27	2870	40	*	*	14380	50	5780	60	15954	27
	Re	75	11260	60	-287	23	*	*	14960	60	8203	29	14770	60
	Os	76	9440#	250#	1610#	200#	*	*	14920#	200#	5570	10	17850#	200#
Ir	77	12320#	350#	-1540#	50#	*	*	15310#	340#	7710#	340#	16560#	250#	
166	Sm	62	4990#	570#	*	21860#	400#	8850#	570#	7380#	570#	*		
	Eu	63	4560#	380#	10690#	540#	15860#	360#	11610#	470#	8380#	470#	1690#	540#
	Gd	64	6150#	230#	11100#	240#	10400#	200#	9560#	230#	6820#	210#	1840#	360#
	Tb	65	5390#	120#	8720#	140#	4000	70	12600#	120#	8290	70	4250	100
	Dy	66	7043.5	0.4	9310#	100#	-989	7	10200	100	6875	4	4375	8
	Ho	67	6243.64	0.02	6747.7	0.8	-7050	30	13607.4	0.8	8173.9	0.8	7171	4
	Er	68	8475.7	1.3	7316.0	0.9	-11067	28	10766.3	1.5	6316.3	1.1	7101.5	1.1
	Tm	69	7030	12	4656	12	-15790	30	14765	12	8143	12	10136	12
	Yb	70	9372	27	5955	7	-19708	12	11019	25	5997	9	9218	8
	Lu	71	7650	40	3010	40	-24130	80	15710	30	8140	30	12350	30
	Hf	72	10290	40	4710	40	-28430	30	11490	40	5800	40	11090	30
	Ta	73	8320	30	1750	40	-32740#	200#	16430	30	8030	40	14340	40
	W	74	11098	27	3329	17	-37160#	300#	12106	30	5510	40	13022	27
	Re	75	9310	80	320	80	*	*	17050	70	7880	90	16290	80
	Os	76	11710#	200#	2061	30	*	*	12750	60	5435	5	15120	60
	Ir	77	9830#	250#	-1152	8	*	*	17780#	250#	7700#	360#	18300#	200#
	Pt	78	*	*	430#	340#	*	*	13330#	440#	*	*	17110#	420#

Table III. Nuclear-reaction and separation energies (continued, Explanation of Table on p. 030003-98)

A	Elt.	Z	S(2n)		S(2p)		$Q(\alpha)$		$Q(2\beta^-)$		$Q(\epsilon p)$		$Q(\beta^-n)$	
164	Pm	61	8640#	500#	*		-4780#	570#	14510#	420#	*		3780#	500#
	Sm	62	9720#	360#	23130#	500#	-3390#	420#	11670#	320#	*		310#	310#
	Eu	63	10820#	120#	21590#	320#	-2800#	230#	8700#	150#	-17420#	420#	-140#	110#
	Gd	64	11640#	100#	19820#	220#	-1960#	100#	6190#	100#	-16340#	320#	-3250#	100#
	Tb	65	12540	110	17950	110	-1020	100	2900	100	-12880	120	-3770	100
	Dy	66	13929.12	0.08	16266	4	-451.1	1.2	-25.08	0.11	-11943	8	-7660.95	0.07
	Ho	67	15083	3	13880	40	429.8	1.8	-3077	24	-7674	4	-7885	5
	Er	68	15751.0	0.3	12339.35	0.14	1304.92	0.17	-4925	15	-6850.69	0.13	-11285	5
	Tm	69	16570	40	10440	25	2054	29	-7260	40	-2815	24	-10676	29
	Yb	70	17334	21	9261	15	2622	29	-9199	22	-3139	16	-14300	30
	Lu	71	17950	80	7740	40	3230	40	-11360	40	797	28	-13450	40
	Hf	72	18792	18	6570	22	3919	17	-13583	19	192	22	-17360	40
	Ta	73	19650	60	5030	80	4560	60	-15810	60	4220	40	-16450	60
	W	74	20379	20	3645	13	5278.3	2.0	-17810	150	3739	27	-20305	21
	Re	75	21110#	200#	2270	80	5926	5	-20130#	320#	7770	70	-19350#	300#
	Os	76	22120#	340#	1000	150	6479	5	*	*	7200	160	*	*
	Ir	77	*	*	-580#	370#	6970#	100#	*	*	11370#	320#	*	*
165	Sm	62	9230#	500#	*		-3650#	570#	12650#	420#	*		1500#	420#
	Eu	63	10380#	150#	22050#	420#	-2910#	330#	9840	90	-19140#	420#	980#	170#
	Gd	64	11280#	120#	20310#	320#	-2210#	120#	7160#	120#	-15640#	320#	-2450#	160#
	Tb	65	12110#	100#	18660#	120#	-1200#	100#	4330#	100#	-14470#	150#	-2670#	100#
	Dy	66	13374.07	0.09	16877	8	-531.7	1.6	909.0	0.6	-11130#	100#	-6702.4	1.4
	Ho	67	14663.3	0.8	14881	4	137.7	1.5	-1969.4	1.8	-10110	100	-7027.4	0.8
	Er	68	15497	5	12718.4	0.6	1109.3	0.6	-4226	27	-5842.6	0.6	-10689	24
	Tm	69	16344	6	11129.2	1.6	1842.7	2.7	-6487	27	-5237.1	2.2	-9984	15
	Yb	70	17140	30	9706	27	2481	28	-8660	40	-1641	27	-13720	40
	Lu	71	17790	40	8291	27	3030	40	-10594	30	-1830	40	-12700	30
	Hf	72	18510	40	6910	30	3780	30	-12770	40	2090	30	-16420	40
	Ta	73	19460	40	5630	30	4290	30	-15188	27	1510	30	-15683	17
	W	74	20100	60	4180	40	5029	30	-17070#	200#	5669	30	-19460	60
	Re	75	20800	30	2700	40	5694	6	-19070#	160#	5330	40	-18310	150
	Os	76	21750#	360#	1470#	200#	6335	6	*	*	9150#	200#	-22520#	370#
	Ir	77	*	*	170#	160#	6820#	50#	*	*	8590#	150#	*	*
	166	Sm	62	8770#	500#	*		-3600#	570#	13800#	450#	*		1920#
Eu		63	9970#	380#	22920#	540#	-3260#	470#	10680#	370#	*		1170#	380#
Gd		64	10900#	220#	21010#	360#	-2430#	280#	8060#	200#	-18010#	450#	-2040#	220#
Tb		65	11950	120	19080#	130#	-1610	80	5190	70	-14450#	150#	-2340	70
Dy		66	12759.5	0.4	17390#	100#	-729	4	2341.3	1.2	-13420#	120#	-5757.1	0.9
Ho		67	14232.5	1.1	15570	100	180	40	-1183	12	-9800#	100#	-6621.0	1.0
Er		68	15125.8	1.1	13536.0	1.1	830.5	1.1	-3330	7	-8602.4	1.1	-10067.7	2.1
Tm		69	16127	27	11485	12	1728	12	-5870	30	-4278	12	-9664	29
Yb		70	16721	17	10231	7	2314	7	-7737	29	-4363	7	-13225	27
Lu		71	17520	40	8690	40	3030	40	-9920	40	-380	30	-12460	40
Hf		72	18180	30	7420	30	3540	30	-11971	30	-850	40	-16080	30
Ta		73	18960	40	6030	40	4310	80	-14200	80	3060	40	-15310	40
W		74	19795	14	4647	18	4856	4	-16457	20	2459	30	-19300	25
Re		75	20560	90	3190	80	5460	50	-18540#	210#	6670	70	-18170#	210#
Os		76	21150	150	1774	20	6143	3	-20700#	300#	6140	30	-21910#	160#
Ir		77	22150#	370#	460#	200#	6722	6	*	*	10020#	200#	*	*
Pt		78	*	*	-1120#	340#	7286	15	*	*	9780#	360#	*	*

Table III. Nuclear-reaction and separation energies (continued, Explanation of Table on p.030003-98)

A	Elt.	Z	S(n)	S(p)	Q(4β ⁻)		Q(d,α)	Q(p,α)	Q(n,α)					
167	Eu	63	4870#	540#	10570#	570#	18270#	400#	10510#	570#	8960#	500#	510#	570#
	Gd	64	4360#	360#	10890#	470#	12480#	300#	10620#	330#	7430#	320#	2940#	420#
	Tb	65	6110#	210#	8690#	280#	6620#	200#	11240#	230#	8710#	220#	3100#	230#
	Dy	66	5420	60	9330	90	660	60	11350#	120#	7010	120	5490#	120#
	Ho	67	7281	5	6985	5	-4780	30	12043	5	8551	5	5440	100
	Er	68	6436.46	0.18	7508.8	0.9	-9823	28	12318.6	0.9	6554.4	1.5	8323.2	1.1
	Tm	69	8727	12	4906.6	1.5	-14193	28	12688.8	1.5	8263.3	1.4	8084.3	1.9
	Yb	70	7066	8	5991	12	-18493	19	13050	4	6178	25	10999	4
	Lu	71	9550	40	3190	30	-22670#	50#	13510	40	8380	40	10050	40
	Hf	72	7680	40	4740	40	-26970	80	13690	40	6040	40	13200	30
	Ta	73	10320	40	1780	40	-31280	30	14000	40	8330	30	11940	40
	W	74	8281	21	3290	30	-35490#	300#	14461	23	6050	30	15367	24
	Re	75	11010#	80#	230#	40#	*		14740#	50#	8270#	40#	14100#	50#
	Os	76	9140	70	1900	100	*		14870	80	5830	90	17380	70
	Ir	77	11790#	200#	-1070	4	*		15430#	200#	8210	150	16050	60
	Pt	78	9950#	430#	550#	360#	*		15690#	340#	5600#	110#	19460#	340#
168	Eu	63	3800#	640#	*		20320#	500#	11700#	640#	8930#	640#	*	
	Gd	64	5620#	500#	11640#	570#	14630#	400#	9560#	540#	7230#	420#	1090#	570#
	Tb	65	4870#	360#	9200#	420#	8590#	300#	12520#	360#	8590#	320#	3650#	330#
	Dy	66	6700	150	9920#	240#	3020	140	10040	160	6870#	170#	3540#	190#
	Ho	67	5850	30	7420	70	-2990	50	13230	30	8420	30	6150#	110#
	Er	68	7771.31	0.12	8000	5	-7631	28	10791.0	0.9	6771.9	0.9	6267.8	1.1
	Tm	69	6840.6	1.8	5310.7	1.9	-12919	28	14323.9	1.9	8072.7	1.9	9232.5	1.8
	Yb	70	9063	4	6327.2	1.5	-16689	13	11017	12	6211.8	2.1	8586.1	1.3
	Lu	71	7640	50	3770	40	-21270	50	15240	40	8090	50	11510	40
	Hf	72	9960	40	5150	40	-25365	30	11370	40	5950	40	10580	40
	Ta	73	8110	40	2220	40	-29730	60	16180	40	8110	40	13690	40
	W	74	10866	23	3830	30	-33890	150	11920	30	5819	18	12390	30
	Re	75	9040#	50#	990	40	*		16800	30	7930	40	15700	30
	Os	76	11560	70	2450#	40#	*		12610	70	5529	22	14512	27
	Ir	77	9670	60	-550	90	*		17480	60	7990#	200#	17640	60
	Pt	78	12470#	340#	1220	150	*		13060#	250#	5450#	50#	16430#	250#
169	Gd	64	3860#	640#	11700#	710#	16770#	500#	10570#	640#	7920#	620#	2220#	640#
	Tb	65	5680#	420#	9250#	500#	10950#	300#	11200#	420#	9070#	360#	2530#	470#
	Dy	66	5110	330	10160#	420#	4780	300	11040#	360#	7150	310	4580#	360#
	Ho	67	6810	40	7530	140	-713	20	11840	60	8652	20	4730	70
	Er	68	6003.25	0.15	8150	30	-6206	28	12068	5	7012.3	0.9	7308.1	1.2
	Tm	69	8033.6	1.5	5573.0	1.1	-10985	28	12726.8	1.1	8514.9	1.1	7442.5	1.1
	Yb	70	6866.98	0.15	6353.6	1.9	-15460	15	12876.9	1.5	6375	12	10194.9	0.4
	Lu	71	9090	40	3792	3	-19675	12	13217	5	8375	8	9450	12
	Hf	72	7430	40	4940	50	-23990	40	13500	40	6170	40	12525	29
	Ta	73	9970	40	2220	40	-28200	40	13890	40	8430	40	11380	40
	W	74	8096	20	3810	30	-32410#	200#	14140	30	6040	30	14590	30
	Re	75	10690	30	805	16	-36620#	300#	14400	22	8343	15	13330	30
	Os	76	8799	27	2220	40	*		14820#	50#	6030	80	16812	27
	Ir	77	11500	60	-612	22	*		15120	80	8202	29	15450	80
	Pt	78	9580#	250#	1140#	200#	*		15270#	200#	5706	9	18570#	200#
	Au	79	*		-1930#	330#	*		15540#	430#	7810#	420#	17210#	360#

Table III. Nuclear-reaction and separation energies (continued, Explanation of Table on p. 030003-98)

A	Elt.	Z	S(2n)		S(2p)		Q(α)		Q($2\beta^-$)		Q(ϵp)		Q($\beta^- n$)	
167	Eu	63	9430#	420#	*		-3190#	570#	11920#	450#	*		2450#	450#
	Gd	64	10500#	320#	21580#	500#	-2520#	420#	9120#	300#	-17370#	500#	-1000#	310#
	Tb	65	11500#	220#	19780#	240#	-1870#	210#	6350#	200#	-16010#	410#	-1410#	200#
	Dy	66	12460	60	18060#	140#	-1040	60	3360	60	-12690#	210#	-4930	60
	Ho	67	13524	5	16290#	100#	-109	7	263	5	-11680	70	-5426	5
	Er	68	14912.2	1.3	14256.5	1.1	665.1	1.1	-2701	4	-7995.4	1.2	-9474	12
	Tm	69	15756.7	2.0	12222.6	1.5	1409.8	1.4	-5040	30	-6761.3	1.5	-9019	7
	Yb	70	16438	27	10647	4	2152	6	-7123	28	-2954	4	-12640	30
	Lu	71	17200	40	9150	30	2800	30	-9150	40	-2900	30	-11710	40
	Hf	72	17970	40	7750	40	3410	30	-11370	30	839	29	-15440	40
	Ta	73	18650	30	6490	40	4020	40	-13520#	50#	380	40	-14534	30
	W	74	19380	30	5040	30	4741	28	-15600	70	4470	30	-18280	70
	Re	75	20310#	50#	3560#	40#	5279#	14#	-17760#	40#	3980#	50#	-17470#	40#
	Os	76	20850#	210#	2220	80	5980	50	-19890#	310#	8100	70	-21220#	210#
	Ir	77	21620#	160#	991	30	6504.9	2.6	*	*	7530	70	-20410#	300#
Pt	78	*		-610#	360#	7160	50	*	*	11530#	300#	*	*	
168	Eu	63	8680#	620#	*		-3300#	640#	12980#	580#	*		3000#	580#
	Gd	64	9980#	450#	22210#	570#	-2690#	500#	10200#	420#	*		-510#	450#
	Tb	65	10980#	310#	20090#	470#	-1770#	320#	7340#	300#	-16000#	500#	-860#	300#
	Dy	66	12120	140	18610#	240#	-1210#	170#	4430	140	-15040#	330#	-4350	140
	Ho	67	13130	30	16750	80	-410	100	1250	30	-11420#	200#	-4840	30
	Er	68	14207.76	0.21	14984.3	1.2	551.9	1.1	-1409.27	0.25	-10350	60	-8518.8	1.5
	Tm	69	15567	12	12819.5	1.8	1243.7	2.2	-4250	40	-6321	6	-8794	4
	Yb	70	16129	7	11233.8	0.3	1936.1	1.2	-6221	28	-5579.69	0.28	-12150	30
	Lu	71	17190	50	9760	40	2410	50	-8670	50	-1810	40	-11670	50
	Hf	72	17640	40	8343	29	3230	30	-10470	30	-2059	28	-15080	40
	Ta	73	18440	40	6950	40	3820	40	-12600	40	1820	40	-14370	30
	W	74	19148	16	5610	30	4500	11	-14898	17	1290	30	-18130#	40#
	Re	75	20040	80	4280	40	5063	13	-17130	60	5270	40	-17360	80
	Os	76	20706	21	2685	14	5815.6	2.7	-18990	150	4814	21	-20994	21
	Ir	77	21460#	200#	1350	90	6381	9	*	*	8880#	70#	-20130#	310#
Pt	78	22420#	340#	150	150	6990	3	*	*	8210	170	*	*	
169	Gd	64	9480#	590#	*		-2770#	640#	11440#	590#	*		500#	590#
	Tb	65	10540#	360#	20900#	500#	-2030#	330#	8470#	300#	-17880#	580#	160#	330#
	Dy	66	11810	310	19360#	420#	-1570#	320#	5330	300	-14520#	500#	-3610	300
	Ho	67	12659	21	17450#	200#	-660#	100#	2478	20	-13360#	300#	-3877	20
	Er	68	13774.56	0.19	15570	60	264.6	1.1	-545.5	0.3	-9650	140	-7681.5	1.9
	Tm	69	14874.2	1.0	13573	5	1198.9	1.1	-3191	3	-8500	30	-7764.6	1.1
	Yb	70	15930	4	11664.3	0.3	1719.1	1.3	-5661	28	-4675.36	0.29	-11380	40
	Lu	71	16730	30	10119	3	2420	4	-7794	28	-4061	4	-10795	28
	Hf	72	17390	40	8704	28	3150	40	-9800	30	-424	28	-14390	40
	Ta	73	18080	40	7370	40	3730	40	-11880	30	-510	50	-13470	30
	W	74	18962	24	6030	30	4290	30	-14195	30	3150	30	-17190	30
	Re	75	19720#	40#	4640	30	5014	14	-16315	26	2700	30	-16485	15
	Os	76	20360	80	3200	30	5713	3	-18210#	200#	6881	28	-20130	60
	Ir	77	21164	30	1840#	50#	6141	4	-20310#	300#	6410	40	-19160	150
	Pt	78	22040#	360#	590#	210#	6858	5	*	*	10190#	200#	*	*
Au	79	*		-710#	300#	7380#	340#	*	*	9590#	300#	*	*	

Table III. Nuclear-reaction and separation energies (continued, Explanation of Table on p. 030003-98)

A	Elt.	Z	S(n)	S(p)	$Q(4\beta^-)$	$Q(d,\alpha)$	$Q(p,\alpha)$	$Q(n,\alpha)$						
170	Gd	64	5300#	780#	*	18730#	600#	9070#	780#	7500#	720#	*		
	Tb	65	4470#	500#	9860#	640#	13070#	400#	12350#	570#	8950#	500#	2930#	570#
	Dy	66	6140#	360#	10620#	360#	7100#	200#	9770#	360#	7130#	280#	2800#	360#
	Ho	67	5510	50	7930	300	1070	50	13030	150	8560	80	5340#	200#
	Er	68	7256.9	1.5	8600	20	-3855	28	10660	30	7036	5	5470	60
	Tm	69	6591.96	0.17	6161.7	1.1	-9658	28	13906.1	1.1	8359.4	1.1	8131	5
	Yb	70	8457.7	1.2	6777.7	0.8	-13473	13	11259.8	1.7	6643.8	1.3	8173.7	1.2
	Lu	71	7293	17	4218	17	-18393	29	14986	17	8148	17	10884	17
	Hf	72	9610	40	5458	28	-22328	30	11520	50	6110	40	9983	28
	Ta	73	7920	40	2710	40	-26780#	90#	15930	40	8190	40	13010	40
	W	74	10444	20	4290	30	-30992	23	11810	30	5920	30	11820	30
	Re	75	8575	26	1284	28	-35160#	200#	16691	27	8049	29	15080	40
	Os	76	11275	27	2806	15	*	*	12580	30	5770#	40#	13818	21
	Ir	77	9340#	90#	-70#	90#	*	*	17350#	90#	8010#	120#	17120#	100#
	Pt	78	11860#	200#	1494	30	*	*	13080	60	5637	4	15850	70
	Au	79	10040#	360#	-1472	12	*	*	17970#	250#	7730#	360#	18970#	200#
171	Tb	65	5380#	640#	9940#	780#	15180#	500#	10830#	710#	9200#	640#	1360#	710#
	Dy	66	4600#	360#	10750#	500#	9120#	300#	10850#	420#	7400#	420#	3820#	500#
	Ho	67	6350	600	8150#	630#	3310	600	11790	670	8900	620	3850#	670#
	Er	68	5681.6	0.4	8770	50	-2288	29	11789	20	7210	30	6490	140
	Tm	69	7485.8	1.2	6390.6	1.2	-7490	28	12423.6	1.5	8644.9	1.5	6500	30
	Yb	70	6614.21	0.01	6799.9	0.8	-12221	28	12679.2	0.8	6870.2	1.7	9330.8	1.2
	Lu	71	8593	17	4353.4	1.9	-16578	28	13260.0	2.2	8617.6	2.2	9130.9	2.5
	Hf	72	7250	40	5410	30	-21130	30	13364	29	6500	50	11797	29
	Ta	73	9650	40	2760	40	-25310	50	13710	40	8500	40	10990	50
	W	74	7870	30	4240	40	-29620	80	13920	40	6170	40	13920	40
	Re	75	10410	40	1250	30	-33690	30	14380	30	8510	30	12790	40
	Os	76	8447	20	2678	29	-37780#	300#	14818	21	6360	40	16238	22
	Ir	77	11120#	100#	-230	40	*	*	15020	50	8450	40	15030	50
	Pt	78	9240	80	1400#	120#	*	*	15330	80	6060	90	18170	70
	Au	79	11880#	200#	-1448	10	*	*	15660#	200#	8310	150	16750	60
	Hg	80	*	*	60#	360#	*	*	15980#	430#	*	*	20130#	340#
172	Tb	65	3890#	710#	*	17520#	500#	12240#	780#	9170#	710#	*		
	Dy	66	5890#	420#	11270#	590#	11250#	300#	9430#	500#	7180#	420#	1790#	590#
	Ho	67	5040#	630#	8580#	360#	5250#	200#	12890#	280#	8980#	360#	4490#	360#
	Er	68	6836	4	9250	600	-81	25	10470	50	7178	20	4760	300
	Tm	69	6235	5	6944	5	-6044	28	13445	5	8413	6	7069	21
	Yb	70	8019.95	0.02	7334.1	1.0	-10158	28	11251.2	0.8	6883.8	0.8	7314.1	1.2
	Lu	71	6978.9	2.6	4718.1	2.3	-15200	40	14738.7	2.3	8505.6	2.6	10185.6	2.5
	Hf	72	9040	40	5863	24	-19158	28	11615	30	6546	25	9622	24
	Ta	73	7680	40	3190	40	-23950	40	15630	40	8250	40	12401	28
	W	74	10080	40	4670	40	-27990	30	11750	40	6060	40	11270	40
	Re	75	8360	50	1740	50	-32220	70	16460	40	8240	40	14400	50
	Os	76	11013	22	3280	30	-36190	150	12380	26	6029	15	13320	20
	Ir	77	9040	50	370	40	*	*	17260	30	8210	40	16680	30
	Pt	78	11710	70	1980	40	*	*	12960#	90#	5851	22	15262	27
	Au	79	9830	60	-860	90	*	*	17690	60	8060#	200#	18420	60
	Hg	80	12610#	340#	790	150	*	*	13400#	250#	5590#	330#	17100#	250#

Table III. Nuclear-reaction and separation energies (continued, Explanation of Table on p. 030003-98)

A	Elt.	Z	S(2n)		S(2p)		Q(α)		Q($2\beta^-$)		Q(ϵp)		Q($\beta^- n$)	
170	Gd	64	9160#	720#	*		-3080#	720#	12280#	630#	*		880#	670#
	Tb	65	10140#	500#	21560#	640#	-1940#	540#	9520#	400#	*		800#	500#
	Dy	66	11250#	240#	19880#	450#	-1560#	280#	6450#	200#	-16800#	540#	-2940#	200#
	Ho	67	12320	60	18090#	300#	-780	90	3560	50	-13200#	300#	-3390	50
	Er	68	13260.1	1.5	16130	140	51.2	1.7	655.2	1.5	-11800	300	-6904.8	1.8
	Tm	69	14625.6	1.5	14310	30	850.6	1.1	-2490	17	-8288	20	-7489.6	1.1
	Yb	70	15324.7	1.2	12350.7	1.2	1737.2	1.2	-4510	28	-7129.8	1.2	-10751	3
	Lu	71	16380	40	10571	17	2157	20	-7170	30	-3320	17	-10660	30
	Hf	72	17040	40	9250	28	2917	29	-8960	30	-3165	28	-14030	40
	Ta	73	17890	40	7650	50	3460	40	-11220	40	658	28	-13290	30
	W	74	18540	19	6510	30	4140	30	-13365	16	140	30	-16953	17
	Re	75	19260	40	5100	40	4760	40	-15550#	90#	4090	40	-16260	30
	Os	76	20074	14	3611	16	5536.9	2.7	-17627	21	3703	18	-19904	25
	Ir	77	20840#	100#	2140#	90#	6110#	50#	-19610#	220#	7760#	90#	-18920#	220#
Pt	78	21430	150	882	21	6707	3	*	*	7130	30	-22580#	300#	
Au	79	*		-340#	200#	7177	15	*	*	11050#	200#	*		
171	Tb	65	9850#	590#	*		-2450#	640#	10490#	780#	*		1560#	540#
	Dy	66	10730#	420#	20610#	590#	-1800#	420#	7530#	300#	-16100#	670#	-2020#	300#
	Ho	67	11860	600	18770#	670#	-1020#	630#	4690	600	-15080#	720#	-2480	600
	Er	68	12938.5	1.5	16700	300	-210	60	1587.9	1.6	-11350#	200#	-5994.4	1.8
	Tm	69	14077.7	1.2	14991	20	645	5	-1381.9	2.1	-10260	50	-6517.7	1.0
	Yb	70	15071.9	1.2	12961.6	1.2	1559.5	1.2	-3875	29	-6487.1	1.5	-10072	17
	Lu	71	15886	4	11131.1	2.0	2290.3	2.3	-6108	28	-5321.5	2.0	-9646	28
	Hf	72	16860	40	9632	29	2734	29	-8350	40	-1956	29	-13360	40
	Ta	73	17570	40	8214	28	3360	40	-10470	40	-1700	30	-12500	30
	W	74	18310	30	6950	40	3960	40	-12780	30	1880	40	-16240	40
	Re	75	18980	30	5540	40	4680	40	-14840	50	1600	40	-15395	30
	Os	76	19720	30	3962	24	5371	4	-16830	70	5700	22	-19010#	90#
	Ir	77	20460	40	2580	40	5994#	13#	-18850	40	5210	40	-18180	40
	Pt	78	21100#	210#	1320	80	6607	3	-20950#	310#	9170	70	-21790#	210#
Au	79	21920#	300#	50	30	7085	11	*	*	8510#	90#	*		
Hg	80	*		-1420#	360#	7668	15	*	*	12490#	300#	*		
172	Tb	65	9270#	640#	*		-2540#	710#	11630#	540#	*		2270#	590#
	Dy	66	10490#	360#	21210#	670#	-2070#	500#	8470#	300#	*		-1560#	670#
	Ho	67	11390#	200#	19340#	450#	-1190#	360#	5890#	200#	-14740#	540#	-1840#	200#
	Er	68	12518	4	17400#	200#	-350	140	2772	4	-13580#	300#	-5345	4
	Tm	69	13721	6	15710	50	260	30	-638	6	-10140	600	-6139	6
	Yb	70	14634.16	0.02	13724.7	1.5	1310.8	1.2	-2853	24	-8825.5	1.6	-9498.4	1.9
	Lu	71	15572	17	11518.1	2.5	2152.0	2.9	-5406	28	-4814.7	2.5	-9376	29
	Hf	72	16290	40	10216	24	2755	24	-7310	40	-4384	24	-12750	40
	Ta	73	17330	40	8600	30	3310	50	-9790	50	-791	28	-12320	40
	W	74	17950	30	7420	40	3840	40	-11850	30	-950	40	-15920	40
	Re	75	18770	50	5980	50	4430	50	-14160	50	2890	50	-15310	40
	Os	76	19460	16	4531	18	5224	7	-16137	16	2550	30	-18900	40
	Ir	77	20160#	90#	3040	40	5991	10	-18060	60	6580	40	-17980	80
	Pt	78	20950	21	1759	14	6463	4	-20050	150	5906	21	-21616	23
Au	79	21710#	200#	540#	110#	6923	10	*	*	9810	70	-20870#	310#	
Hg	80	*		-660	150	7524	6	*	*	9120	170	*		

Table III. Nuclear-reaction and separation energies (continued, Explanation of Table on p.030003-98)

A	Elt.	Z	S(n)		S(p)		Q(4β ⁻)		Q(d,α)		Q(p,α)		Q(n,α)	
173	Dy	66	4000#	500#	11380#	640#	13610#	400#	10800#	640#	7650#	570#	3090#	720#
	Ho	67	5940#	360#	8630#	420#	7530#	300#	11550#	420#	9180#	360#	3020#	500#
	Er	68	5240#	200#	9460#	280#	1760#	200#	11580#	630#	7450#	200#	5660#	280#
	Tm	69	6953	7	7061	6	-3860	28	12174	5	8717	5	5630	50
	Yb	70	6367.10	0.02	7466	6	-8824	28	12369.9	1.0	7108.7	0.8	8203.9	1.5
	Lu	71	8216.3	2.2	4914.4	1.6	-13327	28	13136.7	1.6	8747.1	1.6	8561.3	1.8
	Hf	72	7080	40	5965	28	-17970	30	13127	28	6760	30	10999	28
	Ta	73	9140	40	3280	40	-22130	30	13750	40	8720	40	10560	30
	W	74	7700	40	4690	40	-26780	60	13700	40	6270	40	13170	40
	Re	75	10090	50	1750	40	-30720	40	14240	40	8600	30	12230	40
	Os	76	8266	20	3190	40	-34730#	200#	14520	30	6339	28	15499	20
	Ir	77	10960	30	314	15	*	*	14744	21	8522	15	14291	26
	Pt	78	8910	60	1850	60	*	*	15180	70	6280#	110#	17630	60
	Au	79	11590	60	-986	21	*	*	15350	80	8331	29	16170#	90#
Hg	80	9720#	250#	680#	200#	*	*	15560#	200#	5906	13	19240#	200#	
174	Dy	66	5500#	640#	*	*	15570#	500#	9190#	710#	7530#	710#	*	*
	Ho	67	4410#	420#	9040#	500#	9880#	300#	13030#	420#	9360#	420#	3990#	590#
	Er	68	6370#	360#	9890#	420#	3900#	300#	10250#	360#	7430#	670#	3890#	420#
	Tm	69	5680	40	7500#	200#	-2120	50	13330	40	8720	40	6300	600
	Yb	70	7464.60	0.01	7977	4	-6717	28	11141	6	7129.8	1.0	6420.8	1.6
	Lu	71	6760.6	1.4	5307.9	1.6	-11897	28	14396.1	1.6	8600.7	1.6	9286.5	1.8
	Hf	72	8504	28	6252.5	2.2	-15849	10	11602.3	2.8	6848.0	2.6	9108.7	2.3
	Ta	73	7420	40	3620	40	-20880	40	15370	40	8550	40	11734	28
	W	74	9570	40	5120	40	-24909	30	11810	40	6360	40	10850	40
	Re	75	8190	40	2230	40	-29440#	90#	16130	40	8280	40	13690	40
	Os	76	10628	18	3731	30	-33354	22	12250	40	6119	30	12737	30
	Ir	77	8666	27	714	29	*	*	17091	27	8300	30	16030	40
	Pt	78	11450	60	2339	15	*	*	12770	30	5960	40	14630	21
	Au	79	9470#	90#	-420#	110#	*	*	17580#	90#	8100#	120#	17820#	100#
Hg	80	12000#	200#	1098	30	*	*	13390	60	5785	11	16480	80	
175	Ho	67	5580#	500#	9120#	640#	11960#	400#	11450#	570#	9670#	500#	2290#	640#
	Er	68	4770#	500#	10250#	500#	5830#	400#	11410#	500#	7700#	450#	5000#	500#
	Tm	69	6520	70	7650#	300#	100	60	12050#	200#	9040	50	4820#	200#
	Yb	70	5822.35	0.07	8120	40	-5063	28	12271	4	7543	6	7434	4
	Lu	71	7666.7	1.0	5510.0	1.2	-9877	28	13096.4	1.2	8953.9	1.2	7855	6
	Hf	72	6708.5	0.4	6200.4	2.2	-14376	12	13110.1	2.2	7118.4	2.8	10420.2	2.3
	Ta	73	8740	40	3853	28	-19010	30	13710	40	8860	40	9974	28
	W	74	7480	40	5180	40	-23920	30	13470	40	6560	40	12420	40
	Re	75	9690	40	2350	40	-27880	50	14150	40	8670	40	11690	40
	Os	76	8181	16	3720	30	-32130	70	14160	30	6300	40	14640	30
	Ir	77	10602	27	688	16	*	*	14755	19	8713	18	13790	40
	Pt	78	8467	21	2140	30	*	*	15266	21	6530	40	17177	22
	Au	79	11240#	100#	-630	40	*	*	15250	70	8570	40	15620	50
	Hg	80	9400	80	1030#	120#	*	*	15570	80	6210	90	18780	70
176	Ho	67	4160#	640#	*	*	14090#	500#	12790#	710#	9510#	640#	*	*
	Er	68	6050#	570#	10720#	570#	7950#	400#	9770#	500#	7580#	500#	2950#	570#
	Tm	69	5130	110	8010#	410#	1990	100	13290#	310#	9150#	220#	5630#	310#
	Yb	70	6867.08	0.07	8470	50	-2850	28	11080	40	7629	4	5810#	200#
	Lu	71	6287.97	0.15	5975.7	1.2	-8319	28	14273.1	1.2	9033.0	1.2	8520	5
	Hf	72	8166.0	1.8	6699.7	0.9	-12478	28	11704.7	1.3	7168.6	1.3	8621.3	1.5
	Ta	73	7030	40	4170	30	-17490	40	15190	30	8910	40	11160	30
	W	74	9080	40	5520	40	-21710	30	11810	40	6620	40	10420	40
	Re	75	7850	40	2720	40	-26540	40	15880	40	8530	40	12980	40
	Os	76	10060	30	4100	40	-30310	30	12290	40	6320	40	12280	40
	Ir	77	8555	21	1062	20	-34460	80	16828	20	8424	22	15320	30
	Pt	78	11292	22	2828	18	*	*	12640	27	6199	15	14151	20
	Au	79	9190	50	100	40	*	*	17510	30	8290	70	17390	30
	Hg	80	11880	70	1670	40	*	*	13160#	90#	5912	21	15800	60
Tl	81	*	*	-1265	18	*	*	17930	80	8160#	210#	19060	80	

Table III. Nuclear-reaction and separation energies (continued, Explanation of Table on p. 030003-98)

A	El.	Z	S(2n)	S(2p)	$Q(\alpha)$	$Q(2\beta^-)$	$Q(\epsilon p)$	$Q(\beta^- n)$						
173	Dy	66	9890#	500#	*	-2210#	640#	9720#	450#	*	-530#	450#		
	Ho	67	10970#	670#	19900#	590#	-1450#	420#	6910#	300#	-16790#	590#	-940#	300#
	Er	68	12080#	200#	18040#	360#	-480#	360#	3900#	200#	-12930#	360#	-4350#	200#
	Tm	69	13188	5	16320	600	116	21	625	5	-12060#	200#	-5072	4
	Yb	70	14387.05	0.02	14410.2	1.6	947.0	1.2	-2139	28	-8357	4	-8886.6	2.3
	Lu	71	15195.2	2.0	12248.6	1.8	1969.4	1.8	-4484	28	-6796	6	-8550	24
	Hf	72	16120	40	10683	28	2541	28	-6680	40	-3445	28	-12150	40
	Ta	73	16820	40	9146	28	3263	28	-8840	40	-2950	28	-11370	40
	W	74	17780	40	7870	40	3560	40	-11290	30	390	40	-15260	50
	Re	75	18450	40	6410	40	4310	40	-13290	30	490	40	-14380	30
	Os	76	19279	23	4930	30	5055	6	-15500	60	4370	30	-18130	40
	Ir	77	20000	40	3600	30	5716	10	-17436	25	3980	40	-17233	15
	Pt	78	20620	90	2220	60	6350	50	-19230#	200#	8010	60	-20700	80
	Au	79	21410	30	1000	40	6836	5	*	*	7260	40	-19850	150
	Hg	80	22330#	360#	-180#	210#	7378	4	*	*	11110#	200#	*	*
174	Dy	66	9500#	590#	*	-2420#	780#	10580#	590#	*	-90#	590#		
	Ho	67	10350#	360#	20420#	590#	-1390#	500#	8180#	300#	*	-110#	360#	
	Er	68	11610#	300#	18520#	420#	-710#	360#	5000#	300#	-15300#	500#	-3770#	300#
	Tm	69	12630	50	16960#	200#	-50	70	1710	40	-11800#	300#	-4380	40
	Yb	70	13831.70	0.02	15039	4	739.3	1.5	-1100.0	2.3	-10580#	200#	-8134.9	1.6
	Lu	71	14976.8	2.2	12774	6	1800.7	1.8	-3829	28	-6603	5	-8230	28
	Hf	72	15585	25	11167.0	2.3	2494.5	2.3	-5617	28	-5582.2	2.3	-11519	28
	Ta	73	16550	40	9583	28	3140	30	-8070	40	-2149	28	-11080	40
	W	74	17270	40	8400	40	3600	40	-10232	30	-2100	40	-14740	40
	Re	75	18280	50	6920	40	4040	40	-12810	40	1430	40	-14310	30
	Os	76	18894	16	5476	30	4871	10	-14677	15	1443	30	-17798	15
	Ir	77	19630	40	3900	50	5625	10	-16630#	90#	5400	40	-16990	60
	Pt	78	20354	15	2652	16	6183	3	-18677	22	4831	18	-20557	25
	Au	79	21060#	110#	1430#	100#	6699	7	*	*	8740#	90#	-19600#	220#
	Hg	80	21720	150	112	22	7233	6	*	*	8010	60	*	*
175	Ho	67	10000#	500#	*	-1600#	640#	9110#	400#	*	680#	500#		
	Er	68	11140#	450#	19290#	570#	-890#	500#	6040#	400#	-14570#	640#	-2860#	400#
	Tm	69	12200	50	17540#	300#	-220	600	2860	50	-13910#	300#	-3440	50
	Yb	70	13286.96	0.07	15620#	200#	598.5	1.6	-213.9	2.3	-10040#	300#	-7196.7	1.6
	Lu	71	14427.3	1.0	13487	5	1619.8	1.5	-2757	28	-8590	40	-7392.4	1.9
	Hf	72	15213	28	11508.4	2.3	2400.2	2.3	-4849	28	-4826.1	2.3	-10812	28
	Ta	73	16150	40	10106	28	2995	28	-7120	40	-4127	28	-10250	40
	W	74	17050	40	8800	40	3370	40	-9530	30	-1077	28	-14030	40
	Re	75	17880	40	7470	40	4010	40	-11890	30	-840	40	-13364	30
	Os	76	18810	19	5960	30	4560	30	-14392	22	2830	30	-17313	27
	Ir	77	19269	17	4420	30	5430	30	-15990	40	2990	30	-16148	16
	Pt	78	19910	60	2853	24	6164	4	-17740	80	6993	21	-19550#	90#
	Au	79	20710	40	1710	40	6583	4	*	*	6170	50	-18830	40
	Hg	80	21410#	210#	610	90	7072	5	*	*	10060	70	*	*
176	Ho	67	9740#	590#	*	-1870#	710#	10080#	510#	*	1290#	640#		
	Er	68	10820#	500#	19840#	640#	-1050#	500#	6860#	400#	*	-2390#	400#	
	Tm	69	11650	110	18260#	310#	-310#	220#	4010	100	-13460#	410#	-2750	100
	Yb	70	12689.44	0.02	16120#	300#	567	4	1085.0	1.5	-12130#	400#	-6397.0	1.2
	Lu	71	13954.7	1.0	14100	40	1567	6	-2020	30	-8360	50	-6971.9	1.9
	Hf	72	14874.5	1.7	12209.8	1.5	2254.2	1.5	-3935	28	-7169.7	1.5	-10239	28
	Ta	73	15770	40	10370	30	2950	30	-6300	40	-3490	30	-9800	40
	W	74	16560	40	9375	28	3340	40	-8540	40	-3449	28	-13420	40
	Re	75	17530	40	7900	40	3840	40	-11180	30	60	40	-13030	30
	Os	76	18245	30	6450	40	4570	40	-13160	30	250	40	-16770	30
	Ir	77	19157	30	4780	30	5230	40	-15360	40	4120	30	-16236	25
	Pt	78	19758	16	3516	16	5885.1	2.1	-17149	17	3883	17	-19600	40
	Au	79	20430#	100#	2240	40	6433	7	-19100	80	7580	40	-18620	80
	Hg	80	21287	22	1045	15	6897	6	*	*	6640	21	*	*
	Tl	81	*	-240#	120#	7470	90	*	*	10700	80	*	*	

Table III. Nuclear-reaction and separation energies (continued, Explanation of Table on p. 030003-98)

A	Elt.	Z	S(n)	S(p)	$Q(4\beta^-)$		$Q(d,\alpha)$		$Q(p,\alpha)$		$Q(n,\alpha)$			
177	Er	68	4300#	640#	10860#	710#	10020#	500#	11060#	640#	7700#	590#	4160#	710#
	Tm	69	6170#	310#	8130#	500#	4250#	300#	11890#	500#	9350#	420#	3870#	420#
	Yb	70	5566.40	0.22	8900	100	-1285	28	12030	50	7740	40	6610#	300#
	Lu	71	7072.89	0.16	6181.5	1.2	-6115	28	13022.5	1.2	9424.8	1.2	7130	40
	Hf	72	6375.6	1.0	6787.4	0.8	-10924	15	12995.8	0.8	7553.6	1.3	9710.3	1.4
	Ta	73	8420	30	4427	3	-15667	20	13478	4	8994	4	9502	3
	W	74	7130	40	5630	40	-20330	30	13420	40	6900	40	11789	28
	Re	75	9280	40	2920	40	-24724	30	14070	40	8820	40	11120	40
	Os	76	7930	30	4180	30	-29170	80	14040	30	6580	30	13920	30
	Ir	77	10240	26	1240	30	-32707	29	14769	23	8812	22	13270	30
	Pt	78	8508	20	2781	22	*	*	14735	19	6357	29	16271	18
	Au	79	11100	30	-100	15	*	*	14879	21	8637	15	14965	26
	Hg	80	9070	80	1550	80	*	*	15330	80	6320#	120#	18180	80
	Tl	81	11990	80	-1155	19	*	*	15340	80	8165	29	16540#	90#
178	Er	68	5470#	780#	*	*	12180#	600#	9740#	780#	7810#	720#	*	*
	Tm	69	4720#	500#	8550#	640#	6480#	400#	13230#	570#	9400#	570#	4730#	570#
	Yb	70	6780	10	9520#	300#	711	18	10390	100	7480	50	4600#	400#
	Lu	71	6025.3	1.9	6640.4	2.3	-4684	28	13864.3	2.3	9221.8	2.3	7620	50
	Hf	72	7625.94	0.18	7340.4	0.8	-8891	14	11657.8	0.8	7594.4	0.8	7906.7	1.4
	Ta	73	6960#	50#	5010#	50#	-14350#	60#	14690#	50#	8750#	50#	10210#	50#
	W	74	8780	30	5981	15	-18409	18	11670	30	6870	30	9721	15
	Re	75	7460	40	3240	40	-23350	30	15700	40	8840	40	12400	40
	Os	76	9659	20	4560	30	-27228	17	12230	30	6610	30	11730	30
	Ir	77	8276	28	1584	25	-31460#	90#	16560	30	8718	23	14680	30
	Pt	78	10698	18	3239	22	-35572	26	12592	20	6261	16	13754	16
	Au	79	8830	15	222	18	*	*	17341	16	8274	21	16737	16
	Hg	80	11600	80	2060	15	*	*	12920	30	5950	40	15044	21
	Tl	81	9520#	90#	-700#	120#	*	*	17710#	90#	8050#	120#	18260#	100#
	Pb	82	*	*	370	30	*	*	13700	80	*	*	17190	80
179	Tm	69	5560#	640#	8630#	780#	8760#	500#	11970#	710#	9890#	640#	3340#	710#
	Yb	70	4910#	200#	9710#	450#	2760#	200#	11640#	360#	7700#	220#	5740#	450#
	Lu	71	6792	5	6652	11	-2475	25	12638	5	9296	5	5960	100
	Hf	72	6098.99	0.08	7414.1	2.1	-7443	17	12631.7	0.8	7783.4	0.8	8674.8	1.4
	Ta	73	7830#	50#	5211.1	0.4	-12276	10	13234.1	0.5	9083.1	1.1	8671.3	0.9
	W	74	6960	21	5990#	50#	-17027	17	13130	15	6930	30	10928	15
	Re	75	9000	40	3466	29	-21596	27	13830	40	8920	40	10430	40
	Os	76	7547	21	4660	30	-26090	30	13960	30	6910	30	13270	30
	Ir	77	9901	22	1826	17	-29810	40	14586	18	8880	30	12628	30
	Pt	78	8342	13	3305	21	-34320	80	14490	21	6474	19	15476	29
	Au	79	10756	15	280	15	*	*	15093	19	8809	17	14536	20
	Hg	80	8684	29	1913	29	*	*	15328	29	6460	40	17650	30
	Tl	81	11550#	100#	-760	40	*	*	15220	80	8380	40	15900	50
	Pb	82	9590	80	450#	120#	*	*	16100	80	6333	27	19480	80
180	Tm	69	4390#	710#	*	*	11010#	500#	13050#	780#	9800#	710#	*	*
	Yb	70	6130#	360#	10290#	590#	5040#	300#	10230#	500#	7730#	420#	3910#	590#
	Lu	71	5690	70	7430#	210#	-840	70	13730	70	9170	70	6440#	310#
	Hf	72	7387.76	0.15	8009	5	-5422	16	11269.2	2.1	7468.5	0.8	6853.5	1.4
	Ta	73	6646.9	2.3	5758.9	2.3	-10955	22	14213.2	2.3	8811.8	2.3	9097.3	2.2
	W	74	8412	15	6567.8	0.5	-15200	11	11670#	50#	6943	3	8890.9	0.4
	Re	75	7320	30	3831	26	-20212	22	15280	26	8730	40	11524	22
	Os	76	9410	23	5063	30	-24107	21	12010	30	6780	30	10990	30
	Ir	77	7967	24	2247	27	-28590	60	16278	26	8843	26	13940	40
	Pt	78	10239	14	3643	15	-32494	17	12527	23	6476	23	13167	18
	Au	79	8708	13	646	9	*	*	17083	11	8609	16	16068	20
	Hg	80	11390	30	2551	17	*	*	12764	16	6159	15	14766	20
	Tl	81	9190	70	-250	70	*	*	17640	60	8260	100	17800	60
	Pb	82	12060	80	960	40	*	*	13560#	90#	6263	20	16490	80

Table III. Nuclear-reaction and separation energies (continued, Explanation of Table on p. 030003-98)

A	Elt.	Z	S(2n)		S(2p)		Q(α)		Q($2\beta^-$)		Q(ϵp)		Q($\beta^- n$)	
177	Er	68	10350#	640#	*		-1340#	640#	8130#	500#	*		-1560#	510#
	Tm	69	11300#	300#	18840#	500#	-540#	420#	4920#	300#	-15470#	590#	-2050#	300#
	Yb	70	12433.48	0.23	16910#	400#	240#	200#	1894.2	1.4	-11650#	400#	-5675.5	1.2
	Lu	71	13360.86	0.22	14650	50	1447	5	-669	3	-10300	100	-5878.8	0.9
	Hf	72	14541.6	2.0	12763.0	1.4	2245.7	1.4	-3179	28	-6678.3	1.4	-9590	30
	Ta	73	15449	28	11127	3	2741	3	-5445	28	-5621	3	-9144	28
	W	74	16210	40	9798	28	3290	40	-7750	30	-2414	28	-12710	40
	Re	75	17120	40	8440	40	3700	40	-10220	30	-2190	40	-12240	40
	Os	76	17994	19	6900	30	4350	30	-12586	21	1400	30	-16149	22
	Ir	77	18796	23	5340	30	5080	30	-14502	22	1730	30	-15185	24
	Pt	78	19800	24	3843	19	5642.9	2.7	-16590	80	5440	30	-18920	40
	Au	79	20280	40	2729	16	6298	4	-18205	24	5044	20	-17831	15
	Hg	80	20950	100	1650	80	6740	50	*		8860	80	-21440	110
	Tl	81	*		510	40	7067	7	*		7890	40	*	
178	Er	68	9770#	720#	*		-1320#	780#	9440#	600#	*		-860#	670#
	Tm	69	10890#	410#	19400#	640#	-850#	500#	6220#	400#	*		-1200#	400#
	Yb	70	12347	10	17640#	400#	-170#	300#	2740	10	-14130#	500#	-5383	10
	Lu	71	13098.2	1.9	15540	100	1100	40	260#	50#	-10160#	300#	-5528.5	2.1
	Hf	72	14001.5	1.0	13521.9	1.4	2084.4	1.4	-2028	15	-8737.8	1.4	-8792	3
	Ta	73	15380#	60#	11790#	50#	2550#	50#	-4950#	60#	-5500#	50#	-8970#	60#
	W	74	15910	30	10409	15	3013	15	-6863	20	-4815	15	-12210	30
	Re	75	16730	40	8870	40	3660	40	-9400	30	-1228	28	-11770	30
	Os	76	17590	30	7480	30	4260	30	-11547	17	-1130	30	-15568	24
	Ir	77	18516	26	5770	30	5000	30	-13948	22	2730	30	-14953	25
	Pt	78	19206	16	4478	30	5573.0	2.2	-15682	15	2670	18	-18524	15
	Au	79	19930	30	3003	20	6135	25	-17510#	90#	6455	22	-17590	80
	Hg	80	20674	15	1960	17	6577.3	3.0	-19890	26	5766	18	-21047	24
	Tl	81	21520#	120#	850#	100#	7020	10	*		9470#	90#	*	
Pb	82	*		-781	26	7790	14	*		9070	80	*		
179	Tm	69	10270#	590#	*		-820#	640#	7460#	500#	*		20#	500#
	Yb	70	11690#	200#	18260#	540#	-310#	450#	3930#	200#	-13570#	630#	-4270#	200#
	Lu	71	12818	5	16170#	300#	830	50	1298	5	-12230#	400#	-4695	5
	Hf	72	13724.93	0.19	14054.5	1.4	1807.7	1.4	-1168	15	-8056	10	-7940#	50#
	Ta	73	14785	3	12551.5	0.9	2383.3	0.9	-3773	25	-7308.5	2.1	-8022	15
	W	74	15740	30	10992	15	2762	15	-6276	22	-4149	15	-11710	30
	Re	75	16460	40	9448	25	3400	40	-8503	27	-3280#	60#	-11111	28
	Os	76	17206	22	7900	30	4190	30	-10751	18	98	22	-14839	26
	Ir	77	18177	22	6390	30	4782	30	-13093	15	283	30	-14156	14
	Pt	78	19040	17	4890	17	5412	9	-15340	28	3987	16	-18036	13
	Au	79	19586	16	3519	23	5981	5	-16720	40	3974	23	-16744	16
	Hg	80	20290	80	2140	30	6360	30	-18980	80	7780	29	-20210#	90#
	Tl	81	21070	40	1300	40	6711	3	*		6750	40	-19910	50
	Pb	82	*		-260	110	7598	20	*		11080	80	*	
180	Tm	69	9950#	640#	*		-1060#	710#	8760#	510#	*		550#	540#
	Yb	70	11050#	300#	18920#	670#	-390#	500#	5180#	300#	*		-3610#	300#
	Lu	71	12480	70	17140#	410#	270	120	2260	70	-12370#	510#	-4280	70
	Hf	72	13486.75	0.17	14662	10	1287.1	1.4	-143.23	0.28	-10530#	200#	-7493.3	0.4
	Ta	73	14480#	50#	13173.0	2.9	2024.4	2.2	-3096	21	-7163	5	-7709	15
	W	74	15372	15	11778.8	0.3	2515.3	1.0	-5278	16	-6462.2	0.3	-11123	25
	Re	75	16330	40	9820#	60#	3100	40	-7860	30	-2769	21	-10889	27
	Os	76	16956	21	8529	22	3860	30	-9922	20	-2352	22	-14347	19
	Ir	77	17868	29	6900	40	4660	40	-12352	22	1320	30	-13781	23
	Pt	78	18581	15	5470	17	5240	30	-14185	17	1295	20	-17519	16
	Au	79	19464	11	3952	20	5828	17	-16240	60	5167	11	-16769	28
	Hg	80	20077	17	2831	16	6258.5	2.4	-18309	18	4729	15	-20050	40
	Tl	81	20740#	110#	1660	60	6710	50	*		8310	60	-19510	100
	Pb	82	21658	27	203	16	7419	5	*		7698	30	*	

Table III. Nuclear-reaction and separation energies (continued, Explanation of Table on p.030003-98)

A	Elt.	Z	S(n)		S(p)		Q(4β ⁻)		Q(d,α)		Q(p,α)		Q(n,α)	
181	Tm	69	5320#	780#	*		13270#	600#	*		9950#	840#	*	
	Yb	70	4560#	420#	10460#	590#	7150#	300#	11220#	590#	7890#	500#	4820#	670#
	Lu	71	6190	140	7490#	320#	1720	130	12450#	230#	9760	130	4970#	420#
	Hf	72	5694.80	0.07	8020	70	-3853	25	12367	5	7799.0	2.1	7939	10
	Ta	73	7576.8	1.3	5947.9	1.8	-8975	5	12735.4	1.8	8861.0	1.8	7545.9	2.6
	W	74	6669.02	0.16	6589.9	2.3	-13852	14	12834.3	0.5	7230#	50#	9847.8	0.4
	Re	75	8751	25	4170	13	-18646	24	13489	19	8754	20	9730#	50#
	Os	76	7260	30	5000	30	-22889	30	13750	40	6970	40	12503	30
	Ir	77	9557	22	2394	17	-26664	11	14267	17	8945	15	11837	28
	Pt	78	8017	18	3693	26	-31260	80	14411	17	6734	24	14809	19
	Au	79	10317	21	724	23	*	*	15108	22	8990	22	14027	28
	Hg	80	8482	20	2325	16	*	*	15038	19	6507	18	16983	18
	Tl	81	11480	60	-163	14	*	*	14840	29	8381	14	15151	14
	Pb	82	9250	80	1020	100	*	*	15860	80	6540#	120#	18840	80
182	Yb	70	5800#	500#	10940#	720#	9430#	400#	9810#	640#	7650#	640#	*	
	Lu	71	5150#	230#	8080#	360#	3570#	220#	13430#	360#	9520#	280#	5370#	540#
	Hf	72	6718	6	8540	130	-1440	23	11340	70	7873	8	6130#	200#
	Ta	73	6062.94	0.11	6316.1	1.8	-7378	21	14060.2	1.8	8897.0	1.8	8275	5
	W	74	8083.6	1.6	7096.7	1.4	-12078	13	11397.6	1.9	6975.3	1.6	7863.2	1.6
	Re	75	7000	100	4500	100	-17150	100	14900	100	8710	100	10560	100
	Os	76	9130	30	5381	25	-21032	24	11940	30	6840	30	10332	26
	Ir	77	7660	22	2790	30	-25724	24	16017	27	8832	27	13180	30
	Pt	78	9858	19	3994	14	-29343	18	12520	25	6777	16	12497	21
	Au	79	8501	28	1208	24	*	*	16846	23	8831	22	15427	22
	Hg	80	10987	18	2995	22	*	*	12759	11	6276	15	14338	13
	Tl	81	8601	15	-44	19	*	*	17633	17	8464	30	17307	17
	Pb	82	11780	80	1315	15	*	*	13270	60	6310	40	15749	30
	183	Yb	70	4350#	570#	*		11270#	400#	10780#	720#	7690#	640#	*
Lu		71	5910#	210#	8190#	410#	6090	80	12080#	310#	9750#	310#	3850#	510#
Hf		72	5300	30	8690#	200#	380	60	12230	130	8260	80	6960#	300#
Ta		73	6934.18	0.20	6532	6	-5089	24	12820.8	1.8	9350.6	1.8	7030	70
W		74	6190.84	0.04	7224.6	1.4	-10593	16	12783.5	1.4	7431.4	1.9	9060.2	1.6
Re		75	8430	100	4852	8	-15618	12	13135	8	8691	8	8770	8
Os		76	7130	50	5510	110	-19860	50	13560	50	7040	50	11620	50
Ir		77	9220	30	2880	30	-23616	26	14060	40	9019	29	11280	30
Pt		78	7675	20	4010	26	-28200	30	14401	16	7069	27	14232	23
Au		79	9962	22	1312	16	*	*	14901	17	9108	14	13432	24
Hg		80	8299	12	2793	21	*	*	14777	21	6685	9	16278	13
Tl		81	11331	15	299	14	*	*	14785	18	8527	16	14685	10
Pb		82	8820	30	1540	30	*	*	15934	30	6680	70	18320	30
184		Yb	70	5510#	640#	*		13170#	500#	*		7500#	780#	*
	Lu	71	4770#	310#	8600#	500#	7810#	300#	13120#	500#	9540#	420#	4410#	670#
	Hf	72	6290	50	9070	90	2750	40	11090#	200#	8160	130	5240#	300#
	Ta	73	5618	26	6850	40	-3230	40	13921	27	9428	26	7600	130
	W	74	7411.11	0.13	7701.5	1.4	-8371	16	11435.4	1.4	7597.0	1.4	7343.9	1.6
	Re	75	6481	9	5143	4	-13901	23	14737	4	8878	5	9865	4
	Os	76	8660	50	5732	8	-17904	10	11900	100	7129	13	9627.7	1.6
	Ir	77	7480	40	3240	60	-22728	30	15710	40	8800	40	12550	30
	Pt	78	9633	22	4420	29	-26283	20	12428	26	6993	16	11862	30
	Au	79	8199	24	1835	27	-31380	80	16561	26	8927	26	14791	23
	Hg	80	10616	12	3446	14	*	*	12663	23	6386	22	13679	17
	Tl	81	8367	14	368	12	*	*	17404	14	8642	18	16634	22
	Pb	82	11550	30	1753	16	*	*	12987	17	6611	14	15256	20
	Bi	83	*		-1350	80	*	*	18600	80	9040	110	19510	80

Table III. Nuclear-reaction and separation energies (continued, Explanation of Table on p. 030003-98)

A	El.	Z	S(2n)	S(2p)	$Q(\alpha)$		$Q(2\beta^-)$		$Q(\epsilon p)$		$Q(\beta^- n)$			
181	Tm	69	9710#	780#	*	*	9630#	610#	*		1360#	670#		
	Yb	70	10690#	360#	*	-660#	590#	6320#	300#	*	-2480#	310#		
	Lu	71	11880	130	17780#	520#	250#	320#	3640	130	-14170#	520#	-3090	130
	Hf	72	13082.56	0.17	15440#	200#	1158.7	1.4	831.0	0.3	-10090#	300#	-6541.3	2.3
	Ta	73	14223.6	1.9	13957	5	1520.6	1.7	-1921	13	-9050	70	-6873.5	1.8
	W	74	15081	15	12348.9	0.4	2221.9	0.4	-4684	25	-5743.4	0.3	-10468	21
	Re	75	16076	28	10738	13	2772	13	-7054	14	-4873	13	-10231	21
	Os	76	16670	30	8833	29	3730	40	-9168	29	-1203	25	-13640	30
	Ir	77	17524	11	7457	25	4381	28	-11592	21	-915	22	-13098	12
	Pt	78	18256	16	5940	21	5150	5	-13720	21	2687	21	-16827	15
	Au	79	19025	23	4367	22	5751.4	2.9	-15072	22	2817	29	-15692	24
	Hg	80	19880	30	2971	17	6284	4	-17540	80	6486	19	-19350	60
	Tl	81	20670	40	2388	15	6321	6	*		5538	10	-18929	15
	Pb	82	21310	110	770	80	7240	7	*		9840	80	*	
182	Yb	70	10360#	500#	*	-990#	720#	7230#	400#	*		-2090#	420#	
	Lu	71	11350#	210#	18540#	540#	-190#	450#	4550#	200#	-14000#	630#	-2550#	200#
	Hf	72	12413	6	16030#	300#	1221	12	2197	6	-12250#	300#	-5683	6
	Ta	73	13639.7	1.3	14330	70	1482.9	2.6	-980	100	-8920	130	-6267.4	1.9
	W	74	14752.6	1.6	13044.7	1.6	1764.3	1.6	-3637	22	-8132.2	1.6	-9800	13
	Re	75	15750	100	11090	100	2730#	120#	-6390	100	-4300	100	-9970	110
	Os	76	16394	27	9551	22	3373	27	-8441	25	-3664	22	-13217	22
	Ir	77	17220	30	7792	30	4180	30	-10751	29	177	24	-12741	25
	Pt	78	17875	17	6389	21	4951	5	-12592	16	93	29	-16369	24
	Au	79	18818	21	4901	30	5526	4	-14973	23	3873	21	-15711	25
	Hg	80	19469	16	3719	15	5996	5	-16752	16	3516	17	-18850	13
	Tl	81	20080	60	2280	13	6551	6	*		7254	23	-18280	80
	Pb	82	21026	17	1153	18	7066	6	*		6547	20	*	
183	Yb	70	10150#	500#	*	*		8180#	400#	*		-1290#	450#	
	Lu	71	11060	150	19120#	600#	-540#	510#	5580	80	*		-1740	80
	Hf	72	12020	30	16770#	300#	830#	200#	3080	30	-11750#	400#	-4920	30
	Ta	73	12997.12	0.23	15070	130	1341	5	517	8	-10700#	200#	-5118.1	1.4
	W	74	14274.4	1.6	13540.7	1.6	1672.4	1.6	-2700	50	-7605	6	-8990	100
	Re	75	15435	15	11949	8	2123	8	-5606	26	-6669	8	-9272	23
	Os	76	16260	60	10010	50	3210	50	-7890	50	-2710	50	-12680	50
	Ir	77	16883	25	8264	27	3960	30	-10012	26	-2050	100	-12106	28
	Pt	78	17534	21	6800	30	4822	9	-11968	17	1548	27	-15543	26
	Au	79	18463	22	5306	11	5465.3	2.9	-13604	13	1571	23	-14686	14
	Hg	80	19286	17	4001	15	6039	4	-16229	29	5075	15	-18548	14
	Tl	81	19931	13	3294	22	5976	9	*		4425	22	-17833	15
	Pb	82	20600	80	1490	30	6928	7	*		8713	30	*	
184	Yb	70	9860#	640#	*	*		8960#	510#	*		-900#	510#	
	Lu	71	10680#	360#	*	-920#	590#	6430#	300#	*		-1200#	300#	
	Hf	72	11590	40	17260#	400#	680#	300#	4210	40	-13690#	400#	-4280	40
	Ta	73	12552	26	15540#	200#	1410	80	1380	26	-10410	80	-4545	26
	W	74	13601.95	0.14	14234	6	1649.1	1.6	-1452.8	0.7	-9710	30	-7967	8
	Re	75	14920	100	12368	4	2288	5	-4609	28	-6216	4	-8630	50
	Os	76	15786	22	10584.4	0.7	2958.7	1.6	-6918	16	-5175.9	0.7	-12121	24
	Ir	77	16700	30	8740	110	3800	40	-9290	40	-1090	29	-11910	30
	Pt	78	17308	20	7303	27	4599	8	-10985	19	-960	50	-15214	18
	Au	79	18160	30	5840	30	5234	5	-13435	24	2600	30	-14585	23
	Hg	80	18915	14	4758	16	5662	4	-15297	16	2135	18	-17833	14
	Tl	81	19698	16	3160	23	6317	9	-17950	80	6019	14	-17379	30
	Pb	82	20369	18	2053	16	6774	3	*		5464	15	*	
	Bi	83	*		190	80	8020	50	*		10360	80	*	

Table III. Nuclear-reaction and separation energies (continued, Explanation of Table on p.030003-98)

A	Elt.	Z	S(n)	S(p)	$Q(4\beta^-)$	$Q(d,\alpha)$	$Q(p,\alpha)$	$Q(n,\alpha)$						
185	Yb	70	4030#	710#	*	14890#	500#	*	*	*	*	*		
	Lu	71	5550#	420#	8640#	590#	9930#	300#	11920#	500#	9800#	500#	*	
	Hf	72	4890	80	9200#	310#	4490	60	12110	100	8420#	210#	6150#	410#
	Ta	73	6626	30	7180	40	-1060	30	12600	30	9519	15	6130#	200#
	W	74	5753.74	0.05	7837	26	-6700	26	12615.8	1.4	7906.2	1.4	8308	6
	Re	75	7671	4	5402.6	0.7	-11960.9	2.7	13257.4	0.7	9291.1	0.7	8257.3	1.5
	Os	76	6624.66	0.27	5875	4	-16622	14	13715	8	7500	100	11086.6	0.7
	Ir	77	8800	40	3372	28	-20580	30	14040	60	9140	40	10760	110
	Pt	78	7430	30	4370	40	-25150	30	14230	40	7230	30	13570	30
	Au	79	9611	22	1813	16	-29620#	80#	14625	16	9174	13	12840	21
	Hg	80	7906	17	3154	26	*	*	14719	17	6981	24	15631	19
	Tl	81	10946	23	698	23	*	*	14758	22	8683	23	14189	29
	Pb	82	8561	21	1947	19	*	*	15757	19	6651	20	17682	19
	Bi	83	11370#	110#	-1530#	80#	*	*	16050#	90#	9450#	80#	16740#	80#
186	Lu	71	4390#	500#	9000#	640#	11720#	400#	13040#	640#	9750#	570#	*	*
	Hf	72	6180	80	9830#	300#	6580	50	10700#	300#	8160	100	4320#	400#
	Ta	73	5280	60	7580	90	560	60	13600	70	9540	70	6750	100
	W	74	7192.1	1.2	8403	14	-4644	22	11042	26	7648.3	1.8	6420	30
	Re	75	6179.38	0.17	5828.3	0.7	-10212	21	14489.1	0.7	9302.5	0.7	9012.1	1.5
	Os	76	8265.4	0.9	6469.9	0.8	-14461	12	11930	4	7674	8	9012.0	0.9
	Ir	77	6910	30	3655	17	-19286	28	15791	17	9360	50	12284	18
	Pt	78	9250	30	4820	40	-23182	25	12460	40	7200	30	11450	50
	Au	79	7928	21	2320	30	-28569	27	16330	26	8922	26	14130	30
	Hg	80	10427	18	3970	12	-32640	22	12490	25	6516	15	12880	19
	Tl	81	8200	30	992	26	*	*	17173	25	8782	23	15951	24
	Pb	82	11212	20	2213	24	*	*	12912	15	6769	15	14769	13
	Bi	83	8980#	80#	-1106	23	*	*	18616	21	9290	30	19087	19
	Po	84	*	950#	80#	*	*	*	13750	80	*	*	17320	30
187	Lu	71	5440#	570#	*	13640#	400#	11630#	640#	9820#	640#	*	*	
	Hf	72	4460#	300#	9900#	500#	8400#	300#	11780#	420#	8460#	420#	5370#	590#
	Ta	73	6360	80	7760	80	2650	60	12140	90	9470	70	5160#	300#
	W	74	5466.76	0.04	8590	60	-3219	24	12201	14	7799	26	7240	40
	Re	75	7360.7	0.9	5996.9	1.1	-8189	22	12882.1	0.9	9353.0	0.9	7269	26
	Os	76	6290.3	0.5	6580.8	0.9	-13101	14	13310.9	0.9	7865	4	10132.8	0.9
	Ir	77	8450	30	3838	28	-17105	29	13967	28	9567	28	10317	28
	Pt	78	6890	30	4802	29	-21698	25	14360	40	7790	40	13214	24
	Au	79	9380	30	2450	30	-26645	24	14370	30	9170	27	12230	40
	Hg	80	7650	18	3692	25	-30950	30	14451	14	7065	26	14863	21
	Tl	81	10629	24	1194	14	*	*	14450	16	8768	13	13521	24
	Pb	82	8376	12	2389	23	*	*	15482	21	6760	11	17008	11
	Bi	83	11308	20	-1010	15	*	*	15869	19	9532	16	16146	14
	Po	84	9340	40	1310	40	*	*	15780#	90#	6630	80	19530	30
188	Lu	71	4280#	640#	*	15230#	500#	*	*	9570#	710#	*	*	
	Hf	72	6130#	420#	10590#	500#	10260#	300#	10040#	500#	7870#	420#	3270#	590#
	Ta	73	4790	80	8080#	300#	4730	60	13520	80	9570	80	5920#	300#
	W	74	6835	3	9060	60	-847	6	10650	60	7591	14	5300	60
	Re	75	5871.65	0.04	6401.8	1.1	-6645.5	2.8	14202.5	1.1	9235.0	0.9	8024	14
	Os	76	7989.61	0.15	7209.73	0.15	-10935	12	11500.7	0.9	7545.8	0.9	7897.0	0.9
	Ir	77	6867	29	4415	9	-16010	30	15366	9	9325	9	11121	9
	Pt	78	9207	25	5561	28	-20006	12	12062	17	7379	28	10631	5
	Au	79	7415	22	2975	24	-25177	12	16204	22	9181	26	13611	28
	Hg	80	10155	19	4463	25	-29658	23	12224	24	6520	13	12133	29
	Tl	81	7960	30	1510	30	*	*	16910	30	8710	30	15170	30
	Pb	82	10900	12	2660	13	*	*	12782	25	6807	23	14015	17
	Bi	83	8883	15	-503	12	*	*	18198	16	9211	20	18209	24
	Po	84	11440	40	1450	22	*	*	13313	26	6560#	80#	16643	26

Table III. Nuclear-reaction and separation energies (continued, Explanation of Table on p. 030003-98)

A	Elt.	Z	S(2n)		S(2p)		Q(α)		Q(2 β^-)		Q(ϵ_p)		Q(β^-n)	
185	Yb	70	9540#	640#	*	*	*	9820#	510#	*			-160#	590#
	Lu	71	10310#	310#	*		-1140#	670#	7510#	300#	*		-460#	300#
	Hf	72	11180	70	17800#	410#	340#	310#	5070	60	-13070#	510#	-3550	70
	Ta	73	12244	14	16260	80	980	130	2425	14	-12270#	300#	-3760	14
	W	74	13164.85	0.14	14680	30	1590.1	1.6	-581.9	0.7	-9180	40	-7239	4
	Re	75	14152	8	13104.2	1.5	2194.4	1.5	-3483	28	-8269	26	-7637.8	0.5
	Os	76	15280	50	11018.2	0.7	3003.0	1.6	-6118	26	-4389.5	0.7	-11266	28
	Ir	77	16270	40	9104	29	3760	30	-8477	28	-3405	28	-11070	30
	Pt	78	17060	30	7600	60	4437	10	-10504	29	275	26	-14440	30
	Au	79	17809	10	6233	25	5180	5	-12100	21	464	28	-13580	10
	Hg	80	18522	15	4989	21	5773	4	-14642	21	3862	21	-17372	17
	Tl	81	19313	23	4144	23	5688	5	-17520#	80#	3270	30	-16778	24
	Pb	82	20110	30	2314	18	6695	5	*		7519	19	-20680	80
	Bi	83	*		230#	80#	8140#	80#	*		7360#	80#	*	
186	Lu	71	9940#	500#	*	*	*	8400#	410#	*			40#	410#
	Hf	72	11070	60	18460#	510#	-30#	400#	6080	50	-15210#	510#	-3100	50
	Ta	73	11910	70	16770#	300#	850#	210#	3320	60	-12010#	300#	-3290	60
	W	74	12945.8	1.2	15590	40	1116	6	491.4	1.2	-11480	60	-6760.8	1.2
	Re	75	13850	4	13666	26	2077.9	1.5	-2755	17	-7822	14	-7192.5	0.5
	Os	76	14890.0	0.9	11872.5	0.9	2821.2	0.9	-5135	22	-6901.1	0.9	-10736	28
	Ir	77	15700	30	9531	17	3850	100	-7457	27	-2642	17	-10560	30
	Pt	78	16673	27	8190	22	4320	18	-9325	25	-2348	22	-14078	22
	Au	79	17540	30	6680	30	4912	14	-11830	30	1330	30	-13603	25
	Hg	80	18333	15	5783	19	5204	10	-13857	16	860	28	-16853	24
	Tl	81	19146	24	4150	30	5990	30	-16740	28	4683	23	-16417	28
	Pb	82	19773	17	2911	15	6470	6	-18783	22	4213	18	-20520#	80#
	Bi	83	20350	80	841	20	7757	12	*		9323	27	*	
	Po	84	*		-575	22	8501	14	*		8353	24	*	
187	Lu	71	9840#	500#	*	*	*	9320#	400#	*			770#	400#
	Hf	72	10640#	310#	18890#	590#	-140#	500#	7090#	300#	*		-2280#	300#
	Ta	73	11640	60	17590#	300#	400	100	4320	60	-13970#	400#	-2460	60
	W	74	12658.8	1.2	16160	60	950	30	1315.0	1.1	-10770	50	-6048.2	1.2
	Re	75	13540.1	0.9	14400	14	1651.4	1.5	-1667	28	-9900	60	-6287.9	0.5
	Os	76	14555.7	0.9	12409.1	0.9	2721.7	0.9	-4534	24	-5999.4	1.1	-10118	17
	Ir	77	15360	40	10308	28	3835	29	-6520	40	-4911	28	-9760	40
	Pt	78	16140	40	8457	24	4550	60	-8567	28	-974	24	-13040	30
	Au	79	17312	22	7270	40	4751	29	-10583	24	-1144	28	-12560	25
	Hg	80	18077	19	6008	29	5230	14	-13131	15	2458	26	-16303	26
	Tl	81	18829	22	5164	8	5322	7	-16061	13	1981	22	-15834	14
	Pb	82	19588	17	3381	15	6393	6	-17820	30	6263	13	-19912	18
	Bi	83	20290#	80#	1203	23	7779	4	*		6214	24	-18556	21
	Po	84	*		210	40	7979	15	*		10220	30	*	
188	Lu	71	9720#	640#	*	*	*	9820#	510#	*			960#	590#
	Hf	72	10600#	300#	*		-760#	590#	7790#	300#	*		-2060#	300#
	Ta	73	11150	80	17980#	400#	380#	300#	5400	50	-13320#	400#	-1780	50
	W	74	12302	3	16820	50	410	40	2469	3	-13140#	300#	-5523	3
	Re	75	13232.4	0.9	14990	60	1398	26	-672	9	-9410	60	-5869.18	0.04
	Os	76	14279.9	0.5	13206.6	1.1	2143.2	0.9	-3316	5	-8522.2	1.1	-9659	28
	Ir	77	15315	19	10996	9	3450	10	-5974	10	-4417	9	-9731	26
	Pt	78	16099	22	9399	5	4007	5	-7619	13	-3891	5	-12864	23
	Au	79	16799	21	7777	17	4815	28	-10030	30	-111	28	-12325	14
	Hg	80	17805	17	6915	25	4707	16	-12387	16	-806	27	-15829	15
	Tl	81	18590	40	5200	40	5560	40	-15140	30	3400	40	-15420	30
	Pb	82	19276	16	3854	16	6109	3	-17271	23	3014	17	-19503	15
	Bi	83	20191	20	1886	25	7264	5	*		7961	14	-18090	30
	Po	84	20788	27	440	23	8082	15	*		7154	21	*	

Table III. Nuclear-reaction and separation energies (continued, Explanation of Table on p.030003-98)

A	Elt.	Z	S(n)		S(p)		Q(4β ⁻)		Q(d,α)		Q(p,α)		Q(n,α)	
189	Hf	72	4360#	420#	10660#	590#	11820#	300#	11130#	500#	7910#	500#	*	
	Ta	73	6290#	200#	8240#	360#	6620#	200#	11700#	360#	9460#	200#	4030#	450#
	W	74	5020	40	9290	70	850	40	11990	70	7850	70	6450	70
	Re	75	7034	8	6600	9	-4397	22	12636	8	9394	8	6270	60
	Os	76	5920.8	0.4	7258.9	0.5	-9360	30	12940.5	0.5	7804.4	0.9	9168.2	1.2
	Ir	77	8176	16	4601	13	-13833	15	13480	13	9414	13	9124	13
	Pt	78	6720	11	5413	14	-18625	17	13791	30	7567	19	12177	10
	Au	79	9282	20	3050	21	-23517	29	13810	30	9147	30	11237	26
	Hg	80	7500	30	4540	30	-28200	40	14110	40	6950	40	13880	40
	Tl	81	10350	30	1703	15	*	*	14213	16	8787	14	12745	23
	Pb	82	8100	18	2800	30	*	*	15311	16	6907	26	16341	18
	Bi	83	10941	24	-462	23	*	*	15633	21	9481	24	15470	30
	Po	84	8949	30	1516	25	*	*	15672	24	6588	28	18906	25
190	Hf	72	5940#	500#	*		13680#	400#	9470#	640#	7410#	570#	*	
	Ta	73	4760#	280#	8640#	360#	8240#	200#	13080#	360#	9170#	360#	4710#	450#
	W	74	6840	60	9840#	200#	2920	40	9940	70	7380	70	4080#	300#
	Re	75	5730	70	7310	80	-2800	70	13740	70	9130	70	6910	90
	Os	76	7792.34	0.19	8018	8	-7337	16	11019.8	0.5	7372.8	0.5	6842.6	1.2
	Ir	77	6375	13	5055.8	1.2	-12382	8	15094.5	1.3	9329.5	1.3	10109.3	1.3
	Pt	78	8908	10	6146	13	-16890	13	11749	9	7107	28	9558.9	0.6
	Au	79	7323	20	3653	11	-22234	23	15698	6	8716	24	12362	28
	Hg	80	9820	40	5078	26	-26807	21	11711	16	6521	27	10961	29
	Tl	81	7827	12	2030	30	*	*	16541	15	8610	16	14302	24
	Pb	82	10644	19	3090	15	*	*	12630	30	6892	15	13348	19
	Bi	83	8610	30	45	27	*	*	17926	25	9251	23	17491	24
	Po	84	11213	26	1788	25	*	*	13342	18	6683	17	16070	14
191	Ta	73	6050#	360#	8750#	500#	10220#	300#	11380#	420#	9250#	420#	2950#	590#
	W	74	4870	60	9950#	200#	4520	40	11360#	200#	7300	70	5350#	300#
	Re	75	6790	70	7260	40	-552	11	11980	40	9182	11	4910	60
	Os	76	5758.73	0.11	8050	70	-5803	22	12295	8	7485.7	0.5	7919	3
	Ir	77	8026.5	0.4	5290.0	1.1	-10426	7	12988.8	1.2	9292.5	1.2	7954.5	1.2
	Pt	78	6463	4	6234	4	-15470	40	13462	13	7511	10	11085	4
	Au	79	9036	6	3780	5	-20559	9	13382	11	8887	7	10193	11
	Hg	80	7293	27	5047	23	-25523	23	13701	30	6643	22	12875	23
	Tl	81	9982	11	2201	18	-30147	18	14050	30	8783	14	11735	8
	Pb	82	7890	40	3150	40	*	*	15100	40	6970	50	15620	40
	Bi	83	10711	24	112	15	*	*	15315	16	9440	13	14740	30
	Po	84	8576	15	1758	24	*	*	15707	22	6990	13	18393	13
	At	85	*		-1139	21	*	*	15997	27	9272	26	16705	20
192	Ta	73	4640#	500#	*		11770#	400#	12680#	570#	8960#	500#	*	
	W	74	6550#	200#	10450#	360#	6640#	200#	9570#	280#	7040#	280#	3160#	360#
	Re	75	5310	70	7700	80	1180	70	13500	80	8890	80	5890#	210#
	Os	76	7558.3	2.2	8821	10	-3871	16	10460	70	6961	8	5380	40
	Ir	77	6198.12	0.11	5729.3	1.1	-8960	30	14583.0	1.1	9015.2	1.2	8790	8
	Pt	78	8661.5	2.9	6868.7	2.3	-13732	14	11175.9	2.3	7025	13	8344.7	2.5
	Au	79	7046	17	4363	16	-19240	30	15245	16	8561	19	11324	20
	Hg	80	9491	27	5503	16	-23941	19	11533	16	6434	25	10104	19
	Tl	81	7660	30	2570	40	-28800	40	16210	40	8620	40	13360	40
	Pb	82	10400	40	3562	15	*	*	12527	15	6924	16	12720	30
	Bi	83	8370	30	590	50	*	*	17590	30	9170	30	16730	30
	Po	84	11073	13	2120	13	*	*	13240	25	6858	24	15420	18
	At	85	9010	30	-706	29	*	*	18200	30	9210	40	18640	30

Table III. Nuclear-reaction and separation energies (continued, Explanation of Table on p. 030003-98)

A	Elt.	Z	S(2n)	S(2p)	$Q(\alpha)$	$Q(2\beta^-)$	$Q(\epsilon p)$	$Q(\beta^- n)$						
189	Hf	72	10490#	420#	*	-1090#	590#	8460#	300#	*	-1620#	300#		
	Ta	73	11080#	200#	18830#	450#	-370#	360#	6150#	200#	-15330#	540#	-1230#	200#
	W	74	11860	40	17380#	300#	280	80	3370	40	-12030#	300#	-4670	40
	Re	75	12905	8	15660	60	990	16	471	15	-11660	60	-4913	8
	Os	76	13910.4	0.5	13660.7	1.2	1976.1	0.9	-2517	10	-7608	3	-8713	9
	Ir	77	15040	30	11811	13	2945	13	-4868	24	-6722	13	-8700	14
	Pt	78	15927	26	9828	10	3912	10	-6840	30	-2621	10	-12169	10
	Au	79	16700	30	8610	30	4330	30	-8966	22	-2526	22	-11451	24
	Hg	80	17650	30	7520	40	4640	40	-11780	30	910	30	-15360	40
	Tl	81	18314	12	6166	24	4817	9	-14551	22	466	9	-14872	14
	Pb	82	19000	15	4304	20	5915	4	-16422	26	5069	19	-18721	18
	Bi	83	19824	23	2198	22	7268.2	2.7	*		4980	40	-17592	29
	Po	84	20390	40	1013	23	7694	15	*		9104	24	*	
190	Hf	72	10290#	500#	*	*		9350#	400#	*		-1270#	450#	
	Ta	73	11040#	200#	19300#	540#	-730#	450#	7120#	210#	*		-970#	200#
	W	74	11860	40	18080#	300#	-380	60	4330	40	-14510#	300#	-4470	40
	Re	75	12760	70	16600	90	550	90	1120	70	-11100#	210#	-4720	70
	Os	76	13713.2	0.5	14618	3	1375.8	1.2	-1401.3	0.4	-10380	40	-8330	13
	Ir	77	14551	9	12314.7	1.3	2748.6	1.5	-3920	4	-6063	8	-8356	10
	Pt	78	15628	5	10747.2	0.6	3268.6	0.6	-5936	16	-5608.7	0.5	-11796	20
	Au	79	16605	4	9067	10	3914	17	-8462	9	-1673	13	-11280	30
	Hg	80	17311	20	8128	17	4069	27	-10954	20	-2190	19	-14826	18
	Tl	81	18180	30	6579	8	4918	22	-13772	24	1921	22	-14599	16
	Pb	82	18744	16	4793	18	5698	5	-15853	18	1920	30	-18423	24
	Bi	83	19548	25	2840	40	6862	3	*		6728	24	-17250	30
	Po	84	20162	24	1327	17	7693	7	*		5991	19	*	
191	Ta	73	10810#	360#	*	-1340#	500#	7860#	300#	*		-180#	300#	
	W	74	11700	60	18590#	300#	-790#	300#	5220	40	-13440#	400#	-3610	80
	Re	75	12514	13	17100#	200#	120	60	2358	10	-13130#	200#	-3714	10
	Os	76	13551.07	0.22	15360	40	1083.9	1.2	-697	4	-9300	40	-7713.0	1.2
	Ir	77	14402	13	13308	8	2082.8	1.2	-2911	5	-8360	70	-7473.6	1.2
	Pt	78	15372	11	11289	4	3096	4	-5106	23	-4279	4	-10936	5
	Au	79	16359	21	9926	14	3327	28	-7515	9	-4333	5	-10499	17
	Hg	80	17110	40	8700	24	3670	30	-10360	40	-574	22	-14291	24
	Tl	81	17809	11	7279	21	4320	23	-13044	10	-738	8	-13938	15
	Pb	82	18530	40	5180	50	5460	40	-15160	40	3850	40	-17700	40
	Bi	83	19317	22	3201	11	6780	3	-17103	18	3844	11	-16747	15
	Po	84	19789	23	1803	16	7493	5	*		8059	14	*	
	At	85	*		649	26	7822	14	*		7175	28	*	
192	Ta	73	10690#	450#	*	-1700#	640#	8530#	410#	*		40#	400#	
	W	74	11410#	200#	19200#	450#	-1200#	360#	6230#	200#	*		-3370#	200#
	Re	75	12100	100	17650#	210#	-400	90	3250	70	-12390#	310#	-3260	70
	Os	76	13317.1	2.2	16080	40	361	4	406	3	-11990	40	-7244.8	2.4
	Ir	77	14224.7	0.4	13780	70	1756.3	1.2	-2063	16	-7774	10	-7209	4
	Pt	78	15124.6	2.5	12158.6	2.5	2423.9	2.5	-4277	16	-7182.2	2.5	-10562	6
	Au	79	16081	16	10597	16	3148	18	-6900	40	-3352	16	-10252	27
	Hg	80	16783	22	9283	16	3384	16	-9456	20	-3602	16	-13800	17
	Tl	81	17640	30	7620	30	4070	30	-12340	40	640	30	-13710	50
	Pb	82	18282	18	5763	21	5221	5	-14485	17	747	26	-17388	15
	Bi	83	19080	40	3740	30	6377	4	-16460	40	5460	30	-16540	30
	Po	84	19649	17	2232	17	7320	3	*		4870	40	-20006	20
	At	85	*		1050	40	7696	26	*		8876	29	*	

Table III. Nuclear-reaction and separation energies (continued, Explanation of Table on p.030003-98)

A	Elt.	Z	S(n)		S(p)		Q(4β ⁻)		Q(d,α)		Q(p,α)		Q(n,α)	
193	Ta	73	5880#	570#	*		13670#	400#	*		9020#	570#	*	
	W	74	4710#	280#	10510#	450#	8190#	200#	10920#	360#	7090#	280#	4390#	450#
	Re	75	6710	80	7870#	200#	3170	40	11660	60	9010	60	3930#	200#
	Os	76	5583.42	0.20	9090	70	-2332	16	11667	10	7110	70	6630	40
	Ir	77	7771.99	0.20	5943.0	2.4	-7059	7	12569.8	1.2	9035.6	1.2	6750	70
	Pt	78	6262.5	2.3	6933.0	0.4	-12290	50	12940.0	0.4	7138.0	0.5	9874.6	1.2
	Au	79	8704	18	4405	9	-17520	12	13004	10	8766	9	8995	9
	Hg	80	7122	22	5579	22	-22737	21	13447	16	6635	16	11891	16
	Tl	81	9680	30	2755	17	-27410	23	13825	23	8758	17	11003	8
	Pb	82	7710	50	3610	60	-31240	60	14800	50	7040	50	14820	50
	Bi	83	10420	30	618	15	*	*	15060	40	9396	15	14134	11
	Po	84	8326	18	2080	30	*	*	15625	16	7138	27	17738	19
	At	85	11060	40	-714	24	*	*	15712	23	9361	25	16180	30
	Rn	86	*		1170	40	*	*	15890	30	*		19253	28
194	Ta	73	4500#	640#	*		15230#	500#	*		*		*	
	W	74	6310#	360#	10950#	500#	10230#	300#	9250#	500#	6830#	420#	*	
	Re	75	5080#	200#	8240#	280#	4980#	200#	13120#	280#	8800#	200#	4900#	360#
	Os	76	7112	3	9490	40	-251	4	9860	70	6779	10	4390	40
	Ir	77	6066.79	0.11	6426.4	2.4	-5594	14	14061.3	2.4	8727.5	1.2	7465	10
	Pt	78	8351.8	1.3	7512.8	1.3	-10552	17	10786.3	1.2	6812.7	1.2	7281.5	0.5
	Au	79	6878	9	5021.3	2.5	-16183	7	14787	3	8350	5	10143.2	2.4
	Hg	80	9193	16	6068	9	-21179	13	11299	16	6478	6	9161	5
	Tl	81	7532	15	3164	21	-26217	29	15785	21	8518	26	12507	15
	Pb	82	10080	50	4020	19	-29931	24	12380	40	6939	19	12030	28
	Bi	83	8216	10	1120	50	*	*	17238	15	9070	40	15901	10
	Po	84	10751	19	2409	15	*	*	13240	30	7099	15	14870	40
	At	85	8720	30	-316	29	*	*	18061	27	9213	26	18166	26
	Rn	86	11390	30	1498	27	*	*	13510	30	6724	23	16439	18
195	W	74	4560#	420#	11000#	590#	11780#	300#	10570#	500#	6920#	500#	*	
	Re	75	6410#	360#	8340#	420#	6990#	300#	11420#	360#	8940#	360#	3130#	500#
	Os	76	5150	60	9560#	200#	1500	60	11430	70	6940	90	5780#	200#
	Ir	77	7231.86	0.06	6546.1	2.0	-3537	11	12412.8	2.4	9054.0	2.4	5540	70
	Pt	78	6105.10	0.12	7551.1	1.3	-9086	18	12453.2	1.3	6905.8	1.2	8734.7	2.3
	Au	79	8426.4	2.3	5095.9	1.0	-14541	5	12623.4	1.6	8585.5	2.7	7914.9	1.6
	Hg	80	6901	23	6090	23	-19960	40	13102	25	6623	28	10921	23
	Tl	81	9289	18	3260	11	-24685	15	13618	19	8720	19	10263	19
	Pb	82	7571	25	4059	23	-28760	50	14480	19	7030	40	13950	24
	Bi	83	10068	8	1107	18	*	*	14880	50	9395	14	13490	30
	Po	84	8120	40	2320	40	*	*	15540	40	7340	50	17150	40
	At	85	10821	27	-245	16	*	*	15566	17	9464	15	15710	30
	Rn	86	8740	50	1520	60	*	*	15830	50	6990	60	18770	50
	196	W	74	5940#	500#	*		13760#	400#	9130#	640#	6850#	570#	*
Re		75	5040#	420#	8820#	420#	8600#	300#	12700#	420#	8610#	360#	3970#	500#
Os		76	6840	70	9990#	300#	3550	40	9670#	200#	6820	60	3660#	200#
Ir		77	5810	40	7210	70	-1940	40	13710	40	8820	40	6440	50
Pt		78	7921.98	0.13	8241.2	1.3	-7296	8	10598.0	1.3	6755.8	1.3	6396.2	2.3
Au		79	6643	3	5633.8	3.0	-13130	25	14332.2	3.0	8205	3	9044	3
Hg		80	8884	23	6548	3	-18353	14	11097	4	6443	9	8300	3
Tl		81	7413	16	3772	26	-23580	30	15398	12	8430	20	11555	15
Pb		82	9712	20	4482	13	-27319	16	12300	16	6993	10	11360	17
Bi		83	8055	25	1590	30	*	*	16910	30	9050	60	15115	25
Po		84	10490	40	2736	15	*	*	13267	15	7276	15	14370	50
At		85	8520	30	150	50	*	*	17800	30	9270	30	17620	30
Rn		86	11150	50	1848	17	*	*	13402	29	6902	26	15943	20

Table III. Nuclear-reaction and separation energies (continued, Explanation of Table on p. 030003-98)

A	Elt.	Z	S(2n)	S(2p)	Q(α)	Q(2 β^-)	Q(ϵp)	Q($\beta^- n$)						
193	Ta	73	10520#	500#	*	*	9360#	400#	*	710#	450#			
	W	74	11250#	200#	*	-1550#	360#	7110#	200#	*	-2770#	210#		
	Re	75	12020	40	18320#	300#	-830#	200#	4300	40	-14460#	400#	-2420	40
	Os	76	13141.7	2.2	16800	40	-200	40	1085.3	2.4	-11030#	200#	-6630.0	2.4
	Ir	77	13970.11	0.23	14764	10	1018	8	-1131	9	-10240	70	-6319.1	2.3
	Pt	78	14924	4	12662.4	1.2	2082.2	1.2	-3417	16	-5886.4	2.4	-9779	16
	Au	79	15750	10	11274	9	2620	15	-5928	11	-5858	9	-9465	18
	Hg	80	16613	27	9942	16	2982	18	-8870	50	-2063	16	-13260	40
	Tl	81	17337	10	8257	8	3680	21	-11593	10	-1994	17	-12993	15
	Pb	82	18110	60	6180	50	5010	60	-13870	50	2530	50	-16730	60
	Bi	83	18788	11	4180	11	6307	5	-15817	23	2700	30	-15885	13
	Po	84	19399	16	2670	40	7094	4	-17368	29	6942	20	-19320	30
	At	85	20074	27	1406	23	7572	7	*		6180	40	*	
	Rn	86	*		466	26	8040	12	*		9825	27	*	
194	Ta	73	10380#	640#	*	*	9940#	540#	*		920#	540#		
	W	74	11020#	360#	*	-1920#	500#	7910#	300#	*	-2370#	300#		
	Re	75	11790#	210#	18750#	450#	-1150#	280#	5300#	200#	-13660#	450#	-1910#	200#
	Os	76	12696	3	17360#	200#	-480	40	2325.0	2.4	-13440#	200#	-5970.2	2.0
	Ir	77	13838.78	0.23	15520	70	680	70	-319.8	2.5	-9590	40	-6123.4	0.3
	Pt	78	14614.2	2.5	13455.8	2.3	1522.8	0.5	-2576.1	2.9	-8654.8	2.3	-9427	9
	Au	79	15582	16	11954.3	2.4	2116.7	2.5	-5274	14	-4964.7	2.5	-9221	16
	Hg	80	16315	16	10473	4	2697.6	3.0	-7976	18	-4993	3	-12778	7
	Tl	81	17210	30	8743	21	3471	14	-10909	15	-822	16	-12810	50
	Pb	82	17795	22	6774	23	4738	17	-13203	22	-435	23	-16395	19
	Bi	83	18640	30	4730	30	5918	5	-15309	26	4159	9	-15775	16
	Po	84	19077	17	3027	19	6987	3	-16728	21	3900	50	-19009	25
	At	85	19790	40	1760	40	7454	11	*		7875	26	-17830	40
	Rn	86	*		784	20	7862	10	*		6760	22	*	
195	W	74	10870#	360#	*	*	8500#	300#	*		-1840#	360#		
	Re	75	11490#	300#	19290#	500#	-1510#	420#	6110#	300#	-15570#	590#	-1220#	300#
	Os	76	12260	60	17800#	200#	-760	70	3280	60	-12270#	300#	-5050	60
	Ir	77	13298.65	0.13	16040	40	233	10	874.8	1.6	-11740#	200#	-5003.5	1.3
	Pt	78	14456.9	1.3	13977.5	2.3	1176.4	0.5	-1780	23	-7647.7	2.4	-8653.2	2.1
	Au	79	15305	9	12608.7	1.6	1716.8	1.6	-4412	11	-7324.3	1.6	-8454	3
	Hg	80	16094	28	11112	23	2260	24	-7306	29	-3542	23	-12147	27
	Tl	81	16821	13	9328	14	3218	12	-10130	12	-3232	11	-12019	21
	Pb	82	17660	50	7223	24	4459	29	-12650	40	1187	18	-15750	19
	Bi	83	18284	9	5126	9	5832	5	-14555	11	1623	15	-15092	14
	Po	84	18870	40	3440	60	6749.9	2.8	-16110	60	5860	40	-18410	40
	At	85	19546	24	2164	12	7344	6	*		5270	11	-17265	19
	Rn	86	20140	60	1200	50	7690	50	*		8770	50	*	
196	W	74	10500#	500#	*	*	9400#	400#	*		-1370#	500#		
	Re	75	11450#	360#	19820#	590#	-1900#	500#	6890#	300#	*	-1100#	300#	
	Os	76	11980	40	18330#	300#	-1050#	200#	4370	40	-14560#	300#	-4660	40
	Ir	77	13050	40	16780#	200#	-270	80	1700	40	-11150#	300#	-4710	40
	Pt	78	14027.07	0.17	14787.3	2.4	812.8	2.3	-818.6	3.0	-10420	60	-8148.8	1.0
	Au	79	15069	4	13185	3	1272	3	-3642	12	-6735	3	-8197	23
	Hg	80	15785	4	11643.8	3.0	2038	4	-6478	8	-6321.1	3.0	-11742	11
	Tl	81	16702	18	9863	12	2851	20	-9488	27	-2219	12	-11860	22
	Pb	82	17283	19	7742	8	4238	17	-11875	16	-1624	24	-15394	9
	Bi	83	18123	25	5649	28	5440	40	-14090	40	2857	27	-15020	40
	Po	84	18611	19	3843	22	6658.1	2.4	-15444	20	2946	22	-18074	17
	At	85	19340	40	2460	30	7195	3	*		6820	30	-17040	60
	Rn	86	19895	22	1602	19	7617	9	*		5740	40	*	

Table III. Nuclear-reaction and separation energies (continued, Explanation of Table on p.030003-98)

A	Elt.	Z	S(n)		S(p)		Q(4β ⁻)		Q(d,α)		Q(p,α)		Q(n,α)	
197	W	74	4330#	570#	*		15280#	400#	*		7020#	640#	*	
	Re	75	6030#	420#	8910#	500#	10640#	300#	11220#	420#	8890#	420#	2440#	590#
	Os	76	5100#	200#	10060#	360#	5230#	200#	10980#	360#	6790#	280#	4860#	360#
	Ir	77	6900	40	7280	40	78	26	11960	60	9035	20	4620#	200#
	Pt	78	5846.56	0.26	8270	40	-5674	5	11983.3	1.3	6976.0	1.3	7661.8	2.4
	Au	79	8072.3	2.9	5784.2	0.5	-11453	8	12364.9	0.5	8484.4	0.5	7038.4	1.4
	Hg	80	6785.6	1.5	6690	3	-17180	50	12738	3	6536	4	9866	3
	Tl	81	8916	20	3805	17	-21986	18	13383	28	8706	17	9517	16
	Pb	82	7468	9	4538	13	-26256	17	14121	12	7056	15	13085	6
	Bi	83	9749	26	1628	11	-29940	60	14731	20	9385	19	12897	16
	Po	84	7960	50	2640	60	*	*	15380	50	7530	50	16500	50
	At	85	10510	30	171	16	*	*	15410	40	9513	15	15320	10
	Rn	86	8532	22	1860	30	*	*	15691	19	7095	30	18161	21
	Fr	87	*		-990	60	*	*	15910	70	9390	60	16620	60
198	Re	75	4710#	500#	9290#	570#	12440#	400#	12450#	570#	8730#	500#	*	
	Os	76	6600#	280#	10620#	360#	7120#	200#	9420#	360#	6610#	360#	2820#	360#
	Ir	77	5630#	200#	7800#	280#	1710#	200#	13170#	200#	8560#	200#	5400#	360#
	Pt	78	7555.6	2.1	8929	20	-3837	9	10240	40	6652.3	2.4	5250	60
	Au	79	6512.36	0.09	6450.0	0.5	-10211	28	13774.5	0.5	8077.1	0.5	7757.9	1.4
	Hg	80	8485	3	7103.5	0.5	-15481	17	10895.2	3.0	6476.8	1.2	7485.9	0.6
	Tl	81	7258	18	4277	8	-20814	10	15008	8	8349	24	10685	8
	Pb	82	9393	10	5015	19	-24837	16	12140	15	6952	14	10592	25
	Bi	83	7754	29	1913	28	-28940	40	16690	29	9200	30	14430	30
	Po	84	10190	50	3075	19	*	*	13250	30	7416	18	13881	25
	At	85	8431	10	650	50	*	*	17469	15	9210	40	16957	8
	Rn	86	10812	21	2164	16	*	*	13400	30	7104	16	15470	40
	Fr	87	8750	60	-770	40	*	*	18310	40	9390	60	18690	30
	199	Re	75	5790#	570#	*		14230#	400#	10990#	570#	8880#	570#	*
Os		76	4720#	280#	10630#	450#	9060#	200#	10730#	360#	6920#	360#	4040#	450#
Ir		77	6650#	200#	7850#	200#	3660	50	11620#	200#	8740	60	3790#	300#
Pt		78	5556.0	0.5	8860#	200#	-2157	10	11586	20	6910	40	6530	40
Au		79	7584.28	0.06	6478.7	2.1	-8296	11	12036.8	0.5	8414.8	0.5	5990	40
Hg		80	6663.1	0.6	7254.3	0.6	-14338	18	12304.5	0.6	6456.7	3.0	8744.8	0.7
Tl		81	8602	29	4394	28	-19236	28	13192	28	8631	28	8726	28
Pb		82	7236	13	4992	13	-23730	40	13821	19	7129	16	12241	10
Bi		83	9499	30	2019	14	-27569	17	14659	12	9415	13	12345	16
Po		84	7806	25	3130	30	*	*	15190	20	7660	30	15786	20
At		85	10180	8	639	18	*	*	15250	50	9514	15	14832	25
Rn		86	8340	40	2070	40	*	*	15570	40	7280	50	17620	40
Fr		87	10870	40	-713	19	*	*	15972	21	9664	20	16330	30
200		Os	76	6370#	360#	11210#	500#	10720#	300#	9070#	500#	6590#	420#	2010#
	Ir	77	5280#	200#	8420#	280#	5440#	200#	12940#	280#	8560#	280#	4540#	360#
	Pt	78	7282	20	9490	50	-348	23	9930#	200#	6529	28	4360#	200#
	Au	79	6218	27	7140	27	-6870	30	13375	27	8044	27	6670	30
	Hg	80	8028.52	0.11	7698.5	0.6	-12562	8	10788.3	0.6	6500.5	0.6	6562.9	0.7
	Tl	81	7059	29	4790	6	-18059	25	14618	6	8357	7	9739	6
	Pb	82	9091	15	5480	30	-22246	17	11988	13	6955	20	9936	11
	Bi	83	7645	25	2428	24	-26500	40	16408	24	9239	23	13617	28
	Po	84	9805	20	3433	13	*	*	13139	29	7609	11	13450	9
	At	85	8236	25	1070	30	*	*	17200	30	9230	60	16346	26
	Rn	86	10580	40	2470	15	*	*	13421	15	7215	16	15000	50
	Fr	87	8710	30	-340	50	*	*	18070	30	9490	30	18130	30

Table III. Nuclear-reaction and separation energies (continued, Explanation of Table on p. 030003-98)

A	Elt.	Z	S(2n)	S(2p)	$Q(\alpha)$	$Q(2\beta^-)$	$Q(\epsilon p)$	$Q(\beta^- n)$						
197	W	74	10270#	500#	*	*	10170#	450#	*	-670#	500#			
	Re	75	11070#	420#	*	-2060#	500#	7760#	300#	*	-300#	300#		
	Os	76	11940#	200#	18880#	360#	-1450#	280#	5110#	200#	-13720#	450#	-3950#	200#
	Ir	77	12714	20	17260#	300#	-460	40	2876	20	-13010#	300#	-3691	20
	Pt	78	13768.54	0.29	15490	60	549.6	2.3	120	3	-9430	40	-7352.4	3.0
	Au	79	14715.3	1.1	14025.4	1.4	971.6	1.4	-2798	16	-8990	40	-7385.1	2.9
	Hg	80	15669	23	12324	3	1514	3	-5795	6	-5185	3	-11115	13
	Tl	81	16329	20	10353	16	2638	18	-8654	18	-4492	17	-11065	18
	Pb	82	17180	19	8310	24	3892	16	-11390	50	-208	6	-14808	25
	Bi	83	17804	10	6110	14	5365	11	-13332	12	520	15	-14285	16
	Po	84	18440	60	4230	50	6412	3	-14870	50	4700	50	-17510	60
	At	85	19028	12	2908	10	7104	3	-16610	50	4365	26	-16398	16
	Rn	86	19680	50	2010	40	7411	7	*	*	7694	21	*	*
	Fr	87	*	*	850	60	7900	50	*	*	6880	60	*	*
	198	Re	75	10740#	500#	*	-2270#	640#	8680#	450#	*	100#	450#	
Os		76	11700#	200#	19530#	450#	-1740#	360#	6070#	200#	-15990#	450#	-3640#	200#
Ir		77	12530#	200#	17860#	360#	-1010#	280#	3760#	200#	-12610#	360#	-3470#	200#
Pt		78	13402.1	2.1	16200	40	106	3	1050.3	2.1	-11880#	200#	-6835.6	2.1
Au		79	14584.7	2.9	14720	40	526.0	1.4	-2052	8	-8606	20	-7112	3
Hg		80	15271.0	2.9	12887.7	0.6	1380.8	0.6	-4887	9	-7823.5	0.6	-10684	16
Tl		81	16175	14	10968	8	2258	8	-8159	29	-3678	8	-10855	9
Pb		82	16862	12	8819	9	3692	9	-10594	19	-2816	9	-14452	12
Bi		83	17500	40	6450	30	5140	30	-12655	29	1680	30	-14080	60
Po		84	18143	22	4703	19	6309.7	1.4	-14243	22	1983	18	-17189	19
At		85	18940	30	3283	25	6889.4	1.9	-16290	30	5684	10	-16296	17
Rn		86	19344	20	2335	19	7349	4	*	*	4840	50	-19560	60
Fr		87	*	*	1090	40	7869	20	*	*	8640	30	*	*
199		Re	75	10500#	500#	*	*	9540#	400#	*	910#	450#		
		Os	76	11320#	280#	19920#	450#	-1900#	360#	6910#	200#	*	-2730#	280#
	Ir	77	12280	50	18470#	300#	-1250#	300#	4700	40	-14550#	400#	-2570	40
	Pt	78	13111.6	2.1	16660#	200#	-300	60	2157.4	2.2	-10840#	200#	-5879.2	2.1
	Au	79	14096.64	0.11	15408	20	173.6	1.4	-1034	28	-10560#	200#	-6210.7	0.5
	Hg	80	15148	3	13704.3	0.7	822.9	0.7	-4314	10	-6931.0	2.1	-10089	8
	Tl	81	15860	30	11498	28	2083	28	-7262	30	-5768	28	-10063	29
	Pb	82	16629	11	9270	10	3357	25	-10023	21	-1566	10	-13934	30
	Bi	83	17253	13	7034	19	4933	7	-11974	12	-558	13	-13396	20
	Po	84	17990	50	5041	19	6074.3	1.9	-13710	40	3570	20	-16565	19
	At	85	18611	10	3714	10	6777.3	1.2	-15595	15	3257	28	-15664	14
	Rn	86	19150	40	2720	60	7132	4	*	*	6680	40	-19140	50
	Fr	87	19630	60	1451	16	7817	10	*	*	6197	15	*	*
	200	Os	76	11090#	360#	*	-2320#	500#	7820#	300#	*	-2450#	300#	
		Ir	77	11930#	280#	19050#	450#	-1490#	360#	5630#	200#	-14040#	450#	-2290#
Pt		78	12838	20	17340#	200#	-750	40	2904	20	-13410#	200#	-5577	20
Au		79	13802	27	16000#	200#	-230	50	-193	27	-10130	50	-5765	27
Hg		80	14691.6	0.6	14177.2	2.1	716.3	0.7	-3252	11	-9403.6	2.2	-9515	28
Tl		81	15661	9	12044	6	1667	6	-6676	23	-5242	6	-9887	12
Pb		82	16326	14	9875	11	3150	11	-9309	13	-3994	11	-13525	15
Bi		83	17140	40	7420	24	4701	25	-11380	30	400	40	-13234	29
Po		84	17611	19	5452	12	5981.6	1.8	-12937	16	1001	13	-16190	9
At		85	18416	25	4200	40	6596.2	1.3	-15120	40	4521	27	-15560	40
Rn		86	18917	19	3109	22	7043.4	2.1	*	*	3915	23	-18847	19
Fr		87	19580	40	1730	30	7622	4	*	*	7670	30	*	*

Table III. Nuclear-reaction and separation energies (continued, Explanation of Table on p.030003-98)

A	Elt.	Z	S(n)	S(p)	$Q(4\beta^-)$	$Q(d,\alpha)$	$Q(p,\alpha)$	$Q(n,\alpha)$						
201	Os	76	4530#	420#	*	12420#	300#	10330#	500#	6760#	500#	*		
	Ir	77	6360#	280#	8410#	360#	7280#	200#	11300#	280#	8800#	280#	2890#	450#
	Pt	78	5210	50	9420#	200#	1530	50	11370	60	6940#	200#	5740#	200#
	Au	79	7232	27	7091	20	-4984	16	11699	4	8367	4	5070#	200#
	Hg	80	6230.6	0.6	7711	27	-11141	5	12142.0	0.8	6782.3	0.8	7887.9	2.2
	Tl	81	8205	15	4967	14	-16391	16	13076	14	8638	14	8046	14
	Pb	82	7091	18	5513	15	-21200	50	13500	30	7122	16	11330	14
	Bi	83	9117	27	2454	19	-25005	18	14526	18	9515	18	11759	17
	Po	84	7651	9	3439	23	-28458	21	14987	12	7712	28	15193	10
	At	85	9873	26	1137	11	*	*	15130	20	9548	19	14226	29
	Rn	86	8140	50	2370	60	*	*	15460	50	7510	50	17050	50
	Fr	87	10620	30	-304	16	*	*	15800	40	9683	16	15949	11
	Ra	88	*	*	1480	40	*	*	15876	25	7230	40	18814	24
202	Os	76	5920#	500#	*	14260#	400#	*	*	6640#	570#	*		
	Ir	77	4950#	360#	8830#	420#	9200#	300#	12710#	420#	8570#	360#	3730#	500#
	Pt	78	7020	60	10080#	200#	3248	25	9630#	200#	6570	50	3440#	200#
	Au	79	6024	24	7900	60	-3611	28	12960	30	7900	23	5690	50
	Hg	80	7754.10	0.20	8234	3	-9404	9	10606	27	6612.5	0.8	5689.8	2.2
	Tl	81	6871	14	5606.6	1.6	-15389	28	14233.9	1.6	8429.9	1.6	8759.9	1.7
	Pb	82	8741	14	6049	15	-19666	18	11817	7	6983	28	9252	4
	Bi	83	7396	22	2759	21	-23838	17	16220	19	9354	18	12960	30
	Po	84	9492	10	3814	17	-27016	17	13140	24	7720	14	12937	13
	At	85	7873	29	1359	28	*	*	17062	29	9480	30	15853	30
	Rn	86	10270	50	2774	19	*	*	13420	30	7413	18	14580	25
	Fr	87	8564	11	120	50	*	*	17812	15	9460	40	17566	9
	Ra	88	10933	25	1803	18	*	*	13650	30	7168	20	16220	40
203	Os	76	2620#	570#	*	17630#	400#	*	*	*	*	*		
	Ir	77	5990#	500#	8890#	570#	11070#	400#	11260#	500#	8950#	500#	*	
	Pt	78	5010#	200#	10140#	360#	5160#	200#	10980#	280#	6850#	280#	4800#	360#
	Au	79	6862	23	7740	25	-1619	13	11310	50	8320	20	4110#	200#
	Hg	80	5995.3	1.6	8205	23	-7958	9	11842	4	6835	27	6976	20
	Tl	81	7852.5	1.6	5705.0	1.1	-13599	11	12612.0	1.1	8605.9	1.2	7125	27
	Pb	82	6917	8	6095	7	-18633	19	13105	16	7125	9	10363	7
	Bi	83	8855	20	2873	13	-22401	14	14457	19	9590	17	11169	14
	Po	84	7441	12	3858	18	-25970	40	14816	17	7924	24	14587	14
	At	85	9643	30	1510	14	*	*	15069	12	9643	13	13855	25
	Rn	86	7950	25	2850	30	*	*	15347	20	7700	30	16434	20
	Fr	87	10291	9	138	19	*	*	15660	50	9745	15	15511	25
	Ra	88	8480	40	1720	40	*	*	15780	40	7390	50	18310	40
204	Ir	77	3070#	570#	9340#	570#	14660#	400#	14110#	570#	10420#	500#	*	
	Pt	78	6370#	280#	10520#	450#	7190#	200#	9570#	360#	6840#	280#	2960#	360#
	Au	79	5580#	200#	8310#	280#	-0#	200#	12750#	200#	7960#	210#	4890#	280#
	Hg	80	7492.2	1.6	8836	3	-6349	11	10374	23	6575	3	4700	50
	Tl	81	6656.08	0.29	6365.9	1.3	-12471	22	13710.0	1.1	8180.5	1.1	7701	3
	Pb	82	8395	6	6637.5	0.3	-17140	7	11581.1	1.6	6935	14	8199.1	1.1
	Bi	83	7192	16	3148	11	-21253	26	16006	10	9489	17	12181	17
	Po	84	9102	14	4105	17	-24398	19	13111	19	7939	19	12576	18
	At	85	7784	25	1854	24	*	*	16777	24	9510	23	15187	27
	Rn	86	9888	20	3097	13	*	*	13331	29	7683	11	14197	9
	Fr	87	8340	25	530	30	*	*	17590	30	9540	60	17043	26
	Ra	88	10680	40	2109	16	*	*	13671	17	7332	18	15780	50

Table III. Nuclear-reaction and separation energies (continued, Explanation of Table on p. 030003-98)

A	Elt.	Z	S(2n)		S(2p)		Q(α)		Q(2 β^-)		Q(ϵ_p)		Q(β^-n)	
201	Os	76	10900#	360#	*		-2530#	500#	8500#	300#	*		-1700#	360#
	Ir	77	11640#	200#	19620#	450#	-1820#	360#	6500#	200#	*		-1370#	200#
	Pt	78	12490	50	17840#	200#	-860#	200#	3920	50	-12250#	300#	-4570	60
	Au	79	13450	3	16580	40	-562	20	780	15	-12080#	200#	-4969	3
	Hg	80	14259.1	0.6	14851.8	2.2	332.3	0.8	-2392	14	-8352	20	-8687	6
	Tl	81	15260	30	12665	14	1534	14	-5764	21	-7230	30	-9001	18
	Pb	82	16182	17	10303	14	2844	14	-8750	15	-3057	14	-12972	26
	Bi	83	16762	18	7930	30	4500	6	-10627	17	-1658	16	-12546	17
	Po	84	17455	19	5867	11	5799.3	1.7	-12450	50	2441	12	-15605	25
	At	85	18109	10	4570	13	6472.8	1.6	-14378	12	2292	24	-14856	16
	Rn	86	18720	60	3440	50	6860.7	2.3	-16010	50	5580	50	-18280	60
	Fr	87	19325	16	2166	11	7519	4	*	*	5287	26	*	*
	Ra	88	*		1140	40	8002	12	*	*	8653	24	*	*
	202	Os	76	10450#	500#	*		*		9610#	400#	*		-1260#
Ir		77	11310#	360#	*		-2060#	500#	7580#	300#	*		-1110#	300#
Pt		78	12240	30	18490#	300#	-1280#	200#	4653	25	-14740#	300#	-4363	25
Au		79	13260	40	17320#	200#	-960#	200#	1627	23	-11750#	200#	-4762	23
Hg		80	13984.7	0.6	15324	20	133.8	2.2	-1405	4	-10890	50	-8236	14
Tl		81	15076	6	13318	27	1175.6	1.7	-5239	15	-6868	4	-8780	14
Pb		82	15832	12	11015	4	2589	4	-7999	9	-5567	4	-12595	16
Bi		83	16513	27	8272	16	4362	17	-10150	30	-850	21	-12292	16
Po		84	17142	11	6269	14	5701.0	1.7	-11667	20	40	16	-15223	12
At		85	17750	40	4800	40	6353.8	1.3	-13687	29	3540	30	-14590	60
Rn		86	18413	22	3911	19	6773.8	1.8	-15349	23	2958	18	-17935	20
Fr		87	19180	30	2494	25	7386	4	*	*	6597	11	-16912	21
Ra		88	*		1498	20	7880	7	*	*	5860	50	*	*
203		Os	76	8540#	500#	*		*		11990#	450#	*		1070#
	Ir	77	10940#	450#	*		-2250#	570#	8450#	400#	*		-70#	400#
	Pt	78	12030#	200#	18970#	360#	-1570#	280#	5640#	200#	-13830#	450#	-3350#	200#
	Au	79	12885	4	17830#	200#	-1170	40	2618	3	-13660#	300#	-3869	3
	Hg	80	13749.4	1.6	16110	50	-305.5	2.7	-483	7	-9866	25	-7360.4	2.0
	Tl	81	14723	14	13939	3	907.4	1.2	-4237	13	-8697	23	-7892	4
	Pb	82	15658	15	11702	7	2335	7	-7476	11	-4730	7	-12116	17
	Bi	83	16251	20	8922	19	4110	30	-9362	17	-2834	13	-11655	15
	Po	84	16932	10	6618	16	5496	5	-11157	20	1341	9	-14791	29
	At	85	17516	13	5324	19	6210.1	0.8	-13039	12	1290	19	-13959	20
	Rn	86	18220	50	4210	19	6629.9	2.1	-14820	40	4499	20	-17321	19
	Fr	87	18855	11	2912	10	7275	4	*	*	4178	29	-16270	16
	Ra	88	19420	40	1840	60	7736	6	*	*	7650	40	*	*
	204	Ir	77	9050#	500#	*		*		10960#	450#	*		1870#
Pt		78	11370#	200#	19410#	450#	-1570#	360#	6770#	200#	-17570#	450#	-2850#	200#
Au		79	12440#	200#	18450#	360#	-1460#	280#	3700#	200#	-13250#	450#	-3450#	200#
Hg		80	13487.5	0.7	16576	25	-516	20	419.7	1.2	-12350#	200#	-7000.1	1.2
Tl		81	14508.6	1.6	14571	23	469	27	-3700	9	-8492	3	-7631	6
Pb		82	15312	4	12342.5	1.1	1968.5	1.1	-6769	11	-7129.6	1.3	-11656	13
Bi		83	16047	18	9244	9	3976	11	-8770	24	-2173	9	-11406	13
Po		84	16542	14	6979	12	5484.9	1.4	-10371	13	-844	13	-14250	15
At		85	17430	40	5712	27	6070.4	1.2	-12480	30	2360	26	-13793	29
Rn		86	17838	19	4607	11	6546.7	1.8	-14027	17	2052	11	-16918	10
Fr		87	18632	26	3380	40	7170.3	2.4	*	*	5481	27	-16130	50
Ra	88	19161	21	2247	23	7637	7	*	*	4922	24	*	*	

Table III. Nuclear-reaction and separation energies (continued, Explanation of Table on p. 030003-98)

A	Elt.	Z	S(n)	S(p)	$Q(4\beta^-)$		$Q(d,\alpha)$		$Q(p,\alpha)$		$Q(n,\alpha)$		
205	Ir	77	4340#	640#	*	17860#	500#	12390#	640#	11990#	640#	*	
	Pt	78	3120#	360#	10570#	500#	10800#	300#	12430#	500#	8670#	420#	5770#
	Au	79	6190#	280#	8140#	280#	2300#	200#	11570#	280#	8790#	200#	3650#
	Hg	80	5669	4	8930#	200#	-4766	11	11567	5	6929	24	6051
	Tl	81	7546.0	0.5	6419.7	1.3	-10849	15	12159.2	1.3	8388.5	1.2	6179
	Pb	82	6731.66	0.11	6713.06	0.21	-16060	5	12701.9	0.4	7074.0	1.6	9221.5
	Bi	83	8490	11	3244	5	-19755	9	14433	8	9740	6	10562
	Po	84	7251	15	4164	14	-23360	70	14714	16	8084	18	14066
	At	85	9168	27	1920	19	-27080	50	15050	17	9834	17	13416
	Rn	86	7811	9	3123	23	*	*	15164	12	7745	28	15878
	Fr	87	9988	26	629	11	*	*	15555	20	9829	19	14927
	Ra	88	8290	70	2060	70	*	*	15670	70	7610	70	17760
	Ac	89	*	*	-760	50	*	*	16160	60	9900	50	16660
	206	Pt	78	4740#	420#	10960#	590#	14150#	300#	10770#	500#	9920#	500#
Au		79	3520#	360#	8540#	420#	5810#	300#	14420#	360#	10280#	360#	6120#
Hg		80	6729	21	9470#	200#	-2757	21	10420#	200#	7062	21	4330#
Tl		81	6503.8	0.4	7255	4	-9824	15	13147.6	1.3	7880.0	1.4	6536
Pb		82	8086.66	0.06	7253.7	0.5	-14653	9	11271.37	0.21	6839.8	0.4	7130.1
Bi		83	7035	9	3547	8	-18786	29	15792	8	9622	10	11380
Po		84	8739	11	4413	6	-21754	18	13168	10	8200	13	12244
At		85	7529	21	2197	18	-25910	50	16622	19	9745	17	14742
Rn		86	9494	10	3450	17	*	*	13453	24	7894	14	13824
Fr		87	8004	29	822	29	*	*	17439	29	9780	30	16570
Ra		88	10340	70	2414	20	*	*	13670	30	7553	19	15366
Ac		89	8700	70	-350	90	*	*	18130	50	9680	60	18250
207		Pt	78	2980#	500#	*	17910#	400#	12130#	640#	10010#	570#	*
		Au	79	4670#	420#	8470#	420#	9250#	300#	12870#	420#	11980#	360#
	Hg	80	3610	40	9560#	300#	660	30	12990#	200#	9030#	200#	7080#
	Tl	81	6852	5	7378	21	-7807	14	11964	7	8520	5	5260#
	Pb	82	6737.78	0.10	7487.7	0.6	-13817	9	12079.6	0.5	6758.15	0.23	7884.5
	Bi	83	8098	8	3558.0	2.1	-17210	18	14426.4	2.1	9919.3	2.1	9937.9
	Po	84	7028	8	4406	10	-20690	50	14630	8	8364	11	13611
	At	85	8869	19	2328	13	-24370	50	15005	16	9978	17	13065
	Rn	86	7573	12	3494	17	*	*	15048	17	8105	24	15353
	Fr	87	9670	30	1000	19	*	*	15576	18	9990	19	14677
	Ra	88	8090	60	2500	60	*	*	15570	50	7800	60	17160
	Ac	89	10400	70	-290	50	*	*	16020	90	9950	50	16190
	208	Pt	78	4520#	570#	*	20760#	400#	*	*	9830#	640#	*
		Au	79	3360#	420#	8850#	500#	12770#	300#	14240#	420#	11730#	420#
Hg		80	4850	40	9740#	300#	4200	30	11660#	300#	10370#	200#	5350#
Tl		81	3787	6	7552	30	-4280	9	14906	20	10402	4	7670#
Pb		82	7367.87	0.05	8003	5	-12093	11	11215.6	0.6	6936.3	0.5	6186
Bi		83	6886.9	2.7	3707.1	2.0	-16204	12	15626.2	2.0	9764.1	2.0	10597.1
Po		84	8395	7	4703.9	2.5	-19197	9	13269	8	8459	5	11947.0
At		85	7314	15	2613	11	-23220	60	16430	10	9916	13	14241
Rn		86	9092	14	3717	17	-26340	40	13485	19	8180	19	13512
Fr		87	7893	21	1320	15	*	*	17178	15	9908	13	15952
Ra		88	9890	50	2717	20	*	*	13681	30	7902	12	15084
Ac		89	8460	80	80	80	*	*	17900	60	9780	90	17710
Th		90	*	*	1750	60	*	*	13920	60	7440	60	16490

Table III. Nuclear-reaction and separation energies (continued, Explanation of Table on p.030003-98)

A	Elt.	Z	S(2n)	S(2p)	$Q(\alpha)$	$Q(2\beta^-)$	$Q(\epsilon p)$	$Q(\beta^- n)$						
205	Ir	77	7410#	640#	*	*	12810#	540#	*	3890#	540#			
	Pt	78	9480#	360#	19900#	500#	-150#	420#	9320#	300#	*	-390#	360#	
	Au	79	11770#	200#	18660#	450#	-1300#	280#	5050#	200#	-16370#	450#	-2150#	200#
	Hg	80	13161	4	17240#	200#	-970	50	1482	4	-11660#	200#	-6013	4
	Tl	81	14202.1	0.5	15255	3	155	3	-2756	5	-10460#	200#	-6782.3	0.5
	Pb	82	15126	6	13078.9	1.3	1467.4	1.1	-6249	10	-6369.1	1.2	-11196	9
	Bi	83	15682	14	9881	5	3691	15	-8093	16	-4007	5	-10795	12
	Po	84	16353	13	7313	12	5325	10	-9812	11	300	10	-13717	24
	At	85	16952	18	6025	20	6019.6	1.7	-11662	17	385	18	-13073	17
	Rn	86	17699	19	4977	10	6386.5	1.8	-13550	70	3342	12	-16388	25
	Fr	87	18329	10	3725	13	7054.7	2.4	-15420	50	3277	24	-15438	17
	Ra	88	18970	80	2590	70	7490	50	*	*	6520	70	*	*
	Ac	89	*	*	1350	50	8090	50	*	*	6210	60	*	*
206	Pt	78	7850#	360#	*	1030#	500#	11310#	300#	*	1070#	360#		
	Au	79	9710#	360#	19110#	500#	140#	420#	8040#	300#	-15540#	590#	0#	300#
	Hg	80	12398	20	17600#	200#	-680	30	2840	20	-15270#	300#	-5196	20
	Tl	81	14049.9	0.6	16180#	200#	-325	23	-2225	8	-10770#	200#	-6554.4	0.6
	Pb	82	14818.33	0.12	13673.4	1.2	1134.8	1.1	-5597	4	-8787	4	-10792	5
	Bi	83	15525	12	10260	8	3527	8	-7599	17	-3496	8	-10578	13
	Po	84	15990	12	7657	4	5327.0	1.3	-9056	9	-1707	4	-13288	16
	At	85	16697	27	6362	18	5887	5	-11190	30	1346	16	-12791	16
	Rn	86	17305	11	5370	14	6383.7	1.6	-12699	20	1099	13	-15894	12
	Fr	87	17990	40	3940	40	6923	4	-14720	60	4440	30	-15150	80
	Ra	88	18634	24	3042	19	7415	4	*	*	3986	19	-18610	50
	Ac	89	*	*	1710	60	7960	50	*	*	7500	50	*	*
	207	Pt	78	7720#	500#	*	680#	570#	11950#	400#	*	1600#	500#	
Au		79	8180#	360#	19430#	590#	1460#	500#	10220#	300#	*	2060#	300#	
Hg		80	10340	30	18100#	300#	710#	200#	5965	30	-14150#	300#	-2305	30
Tl		81	13356	5	16840#	200#	-316	6	-980	6	-14110#	300#	-5320	5
Pb		82	14824.44	0.11	14742	4	392.3	1.3	-5306	7	-8795	20	-10495	8
Bi		83	15133	6	10811.7	2.1	3281.8	2.1	-6827	13	-5090.2	2.1	-9937	5
Po		84	15767	12	7953	7	5215.9	2.5	-8511	11	-649	7	-12787	16
At		85	16398	19	6741	13	5872	3	-10383	21	-488	15	-12166	15
Rn		86	17068	10	5691	13	6251.2	1.6	-12180	50	2265	9	-15464	29
Fr		87	17677	19	4450	23	6893	20	-13990	50	2296	23	-14481	25
Ra		88	18440	90	3320	50	7270	50	*	*	5390	50	-18010	70
Ac		89	19100	70	2120	50	7840	50	*	*	5100	60	*	*
208		Pt	78	7500#	500#	*	*	12280#	400#	*	1750#	500#		
	Au	79	8030#	420#	*	1160#	500#	10650#	300#	*	2320#	300#		
	Hg	80	8460	40	18210#	300#	2230#	200#	8480	30	-16010#	400#	-300	30
	Tl	81	10639.4	1.8	17110#	300#	1480#	200#	2120.1	2.6	-13230#	300#	-2369.4	1.7
	Pb	82	14105.65	0.11	15381	20	516.6	1.2	-4279.0	1.3	-12550	30	-9765.3	2.1
	Bi	83	14985	8	11194.8	2.0	3051.0	2.0	-6400	9	-5125	6	-9796	7
	Po	84	15424	4	8262.0	1.3	5215.4	1.3	-7814	11	-2306.5	1.3	-12313	13
	At	85	16183	17	7020	12	5751.1	2.2	-9804	15	296	9	-11906	12
	Rn	86	16665	14	6045	12	6260.7	1.7	-11383	14	201	13	-14883	21
	Fr	87	17570	30	4814	19	6785	24	-13420	60	3273	17	-14280	50
	Ra	88	17980	20	3717	12	7273	5	-14960	40	3074	12	-17490	50
	Ac	89	18870	80	2580	60	7720	50	*	*	6310	60	*	*
	Th	90	*	*	1460	40	8200	30	*	*	5850	60	*	*

Table III. Nuclear-reaction and separation energies (continued, Explanation of Table on p. 030003-98)

A	Elt.	Z	S(n)	S(p)	$Q(4\beta^-)$		$Q(d,\alpha)$		$Q(p,\alpha)$		$Q(n,\alpha)$		
209	Au	79	4510#	500#	8840#	570#	15720#	400#	12710#	570#	11960#	500#	*
	Hg	80	3450#	150#	9830#	330#	7720#	150#	12880#	340#	10430#	330#	6630#
	Tl	81	4966	6	7670	30	-762	8	13550	30	12165	21	6220#
	Pb	82	3937.4	1.3	8153.5	2.1	-8674	10	14131	6	9502.8	1.4	8978
	Bi	83	7459.8	1.9	3799.0	0.8	-14489	15	14904.2	0.8	10391.0	0.8	9641.1
	Po	84	6967.8	1.9	4784.8	2.4	-18224	6	14399.3	2.5	8526	8	13065.9
	At	85	8484	10	2702	5	-21730	50	14974	8	10170	6	12792
	Rn	86	7357	15	3760	13	-25310#	140#	14997	16	8353	18	14894
	Fr	87	9175	19	1403	18	*	*	15576	17	10227	17	14307
	Ra	88	7941	11	2765	13	*	*	15413	18	7965	29	16638
	Ac	89	9980	80	170	50	*	*	16010	70	10140	50	15730
Th	90	8390#	140#	1680#	150#	*	*	15930#	150#	7750#	150#	18450#	
210	Au	79	3200#	570#	*	*	17120#	400#	14030#	570#	11730#	570#	*
	Hg	80	4790#	250#	10110#	450#	10590#	200#	11450#	360#	10310#	360#	4820#
	Tl	81	3674	13	7890#	150#	2725	14	14730	30	12100	30	7210#
	Pb	82	5185.2	1.3	8373	6	-5124	5	12732.4	1.9	11170	5	7405
	Bi	83	4604.63	0.08	4466.3	1.1	-11459	15	17667.4	0.8	12524.1	0.8	11889
	Po	84	7658.4	1.4	4983.4	0.8	-16396	9	13627.9	2.0	8965.5	2.1	12145.31
	At	85	7161	9	2895	8	-20760	60	16208	8	10038	10	13729
	Rn	86	8735	11	4011	7	-23664	19	13576	10	8487	13	13187
	Fr	87	7635	21	1681	18	*	*	17033	19	10166	17	15541
	Ra	88	9487	11	3077	17	*	*	13820	15	8151	20	14724
	Ac	89	8130	80	360	60	*	*	17770	60	10110	80	17280
Th	90	10380#	140#	2070	50	*	*	14020	60	7780	50	16160	
211	Hg	80	3330#	280#	10240#	450#	11810#	200#	12630#	450#	10340#	360#	6010#
	Tl	81	4900	40	8000#	200#	5570	40	13280#	160#	12050	50	5670#
	Pb	82	3835.8	2.6	8535	12	-1738	7	13863	6	11121.2	2.7	8420
	Bi	83	5138	5	4420	5	-7719	13	16466	6	14754	5	10537
	Po	84	4550.8	0.5	4929.6	0.9	-13265	8	16536.9	0.9	11301.7	2.1	14962.4
	At	85	7746	8	2983.1	2.5	-18850	50	15429.6	2.8	10686.4	2.8	12869
	Rn	86	7222	8	4072	10	-22670	70	14838	8	8579	11	14361
	Fr	87	8878	19	1824	13	-26220#	100#	15512	16	10379	16	13976
	Ra	88	7682	12	3124	17	*	*	15312	17	8362	14	16134
	Ac	89	9660	80	530	50	*	*	16050	50	10340	50	15510
	Th	90	8220	80	2170	90	*	*	15780	90	8020	90	17830
Pa	91	*	*	-730#	100#	*	*	16420#	170#	10260#	110#	16970#	
212	Hg	80	4690#	360#	*	*	13130#	300#	11140#	500#	10160#	500#	*
	Tl	81	3540#	210#	8220#	280#	7080#	200#	14530#	280#	11960#	250#	6640#
	Pb	82	5127.2	2.5	8760	40	1111	3	12409	12	10960	6	6740#
	Bi	83	4330	6	4914.0	2.7	-4602	9	17321.4	1.9	14360.7	2.1	11173
	Po	84	6008.2	0.5	5799	5	-10171	11	15133.3	0.8	12753.2	0.8	12891.6
	At	85	5052	3	3484.6	2.2	-15910	50	18035.7	2.1	12601.9	2.5	15276.8
	Rn	86	7976	7	4301	4	-20770	10	14023	8	9087	6	13353
	Fr	87	7447	15	2050	11	-25110	80	16800	10	10289	13	15013
	Ra	88	9102	14	3348	16	*	*	13845	19	8435	18	14388
	Ac	89	8000	70	840	50	*	*	17550	50	10280	50	16690
	Th	90	9870	70	2380	50	*	*	14030	60	8130	50	15899
Pa	91	8560#	130#	-390	100	*	*	18240	80	10090#	160#	18400	

Table III. Nuclear-reaction and separation energies (continued, Explanation of Table on p. 030003-98)

A	Elt.	Z	S(2n)		S(2p)		Q(α)		Q($2\beta^-$)		Q(ϵp)		Q($\beta^- n$)	
209	Au	79	7870#	500#	*		1000#	640#	11110#	400#	*		2650#	400#
	Hg	80	8300#	150#	18680#	430#	1900#	330#	8970#	150#	-14940#	430#	40#	150#
	Tl	81	8753	8	17410#	300#	2700#	200#	4614	6	-14830#	300#	33	6
	Pb	82	11305.2	1.3	15705	30	2248	4	-1248.6	1.9	-11640	30	-6815.7	2.2
	Bi	83	14346.7	2.0	11802	5	3137.3	0.8	-5376	5	-8797.5	1.8	-8860.4	1.5
	Po	84	15363	7	8492.0	1.4	4979.2	1.4	-7425	10	-1906.5	1.4	-11968	9
	At	85	15798	13	7406	6	5757.0	2.0	-9113	16	-1301	5	-11298	12
	Rn	86	16449	13	6373	12	6155.4	2.0	-10799	11	1240	10	-14346	15
	Fr	87	17068	23	5120	19	6777	4	-12610	50	1411	17	-13569	17
	Ra	88	17830	50	4085	10	7143.1	2.7	-14510#	140#	4225	13	-16970	60
	Ac	89	18450	70	2890	50	7730	50	*	*	4220	50	-15910	60
	Th	90	*		1760#	150#	8100#	140#	*	*	7350#	140#	*	*
	210	Au	79	7710#	500#	*		*		11580#	400#	*		2900#
Hg		80	8240#	200#	18950#	450#	1840#	360#	9360#	200#	*		210#	200#
Tl		81	8639	12	17720#	300#	2540#	300#	5545	12	-14000#	400#	296	12
Pb		82	9122.5	0.9	16040	30	3792	20	1224.6	0.9	-13370#	150#	-4541.2	0.5
Bi		83	12064.4	1.9	12619.8	1.8	5036.5	0.8	-2820	8	-8436	6	-6497.2	1.6
Po		84	14626.2	1.3	8782.48	0.13	5407.53	0.07	-6348	5	-5627.5	1.3	-11142	5
At		85	15645	12	7680	8	5631.2	1.0	-8639	17	-1002	8	-11102	13
Rn		86	16092	12	6713	5	6159.0	2.2	-10048	10	-528	5	-13907	15
Fr		87	16810	19	5441	18	6672	5	-12120	60	2260	16	-13263	16
Ra		88	17428	13	4480	14	7151	3	-13617	21	2095	14	-16470	50
Ac		89	18110	80	3120	60	7610	50	*	*	5270	60	-15650#	150#
Th		90	18770	40	2246	21	8069	6	*	*	4912	20	*	*
211		Hg	80	8120#	250#	*		1490#	450#	9870#	200#	*		550#
	Tl	81	8580	40	18120#	400#	2310#	300#	5780	40	-15700#	400#	580	40
	Pb	82	9020.9	2.7	16430#	150#	3570	30	1939.6	2.5	-12420#	200#	-3772.3	2.5
	Bi	83	9743	5	12792	8	6750.4	0.5	-212	6	-9901	13	-3977	5
	Po	84	12209.1	1.5	9395.9	1.4	7594.6	0.5	-3677	7	-4993.0	1.0	-8532	8
	At	85	14907	6	7966.5	2.4	5982.4	1.3	-7507	12	-4144.3	2.4	-10114	5
	Rn	86	15957	12	6967	7	5965.5	1.4	-9587	10	-91	7	-13494	17
	Fr	87	16513	19	5836	13	6662	3	-11340	50	543	14	-12654	15
	Ra	88	17169	10	4805	13	7042	3	-13080	70	3148	9	-16030	60
	Ac	89	17780	70	3610	50	7620	50	-14880#	120#	3250	60	-14930	60
	Th	90	18600#	160#	2530	70	7940	50	*	*	6180	70	*	*
	Pa	91	*		1340#	110#	8510#	110#	*	*	6000#	120#	*	*
	212	Hg	80	8020#	360#	*		1320#	500#	10310#	300#	*		760#
Tl		81	8450#	200#	18460#	450#	2130#	360#	6570#	200#	*		870#	200#
Pb		82	8963.0	2.1	16760#	200#	3290	30	2820.6	1.9	-14210#	200#	-3761	6
Bi		83	9468.6	1.8	13449	12	6207.26	0.03	510.3	2.7	-9330	40	-3756.7	1.7
Po		84	10558.98	0.17	10218.9	0.9	8954.20	0.11	-1709.9	2.9	-7165.5	2.4	-6793.5	2.5
At		85	12799	8	8414.2	2.0	7817.1	0.6	-5112	9	-4058	6	-7944	7
Rn		86	15197	6	7284.4	2.9	6385.1	2.6	-8461	12	-3516.0	3.0	-12591	12
Fr		87	16325	18	6122	12	6529.0	1.6	-10790	50	842	9	-12419	12
Ra		88	16784	14	5172	12	7031.7	1.7	-12310	15	1267	13	-15470	50
Ac		89	17660	80	3970	50	7520	50	-14320	90	4130	50	-14700	90
Th		90	18091	21	2910	14	7958	5	*	*	3990	13	-18040#	100#
Pa		91	*		1770	90	8420	50	*	*	7100	90	*	*

Table III. Nuclear-reaction and separation energies (continued, Explanation of Table on p. 030003-98)

A	Elt.	Z	S(n)		S(p)		Q(4β ⁻)		Q(d,α)		Q(p,α)		Q(n,α)	
213	Hg	80	3160#	420#	*		14320#	300#	*		10200#	500#	*	
	Tl	81	4740#	200#	8260#	300#	8363	27	13120#	200#	12010#	200#	5100#	400#
	Pb	82	3726	7	8940#	200#	2492	8	13590	40	10907	13	7810#	200#
	Bi	83	5185	5	4972	5	-1679	7	15972	5	14361	5	9662	13
	Po	84	4355.4	2.9	5825	3	-6999	10	15916	6	13002.4	2.8	13721.3	2.8
	At	85	6023	5	3499	5	-12734	16	16564	5	14238	5	13859	5
	Rn	86	5108	4	4357	4	-17816	10	16662	4	11140	8	15904	3
	Fr	87	8108	10	2182	6	-23220	70	15913	8	10916	7	14066	9
	Ra	88	7527	15	3427	13	*		15197	15	8543	18	15597	11
	Ac	89	9190	50	935	19	*		16033	17	10576	18	15134	21
	Th	90	8062	14	2450	50	*		15630	50	8190	60	17324	13
Pa	91	10000	100	-260	70	*		16460	100	10470	70	16520	90	
214	Hg	80	4560#	500#	*		15650#	400#	*		*		*	
	Tl	81	3390#	200#	8490#	360#	9840#	200#	14420#	360#	11950#	280#	*	
	Pb	82	5051	7	9256	27	4137	9	12080#	200#	10760	40	6090#	200#
	Bi	83	4040	12	5286	13	-242	14	17059	11	14156	11	10520	40
	Po	84	5887.8	2.8	6527	5	-4563	5	14358.7	1.9	12253	5	11669.3	2.6
	At	85	4872	6	4015	5	-9824	16	17700	4	13917	4	14126	7
	Rn	86	6695	10	5029	10	-15015	14	15019	9	12192	9	13759	9
	Fr	87	5477	10	2552	9	-20440	80	18412	9	12661	11	16335	9
	Ra	88	8324	11	3643	7	*		14320	10	9097	13	14495	9
	Ac	89	7782	22	1191	18	*		17354	19	10476	17	16231	19
	Th	90	9497	14	2749	19	*		14130	50	8360	50	15509	13
Pa	91	8250	100	-80	80	*		18090	80	10440	110	17930	90	
215	Hg	80	3040#	570#	*		16750#	400#	*		*		*	
	Tl	81	4630#	360#	8560#	500#	11170#	300#	12960#	420#	12020#	420#	*	
	Pb	82	3550	50	9410#	200#	5510	50	13270	60	10760#	210#	7230#	300#
	Bi	83	5241	13	5477	6	1311	9	15544	9	14042	6	8830#	200#
	Po	84	4143.0	2.5	6630	11	-3075	8	15401	5	12440.3	2.6	12653.5	2.3
	At	85	5947	8	4075	7	-7286	14	16109	7	13978	7	12509	7
	Rn	86	4920	12	5078	9	-12090	12	16122	9	12324	8	14847	8
	Fr	87	6795	11	2651	11	-17550	70	16725	8	13842	8	14593	7
	Ra	88	5630	9	3797	11	-22390	90	16797	9	10914	12	16840	8
	Ac	89	8485	20	1351	13	*		16396	16	11094	17	15193	15
	Th	90	7845	14	2811	18	*		15478	18	8510	50	16767	14
	Pa	91	9690	110	120	70	*		16450	70	10620	70	16230	90
U	92	*		1850	120	*		15970	110	8190	120	18460	90	
216	Hg	80	4420#	570#	*		18080#	400#	*		*		*	
	Tl	81	3270#	420#	8780#	500#	12460#	300#	14250#	500#	11920#	420#	*	
	Pb	82	4930#	200#	9720#	360#	7230#	200#	11730#	280#	10560#	200#	5460#	360#
	Bi	83	3827	13	5760	50	2903	12	16768	11	13942	13	9737	29
	Po	84	5747.2	2.3	7136	6	-1509	9	13694	11	11878	5	10632	7
	At	85	4559	8	4491	4	-5888	11	17438	4	13774	4	13135	6
	Rn	86	6650	10	5780	9	-10045	13	14344	7	11697	8	12553	7
	Fr	87	5418	8	3149	9	-14830	50	18001	10	13531	5	15197	6
	Ra	88	7314	11	4316	11	-19775	29	14961	12	11708	10	14634	9
	Ac	89	5958	16	1678	13	*		18762	12	12663	15	17344	12
	Th	90	8695	15	3021	17	*		14565	20	9008	19	15599	16
	Pa	91	8140	90	410	50	*		17820	50	10540	50	17290	60
	U	92	9930	90	2090	80	*		14290	80	8270	80	16593	30

Table III. Nuclear-reaction and separation energies (continued, Explanation of Table on p. 030003-98)

A	El.	Z	S(2n)		S(2p)		Q(α)		Q($2\beta^-$)		Q(ϵ_p)		Q(β^-n)	
213	Hg	80	7850#	360#	*	*	*	10870#	300#	*	*	1150#	360#	
	Tl	81	8280	50	*	*	1900#	400#	7015	27	*	*	1261	27
	Pb	82	8853	7	17160#	200#	3020#	150#	3450	8	-13250#	300#	-3157	7
	Bi	83	9515	7	13730	40	5988	3	1348	7	-10970#	200#	-2933	5
	Po	84	10363.6	2.9	10739	4	8536.1	2.6	-958	4	-6394	3	-6097	3
	At	85	11075	5	9298	7	9254	5	-3027	7	-5751	5	-5991	6
	Rn	86	13083	7	7841	3	8245.2	2.9	-6042	10	-2616	3	-10251	9
	Fr	87	15555	13	6484	6	6904.9	1.2	-9708	16	-2214	6	-11425	12
	Ra	88	16629	13	5477	12	6861.7	2.3	-11775	13	1716	10	-15000	50
	Ac	89	17190	60	4283	19	7499	4	-13510	70	2382	18	-14027	18
	Th	90	17930	70	3290	12	7837	7	*	*	5030	15	-17540	80
Pa	91	18560#	130#	2120	90	8390	50	*	*	5100	90	*	*	
214	Hg	80	7720#	500#	*	*	*	11360#	400#	*	*	1320#	400#	
	Tl	81	8130#	280#	*	*	1710#	450#	7670#	200#	*	*	1600#	200#
	Pb	82	8776.6	2.0	17520#	300#	2760#	200#	4287.3	2.3	-15140#	300#	-3022	5
	Bi	83	9225	11	14230#	200#	5621	3	2179	12	-10274	29	-2618	12
	Po	84	10243.2	0.9	11499.1	2.1	7833.54	0.06	-150	9	-8555	7	-5962	5
	At	85	10894	5	9840	4	8987	4	-2421	10	-5437	7	-5755	5
	Rn	86	11803	10	8528	9	9208	9	-4412	11	-4955	10	-8838	10
	Fr	87	13585	12	6908	9	8589	4	-7403	18	-1668	10	-9376	13
	Ra	88	15851	12	5826	6	7272.6	2.6	-10602	12	-1500	6	-14133	16
	Ac	89	16980	50	4618	18	7352.1	2.5	-13040	80	2708	16	-13748	18
	Th	90	17559	15	3684	15	7827	5	*	*	3060	14	-17040	70
Pa	91	18250	110	2370	90	8270	50	*	*	6040	80	*	*	
215	Hg	80	7600#	500#	*	*	*	11870#	400#	*	*	1670#	450#	
	Tl	81	8020#	300#	*	*	*	8280#	300#	*	*	2020#	300#	
	Pb	82	8600	50	17900#	300#	2540#	200#	4880	50	-14130#	400#	-2530	50
	Bi	83	9282	7	14732	28	5280	40	2885	9	-12120#	200#	-1972	6
	Po	84	10031	4	11916	7	7526.3	0.8	627	8	-7647.9	2.5	-5233	5
	At	85	10819	8	10602	8	8178	4	-1574	10	-7344	13	-5007	11
	Rn	86	11615	8	9093	8	8839	8	-3702	11	-3987	8	-8281	11
	Fr	87	12272	9	7680	8	9540	7	-5713	14	-3591	8	-7846	9
	Ra	88	13954	12	6348	8	8864	3	-8388	12	-435	12	-11981	17
	Ac	89	16267	20	4994	13	7746	3	-11830	70	-300	15	-12736	16
	Th	90	17341	13	4002	13	7665	4	-14000	90	3540	10	-16640	80
Pa	91	17940	100	2870	70	8240	50	*	*	4130	70	*	*	
U	92	*	*	1770	90	8590	50	*	*	6940	90	*	*	
216	Hg	80	7460#	570#	*	*	*	12380#	450#	*	*	1880#	500#	
	Tl	81	7890#	360#	*	*	*	8840#	300#	*	*	2300#	300#	
	Pb	82	8480#	200#	18280#	450#	2300#	360#	5700#	200#	-16020#	450#	-2220#	200#
	Bi	83	9068	16	15170#	200#	5000#	200#	3617	12	-11330#	300#	-1656	11
	Po	84	9890.2	2.1	12612.8	2.0	6906.4	0.5	1530	6	-9850	50	-5033	7
	At	85	10506	5	11121	12	7950	3	-714	5	-6662	7	-4646	8
	Rn	86	11570	11	9855	6	8197	6	-3038	10	-6494	6	-8137	9
	Fr	87	12213	9	8227	6	9174	3	-5173	12	-3062	8	-7634	9
	Ra	88	12944	10	6967	13	9526	8	-7007	15	-2829	12	-10811	15
	Ac	89	14442	19	5475	14	9235	6	-9650	50	537	13	-10849	14
	Th	90	16539	16	4372	13	8072	4	-12770	30	476	14	-15640	70
Pa	91	17830	90	3220	60	8097	15	*	*	4480	50	-15200	100	
U	92	*	*	2210	30	8531	26	*	*	4856	29	*	*	

Table III. Nuclear-reaction and separation energies (continued, Explanation of Table on p. 030003-98)

A	Elt.	Z	S(n)		S(p)		Q(4β ⁻)		Q(d,α)		Q(p,α)		Q(n,α)	
217	Tl	81	4480#	500#	8840#	570#	13920#	400#	12820#	570#	12000#	570#	*	
	Pb	82	3310#	360#	9770#	420#	8580#	300#	13040#	420#	10640#	360#	6710#	500#
	Bi	83	5215	21	6040#	200#	4415	19	15100	60	13777	18	7910#	200#
	Po	84	3970	7	7279	13	-6	10	14965	9	11948	13	11713	7
	At	85	5933	6	4677	5	-4309	12	15647	5	13729	5	11242	12
	Rn	86	4666	7	5887	5	-8547	11	15625	8	11902	6	13775	4
	Fr	87	6728	8	3227	9	-12754	17	16194	10	13498	11	13341	8
	Ra	88	5473	11	4370	8	-17080#	70#	16282	10	11712	11	15856	12
	Ac	89	7512	16	1876	14	*		16881	14	13475	13	15309	14
	Th	90	6164	16	3228	15	*		16886	16	10626	19	17759	12
	Pa	91	8800	60	519	20	*		16858	18	11238	19	16271	22
U	92	8160#	80#	2120#	90#	*		15820#	100#	8350#	100#	17930#	70#	
218	Tl	81	3200#	570#	*		15080#	400#	14030#	570#	11840#	570#	*	
	Pb	82	4860#	420#	10150#	500#	10240#	300#	11450#	420#	10410#	420#	4890#	500#
	Bi	83	3590	30	6310#	300#	6157	27	16450#	200#	13740	60	8950#	300#
	Po	84	5598	7	7662	18	1706	11	13194	11	11592	6	9660	50
	At	85	4368	13	5074	13	-2750	50	17027	12	13504	12	12115	13
	Rn	86	6512	4	6466	5	-7149	11	13671	4	11337	7	11405	3
	Fr	87	5327	8	3888	6	-11625	19	17517	7	13092	9	13961	8
	Ra	88	7310	13	4952	13	-15243	18	14391	12	11197	13	13466	13
	Ac	89	5930	50	2340	50	*		18260	50	13170	50	16170	50
	Th	90	7910	15	3626	15	*		14933	15	11200	16	15479	13
	Pa	91	6456	24	811	21	*		19096	22	12626	20	18300	22
U	92	9150#	70#	2463	21	*		14810	60	8890	70	16619	16	
219	Pb	82	3250#	500#	10190#	570#	11450#	400#	12680#	570#	10430#	500#	6070#	570#
	Bi	83	5010#	200#	6460#	360#	7670#	200#	14750#	360#	13670#	280#	7210#	360#
	Po	84	3747	16	7820	30	3287	18	14662	24	11671	19	10850#	200#
	At	85	5773	12	5250	4	-1170	50	15223	7	13478	3	10168	12
	Rn	86	4459	3	6558	12	-5640	50	15146	5	11437	4	12693.4	2.3
	Fr	87	6513	8	3889	7	-9920	50	15670	8	13229	9	12008	8
	Ra	88	5328	14	4954	9	-13890	50	15790	10	11287	9	14788	10
	Ac	89	7350	70	2370	50	-17890	100	16390	50	13140	50	14240	50
	Th	90	5970	50	3660	70	*		16480	50	11190	50	16830	50
	Pa	91	8210	50	1120	50	*		17050	50	13110	50	16040	50
	U	92	6680	50	2690	50	*		16930	50	10350	70	18630	50
Np	93	*		-270	90	*		17190#	110#	11250	90	17300	100	
220	Pb	82	4680#	570#	*		13060#	400#	11200#	570#	10220#	570#	*	
	Bi	83	3540#	360#	6750#	500#	9340#	300#	16080#	420#	13440#	420#	8150#	500#
	Po	84	5489	24	8310#	200#	4993	20	12760	30	11398	25	8670#	300#
	At	85	4092	14	5595	21	632	15	16730	14	13356	15	11292	23
	Rn	86	6288.6	2.3	7073	3	-4057	22	13225	12	11081	5	10375	7
	Fr	87	5207	8	4636	4	-8740#	50#	16976	4	12688	6	12734	6
	Ra	88	7195	12	5636	11	-12660#	100#	13922	9	10820	10	12258	9
	Ac	89	5900	50	2940	10	-16570#	200#	17803	13	12718	9	15075	9
	Th	90	7870	60	4190	60	*		14540	60	10829	25	14426	23
	Pa	91	6390#	70#	1540#	70#	*		18560#	50#	12880#	50#	17160#	50#
	U	92	8430#	110#	2900#	110#	*		14960#	100#	10730#	100#	16370#	100#
Np	93	7220#	220#	270#	200#	*		19130#	200#	12200#	210#	18890#	200#	

Table III. Nuclear-reaction and separation energies (continued, Explanation of Table on p. 030003-98)

A	Elt.	Z	S(2n)	S(2p)	Q(α)	Q($2\beta^-$)	Q(ϵp)	Q($\beta^- n$)						
217	Tl	81	7740#	500#	*	*	9580#	400#	*	2760#	450#			
	Pb	82	8250#	300#	18550#	500#	2150#	420#	6360#	300#	-14910#	500#	-1710#	300#
	Bi	83	9042	19	15760#	300#	4520	30	4335	18	-13280#	300#	-1124	18
	Po	84	9717	7	13040	50	6662.1	2.4	2225	8	-8890#	200#	-4444	7
	At	85	10492	8	11813	7	7201.4	1.2	80	8	-8768	12	-3930	8
	Rn	86	11316	9	10378	5	7887.2	2.9	-2231	8	-5413	4	-7384	6
	Fr	87	12146	9	9008	9	8469	4	-4389	13	-5231	7	-7048	11
	Ra	88	12787	10	7520	10	9161	6	-6316	13	-1652	9	-10326	13
	Ac	89	13470	17	6192	13	9832	10	-8365	20	-1556	12	-9666	17
	Th	90	14858	14	4906	13	9435	4	-10770#	70#	1626	14	-13660	50
	Pa	91	16940	70	3540	20	8489	4	*	*	1635	19	-14070	30
	U	92	18090#	110#	2530#	70#	8430#	70#	*	*	5390#	70#	*	*
218	Tl	81	7680#	500#	*	*	9960#	400#	*	*	2870#	500#		
	Pb	82	8170#	360#	18980#	500#	1850#	500#	7100#	300#	*	-1350#	300#	
	Bi	83	8801	29	16080#	300#	4330#	200#	5118	29	-12390#	400#	-739	28
	Po	84	9568.2	2.0	13700#	200#	6114.75	0.09	3139.6	2.9	-11170#	300#	-4109	5
	At	85	10301	12	12354	16	6874	3	1039	12	-7921	21	-3632	12
	Rn	86	11178	6	11143.0	2.7	7262.5	1.9	-1434	11	-7955	7	-7169	7
	Fr	87	12054	6	9775	6	8014.0	2.0	-3780	50	-4624	7	-6902	8
	Ra	88	12783	14	8180	13	8546	6	-5716	15	-4296	12	-10124	16
	Ac	89	13440	50	6710	50	9380	50	-7840	50	-760	50	-9430	50
	Th	90	14074	16	5502	14	9849	9	-9528	17	-812	13	-12773	19
	Pa	91	15260	60	4039	21	9815	10	*	*	2691	22	-12360#	70#
	U	92	17310	30	2982	18	8775	9	*	*	2400	17	*	*
219	Pb	82	8100#	500#	*	1650#	570#	7600#	400#	*	*	-1010#	400#	
	Bi	83	8590#	200#	16610#	450#	3950#	360#	5890#	200#	-14190#	450#	-150#	200#
	Po	84	9345	17	14140#	300#	5910	50	3852	16	-10060#	300#	-3488	20
	At	85	10141	6	12912	18	6342	5	1778	8	-10109	27	-2893	4
	Rn	86	10972	5	11632	7	6946.2	0.3	-565	8	-6816.5	2.4	-6301	5
	Fr	87	11839	10	10355	8	7448.6	1.8	-2950	50	-6769	14	-6105	13
	Ra	88	12638	11	8842	9	8138	3	-5080	50	-3112	8	-9520	50
	Ac	89	13280	50	7320	50	8830	50	-6970	70	-2780	50	-8870	50
	Th	90	13880	50	6000	50	9510	50	-8820	70	530	50	-12280	50
	Pa	91	14670	50	4740	50	10080	50	-10920	100	410	70	-11430	50
	U	92	15830#	90#	3500	50	9940	50	*	*	3630	50	*	*
	Np	93	*	*	2190	90	9170	50	*	*	3480	90	*	*
220	Pb	82	7930#	500#	*	1390#	570#	8410#	400#	*	*	-690#	450#	
	Bi	83	8540#	300#	16940#	500#	3680#	420#	6440#	300#	*	*	70#	300#
	Po	84	9236	18	14770#	300#	5360#	200#	4651	18	-12300#	400#	-3204	18
	At	85	9865	18	13420	30	6077	18	2893	15	-9200#	200#	-2525	14
	Rn	86	10747.9	2.7	12322.8	2.0	6404.74	0.10	342	8	-9358	16	-6077	7
	Fr	87	11719	6	11194	12	6800.7	1.9	-2261	7	-6203	5	-5983	9
	Ra	88	12524	14	9525	8	7592	6	-4399	24	-5848	8	-9370	50
	Ac	89	13240	50	7893	8	8348	4	-6480#	50#	-2163	9	-8800	50
	Th	90	13840	25	6560	25	8953	20	-8260#	100#	-2014	24	-11940	60
	Pa	91	14610#	50#	5200#	70#	9650#	50#	-10090#	200#	1360#	70#	-11140#	70#
	U	92	15100#	100#	4010#	100#	10210#	100#	*	*	1170#	110#	-14600#	130#
	Np	93	*	*	2950#	200#	10090#	200#	*	*	4480#	200#	*	*

Table III. Nuclear-reaction and separation energies (continued, Explanation of Table on p. 030003-98)

A	Elt.	Z	S(n)	S(p)	$Q(4\beta^-)$	$Q(d,\alpha)$	$Q(p,\alpha)$	$Q(n,\alpha)$						
221	Bi	83	4790#	420#	6860#	500#	10820#	300#	14530#	500#	13510#	420#	6560#	500#
	Po	84	3561	26	8330#	300#	6810	20	14200#	200#	11420	30	9970#	300#
	At	85	5664	20	5770	23	2260	50	14812	21	13290	14	9210	30
	Rn	86	4212	6	7193	15	-2469	10	14786	6	11237	13	11761	6
	Fr	87	6276	6	4624	5	-7100	50	15159	5	12924	5	10826	13
	Ra	88	5378	9	5807	6	-11560	50	15057	8	10769	6	13393	5
	Ac	89	7290	50	3040	50	-15330#	210#	15840	50	12740	50	13110	50
	Th	90	5800	24	4092	10	*	*	16080	50	10960	50	15936	14
	Pa	91	7910#	70#	1580	60	*	*	16620	70	12870	50	15180	70
	U	92	6490#	110#	2990#	70#	*	*	16690	70	10700	50	17800	50
Np	93	8530#	280#	370#	220#	*	*	17270#	210#	12820#	200#	16810#	200#	
222	Bi	83	3440#	420#	*	*	12350#	300#	15770#	500#	13320#	500#	*	*
	Po	84	5360	40	8900#	300#	8170	40	12380#	300#	11070#	200#	7850#	400#
	At	85	3901	21	6110	25	4332	17	16400	24	13136	22	10320#	200#
	Rn	86	6171	6	7699	14	-831	12	12707	14	10840	4	9337	16
	Fr	87	4971	9	5382	9	-5780#	70#	16477	8	12413	8	11628	8
	Ra	88	6715	6	6246	6	-9950	50	13549	6	10566	8	11137	5
	Ac	89	5970	50	3631	7	-14400#	200#	17062	10	12091	10	13650	9
	Th	90	7809	15	4610	50	*	*	14170	14	10500	50	13455	15
	Pa	91	6290#	90#	2080#	70#	*	*	18200#	80#	12550#	90#	16230#	90#
	U	92	8320	70	3390	70	*	*	14770#	70#	10600	70	15450	70
Np	93	6900#	280#	790#	200#	*	*	18800#	220#	12600#	200#	18130#	200#	
223	Bi	83	4660#	500#	*	*	13750#	400#	*	*	13330#	570#	*	*
	Po	84	3480#	200#	8940#	360#	9850#	200#	13690#	360#	11120#	360#	9060#	450#
	At	85	5596	21	6350	40	5602	16	14365	24	13029	23	8260#	300#
	Rn	86	4054	8	7852	18	1004	12	14318	16	10878	16	10773	19
	Fr	87	6067	8	5278.8	2.3	-3940	70	14622	6	12634.4	2.1	9653	14
	Ra	88	5158	5	6434	8	-8600	70	14667	5	10615	4	12267.6	2.3
	Ac	89	6867	9	3783	8	-12770#	200#	15573	8	12420	11	11990	8
	Th	90	5889	15	4525	10	*	*	15570	50	10506	11	14762	12
	Pa	91	7910#	100#	2170	70	*	*	16090	70	12520	70	14220	70
	U	92	6510	90	3610#	100#	*	*	16170	90	10480#	90#	16810	70
Np	93	8490#	280#	960#	200#	*	*	16790#	200#	12530#	220#	16030#	200#	
224	Bi	83	3380#	570#	*	*	15080#	400#	*	*	*	*	*	*
	Po	84	5240#	280#	9520#	450#	11080#	200#	11890#	360#	10680#	360#	*	*
	At	85	3788	26	6660#	200#	7477	23	15940	50	12801	30	9260#	300#
	Rn	86	6016	13	8272	17	2451	14	12203	19	10526	17	8318	22
	Fr	87	4705	11	5930	14	-2114	14	16087	11	12141	13	10612	18
	Ra	88	6478.7	2.3	6845.4	2.1	-6896	23	13159	8	10413	5	10001	6
	Ac	89	5663	8	4288	4	-11640#	200#	16625	6	12134	6	12603	6
	Th	90	7463	14	5121	12	*	*	14083	11	10330	50	12676	11
	Pa	91	6530	70	2813	12	*	*	17370	14	11786	11	14990	50
	U	92	8190	70	3890	70	*	*	14280#	80#	10210	60	14428	25
Np	93	6800#	280#	1250#	210#	*	*	18310#	200#	12220#	200#	17150#	200#	
225	Po	84	3450#	360#	9590#	500#	12540#	300#	13110#	500#	10670#	420#	*	*
	At	85	5390#	300#	6810#	360#	8760#	300#	14030#	360#	12770#	300#	7310#	420#
	Rn	86	3982	15	8466	25	4224	12	13817	18	10445	19	9690	40
	Fr	87	5999	16	5913	15	-520	70	14142	14	12312	12	8514	20
	Ra	88	4904.1	2.8	7044	11	-5387	11	14321.5	2.9	10479	8	11267.3	2.9
	Ac	89	6668	6	4478	5	-9950	70	15115	5	12181	6	10906	9
	Th	90	5755	11	5213	6	*	*	15195	9	10553	7	13636	7
	Pa	91	7590	70	2940	70	*	*	15670	70	12000	70	13370	70
	U	92	6414	26	3771	13	*	*	15770	70	10090#	70#	15823	16
	Np	93	8360#	210#	1420	80	*	*	16460	100	12180	90	15080#	100#

Table III. Nuclear-reaction and separation energies (continued, Explanation of Table on p. 030003-98)

A	Elt.	Z	S(2n)		S(2p)		Q(α)		Q($2\beta^-$)		Q(ϵp)		Q($\beta^- n$)	
221	Bi	83	8330#	360#	*		3360#	500#	7320#	300#	*		760#	300#
	Po	84	9050	25	15080#	400#	5110#	300#	5302	20	-11180#	400#	-2673	24
	At	85	9756	14	14080#	200#	5628	23	3505	15	-11330#	300#	-1901	14
	Rn	86	10501	6	12788	17	6163	3	1508	7	-8081	19	-5082	7
	Fr	87	11483	8	11697	6	6457.7	1.4	-1250	50	-8387	15	-5064	10
	Ra	88	12573	9	10444	5	6880.4	2.0	-3977	9	-4937	5	-8851	7
	Ac	89	13190	70	8670	50	7780	50	-5850	70	-4250	50	-8220	60
	Th	90	13670	50	7032	12	8626	4	-7580	50	-619	11	-11350#	50#
	Pa	91	14310	70	5770	70	9250	50	-9470#	210#	-660	50	-10630#	110#
	Np	93	15750#	220#	3270#	210#	10360#	200#	*		2560	60	-13860#	200#
222	Bi	83	8230#	420#	*		3120#	500#	7780#	300#	*		880#	300#
	Po	84	8920	40	15760#	400#	4610#	300#	6110	40	*		-2370	40
	At	85	9565	21	14440#	300#	5310	30	4575	18	-10430#	300#	-1590	17
	Rn	86	10382.5	1.9	13469	18	5590.4	0.3	2052	5	-10691	20	-4976	5
	Fr	87	11247	8	12576	16	5855	14	-243	9	-7694	16	-4657	9
	Ra	88	12093	9	10870	5	6678	4	-2883	13	-7440	7	-8270	50
	Ac	89	13265	8	9439	6	7137.4	2.0	-5530#	70#	-3945	7	-8390	10
	Th	90	13609	25	7645	15	8127	5	-7070	50	-3050	13	-11240	50
	Pa	91	14210#	90#	6170#	70#	8890#	50#	-8860#	210#	340#	90#	-10440#	90#
	Np	93	15440#	280#	3780#	200#	9910#	200#	*		3350#	200#	*	
223	Bi	83	8100#	500#	*		*		8710#	400#	*		1580#	400#
	Po	84	8840#	200#	*		4380#	450#	6690#	200#	*		-1950#	200#
	At	85	9497	20	15250#	300#	4720#	200#	5046	14	-12590#	300#	-1016	14
	Rn	86	10224	10	13962	21	5283	18	3156	8	-9390	40	-4060	11
	Fr	87	11038	5	12978	14	5561.4	2.8	557	7	-9860	16	-4009	5
	Ra	88	11873	5	11816	6	5978.99	0.21	-2153	9	-6427.9	2.4	-7459	6
	Ac	89	12840	50	10029	8	6783.2	1.0	-4490	70	-5841	10	-7449	14
	Th	90	13697	12	8156	10	7567	4	-6450	70	-2223	10	-10840#	70#
	Pa	91	14200	90	6780	90	8330	50	-8280#	210#	-1590	70	-10020	90
	Np	93	15390#	280#	4360#	200#	9640#	200#	*		1160#	210#	*	
224	Bi	83	8040#	500#	*		*		9120#	400#	*		1680#	450#
	Po	84	8720#	200#	*		3820#	450#	7470#	200#	*		-1590#	200#
	At	85	9385	27	15600#	300#	4470#	300#	5962	25	-11710#	400#	-750	24
	Rn	86	10070	10	14620	40	4757	20	3619	10	-11920#	200#	-4009	10
	Fr	87	10772	13	13782	19	4948	18	1514	12	-8968	18	-3556	11
	Ra	88	11637	5	12124.2	1.9	5788.92	0.15	-1168	10	-8853	8	-7071	7
	Ac	89	12530	6	10722	8	6326.9	0.7	-3628	9	-5437	4	-7223	10
	Th	90	13352	16	8904	11	7299	6	-5729	25	-4529	10	-10400	70
	Pa	91	14440#	70#	7337	9	7694	4	-8010#	200#	-1253	10	-10050	70
	Np	93	15290#	280#	4860#	210#	9230#	200#	*		2270#	210#	*	
225	Po	84	8690#	360#	*		*		8000#	300#	*		-1250#	300#
	At	85	9180#	300#	16320#	500#	3870#	420#	6570#	300#	-13730#	500#	-120#	300#
	Rn	86	9998	14	15120#	200#	4335	23	4541	11	-10670#	200#	-3286	16
	Fr	87	10704	12	14185	18	4613	18	2183	13	-11179	25	-3077	12
	Ra	88	11382.8	3.0	12975	8	5097	5	-317	6	-7741	10	-6312	5
	Ac	89	12331	8	11323	5	5935.1	1.4	-2700	70	-7400	12	-6428	11
	Th	90	13218	10	9501	5	6921.4	2.1	-5070	12	-3805	5	-9623	9
	Pa	91	14120	100	8060	70	7390	50	-7250	100	-3180	70	-9450	70
	U	92	14600	70	6584	14	8015	7	*		97	15	-12570#	200#
	Np	93	15160#	210#	5310	100	8790	50	*		440	70	*	

Table III. Nuclear-reaction and separation energies (continued, Explanation of Table on p.030003-98)

A	Elt.	Z	S(n)	S(p)	Q($4\beta^-$)		Q(d, α)	Q(p, α)	Q(n, α)					
226	Po	84	5050#	500#	*	13880#	400#	11430#	570#	10280#	570#	*		
	At	85	3850#	420#	7210#	420#	10310#	300#	15420#	360#	12400#	360#	8120#	500#
	Rn	86	5858	15	8940#	300#	5550	11	11747	25	10183	17	7320#	200#
	Fr	87	4371	13	6303	13	1487	13	15786	12	11995	10	9739	15
	Ra	88	6396.6	2.9	7442	12	-3661	13	12630	11	10149.5	2.3	8924	8
	Ac	89	5399	6	4973	4	-8470#	90#	16194	3	11940	3	11573	3
	Th	90	7184	7	5729	6	*	*	13674	6	10236	8	11611	5
	Pa	91	6380	70	3566	12	*	*	16750	15	11512	15	13854	13
	U	92	8122	17	4300	70	*	*	14177	15	9870	70	13589	16
Np	93	6880#	110#	1890#	90#	*	*	17770#	90#	11800#	110#	16100#	110#	
227	Po	84	3340#	570#	*	15100#	400#	*		10310#	570#	*		
	At	85	5200#	420#	7350#	500#	11630#	300#	13660#	420#	12440#	360#	6300#	500#
	Rn	86	3933	18	9020#	300#	7081	14	13200#	300#	10039	26	8620#	200#
	Fr	87	5909	9	6354	12	2851	9	13859	13	12101	11	7618	23
	Ra	88	4561.43	0.27	7632	7	-1868	10	14068	12	10293	11	10379	10
	Ac	89	6531	3	5107.2	2.2	-6710	70	14567.3	2.9	11887.7	2.1	9747	11
	Th	90	5464	5	5793	3	-10970#	100#	14878	5	10435	4	12625.3	2.3
	Pa	91	7273	14	3655	9	*	*	15232	9	11702	12	12243	8
	U	92	6355	16	4277	15	*	*	15420	70	10047	12	14698	14
	Np	93	8290#	110#	2060	70	*	*	15890	70	11700	80	14350	70
Pu	94	*		3300#	130#	*	*	15890#	120#	9760#	220#	16690#	100#	
228	At	85	3870#	500#	7890#	570#	12790#	400#	14850#	570#	12020#	500#	*	
	Rn	86	5714	23	9530#	300#	8472	18	11340#	300#	9710#	300#	6360#	300#
	Fr	87	4370	9	6791	16	4461	8	15348	12	11714	13	8640#	300#
	Ra	88	6308.8	2.3	8031	6	-282	14	12131	7	9984	12	8053	11
	Ac	89	5026.2	2.4	5572.0	2.4	-4700	50	15937.7	2.4	11765.7	2.9	10721	12
	Th	90	7105.2	2.3	6367.6	2.1	-9316	29	13173	3	9998	5	10424.3	2.8
	Pa	91	5979	8	4170	5	*	*	16437	6	11478	7	12933	6
	U	92	7895	17	4898	16	*	*	13900	18	9750	70	12559	15
	Np	93	7040	90	2740	50	*	*	16980	50	11080	50	14900	90
Pu	94	8750#	100#	3760	80	*	*	14020#	90#	9360	80	14350	30	
229	At	85	4930#	570#	*	14130#	400#	13250#	570#	12140#	570#	*		
	Rn	86	3952	22	9610#	400#	9777	13	12590#	300#	9610#	300#	7460#	400#
	Fr	87	5787	8	6864	18	5771	6	13493	15	11785	12	6700#	300#
	Ra	88	4450	16	8111	17	1351	17	13590	17	9905	17	9461	19
	Ac	89	6276	12	5539	12	-3090	90	14223	12	11886	12	8816	14
	Th	90	5256.7	2.6	6598.1	2.8	-7810	50	14446.8	2.7	10140	4	11564.2	2.7
	Pa	91	7098	5	4163	3	-12250	90	14803	3	11563	5	11234	4
	U	92	6083	15	5002	7	*	*	15090	9	10041	13	13659	7
	Np	93	7890	100	2730	90	*	*	15450	90	11310	90	13390	90
	Pu	94	6760	60	3490	70	*	*	15540	90	9480#	100#	15710	50
Am	95	*		1230	90	*	*	16090#	130#	*		15020#	120#	
230	Rn	86	5390#	200#	10070#	450#	11190#	200#	11070#	450#	9430#	360#	5410#	450#
	Fr	87	4253	8	7165	15	7313	7	14954	19	11465	16	7650#	300#
	Ra	88	6117	19	8441	11	2901	11	11843	12	9698	12	7277	17
	Ac	89	4923	20	6013	22	-1400	50	15609	16	11525	16	9802	17
	Th	90	6794.3	2.2	7116	12	-6072	15	12678.7	1.9	9877.1	1.7	9331.3	1.5
	Pa	91	5795	4	4701	4	-10760#	130#	16113	3	11233	3	11970	3
	U	92	7667	7	5571	5	*	*	13402	6	9648	9	11457	5
	Np	93	6610	100	3260	50	*	*	16720	50	11050	50	14050	50
	Pu	94	8530	50	4130	90	*	*	14050	50	9240	70	13535	18
Am	95	7290#	160#	1750#	140#	*	*	17560#	140#	11030#	170#	16020#	150#	

Table III. Nuclear-reaction and separation energies (continued, Explanation of Table on p. 030003-98)

A	El.	Z	S(2n)		S(2p)		Q(α)		Q(2 β^-)		Q(ϵ_p)		Q(β^-n)	
226	Po	84	8500#	450#	*	*	8800#	400#	*				-920#	500#
	At	85	9240#	300#	16790#	500#	3460#	420#	7090#	300#	*		10#	300#
	Rn	86	9841	14	15740#	200#	3840	40	5079	11	-13070#	300#	-3145	16
	Fr	87	10371	13	14768	23	4143	17	3211	7	-10160#	300#	-2544	7
	Ra	88	11300.7	1.9	13355	10	4870.70	0.25	470	5	-10155	11	-6041	5
	Ac	89	12068	5	12017	12	5506	8	-1724	12	-6800	12	-6072	6
	Th	90	12939	11	10206	5	6452.5	1.0	-4131	14	-6084	5	-9210	70
	Pa	91	13972	14	8779	12	6987	10	-6740#	90#	-2893	12	-9418	16
	U	92	14536	27	7243	16	7701	4	*		-2270	14	-12330	70
Np	93	15240#	220#	5660#	90#	8200	50	*		1150#	110#	*		
227	Po	84	8390#	500#	*	*	9400#	400#	*				-410#	500#
	At	85	9050#	420#	*	2920#	500#	7800#	300#	*			670#	300#
	Rn	86	9791	18	16220#	300#	3380#	200#	5708	14	-11950#	400#	-2706	15
	Fr	87	10281	13	15290#	300#	3830	15	3833	6	-12220#	300#	-2057	6
	Ra	88	10958.0	2.9	13934	11	4363	8	1372.9	2.4	-8858	11	-5203	3
	Ac	89	11930	5	12549	12	5042.27	0.14	-982	7	-8960	7	-5419	5
	Th	90	12648	5	10766.2	3.0	6146.60	0.10	-3241	10	-5152.0	2.4	-8300	12
	Pa	91	13650	70	9384	9	6580.4	2.1	-5730	70	-4767	8	-8569	15
	U	92	14477	15	7843	11	7235	3	-7720#	100#	-1441	11	-11800#	90#
	Np	93	15170	100	6360	100	7816	14	*		-760	70	*	
Pu	94	*		5190#	100#	8510#	120#	*		2150#	100#	*		
228	At	85	9070#	500#	*	2430#	570#	8300#	400#	*			730#	400#
	Rn	86	9646	21	16880#	400#	2910#	200#	6303	18	-14330#	400#	-2510	19
	Fr	87	10279	9	15810#	300#	3248	23	4489	7	-11390#	300#	-1865	7
	Ra	88	10870.2	2.3	14385	11	4070	10	2169.3	2.6	-11235	14	-4980.6	2.3
	Ac	89	11557	3	13204	7	4721	11	-29	5	-8077	6	-4981.4	2.6
	Th	90	12569	5	11474.8	1.9	5520.15	0.22	-2451	14	-7695.7	1.9	-8132	8
	Pa	91	13252	12	9964	5	6264.5	1.5	-4670	50	-4215	5	-8193	11
	U	92	14249	19	8553	15	6804	10	-6870	30	-3872	14	-11410	70
	Np	93	15320#	100#	7020	50	7310	50	*		-520	50	-11250#	110#
	Pu	94	*		5820	30	7940	18	*		-250	30	*	
229	At	85	8800#	500#	*	*	9160#	400#	*				1510#	400#
	Rn	86	9666	19	17500#	400#	2410#	300#	6800	20	*		-2093	15
	Fr	87	10157	8	16390#	300#	2850#	300#	4978	13	-13310#	400#	-1343	5
	Ra	88	10758	16	14902	21	3603	19	2976	16	-9970	23	-4404	16
	Ac	89	11302	12	13570	13	4444	17	793	13	-9983	14	-4152	12
	Th	90	12361.9	2.8	12170.1	2.7	5167.6	1.0	-1625	6	-6643.7	2.7	-7409	5
	Pa	91	13077	8	10530.6	3.0	5835	4	-3880	90	-6287	4	-7397	15
	U	92	13978	11	9172	6	6476	3	-6190	50	-2849	6	-10460	50
	Np	93	14930	110	7630	90	7010	50	-8370	120	-2430	90	-10380	90
	Pu	94	15520#	110#	6230	50	7590	50	*		880	50	*	
Am	95	*		4990	110	8140	50	*		1270	100	*		
230	Rn	86	9340#	200#	*	2070#	450#	7530#	200#	*			-1690#	200#
	Fr	87	10040	9	16780#	400#	2450#	300#	5648	17	-12630#	400#	-1147	17
	Ra	88	10567	10	15305	20	3344	15	3654	10	-12135	17	-4245	16
	Ac	89	11199	16	14124	17	3893	17	1665	16	-9119	17	-3819	16
	Th	90	12051.0	1.1	12655.6	1.8	4769.9	1.5	-752	5	-8988	15	-7106	3
	Pa	91	12893	5	11299	3	5439.4	0.7	-3060	50	-5805	12	-7108	7
	U	92	13750	15	9734	5	5992.5	0.5	-5319	15	-5260	5	-10240	90
	Np	93	14500	70	8270	50	6780	50	-7700#	140#	-1950	50	-10230	70
	Pu	94	15300	30	6866	21	7181	7	*		-1565	16	-13290	90
	Am	95	*		5240#	140#	7730#	100#	*		1860#	160#	*	

Table III. Nuclear-reaction and separation energies (continued, Explanation of Table on p.030003-98)

A	Elt.	Z	S(n)	S(p)	Q(4β ⁻)		Q(d,α)	Q(p,α)	Q(n,α)					
231	Rn	86	3670#	360#	*	12640#	300#	12340#	500#	9630#	500#	*		
	Fr	87	5478	10	7260#	200#	8656	8	13429	15	11701	19	6040#	400#
	Ra	88	4371	15	8559	13	4410	12	13259	12	9696	13	8619	21
	Ac	89	6147	21	6042	17	140	50	13912	20	11687	13	8025	15
	Th	90	5118.02	0.20	7311	16	-4493	23	13837	12	9785.2	1.9	10522.0	1.8
	Pa	91	6821	3	4727.2	1.5	-8990#	300#	14549.6	2.6	11517.5	1.9	10176.1	2.3
	U	92	5880	5	5657	4	-13460#	300#	14620	3	9746	5	12681.4	2.8
	Np	93	7680	70	3280	50	*		15120	50	11270	50	12350	50
	Pu	94	6697	27	4220	60	*		15240	90	9580	60	14733	27
	Am	95	8590#	330#	1810#	300#	*		15730#	300#	11190#	300#	14460#	300#
Cm	96	*		2950#	330#	*		15830#	310#	*		16830#	300#	
232	Fr	87	4079	16	7670#	300#	10126	16	14740#	200#	11574	19	6900#	400#
	Ra	88	5791	15	8873	12	5887	9	11721	11	9693	10	6781	16
	Ac	89	4680	18	6351	17	1800#	100#	15349	17	11457	20	9133	14
	Th	90	6440.4	1.1	7605	13	-2916	18	12319	16	9621	12	8531	16
	Pa	91	5549	8	5158	8	-7390#	300#	15795	8	11225	8	10903	14
	U	92	7267.8	2.8	6103.8	2.0	-11700#	200#	13147	3	9577	3	10670.3	2.6
	Np	93	6340#	110#	3740#	100#	*		16460#	100#	11010#	100#	13110#	100#
	Pu	94	8017	29	4550	50	*		13840	50	9450	90	12799	19
	Am	95	7140#	420#	2260#	300#	*		17120#	300#	10810#	300#	15210#	310#
	Cm	96	9030#	360#	3390#	360#	*		14090#	240#	9030#	220#	14560#	210#
233	Fr	87	5224	24	*		11431	20	13180#	300#	11740#	200#	*	
	Ra	88	4234	13	9028	16	7415	9	12964	12	9711	11	7930#	200#
	Ac	89	5918	18	6478	16	3360	50	13802	17	11656	17	7468	15
	Th	90	4786.39	0.09	7712	13	-1320	50	13680	13	9757	16	9862	10
	Pa	91	6528	8	5246.3	1.1	-5770#	100#	14384.4	1.0	11490.9	1.0	9297	16
	U	92	5761.7	2.5	6316	8	-10370	70	14205.6	2.4	9610	3	11703.0	2.1
	Np	93	7480#	110#	3950	50	-14910#	230#	14850	50	11200	50	11420	50
	Pu	94	6380	50	4600#	110#	*		15140	70	9680	70	14080	50
	Am	95	8150#	320#	2390#	100#	*		15670#	100#	11190#	100#	13670#	110#
	Cm	96	7090#	210#	3340#	310#	*		15600#	310#	9230#	150#	16010	70
Bk	97	*		740#	300#	*		16300#	370#	*		15580#	260#	
234	Ra	88	5475	12	9278	21	8786	8	11569	16	9714	11	6120#	300#
	Ac	89	4538	19	6782	16	4886	16	15055	17	11489	18	8407	16
	Th	90	6190.0	2.6	7984	13	263	7	12169	13	9714	13	8043	12
	Pa	91	5222	4	5682	4	-4120#	160#	15603	4	11387	4	10222	14
	U	92	6845.5	2.0	6633.4	0.8	-8580	17	12909	8	9584.7	1.5	9975.5	0.7
	Np	93	6070	50	4253	9	-13500#	140#	16056	8	11013	9	12177	8
	Pu	94	7770	50	4890	50	*		13700#	100#	9590	50	12190	7
	Am	95	6870#	190#	2880#	170#	*		16810#	160#	11020#	160#	14480#	170#
	Cm	96	8640	70	3830#	100#	*		14100#	300#	9180#	300#	14062	28
Bk	97	7480#	270#	1130#	160#	*		17850#	250#	11050#	330#	16690#	330#	
235	Ra	88	3870#	300#	*		10210#	300#	12920#	300#	9920#	300#	*	
	Ac	89	5555	20	6862	16	6314	14	13734	16	11724	17	6931	20
	Th	90	4667	13	8112	19	1835	24	13421	18	9727	18	9167	16
	Pa	91	6121	15	5613	14	-2340	50	14268	14	11706	14	8781	19
	U	92	5297.50	0.23	6709	4	-7120#	200#	14140.2	0.8	9836	8	11118.5	0.9
	Np	93	6983	8	4390.9	0.9	-11660#	400#	14834.7	2.2	11297.6	1.8	10743	8
	Pu	94	6239	22	5061	22	*		14940	50	9690#	100#	13219	21
	Am	95	7910#	170#	3010	50	*		15280	70	11130	60	12910#	110#
	Cm	96	6760#	200#	3720#	260#	*		15480#	230#	9560#	360#	15320#	200#
Bk	97	8820#	430#	1310#	400#	*		16120#	410#	11260#	450#	15010#	500#	

Table III. Nuclear-reaction and separation energies (continued, Explanation of Table on p. 030003-98)

A	El.	Z	S(2n)		S(2p)		Q(α)		Q(2 β^-)		Q(ϵ_p)		Q(β^-n)		
231	Rn	86	9050#	300#	*		1750#	500#	8240#	300#	*		-1100#	300#	
	Fr	87	9730	9	17320#	400#	2170#	300#	6318	15	*		-507	13	
	Ra	88	10488	19	15724	17	2906	18	4401	11	-11120#	200#	-3693	19	
	Ac	89	11070	18	14483	14	3655	14	2338	13	-11013	15	-3171	13	
	Th	90	11912.3	2.2	13324	15	4213.3	1.6		9.9	2.5	-7989	10	-6429.0	2.8
	Pa	91	12615.1	2.8	11843	12	5149.9	0.8	-2200	50	-7703	16	-6262	5	
	U	92	13547	6	10358	3	5576.3	1.7	-4503	23	-4345.5	2.5	-9500	50	
	Np	93	14300	100	8850	50	6370	50	-6790#	300#	-3840	50	-9380	50	
	Pu	94	15230	60	7479	23	6839	20	-8960#	300#	-595	23	-12690#	140#	
	Am	95	15880#	310#	5950#	310#	7420#	310#	*		-120#	300#	*		
Cm	96	*		4700#	300#	8080#	320#	*		3050#	300#	*			
232	Fr	87	9557	15	*		1960#	400#	6918	19	*		-215	18	
	Ra	88	10162	14	16130#	200#	2829	20	5050	9	-13250#	300#	-3337	16	
	Ac	89	10827	21	14910	15	3345	15	3208	15	-10215	15	-2733	13	
	Th	90	11558.4	1.1	13647	10	4081.6	1.4		837.3	2.2	-10059	11	-6048.9	1.7
	Pa	91	12370	8	12470	18	4627	8	-1410#	100#	-7105	15	-5931	8	
	U	92	13148	5	10831.0	1.1	5413.63	0.09	-3754	18	-6495.3	1.2	-9090	50	
	Np	93	14020#	110#	9390#	100#	6010#	100#	-5980#	320#	-3350#	100#	-9020#	100#	
	Pu	94	14714	23	7830	18	6716	10	-7950#	200#	-2732	18	-12120#	300#	
	Am	95	15740#	330#	6480#	300#	7320#	300#	*		430#	300#	-12000#	420#	
	Cm	96	*		5200#	200#	7800#	200#	*		710#	200#	*		
233	Fr	87	9303	21	*		1670#	400#	7612	24	*		352	22	
	Ra	88	10025	14	16700#	300#	2547	16	5602	9	*		-2892	16	
	Ac	89	10597	18	15350	15	3215	14	3819	13	-12054	19	-2210	13	
	Th	90	11226.8	1.1	14063	11	3745	16	1812.5	2.2	-9054	9	-5286	8	
	Pa	91	12077.6	1.7	12851	13	4375	12	-460	50	-8954	13	-5191.4	1.8	
	U	92	13029	3	11474.7	2.1	4908.7	1.2	-3130	50	-5816.6	2.2	-8510#	100#	
	Np	93	13820	70	10050	50	5630	50	-5320#	110#	-5290	50	-8490	50	
	Pu	94	14400	60	8330	50	6420	50	-7240	90	-1850	50	-11360#	300#	
	Am	95	15290#	320#	6940#	110#	7060#	50#	-9600#	250#	-1390#	140#	-11120#	230#	
	Cm	96	16120#	310#	5590	70	7470	50	*		1640	70	*		
Bk	97	*		4130#	370#	8290#	210#	*		2230#	370#	*			
234	Ra	88	9709	12	*		2460#	200#	6318	9	*		-2449	16	
	Ac	89	10456	19	15810	20	2930	15	4502	15	-11368	24	-1962	14	
	Th	90	10976.4	2.6	14462	10	3672	11	2468.0	2.4	-11010	9	-4947.8	2.5	
	Pa	91	11750	9	13393	14	4076	16	384	9	-8258	14	-4652	4	
	U	92	12607.1	1.6	11879.7	0.9	4857.5	0.7	-2205	7	-7875.7	0.9	-7870	50	
	Np	93	13550#	100#	10570	11	5356	9	-4510#	160#	-4824	8	-8170	50	
	Pu	94	14156	19	8837	7	6310	5	-6375	19	-3858	7	-10990#	100#	
	Am	95	15020#	340#	7480#	190#	6800#	150#	-8990#	210#	-780#	170#	-10900#	170#	
	Cm	96	15730#	200#	6216	25	7365	9	*		-620	50	-14210#	230#	
	Bk	97	*		4460#	330#	8100	50	*		2900#	180#	*		
235	Ra	88	9350#	300#	*		2250#	420#	7110#	300#	*		-1780#	300#	
	Ac	89	10094	19	16141	24	2852	16	5068	20	*		-1327	14	
	Th	90	10857	13	14894	16	3376	17	3099	13	-10202	16	-4392	14	
	Pa	91	11343	14	13597	19	4101	19	1246	14	-9841	20	-3927	14	
	U	92	12143.0	2.0	12390.8	0.9	4678.0	0.7	-1264	20	-6983.1	2.4	-7107	8	
	Np	93	13050	50	11024.3	1.2	5193.8	1.5	-3580	50	-6585	4	-7378	7	
	Pu	94	14010	50	9315	21	5951	20	-5850#	200#	-3252	20	-10350#	160#	
	Am	95	14780#	110#	7900	70	6576	13	-8080#	400#	-2620	50	-10170	50	
	Cm	96	15400#	210#	6600#	210#	7300#	200#	*		400#	200#	-13490#	250#	
	Bk	97	16300#	460#	5140#	410#	7870#	500#	*		950#	430#	*		

Table III. Nuclear-reaction and separation energies (continued, Explanation of Table on p. 030003-98)

A	Elt.	Z	S(n)	S(p)	$Q(4\beta^-)$		$Q(d,\alpha)$		$Q(p,\alpha)$		$Q(n,\alpha)$			
236	Ac	89	4210	40	7200#	300#	7840	60	15000	40	11750	40	7950	40
	Th	90	5834	19	8391	20	3354	14	12125	20	9811	19	7568	16
	Pa	91	5026	20	5973	19	-710#	110#	15432	14	11466	14	9672	19
	U	92	6545.52	0.26	7133	14	-5410	18	12817	4	9819.2	0.8	9359.3	0.9
	Np	93	5740	50	4830	50	-10160#	400#	15940	50	11320	50	11540	50
	Pu	94	7352	21	5430.5	1.8	*	*	13658	8	9820	50	11628.8	2.5
	Am	95	6660#	120#	3430#	110#	*	*	16400#	110#	10850#	120#	13740#	120#
	Cm	96	8250#	200#	4060	60	*	*	14110#	160#	9460#	100#	13450	50
Bk	97	7230#	570#	1780#	450#	*	*	17530#	400#	11110#	410#	15930#	410#	
237	Ac	89	5270#	400#	*	*	9150#	400#	13600#	500#	11950#	400#	*	*
	Th	90	4371	21	8550	40	4863	16	13309	21	9978	21	8671	18
	Pa	91	5878	19	6017	19	960#	60#	14221	18	11779	13	8333	19
	U	92	5125.8	0.5	7233	14	-3860	70	13812	14	9915	4	10423.6	2.5
	Np	93	6580	50	4861.95	0.25	-8320#	220#	14663.6	0.3	11590.7	0.4	10179	4
	Pu	94	5881.2	2.1	5580	50	-12850	90	14759.4	1.6	10001	8	12593.1	1.3
	Am	95	7540#	130#	3620#	60#	*	*	15100#	60#	11080#	60#	12260#	60#
	Cm	96	6680	70	4080#	130#	*	*	15330	90	9650#	170#	14540	70
	Bk	97	8430#	460#	1960#	230#	*	*	15870#	300#	11330#	230#	14370#	280#
	Cf	98	*	*	2890#	410#	*	*	15950#	410#	9350#	170#	16860	90
238	Th	90	5500#	280#	8780#	490#	6360#	280#	12020#	290#	10030#	280#	7040#	410#
	Pa	91	4705	21	6350	22	2470	50	15350	21	11740	21	9183	21
	U	92	6153.7	1.3	7509	13	-2137	12	12685	14	9883	14	8936	13
	Np	93	5488.32	0.20	5224.5	0.6	-6760#	260#	15720.8	0.3	11399.9	0.4	10812	14
	Pu	94	6999.8	1.3	5997.4	0.4	-11110#	300#	13500	50	9984.2	0.9	10890.77	0.28
	Am	95	6220#	80#	3960	50	*	*	16230	50	11100	50	13020	50
	Cm	96	7870	70	4410#	60#	*	*	14120#	110#	9680	50	12909	24
	Bk	97	7040#	340#	2320#	270#	*	*	17070#	260#	11050#	330#	15240#	260#
Cf	98	8730#	310#	3200#	370#	*	*	14450#	500#	9440#	500#	14890#	360#	
239	Th	90	4150#	490#	*	*	7860#	400#	13140#	570#	10090#	400#	*	*
	Pa	91	5630#	200#	6480#	340#	3950#	200#	14090#	200#	11950#	200#	7760#	200#
	U	92	4806.38	0.17	7610	16	-570	50	13756	13	10103	14	9964	14
	Np	93	6214.9	1.0	5285.7	1.5	-4940#	210#	14631.7	1.1	11730.5	1.0	9624	14
	Pu	94	5646.2	0.3	6155.3	0.4	-9680#	210#	14427.4	0.3	10070	50	11790.04	0.25
	Am	95	7100	50	4061.8	1.7	-14170#	300#	15009.5	2.1	11352.9	2.3	11660	50
	Cm	96	6370	60	4560	70	*	*	15290#	80#	9970#	120#	13890	50
	Bk	97	8040#	330#	2480#	210#	*	*	15710#	220#	11260#	210#	13860#	240#
	Cf	98	7080#	360#	3240#	330#	*	*	15790#	310#	9590#	450#	16060#	210#
	Es	99	*	*	1010#	420#	*	*	16330#	310#	*	*	15660#	500#
240	Pa	91	4500#	280#	6830#	450#	5400#	200#	15100#	350#	11820#	200#	8540#	450#
	U	92	5928.5	2.9	7910#	200#	991	3	12532	16	10052	13	8407	16
	Np	93	5066	17	5545	17	-3350#	150#	15719	17	11790	17	10435	21
	Pu	94	6534.22	0.23	6474.6	1.0	-7866	19	13381.53	0.29	10117.78	0.21	10381.6	0.5
	Am	95	5952	14	4367	14	-12690#	400#	16058	14	11283	14	12285	14
	Cm	96	7490	50	4955.1	2.3	*	*	14010	50	10020#	60#	12279.0	2.2
	Bk	97	6660#	260#	2770#	160#	*	*	16930#	150#	11280#	170#	14740#	160#
	Cf	98	8350#	210#	3550#	210#	*	*	14490#	260#	9670#	230#	14390	70
Es	99	7430#	500#	1360#	450#	*	*	17630#	500#	11120#	410#	16660#	460#	
241	Pa	91	5340#	360#	*	*	6710#	300#	13900#	500#	11980#	410#	*	*
	U	92	4590#	200#	8000#	280#	2500#	200#	13570#	280#	10170#	200#	9320#	340#
	Np	93	6130	70	5740	70	-1770#	210#	14400	70	11820	70	9010	70
	Pu	94	5241.52	0.03	6650	17	-6370#	170#	14354.9	1.0	10364.57	0.29	11293.8	1.2
	Am	95	6647	14	4479.96	0.17	-10930#	230#	15056.92	0.29	11635.2	0.4	11126.14	0.23
	Cm	96	6093.8	2.1	5097	14	-15420#	300#	15022.2	2.0	10140	50	13185.0	1.2
	Bk	97	7700#	250#	2980#	200#	*	*	15600#	210#	11450#	200#	13260#	210#
	Cf	98	6740#	170#	3630#	220#	*	*	15790#	270#	9980#	300#	15530#	170#
	Es	99	8410#	460#	1420#	230#	*	*	16310#	310#	11450#	370#	15290#	340#
	Fm	100	*	*	2360#	500#	*	*	16280#	420#	*	*	17500#	420#

Table III. Nuclear-reaction and separation energies (continued, Explanation of Table on p. 030003-98)

A	Elt.	Z	S(2n)	S(2p)	$Q(\alpha)$	$Q(2\beta^-)$	$Q(\epsilon p)$	$Q(\beta^- n)$						
236	Ac	89	9760	40	*	2720	40	5890	40	*	-870	40		
	Th	90	10500	14	15253	16	3333	17	3811	14	-12160#	300#	-4105	20
	Pa	91	11148	15	14085	20	3755	19	1960	50	-9312	20	-3656	14
	U	92	11843.0	0.3	12746.3	2.4	4572.9	0.9	-456.9	1.6	-8862	13	-6669.8	0.9
	Np	93	12720	50	11540	50	5010	50	-2660#	120#	-6200	50	-6880	50
	Pu	94	13591	7	9821.4	1.6	5867.15	0.08	-4953	18	-5306.2	1.6	-9800	50
	Am	95	14560#	190#	8490#	110#	6260	50	-7500#	420#	-2290#	110#	-10070#	230#
	Cm	96	15012	25	7073	19	7067	5	*	*	-1616	27	-12920#	400#
Bk	97	16060#	430#	5500#	430#	7780#	500#	*	*	1630#	400#	*	*	
237	Ac	89	9480#	400#	*	2680#	400#	6490#	400#	*	*	-310#	400#	
	Th	90	10205	21	15750#	300#	3196	18	4565	16	*	*	-3450	21
	Pa	91	10904	19	14407	19	3795	18	2656	13	-10980	40	-2988	13
	U	92	11671.3	0.5	13205	13	4233.6	1.0	298.5	1.4	-8154	14	-6060	50
	Np	93	12314.1	0.9	11995	14	4957.3	0.7	-1700#	60#	-7751	14	-6101.3	1.6
	Pu	94	13233	21	10405.1	1.3	5747.6	2.3	-4160	70	-4641.9	1.3	-9020#	110#
	Am	95	14200#	80#	9050#	60#	6200#	30#	-6620#	230#	-4100#	80#	-9360#	60#
	Cm	96	14930#	210#	7510	70	6770	50	-8690	110	-940	70	-12370#	410#
	Bk	97	15660#	460#	6020#	230#	7500#	200#	*	*	-140#	250#	*	*
Cf	98	*	*	4670#	220#	8220	50	*	*	2790	90	*	*	
238	Th	90	9870#	280#	*	3170#	280#	5220#	280#	*	*	-3070#	280#	
	Pa	91	10583	21	14900	40	3628	21	3439	16	-10420#	400#	-2567	16
	U	92	11279.5	1.2	13525	14	4269.9	2.1	1144.6	1.2	-9936	16	-5635.2	1.2
	Np	93	12070	50	12457	14	4691	4	-970	50	-7362	13	-5708.4	1.3
	Pu	94	12881.0	1.6	10859.4	0.4	5593.27	0.19	-3282	12	-6516.0	0.6	-8480#	60#
	Am	95	13760#	120#	9530	70	6040	50	-5800#	260#	-3740	50	-8900	90
	Cm	96	14552	22	8034	12	6670	10	-7830#	300#	-2936	12	-11810#	230#
	Bk	97	15470#	480#	6400#	280#	7330#	200#	*	*	360#	260#	-11790#	270#
Cf	98	*	*	5160#	300#	8130#	300#	*	*	740#	310#	*	*	
239	Th	90	9650#	400#	*	2900#	500#	5880#	400#	*	*	-2520#	400#	
	Pa	91	10330#	200#	15260#	450#	3560#	200#	4030#	200#	*	*	-2040#	200#
	U	92	10960.1	1.3	13960	16	4130	13	1984.4	1.2	-9240#	280#	-4953.3	1.2
	Np	93	11703.2	1.0	12795	13	4597	14	-79.4	1.9	-8872	16	-4923.5	1.0
	Pu	94	12646.1	1.3	11379.9	0.5	5244.52	0.21	-2560	50	-6008.5	1.2	-7900	50
	Am	95	13320#	60#	10059.2	1.7	5922.4	1.4	-4860#	210#	-5353.2	1.7	-8126	12
	Cm	96	14240	90	8520	50	6540	50	-7120#	220#	-2310	50	-11140#	260#
	Bk	97	15080#	310#	6900#	220#	7200#	200#	-9310#	360#	-1460#	210#	-11100#	360#
	Cf	98	15810#	230#	5560#	220#	7810#	60#	*	*	1540#	210#	*	*
Es	99	*	*	4210#	370#	8430#	500#	*	*	2050#	390#	*	*	
240	Pa	91	10130#	200#	*	3260#	200#	4590#	200#	*	*	-1730#	200#	
	U	92	10734.9	2.9	14390#	280#	4035	14	2590.1	2.7	-11020#	400#	-4666.9	2.8
	Np	93	11281	17	13156	23	4557	22	806	22	-8310#	200#	-4343	17
	Pu	94	12180.5	0.4	11760.3	1.2	5255.82	0.14	-1598.9	1.7	-7736.3	1.2	-7336.4	1.7
	Am	95	13050	50	10522	14	5710	50	-4150#	150#	-5090	14	-7710	60
	Cm	96	13864	12	9016.8	1.7	6397.8	0.6	-6267	19	-4152.9	1.7	-10600#	210#
	Bk	97	14690#	300#	7340#	160#	7200#	190#	-8530#	430#	-1020#	150#	-10680#	260#
	Cf	98	15430#	300#	6032	22	7711	4	*	*	-450	60	-13640#	300#
Es	99	*	*	4600#	480#	8230#	570#	*	*	2660#	450#	*	*	
241	Pa	91	9840#	360#	*	3200#	500#	5380#	310#	*	*	-1150#	300#	
	U	92	10520#	200#	14830#	450#	3820#	200#	3240#	200#	*	*	-4190#	200#
	Np	93	11190	70	13660#	210#	4310	70	1330	70	-9940#	210#	-3940	70
	Pu	94	11775.74	0.23	12195.5	1.2	5140.1	0.5	-746.7	1.2	-7049.3	2.7	-6626	14
	Am	95	12598.7	1.7	10954.6	1.0	5637.82	0.12	-3100#	200#	-6671	17	-6861.2	1.7
	Cm	96	13590	50	9464.4	1.2	6185.2	0.6	-5630#	170#	-3712.5	1.2	-10030#	150#
	Bk	97	14360#	290#	7940#	200#	7040#	210#	-7830#	300#	-2770#	200#	-10030#	200#
	Cf	98	15090#	270#	6400#	180#	7660#	150#	-9800#	340#	310#	170#	-12940#	430#
	Es	99	15840#	370#	4970#	310#	8250	20	*	*	910#	270#	*	*
Fm	100	*	*	3720#	360#	8760#	310#	*	*	3850#	300#	*	*	

Table III. Nuclear-reaction and separation energies (continued, Explanation of Table on p. 030003-98)

A	Elt.	Z	S(n)	S(p)	$Q(4\beta^-)$		$Q(d,\alpha)$		$Q(p,\alpha)$		$Q(n,\alpha)$				
242	U	92	5650#	280#	8310#	360#	3820#	200#	12420#	280#	10150#	280#	7820#	450#	
	Np	93	4910	210	6070#	280#	-320#	280#	15410	200	11710	200	9730#	280#	
	Pu	94	6309.6	0.7	6830	70	-4670	13	13111	17	10269.9	1.2	9790.6	1.0	
	Am	95	5537.64	0.10	4776.07	0.19	-9330#	260#	16053.50	0.20	11743.8	0.3	11803.4	1.0	
	Cm	96	6969.4	1.2	5419.6	0.4	-13600#	400#	14004	14	10277.4	1.7	11861.9	0.3	
	Bk	97	6370#	280#	3260#	200#	*	*	16720#	200#	11450#	210#	13990#	200#	
	Cf	98	8010#	170#	3930#	200#	*	*	14430#	150#	10000#	210#	13890	60	
	Es	99	7130#	340#	1810#	310#	*	*	17520#	260#	11400#	330#	16200#	330#	
	Fm	100	8800#	500#	2750#	460#	*	*	14910#	570#	9710#	500#	15780#	450#	
	243	U	92	4330#	360#	*	*	5180#	300#	13430#	420#	10310#	360#	*	*
Np		93	5610#	200#	6030#	200#	1190#	30#	14390#	200#	12020#	30#	8610#	200#	
Pu		94	5033.6	2.4	6950	200	-3240#	110#	14210	70	10302	17	10685	3	
Am		95	6364.3	1.2	4830.9	1.4	-7570#	210#	14930.7	1.2	11913.7	1.2	10505	17	
Cm		96	5693.1	1.0	5575.0	1.0	-12210#	220#	14958.4	1.0	10536	14	12703.0	1.0	
Bk		97	7120#	200#	3403	4	*	*	15699	5	11829	5	12826	14	
Cf		98	6470#	120#	4030#	230#	*	*	15670#	230#	10190#	190#	14910#	110#	
Es		99	8130#	330#	1930#	210#	*	*	16130#	270#	11620#	210#	14730#	260#	
Fm		100	7080#	460#	2700#	330#	*	*	16240#	310#	10050#	460#	17040#	220#	
244		Np	93	4750#	300#	6450#	420#	2490#	300#	15290#	360#	11870#	360#	9210#	420#
	Pu	94	6019.9	2.9	7360#	30#	-1672	3	13100	200	10410	70	9260#	200#	
	Am	95	5367.2	1.6	5164.4	2.6	-6150#	180#	15873.1	1.2	11788.1	1.0	11270	70	
	Cm	96	6801.4	1.0	6012.1	1.2	-10510#	200#	13694.63	0.20	10381.56	0.17	11143.12	0.04	
	Bk	97	6047	15	3757	14	*	*	16621	14	11876	14	13426	14	
	Cf	98	7580#	110#	4500	5	*	*	14460#	200#	10310#	200#	13422.8	2.8	
	Es	99	6790#	280#	2250#	210#	*	*	17350#	180#	11560#	250#	15640#	270#	
	Fm	100	8490#	290#	3070#	290#	*	*	14880#	330#	9970#	300#	15290#	260#	
	245	Np	93	5380#	420#	*	*	4080#	300#	14240#	420#	12130#	360#	*	*
		Pu	94	4699	13	7310#	300#	-207	14	14010#	30#	10630	200	10210#	200#
Am		95	6050.0	1.9	5194.5	2.9	-4470#	200#	14856.7	2.9	12047.6	1.8	10130	200	
Cm		96	5518.6	0.5	6163.6	1.1	-9180#	200#	14540.3	1.3	10400.6	0.5	11934.0	0.8	
Bk		97	6971	14	3927.0	1.4	-13460#	310#	15342.6	1.7	11874.1	1.5	11992.2	1.4	
Cf		98	6164	3	4618	15	*	*	15406	5	10520#	200#	14227.8	2.2	
Es		99	7730#	270#	2400#	200#	*	*	16090#	230#	11840#	200#	14280#	280#	
Fm		100	6850#	280#	3130#	270#	*	*	16150#	280#	10250#	320#	16450#	200#	
Md		101	*	*	980#	370#	*	*	16600#	370#	11740#	500#	16120#	400#	
246		Pu	94	5855	20	7780#	300#	1305	15	12900#	300#	10380#	40#	8680#	300#
	Am	95	4978#	18#	5473#	22#	-2910#	220#	15899#	18#	12103#	18#	10770#	40#	
	Cm	96	6458.9	1.2	6572.5	2.0	-7572	15	13448.6	1.5	10306.0	1.6	10508.8	2.5	
	Bk	97	5920	60	4330	60	-12150#	270#	16230	60	11650	60	12440	60	
	Cf	98	7366.2	2.4	5012.5	1.8	*	*	14087	14	10265	5	12554.7	1.4	
	Es	99	6540#	300#	2770#	220#	*	*	17130#	220#	11780#	250#	14860#	220#	
	Fm	100	8070#	200#	3470#	200#	*	*	14870#	180#	10310#	210#	14850#	120#	
	Md	101	7230#	400#	1360#	320#	*	*	17860#	330#	11590#	340#	17010#	330#	
	247	Pu	94	4360#	200#	*	*	3000#	200#	13930#	360#	10770#	360#	*	*
		Am	95	5910#	100#	5530#	100#	-1430#	100#	14690#	100#	12210#	100#	9600#	310#
Cm		96	5155	4	6750#	18#	-6140#	120#	14343	4	10518	4	11374	4	
Bk		97	6550	60	4416	5	-10450#	210#	15196	5	11902	5	11257	5	
Cf		98	6058	15	5150	60	*	*	15001	15	10254	21	13298	15	
Es		99	7390#	220#	2801	19	*	*	15904	20	11964	20	13511	24	
Fm		100	6590#	120#	3520#	250#	*	*	16020#	230#	10510#	220#	15840#	120#	
Md		101	8250#	330#	1540#	210#	*	*	16460#	280#	11840#	290#	15560#	280#	

Table III. Nuclear-reaction and separation energies (continued, Explanation of Table on p. 030003-98)

A	El.	Z	S(2n)		S(2p)		Q(α)		Q($2\beta^-$)		Q(ϵp)		Q($\beta^- n$)	
242	U	92	10240#	200#	*		3670#	200#	3900#	200#	*		-3710#	210#
	Np	93	11040	200	14070#	280#	4100	200	1950	200	-9510#	360#	-3610	200
	Pu	94	11551.1	0.7	12576.5	2.7	4984.2	1.0	-86.8	0.8	-8770#	200#	-6288.8	0.7
	Am	95	12185	14	11426	17	5588.50	0.25	-2270#	200#	-6080	70	-6305.1	1.2
	Cm	96	13063.2	1.7	9899.6	0.4	6215.63	0.08	-4583	13	-5440.4	0.4	-9300#	200#
	Bk	97	14070#	250#	8350#	200#	6890#	210#	-7070#	330#	-2490#	200#	-9660#	260#
	Cf	98	14747	23	6915	13	7517	4	-9010#	400#	-1604	13	-12550#	230#
	Es	99	15540#	480#	5440#	300#	8160	20	*		1480#	330#	-12400#	390#
	Fm	100	*		4170#	400#	8700#	500#	*		1780#	430#	*	
243	U	92	9980#	360#	*		3480#	500#	4610#	300#	*		-3130#	360#
	Np	93	10530#	80#	14340#	300#	4110#	200#	2700#	30#	*		-2910#	30#
	Pu	94	11343.2	2.4	13020#	200#	4757.0	2.6	572.6	2.6	-8150#	200#	-5784.8	2.4
	Am	95	11902.0	1.2	11660	70	5439.1	0.9	-1515	5	-7530	200	-5700.0	1.2
	Cm	96	12662.5	1.6	10351.1	1.0	6168.8	1.0	-3810#	110#	-4823.9	1.2	-8620#	200#
	Bk	97	13490#	200#	8823	4	6874	4	-6060#	210#	-4067	4	-8769	14
	Cf	98	14480#	200#	7290#	110#	7420#	100#	-8400#	240#	-1100#	110#	-11880#	280#
	Es	99	15260#	310#	5860#	290#	8072	10	*		-280#	290#	-11720#	450#
	Fm	100	15880#	370#	4520#	270#	8690	50	*		2710#	220#	*	
244	Np	93	10360#	360#	*		3870#	360#	3320#	300#	*		-2620#	300#
	Pu	94	11053.5	2.5	13390#	200#	4665.6	1.0	1354.1	2.5	-9840#	300#	-5440.3	2.6
	Am	95	11731.5	1.0	12120	200	5138	17	-835	14	-7290#	30#	-5374.1	1.4
	Cm	96	12494.5	0.4	10843.0	0.7	5901.60	0.03	-3026.3	2.5	-6591.7	2.4	-8309	4
	Bk	97	13160#	200#	9332	14	6779	4	-5310#	180#	-3750	14	-8350#	120#
	Cf	98	14051	13	7903.5	2.5	7329.0	1.8	-7490#	200#	-2992.8	2.7	-11340#	210#
	Es	99	14920#	310#	6290#	270#	7940#	100#	*		50#	180#	-11430#	280#
	Fm	100	15580#	450#	5000#	200#	8550#	200#	*		690#	230#	*	
	245	Np	93	10130#	300#	*		3830#	420#	3990#	300#	*		-1990#
Pu		94	10719	14	13760#	300#	4560#	200#	2174	14	*		-4772	14
Am		95	11417.2	2.0	12550#	30#	5220	70	86.6	2.1	-8590#	300#	-4622.7	1.6
Cm		96	12320.1	1.1	11328.0	2.5	5624.5	0.5	-2380.6	2.2	-6090.4	2.5	-7781	14
Bk		97	13018	5	9939.2	1.9	6454.5	1.4	-4550#	200#	-5354.3	1.7	-7735.7	2.9
Cf		98	13750#	110#	8374.7	2.4	7258.5	1.8	-6800#	200#	-2355.7	2.2	-10710#	180#
Es		99	14520#	290#	6900#	200#	7909	3	-8910#	370#	-1640#	200#	-10670#	280#
Fm		100	15340#	290#	5380#	230#	8440#	100#	*		1420#	200#	*	
Md		101	*		4050#	370#	8980#	210#	*		1960#	360#	*	
246	Pu	94	10554	15	*		4350#	200#	2778	15	*		-4577	15
	Am	95	11028#	18#	12790#	300#	5150#	200#	1030#	60#	-8190#	300#	-4082#	18#
	Cm	96	11977.6	1.1	11767.0	2.7	5475.1	0.9	-1473.3	1.5	-7850	14	-7268.2	1.8
	Bk	97	12890	60	10490	60	6070	60	-3930#	230#	-5220	60	-7490	60
	Cf	98	13530.5	2.7	8939.5	1.1	6861.6	1.0	-6099	15	-4203.3	1.2	-10350#	200#
	Es	99	14270#	290#	7390#	220#	7740#	100#	-8210#	340#	-1200#	220#	-10360#	300#
	Fm	100	14920#	200#	5867	15	8377	8	*		-485	15	-13160#	310#
	Md	101	*		4490#	320#	8890	40	*		2460#	330#	*	
	247	Pu	94	10210#	200#	*		4320#	360#	3570#	200#	*		-3960#
Am		95	10890#	100#	13320#	320#	4850#	110#	1660#	100#	*		-3540#	100#
Cm		96	11614	4	12223	14	5354	3	-571	16	-7151	15	-6510	60
Bk		97	12467	5	10989	5	5890	5	-3089	20	-6793#	19#	-6672	5
Cf		98	13424	16	9479	15	6497	15	-5570#	120#	-3802	15	-9870#	220#
Es		99	13930#	200#	7813	20	7464	20	-7360#	210#	-2680	60	-9682	25
Fm		100	14660#	230#	6290#	120#	8258	10	*		290#	120#	-12510#	280#
Md		101	15480#	370#	5010#	290#	8764	10	*		750#	310#	*	

Table III. Nuclear-reaction and separation energies (continued, Explanation of Table on p. 030003-98)

A	Elt.	Z	S(n)	S(p)	$Q(4\beta^-)$	$Q(d,\alpha)$	$Q(p,\alpha)$	$Q(n,\alpha)$						
248	Am	95	4660#	220#	5830#	280#	260#	210#	15880#	200#	12250#	200#	10320#	360#
	Cm	96	6212	4	7050#	100#	-4505	9	13110#	18#	10356.3	2.9	9861	13
	Bk	97	5480#	70#	4740#	70#	-9070#	250#	16170#	70#	11940#	70#	11830#	70#
	Cf	98	6937	16	5541	7	-13380#	220#	13980	60	10288	5	11880	5
	Es	99	6350#	60#	3090#	50#	*	*	16920#	50#	11780#	50#	14130#	50#
	Fm	100	7850#	120#	3970	21	*	*	14710#	220#	10400#	200#	14159	9
	Md	101	6860#	320#	1810#	260#	*	*	17670#	240#	11830#	310#	16430#	310#
	No	102	*	*	2610#	310#	*	*	15220#	340#	10210#	380#	16080#	300#
249	Am	95	5530#	360#	*	*	1930#	300#	14710#	360#	12570#	300#	*	*
	Cm	96	4713.37	0.25	7100#	200#	-2768	7	14310#	100#	10621#	18#	11002	15
	Bk	97	6310#	70#	4835.3	2.6	-7390#	200#	15024	4	12093.5	1.4	10499#	18#
	Cf	98	5587	5	5650#	70#	-12060#	280#	14944	5	10620	60	12752.2	1.3
	Es	99	7200#	60#	3350#	30#	*	*	15780#	30#	11950#	30#	12850#	70#
	Fm	100	6450	10	4070#	50#	*	*	15652	20	10480#	220#	15075	6
	Md	101	7990#	310#	1960#	200#	*	*	16270#	230#	11910#	200#	14980#	300#
	No	102	6910#	360#	2660#	370#	*	*	16560#	350#	10530#	380#	17240#	280#
250	Cm	96	5832	10	7400#	300#	-1083	13	13140#	200#	10700#	100#	9530#	200#
	Bk	97	4968	4	5090	4	-5680#	300#	16268	4	12281	5	11440#	100#
	Cf	98	6623.7	1.3	5965.0	1.4	-10390#	200#	13800#	70#	10545	5	11284	4
	Es	99	6020#	100#	3790#	100#	*	*	16700#	100#	11990#	100#	13380#	100#
	Fm	100	7518	10	4390#	30#	*	*	14480#	50#	10358	21	13615	17
	Md	101	6670#	360#	2180#	300#	*	*	17440#	300#	11820#	320#	15700#	300#
	No	102	8290#	340#	2960#	280#	*	*	15130#	310#	10490#	290#	15540#	230#
251	Cm	96	4413	25	*	*	694	27	14260#	300#	10950#	200#	*	*
	Bk	97	5793	11	5051	15	-3739	22	15188	11	12699	11	10310#	200#
	Cf	98	5107	4	6104	5	-8710#	120#	14999	4	10920#	70#	12389	4
	Es	99	6780#	100#	3947	6	-13220#	300#	15500	6	12138	8	12080#	70#
	Fm	100	6190	17	4560#	100#	*	*	15490#	30#	10520#	50#	14362	16
	Md	101	7740#	300#	2394	20	*	*	16158	20	11933	21	14310#	60#
	No	102	6790#	230#	3070#	320#	*	*	16330#	230#	10570#	260#	16600#	120#
	Lr	103	*	*	1130#	360#	*	*	16660#	410#	11970#	370#	16230#	380#
252	Cm	96	5660#	300#	*	*	2240#	300#	*	*	10820#	420#	*	*
	Bk	97	4770#	200#	5400#	200#	-1980#	240#	16260#	200#	12650#	200#	11080#	360#
	Cf	98	6172	4	6482	11	-6837	10	13795	4	11052.3	2.6	10930.32	0.25
	Es	99	5290	50	4130	50	-11440#	240#	16840	50	12440	50	13090	50
	Fm	100	7210	16	4986	8	*	*	14300#	100#	10510#	30#	12739	5
	Md	101	6530#	130#	2730#	130#	*	*	17150#	130#	11860#	130#	14980#	130#
	No	102	8050#	120#	3384	21	*	*	14950#	300#	10500#	200#	14999	11
	Lr	103	7060#	380#	1400#	260#	*	*	17880#	310#	11820#	370#	17150#	310#
253	Bk	97	5680#	410#	5420#	470#	-240#	360#	14990#	360#	12800#	360#	*	*
	Cf	98	4804	4	6520#	200#	-5057	8	14784	11	11216	6	11958	11
	Es	99	6360	50	4313.0	2.6	-9570#	200#	15586	4	12704.2	1.4	11707	4
	Fm	100	5541	6	5240	50	-14210#	410#	15544	7	10980#	100#	13821.8	3.0
	Md	101	7410#	130#	2930#	30#	*	*	15930#	40#	11970#	30#	13590#	110#
	No	102	6584	12	3440#	130#	*	*	16103	20	10590#	300#	15933	10
	Lr	103	8230#	310#	1590#	200#	*	*	16440#	230#	11880#	290#	15590#	360#
	Rf	104	*	*	2470#	470#	*	*	16540#	510#	*	*	17640#	460#
254	Bk	97	4610#	470#	*	*	940#	310#	16050#	420#	12610#	300#	*	*
	Cf	98	6031	12	6880#	360#	-3382	15	13520#	200#	10977	16	10340	25
	Es	99	5091	4	4600	6	-7880#	300#	16667	5	12720	5	12409	11
	Fm	100	6514	4	5396.7	2.3	-12300#	280#	14320	50	11255	6	12414	4
	Md	101	5790#	110#	3180#	100#	*	*	17350#	100#	12360#	100#	14590#	100#
	No	102	7707	12	3740#	30#	*	*	14920#	130#	10621	21	14416	18
	Lr	103	6780#	360#	1780#	300#	*	*	17710#	300#	11890#	320#	16550#	300#
	Rf	104	8430#	500#	2670#	350#	*	*	15170#	370#	10340#	410#	16000#	310#

Table III. Nuclear-reaction and separation energies (continued, Explanation of Table on p.030003-98)

A	Elt.	Z	S(2n)	S(2p)	$Q(\alpha)$	$Q(2\beta^-)$	$Q(\epsilon p)$	$Q(\beta^-n)$						
248	Am	95	10570#	200#	*	4940#	360#	2480#	210#	*	-3040#	200#		
	Cm	96	11366.8	2.7	12580	15	5161.81	0.25	155	6	-9000#	200#	-6168	6
	Bk	97	12030#	90#	11490#	70#	5780#	70#	-2220#	90#	-6360#	120#	-6100#	70#
	Cf	98	12995	5	9957	5	6361	5	-4660	10	-5584	6	-9412	20
	Es	99	13740#	230#	8250#	80#	7160#	50#	-6850#	240#	-2480#	50#	-9450#	130#
	Fm	100	14434	17	6770	9	7995	8	-8720#	230#	-1495	18	-12110#	210#
	Md	101	15110#	350#	5330#	330#	8700#	150#	*	*	1280#	240#	*	*
No	102	*	*	4150#	230#	9230#	100#	*	*	1660#	250#	*	*	
249	Am	95	10190#	310#	*	4790#	420#	3260#	300#	*	-2360#	300#		
	Cm	96	10925	4	12940#	200#	5148	13	1027.9	2.6	*	-5400#	70#	
	Bk	97	11786	5	11890#	100#	5521.0	1.4	-1330#	30#	-8010#	200#	-5463	5
	Cf	98	12524	15	10388	4	6293.3	0.5	-3796	6	-4958.9	2.6	-8650#	50#
	Es	99	13550#	40#	8890#	30#	6940#	30#	-6060#	200#	-4190#	80#	-8790#	30#
	Fm	100	14300#	120#	7163	17	7709	6	-8260#	280#	-1008	8	-11700#	240#
	Md	101	14850#	290#	5920#	200#	8441	18	*	*	-360#	210#	-11460#	300#
No	102	*	*	4470#	300#	9170#	200#	*	*	2600#	280#	*	*	
250	Cm	96	10546	10	*	5170	18	1819	10	*	-4928	10		
	Bk	97	11270#	70#	12190#	200#	5531#	18#	-280#	100#	-7440#	300#	-4844	4
	Cf	98	12210	5	10800.3	2.7	6128.51	0.19	-2902	8	-6869.3	2.7	-8080#	30#
	Es	99	13220#	110#	9430#	120#	6830#	120#	-5410#	320#	-3910#	100#	-8370#	100#
	Fm	100	13968	12	7744	9	7557	8	-7490#	200#	-2940	8	-11230#	200#
	Md	101	14660#	380#	6250#	310#	8310#	200#	*	*	170#	300#	-11220#	410#
	No	102	15200#	300#	4910#	200#	8950#	200#	*	*	760#	200#	*	*
251	Cm	96	10245	23	*	5120#	200#	2513	22	*	-4373	23		
	Bk	97	10761	11	12450#	300#	5650#	100#	716	12	*	-4014	11	
	Cf	98	11730	4	11194	4	6177.0	0.9	-1819	16	-6144	11	-7160#	100#
	Es	99	12810#	30#	9912	6	6598	3	-4454	20	-5727	7	-7631	10
	Fm	100	13708	16	8347	15	7425.1	2.0	-6900#	120#	-2505	15	-10750#	300#
	Md	101	14410#	200#	6790#	40#	7963	4	-8760#	300#	-1550#	100#	-10670#	200#
	No	102	15080#	300#	5250#	120#	8752	4	*	*	1490#	120#	*	*
Lr	103	*	*	4080#	360#	9370#	360#	*	*	1810#	420#	*	*	
252	Cm	96	10080#	300#	*	*	*	3020#	300#	*	-4240#	300#		
	Bk	97	10560#	200#	*	5550#	280#	1240#	210#	*	-3670#	200#		
	Cf	98	11278.4	2.7	11533	10	6216.95	0.04	-781	6	-7902	23	-6549	6
	Es	99	12070#	110#	10230	50	6790#	50#	-3220#	140#	-5220	50	-6730	50
	Fm	100	13399	10	8933	6	7152.7	2.0	-6056	11	-4608	7	-10222	20
	Md	101	14260#	330#	7290#	160#	7790#	140#	-8230#	270#	-1290#	130#	-10410#	170#
	No	102	14840#	200#	5779	12	8549	5	*	*	-371	18	-12930#	300#
Lr	103	*	*	4470#	380#	9164	17	*	*	2480#	240#	*	*	
253	Bk	97	10440#	360#	*	5400#	200#	1920#	360#	*	-3180#	360#		
	Cf	98	10976	5	11924	23	6126	4	-44	5	-7040#	300#	-6060	50
	Es	99	11644	6	10795	11	6739.24	0.05	-2160#	30#	-6810#	200#	-5876	5
	Fm	100	12751	15	9367	5	7198.0	2.7	-5013	7	-3978	4	-9240#	130#
	Md	101	13940#	40#	7920#	30#	7573	8	-7400#	200#	-3410#	60#	-9770#	30#
	No	102	14630#	120#	6173	17	8415	4	-9200#	410#	254	9	-12450#	240#
	Lr	103	15300#	360#	4970#	200#	8918	20	*	*	780#	240#	*	*
Rf	104	*	*	3870#	430#	9350#	300#	*	*	3400#	410#	*	*	
254	Bk	97	10280#	360#	*	*	*	2400#	300#	*	-2980#	300#		
	Cf	98	10836	11	12290#	300#	5927	5	439	12	*	-5740	12	
	Es	99	11450	50	11120#	200#	6615.7	1.5	-1460#	100#	-6230#	360#	-5426	5
	Fm	100	12055	6	9710	3	7307.5	1.9	-3821	10	-5688	5	-8340#	30#
	Md	101	13200#	160#	8420#	110#	7800#	140#	-6420#	320#	-2850#	100#	-8980#	100#
	No	102	14291	13	6670	11	8226	8	-8480#	280#	-1911	10	-11920#	200#
	Lr	103	15010#	380#	5220#	330#	8816	12	*	*	1410#	300#	-11760#	510#
Rf	104	*	*	4250#	280#	9210#	200#	*	*	1550#	280#	*	*	

Table III. Nuclear-reaction and separation energies (continued, Explanation of Table on p. 030003-98)

A	Elt.	Z	S(n)		S(p)		Q(4β ⁻)		Q(d,α)		Q(p,α)		Q(n,α)	
255	Cf	98	4600#	200#	6870#	360#	-2000#	200#	14590#	410#	11140#	280#	11400#	360#
	Es	99	5973	11	4541	16	-5858	21	15499	11	12919	11	11200#	200#
	Fm	100	5174	5	5480	6	-10530#	120#	15500	4	11370	50	13411	4
	Md	101	6680#	100#	3349	7	-14750#	360#	16208	7	12891	8	13190	50
	No	102	5987	18	3940#	100#	*	*	16350#	40#	11160#	130#	15638	16
	Lr	103	8000#	300#	2065	20	*	*	16299	19	11940	20	15080#	130#
	Rf	104	6940#	310#	2830#	320#	*	*	16470#	230#	10460#	260#	17110#	120#
	Db	105	*	*	900#	460#	*	*	16750#	550#	*	*	16500#	430#
256	Cf	98	5840#	370#	*	*	-780#	320#	13360#	430#	10980#	480#	*	*
	Es	99	4970#	100#	4910#	220#	-4560#	130#	16560#	100#	12750#	100#	11910#	370#
	Fm	100	6384	7	5891	12	-8735	19	14207	7	11340	6	11832	6
	Md	101	5460#	120#	3630#	120#	-13040#	270#	17260#	120#	12970#	120#	14090#	120#
	No	102	7056	17	4310	10	*	*	15080#	100#	11510#	30#	14123	8
	Lr	103	6270	80	2350	80	*	*	17730	80	12250	80	16220#	90#
	Rf	104	8180#	120#	3014	25	*	*	15060#	300#	10510#	200#	15510	19
	Db	105	7170#	430#	1120#	270#	*	*	18010#	370#	11810#	480#	17570#	310#
257	Es	99	5860#	420#	4930#	520#	-3260#	410#	15310#	460#	12930#	410#	10660#	510#
	Fm	100	4968	6	5890#	100#	-7276	12	15212	12	11463	6	12895	12
	Md	101	6530#	120#	3783	6	-11210#	200#	15904	4	12954.3	2.5	12649	4
	No	102	5646	10	4500#	120#	*	*	16115	9	11660#	100#	14991	7
	Lr	103	7150#	90#	2450#	50#	*	*	16570#	50#	12810#	50#	14860#	110#
	Rf	104	6427	21	3170	80	*	*	16630	21	10860#	300#	16789	14
	Db	105	8360#	310#	1300#	200#	*	*	16590#	230#	11870#	350#	15980#	360#
258	Es	99	4770#	570#	*	*	-2080#	410#	16370#	510#	12760#	450#	*	*
	Fm	100	6240#	200#	6270#	460#	-5920#	200#	13950#	220#	11200#	200#	11260#	280#
	Md	101	5378	4	4192	6	-10110#	310#	16911	7	12751	6	13244	12
	No	102	6840#	100#	4800#	100#	-13770#	430#	14730#	160#	11500#	100#	13320#	100#
	Lr	103	5960#	110#	2750#	100#	*	*	17670#	100#	12840#	100#	15590#	100#
	Rf	104	7600	30	3610#	60#	*	*	15310	90	11260	40	15180	40
	Db	105	6480#	370#	1360#	310#	*	*	18290#	310#	12330#	330#	17500#	310#
	Sg	106	*	*	2250#	460#	*	*	15460#	480#	10520#	550#	16560#	430#
	259	Fm	100	4790#	350#	6290#	490#	-4660#	290#	15010#	500#	11380#	300#	12310#
Md		101	6130#	200#	4090#	280#	-8370#	210#	15750#	200#	13000#	200#	12080#	220#
No		102	5470#	100#	4897	8	-12440#	120#	15796	7	11490#	120#	14238	8
Lr		103	7000#	120#	2920#	120#	*	*	16320#	70#	12890#	70#	14040#	140#
Rf		104	6050#	80#	3710#	130#	*	*	16410#	90#	11480#	110#	16190#	70#
Db		105	7880#	310#	1640	60	*	*	16840	50	12630	60	15890	100
Sg		106	6800#	430#	2570#	330#	*	*	17020#	230#	10890#	270#	17940#	120#
260		Fm	100	6010#	520#	*	*	-3380#	480#	13770#	590#	11230#	600#	*
	Md	101	5140#	370#	4440#	420#	-7120#	330#	16840#	370#	12830#	320#	12800#	520#
	No	102	6540#	200#	5300#	280#	-10940#	200#	14640#	200#	11480#	200#	12670#	200#
	Lr	103	5650#	140#	3090#	120#	-15050#	280#	17510#	160#	12890#	120#	14930#	120#
	Rf	104	7290#	210#	3990#	210#	*	*	15080#	230#	11350#	210#	14550#	200#
	Db	105	6390#	110#	1980#	120#	*	*	18040#	100#	12670#	90#	16650#	100#
	Sg	106	8040#	120#	2730	60	*	*	15460#	310#	11210#	200#	16328	23
	Bh	107	*	*	490#	270#	*	*	18790#	480#	*	*	18760#	320#
261	Md	101	6050#	600#	4480#	670#	-5730#	520#	15590#	580#	13020#	550#	11520#	650#
	No	102	5230#	280#	5390#	370#	-9550#	200#	15540#	280#	11630#	200#	13680#	280#
	Lr	103	6790#	240#	3340#	280#	-13580#	290#	16190#	200#	12940#	220#	13520#	200#
	Rf	104	5900#	210#	4250#	130#	*	*	16180#	90#	11400#	110#	15490#	110#
	Db	105	7440#	140#	2130#	230#	*	*	16660#	130#	12830#	120#	15170#	150#
	Sg	106	6614	28	2960#	100#	*	*	16720	60	11070#	310#	17310	40
	Bh	107	8260#	320#	700#	210#	*	*	17330#	240#	12750#	460#	16980#	370#

Table III. Nuclear-reaction and separation energies (continued, Explanation of Table on p. 030003-98)

A	Elt.	Z	S(2n)	S(2p)	$Q(\alpha)$	$Q(2\beta^-)$	$Q(\epsilon p)$	$Q(\beta^-n)$						
255	Cf	98	10640#	200#	*	5740#	200#	1010#	200#	*	-5250#	200#		
	Es	99	11064	11	11420#	360#	6436.3	1.3	-754	13	-7590#	300#	-4885	11
	Fm	100	11689	5	10080	6	7239.7	1.8	-3008	16	-4831	12	-7720#	100#
	Md	101	12470#	30#	8745	7	7905.9	2.6	-5104	19	-4436	8	-7952	12
	No	102	13694	16	7116	15	8428	3	-7520#	120#	-1385	15	-11140#	300#
	Lr	103	14770#	200#	5800#	40#	8556	7	-9650#	360#	-790#	100#	-11320#	280#
	Rf	104	15370#	430#	4610#	120#	9055	4	*		2320#	120#	*	
	Db	105	*		3560#	410#	9440#	200#	*		2430#	470#	*	
256	Cf	98	10440#	320#	*	5560#	100#	1550#	310#	*			-5120#	320#
	Es	99	10950#	100#	11780#	310#	6230#	220#	-270#	160#	*		-4680#	100#
	Fm	100	11559	6	10433	12	7027	5	-2335	10	-6610#	200#	-7428	9
	Md	101	12140#	160#	9110#	120#	7740#	110#	-4290#	150#	-3920#	120#	-7420#	120#
	No	102	13044	12	7659	8	8582	5	-6400	19	-3267	9	-10197	19
	Lr	103	14270#	310#	6280#	130#	8810#	100#	-8750#	250#	-390	80	-10650#	140#
	Rf	104	15120#	280#	5079	20	8926	15	*		126	23	-13440#	360#
	Db	105	*		3950#	390#	9340	30	*		3260#	240#	*	
257	Es	99	10830#	410#	*	6050#	200#	410#	410#	*			-4160#	410#
	Fm	100	11352	6	10800#	200#	6863.5	1.4	-1657	8	-5740#	310#	-6940#	120#
	Md	101	11993	7	9674	11	7557.6	1.0	-3670#	40#	-5480#	100#	-6900	8
	No	102	12703	16	8130	8	8477	6	-5619	13	-2529	9	-9570	80
	Lr	103	13420#	50#	6760#	50#	9070	30	-7540#	210#	-2080#	130#	-9630#	50#
	Rf	104	14610#	120#	5519	18	9083	8	*		755	13	-12700#	240#
	Db	105	15530#	410#	4320#	200#	9207	20	*		1170#	220#	*	
258	Es	99	10630#	410#	*	5880#	500#	1020#	400#	*			-3960#	400#
	Fm	100	11200#	200#	11190#	370#	6660#	200#	-1050#	220#	*		-6640#	200#
	Md	101	11910#	120#	10080#	100#	7271.3	1.9	-3100#	100#	-5010#	410#	-6632	8
	No	102	12490#	100#	8590#	100#	8150#	100#	-4860#	110#	-4400#	100#	-9260#	110#
	Lr	103	13110#	130#	7250#	160#	8904	19	-7020#	320#	-1500#	100#	-9160#	100#
	Rf	104	14020	40	6060	30	9190	30	-8900#	410#	-1200	30	-11940#	210#
	Db	105	14840#	390#	4530#	320#	9500	50	*		1840#	310#	*	
	Sg	106	*		3560#	410#	9620#	300#	*		2090#	410#	*	
259	Fm	100	11030#	280#	*	6470#	200#	-370#	280#	*			-6050#	280#
	Md	101	11510#	200#	10360#	460#	7110#	200#	-2230#	210#	-6370#	450#	-5930#	220#
	No	102	12311	9	9089	8	7854	5	-4280#	70#	-3640#	200#	-8780#	100#
	Lr	103	12960#	80#	7720#	70#	8580#	70#	-6140#	90#	-3120#	70#	-8560#	80#
	Rf	104	13650#	70#	6460#	70#	9130#	70#	-8160#	140#	-400#	120#	-11510#	310#
	Db	105	14360#	210#	5250#	70#	9620	50	*		-80#	120#	-11320#	420#
	Sg	106	*		3930#	120#	9765	8	*		2890#	120#	*	
260	Fm	100	10800#	480#	*	6300#	300#	150#	480#	*			-5930#	480#
	Md	101	11280#	320#	10730#	510#	6940#	300#	-1730#	340#	*		-5600#	320#
	No	102	12010#	220#	9390#	280#	7700#	200#	-3540#	280#	-5380#	350#	-8310#	210#
	Lr	103	12650#	160#	7990#	120#	8400#	140#	-5400#	160#	-2640#	240#	-8160#	140#
	Rf	104	13340#	200#	6910#	220#	8900#	200#	-7400#	200#	-2220#	200#	-10920#	210#
	Db	105	14270#	320#	5690#	140#	9500#	40#	-9650#	260#	530#	120#	-10920#	150#
	Sg	106	14840#	410#	4370	40	9901	10	*		900#	80#	*	
	Bh	107	*		3050#	390#	10400	50	*		4040#	250#	*	
261	Md	101	11190#	550#	*	6750#	300#	-980#	550#	*			-5110#	550#
	No	102	11770#	200#	9830#	350#	7440#	200#	-2860#	210#	-4600#	480#	-7890#	240#
	Lr	103	12440#	210#	8640#	280#	8140#	200#	-4750#	230#	-4280#	370#	-7660#	280#
	Rf	104	13190#	90#	7340	50	8650	50	-6690	50	-1580#	210#	-10430#	110#
	Db	105	13830#	120#	6120#	130#	9220#	100#	-8830#	240#	-1260#	170#	-10310#	110#
	Sg	106	14660#	120#	4940#	80#	9714	15	*		1570#	200#	-13390#	250#
	Bh	107	*		3440#	220#	10500	50	*		2170#	230#	*	

Table III. Nuclear-reaction and separation energies (continued, Explanation of Table on p. 030003-98)

A	Elt.	Z	S(n)	S(p)	$Q(4\beta^-)$		$Q(d,\alpha)$	$Q(p,\alpha)$	$Q(n,\alpha)$					
262	Md	101	5020#	710#	*	-4630#	520#	16570#	660#	12790#	580#	*		
	No	102	6430#	410#	5770#	620#	-8270#	360#	14260#	480#	11340#	410#	12040#	460#
	Lr	103	5530#	280#	3640#	280#	-12440#	370#	17200#	280#	12890#	200#	14120#	280#
	Rf	104	7000#	230#	4450#	300#	*	*	14830#	260#	11410#	240#	13960#	220#
	Db	105	6130#	180#	2350#	150#	*	*	17820#	250#	12760#	160#	16050#	160#
	Sg	106	7710	40	3230#	120#	*	*	15400#	100#	11240	60	15650#	80#
	Bh	107	6660#	370#	750#	310#	*	*	18710#	310#	12890#	330#	18200#	310#
263	No	102	5040#	610#	5790#	700#	-7060#	500#	15260#	710#	11440#	580#	13010#	660#
	Lr	103	6440#	350#	3660#	460#	-10770#	420#	15990#	350#	12980#	350#	12820#	420#
	Rf	104	5710#	270#	4640#	250#	-14920#	200#	15910#	250#	11340#	200#	14790#	250#
	Db	105	7210#	220#	2570#	280#	*	*	16500#	180#	12830#	260#	14480#	210#
	Sg	106	6250#	100#	3350#	170#	*	*	16590#	150#	11380#	130#	16690#	220#
	Bh	107	8120#	430#	1160#	310#	*	*	17200#	310#	12810#	310#	16470#	320#
	Hs	108	*		2150#	330#	*	*	17260#	240#	11220#	280#	18780#	130#
264	No	102	6190#	770#	*	-5770#	660#	14090#	770#	11300#	780#	*		
	Lr	103	5420#	520#	4040#	660#	-9680#	470#	16990#	570#	12790#	480#	13450#	670#
	Rf	104	6750#	390#	4940#	460#	-13490#	360#	14690#	410#	11380#	410#	13270#	410#
	Db	105	5820#	290#	2680#	280#	*	*	17680#	330#	12910#	240#	15450#	310#
	Sg	106	7480#	300#	3620#	330#	*	*	15240#	320#	11340#	300#	15110#	290#
	Bh	107	6510#	350#	1420#	200#	*	*	18400#	180#	12920#	180#	17400#	210#
	Hs	108	8190#	130#	2220#	310#	*	*	15730#	310#	11290#	210#	17200	30
265	Lr	103	6220#	700#	4070#	810#	-8180#	600#	15820#	730#	13000#	660#	12250#	740#
	Rf	104	5460#	510#	4980#	570#	-12210#	360#	15670#	460#	11450#	410#	14240#	510#
	Db	105	6950#	330#	2880#	420#	-16200#	500#	16440#	270#	12950#	320#	14030#	300#
	Sg	106	6060#	310#	3860#	270#	*	*	16390#	210#	11410#	190#	16050#	260#
	Bh	107	7710#	290#	1660#	370#	*	*	16940#	250#	12910#	240#	15810#	270#
	Hs	108	6730	40	2450#	180#	*	*	17120#	310#	11220#	310#	18180	40
	Mt	109	*		170#	450#	*	*	17710#	470#	*	*	17780#	550#
266	Lr	103	4680#	800#	*	-6480#	610#	17320#	830#	13360#	760#	*		
	Rf	104	6690#	590#	5450#	720#	-11060#	470#	14410#	640#	11210#	550#	12590#	680#
	Db	105	5820#	360#	3240#	460#	-15230#	420#	17370#	460#	12850#	320#	14650#	400#
	Sg	106	7250#	270#	4150#	330#	*	*	14970#	340#	11370#	300#	14510#	290#
	Bh	107	6380#	290#	1980#	200#	*	*	18030#	330#	12780#	190#	16640#	230#
	Hs	108	7840	50	2570#	240#	*	*	15790#	180#	11500#	310#	16590#	100#
	Mt	109	6790#	550#	230#	310#	*	*	19110#	310#	13150#	330#	19110#	430#
267	Rf	104	4700#	740#	5470#	820#	-9210#	580#	15920#	790#	11930#	720#	14080#	820#
	Db	105	6730#	500#	3290#	630#	-13720#	650#	16100#	550#	12860#	550#	13340#	600#
	Sg	106	5880#	360#	4220#	380#	-18070#	290#	16030#	340#	11310#	350#	15380#	440#
	Bh	107	7410#	310#	2140#	360#	*	*	16680#	290#	12850#	390#	15050#	350#
	Hs	108	6560#	100#	2740#	190#	*	*	16950#	250#	11460#	200#	17520#	300#
	Mt	109	8240#	590#	630#	500#	*	*	17600#	500#	13090#	500#	17380#	530#
	Ds	110	*		1370#	340#	*	*	17910#	470#	*	*	19960#	140#
268	Rf	104	6040#	880#	*	-7350#	720#	14560#	880#	12110#	860#	*		
	Db	105	5080#	670#	3670#	780#	-12090#	580#	17700#	710#	13240#	640#	14480#	760#
	Sg	106	7080#	540#	4560#	630#	-16850#	560#	14780#	550#	11180#	520#	13760#	590#
	Bh	107	6030#	460#	2290#	460#	*	*	17900#	450#	12880#	400#	15970#	440#
	Hs	108	7890#	300#	3230#	390#	*	*	15440#	330#	11280#	370#	15680#	310#
	Mt	109	6710#	550#	790#	250#	*	*	18730#	240#	13120#	230#	18380#	330#
	Ds	110	8300#	330#	1430#	590#	*	*	16400#	430#	11830#	540#	18390#	300#
269	Db	105	5990#	820#	3620#	910#	-10220#	780#	16420#	850#	13940#	780#	13170#	850#
	Sg	106	5110#	590#	4590#	640#	-15070#	370#	16400#	550#	11890#	460#	15330#	590#
	Bh	107	7400#	530#	2610#	600#	*	*	16380#	450#	12720#	450#	14390#	470#
	Hs	108	6340#	310#	3530#	400#	*	*	16510#	290#	11320#	210#	16590#	280#
	Mt	109	7850#	520#	750#	540#	*	*	17430#	470#	13100#	470#	16910#	490#
	Ds	110	6890#	300#	1610#	240#	*	*	17760#	500#	11740#	310#	19340	50

Table III. Nuclear-reaction and separation energies (continued, Explanation of Table on p. 030003-98)

A	El.	Z	S(2n)		S(2p)		$Q(\alpha)$		$Q(2\beta^-)$		$Q(\epsilon p)$		$Q(\beta^-n)$	
262	Md	101	11070#	590#	*		6500#	300#	-480#	540#	*		-4900#	540#
	No	102	11650#	410#	10240#	570#	7250#	300#	-2290#	420#	*		-7530#	410#
	Lr	103	12320#	240#	9030#	370#	7990#	200#	-4150#	250#	-3770#	550#	-7290#	210#
	Rf	104	12900#	300#	7800#	300#	8490#	200#	-5970#	230#	-3350#	300#	-9990#	250#
	Db	105	13560#	170#	6600#	190#	9050#	100#	-8290#	340#	-590#	250#	-9820#	140#
	Sg	106	14320	40	5360#	200#	9600	15	*		-240	60	-12840#	210#
	Bh	107	14930#	390#	3710#	320#	10319	15	*		2940#	330#	*	*
263	No	102	11470#	530#	*		7000#	400#	-1630#	510#	*		-7040#	530#
	Lr	103	11970#	350#	9430#	580#	7680#	200#	-3380#	330#	-5190#	580#	-6740#	360#
	Rf	104	12710#	160#	8280#	250#	8250#	150#	-5440#	180#	-2640#	390#	-9570#	210#
	Db	105	13340#	200#	7030#	260#	8830#	150#	-7390#	350#	-2280#	260#	-9330#	170#
	Sg	106	13960#	100#	5710#	110#	9400	60	-9490#	160#	510#	240#	-12420#	320#
	Bh	107	14780#	370#	4390#	320#	10080#	300#	*		950#	340#	*	*
	Hs	108	*		2910#	130#	10730	50	*		4020#	130#	*	*
264	No	102	11230#	690#	*		6820#	400#	-1070#	690#	*		-6790#	660#
	Lr	103	11870#	480#	9830#	660#	7400#	300#	-2990#	500#	*		-6450#	460#
	Rf	104	12460#	420#	8600#	510#	8040#	300#	-4710#	460#	-4340#	610#	-9110#	400#
	Db	105	13030#	280#	7320#	310#	8660#	200#	-6700#	300#	-1660#	370#	-8900#	250#
	Sg	106	13730#	290#	6190#	360#	9210#	200#	-8780#	280#	-1260#	320#	-11790#	420#
	Bh	107	14630#	350#	4770#	230#	9960#	150#	*		1660#	240#	-11690#	220#
	Hs	108	*		3380	50	10591	20	*		2080#	100#	*	*
265	Lr	103	11640#	620#	*		7230#	200#	-2250#	590#	*		-5920#	660#
	Rf	104	12210#	390#	9020#	610#	7810#	300#	-4110#	380#	-3610#	690#	-8740#	430#
	Db	105	12770#	280#	7820#	360#	8500#	100#	-5930#	320#	-3180#	490#	-8370#	360#
	Sg	106	13540#	160#	6540#	200#	9050#	110#	-8110#	130#	-570#	380#	-11340#	220#
	Bh	107	14220#	380#	5270#	290#	9680#	210#	-10260#	510#	-240#	330#	-11220#	240#
	Hs	108	14920#	130#	3870#	100#	10470	15	*		2830#	280#	*	*
	Mt	109	*		2400#	540#	11120#	400#	*		3330#	490#	*	*
266	Lr	103	10900#	730#	*		7570#	300#	-1120#	650#	*		-5140#	690#
	Rf	104	12140#	590#	9510#	750#	7550#	300#	-3540#	530#	*		-8480#	520#
	Db	105	12770#	370#	8220#	520#	8210#	200#	-5370#	330#	-2790#	620#	-8130#	310#
	Sg	106	13310#	370#	7040#	440#	8800#	100#	-7520#	250#	-2360#	440#	-10870#	340#
	Bh	107	14100#	240#	5840#	290#	9430#	80#	-9860#	350#	330#	280#	-10870#	160#
	Hs	108	14570	50	4220#	290#	10346	16	*		1050#	130#	-13610#	450#
	Mt	109	*		2670#	350#	10996	25	*		4260#	390#	*	*
267	Rf	104	11390#	680#	*		7890#	300#	-2360#	630#	*		-7360#	640#
	Db	105	12550#	470#	8740#	690#	7920#	300#	-4690#	490#	-4840#	720#	-7620#	480#
	Sg	106	13130#	280#	7460#	440#	8630#	210#	-6850#	270#	-1560#	540#	-10370#	300#
	Bh	107	13790#	350#	6300#	350#	9230#	200#	-9030#	570#	-1260#	390#	-10440#	270#
	Hs	108	14390#	100#	4720#	160#	10038	13	-11230#	170#	1750#	260#	-13380#	320#
	Mt	109	15030#	680#	3200#	550#	10870#	400#	*		2400#	530#	*	*
	Ds	110	*		1600#	140#	11780	50	*		5450#	140#	*	*
268	Rf	104	10740#	810#	*		8040#	300#	-1330#	810#	*		-6670#	780#
	Db	105	11820#	600#	9140#	790#	8260#	300#	-3750#	650#	*		-6820#	590#
	Sg	106	12960#	530#	7850#	660#	8300#	300#	-6030#	550#	-3930#	740#	-10040#	540#
	Bh	107	13440#	420#	6510#	480#	9020#	300#	-8340#	450#	-560#	560#	-9920#	390#
	Hs	108	14450#	290#	5370#	380#	9623	16	-10820#	410#	-270#	380#	-13030#	580#
	Mt	109	14950#	390#	3530#	280#	10670#	150#	*		3100#	350#	-12800#	270#
	Ds	110	*		2070#	300#	11660#	300#	*		3710#	320#	*	*
269	Db	105	11070#	750#	*		8490#	300#	-2330#	730#	*		-5730#	780#
	Sg	106	12190#	450#	8260#	680#	8650	50	-4800#	390#	-3000#	760#	-9120#	530#
	Bh	107	13430#	460#	7170#	560#	8570#	300#	-7890#	600#	-2870#	650#	-9420#	470#
	Hs	108	14230#	160#	5820#	290#	9340#	160#	-10270#	130#	470#	490#	-12660#	260#
	Mt	109	14560#	680#	3970#	530#	10530#	400#	*		1270#	600#	-12350#	550#
	Ds	110	15190#	140#	2400#	100#	11510	30	*		4720#	290#	*	*

Table III. Nuclear-reaction and separation energies (continued, Explanation of Table on p. 030003-98)

A	Elt.	Z	S(n)		S(p)	Q($4\beta^-$)		Q(d, α)		Q(p, α)		Q(n, α)		
270	Db	105	4910#	880#	*	-8400#	640#	17540#	910#	13730#	840#	*		
	Sg	106	6340#	670#	4950#	840#	-13190#	560#	15140#	770#	12280#	690#	13690#	800#
	Bh	107	5320#	470#	2830#	460#	*	18140#	550#	13280#	390#	15800#	500#	
	Hs	108	7520#	280#	3650#	450#	*	15020#	460#	11210#	360#	14950#	360#	
	Mt	109	6730#	490#	1140#	210#	*	18590#	330#	12920#	200#	17590#	310#	
	Ds	110	8230	60	1980#	470#	*	16240#	240#	11750#	510#	17670#	110#	
271	Sg	106	4810#	810#	4840#	850#	-11190#	590#	16320#	860#	12560#	790#	14930#	880#
	Bh	107	6380#	510#	2860#	700#	*	16870#	550#	13980#	630#	14510#	670#	
	Hs	108	5440#	370#	3780#	400#	*	16970#	470#	11800#	470#	16590#	550#	
	Mt	109	7680#	370#	1300#	410#	*	17250#	350#	13140#	440#	15940#	500#	
	Ds	110	6800#	110#	2050#	200#	*	17290#	470#	11660#	250#	18760#	300#	
272	Sg	106	6250#	930#	*	-9430#	840#	14980#	950#	12300#	960#	*		
	Bh	107	5200#	680#	3260#	790#	-13980#	580#	18010#	770#	13890#	640#	15290#	820#
	Hs	108	6810#	580#	4200#	660#	*	15490#	590#	12390#	630#	14890#	630#	
	Mt	109	5590#	590#	1450#	560#	*	19180#	550#	13880#	500#	17750#	610#	
	Ds	110	8000#	420#	2380#	530#	*	16020#	450#	11510#	620#	17100#	430#	
	Rg	111	*		460#	250#	*	18810#	240#	12800#	240#	19050#	520#	
273	Sg	106	4630#	880#	*	-8340#	520#	*		12580#	800#	*		
	Bh	107	6230#	870#	3240#	1000#	-12060#	870#	16590#	910#	14010#	890#	13970#	930#
	Hs	108	5190#	630#	4190#	650#	*	16680#	560#	12530#	470#	16050#	670#	
	Mt	109	6940#	650#	1580#	660#	*	17680#	510#	14460#	490#	16130#	510#	
	Ds	110	5730#	430#	2520#	500#	*	17970#	360#	12510#	220#	18890#	280#	
	Rg	111	8150#	580#	610#	670#	*	17460#	540#	12880#	530#	17630#	550#	
274	Bh	107	5020#	930#	3630#	800#	-10930#	640#	17810#	960#	13790#	850#	*	
	Hs	108	6480#	700#	4440#	910#	*	15410#	800#	12430#	720#	14380#	830#	
	Mt	109	5540#	550#	1930#	510#	*	18950#	620#	14370#	450#	16970#	550#	
	Ds	110	7230#	410#	2800#	580#	*	16330#	620#	12960#	510#	17100#	480#	
	Rg	111	6150#	560#	1030#	220#	*	19310#	450#	13530#	200#	19160#	380#	
275	Bh	107	6060#	860#	*	-9610#	790#	16380#	780#	13970#	940#	*		
	Hs	108	4940#	830#	4350#	850#	*	16700#	910#	12690#	790#	15690#	940#	
	Mt	109	6490#	550#	1950#	730#	*	17650#	560#	14690#	660#	15690#	680#	
	Ds	110	5700#	570#	2970#	540#	*	17560#	590#	12850#	640#	18210#	660#	
	Rg	111	7390#	550#	1190#	650#	*	17650#	540#	14150#	660#	17360#	710#	
276	Hs	108	6410#	960#	4690#	960#	-12070#	960#	15320#	980#	12520#	1020#	13910#	910#
	Mt	109	5590#	680#	2590#	790#	*	18540#	800#	14290#	650#	16330#	870#	
	Ds	110	7100#	680#	3580#	690#	*	16010#	650#	12690#	690#	16300#	660#	
	Rg	111	5880#	820#	1370#	750#	*	19000#	740#	14000#	640#	18420#	760#	
	Cn	112	*		2230#	790#	*	16450#	620#	12520#	800#	17640#	610#	
277	Hs	108	4860#	930#	*	-10910#	560#	16510#	810#	12680#	820#	*		
	Mt	109	6420#	880#	2610#	1030#	*	17060#	910#	14350#	920#	14930#	930#	
	Ds	110	5470#	670#	3460#	660#	*	17020#	570#	12760#	520#	17300#	710#	
	Rg	111	7220#	820#	1490#	760#	*	17480#	660#	14000#	650#	16740#	630#	
	Cn	112	6020#	610#	2370#	650#	*	17820#	540#	12650#	230#	18850#	420#	
278	Mt	109	5300#	940#	3050#	820#	-13150#	650#	18160#	980#	13980#	860#	15690#	860#
	Ds	110	6830#	730#	3880#	940#	*	15780#	820#	12420#	750#	15410#	860#	
	Rg	111	5890#	630#	1910#	520#	*	18690#	650#	13820#	540#	17340#	550#	
	Cn	112	7540#	460#	2690#	680#	*	16160#	770#	12500#	680#	17010#	600#	
	Ed	113	*		800#	230#	*	19250#	620#	*		19240#	550#	
279	Mt	109	6310#	910#	*	-11740#	970#	16710#	860#	14070#	1010#	*		
	Ds	110	5330#	870#	3900#	860#	*	16870#	920#	12680#	800#	16490#	960#	
	Rg	111	6810#	550#	1900#	750#	*	17350#	570#	14100#	690#	16110#	680#	
	Cn	112	5970#	630#	2780#	580#	*	17400#	690#	12410#	780#	18140#	710#	
	Ed	113	7720#	720#	980#	820#	*	17550#	710#	13750#	920#	17400#	940#	

Table III. Nuclear-reaction and separation energies (continued, Explanation of Table on p. 030003-98)

A	Elt.	Z	S(2n)	S(2p)	$Q(\alpha)$	$Q(2\beta^-)$	$Q(\epsilon p)$	$Q(\beta^- n)$						
270	Db	105	10900#	810#	*	8260#	200#	-1920#	680#	*	-5530#	720#		
	Sg	106	11450#	730#	8560#	870#	8990#	300#	-3620#	610#	*	-8060#	670#	
	Bh	107	12720#	480#	7410#	600#	9060	50	-6480#	330#	-2210#	690#	-8410#	310#
	Hs	108	13860#	380#	6270#	530#	9070	40	-9570#	250#	-1940#	440#	-12330#	530#
	Mt	109	14580#	290#	4670#	420#	10180	50	*		1940#	410#	-12200#	170#
	Ds	110	15110#	310#	2730#	290#	11117	28	*		2830#	130#	*	
271	Sg	106	11150#	690#	*	8890#	110#	-2980#	650#	*		-7540#	650#	
	Bh	107	11700#	560#	7810#	750#	9420	50	-5180#	530#	-3680#	740#	-7260#	480#
	Hs	108	12970#	310#	6600#	460#	9510#	110#	-8210#	300#	-1040#	620#	-11040#	330#
	Mt	109	14410#	570#	4960#	500#	9910#	200#	*		-410#	440#	-11650#	330#
	Ds	110	15030#	100#	3190#	160#	10870	18	*		3550#	270#	*	
272	Sg	106	11050#	920#	*	8680#	300#	-2430#	890#	*		-7410#	840#	
	Bh	107	11580#	600#	8100#	810#	9300	50	-4790#	720#	*		-7020#	600#
	Hs	108	12250#	570#	7060#	760#	9780#	200#	-7010#	660#	-3040#	780#	-10170#	610#
	Mt	109	13270#	510#	5220#	560#	10350#	300#	-9190#	540#	370#	640#	-10440#	500#
	Ds	110	14810#	420#	3680#	480#	10760#	300#	*		990#	500#	*	
	Rg	111	*		2520#	290#	11197	13	*		4380#	400#	*	
273	Sg	106	10880#	770#	*	*		-1870#	620#	*		-6840#	730#	
	Bh	107	11430#	810#	*	9060#	300#	-4080#	810#	*		-6450#	860#	
	Hs	108	11990#	460#	7450#	690#	9700	50	-6470#	390#	-1980#	820#	-9760#	610#
	Mt	109	12530#	540#	5790#	590#	10810#	200#	-7980#	680#	-1370#	680#	-9370#	590#
	Ds	110	13740#	170#	3960#	310#	11370	50	*		2060#	530#	-12490#	270#
	Rg	111	*		2980#	620#	10900#	250#	*		1820#	720#	*	
274	Bh	107	11250#	820#	*	8950	50	-3560#	710#	*		-6280#	720#	
	Hs	108	11660#	780#	7670#	940#	9570#	200#	-5710#	710#	-3820#	780#	-9300#	730#
	Mt	109	12480#	600#	6120#	640#	10600#	210#	-7370#	400#	-680#	780#	-9180#	380#
	Ds	110	12960#	570#	4390#	640#	11660#	300#	*		20#	540#	-11570#	660#
	Rg	111	14300#	290#	3550#	520#	11480	50	*		2610#	460#	*	
275	Bh	107	11090#	910#	*	*		-3140#	730#	*		-5870#	840#	
	Hs	108	11410#	690#	7980#	770#	9440	50	-4950#	720#	*		-8700#	690#
	Mt	109	12030#	600#	6380#	810#	10480	50	-6470#	670#	-2140#	750#	-8440#	570#
	Ds	110	12930#	430#	4900#	550#	11400#	300#	*		790#	720#	-11120#	450#
	Rg	111	13540#	740#	4000#	670#	11770#	400#	*		760#	630#	*	
276	Hs	108	11340#	960#	*	9280#	200#	-4260#	930#	*		-8620#	860#	
	Mt	109	12070#	640#	6950#	820#	10100	9	-6170#	820#	-1670#	800#	-8320#	670#
	Ds	110	12800#	670#	5520#	810#	11110#	200#	-7810#	810#	-1370#	800#	-10830#	750#
	Rg	111	13270#	650#	4340#	720#	11480#	400#	*		1370#	760#	*	
	Cn	112	*		3420#	710#	11910#	730#	*		1500#	720#	*	
277	Hs	108	11270#	800#	*	9050#	200#	-3650#	660#	*		-7890#	760#	
	Mt	109	12000#	820#	7300#	920#	9910#	100#	-5370#	870#	*		-7650#	890#
	Ds	110	12570#	560#	6060#	700#	10830#	110#	-7260#	410#	-430#	850#	-10420#	740#
	Rg	111	13100#	730#	5070#	670#	11200#	300#	*		-270#	740#	-10090#	790#
	Cn	112	*		3740#	430#	11620	50	*		2570#	570#	*	
278	Mt	109	11720#	820#	*	9630	50	-4780#	720#	*		-7480#	730#	
	Ds	110	12300#	830#	6480#	980#	10470#	200#	-6550#	760#	-2400#	830#	-10030#	810#
	Rg	111	13110#	720#	5380#	640#	10850	50	-8370#	400#	260#	790#	-9960#	390#
	Cn	112	13560#	740#	4190#	700#	11310#	200#	*		500#	580#	*	
	Ed	113	*		3180#	660#	11850	50	*		3260#	550#	*	
279	Mt	109	11620#	970#	*	9380#	300#	-4280#	790#	*		-6960#	910#	
	Ds	110	12160#	710#	6950#	810#	10080#	110#	-5900#	750#	*		-9460#	700#
	Rg	111	12710#	670#	5770#	820#	10520	50	-7460#	820#	-1250#	750#	-9230#	610#
	Cn	112	13520#	480#	4690#	600#	11040#	200#	*		1360#	770#	-11930#	490#
	Ed	113	*		3680#	870#	11520#	870#	*		1430#	790#	*	

Table III. Nuclear-reaction and separation energies (continued, Explanation of Table on p. 030003-98)

A	Elt.	Z	S(n)	S(p)	$Q(4\beta^-)$	$Q(d,\alpha)$	$Q(p,\alpha)$	$Q(n,\alpha)$					
280	Ds	110	6680#	980#	4260#	1030#	*	15500#	1000#	12420#	1050#	14670#	950#
	Rg	111	5960#	680#	2530#	800#	*	18220#	820#	13610#	660#	16560#	880#
	Cn	112	7410#	740#	3370#	720#	*	15890#	680#	12220#	780#	16200#	700#
	Ed	113	6170#	810#	1180#	610#	*	18920#	590#	13600#	420#	18450#	660#
281	Ds	110	5160#	970#	*	*	*	16650#	880#	12560#	850#	*	*
	Rg	111	6660#	970#	2510#	1120#	*	16880#	1000#	13780#	1020#	15210#	1020#
	Cn	112	5750#	700#	3160#	660#	*	16960#	570#	12370#	530#	17290#	740#
	Ed	113	7400#	500#	1180#	660#	*	17490#	550#	13740#	530#	16940#	470#
282	Rg	111	5570#	1040#	2920#	870#	*	17990#	1020#	13540#	890#	15950#	940#
	Cn	112	7120#	760#	3610#	1040#	*	15800#	840#	12070#	780#	15500#	890#
	Ed	113	6160#	470#	1580#	530#	*	18740#	690#	13560#	580#	17600#	560#
283	Rg	111	6590#	960#	*	*	*	16560#	910#	13620#	1050#	*	*
	Cn	112	5560#	900#	3600#	890#	*	16900#	1010#	12460#	810#	16610#	990#
	Ed	113	7090#	570#	1560#	790#	*	17400#	580#	13870#	730#	16470#	690#
284	Cn	112	7010#	1010#	4020#	1070#	*	15460#	1040#	12110#	1140#	14760#	990#
	Ed	113	6190#	690#	2180#	810#	*	18330#	850#	13440#	660#	16940#	970#
	Fl	114	*	*	3070#	790#	*	15910#	750#	11980#	720#	16550#	760#
285	Cn	112	5440#	990#	*	*	*	16600#	910#	12240#	880#	*	*
	Ed	113	6930#	970#	2100#	1140#	*	16960#	1010#	13620#	1040#	15580#	1040#
	Fl	114	5990#	760#	2880#	660#	*	17010#	590#	12140#	530#	17670#	760#
286	Ed	113	5790#	1040#	2450#	880#	*	18180#	1040#	13390#	900#	16380#	960#
	Fl	114	7300#	760#	3250#	1040#	*	15890#	850#	11930#	790#	15930#	900#
287	Ed	113	6840#	980#	*	*	*	16780#	930#	13560#	1080#	*	*
	Fl	114	5770#	900#	3230#	900#	*	17050#	1010#	12350#	810#	17170#	1010#
	Ef	115	*	*	1170#	790#	*	17600#	590#	13840#	790#	16950#	690#
288	Fl	114	7100#	1010#	3490#	1080#	*	15740#	1040#	12180#	1140#	15520#	990#
	Ef	115	6200#	690#	1590#	810#	*	18710#	850#	13630#	660#	17690#	970#
289	Fl	114	5550#	1000#	*	*	*	17030#	930#	12410#	880#	*	*
	Ef	115	7180#	970#	1670#	1140#	*	17300#	1010#	13760#	1040#	16300#	1040#
	Lv	116	*	*	2530#	730#	*	17340#	660#	*	*	18400#	820#
290	Ef	115	5840#	1040#	1960#	880#	*	18560#	1040#	13690#	900#	17300#	980#
	Lv	116	7400#	820#	2760#	1040#	*	16140#	850#	12170#	790#	16770#	900#
291	Ef	115	6980#	1020#	*	*	*	17140#	980#	13810#	1120#	*	*
	Lv	116	5880#	900#	2800#	900#	*	17430#	1010#	12480#	810#	17990#	1010#
	Eh	117	*	*	690#	890#	*	17980#	770#	*	*	17680#	800#
292	Lv	116	7220#	1010#	3040#	1130#	*	16060#	1040#	12440#	1140#	16320#	1000#
	Eh	117	6300#	900#	1100#	910#	*	19090#	940#	13910#	830#	18560#	1050#
293	Lv	116	5640#	1000#	*	*	*	17390#	980#	12640#	880#	*	*
	Eh	117	7260#	1050#	1150#	1140#	*	17710#	1020#	14050#	1050#	17140#	1040#
	Ei	118	*	*	1990#	970#	*	17780#	920#	*	*	19320#	960#
294	Eh	117	5940#	1050#	1440#	880#	*	18990#	1040#	14000#	900#	18180#	1030#
	Ei	118	7480#	970#	2210#	1050#	*	16600#	940#	12530#	890#	17720#	900#
295	Ei	118	6020#	930#	2300#	920#	*	17840#	1040#	12800#	930#	18920#	1030#

Table III. Nuclear-reaction and separation energies (continued, Explanation of Table on p. 030003-98)

A	Elt.	Z	S(2n)		S(2p)		Q(α)		Q($2\beta^-$)		Q(ϵp)		Q($\beta^- n$)	
280	Ds	110	12000#	1000#	*		9810#	200#	-5180#	970#	*		-9330#	890#
	Rg	111	12770#	640#	6430#	820#	10146	7	-7250#	670#	-900#	850#	-9220#	700#
	Cn	112	13380#	730#	5260#	850#	10730#	200#	*		-720#	840#	-11610#	910#
	Ed	113	13890#	440#	3960#	540#	11230#	750#	*		2080#	580#	*	
281	Ds	110	11840#	830#	*		9510#	210#	-4590#	700#	*		-8530#	790#
	Rg	111	12620#	910#	6780#	1050#	9900#	400#	-6510#	860#	*		-8470#	990#
	Cn	112	13150#	600#	5680#	710#	10450	50	*		210#	870#	-11190#	560#
	Ed	113	13570#	760#	4540#	520#	11050#	600#	*		640#	610#	*	
282	Rg	111	12230#	840#	*		9640#	210#	-5930#	750#	*		-8290#	760#
	Cn	112	12860#	880#	6120#	1020#	10170#	200#	*		-1740#	880#	-10910#	720#
	Ed	113	13560#	540#	4740#	640#	10780	50	*		1140#	880#	*	
283	Rg	111	12160#	1070#	*		9360#	200#	-5430#	820#	*		-7770#	960#
	Cn	112	12680#	720#	6520#	840#	9940#	110#	*		*		-10310#	710#
	Ed	113	13250#	530#	5170#	920#	10510#	110#	*		-380#	790#	*	
284	Cn	112	12570#	1040#	*		9600#	200#	-6380#	1040#	*		-10230#	920#
	Ed	113	13280#	640#	5790#	840#	10280	50	*		20#	880#	*	
	Fl	114	*		4630#	930#	10800#	300#	*		150#	900#	*	
285	Cn	112	12460#	840#	*		9320	50	-5830#	700#	*		-9490#	790#
	Ed	113	13120#	920#	6130#	1070#	10010	50	*		*		-9260#	1040#
	Fl	114	*		5060#	720#	10560	50	*		1170#	900#	*	
286	Ed	113	12720#	850#	*		9790	50	*		*		-9060#	760#
	Fl	114	13290#	930#	5350#	1040#	10370	30	*		-690#	880#	*	
287	Ed	113	12630#	1090#	*		9540#	200#	-6650#	850#	*		-8600#	980#
	Fl	114	13070#	730#	5680#	840#	10160	50	*		*		*	
	Ef	115	*		4410#	920#	10760	50	*		590#	790#	*	
288	Fl	114	12870#	1040#	*		10072	13	*		*		-10920#	920#
	Ef	115	*		4820#	850#	10750	50	*		1240#	900#	*	
289	Fl	114	12650#	840#	*		9970	50	-6960#	760#	*		-10280#	790#
	Ef	115	13370#	920#	5160#	1090#	10510	50	*		*		*	
	Lv	116	*		4120#	780#	11100#	300#	*		2200#	940#	*	
290	Ef	115	13020#	850#	*		10450	50	*		*		-9710#	820#
	Lv	116	*		4420#	1040#	11000	70	*		340#	880#	*	
291	Ef	115	12820#	1130#	*		10320#	300#	-7810#	980#	*		-9280#	1030#
	Lv	116	13280#	790#	4760#	850#	10890	50	*		*		*	
	Eh	117	*		3440#	1000#	11480#	400#	*		1620#	890#	*	
292	Lv	116	13100#	1040#	*		10774	15	*		*		-11630#	1000#
	Eh	117	*		3900#	940#	11380#	400#	*		2300#	1030#	*	
293	Lv	116	12860#	850#	*		10680	50	-8200#	910#	*		-10980#	890#
	Eh	117	13560#	1000#	4180#	1130#	11290	50	*		*		*	
	Ei	118	*		3090#	930#	11920#	500#	*		3340#	1070#	*	
294	Eh	117	13200#	940#	*		11200	50	*		*		-10420#	960#
	Ei	118	*		3360#	1040#	11840	70	*		1510#	890#	*	
295	Ei	118	13500#	950#	3730#	870#	11700#	200#	*		*		*	

Graphs of separation and decay energies

Figs.	1– 9.	S_{2n}	two-neutron separation energies.
Figs.	10–17.	S_{2p}	two-proton separation energies.
Figs.	18–26.	Q_α	α -decay energies.

Mass numbers and element symbols are indicated only along the borders of the graphs; those for the intermediate points must be derived by enumeration.

Points represent experimental values.

Open circles represent values estimated from TMS (see Part I, p. 030002-9).

Lines connect points for isotopes (S_{2n}, Q_α) or isotones (S_{2p}).

Other types of graphs are available from the AMDC web-site (see text).

Fig. 1. Two-neutron separation energies $N = 0$ to 25

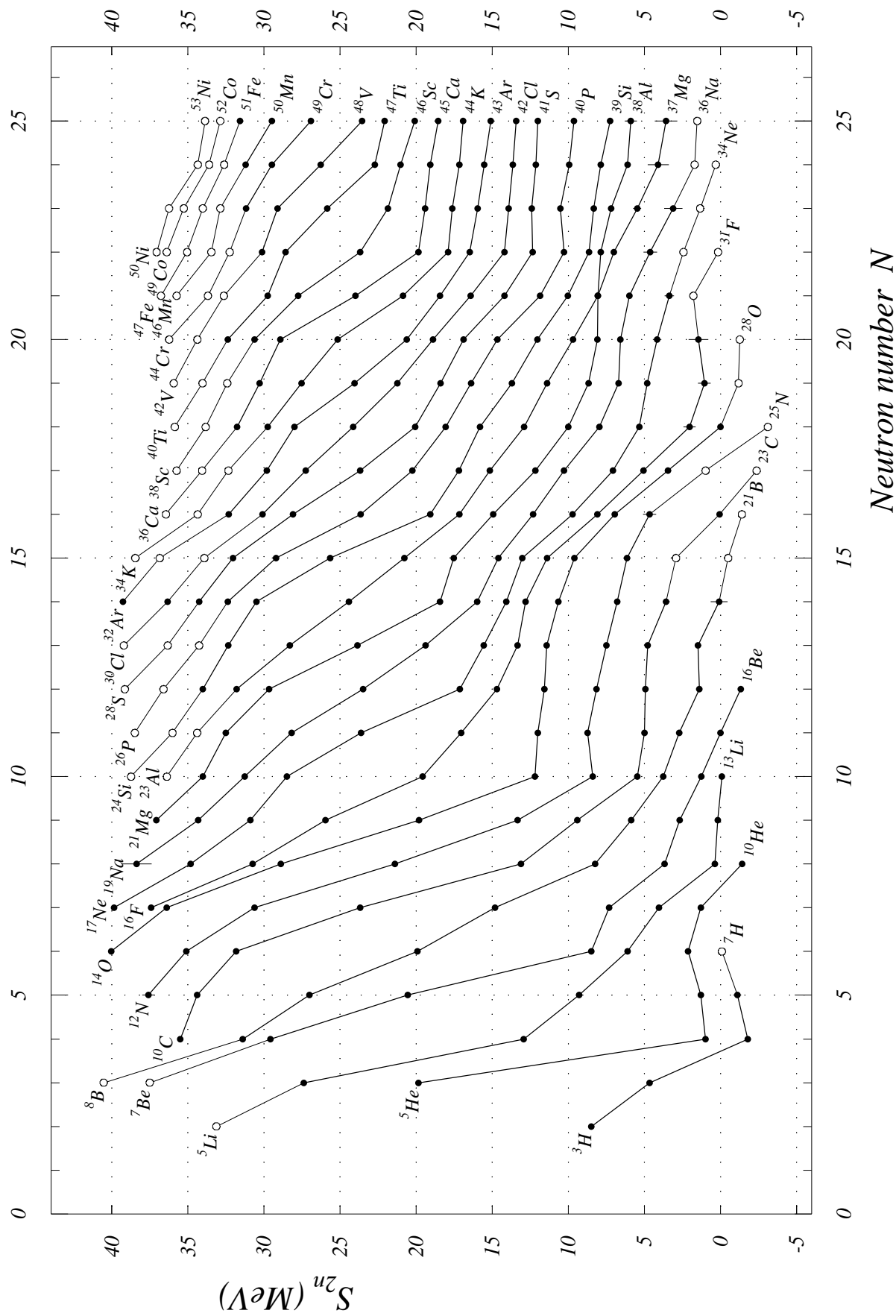

Fig. 2. Two-neutron separation energies $N = 22$ to 45

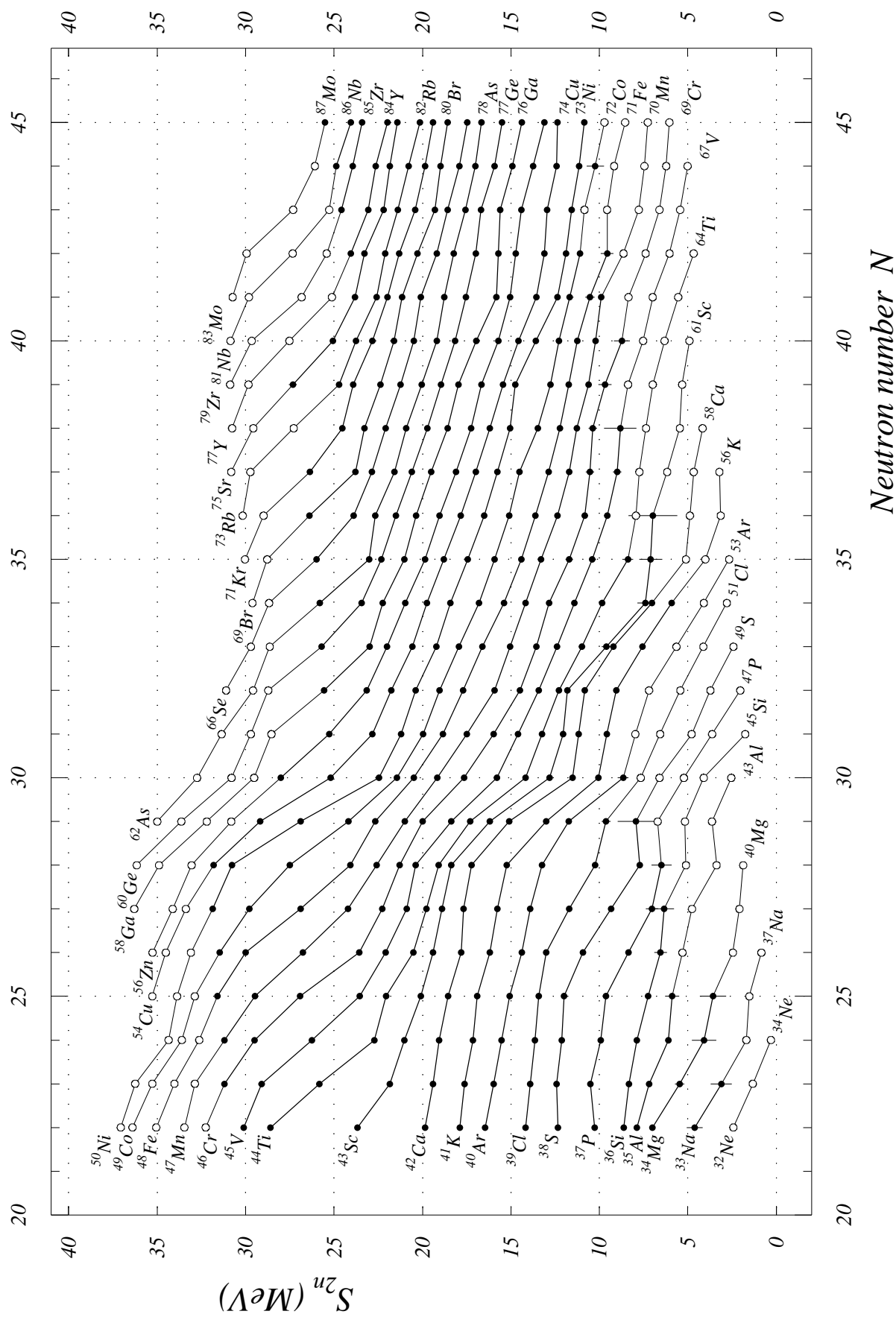

Fig. 3. Two-neutron separation energies $N = 42$ to 65

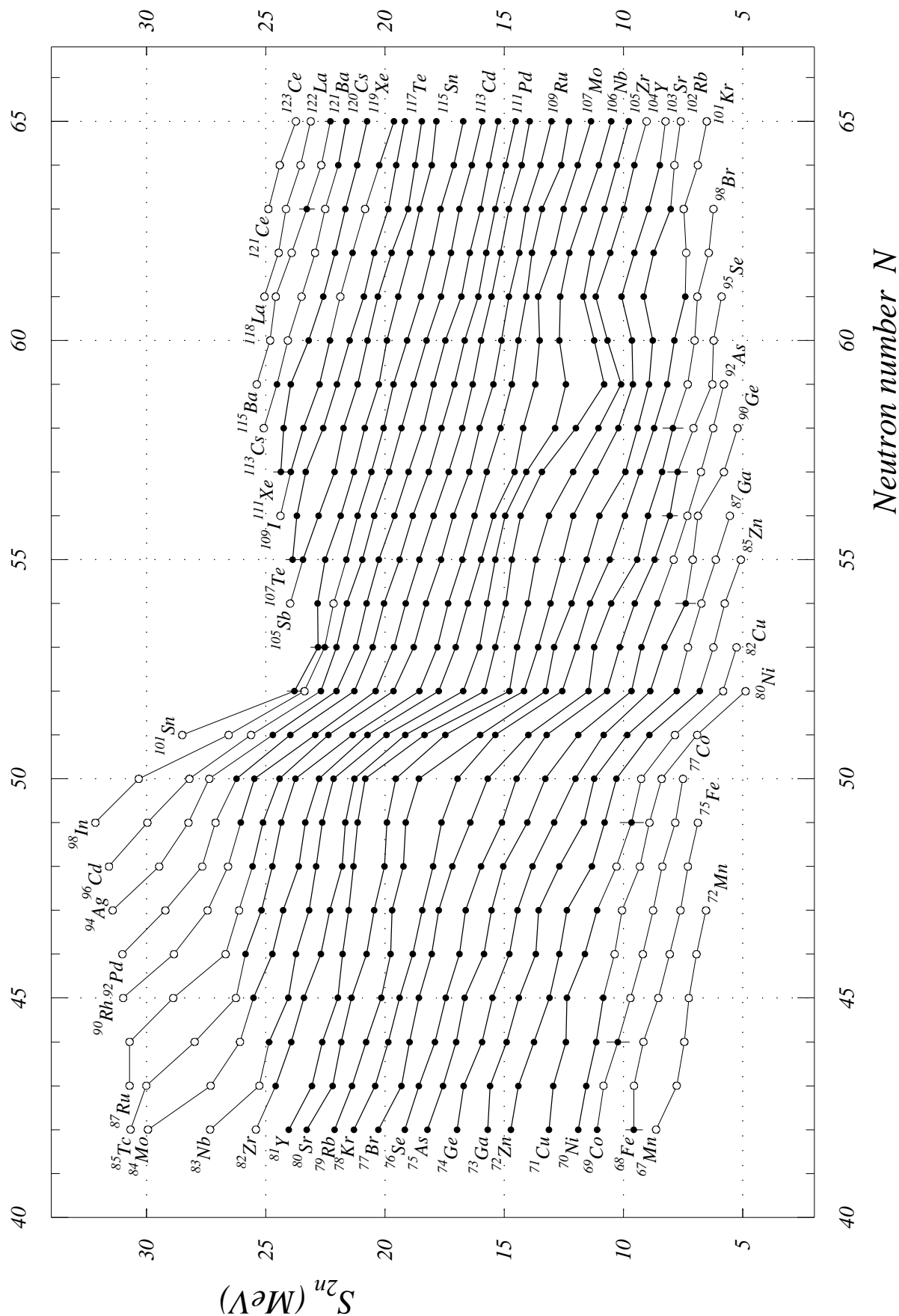

Fig. 4. Two-neutron separation energies $N = 62$ to 85

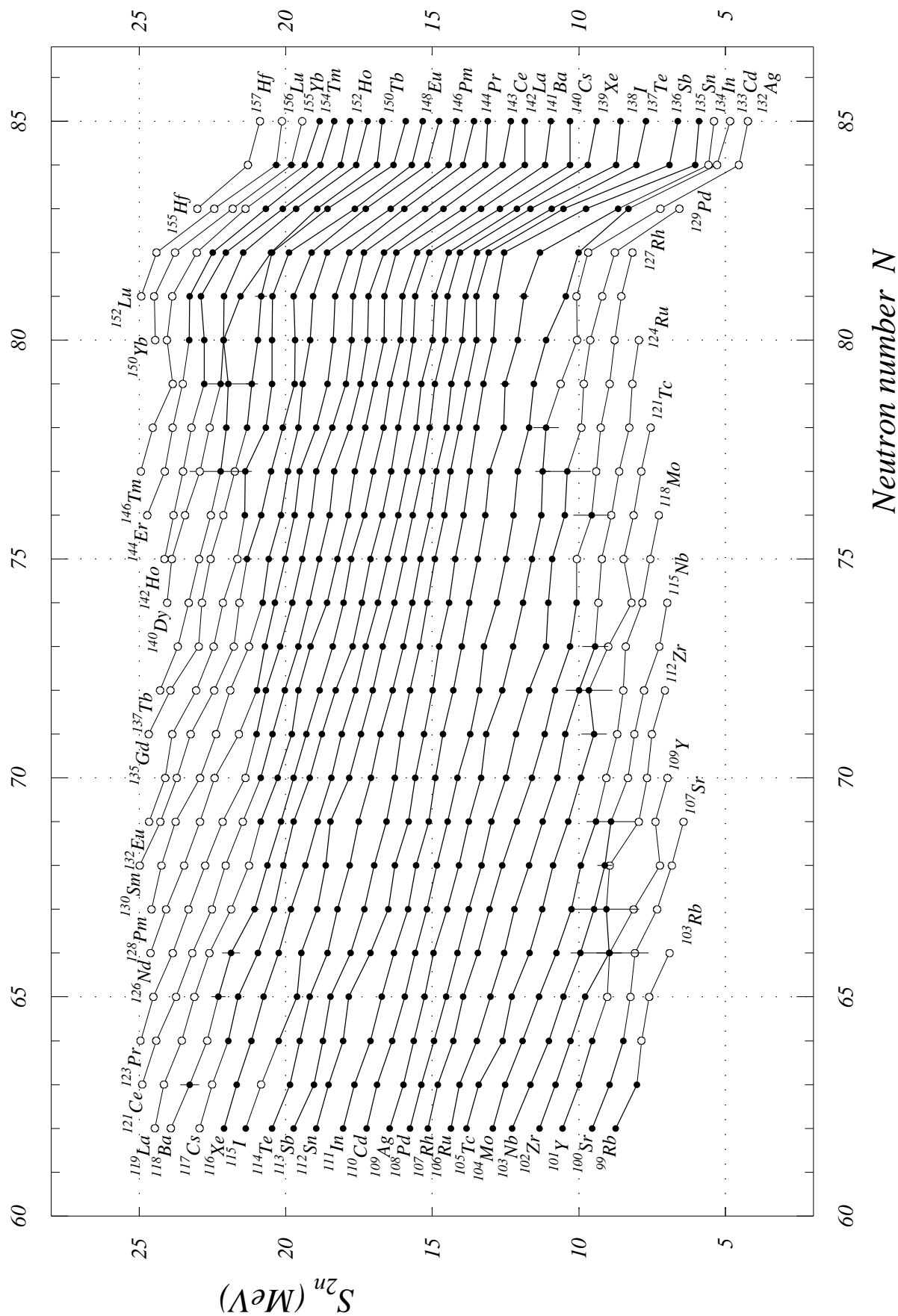

Fig. 5. Two-neutron separation energies $N = 82$ to 105

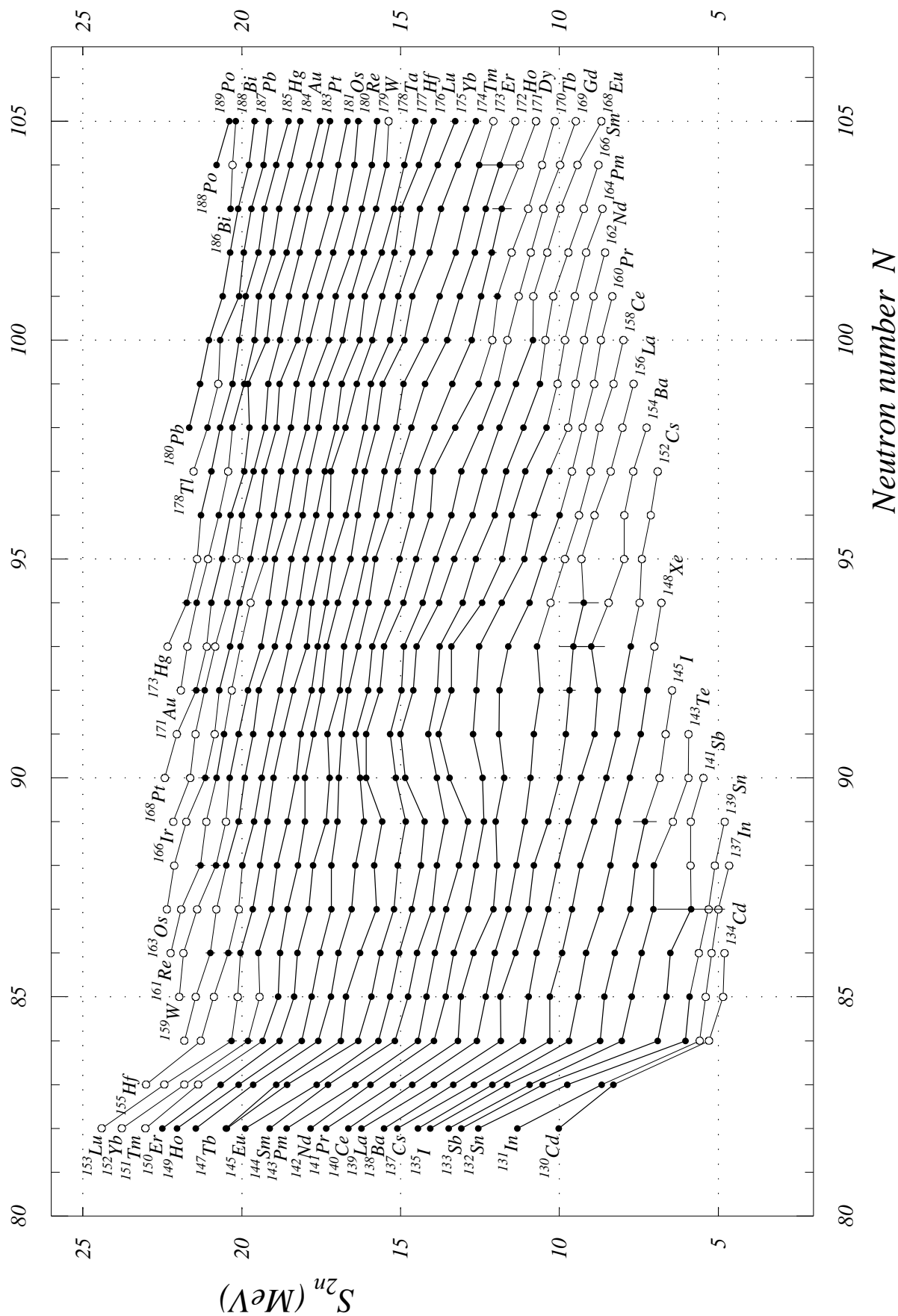

Fig. 6. Two-neutron separation energies $N = 102$ to 125

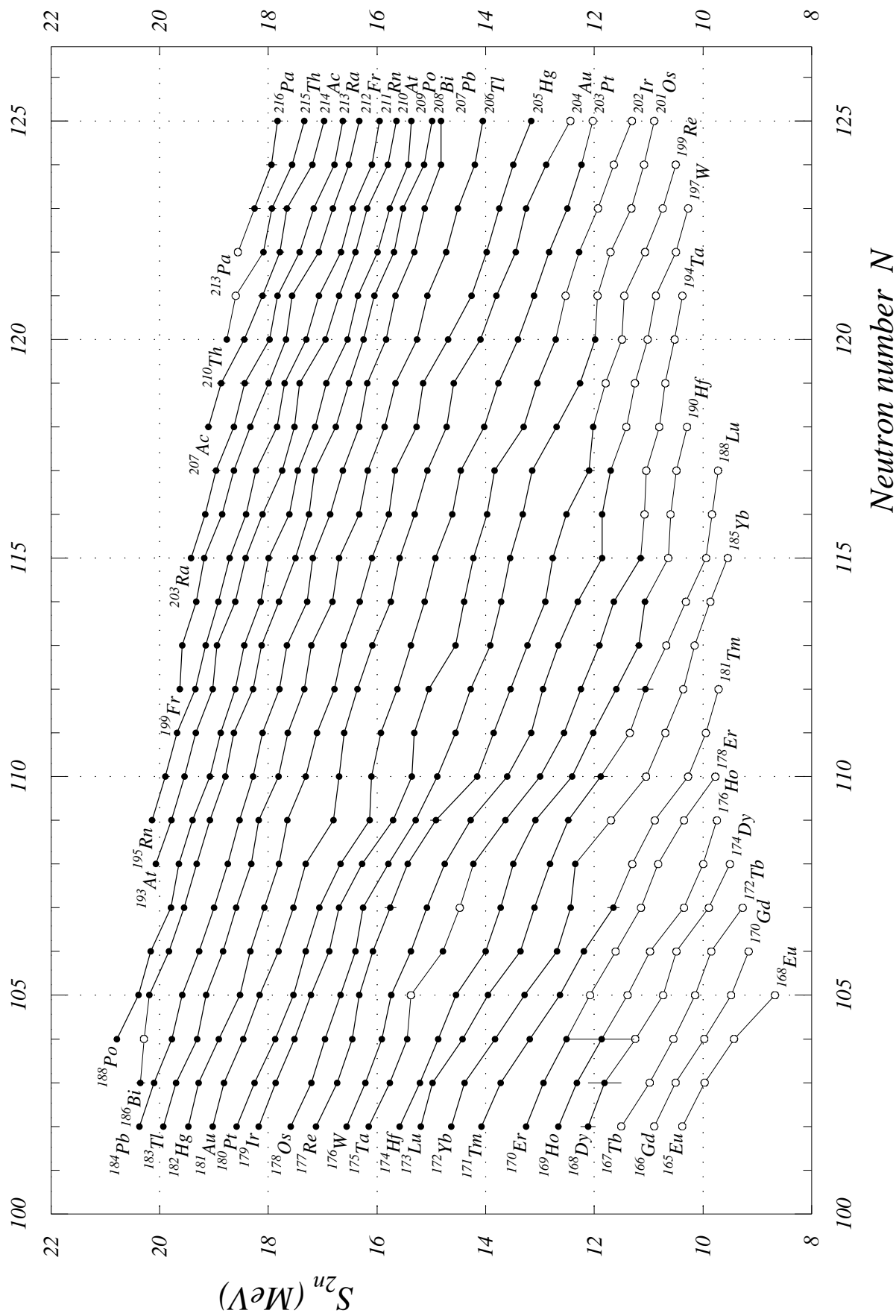

Fig. 7. Two-neutron separation energies $N = 122$ to 145

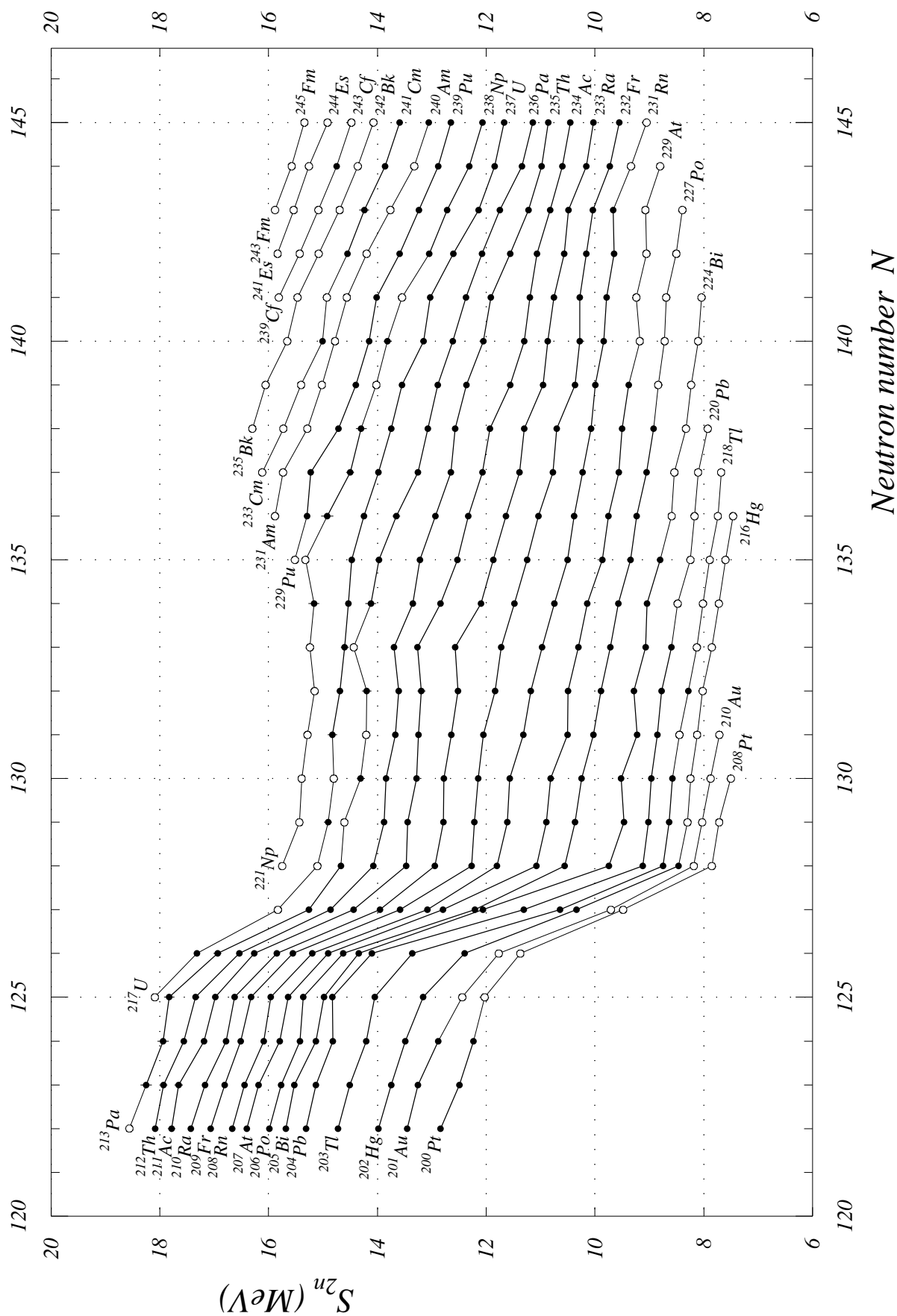

Fig. 8. Two-neutron separation energies $N = 142$ to 165

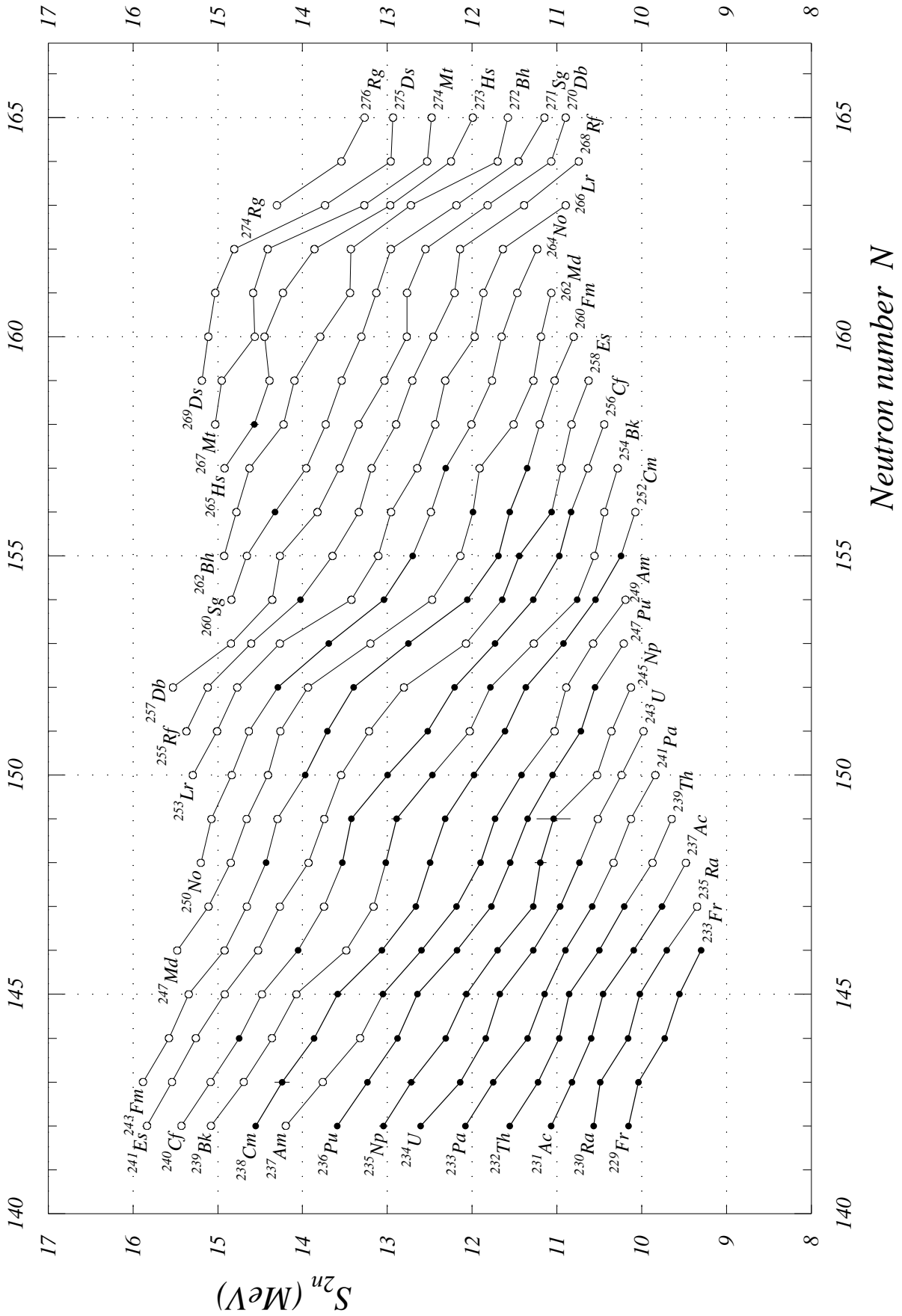

Fig. 9. Two-neutron separation energies $N = 155$ to 178

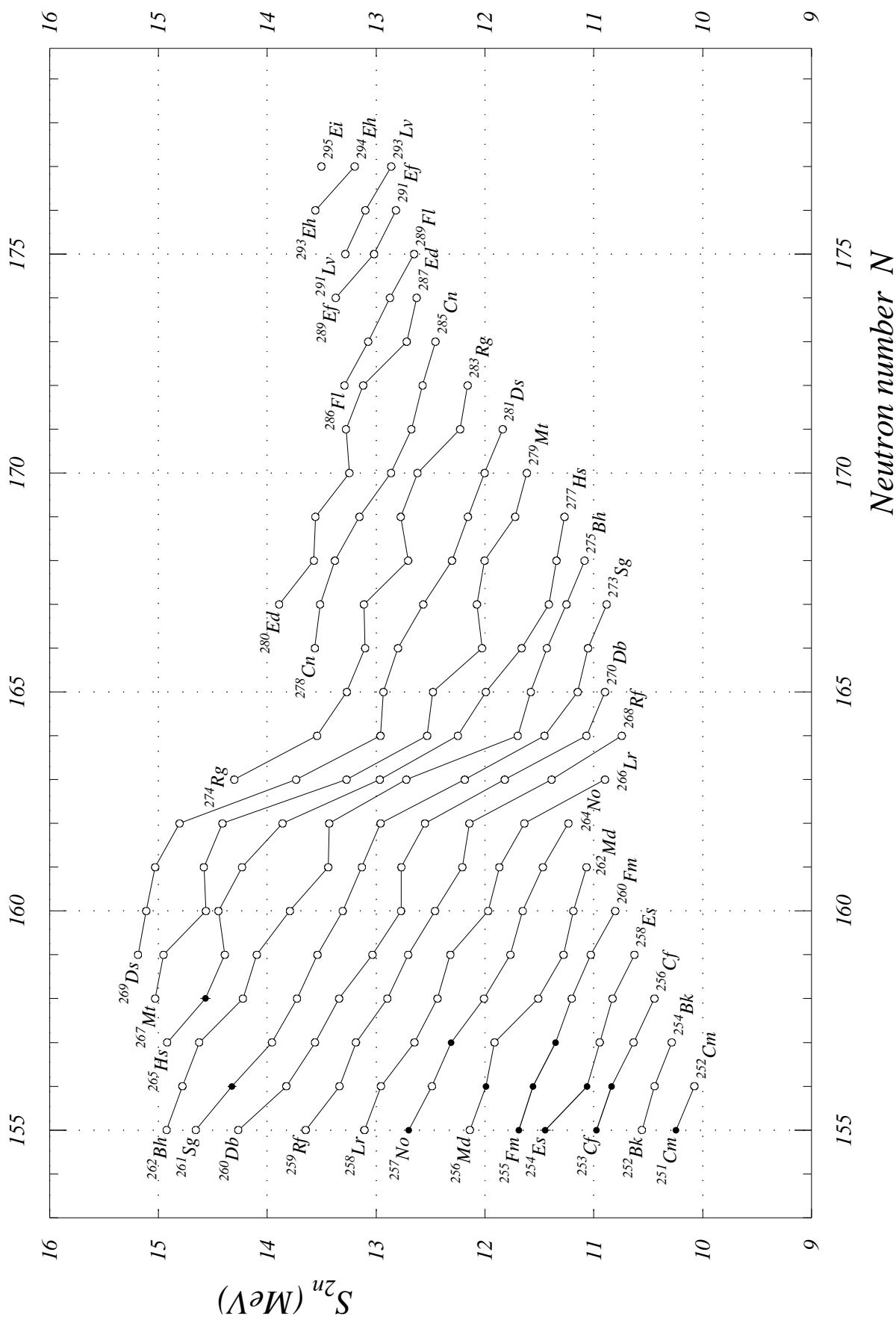

Fig. 10. Two-proton separation energies $Z = 0$ to 20

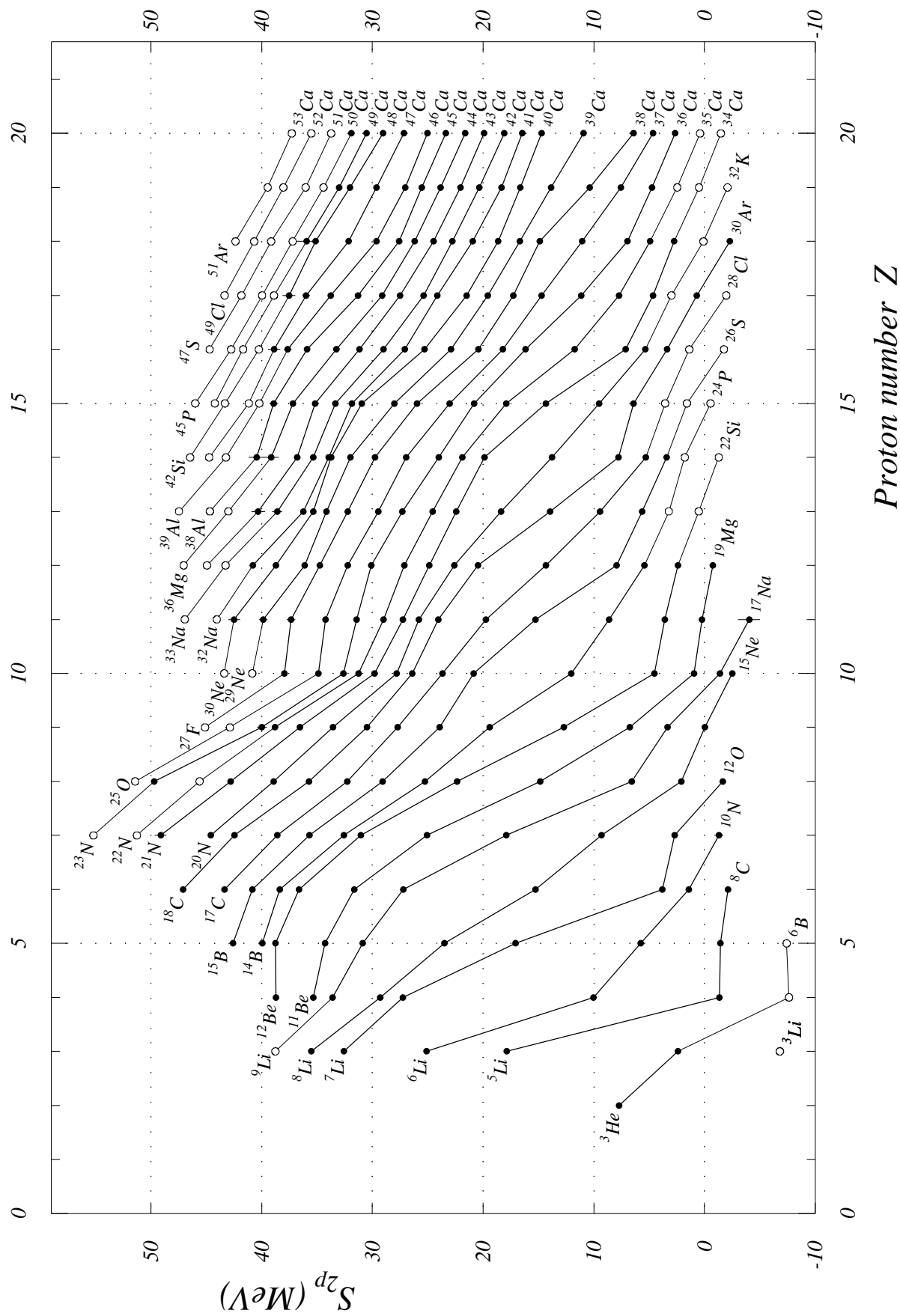

Fig. 11. Two-proton separation energies $Z = 17$ to 35

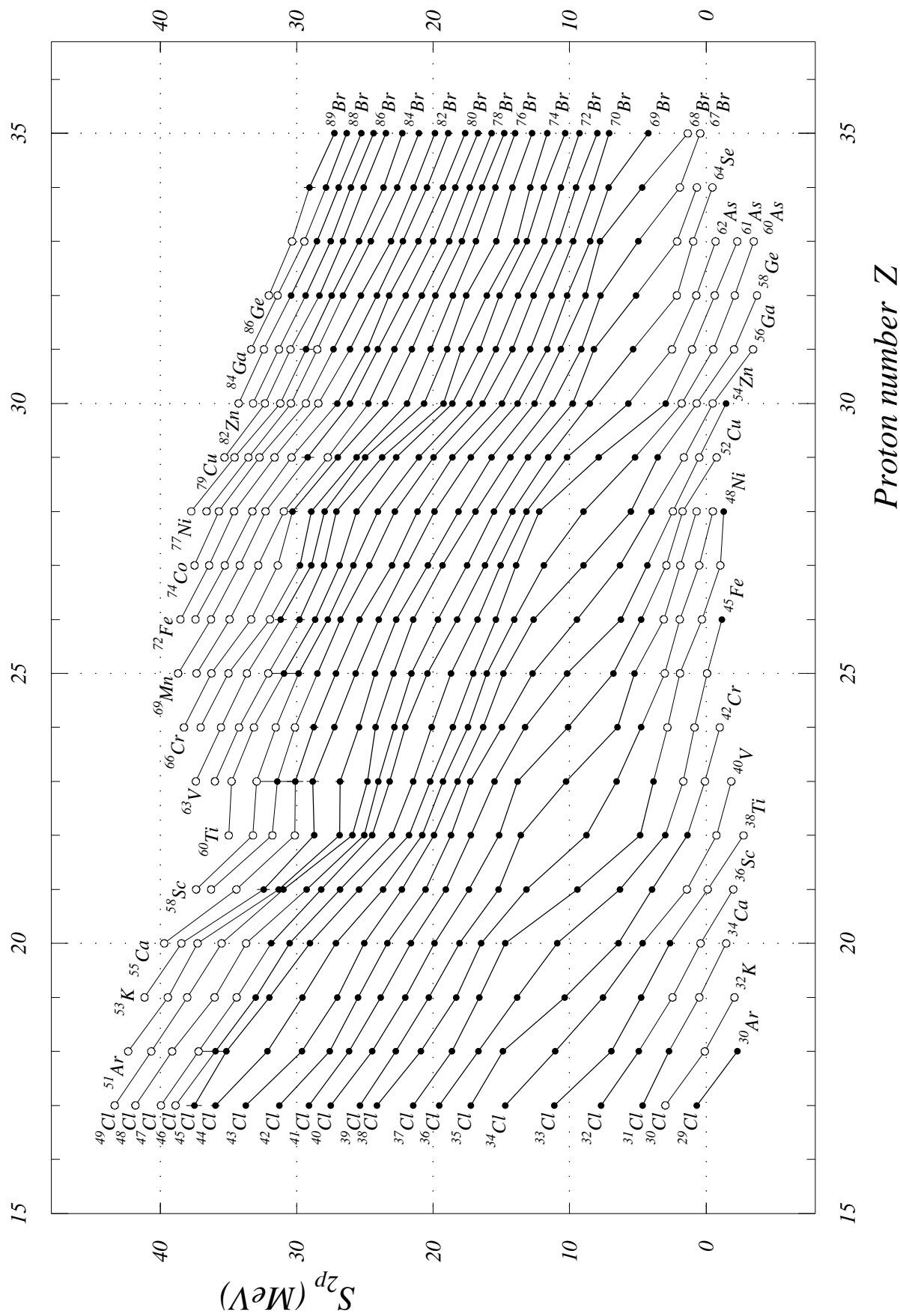

Fig. 12. Two-proton separation energies $Z = 32$ to 50

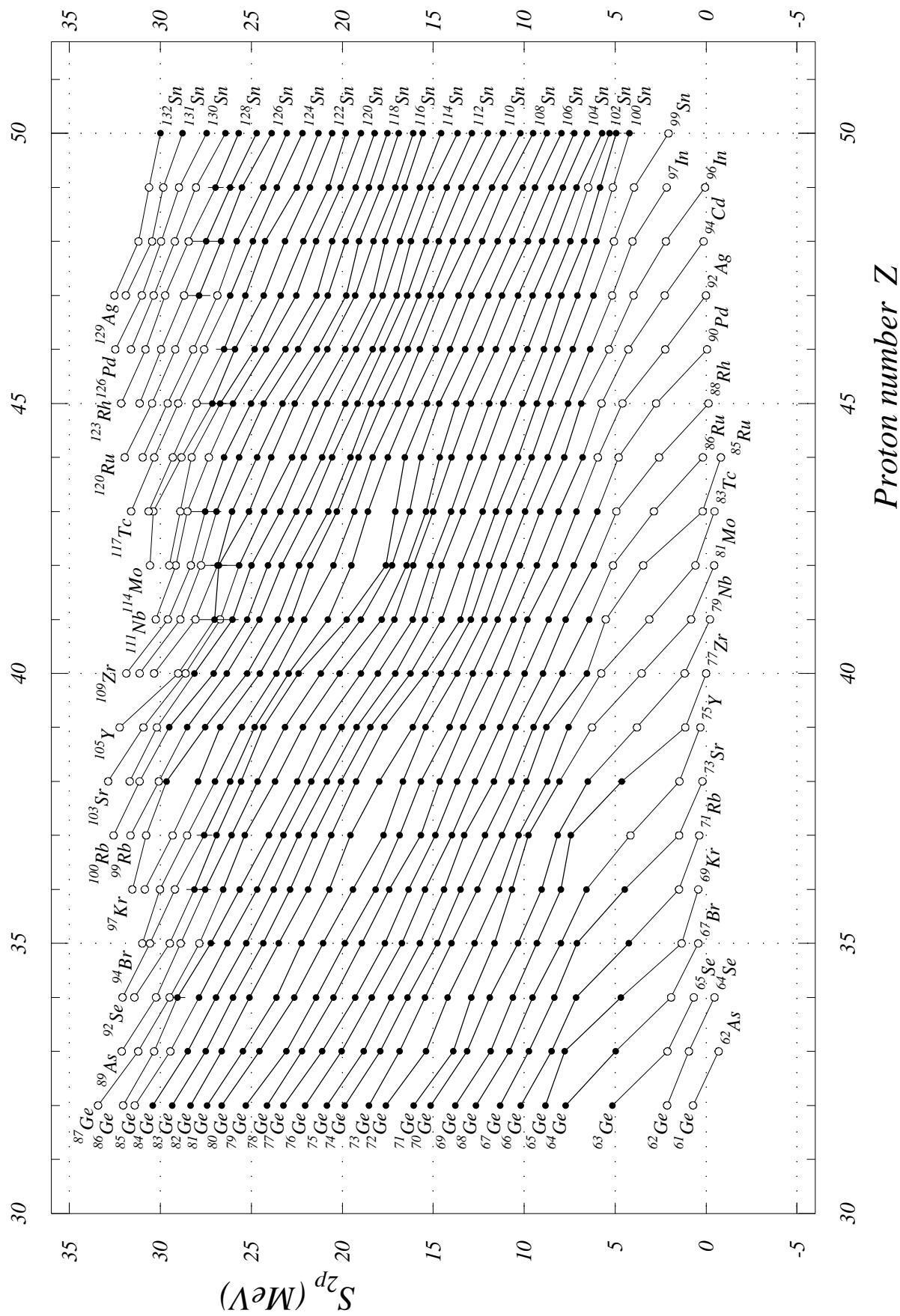

Fig. 13. Two-proton separation energies $Z = 47$ to 65

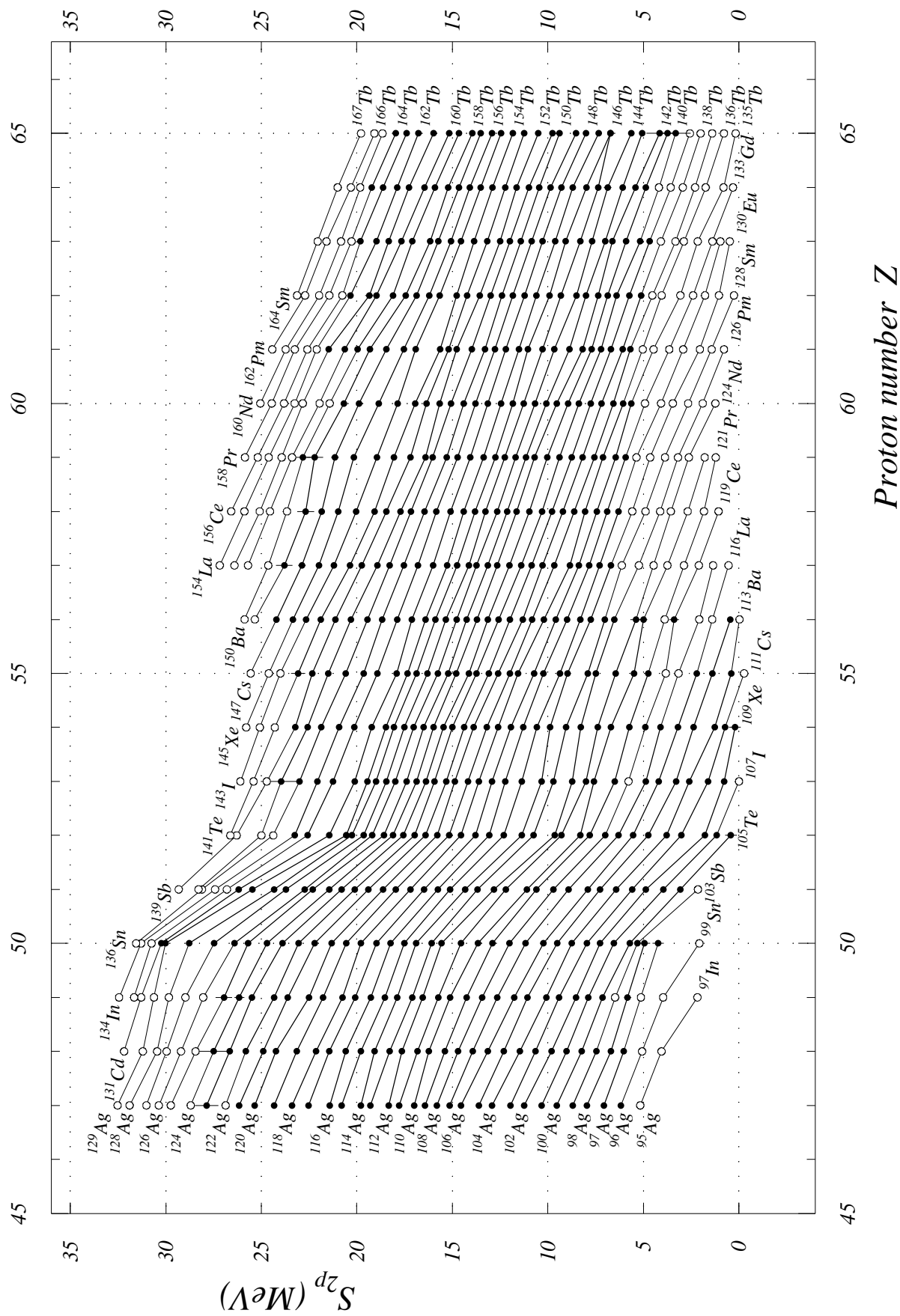

Fig. 14. Two-proton separation energies $Z = 62$ to 80

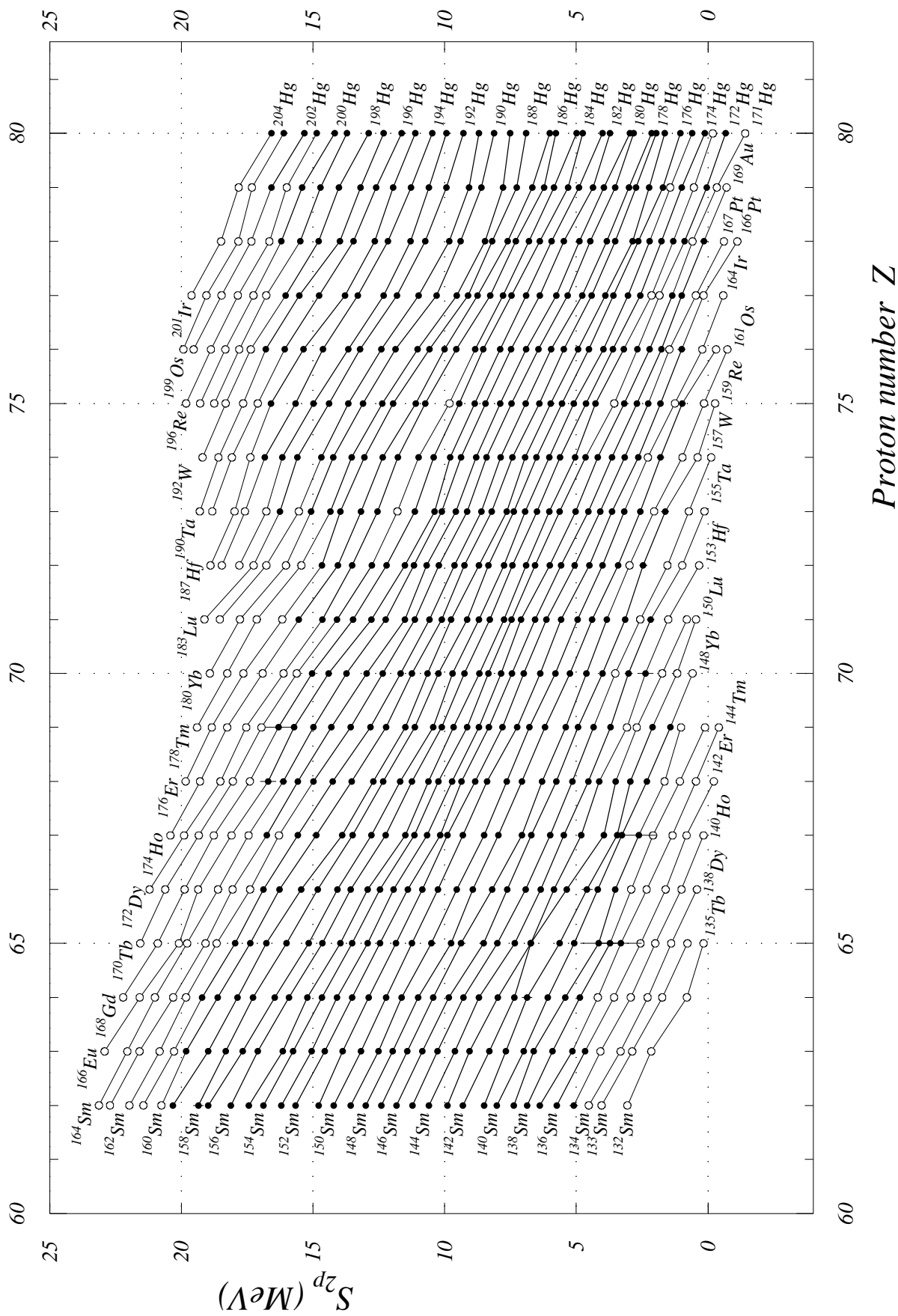

Fig. 15. Two-proton separation energies $Z = 77$ to 95

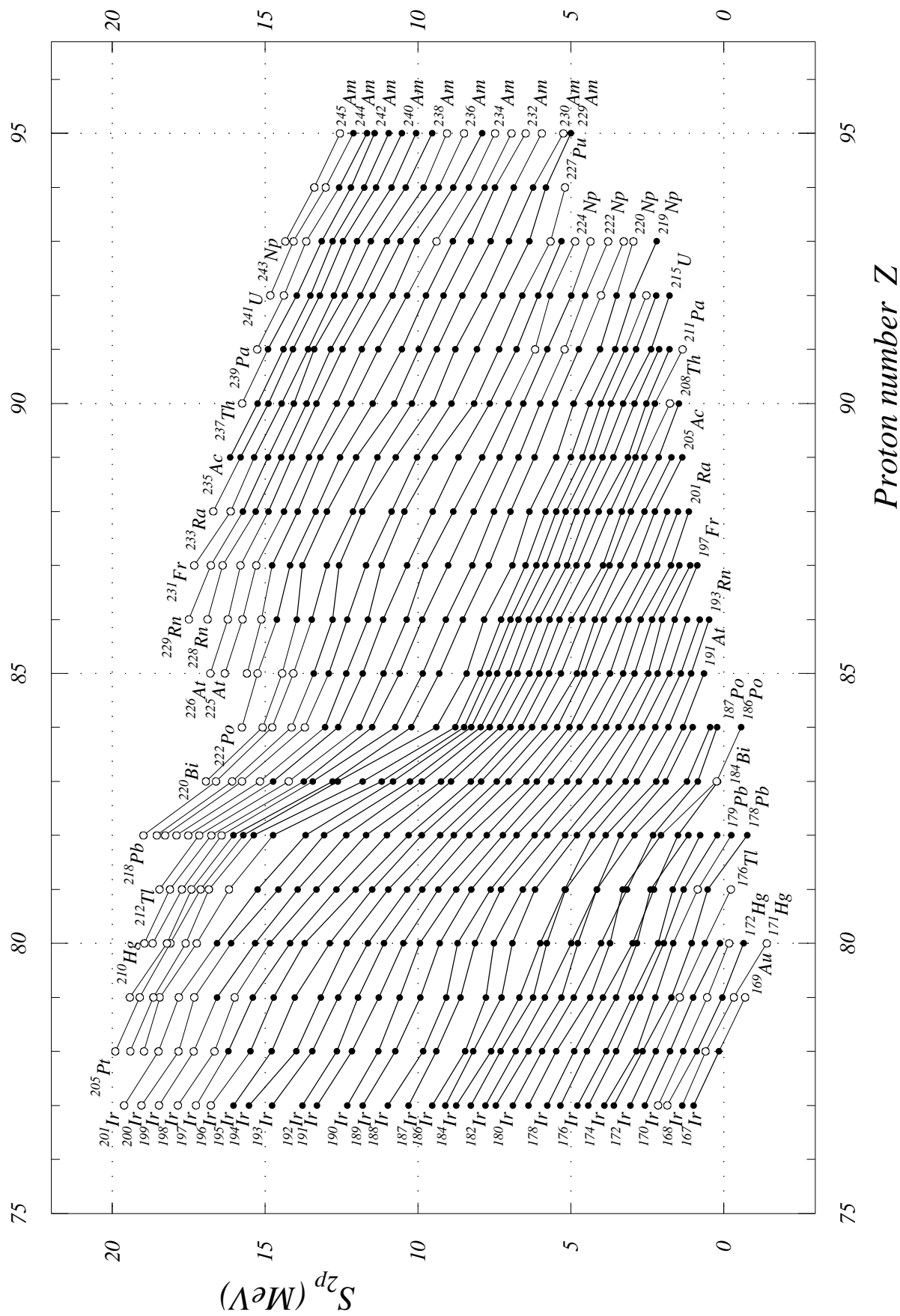

Fig. 16. Two-proton separation energies $Z = 92$ to 110

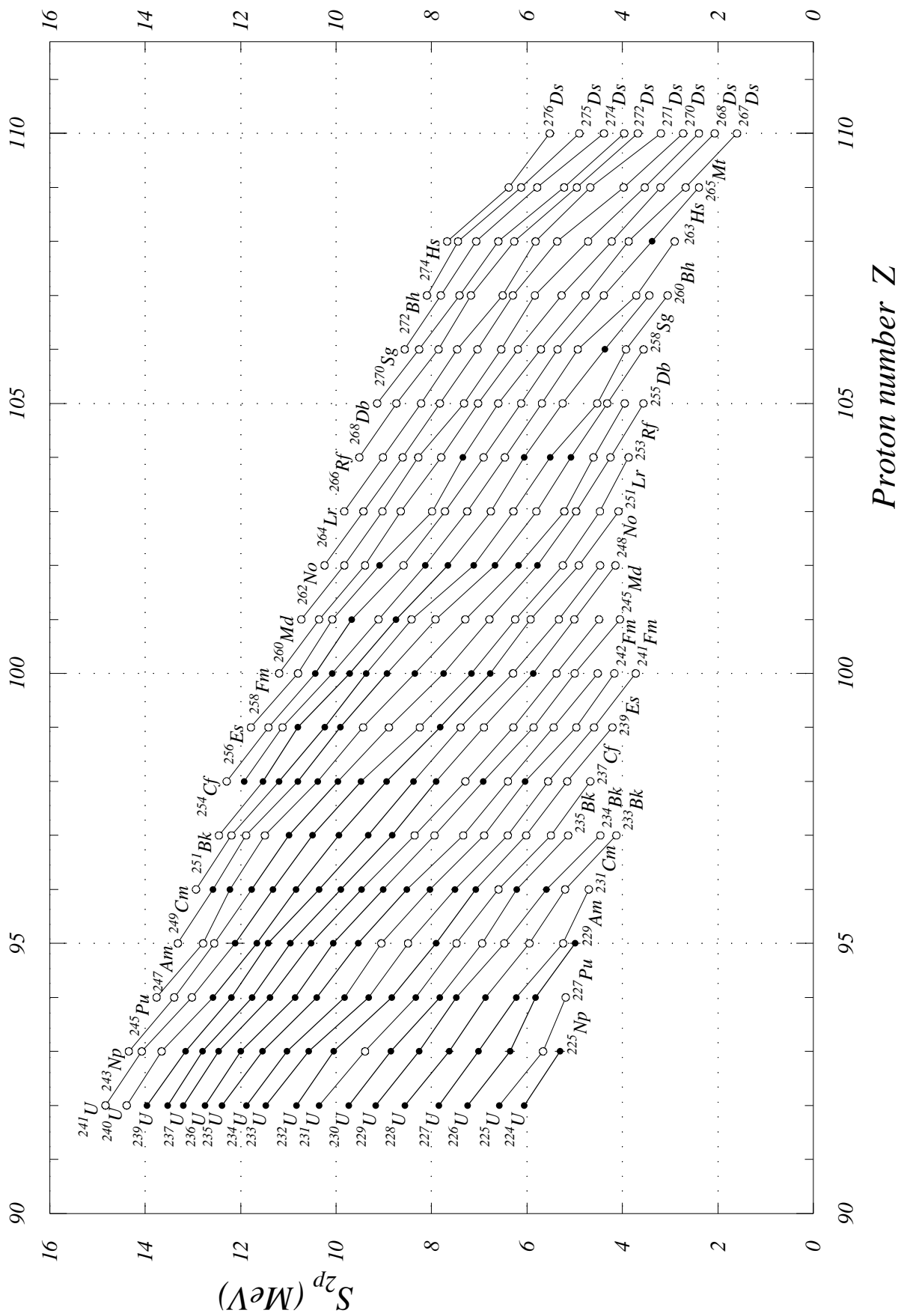

Fig. 17. Two-proton separation energies $Z = 100$ to 118

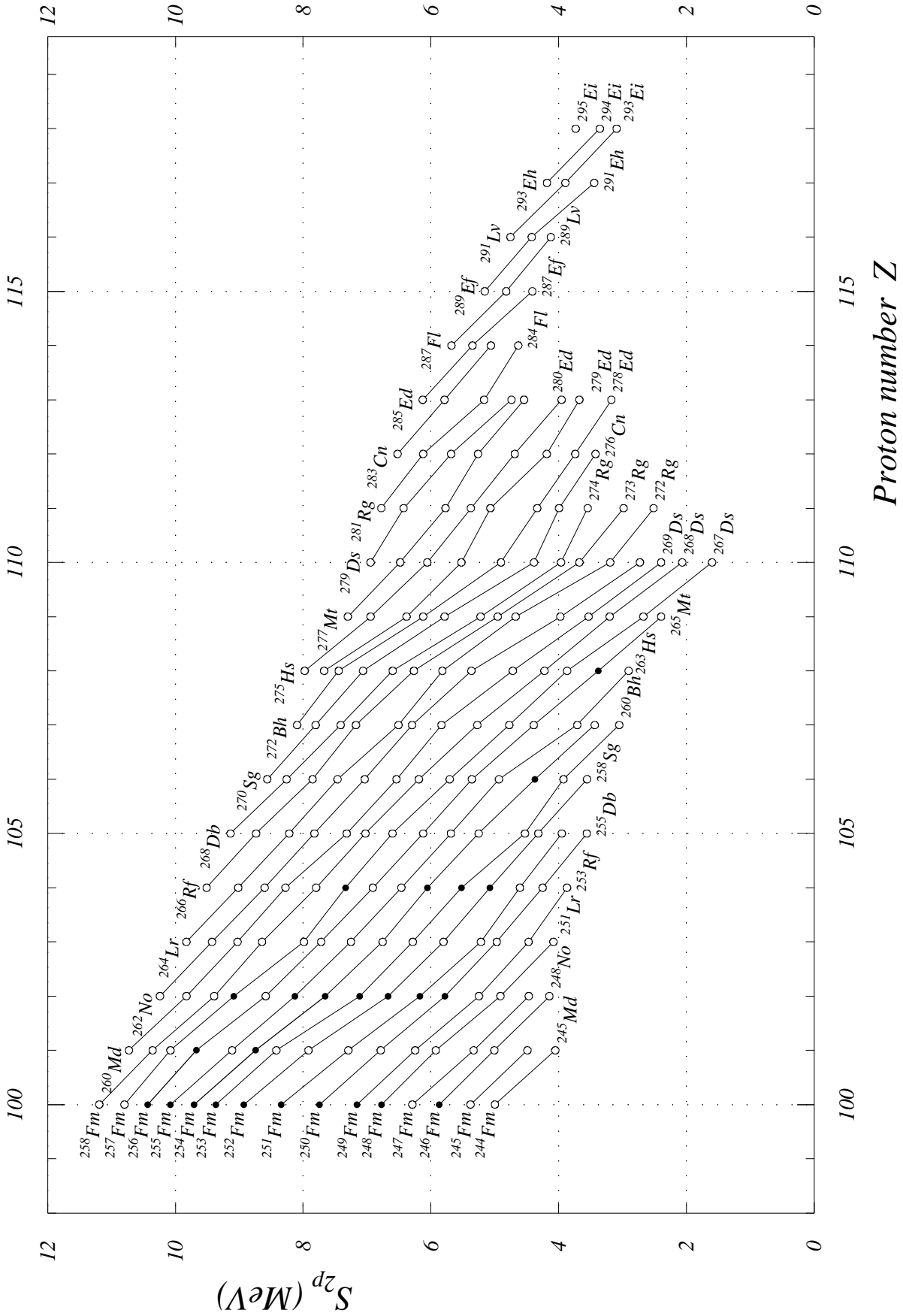

Fig. 18. α -decay energies $N = 0$ to 25

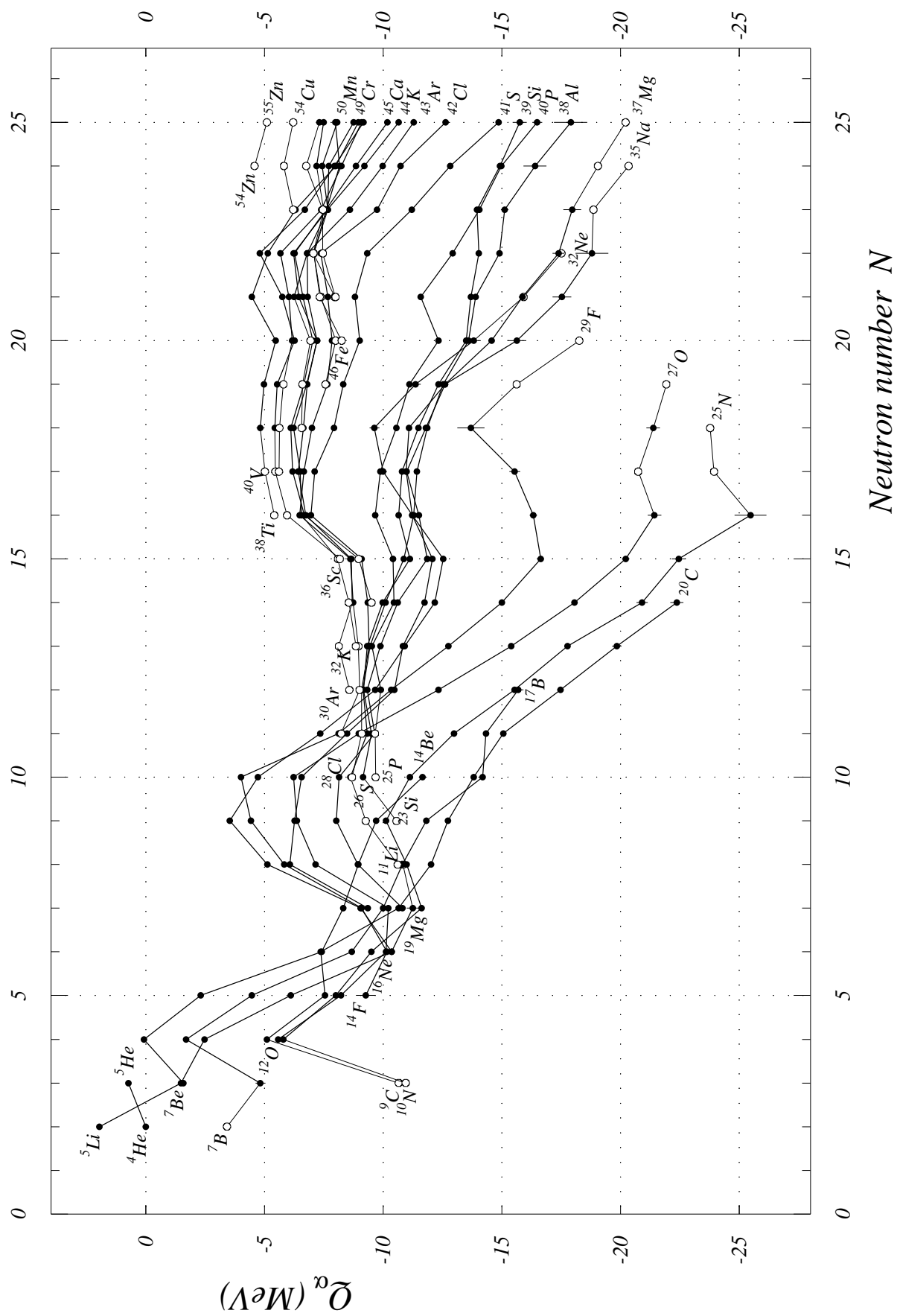

Fig. 19. α -decay energies $N = 22$ to 45

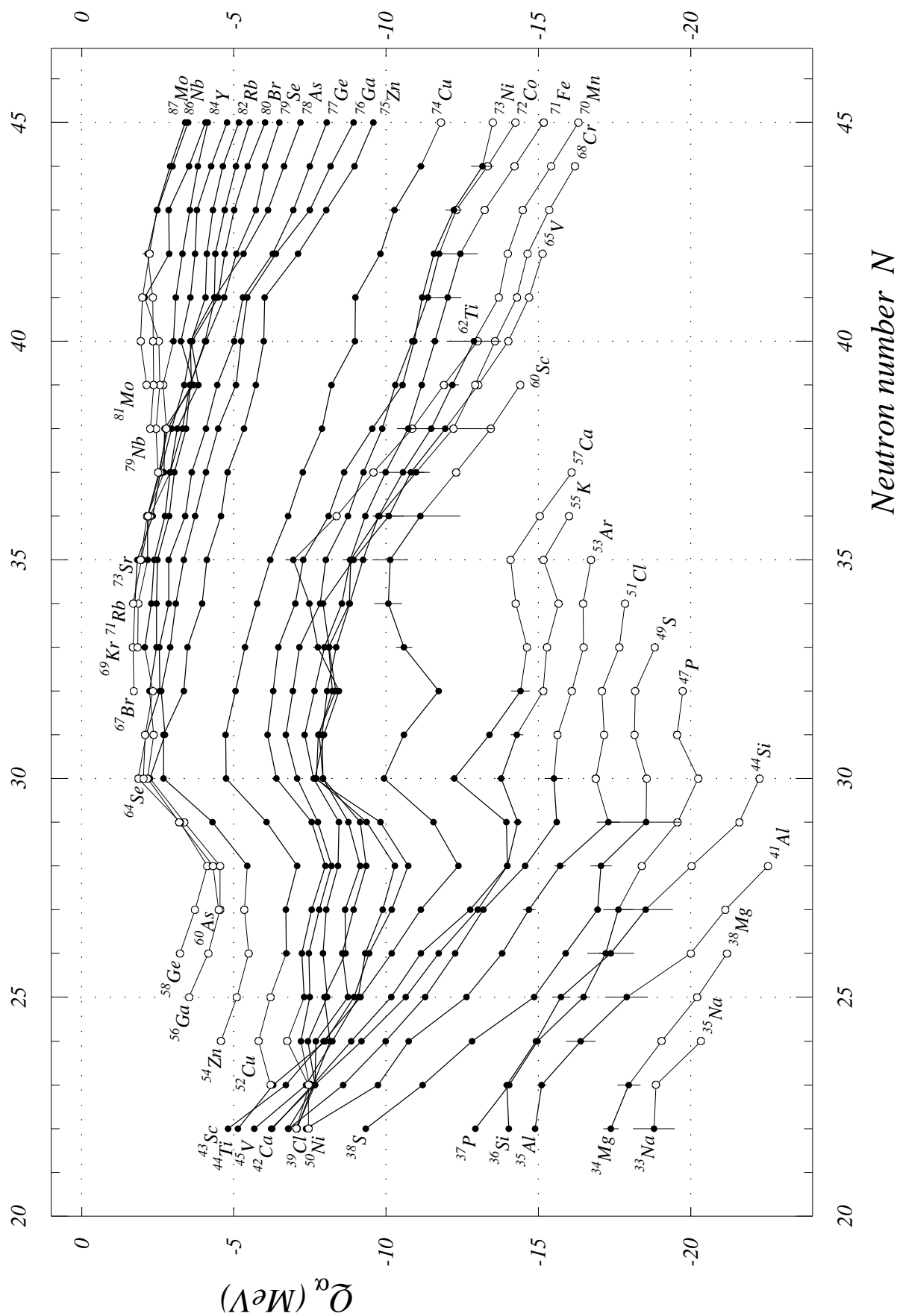

Fig. 20. α -decay energies $N = 42$ to 65

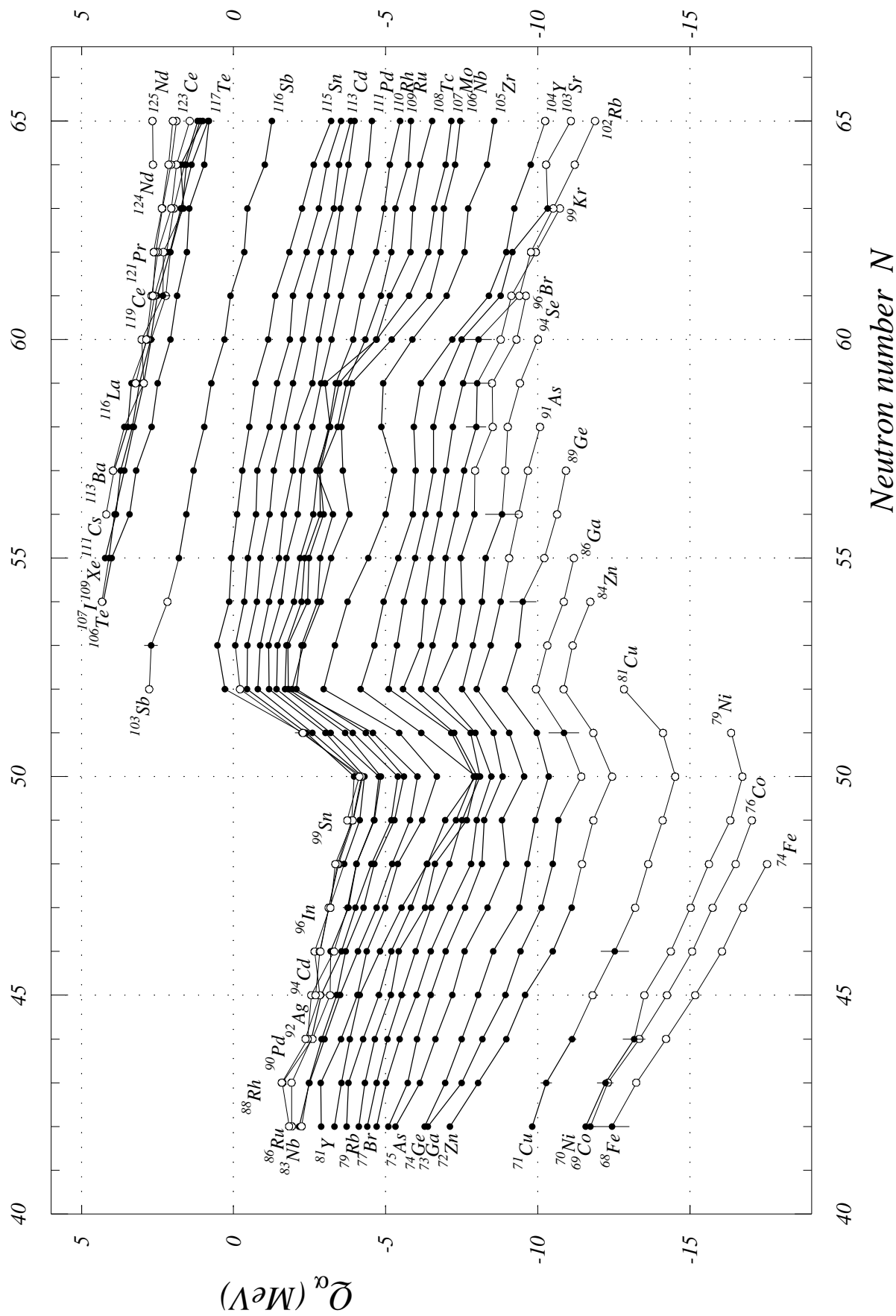

Fig. 21. α -decay energies $N = 62$ to 85

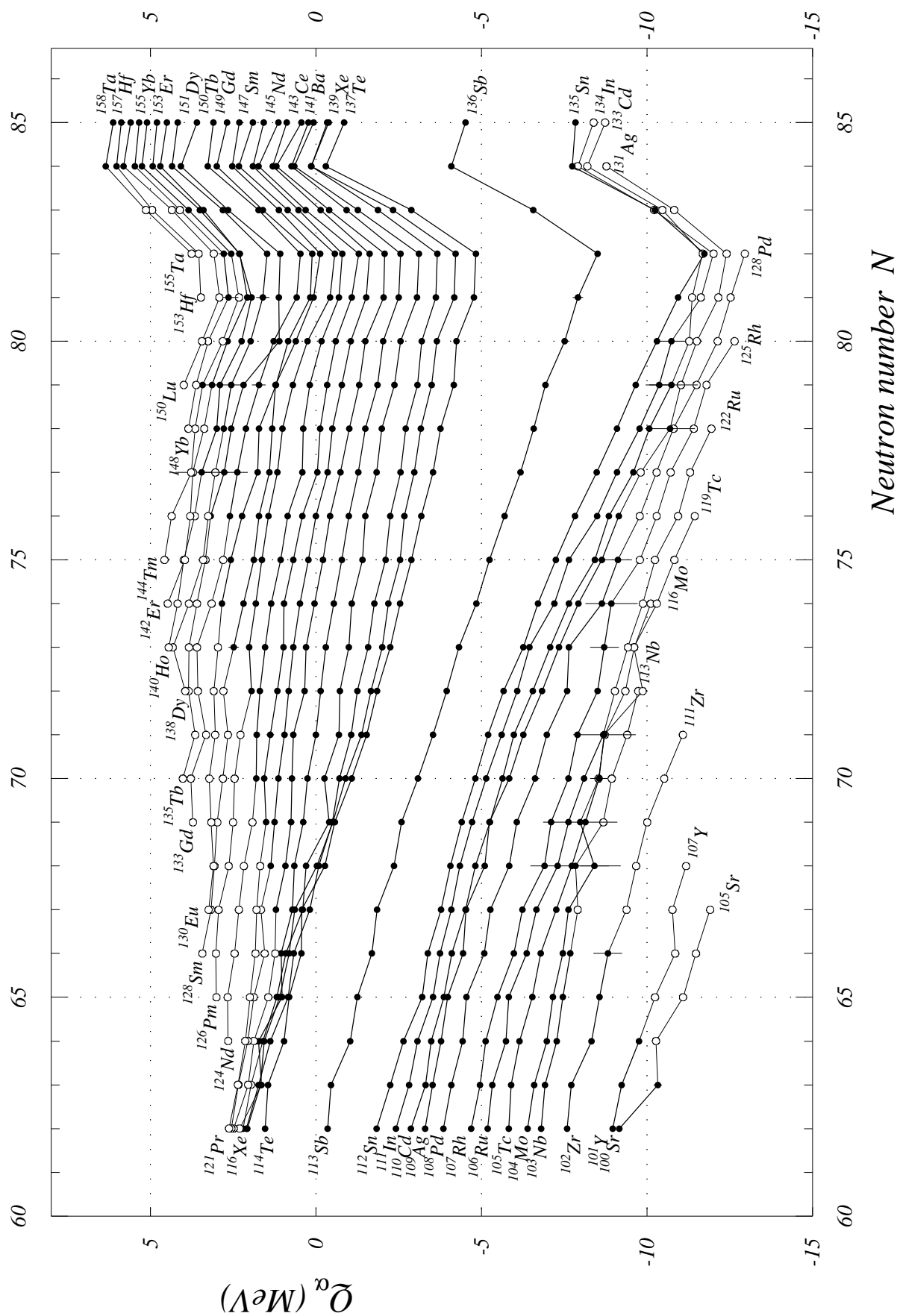

Fig. 22. α -decay energies $N = 82$ to 105

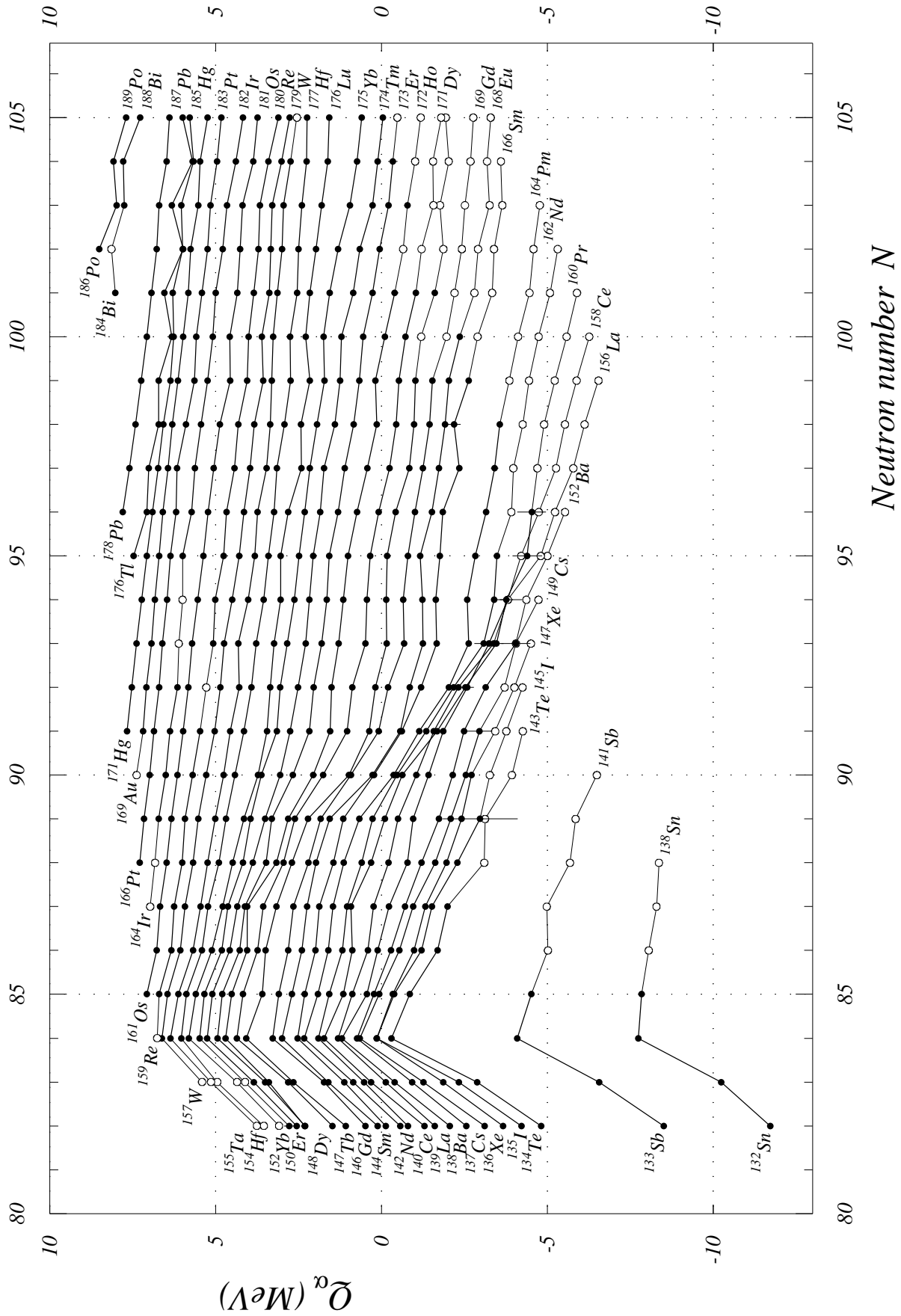

Fig. 23. α -decay energies $N = 102$ to 125

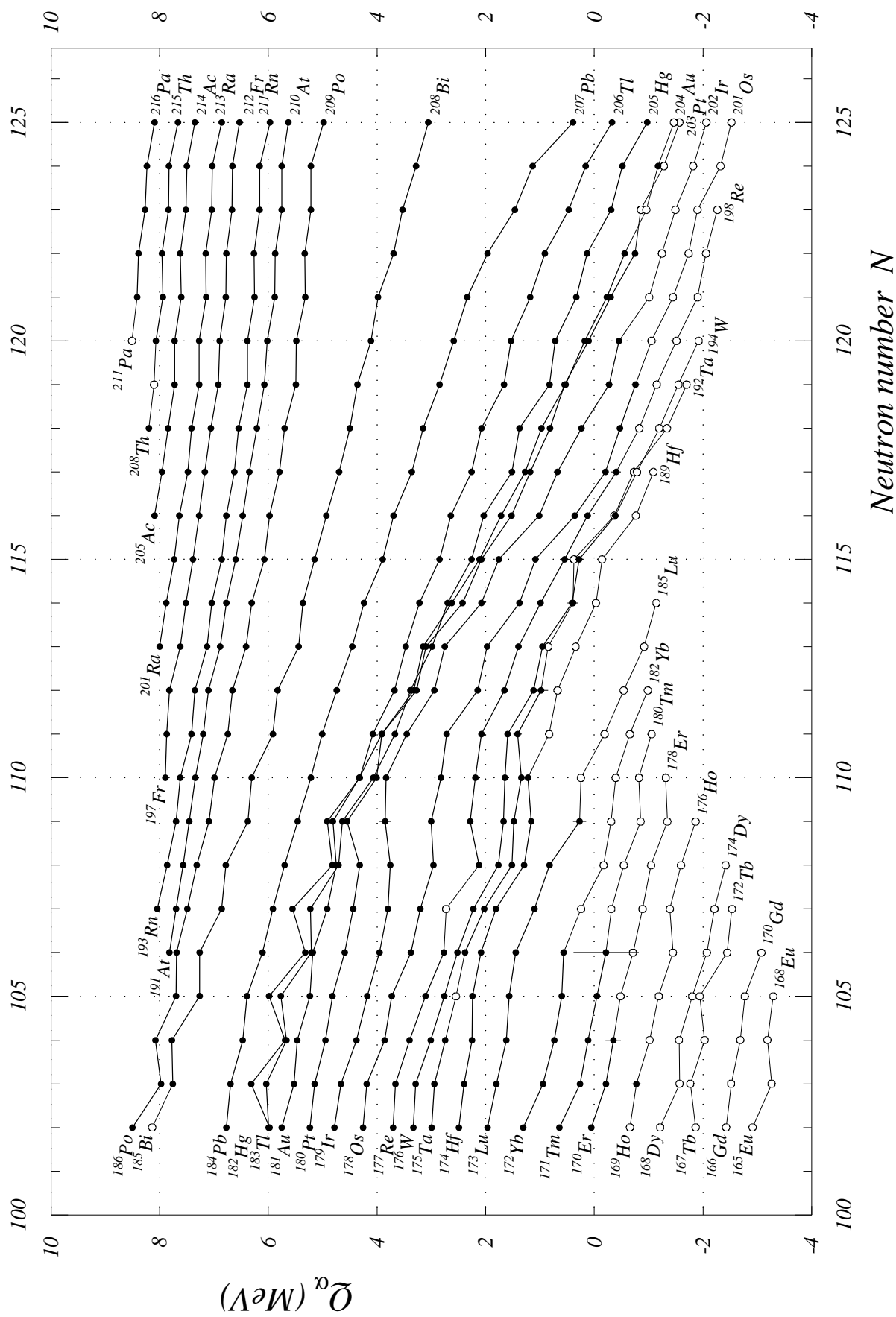

Fig. 24. α -decay energies $N = 122$ to 145

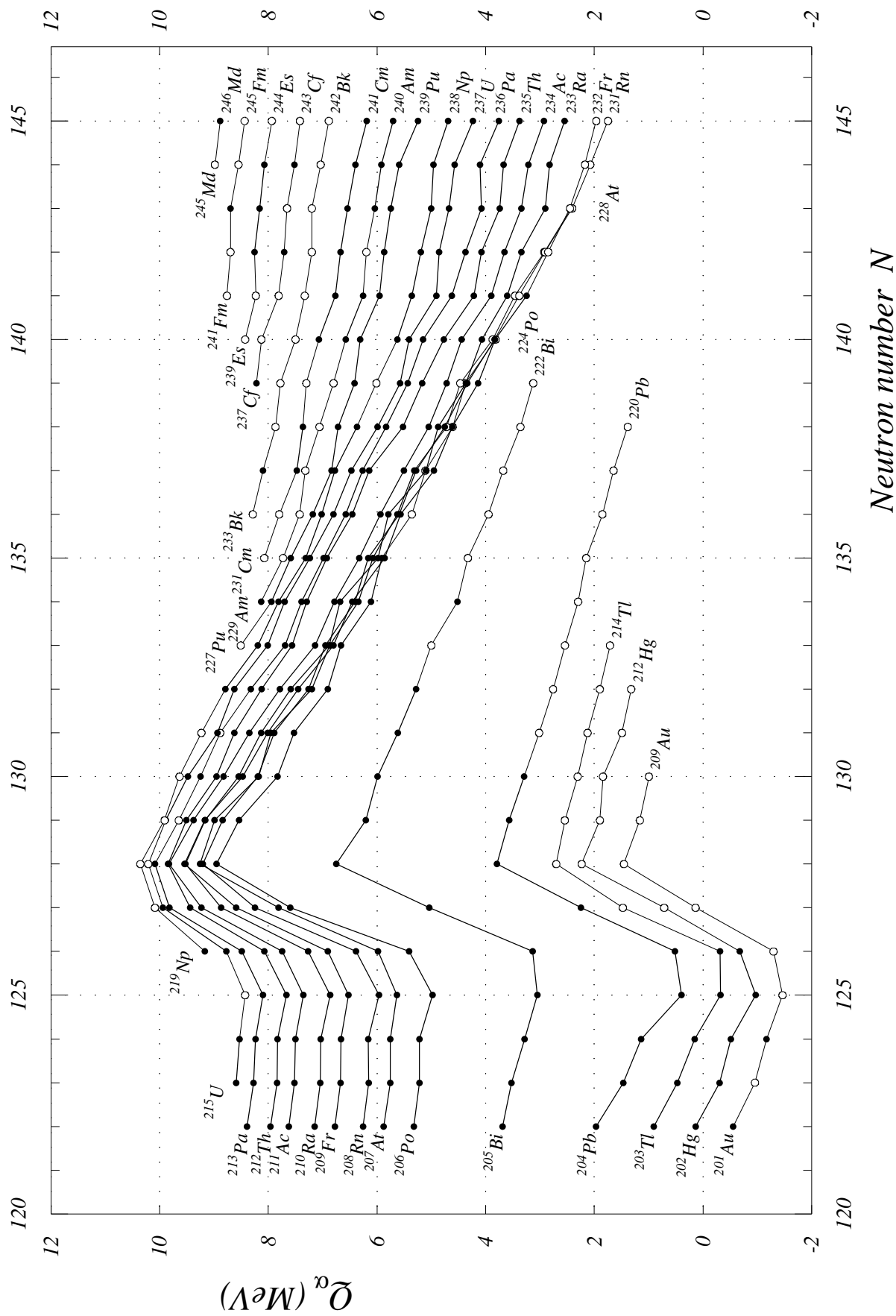

Fig. 25. α -decay energies $N = 142$ to 165

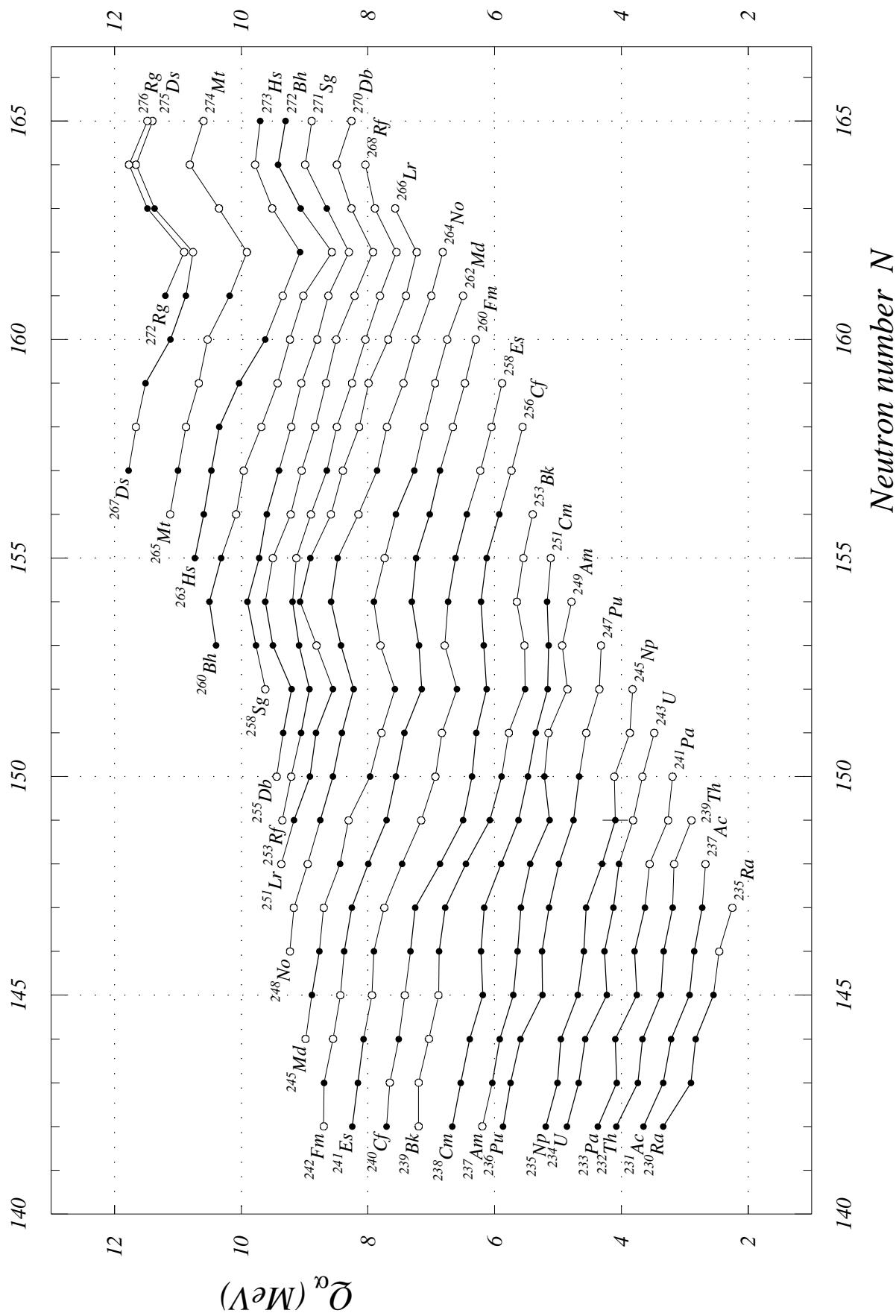
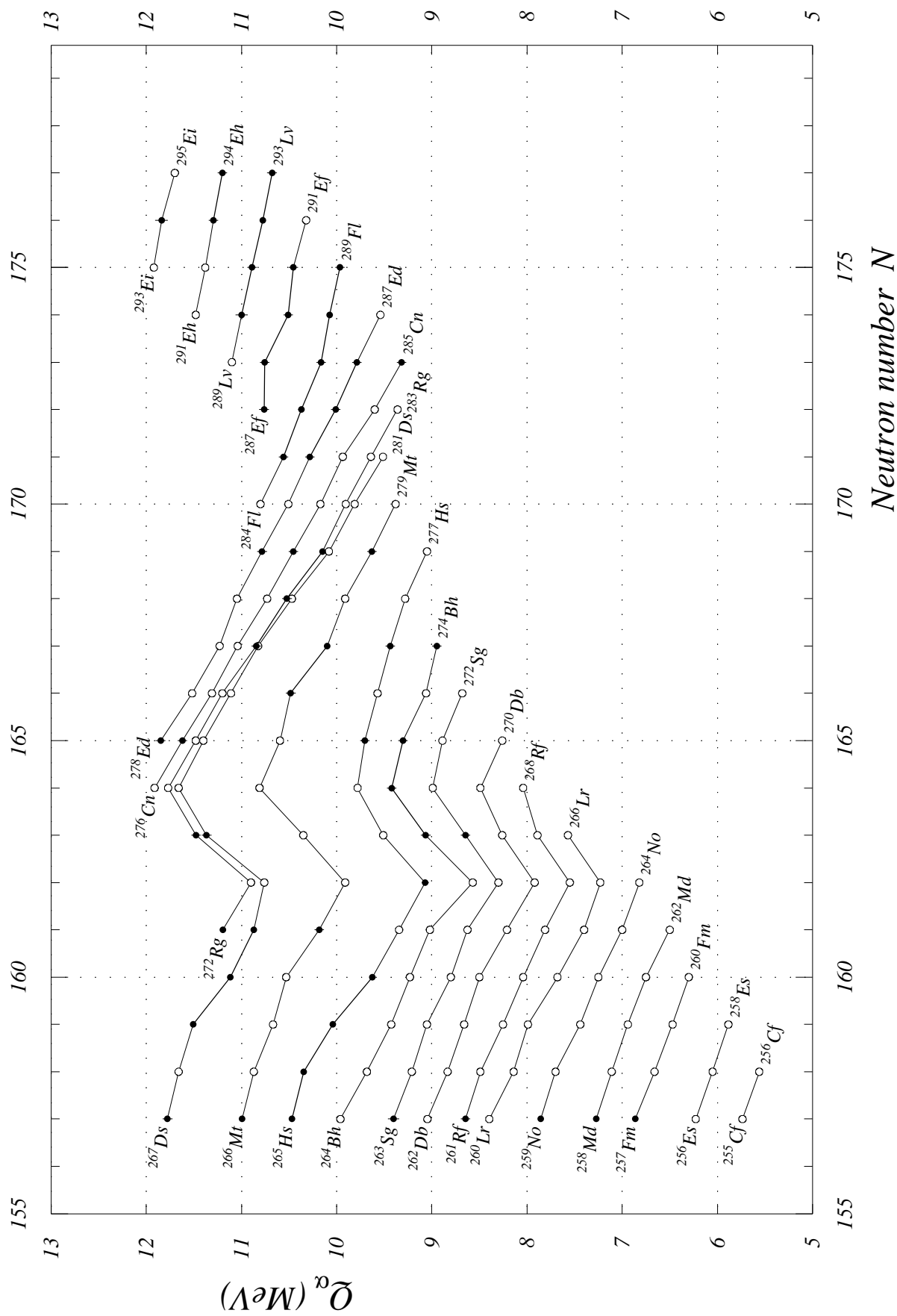

Fig. 26. α -decay energies $N = 157$ to 178



References used in the AME2016 and the NUBASE2016 evaluations

REGULAR JOURNALS (CODEN identifiers) AND BOOKS

AAFP		Annales Academiae Scientiarum Fennicae, series A VI (Finland)
ADNDA		Atomic Data and Nuclear Data Tables (Elsevier, USA)
AENGA		Atomnaya Energiya (Russia)
AFYSA	1950-70	Arkiv för Fysik (Sweden)
ANPHA		Annales de Physique (France)
ANPYA		Annalen der Physik (Germany,DR)
APAHA		Acta Physica Academiae Scientiarum Hungaricae
APASA		Acta Physica Austriaca
APJLA		Astrophysical Journal Letters
APOBB	1970-...	Acta Physica Polonica Section B
APPOA	...-1969	Acta Physica Polonica
ARISE	1986-92	International Journal of Radiation Applications and Instrumentation - Part A - Applied Radiation and Isotopes (Great Britain)
ARISE	1993-...	Applied Radiation and Isotopes (Elsevier)
ATKEA		Atomkernenergie (Germany)
ATKOA		Atomki Kozlemenyek (Hungary)
AUJPA		Australian Journal Physics
BAPMA		Bulletin de l'Académie Polonaise des Sciences, Série des Sciences Mathématiques, Astronomiques et Physiques
BAPSA		Bulletin of the American Physical Society
BRSP		Bulletin of the Russian Academy of Sciences, Physics
CHDBA	1966-...	Comptes Rendus Hebdomadaires des Séances de l'Académie des Sciences, serie B (France)
CHJPB		Acta Physica Sinica (Beijing)
CJCHA		Canadian Journal of Chemistry
CJPHA		Canadian Journal of Physics
CODBA		CODATA Bulletin (Committee on Data for Science and Technology - ICSU)
COREA	...-1965	Comptes Rendus Hebdomadaires des Séances de l'Académie des Sciences (France)
CPCHC	2008-...	Chinese Physics C (former "High-Energy Physics and Nuclear Physics")
CPHMA		Commentationes Physico-Mathematicae : Societas Scientiarum Fennicae (Finland)
CPLEE	1992-...	Chinese Physics Letters
CUSCA		Current Science (India)
CZYPA		Czechoslovak Journal of Physics (Kluwer, london)
DABBB	1953-96	Dissertation Abstract International B
DANKA		Doklady Akademii Nauk SSSR
EPJAA	1998-...	European Physical Journal A (replaces ZPAAD)
EPJDD	1998-...	European Physical Journal D
EPJDR	1999-...	European Physical Journal Direct
EPJST	2007-...	European Physical Journal Special Topics [nsr: ZSTNE]
EULEE	1986-...	Europhysics Letters (replaces JPSLB and NCLTA)
FECLA		Particles and Nuclei, Letters (Russia)
FZKAA		Fizika (Croatia)
HPACA		Helvetica Physica Acta
HYIND		Hyperfine Interactions
IANFA		Izvestiya Akademii Nauk SSSR, seriya Fizicheskaya
IEIMA		IEEE Transactions on Instrumentation and Measurement (USA)
IJARA	1956-85	International Journal of Applied Radiation and Isotopes (Great Britain)
IJMPD		International Journal of Mass Spectrometry and Ion Processes (Elsevier)
IJOPA		Indian Journal of Pure and Applied Physics
IJPYA		Indian Journal of Physics and Proceedings of the Indian Association for the Cultivation of Science

IMPAE		International Journal of Modern Physics A (World Scientific Publishing, Singapore)
IMPEE		International Journal of Modern Physics E (World Scientific Publishing, Singapore)
JCOMA	...-1991	Journal of the Less Common Metals (Switzerland)
JINCA	...-1981	Journal of Inorganic and Nuclear Chemistry (USA)
JLTPA		Journal of Low Temperature Physics
JMOPE		Journal of Modern Optics (Great Britain)
JNCEA		Journal of Nuclear Energy A and B (Great Britain)
JNRSA		Journal of Nuclear and Radiochemical Sciences (Japan)
JOPQA	1961-98	Journal de Physique (France)
JOPQS		Journal de Physique (France) Suppl. Colloques
JPAGB		Journal of Physics, A (Great Britain)
JPCSD		Journal of Physics, G Conference Series (Great Britain)
JPGPE	1989-...	Journal of Physics, G Nuclear Physics (Great Britain)
JPHGB	...-1988	Journal of Physics, G Nuclear Physics (Great Britain)
JPRAA	...-1960	Journal de Physique et le Radium (France)
JPSLB	...-1985	Journal de Physique Lettres (France)
JRNBA		Journal of Research of the National Institute of Standards and Technology
JRNCD		Journal Radioanal. Nuclear Chemistry
JUPSA		Journal of the Physical Society of Japan
JUPSC		Japanese Physical Society Conference Proceedings
KDVSA		Det Kongelige Danske Videnskabernes Selskab, Matematisk-Fysiske Meddelelser
KERNA		Kernenergie (Germany)
KPSJA		Journal of the Korean Physical Society
KURAA		Kyoto University, Research Reactor Institute : Annual Report
MPLAE		Modern Physics Letters section A (World Scientific Publishing, Singapore)
MTRGA		Metrologia
NATUA		Nature (Great Britain)
NCIAA	1955-99	Nuovo Cimento A (Italy)
NCLTA	...-1985	Nuovo Cimento Lettere (Italy)
NDSAA		Nuclear Data Tables, section A (USA)
NDSBA		Nuclear Data Sheets (USA)
NIMAE	1986-...	Nuclear Instruments and Methods in Physics Research A (Netherlands)
NIMBE	1983-...	Nuclear Instruments and Methods in Physics Research B (Netherlands)
NSENA		Nuclear Science and Engineering (American Nuclear Society, USA)
NUCIA	...-1969	Nuovo Cimento (Italy)
NUIMA	...-1985	Nuclear Instruments and Methods (Netherlands)
NUPAB	1967-...	Nuclear Physics, section A (Netherlands)
NUPBB	1967-...	Nuclear Physics, section B (Netherlands)
NUPHA	1957-66	Nuclear Physics (Netherlands)
PACHA		Pure and Applied Chemistry
PCPSA		Proceedings Cambridge Philosophical Society
PENUC		Particle Emission from Nuclei, ed. by D.N. Poenaru and M.S. Ivaşcu, CRC Press (USA), 1989
PHFEA		Physica Fennica (Finland)
PHLTA	...-1967	Physics Letters (Netherlands)
PHMAA	...-1955	Philosophical Magazine (Great Britain)
PHMAB	1956-...	Philosophical Magazine (Great Britain)
PHNOA		Physica Norvegia
PHRVA	1930-69	Physical Review (USA) (not 1964 and 1965)
PHSTB	1970-...	Physica Scripta (Sweden)
PHSTT	1970-...	Physica Scripta (Sweden) T-volumes
PHYSA		Physica (Netherlands)
PISAA		Proceedings of the Indian Academy of Sciences, section A
PLRBA	1964-65	Physical Review, section B (USA)

PLSSA		Planetary and Space Science (Netherlands)
PPNPD		Progress in Particle and Nuclear Physics
PPNUE	2005	Physics of Particle and Nuclei
PPSOA		Proceedings of the Physical Society (Great Britain)
PRAMC		Pramana, Journal of Physics (India)
PRLAA		Proceedings of the Royal Society of London, Series A
PRLTA		Physical Review Letters (USA)
PRVAA	1970-...	Physical Review, section A (USA)
PRVCA	1970-...	Physical Review, section C (USA)
PRVDA	1970-...	Physical Review, section D (USA)
PRXHA	2014-...	Physical Review, section X (USA)
PRYCA		Proceedings of the Royal Society of Canada
PTPSA	-12	Progress in Theoretical Physics (Kyoto), Suppl.
PYLAA	1968-...	Physics Letters, section A (Netherlands)
PYLBB	1968-...	Physics Letters, section B (Netherlands)
PZETA		Pis'ma v Zhurnal Eksperimental'noi i Teoreticheskoi Fiziki (Russia)
RAACA		Radiochimica Acta (Germany)
RAEFB		Radiation Effects and Defects in Solids (Great Britain)
RBFSA		Revista Brasileira de Fisica
RMPHA		Reviews of Modern Physics (USA)
RMXFA		Revista Mexicana de Física
RPHAA	1966-90	Revue de Physique Appliquée (Paris)
RPPHA		Reports on Progress in Physics (Great Britain)
RRALA		Radiochemical and Radioanalytical Letters (Hungary)
SAPHD		South African Journal of Physics
SCIEA		Science (American Association for the Advancement of Science)
SHIBA		Shitsuryo Bunseki (Mass Spectrometry, Japan)
THISc		Treatise on Heavy-Ion Science, ed. by D.A. Bromley, Plenum Press, 1989
UFZHA		Ukrains'kii Fizicheskii Zhurnal
VDPEA		Verhandlungen der Deutschen Physikalischen Gesellschaft
VHDPG		Verhandlungen der Deutschen Physikalischen Gesellschaft
YAFIA		Yadernaya Fizika (Russia)
YTHLD	...-1997	Chinese Journal of Nuclear Physics
YWPIF		Nuclear Physics Review (China)
ZDACE	1974-...	Zeitschrift für Physik D (Germany)
ZENAA		Zeitschrift für Naturforschung, part A (Germany)
ZEPYA	...-1974	Zeitschrift für Physik (Germany)
ZETFA		Zhurnal Eksperimental'noi i Teoreticheskoi Fiziki (Russia)
ZPAAD	1975-97	Zeitschrift für Physik A (Germany) (replaces ZEPYA)
ZPCFD	1975-97	Zeitschrift für Physik C (Germany)

REPORTS, PREPRINTS, THESIS, ABSTRACTS, COMMUNICATIONS

AAAAA to be pd	To be published in journal AAAAA
PrvCom AHW Mon	Private communication to A.H. Wapstra in given Month
PrvCom Bpf Mon	Private communication to B. Pfeiffer in given Month
PrvCom FGK Mon	Private communication to F.G. Kondev in given Month
PrvCom GAu Mon	Private communication to G. Audi in given Month
PrvCom Hwj Mon	Private communication to Huang Wenjia in given Month
PrvCom JBl Mon	Private communication to J. Blachot in given Month
PrvCom NDG Mon	Private communication to Nuclear Data Group in given Month
PrvCom SNa Mon	Private communication to S. Naimi in given Month
PrvCom WgM Mon	Private communication to M. Wang in given Month
PrvCom Ref	Quoted by reference in question

Table of Isotopes	Table of Isotopes, LBL Brookhaven
AnRpt Institute	Annual Report from Institute (or City)
ANL-	Argonne National Laboratory, report
CERN-	European Organization for Nuclear Research, report
COO-	Reports on work done with DOE support
DASA-	Defense Atomic Support Agency, Washington, DC, report
GANIL-	Grand Accelérateur National d'Ions Lourds, report
GSI-	Gesellschaft für Schwerionenforschung, report
IAEA-	International Atomic Energy Agency, report
IDO-	Idaho Operations Office of US Atomic Energy Commission, report
IPNO-DRE	Institut de Physique Nucléaire d'Orsay, report
JINR-	Joint Institute for Nuclear Research Dubna, report
KFK-	Kernphysik Zentrum Karlsruhe, report
LBL-	Lawrence Berkeley National Laboratory, report
LNPI-	Leningrad report
Leninst YF-	Leningradskii Institut Yadernoi Fiziki
NEANDC-	Nuclear Energy Agency - Nuclear Data Center
NP-	Cited in NSR for 1965An05
ORNL-	Oak Ridge National Laboratory report
UCRL-	University of California Radiation Laboratory report
USIP-	University of Stockholm Institute of Physics report
Th.- City	Dissertation from corresponding University

CONFERENCE PROCEEDINGS AND ABSTRACTS

P-Adelaide	2016	Int. Nucl. Physics Conf. (INPC2016), Adelaide, Australia, September 2016
P-Aizu	2002	Proc. Frontiers of Collective Motion, Aizu, Japan, November 2002
P-Alma Ata	1978	Program of 28th USSR Conference on Nuclear Spectroscopy
P-Alma Ata	1984	Program of 34th USSR Conference on Nuclear Spectroscopy
P-Amsterdam	1974	Proc. Intern. Conference Nuclear Structure
P-Amsterdam	1982	Proc. Intern. Conference Nuclear Structure
P-Amsterdam	1996	2nd. North-West Europe Nuclear Physics Conference NWE'96
P-Argonne	2012	Int. Conf. on Nuclear Structure 2012
P-Arles	1995	Proc. Int. Conf. on Exotic Nuclei and Atomic Masses ENAM-95
B-Arles	1995	Abstracts ENAM-95
P-Aulanko	2001	Proc. Int. Conf. on Exotic Nuclei and Atomic Masses ENAM-2001
B-Aulanko	2001	Abstracts ENAM-2001
P-BadHonnet	1988	Proc. Int. Workshop Nucl. Struct. of the Zr Region
P-Baku	1976	Program of 26th USSR Conference on Nuclear Spectroscopy
P-Bellaire	1998	Proc. Int. Conf. on Exotic Nuclei and Atomic Masses ENAM-98
B-Bellaire	1998	Abstracts ENAM-98
P-Berkeley	1980	Proc. Intern. Conf. Nuclear Physics Berkeley
P-Bernkastel	1992	Proc. 9th Int. Conf. Atomic Masses and Fundamental Constants AMCO-9, and 6th Int. Conf. Nuclei far from Stability NUFAS-6
B-Bernkastel	1992	Abstracts AMCO-9 and NUFAS-6
P-Birmingham	1985	Proc. Specialists Meeting on Delayed Neutron Properties
P-Bombay	1974	Proc. Nucl. Phys. and Solid State Phys. Symposium
P-Bombay	1985	Symposium on Quantum Electronics
P-Bormio	1999	XXXVII International Winter meeting on Nuclear Physics
P-Brookhaven	1979	Proc. 3rd Int. Conf. Neutron Capture Gamma Ray Spectroscopy
B-Bruges	2016	ND2016 conference
P-Budapest	1972	Proc. 1st Int. Conf. Neutron Capture Gamma Ray Spectroscopy
P-Cadarache	2005	Proc. Nuclear Fission and Fission-Product Spectroscopy, AIP-798
P-Cargèse	1976	Proc. 3rd Int. Conf. Nuclei far from Stability NUFAS-3 CERN 76-13

P-Charkov	1986	Program of 38th USSR Conference on Nuclear Spectroscopy
P-Darmstadt	1984	Proc. 7th Int. Conf. Atomic Masses and Fundamental Constants AMCO-7
P-Debreccen	1968	Proc. Conf. Electron Capture and Higher Order Processes in Nuclear Decays
P-Debreccen	2005	Int. Symposium on Exotic Nuclear Systems, AIP-802
P-Dubna	1961	Repts. Third Conf. Neutron-deficient Isotopes
P-Dubna	1968	Proc. International Symposium on Nuclear Structure
P-Dubna	1989	Int. School-Seminar on Heavy-Ion Physics
P-Dubna	1999	Proc.49th Ann.Conf.Nucl.Spectrosc.Struct.At.Nuclei
P-Florence	1983	Proc. Intern. Conf. Nuclear Physics Florence
P-Fribourg	1993	Proc. 8th Int. Symp. Capture Gamma Ray Spectroscopy and Related Topics
P-Gatlinburg	1967	Proc. Intern. Conf. Gatlinburg
P-Grenoble	1981	Proc. 4th Int. Conf. Neutron Capture Gamma Ray Spectroscopy
P-Helsingor	1981	Proc. 4th Int. Conf. Nuclei far from Stability NUFAS-4 CERN 81-09
P-Kiev	1982	Program of 32th USSR Conference on Nuclear Spectroscopy
P-Knoxville	1984	Proc. 5th Int. Symp. Capture Gamma-Ray Spectroscopy and Related Topics
P-Kyoto	1970	Conference on Mass Spectroscopy
P-Kyoto	1996	Proc. Research Meeting Unstable Nuclei and Nuclear Methodology
P-Lansing	1979	Proc. 6th Int. Conf. Atomic Masses and Fundamental Constants AMCO-6
P-Legnaro	1971	Proc. Conf. Structure of 1f7/2 Nuclei, Legnaro
P-Leningrad	1975	Program of 25th USSR Conference on Nuclear Spectroscopy
P-Leningrad	1985	Program of 35th USSR Conference on Nuclear Spectroscopy
P-Leningrad	1990	Program of 40th USSR Conference on Nuclear Spectroscopy
P-Leuven	1987	Proc. 6th Int. Symp. Capture Gamma-Ray Spectroscopy and Related Topics
P-Leuven	2011	Int. Conf. on Advances in Radioactive Isotope Science ARIS2011
P-Leysin	1970	Proc. 2nd Int. Conf. Nuclei far from Stability NUFAS-2 CERN 70-30
P-Lisbon	2007	Proc. Proton Emitting Nuclei and Related Topics -PROCON 2007, AIP-961
P-Miami	1989	Symposium on Exotic Nuclear Spectroscopy
P-Minsk	1991	Program of 41th USSR Conference on Nuclear Spectroscopy
P-Monterey	1990	Proc. Xth Int. Conf. Neutron Capture Gamma Ray Spectroscopy
P-Moscow	1955	Conf. Acad. Sci. USSR Peaceful Use of Atomic Energy
P-Moscow	1971	Program of 21st USSR Conference on Nuclear Spectroscopy
P-Moscow	1983	Program of 33rd USSR Conference on Nuclear Spectroscopy
P-New-Dehli	2012	Frontiers in Gamma-Ray Spectroscopy 2012 - FIG12, AIP-1609
P-Niiigata	1991	Proc. Int. Symp. on Structure and Reactions of Unstable Nuclei
P-PacGrove	1991	Proc. 7th Int. Symp. Capture Gamma Ray Spectroscopy
P-Paris	1958	Compt.Rend.Congr.Intern.Phys.Nucl., Paris, P.Gugenberger, Ed., Dunod, Paris(1959)
P-Paris	1975	Proc. 5th Int. Conf. Atomic Masses and Fundamental Constants AMCO-5
P-Petten	1975	Proc. 2nd Int. Conf. Neutron Capture Gamma Ray Spectroscopy
P-Rosseau	1987	Proc. 5th Int. Conf. Nuclei far from Stability NUFAS-5, AIP-164
P-Samarkand	1981	Program of 31st USSR Conference on Nuclear Spectroscopy
P-Santa Fe	2004	Int. Conf. Nuclear Data for Science and Technology
B-Seeheim	1999	1st Int. Conf. Chemistry and Physics of the Transactinide Elements (TAN'99)
P-StMalo	1988	Proc. 3rd Int. Conf. Nucleus-Nucleus Collisions
P-StPetersbg	1995	Low Energy Nuclear Dynamics, EPS XV Nucl. Phys. Div.
P-Studsvik	1969	Proc. Conf, Neutron Capture Gamma Ray Spectroscopy
P-Swansea	1985	10th Int. Mass Spectrometry Conf. (in Adv. in Mass Spectr. 1985)
P-Tashkent	1977	Program of 27th USSR Conference on Nuclear Spectroscopy
P-Tbilis	1964	Program of 14th USSR Conference on Nuclear Spectroscopy
P-Teddington	1972	Proc. 4th Int. Conf. Atomic Masses and Fundamental Constants
P-Tokai	1994	Symposium on Nuclear Data, JAERI
P-Vienna	1964	Proc. 2nd Intern. Conf. Nuclidic Masses
P-Winnipeg	1967	Proc. 3rd Int. Conf. Atomic Masses and Fundamental Constants
P-Yerevan	1969	Program of 19th USSR Conference on Nuclear Spectroscopy
P-Yurmala	1987	Program of 37th USSR Conference on Nuclear Spectroscopy

LIST OF REFERENCES

Before 1948

1934Le01	PRLAA	145,	235	W.B. Lewis, B.V. Bowden
1940Kr08	PCPSA	36,	490	R.S. Krishnan, E.A. Nahum

1948

1948Fe09	PPSOA	61,	466	N. Feather, J. Kyles, R.W. Pringle
1948Ma29	PPSOA	60,	466	D.G.E. Martin, H.O.W. Richardson, Y.K. Hsu
1948Ma30	PRLAA	195,	287	D.G.E. Martin, H.O.W. Richardson
1948Sa18	PHRVA	74,	1264	D. Saxon
1948St.A	PrvCom		58St50	K. Street,Jr., A. Ghiorso, D.A. Orth, G.T. Seaborg

1949

1949Be36	PHRVA	76,	1624	L.A. Beach, C.L. Peacock, R.G. Wilkinson
1949Be53	PHRVA	76,	574	P.R. Bell, B.H. Ketelle, J.M. Cassidy
1949Bo67	PHRVA	75,	1401	T.W. Bonner, J.E. Evans, J.C. Harris, G.C. Phillips
1949Ch35	PHRVA	76,	586	C.Y. Chao, C.C. Lauritsen, A.V. Tollestrup
1949Du15	PHRVA	76,	1272	R.B. Duffield, L.M. Langer
1949Fe18	PHRVA	76,	1888	L. Feldman, L. Lidofsky, P. Macklin, C.S. Wu
1949La06	PHRVA	76,	641	L.M. Langer, H.C. Price,Jr.
1949Ma57	PHRVA	76,	1719	K.C. Mann, D. Rankin, P.N. Kaykin
1949Pa.A	ORNL-499		45	G.W. Parker, G.E. Creek, G.M. Hebert, P.M. Lantz, W.J. Martin
1949Pa.B	ORNL-336		42	G.W. Parker, G.E. Creek, G.M. Hebert, P.M. Lantz
1949To16	PHRVA	76,	428	A.V. Tollestrup, C.C. Lauritsen, W.A. Fowler
1949To23	PHRVA	75,	1947	A.V. Tollestrup, F.A. Jenkins, W.A. Fowler, C.C. Lauritsen

1950

1950Ag01	PHRVA	77,	655	H.M. Agnew
1950B192	HPACA	23,	623	J.P. Blaser, F. Boehm, P. Marmier
1950Br52	PHRVA	79,	606	J.A. Bruner, L.M. Langer
1950Br66	PHRVA	79,	902	A.R. Brosi, H. Zeldes, B.H. Ketelle
1950Ch53	PHRVA	79,	108	C.Y. Chao, A.V. Tollestrup, W.A. Fowler, C.C. Lauritsen
1950Fr10	PHRVA	80,	30	G. Friedlander, M.L. Perlman, D.E. Alburger, A.W. Sunyar
1950Fr58	PHRVA	79,	897	M.S. Freedman, D.W. Engelkemeir
1950Ha58	PHRVA	79,	409	R.W. Hayward
1950Ha65	PHRVA	79,	541	R.W. Hayward
1950Hu27	PHRVA	77,	726	D.J. Hughes, C. Egger, D.E. Alburger
1950Ke11	PHRVA	79,	242	B.H. Ketelle, C.M. Nelson, G.E. Boyd
1950La04	PHRVA	77,	798	L.M. Langer, J.W. Motz, H.C. Price,Jr.
1950Ma14	PHRVA	78,	363	L.B. Magnusson, S.G. Thompson, G.T. Seaborg
1950Ma76	PHRVA	80,	977	E.A. Martell, W.F. Libby
1950Me55	PHRVA	79,	19	J.Y. Mei, A.C.G. Mitchell, C.M. Huddleston
1950Mo56	PHRVA	80,	309	R.C. Mobley, R.A. Laubenstein
1950Na09	PHRVA	77,	398	R.A. Naumann, F.L. Reynolds, I. Perlman
1950Ok52	PHRVA	80,	293	G.D. O'Kelley, G.W. Barton,Jr.
1950Ow03	PHRVA	78,	606	G.E. Owen, C. Sharp Cook, P.H. Owen
1950Ri59	PHRVA	80,	524	H.T. Richards, R.V. Smith, C.P. Browne

1951

1951Bo48	PHRVA	83,	216	G.E. Boyd, B.H. Ketelle
1951Bo49	PHRVA	83,	1091	T.W. Bonner, J.W. Butler
1951Br10	PHRVA	82,	159	A.B. Brown, C.W. Snyder, W.A. Fowler, C.C. Lauritsen
1951Br87	PHRVA	84,	292	H.N. Brown, W.L. Bendel, F.J. Shore, R.A. Becker

1951Ca04	PHRVA	81,	485	R. Canada, A.C.G. Mitchell
1951Ca28	PHRVA	83,	955	R. Canada, A.C.G. Mitchell
1951Ca37	PHRVA	84,	749	R.R. Carlson
1951Ca43	PHRVA	83,	483	J.M. Cassidy
1951Du03	PHRVA	81,	203	R.B. Duffield, L.M. Langer
1951Du19	PHRVA	84,	1065	R.B. Duffield, L.M. Langer
1951Fr19	PHRVA	84,	231	G. Friedlander, D.E. Alburger
1951Hu38	PHRVA	84,	289	C.M. Huddleston, A.B. Smith
1951Hy24	PHRVA	82,	944	E.K. Hyde, G.D. O'Kelley
1951Je01	PHRVA	81,	143	E.N. Jensen, R.T. Nichols, J. Clement
1951Kl55	PHRVA	83,	212	E.D. Klema, G.C. Phillips
1951Ko17	AFYSA	3,	47	E. Kondaiah
1951Li26	PHRVA	83,	512	C.W. Li, W. Whaling, W.A. Fowler, C.C. Lauritsen
1951Li29	PHRVA	82,	122	C.W. Li, W. Whaling
1951Ly10	PHRVA	82,	276	W.S. Lyon
1951Mc11	PHRVA	81,	734	C.L. McGinnis
1951Mc48	PHRVA	84,	384	J.J.G. McCue, W.M. Preston
1951Me10	PHRVA	81,	782	W.W. Meinke, A. Ghiorso, G.T. Seaborg
1951Or.A	UCRL- 1951			D.A. Orth, K. Street, Jr.
1951Ro50	PHRVA	83,	349	J.M. Robson
1951Ta05	PHRVA	81,	461	S.I. Taimuty
1951Ve05	PHYSA	17,	637	N.F. Verster, G.J. Nijgh, R. van Lieshout, C.J. Bakker
1951Wh05	PHRVA	81,	150	W. Whaling, C.W. Li
1951Wi26	PHRVA	84,	731	R.M. Williamson, C.P. Browne, D.S. Craig, D.J. Donahue

1952

1952Al06	PHRVA	85,	734	D.E. Alburger
1952Be55	AFYSA	5,	191	I. Bergström
1952Be78	IANFA	16,	314	E.Y. Berlovich
1952Ch31	PHRVA	88,	887	L.S. Cheng, J.L. Dick, J.D. Kurbatov
1952Cr30	PHRVA	88,	808	D.S. Craig, D.J. Donahue, K.W. Jones
1952Fa14	PHRVA	87,	252	C.Y. Fan
1952Fe16	PHRVA	87,	1091	L. Feldman, C.S. Wu
1952Fr23	PPSOA	65,	911	J.H. Fremlin, M.C. Walters, and 95Tr07 and 02Tr04
1952Fu04	PHRVA	86,	347	S.C. Fultz, M.L. Pool
1952Ha44	PHRVA	88,	876	J.R. Haskins, J.E. Duval, L.S. Cheng, J.D. Kurbatov
1952Hi.A	Th.-Berkeley			G.H. Higgins
1952Ka41	PHRVA	85,	368	M.I. Kalkstein, W.F. Libby
1952Ko27	AFYSA	4,	81	E. Kondaiah
1952Lo06	PHRVA	85,	585	J.A. Lovington, J.J.G. McCue, W.M. Preston
1952Mc34	PHRVA	87,	202	C.L. McGinnis (also PrvCom NDG)
1952Me53	PHRVA	88,	1360	F.R. Metzger
1952Mi54	PHRVA	88,	1254	C. Mileikowsky, W. Whaling
1952Mo12	PHRVA	85,	501	H.T. Motz
1952Mo22	PHRVA	86,	165	H.T. Motz, D.E. Alburger
1952Or.A	Th.-Berkeley			D.A. Orth
1952Ro16	PHRVA	86,	863	D. Rose, G. Hinman, L.G. Lang
1952Sc09	PHRVA	85,	873	W.A. Schoenfeld, R.W. Duborg, W.M. Preston, C. Goodman
1952Sc11	PHRVA	85,	1046	C.L. Scoville, S.C. Fultz, M.L. Pool
1952Sc15	PHRVA	86,	248	G. Schrank, J.R. Richardson
1952Sm13	PHRVA	86,	98	A.B. Smith
1952Sm41	PHRVA	87,	454	A.B. Smith, A.C.G. Mitchell, R.S. Caird
1952Wa12	PHRVA	86,	561	A.H. Wapstra
1952Wi26	PHRVA	85,	687	R.G. Winter

1953

1953Am08	PHRVA	91,	68	D.P. Ames, M.E. Bunker, L.M. Langer, B.M. Sorenson
----------	-------	-----	----	--

1953An01	PHRVA	90,	656	C.E. Anderson, G.W. Wheeler, W.W. Watson
1953As.A	Th.-Berkeley			F. Asaro
1953Ba81	IANFA	17,	437	A.A. Bashilov, N.M. Antoneva, B.S. Dzelepov, A.I. Dolgintseva
1953Ba82	IANFA	17,	468	A.A. Bashilov, N.M. Antoneva, D.C. Broder, B.S. Dzelepov
1953Be42	PHRVA	90,	888	W.L. Bendel, F.J. Shore, H.N. Brown, R.A. Becker
1953BI44	PHRVA	90,	464	E. Bleuler, J.W. Blue, S.A. Chowdary, A.C. Johnson, D.J. Tendam
1953Bu63	PHRVA	91,	1219	J.P. Butler, J.S. Adams
1953Co02	PRLAA	216,	242	E.R. Collins, C.D. MacKenzie, C.A. Ramm
1953Cr18	PHRVA	90,	1124	B. Crasemann, H.T. Easterday
1953Cr.A	PrvCom		58St50	W.W.T. Crane
1953Do04	PHRVA	89,	824	D.J. Donahue, K.W. Jones, M.T. McEllistrem, H.T. Richards
1953Du03	PHRVA	89,	854	R.B. Duffield, L.M. Langer
1953Ea11	PHRVA	91,	653	H.T. Easterday
1953Fa18	PHRVA	91,	1195	K.F. Famularo, G.C. Phillips
1953Fi.A	Th.-Rochester			R.W. Fink
1953Gl.A	ANL-5000		55	L.E. Glendenin, E.P. Steinberg
1953Ha66	CJPHA	31,	278	J.A. Harvey
1953Hy83	PHRVA	90,	267	E.K. Hyde, A. Ghiorso
1953Jo20	CJPHA	31,	1136	F.A. Johnson
1953Kn23	PHRVA	91,	889	J.D. Knight, M.E. Bunker, B. Warren, J.W. Starner
1953Ky19	PPSOA	66,	519	J. Kyles, C.G. Campbell, W.J. Henderson
1953Li01	PHRVA	90,	387	L. Lidofsky, E. Alperovitch, C.S. Wu
1953Ma23	PHRVA	90,	330	L. Marquez
1953Ma64	PHRVA	92,	1511	L. Marquez
1953Pe14	PHRVA	92,	687	J.F. Perkins, S.K. Haynes
1953Ph28	PHRVA	91,	462	G.C. Phillips, K.F. Famularo, C.R. Gosset
1953Sa26	COREA	236,	1249	M. Sakai, P. Hubert
1953Sh48	PHRVA	91,	1203	F.J. Shore, W.L. Bendel, H.N. Brown, R.A. Becker
1953St31	PHYSA	19,	279	P.H. Stoker, Ong Ping Hok
1953Wa05	PHRVA	89,	502	F. Wagner, Jr., M.S. Freedman, D.W. Engelkemeir, J.R. Huizenga
1953Yo03	JUPSA	8,	435	Y. Yoshizawa
1953Yu04	COREA	237,	1077	T. Yuasa
1954				
1954Ah20	AFYSA	7,	459	K. Ahnlund
1954Ah37	PHRVA	96,	999	K. Ahnlund
1954Ah47	AFYSA	8,	489	K. Ahnlund, S. Thulin, R. Pauli
1954Al35	PHRVA	96,	684	K.W. Allen, E. Almqvist, J.T. Dewan, T. Pepper
1954Be10	PHRVA	93,	1073	W. Bernstein, S.S. Markowitz, S. Katcoff
1954Bo39	PHRVA	94,	1078	F.I. Boley
1954Br37	PPSOA	67,	397	W.D. Brodie
1954Br96	PHRVA	96,	1372	H.N. Brown, R.A. Becker
1954Da22	ZENAA	9,	402	H. Daniel, W. Bothe
1954Da31	ZENAA	9,	974	H. Daniel
1954De13	PHRVA	95,	646	E. Der Mateosian
1954De17	PHRVA	95,	458	E. Der Mateosian, C.S. Wu
1954El10	PRLAA	224,	129	R.B. Elliott, D.J. Livesey
1954El24	PRYCA	48,	12	L.G. Elliott, R.L. Graham, J. Walker, J.L. Wolfson
1954Gr19	PHRVA	94,	794	R.L. Graham, J. Walker
1954Ha68	PHRVA	96,	1003	T.H. Handley, E.L. Olsen
1954Hu61	PHRVA	96,	548	J.R. Huizenga, C.M. Stevens
1954Ki23	RMPHA	26,	327	R.W. King
1954Le08	PHRVA	93,	155	M.R. Lee, R. Katz
1954Li19	PHRVA	94,	780	L. Lidofsky, R. Gold, C.S. Wu
1954Li24	PHRVA	95,	444	T. Lindqvist, A.C.G. Mitchell
1954Li42	PHRVA	95,	1535	T. Lindqvist, A.C.G. Mitchell
1954Ma54	PHRVA	95,	708	H.B. Mathur, E.K. Hyde
1954Ma75	PHRVA	96,	126	H.B. Mathur, E.K. Hyde

1954Mi60	AFYSA	7,	89	C. Mileikowsky
1954Mi61	AFYSA	8,	117	C. Mileikowsky
1954Mi89	PHRVA	96,	996	C. Mileikowsky, K. Ahnlund
1954Na14	JPRAA	15,	570	M.E. Nahmias, A.H. Wapstra
1954Na18	COREA	239,	47	M.E. Nahmias, T. Yuasa
1954Ni06	PHRVA	94,	369	R.T. Nichols, E.N. Jensen
1954Nu26	PHYSA	20,	555	R.H. Nussbaum, R. van Lieshout, A.H. Wapstra, N.F. Verster, F.E.L. Ten Haaf, G.J. Nijgh, L. Th. M. Ornstein
1954Nu27	PHYSA	20,	571	R.H. Nussbaum, A.H. Wapstra, R. van Lieshout, G.J. Nijgh, L. Th. M. Ornstein, (and PrvCom NDG)
1954O103	PHRVA	93,	1125	J.L. Olsen, G.D. O'Kelley
1954O105	PHRVA	95,	1539	J.L. Olsen, G.D. O'Kelley
1954Pa39	AFYSA	8,	212	R. Pauli, K. Ahnlund, C. Mileikowsky
1954Po26	PHRVA	95,	1523	A.V. Pohm, W.E. Lewis, J.H. Talboy, Jr., E.N. Jensen
1954Pr31	PHRVA	96,	1390	C.H. Pruett, R.G. Wilkinson
1954Ri09	PHYSA	20,	107	L.H. Th. Rietjens, H.J. van den Bold, P.M. Endt
1954Sa22	PHRVA	94,	642	B. Saraf
1954Th17	AFYSA	7,	289	S. Thulin, K. Nybø
1954Th30	PHRVA	96,	850	J. Thirion, R. Cohen, W. Whaling
1954Th36	AFYSA	8,	219	S. Thulin, J. Moreau, H. Atterling
1954Th39	AFYSA	8,	229	S. Thulin, J. Moreau, H. Atterling
1954Wo23	PHRVA	95,	761	C. Wong
1954Za05	IANFA	18,	563	P.P. Zarubin

1955

1955Ad10	COREA	240,	1421	J.P. Adloff
1955Ah41	AFYSA	9,	39	K. Ahnlund
1955At21	PHYSA	21,	543	A.H.W. Aten, Jr., G.D. De Feyfer
1955Ba.A	P-Moscow		251	S.A. Baranov, K.N. Shlyagin
1955Be20	ZEPYA	142,	585	W. Beekman
1955Be78	PHMAA	46,	341	E.H. Bellamy, F.C. Flack
1955Bi29	NUCIA	2,	1052	A. Bisi, E. Germagnoli, L. Zappa
1955Bl23	PHRVA	100,	1324	J.W. Blue, E. Bleuler
1955Br02	JINCA	1,	254	C.P. Browne, D.C. Hoffman, W.T. Crane, J.P. Balagna, G.H. Higgins, J.W. Barnes, R.W. Hoff, H.L. Smith, J.P. Mize, M.E. Bunker
1955Br16	PHRVA	100,	84	R.M. Brugger, T.W. Bonner, J.B. Marion
1955Bu01	PHRVA	97,	1272	M.E. Bunker, J.W. Starnier
1955Bu.A	PHRVA	99,	659	M.E. Bunker, J.P. Mize, J.W. Starnier
1955Da37	PHRVA	100,	796	M.C. Day, Jr., G.W. Eakins, A.F. Voigt
1955De18	PHMAA	46,	445	H. De Waard
1955De40	PHYSA	21,	803	E.F. De Haan, G.J.S. Sizoo, P. Kramer
1955Dr43	IANFA	19,	324	G.M. Drabkin, V.I. Orlov, L.I. Rusinov
1955En16	JINCA	1,	345	D.W. Engelkemeir, P.R. Fields, S. Fried, G.L. Pyle, C.M. Stevens, L.B. Asprey, C.P. Browne, H.L. Smith, R.W. Spence
1955Fa33	PHRVA	99,	1440	B. Farrelly, L. Koerts, N. Benczer, R. van Lieshout, C.S. Wu
1955Go.A	P-Moscow		226	L.L. Goldin, E.F. Tretyakov, G.I. Novikov
1955Gr08	PHRVA	97,	1033	W.E. Graves, A.C.G. Mitchell
1955Ha.A	Th.-Delft			H. Hagedoorn
1955Jo02	PHRVA	97,	1031	J.T. Jones, Jr., E.N. Jensen
1955Jo09	PHRVA	99,	1645	M.W. Johns, B.C. Chidley, I.R. Williams
1955Ki28	PHRVA	99,	1393	J.D. Kington, J.K. Bair, H.O. Cohn, H.B. Willard
1955Ko14	PHRVA	98,	1230	L. Koerts, P. Macklin, B. Farrelly, R. van Lieshout, C.S. Wu
1955Ma01	ZENAA	10,	168	Th. Mayer-Kuckuk, H. Daniel
1955Ma12	PHRVA	97,	103	P. Marmier, F. Boehm
1955Ma13	PHRVA	97,	117	H.B. Mathur, E.K. Hyde, C.A. Levine, P.K. Kofstad
1955Ma40	COREA	240,	291	N. Marty
1955Ma62	JPRAA	16,	458	N. Marty
1955Ma63	HPACA	28,	193	D. Maeder, P. Stahelin

1955Ma76	PHRVA	100,	847	J.B. Marion, T.W. Bonner, C.F. Cook
1955Ma84	PHRVA	100,	91	J.B. Marion, T.W. Bonner, C.F. Cook
1955Ma.A	ANL-5386			L.B. Magnusson, F. Wagner, Jr., D.W. Engelkemeir, M.S. Freedman
1955Mc17	PHRVA	97,	93	C.L. McGinnis
1955Mi90	PHRVA	100,	1390	J.P. Mize, M.E. Bunker, J.W. Starnier
1955Mo69	JINCA	1,	274	F.F. Momyer, Jr., F. Asaro, E.K. Hyde
1955Mu19	PHRVA	97,	1007	J.J. Murray, F. Boehm, F. Marmier, J.W.M. Dumond
1955Nu11	PHYSA	21,	77	R.H. Nussbaum, A.H. Wapstra, M.J. Sterk, R.E.W. Kropveld
1955On05	PHYSA	21,	676	Ong Ping Hok, P. Kramer
1955Pa50	AFYSA	9,	571	R.T. Pauli
1955Pe24	PHRVA	98,	262	I. Perlman, F. Stephens, F. Asaro
1955Ra27	PHRVA	99,	42	J.O. Rasmussen, H. Slatis, T.O. Passel
1955Ro05	PHRVA	97,	97	H. Roderick, O. Lonsjo, W.E. Meyerhof
1955Sc09	PHRVA	99,	810	A.W. Schardt, J.P. Welker
1955Th01	AFYSA	9,	137	S. Thulin
1956				
1956Ar33	AFYSA	10,	1	E. Arberman, N. Svartholm
1956As38	PHRVA	104,	91	F. Asaro, I. Perlman
1956Av28	ANPHA	1,	10	P. Avignon
1956Ba39	ZETFA	30,	225	S.A. Baranov, K.N. Shlyagin
1956Ba95	JNCEA	3,	132	S.A. Baranov, K.N. Shlyagin
1956Be18	PHRVA	101,	1027	N. Benczer, B. Farrelly, L. Koerts, C.S. Wu
1956Bi30	NUCIA	4,	758	A. Bisi, S. Terrani, L. Zappa
1956B110	PHRVA	104,	202	N.C. Blais, W.W. Watson
1956Ch67	PHRVA	104,	1314	A. Chetham-Strode, L.W. Holm
1956Ch.A	Th.-Berkeley			A. Chetham-Strode, Jr. UCRL-3322
1956Co13	PHRVA	101,	1042	J.M. Cork, M.K. Brice, D.W. Martin, L.C. Schmid, R.G. Helmer
1956Da06	ZENAA	11,	212	H. Daniel, R. Nierhaus
1956Do41	PHRVA	104,	1059	R.A. Douglas, J.W. Broer, R. Chiba, D.F. Herring, E.A. Silverstein
1956Dr11	PHRVA	102,	426	B.J. Dropesky, A.W. Schardt
1956Du31	PHRVA	103,	1413	V.S. Dubey, C.E. Mandeville, M.A. Rothman
1956Gr07	PHRVA	101,	776	D. Green, J.R. Richardson
1956Gr10	PHRVA	101,	701	W.E. Graves, A.C.G. Mitchell
1956Gr11	PHRVA	101,	1306	P.R. Gray
1956Gr12	PHRVA	101,	1368	W.E. Graves, S.K. Suri
1956Gr35	PHRVA	102,	761	L. Grodzins, H. Motz
1956Ha10	PHRVA	101,	93	R.W. Hayward, D.D. Hoppes
1956Ha59	PHRVA	104,	183	R.W. Hayward, D.D. Hoppes
1956Ho23	JINCA	2,	209	D.C. Hoffman, C.P. Browne
1956Ho66	PHRVA	104,	368	D.D. Hoppes, R.W. Hayward
1956Jo05	CJPHA	34,	69	M.W. Johns, C.V. McMullen, I.R. Williams, S.V. Nablo
1956Jo20	PHRVA	102,	831	N.R. Johnson, R.K. Sheline, R. Wolfgang
1956Ke23	PHRVA	103,	190	B.H. Ketelle, H. Thomas, A.R. Brosi
1956Ki16	PHRVA	102,	1140	H.W. Kirby, G.R. Grove, D.L. Timma
1956Ki29	PHRVA	104,	154	O.C. Kistner, A. Schwarzschild, B.M. Rustad
1956Kn20	PHRVA	102,	1592	J.D. Knight, J.P. Mize, J.W. Starnier, J.W. Barnes
1956Ko67	ZETFA	31,	771	L.M. Kondratev, G.I. Novikova, Y.P. Sobolev, L.L. Goldin
1956La24	ANPHA	1,	152	J. Laberrigue-Frolow
1956Ma14	PHRVA	101,	283	J.B. Marion, R.A. Chapman
1956Ma27	PHRVA	102,	457	D.W. Martin, J.M. Cork, S.B. Burson
1956Ma87	PHRVA	104,	1028	J. Marion, F.B. Hagedorn
1956Nu02	PHRVA	101,	905	R.H. Nussbaum, A.H. Wapstra, W.A. Bruil, M.J. Sterk, G.J. Nijgh, N. Grobber
1956Ok02	PHRVA	101,	1059	G.D. O'Kelley, N.H. Lazar, E. Eichler
1956Pe38	PHRVA	104,	740	J.R. Penning, H.R. Maltrud, J.C. Hopkins, F.H. Schmidt
1956Po16	ZENAA	11,	143	W. Porschen, W. Riezler
1956Po28	PHRVA	103,	921	F.T. Porter, M.S. Freedman, T.B. Novey, F. Wagner, Jr.
1956Sa06	PHRVA	104,	1434	R.M. Sanders

1956Sc.A	BAPSA	1,	162	A.W. Schardt, B. Dropesky
1956Sh31	ZETFa	30,	891	K.N. Shlyagin
1956Sm85	JINCA	3,	93	H.L. Smith, C.P. Browne, D.C. Hoffman, J.P. Mize, M.E. Bunker
1956Sm96	PHRVA	104,	706	F.B. Smith, N.B. Gove, R.W. Henry, R.A. Becker
1956Th11	PHRVA	102,	195	M.T. Thieme, E. Bleuler
1956Tu17	PHRVA	103,	1000	W. Turchinets, R.W. Pringle
1956Va14	PHRVA	103,	656	D.M. Van Patter, C.P. Swann, W.C. Porter, C.E. Mandeville
1956Wa24	PHRVA	102,	816	R.G. Waddell, E.N. Jensen
1956Wo09	CJPHA	34,	256	J.R. Wolfson
1957				
1957Ah19	AFYSA	11,	379	K. Ahnlund
1957Am47	PHRVA	106,	553	S. Amiel, A. Chetham-Strode, Jr., G.R. Choppin, A. Ghiorso, B.G. Harvey, L.W. Holm, S.G. Thompson
1957As.A	BAPSA	2,	393	F. Asaro, S.G. Thompson, F.S. Stephens, Jr., I. Perlman
1957Ba08	ZENAA	12,	520	G. Baro, P. Rey
1957Be44	PHRVA	107,	737	E.M. Bernstein, H.W. Lewis
1957Bi84	PHRVA	108,	1025	H. Bichsel, T.W. Bonner
1957Bj56	NUPHA	4,	313	S. Bjornholm, O. Nathan, O.B. Nielsen, R.K. Sheline
1957Br82	PHRVA	108,	1007	C.P. Browne
1957Bu37	PHRVA	106,	1224	J.W. Butler, K.L. Dunning, R.O. Bondelid
1957Bu41	PHRVA	105,	227	M.E. Bunker, J.P. Mize, J.W. Starner
1957Ch30	PHRVA	105,	633	R.A. Chapman, J.C. Slattery
1957Co62	PPSOA	70,	769	R.D. Connor, I.L. Fairweather
1957Da07	ZENAA	12,	363	H. Daniel
1957Dz64	IANFA	21,	978	B.S. Dzelepov, O.E. Kraft, V.B. Zhinkina
1957Fr.A	PrvCom		58St50	M.S. Freedman, D.W. Engelkemeir, F.T. Porter, F. Wagner, Jr.
1957Ga15	PHRVA	107,	1628	D.G. Gardner, W.W. Meinke
1957GI20	PHMAB	2,	49	R.N. Glover, D.E. Watt
1957Gr47	PHRVA	105,	1570	H.G. Graetzer, A.B. Robbins
1957Ha08	CJPHA	35,	258	B.G. Harvey, H.G. Jackson, T.A. Eastwood, G.C. Hanna
1957Ha99	PHRVA	108,	735	F.B. Hagedorn
1957He39	PHRVA	105,	1011	R.L. Heath
1957He43	NUPHA	3,	161	C.J. Herrlander, T.R. Gerholm
1957Je.A	PrvCom	NDG	Jun	E.N. Jensen
1957Jo24	PISAA	45,	390	M.C. Joshi, B.N. Subba Rao, B.V. Thosar
1957Ki22	PHRVA	105,	1339	O.G. Kistner, A. Schwarzschild, B.M. Rustadt, D.E. Alburger
1957Kn.A	PrvCom	NDG	Apr	J.D. Knight
1957Le27	COREA	244,	1358	C. Levi, L. Papineau
1957Mi63	ANPHA	2,	116	A. Michalowicz
1957Na03	NUPHA	4,	125	O. Nathan
1957Ok.A	BAPSA	2,	24	G.D. O'Kelley, Q.V. Larson, G.E. Boyd
1957OI05	PHRVA	106,	985	J.L. Olsen, L.G. Mann, M. Lindner
1957Ra04	PHRVA	107,	141	J.O. Rasmussen, F.L. Canavan, J.M. Hollander
1957Ri43	ZENAA	12,	665	W. Riezler, G. Kauw
1957Ro54	CJPHA	35,	649	J.C. Roy, T.P. Kohman
1957Sm73	PHRVA	107,	1314	W.G. Smith, R.L. Robinson, J.H. Hamilton, L.M. Langer
1957Th10	PHRVA	106,	1228	T.D. Thomas, R. Vandenbosch, R.A. Glass, G.T. Seaborg
1957Va03	PHRVA	107,	171	D.M. Van Patter, M.A. Rothman, W.C. Porter, C.E. Mandeville
1957Va08	PHYSA	23,	753	B. Van Nooijen, J. Konijn, A. Heyligers, J.F. van den Brugge, A.H. Wapstra
1957Wa01	PHRVA	105,	639	E.K. Warburton, J.N. McGruer
1957Yo04	PHRVA	108,	72	T.E. Young, G.C. Phillips, R.R. Spencer
1958				
1958A199	PHRVA	112,	1998	D.E. Alburger, S. Ofer, M. Goldhaber
1958Ar56	AFYSA	13,	501	E. Arberman, J. Brude, T.R. Gerholm
1958Bi41	PHRVA	112,	1089	H. Bichsel

1958Br88	HPACA	31,	335	J. Brunner, J. Halter, P. Scherrer
1958Du78	PHRVA	110,	1076	K.L. Dunning, J.W. Butler, R.O. Bondelid
1958Ea06	JINCA	6,	261	T.A. Eastwood, R.P. Schuman
1958El44	PHRVA	112,	1200	A.J. Elwyn, H.H. Landon, S. Oleksa, G.N. Glasoe
1958Fe16	PHRVA	112,	1238	J.M. Ferguson
1958Gi05	PHRVA	109,	1263	J.E. Gindler, J.R. Huizenga, D.W. Engelkemeir
1958GI56	IANFA	22,	941	M.P. Glazunov, B.F. Fulev
1958Go77	PRLTA	1,	251	H.E. Gove, J.A. Kuehner, A.E. Litherland, E. Almqvist, D.A. Bromley, A.D. Ferguson, P.H. Rose, R.P. Bastide, N. Brooks, R.D. Connor
1958Gr07	IANFA	22,	194	E.P. Grigorev, A.V. Zolotavin, I.I. Kuzmin, E.D. Pavlitskaia
1958Ha32	PHRVA	112,	2010	J.H. Hamilton, L.M. Langer, W.G. Smith
1958Hi.A	Th.-Berkeley			M.W. Hill
1958Ho02	PHRVA	109,	1282	D.C. Hoffman, B.J. Dropesky
1958Jo01	PHRVA	109,	1243	C.H. Johnson, A. Galonsky, J.P. Ulrich
1958Jo28	PHRVA	112,	1252	K.W. Jones, L.J. Lidofsky, J.L. Weil
1958Ki40	PHRVA	112,	1972	O.C. Kistner, B.M. Rustad
1958Ko57	PHYSA	24,	377	J. Konijn, B. van Nooijen, H.L. Hagedoorn
1958Ko60	PHYSA	24,	129	J. Konijn, H.L. Hagedoorn, B. van Nooijen
1958Mc64	PHRVA	111,	1636	M.T. McEllistrem, H.J. Martin, D.W. Miller, M.B. Sampson
1958Na15	CJPHA	36,	1409	S.V. Nablo, M.W. Johns, A. Artna, R.H. Goodman
1958Ni28	NUPHA	9,	528	G.J. Nijgh, A.H. Wapstra, L.T.M. Ornstein, N. Salomons-Grobben
1958No30	AFYSA	14,	85	T. Novakov, R. Stockendal, M. Schmorak, B. Johansson
1958Pe17	PHRVA	110,	381	M.L. Perlman, J.P. Welker, M. Wolfsberg
1958Po79	PHRVA	112,	1954	N.T. Porile
1958Ri23	ZENAA	13,	904	W. Riezler, G. Kauw
1958Ro09	PHRVA	109,	1255	R.L. Robinson, L.M. Langer
1958Se71	IANFA	22,	198	V.A. Sergienko
1958St50	RMPHA	30,	585	D. Strominger, J.M. Hollander, G.T. Seaborg
1958Su60	PHRVA	109,	109	C.R. Sun, B.T. Wright
1958Wa.A	P-Paris		910	R.J. Walen, G. Bastin
1958Yt22	NUPHA	9,	108	C. Ythier, R.K. Girgis, R.A. Ricci, R. van Lieshout
1959				
1959Ac28	PHRVA	114,	137	W.T. Achor, W.E. Phillips, J.I. Hopkins, S.K. Haynes
1959Al06	PHRVA	116,	939	D.E. Alburger, A. Gallmann, D.H. Wilkinson
1959Am16	PISAA	50,	342	K.S.Y. AMBIYE, M.C. Yoshi, B.V. Thosar
1959An33	NUPHA	13,	310	S.L. Anderson, T. Holtebekk, O. Lonsjo, R. Tangen
1959Ba13	PPSOA	73,	513	F. De S. Barros, P.D. Forsyth, A.A. Jaffe, I.J. Taylor
1959Be72	PHRVA	115,	108	N. Benczer-Koller, A. Schwarzschild, C.S. Wu
1959Bo52	ZEPYA	155,	488	F. Bonhoeffer, H.H. Hennies, A. Flammersfeld
1959Bo61	NUPHA	14,	145	P. Boskma, H. De Waard
1959Br06	CJPHA	37,	1514	D.A. Bromley, A.J. Ferguson, H.E. Gove, J.A. Kuehner, A.E. Litherland, E. Almqvist, R. Batchelor
1959Br65	PHRVA	113,	239	A.R. Brosi, B.H. Ketelle, H.C. Thomas, R.J. Kerr
1959Br74	NUPHA	12,	662	C.P. Browne
1959Bu20	PHRVA	116,	143	M.E. Bunker, B.J. Dropesky, J.D. Knight, J.W. Stamer, B. Warren
1959Co63	PPSOA	74,	161	R.D. Connor, I.L. Fairweather
1959Cu86	PHRVA	114,	1600	J.B. Cumming
1959Dr.A	BAPSA	4,	57	B.J. Dropesky, D.C. Hoffman, W.R. Daniels
1959Fe99	CJPHA	37,	660	A.J. Ferguson, H.E. Gove
1959FI40	PHRVA	116,	744	K.F. Flynn, L.E. Glendenin
1959Gh.A	UCRL- 8714			A. Ghiorso
1959Gi50	NUPHA	12,	204	R.K. Girgis, R. van Lieshout
1959Gi54	PHRVA	115,	1271	J.E. Gindler, J. Gray, Jr., J.R. Huizenga
1959Go68	PHRVA	113,	246	C.R. Gossett, J.W. Butler
1959Gr93	IANFA	23,	191	E.P. Grigorev, A.V. Zolotavin, B. Kratsik
1959Ha27	PHRVA	114,	1133	D.S. Harmer, M.L. Perlman
1959Hi66	PPSOA	73,	501	S. Hinds, R. Middleton

1959Hi67	PPSOA	73,	721	S. Hinds, R. Middleton
1959Hi68	PPSOA	73,	727	S. Hinds, R. Middleton
1959Hi75	PPSOA	74,	779	S. Hinds, R. Middleton
1959Ho97	AFYSA	15,	387	G. Holm, H. Ryde
1959Jo37	PHRVA	114,	279	N.R. Johnson, G.D. O'Kelley
1959Ju40	PHRVA	113,	602	J.O. Juliano, C.W. Kocher, T.D. Nainan, A.C.G. Mitchell
1959Ke26	NUPHA	11,	492	W.H. Kelly, G.B. Beard, R.A. Peters
1959Kn38	JINCA	10,	183	J.D. Knight, D.C. Hoffman, B.J. Dropesky, D.L. Frasco
1959Ku79	PHYSA	25,	600	J. Kuperus, P.J.M. Smulders, P.M. Endt
1959Me68	PPSOA	74,	693	R.E. Meads, J.E.G. McIlldowie
1959Mi19	CJPHA	37,	1126	C.H. Millar, T.A. Eastwood, J.C. Roy
1959No41	ZETFA	37,	928	G.I. Novikova, E.A. Volkova, L.I. Goldin, D.M. Ziv, E.F. Tretyakov
1959Pe27	ZETFA	37,	1558	V.P. Pereygin, E.D. Donets, G.N. Flerov
1959Po77	PHRVA	114,	1286	F.T. Porter, P.P. Day
1959Ri35	NUPHA	10,	360	R.A. Ricci, R. van Lieshout
1959Ro53	CJPHA	37,	385	J.P. Roy, L.P. Roy
1959Su.A	BAPSA	4,	278	D.C. Sutton, H.A. Hill, R. Sherr, and PrvCom
1959To25	BAPSA	4,	366	C.W. Townley, J.D. Kurbatov, M.H. Kurbatov
1959Va02	PHRVA	115,	115	S.E. Vandenbosch, H. Diamond, R.K. Sjoblom, P.R. Fields
1959Va32	PHRVA	113,	259	S.E. Vandenbosch
1959We30	PHRVA	113,	881	H.I. West, Jr., L.G. Mann, G.M. Iddings
1959Yo25	PHRVA	116,	962	T.E. Young, G.C. Phillips, R.R. Spencer, D.A.A.S.N. Rao
1960				
1960An04	ZETFA	38,	372	S.F. Antonova, S.S. Vasilenko, M.G. Kaganskii, D.L. Kaminskii
1960Ar05	CJPHA	38,	1577	A. Artna, M.E. Law
1960Ba17	NUPHA	15,	566	G. Backstrom, O. Bergman, J. Burde, J. Lindskog
1960Ba44	IANFA	24,	1035	S.A. Baranov, A.G. Zelenkov, V.M. Kulakov
1960Bo21	PHRVA	120,	889	R.O. Bondelid, C.A. Kennedy, J.W. Butler
1960Cl02	NUPHA	14,	472	R.L. Clarke, E. Almqvist, E.B. Paul
1960Cr01	NUPHA	14,	578	C.B. Creager, C.W. Kocher, A.C.G. Mitchell
1960Dr03	NUPHA	16,	357	B.J. Dropesky, A.W. Schardt, T.T. Shull
1960Dz02	IANFA	24,	802	B.S. Dzelepov, I.F. Uchevatkin, S.A. Shestopalova
1960Fe03	ANPHA	5,	181	L. Feuervais
1960Fo01	PPSOA	75,	291	P.D. Forsyth, F. De S. Barros, A.A. Jaffe, T.J. Taylor, S. Ramavataram
1960Fr04	PHRVA	120,	1436	J.M. Freeman
1960Ge01	PHRVA	118,	1302	K.N. Geller, J. Halpern, E.G. Muirhead
1960Gi01	NUPHA	14,	589	R.K. Girgis, R.A. Ricci, R. van Lieshout
1960Gu05	AFYSA	17,	337	R.K. Gupta
1960Ha26	PHRVA	119,	772	J.H. Hamilton, L.M. Langer, W.G. Smith
1960He09	PHRVA	119,	788	R.G. Helmer, S.B. Burson
1960Hi03	PPSOA	75,	444	S. Hinds, R. Middleton
1960Ho.A	PrvCom		Hyde	R.W. Hoff, F. Asaro, I. Perlman, in E.K. Hyde, I. Perlman, G.T. Seaborg, Nuclear Properties Heavy Elements p. 799
1960Ja07	PHRVA	117,	1086	T.H. Jacobi, H.A. Howie, J.R. Richardson
1960Ja13	PHRVA	120,	914	N. Jarmie, M.G. Silbert
1960Ja17	PPSOA	76,	914	A.A. Jaffe, F. De S. Barros, P.D. Forsyth, J. Muto, I.J. Taylor, S. Ramavataram
1960Je03	NUPHA	19,	654	B.S. Jensen, O.B. Nielsen, O. Skilbreit
1960Ka14	PHRVA	119,	1953	W.R. Kane, G.T. Emery, G. Scharff-Goldhaber, M. McKeown
1960Ka20	JUPSA	15,	2140	T. Katoh, M. Nozawa, Y. Yoshizawa, Y. Koh
1960Ko04	ZETFA	38,	1436	A.P. Komar, G.A. Korolev, G.E. Kocharov
1960Ko12	PHRVA	120,	1348	C.W. Kocher, A.C.G. Mitchell, C.B. Creager, T.D. Nainan
1960Ku06	JUPSA	15,	2179	T. Kuroyanagi
1960La04	PHRVA	119,	1308	L.M. Langer, D.R. Smith
1960Lu07	ZENAA	15,	939	G. Luhrs, C. Mayer-Boricke
1960Ma21	PPSOA	76,	56	B.E.F. Macefield, J.H. Towle
1960Ma.A	UCRL- 8740			T.V. Marshall
1960Mc12	NUPHA	17,	116	G.J. McCallum, A.T.G. Ferguson, G.S. Mani

1960Mi.A	Th.-Princeton			J.H. Miller III
1960Mo01	JUPSA	15,	213	H. Morinaga, T. Kuroyanagi, H. Mitsui, K. Shoda
1960Mo.A	BAPSA	5,	338	R.B. Moore
1960Mu07	PPSOA	75,	929	J. Muto, F. De S. Barros, A.A. Jaffe
1960Nu02	PHRVA	120,	1815	H. Nutley, J.B. Gerhard
1960Pr07	PHRVA	118,	113	W.W. Pratt, R.G. Cochran
1960Sc14	NUPHA	21,	55	W. Schneider
1960Se05	NUPHA	16,	138	O.J. Segaert, J. Demuynck, A.M. Hoogenboom, H. van den Bold
1960Sp08	NUPHA	21,	310	R.R. Spencer, G.C. Phillips, T.E. Young
1960Ta12	PPSOA	75,	772	I.J. Taylor, F. De S. Barros, P.D. Forsyth, A.A. Jaffe, S. Ramavataram
1960Ta19	NUPHA	21,	133	K. Takahashi, H. Morinaga
1960Vo05	ZETFa	39,	70	A.A. Vorobiev, A.P. Komar, V.A. Korolev
1960Vo07	IANFA	24,	1092	A.A. Vorobiev, A.P. Komar, V.A. Korolev
1960Wa03	PHRVA	117,	191	W.R. Ware, E.O. Wiig
1960Wa04	PHRVA	117,	1297	R. Wallace, J.A. Welch, Jr.
1960Wa10	PHRVA	118,	181	M.A. Wahlgren, W.W. Meinke
1960Wa14	NUPHA	16,	246	R.J. Walen, G. Bastin-Scoffier
1960Wi07	PHRVA	117,	1325	R.M. Williamson, T. Katman, B.S. Burton
1960Yu01	NUPHA	16,	119	H. Yuta, H. Morinaga
1960Ze02	PHRVA	120,	1723	B. Zeidman, J.L. Yntema, B.J. Raz
1961				
1961Ar05	NUPHA	22,	341	E. Arberman, I.B. Haller
1961Ar15	CJPHA	39,	1817	A. Artna, M.W. Johns
1961Ba43	ZETFa	41,	1484	K.A. Baskova, S.S. Vasilev, N.S. Chang, L.Y. Shavtvalov
1961Ba44	ZETFa	41,	1733	S.A. Baranov, V.M. Kulakov, P.S. Samoilov, A.G. Zelenkov, Y.F. Rodionov
1961Be13	PHRVA	123,	2100	E.H. Beckner, R.L. Bramblett, G.C. Phillips, T.A. Eastwood
1961Be15	PHRVA	122,	1576	G.B. Beard, W.H. Kelly
1961Be20	ZETFa	40,	91	A. Bedesku, O.M. Kalinkina, K.P. Mitrofanov, A.A. Sorokin, N.V. Forafontov, V.S. Shpinel
1961Be41	NUPHA	28,	570	G.B. Beard, W.H. Kelly
1961Bo13	PHRVA	124,	213	H.H. Bolotin, A.C. Li, A. Schwarzschild
1961Bo24	NUPHA	27,	581	N.A. Bonch-Osmolovskaya, B.S. Dzelepov, O.E. Kraft, Y.Y. Yang
1961Bo.B	P-Dubna			N.A. Bonch-Osmolovskaya, B.S. Dzelepov, O.E. Kraft
1961Bu04	PHRVA	121,	1770	J.W. Butler, R.O. Bondelid
1961Cu02	PHRVA	122,	1267	J.B. Cumming, N.T. Porile
1961Da01	ZEPYA	164,	303	H. Daniel, P. Panussi
1961De17	NUPHA	28,	148	H.G. Devare
1961De25	JOQA	22,	656	P. Depommier, M. Chabre
1961Di04	NUPHA	25,	248	R.M. Diamond, J.M. Hollander, D.J. Horen, R.A. Naumann
1961Du02	PHRVA	123,	1321	K.L. Dunning, J.W. Butler
1961Er04	AFYSA	20,	209	P. Erman, Z. Sujkowski
1961Fi05	AFYSA	19,	323	R.W. Fink, G. Andersson, J. Kantele
1961Ga05	PHRVA	122,	1590	C.J. Gallagher, Jr., H.L. Nielsen, O.B. Nielsen
1961GI02	PHRVA	122,	229	C.E. Gleit, C.D. Coryell
1961GI06	PHRVA	124,	1914	C.E. Gleit, C.D. Coryell
1961Gr33	IANFA	25,	1217	E.P. Grigorev, K.Y. Gromov, B.S. Dzelepov, Z.T. Zhelev, V. Zvolska, I. Zvolskii
1961Gu02	AFYSA	18,	443	R.K. Gupta, J. Svedberg, G. Andersson
1961Hi06	JUPSA	16,	1280	H. Hisatake
1961Hi11	PPSOA	78,	473	S. Hinds, H. Marchant, R. Middleton
1961Ho10	JUPSA	16,	841	S. Homma, T. Kuroyanagi, H. Morinaga
1961Ho13	JINCA	18,	1	R.W. Hoff, J.M. Hollander, M.C. Michel
1961Ja07	PHRVA	123,	909	N. Jarmie, M.G. Silbert
1961Ja21	PHRVA	124,	1142	H.E. Jackson, L.M. Bollinger
1961Ja22	ZEPYA	165,	94	J. Jaenecke, H. Jung
1961Ja23	RMXFA	10,	247	A. Jaidar, G. Lopez, M. Mazari, R. Dominguez
1961Jo08	PHRVA	122,	1546	N.R. Johnson, E. Eichler, G.D. O'Kelley, J.W. Chase, J.T. Wasson
1961Jo15	PHRVA	124,	157	R.C. Jopson, H. Mark, C.S. Swift, J.H. Zenger

1961Ju05	AFYSA	17,	429	B. Jung, T. Svedberg
1961Ko11	IANFA	25,	237	G.E. Kocharov, G.A. Korolev
1961Ku09	JUPSA	16,	2369	T. Kuroyanagi
1961Ku10	JUPSA	16,	2393	T. Kuroyanagi, H. Yuta, K. Takahashi, H. Morinaga
1961La05	DANKA	137,	551	A.K. Lavrukhina, T.V. Malysheva, B.A. Khotin
1961La16	ZEPYA	165,	393	H. Langhoff, P. Kilian, A. Flammersfeld
1961Ma03	PHRVA	121,	877	H.J. Martin, M.B. Sampson, D.W. Miller
1961Ma05	PHRVA	121,	1758	R.D. Macfarlane, T.P. Kohman
1961Ma08	PPSOA	77,	1050	B.E.F. Macefield, J.H. Towle, W.B. Gilboy
1961Ni02	PHRVA	122,	172	R.T. Nichols, R.E. McAdams, E.N. Jensen
1961Pe23	ZETFA	41,	1780	K.A. Petrzhak, M.I. Yakunin
1961Re06	JINCA	18,	13	I. Rezanka, J. Frana, M. Vobecky, A. Mastalka
1961Ri02	NUPHA	24,	494	R. Rikmenspoel, C.M. Van Patter
1961Ro12	PHRVA	123,	1349	E.L. Robinson, O.E. Johnson
1961Ru06	Th.-Berkeley			C.P. Ruiz
1961Ry02	HPACA	34,	240	A. Rytz
1961Ry04	HPACA	34,	819	A. Rytz, H. Winkler, F. Zamboni, W. Zych
1961Ry05	HPACA	34,	819	A. Rytz, H.H. Staub, H. Winckler
1961Sa11	PHRVA	123,	855	D. Sadeh
1961Sc11	PHRVA	123,	893	A.W. Scharadt, A. Goodman
1961Se08	IANFA	25,	848	I.P. Selinov, V.L. Chikhladze, D.E. Khulelidze
1961Sh23	NUPHA	28,	649	S.M. Shafroth
1961Si03	PHRVA	123,	221	M.G. Silbert, N. Jarmie
1961Sm05	PHRVA	122,	1527	A.M. Smith, F.E. Steigert
1961Th01	PHRVA	124,	1526	T.T. Thwaites, W.W. Pratt
1961To03	PPSOA	77,	399	J.H. Towle, B.E.F. Macefield
1961To10	JOPQA	22,	683	J. Tousset, A. Moussa
1961Va08	ZETFA	40,	475	S.S. Vasilev, No Hsieng Chang, L. Ya. Shavtvalov
1961Va19	IANFA	25,	1127	A.K. Valter, I.I. Zalubovski, A.P. Klyucharev, V.A. Lutsik
1961We11	PHRVA	124,	527	H.I. West, Jr., L.G. Mann, R.J. Nagle
1961Ya01	PHRVA	121,	600	S.S. Yamamoto, F.E. Steigert
1961Zy02	APPOA	20,	321	J. Żylicz, Z. Preibisz, S. Chojnacki, J. Wolowski, Y. Norseev
1962				
1962An05	ZENAA	17,	238	G. Andersson-Lindstrom
1962Ar05	PRLTA	9,	405	P.E. Argan, G. Bendiscioli, A. Piazzoli, V. Bisi, M.I. Ferrero, G. Piragino
1962Ba23	PRLTA	9,	16	R.C. Barber, L.A. Cambey, J.H. Ormrod, R.L. Bishop, H.E. Duckworth
1962Ba24	CJPHA	40,	1496	R.C. Barber, R.L. Bishop, L.A. Cambey, W. McLatchie, H.E. Duckworth
1962Ba26	PHRVA	127,	583	R.K. Bardin, C.A. Barnes, W.A. Fowler, P.A. Seeger
1962Ba28	NUPHA	33,	347	B. Basu, A.P. Patro
1962Ba32	AFYSA	21,	65	E. Bashandy, M.S. El-Nesr
1962Bj01	NUPHA	30,	488	S. Bjornholm, O.B. Nielsen
1962Bo22	IANFA	26,	975	N.A. Bonch-Osmolovskaya, K. Ya. Gromov, B.S. Dzelepov, O.E. Kraft, T.V. Malysheva, L.N. Nikityuk, B.A. Khotin, Chzhou, Yue-Va, V.G. Chumin
1962Bo25	AFYSA	22,	111	E.C.O. Bonacalza, P. Thieberger, I. Bergström
1962Br10	PHRVA	125,	992	C.P. Browne, W.E. Dorenbusch, J.R. Erskine
1962Br15	PHRVA	125,	1323	H.W. Brandhorst, Jr., J.W. Cobble
1962Bu16	PHRVA	127,	844	M.E. Bunker, B.J. Dropesky, J.D. Knight, J.W. Starner
1962Ch21	ZETFA	43,	453	V.L. Chikhladze, D.E. Khulelidze, R.A. Ryukhin
1962Cr04	NUPHA	34,	580	J.G. Cramer, Jr., C.M. Class
1962Da03	NUPHA	31,	293	H. Daniel
1962Ei02	NUPHA	35,	625	E. Eichler, G.D. O'Kelley, R.L. Robinson, J.A. Marinsky, N.R. Johnson
1962Ei02	NUPHA	31,	128	M.S. El-Nesr, E. Bashandy
1962Ew01	NUPHA	29,	153	G.T. Ewan, R.L. Graham, J.S. Geiger
1962Fr07	ZEPYA	169,	456	L. Frevert
1962Fr09	NUPHA	38,	89	J.M. Freeman, D. West
1962Fu16	NUPHA	39,	147	E.G. Funk, Jr., J.W. Mihelich, C.F. Schwerdtfeger
1962Ga07	NUPHA	33,	285	C.J. Gallagher, Jr., M. Jorgensen, O. Skilbreid

1962Gu03	PHRVA	126,	642	R. Gunnink, A.W. Stoner
1962Hi01	NUPHA	31,	118	S. Hinds, M. Marchant, R. Middleton
1962Hi06	NUPHA	38,	81	S. Hinds, H. Marchant, R. Middleton
1962Ho14	PHRVA	128,	2748	D.A. Howe, L.M. Langer, E.H. Spejewaki, D.E. Wortman
1962In01	NUPHA	38,	50	H. Inoue, J. Ruan, S. Yasukawa, Y. Yoshizawa
1962Ka08	NUPHA	32,	25	T. Katoh, M. Nozawa, Y. Yoshizawa
1962Ka23	NUPHA	36,	394	T. Katoh, M. Nozawa, Y. Yoshizawa, Y. Koh
1962Ka27	AAFPA	6,	96	P. Kauranen
1962Kh05	IANFA	26,	1036	D.E. Khulelidze, V.L. Chikhladze, N.A. Vartenov, Y.A. Kyukhin
1962Ko10	NUPHA	39,	89	K. Kotajima
1962Ko12	IANFA	26,	235	G.A. Korolev, G.E. Kocharov
1962La10	NUPHA	35,	582	N.L. Lark, P.F.A. Goudsmit, J.F.W. Jansen, J.E.J. Oberski, A.H. Wapstra
1962Li03	NUPHA	31,	584	E.W.A. Lingeman, K.E.G. Lobner, G.J. Nijgh, A.H. Wapstra
1962Lo10	ZETFA	43,	1579	V.M. Lobashov, V.A. Nazarenko, L.F. Saenko
1962Ma06	PHRVA	125,	942	H.J. Martin, Jr., M.B. Sampson, R.L. Preston
1962Ne08	PHRVA	125,	2005	J.W. Nelson, H.S. Plendl, R.H. Davis
1962No06	NUPHA	36,	411	M. Nozawa
1962Nu01	PHRVA	127,	943	M. Nurmia, P. Kauranen, A. Siivola
1962Pa05	PHRVA	127,	1258	A.P. Patro, B. Basu
1962Pe08	HPACA	35,	175	C.F. Perdrisat, J.H. Brunner, H.J. Leisi
1962Pe15	PHRVA	127,	917	I. Perlman, F. Asaro, A. Ghiorso, A. Larsh, R. Latimer
1962Pi02	PHRVA	127,	1708	W.R. Pierson, H.C. Griffin, C.D. Coryell
1962Pu01	NUPHA	36,	1	D.J. Pullen, A.E. Litherland, S. Hinds, R. Middleton
1962Ru05	NUPHA	36,	431	J. Ruan, Y. Yoshizawa, Y. Koh
1962Sc04	PHRVA	125,	1641	C.F. Schwerdtfeger, E.G. Funk, Jr., J.W. Mihelich
1962Se03	PHRVA	125,	968	M.L. Seghal
1962Sh01	NUPHA	29,	177	R.K. Sheline, R.A. Harlan
1962Si14	AAFPA	6,	109	A. Siivola
1962Un01	NUPHA	36,	284	J. Unik, P. Day, S. Vandenbosch
1962Va08	NUPHA	30,	177	S.E. Vandenbosch, P. Day
1962Va10	NUPHA	31,	406	B. Van Nooijen, H. van Krugten, W.J. Wieseahn, A.H. Wapstra
1962Wa15	PHMAB	7,	105	D.E. Watt, R.N. Glover
1962Wa16	NUPHA	31,	575	A.H. Wapstra, J.F.W. Jansen, P.F.A. Goudsmit, J. Oberski
1962Wa18	NUPHA	35,	232	R.J. Walen, V. Nedovesov, G. Bastin-Scoffier
1962Wa20	NUPHA	36,	207	L.B. Warner, R.K. Sheline
1962Wa28	COREA	255,	1604	R.J. Walen
1962Ya01	NUPHA	30,	68	T. Yamazaki, H. Ikegami, M. Sakai
1963				
1963Ab02	PHLTA	5,	359	A. Abdumalikov, A. Abdurazakov, K. Gromov, Z. Zhelev, N. Lebedev, B. Dzelepov, A. Kudryavtseva
1963Ba20	CJPHA	41,	696	R.C. Barber, R.L. Bishop, W. McLatchie, P. Van Rookhuyzen, H.E. Duckworth
1963Ba31	NUPHA	43,	264	C.V.K. Baba, G.T. Ewan, J.F. Suarez
1963Ba32	NUPHA	43,	285	C.V.K. Baba, G.T. Ewan, J.F. Suarez
1963Ba37	ZETFA	44,	35	N.B. Badalov, S.S. Vasilenko, M.G. Kaganskii, D.L. Kaminskii, M.K. Nikitin
1963Ba47	CJPHA	41,	1482	R.C. Barber, W. McLatchie, R.L. Bishop, P. Van Rookhuyzen, H.E. Duckworth
1963Ba52	PHRVA	132,	1763	F.J. Bartis
1963Bi03	NUPHA	41,	21	K.M. Bisgard, P. Dahl, P. Hornshoj, A.B. Knutsen
1963Bi12	CJPHA	41,	1532	R.L. Bishop, R.C. Barber, W. McLatchie, J.D. Macdougall, P. Van Rookhuyzen, H.E. Duckworth
1963Bj01	NUPHA	42,	469	S. Bjornholm, F. Boehm, A.B. Knutsen, O.B. Nielsen
1963Bj02	NUPHA	42,	642	S. Bjornholm, O.B. Nielsen
1963Bo07	PHRVA	130,	1078	R.O. Bondelid, J.W. Butler
1963Bo14	PHYSA	29,	277	P. Born, C. Bobeldijk, W.A. Oost, J. Blok
1963Bo17	PHYSA	29,	535	P. Born, A. Veefkind, W.H. Elsenaar, J. Blok
1963Ca03	PHRVA	129,	1782	D.C. Camp, L.M. Langer
1963Ca06	PHRVA	132,	2239	T.A. Carlson
1963Ch03	NUCIA	27,	86	G. Chilosi, P. Cuzzocrea, G.B. Vingiani, R.A. Ricci, H. Morinaga

1963Cr06	PHRVA	132,	1681	B. Crasemann, G.T. Emery, W.R. Kane, M.L. Perlman
1963Da03	ZEPYA	172,	202	H. Daniel, O. Mehling, D. Schotte
1963Da10	PHRVA	132,	1673	R.A. Damerow, R.R. Ries, W.H. Johnson, Jr.
1963De11	JINCA	25,	741	P. Del Marmol, P.F. Fettweis
1963Di05	JINCA	25,	143	H. Diamond, J.E. Gindler
1963Do07	PHRVA	132,	2600	I. Dostrovsky, S. Katcoff, R.W. Stoenner
1963Dz07	ZETFA	45,	1360	B.S. Dzelepov, R.B. Ivanov, V.G. Nedovesov, V.P. Chechev
1963Em02	PHRVA	129,	2597	G.T. Emery, W.R. Kane, M. McKeown, M.L. Perlman, G. Scharff-Goldhaber
1963Fr04	PHRVA	131,	772	A.M. Friedman, J. Milsted
1963Fr10	PHRVA	132,	2169	G. Frick, A. Gallmann, D.E. Alburger, D.H. Wilkinson, J.P. Coffin
1963Fu17	KERNA	6,	152	L. Funke, K. Hohmuth, H. Jungclaussen, K.-H. Kaun, G. Muller, H. Sodan, L. Werner
1963Ga09	PHRVA	131,	1759	B.R. Gasten
1963Ge02	NUPHA	40,	177	K.N. Geller
1963G104	PHRVA	130,	299	N.W. Glass, R.W. Peterson
1963Go06	NUCIA	30,	14	K.P. Gopinathan, M.C. Joshi, M. Radha Menon
1963Gr08	AAFPA	6,	128	G. Graeffe
1963Gr.A	BAPSA	8,	486	D.E. Groce, J.H. McNally, W. Whaling
1963Gu04	PHRVA	131,	301	R. Gunnink
1963Ho18	JINCA	25,	1303	R.W. Hoff, F. Asaro, I. Perlman
1963Ho.A	PrvCom	AHW		A.M. Hoogenboom
1963Ik01	NUPHA	41,	130	H. Ikegami, K. Sugiyama, T. Yamazaki, M. Sakai
1963Ja06	NUPHA	41,	303	A. Jasinski, J. Kownacki, H. Lancman, J. Ludziejewski, S. Chojnacki, I. Yutlandov
1963Ja12	PHLTA	6,	69	J. Jaenecke
1963Jo04	NUPHA	41,	167	C.H. Johnson, F. Pleasonton, T.A. Carlson
1963Ka21	PHLTA	6,	98	M. Karras, J. Kantele
1963Ko08	PHRVA	130,	1503	P.F.M. Koehler, L. Slack, N.B. Gove
1963Kr04	CZYPA	13,	79	B. Kracik, Z. Miligui, V. Brabec, M. Vejs, A. Mastalka, T. Kucarova
1963Ku22	NUPHA	48,	675	T. Kuroyanagi, T. Tamura
1963La06	PHRVA	132,	324	L.M. Langer, D.E. Wortman
1963Ma27	NUPHA	44,	309	B.E.F. Macefield, R. Middleton, D.J. Pullen
1963Me06	NUPHA	46,	233	D.G. Megli, T.T. Thwaites
1963Me08	NUPHA	48,	90	M.K. Mehta, W.E. Hunt, H.S. Plendl, R.H. Davis
1963Mi17	NUPHA	49,	315	K. Miyano, T. Kuroyanagi
1963Ne05	PHRVA	129,	1723	J.W. Nelson, E.B. Carter, G.E. Mitchell, R.H. Davis
1963Ok01	JUPSA	18,	1563	K. Okano, K. Nishimira
1963Or01	PHRVA	132,	355	C.J. Orth, M.E. Bunker, J.W. Starnier
1963Pa09	NUPHA	45,	336	M. Pasternak, T. Sonnino
1963Pe11	AFYSA	23,	1	L. Persson, R. Hardell, S. Nilsson
1963Pe13	NUPHA	44,	653	L. Persson, H. Ryde, K. Oelsner-Ryde
1963Pe16	PHLTA	6,	347	L. Persson
1963PI01	CZYPA	13,	23	Z. Plajner, L. Maly, N. Eissa, A. Benadek
1963Pr13	BAPMA	11,	691	Z. Preibisz, K. Pawlak, K. Stryczniewicz
1963Rh02	PHRVA	131,	1227	J.I. Rhode, O.E. Johnson
1963Ri07	PHRVA	132,	1662	R.R. Ries, R.A. Damerow, W.H. Johnson, Jr.
1963Ro10	PHRVA	129,	2653	P.C. Rogers, G.E. Gordon
1963Ry01	AFYSA	23,	171	H. Ryde, L. Persson, K. Oelsner-Ryde
1963Ry04	NUPHA	43,	229	A. Rytz, H.H. Staub, H. Winkler, F. Zamboni
1963Sc15	PHRVA	132,	2650	F. Schima, E.G. Funk, Jr., J.W. Mihelich
1963St06	NUPHA	41,	524	W.A. Stensland, A.F. Voigt
1963Su.A	Th.-Berkeley			V.B. Subrahmanyam
1963Ta05	NUPHA	41,	221	H.W. Taylor, G.N. White, R. McPherson
1963Th02	NUPHA	41,	380	B.V. Thosar, R.P. Sharma, K.G. Prasad
1963Th03	PHRVA	129,	1778	T.T. Thwaites
1963Va24	PHYSA	29,	990	C. van der Leun, P.M. Endt
1963Va37	ZETFA	45,	1385	S.S. Vasilev, L.Y. Shavtvalov
1963Ve09	PHRVA	132,	1736	M.N. Vergnes, R.K. Sheline
1963Wo01	PHRVA	131,	325	D.E. Wortman, L.M. Langer

1963Wo04	RAACA	1,	225	G. Wolzak, H. Morinaga
1963Wu01	CHJPB	19,	524	P.-K. Wung, G.-G. Yan, S.-K. Chu, S.-P. Chen, S. Huo, S.-F. Wang, L.-S. Chen
1963Yo07	NUPHA	46,	78	Y. Yoshizawa, H. Okamura, S. Iwata, I. Fugiwara, T. Shigematsu, M. Tabushi, T. Tarumoto, K. Sakamoto
1963Zy01	NUPHA	42,	330	J. Żylicz, Z. Sujkowski, J. Jastrzebski, O. Wolczek, S. Chojnacki, I. Yutlandov
			1964	
1964Ag.A	P-Tbilis		63	V.K. Ageev, K.Y. Gromov, B.S. Dzelepov, Z. Zhelev, V. Kalinnikov, A. Kudryavtseva
1964Al29	AFYSA	26,	235	N.H. Albins
1964An12	JOPQA	25,	673	S. Andre, P. Depommier
1964Ar17	AFYSA	26,	153	S.E. Arnell
1964As01	PLRBA	133,	291	F. Asaro, S. Bjornholm, I. Perlman
1964Ba03	CJPHA	42,	391	R.C. Barber, W. McLatchie, R.L. Bishop, J.D. Macdougall, P. van Rookhuizen, H.E. Duckworth
1964Ba13	NUPHA	52,	125	H. Bakhru, S.K. Mukherjee
1964Ba15	PRLTA	12,	597	R.C. Barber, H.E. Duckworth, B.G. Hogg, J.D. Macdougall, W. McLatchie, P. Van Rookhuizen
1964Ba36	PLRBA	136,	603	E.L. Bahn, Jr., B.D. Pate, R.D. Fink, C.D. Coryell
1964Ba46	ZETFA	47,	1162	K.A. Baskova, S.S. Vasilev, M.A. Khamo-LEILA, L.Y. Shavtvalov
1964Be10	NUPHA	50,	657	U. Bertelsen, G.T. Ewan, H.L. Nielsen
1964Bj02	PLRBA	136,	1348	J.H. Bjerregaard, H.R. Blieden, O. Hansen, G. Sidenius, G.R. Satchler
1964B111	NUPHA	55,	331	K.J. Blinowska, P.G. Hansen, H.L. Nielsen, O. Schult, K. Wien
1964Bo10	PLRBA	134,	591	R.O. Bondelid, E.E. Dowling Whiting
1964Bo13	NUPHA	53,	618	R.O. Bondelid, J.W. Butler
1964Bo25	AFYSA	26,	141	E.C.O. Bonacalza
1964Br08	PLRBA	134,	133	C.P. Browne, I. Michael
1964Br09	JINCA	26,	677	R.L. Brodzinski, J.R. Finkel, D.C. Conway
1964Bu10	PLRBA	136,	1	S.B. Burson, E.B. Shera, T. Gedayloo, R.G. Helmer, D. Zei
1964Bu12	JINCA	26,	1491	F.D.S. Butement, S.M. Qaim
1964Ch17	NUPHA	55,	577	P. Christmas
1964Ch19	PRLTA	13,	665	L.F. Chase, Jr., H.A. Grench, R.E. McDonald, F.J. Vaughn
1964Co11	PLRBA	135,	383	B.L. Cohen, R. Patell, A. Prakash, E.J. Schneid
1964Da11	NUPHA	55,	643	E.A. Davis, T.W. Bonner, D.M. Worley, Jr., R. Bass
1964Da15	NUPHA	56,	147	H. Daniel, J. Huefner, T. Lorenz, O.W.B. Schult, U. Gruber
1964Da16	PLRBA	136,	1240	H. Daniel, G. Th. Kaschl, H. Schmitt, K. Springer
1964De02	PLRBA	133,	568	S.H. Devare, H.G. Devare
1964De10	PLRBA	134,	705	S.H. Devare, H.G. Devare
1964De15	P-Vienna		430	R.A. Demirkhanov, V.V. Dorokhov, M.I. Dzkuya
1964De16	PHYSA	30,	1938	A. De Beer, H.P. Blok, J. Blok
1964Ej05	NUPHA	59,	625	H. Ejiri, Y. Nogami, Y. Nakajima, K. Horie, K. Etoh, A. Sugawara
1964Er02	PLRBA	133,	370	J.R. Erskine, W.W. Buechner
1964Er06	PLRBA	135,	110	J.R. Erskine
1964Fi02	PLRBA	133,	1502	T.R. Fisher, W. Whaling
1964FI02	RAACA	2,	210	J. Fleggenheimer, G.B. Baro
1964Fr04	CZYPA	14,	152	J. Frana, I. Rezanka
1964Fu08	NUPHA	60,	294	M. Fujioka, K. Hisatake, K. Takahashi
1964Fu11	NUPHA	55,	401	L. Funke, H. Graber, K.-H. Kaun, H. Sodan, L. Werner
1964Go08	PLRBA	134,	297	K.P. Gopinathan, M.G. Joshi
1964Gr04	PHRVA	133,	1373	R.D. Griffioen, R.D. Macfarlane
1964Gr11	AAFPA	6,	145	G. Graeffe, K. Valli, J. Aaltonen
1964Ha29	PHYSA	30,	1802	J.H. Hamilton, K.E.G. Lobner, A.R. Sattler, R. van Lieshout
1964Ho03	JINCA	26,	1769	D.C. Hoffman, W.R. Daniels
1964Ho08	NUPHA	52,	590	K. Hohmuth, G. Muller, J. Schintlmeister
1964Ho14	PRLTA	13,	241	R.E. Holland, F.J. Lynch, K.-E. Nysten
1964Ho28	APASA	18,	309	I. Hofman
1964Jo03	PHLTA	8,	61	H.S. Johansen, M. Jorgensen, O.B. Nielsen, G. Sidenius
1964Jo09	NUPHA	52,	301	M.C. Joshi, B.V. Thosar, K.G. Prasad

1964Jo11	PLRBA	136,	1719	C.H. Johnson, C.C. Trail, A. Galonsky
1964Ka08	PLRBA	133,	1504	R.W. Kavanagh
1964Ka10	PLRBA	135,	9	J. Kantele, M. Karras
1964Ka16	AAFPA	6,	162	J. Kantele, K.M. Broom, D.M. Chittenden
1964Ka23	AFYSA	27,	61	S.E. Karlsson, O. Bergman, W. Scheuer
1964Ke03	PLRBA	133,	25	R.A. Kenefick, R.K. Sheline
1964Ku02	NUPHA	50,	417	T. Kuroyanagi, T. Tamura, K. Tanaka, H. Morinaga
1964La03	PLRBA	133,	1145	L.M. Langer, E.H. Spejewski, D.E. Wortman
1964La13	PLRBA	135,	581	L.M. Langer, E.H. Spejewski, D.E. Wortman
1964Le05	NUPHA	50,	648	H. Leutz, K. Ziegler
1964Le09	JOPQA	25,	326	J. Lehmann
1964Le10	PLRBA	134,	752	J.C. Legg, E. Rost
1964Li10	NUPHA	59,	504	P. Lipnik, G. Pralong, J.W. Sunier
1964Ma30	CJPHA	42,	1700	K.C. Mann, F.A. Payne, R.P. Chaturvedi
1964Ma36	CZYPA	14,	240	L. Maly, Z. Plajner, J. Jursik, M. Finger
1964Ma.A	P-Vienna		279	J.B. Marion
1964Ma.B	P-Vienna		305	M. Mazari, A. Jaidar, G. Lopez, A. Tejera, J. Caracea, R. Dominguez, F. Alba
1964Mc07	CJPHA	42,	926	W. McLatchie, R.C. Barber, R.L. Bishop, H.E. Duckworth
1964Mc11	PHLTA	10,	330	W. McLatchie, R.C. Barber, H.E. Duckworth, P. Van Rookhuyzen
1964Mc21	CPHMA	30,	#4	J.D. McCoy
1964Mi04	NUPHA	51,	50	R. Middleton, D.J. Pullen
1964Mi.A	P-Vienna		329	R. Middleton, H. Marchant
1964Mo18	PHLTA	11,	148	H. Morinaga, G. Wolzak
1964Mo.A	P-Vienna		423	P.E. Moreland, Jr., K.T. Bainbridge
1964Ne10	PLRBA	135,	325	C.L. Nealy, R.K. Sheline
1964No06	PLRBA	136,	40	L.R. Norris, C.F. Moore
1964Nu02	AAFPA	6,	148	M. Nurmia, G. Graeffe, K. Valli, J. Aaltonen
1964On03	PLRBA	136,	365	R.J. Onega, W.W. Pratt
1964Pa03	APASA	18,	315	H. Paul
1964Pe17	PLRBA	136,	330	N.F. Peek, J.A. Jungerman, C.G. Patten
1964Ro17	PLRBA	136,	664	B. Rosner
1964Sa12	NUPHA	53,	457	R.C. Salgo, H.H. Staub, H. Winkler, F. Zamboni
1964Sa32	SHIBA	5,	54	K. Sato
1964Sc27	IDO-17042		11	R.P. Schuman
1964Sh04	PHLTA	8,	121	R.K. Sheline, C. Watson, E.W. Hamburger
1964Sh06	PLRBA	133,	624	W.N. Shelton, R.K. Sheline
1964Sh13	PLRBA	136,	351	R.K. Sheline, W.N. Shelton, H.T. Motz, R.E. Carter
1964Sh21	JUPSA	19,	245	Y. Shida
1964Si18	PLRBA	136,	618	R.J. Silva, G.E. Gordon
1964Sm03	PHYSA	30,	1197	P.J.M. Smulders
1964So01	NUPHA	54,	568	T. Sonino, E. Eichler, S. Amiel
1964Sp12	P-Vienna		289	A. Sperduto, W.W. Buechner
1964St01	PLRBA	133,	911	P.H. Stelson, F.K. McGowan
1964Ta11	JUPSA	19,	587	E. Takekoshi, Z.-I. Matumoto, M. Ishii, K. Sugiyama, S. Hayashibe, H. Sekiguchi, H. Natsume
1964Te02	JINCA	26,	1129	G.P. Tercho, J.A. Marinsky
1964Th05	NUPHA	60,	35	K.S. Thorne, E. Kashy
1964To04	PLRBA	136,	1233	K.S. Toth, T.H. Handley, E. Newman, I.R. Williams
1964Va05	PHLTA	9,	164	R. van Lieshout, S. Monaro, G.B. Vingiani, H. Morinaga
1964Va20	AAFPA	6,	165	K. Valli
1964Ve02	NUPHA	57,	451	E. Veje, C. Droste, O. Hansen, S. Holm
1964Wa14	NUPHA	54,	519	C. Watson, C.F. Moore, R.K. Sheline
1964We06	PLRBA	134,	257	P. Weinzierl, E. Ujlaki, G. Preinreich, G. Eder
1964Wi07	PLRBA	135,	289	D.C. Williams, R.A. Naumann
1964Yn03	PLRBA	134,	976	J.L. Yntema, G.R. Satchler
1965				
1965An05	AFYSA	28,	37	G. Andersson, G. Rudstam, G. Sorensen

1965An07	NP-15663			S.C. Anspach, L.M. Cavallo, S.B. Garfinkel, J.M.R. Hutchinson, C.N. Smith
1965Ba29	PLRBA	140,	904	J.B. Ball, R.F. Sweet
1965Ba48	IANFA	29,	2255	Ts. Vylov, V.M. Gorodzankin, K. Ya. Gromov, V.V. Kuznetsov
1965Be19	PHLTA	18,	293	D. Berenyi, C. Ujhelyi, I. Feher
1965Be24	NUPHA	74,	459	H. Beekhuis, H. de Waard
1965Bi04	PLRBA	138,	514	W.N. Bishop
1965Bi12	IANFA	29,	151	E.I. Biryukov, V.T. Novikov, N.S. Shimanskaya
1965BI06	AFYSA	28,	415	P.H. Blichert-Toft
1965B113	PLRBA	140,	1567	A.G. Blair, D.D. Armstrong
1965Br12	PLRBA	138,	1368	R.L. Brodzinski, D.C. Conway
1965Br25	PHYSA	31,	1305	G.A. Brinkman, A.H.W. Aten, Jr., J.T. Veenboer
1965Br28	NUPHA	72,	194	C.P. Browne, W.E. Dorenbusch, F.H. O'Donnell
1965Br31	NUPHA	72,	529	L. Broman, J. Dubois
1965Bu03	JINCA	27,	907	F.D.S. Butement, S.M. Quaim
1965Bu07	NUPHA	65,	561	J. Burde, M. Rakavi, G. Adam
1965Ce02	PRLTA	15,	300	J. Cerny, C. Détraz, R.H. Pehl
1965Co06	CJPHA	43,	383	C.R. Cothorn, R.D. Connor
1965Cr04	NUPHA	70,	129	T. Cretzu, K. Hohmuth, J. Schintlmeister
1965Da01	NUPHA	63,	145	H. Daniel, M. Kuntze, B. Martin, P. Schmidlin, H. Schmitt
1965De08	PRLTA	14,	708	C. Détraz, J. Cerny, R.H. Pehl
1965De09	PLRBA	138,	540	J.W. Dewdney, K.T. Bainbridge
1965De13	IANFA	29,	859	R.A. Demirkhanov, V.V. Dorokhov, M.I. Dzkuya
1965De15	YAFIA	1,	198	A.G. Demin, Y.P. Kushakevich
1965De20	NUPHA	73,	49	S.A. De Wit, A.H. Wapstra
1965De22	PLRBA	140,	536	S.H. Devare, R.M. Singru, H.G. Devare
1965Du02	COREA	261,	98	J.C. Duperrin, A. Guizon-Juillard
1965Er02	PLRBA	138,	851	J.R. Erskine
1965Er03	PLRBA	138,	66	J.R. Erskine
1965FI02	NSENA	22,	416	K.F. Flynn, L.E. Glendenin, E.P. Steinberg
1965Fr04	NUPHA	64,	303	K. Fritze
1965Fr12	PLRBA	140,	563	M.S. Freedman, F.T. Porter, F. Wagner, Jr.
1965Fu13	NUPHA	70,	335	L. Kunke, H. Graber, K.-H. Kaun, H. Sodan, L. Werner
1965Go05	PLRBA	137,	1466	S. Gorodetsky, A. Gallmann, R. Rebmeister
1965Gr35	YAFIA	2,	783	K.Y. Gromov, Z.T. Zhelev, V. Zvolska, V.G. Kalinnikov
1965Gu03	NUPHA	64,	401	M. Guttman, E.G. Funk, Jr., J.W. Mihelich
1965Ha30	PHLTA	19,	304	P.G. Hansen, H.L. Nielsen, K. Wilsky, J. Treherne
1965Ho07	NUPHA	71,	449	C.G. Hoot, M. Kondo, M.E. Rickey
1965Hs02	NUPHA	73,	379	S.T. Hsue, L.M. Langer, S.M. Tang, D.A. Zollman
1965Is01	ZENAA	20,	541	A. Isola, M. Nurmia
1965Iv01	IANFA	29,	157	Y.F. Ivanov, I.A. Rumer, A.Y. Bukach
1965Iw01	JUPSA	20,	2105	T. Iwashita
1965Jo04	NUPHA	61,	385	M.W. Johns, M. Kawamura
1965Jo13	NUPHA	72,	617	N.R. Johnson, K. Wilsky, P.G. Hansen, H.L. Nielsen
1965Ka07	JINCA	27,	1451	P. Kauranen, H. Ihochi
1965Ke04	NUPHA	61,	513	W.J. Keeler, R.D. Connor
1965Ke09	PLRBA	139,	1479	R.A. Kenefick, R.K. Sheline
1965Ko09	ZENAA	20,	969	W. Kohler, K. Knopf
1965Ku02	NUPHA	64,	524	H.-M. Kuan, J.R. Risser
1965Kv01	NUPHA	74,	27	E. Kvale, A.C. Pappas
1965Le06	NUPHA	63,	263	H. Leutz, K. Schneckenberger, H. Wennige
1965Le07	NUPHA	65,	337	W.H.G. Lewin, J. Lettinga, B. van Nooijen, A.H. Wapstra
1965Ma07	PHLTA	14,	46	A. Marinov, J.R. Erskine
1965Ma12	PRLTA	14,	114	R.D. Macfarlane, A. Siivola
1965Ma32	NUPHA	67,	73	J.H.E. Mattauch, W. Thiele, A.H. Wapstra
1965Ma51	IANFA	29,	1121	I. Mahunka, T. Fenyes
1965Mc09	PLRBA	140,	1513	R. McPherson, R.A. Easterlund, A.M. Poskanzer, P.L. Reeder
1965Me02	JINCA	27,	33	D. Metta, H. Diamond, R.F. Barnes, J. Milsted, J. Gray, Jr., D.J. Henderson, C.M. Stevens
1965Me12	PHLTA	19,	133	R. Messlinger, H. Morinaga, C. Signorini

1965Mo05	NUPHA	61,	613	S. Morinobu, T. Hirose, K. Hisatake
1965Mo16	NUPHA	74,	403	R. Moreh, T. Daniels
1965Mo19	NUPHA	70,	293	R. Moreh
1965Mu09	NUPHA	67,	466	A. Mukerji, D.N. McNelis, J.W. Kane, Jr.
1965Ne02	NUPHA	62,	434	J.W. Nelson, J.D. Oberholtzer, H.S. Plendl
1965Og01	NUPHA	66,	119	I. Ogawa, T. Doke, M. Miyajima, A. Nakamoto
1965Pa08	NUPHA	72,	326	H. Paul
1965Pe18	AFYSA	29,	423	H. Pettersson, O. Berhman, C. Bergman
1965Pi01	NUPHA	73,	131	H.S. Plendl, L.J. Defelice, R.K. Sheline
1965Pr03	NUPHA	67,	302	W.V. Prestwich, T.J. Kennett
1965Ra02	PLRBA	137,	13	A.V. Ramaya, Y. Yoshizawa
1965Re07	NUPHA	65,	609	R. Reising, B.D. Pate
1965Ri06	PHLTA	17,	296	M.E. Rickey, P.D. Kunz, J.J. Kraushaar, W.G. Anderson
1965Ry01	NUPHA	70,	369	A. Rytz
1965Sc19	PLRBA	140,	1496	F. Schima, T. Katoh
1965Si06	NUPHA	64,	161	A. Siivola, G. Graeffe
1965St06	PLRBA	137,	772	G.L. Struble, J. Kern, R.K. Sheline
1965Va02	NUPHA	63,	241	B. Van Nooijen, W. Lourens, H. van Krugten, A.H. Wapstra
1965Wa14	PLRBA	140,	882	W.N. Wang, E.J. Winhold
1965Wi08	PHLTA	15,	143	E.T. Williams, P.G. Hansen, J. Lipperts, H.L. Nielsen, K. Wilsky
1965Za01	PLRBA	137,	1479	C.D. Zafiratos, F. Ajzenberg-Selove, F.S. Dietrich
1966				
1966Ah.A	UCRL-16580		21	I. Ahmad, F. Asaro, I. Perlman
1966Ah.B	Th.-Berkeley			I. Ahmad
1966Ak01	AENGA	21,	243	G.N. Akapev, A.G. Demin, V.A. Druin, E.G. Imaev, I.V. Kolesov, Y.V. Lobanov, L.P. Pashchenko
1966An10	CHDBA	262,	214	S. Andre, P. Depommier
1966Au04	NUPHA	81,	441	R.L. Auble, W.H. Kelly
1966Av03	IANFA	30,	542	M.P. Avotina, E.P. Grigorev, B.S. Dzelepov, A.V. Zolotavin, V.O. Sergeev
1966Ba07	YAFIA	4,	1108	S.A. Baranov, Y.F. Rodionov, V.M. Kulakov, V.M. Shatinskii
1966Ba14	CHDBA	262,	89	G. Bastin, C.F. Leang, R.J. Walen
1966Ba19	CHDBA	262,	370	G. Bastin, C.F. Leang, R.J. Walen
1966Be10	PHRVA	141,	1112	J.L. Benson, W.H. Johnson, Jr.
1966Be12	PHLTA	21,	205	H. Beekhuis
1966Be21	IANFA	30,	1130	Yu. I. Belyanin, E.I. Biryukov, N.S. Shimanskaya
1966Bj01	NUPHA	86,	145	J.H. Bjerregaard, O. Hansen, O. Nathan, S. Hinds
1966Bj02	NUPHA	85,	593	J.H. Bjerregaard, O. Nathan, S. Hinds, R. Middleton
1966Bl04	NUPHA	76,	45	L.M. Blau, W.P. Alford, D. Cline, H.E. Gove
1966Bl15	PHRVA	151,	930	A.G. Blair, D.D. Armstrong
1966Bo20	NUPHA	86,	187	B.E. Bonner, G. Rickards, D.L. Bernard, G.C. Phillips
1966Br05	NUPHA	77,	365	G. Brown, S.E. Warren, R. Middleton
1966Br06	NUPHA	77,	385	G. Brown, A. Macgregor, R. Middleton
1966Br14	NUPHA	81,	233	H.F. Brinckmann, C. Heiser, K.F. Alexander, W. Neubert, H. Rotter
1966Br18	PHRVA	149,	767	D.G. Burke, B. Zeidman, B. Elbek, B. Herskind, M. Olesen
1966Bu16	KDVSA	35,	#2	D.G. Burke, B. Zeidman, B. Elbek, B. Herskind, M. Olesen
1966Ca09	NUPHA	82,	471	R.C. Catura, J.R. Richardson
1966Ca10	NUPHA	85,	317	M.J. Canty, W.F. Davidson, R.D. Connor
1966Cu02	NUPHA	86,	481	R.Y. Cusson
1966Da04	NUPHA	76,	97	H. Daniel, G.T. Kaschl
1966Da06	PHRVA	147,	845	W.R. Daniels, D.C. Hoffman
1966De11	NUPHA	83,	289	E.Y. De Aisenberg, J.F. Suarez
1966Do02	PHRVA	146,	734	W.E. Dorenbusch, T.A. Belote, O. Hansen
1966Do06	NUPHA	81,	390	W.E. Dorenbusch, O. Hansen, D.J. Pullen, T.A. Belote, G. Sidenius
1966Ei01	PHRVA	146,	899	E. Eichler, J.W. Chase, N.R. Johnson, G.D. O'Kelley
1966El09	ORNL-3889		49	J.S. Eldridge, W.S. Lyon
1966Er02	PHRVA	142,	633	J.R. Erskine, A. Marinov, J.P. Schiffer
1966Fi06	PHRVA	150,	941	H.J. Fischbeck, F.T. Porter, M.S. Freedman, F. Wagner, Jr., H.H. Bolotin

1966Fr11	RAACA	5,	192	A.M. Friedman, J. Milsted, D. Metta, D. Henderson, J. Lerner, A.L. Harkness, D.J. Rokop
1966Fu05	NUPHA	84,	461	L. Funke, H. Graber, K.-H. Kaun, R. Ross, H. Sodan, L. Werner, J. Frana
1966Fu08	NUPHA	84,	424	L. Funke, H. Graber, K.-H. Kaun, H. Sodan, G. Geske, J. Frana
1966Ga03	NUPHA	76,	353	R. Gaeta, M.A. Vigon
1966Ga06	PHLTA	20,	669	J. Gastebois, M. Berloutaud, J.M. Lagat, J. Quidort
1966Ga08	PHRVA	147,	753	A. Gallmann, P. Fintz, J.B. Nelson, D.E. Alburger
1966Gl02	NUPHA	86,	279	K.M. Glibert, H.T. Easterday
1966Gr26	PHNOA	2,	1	A. Graue
1966Gu05	NUPHA	85,	288	S.G. Gujrathi, S.K. Mukherjee
1966Ha15	NUPHA	76,	257	P.G. Hansen, H.L. Nielsen, K. Wilsky, Y.K. Agarwal, C.V.K. Baba, S.K. Bhat-tacherjee
1966Ha29	NUPHA	84,	62	G.R. Hagee, R.C. Lange, J.T. McCarty
1966Ha32	PHLTA	23,	487	J.C. Hardy, D.J. Skyrme, I.S. Towner
1966He10	NUPHA	88,	561	P.V. Hewka, C.H. Holbrow, R. Middleton
1966Hi01	PHLTA	21,	328	S. Hinds, J.H. Bjerregaard, O. Hansen, O. Nathan
1966Hi06	NUPHA	84,	651	S. Hinds, R. Middleton
1966Hs01	NUPHA	80,	657	S.T. Hsue, L.M. Langer, E.H. Spejewski, S.M. Tang
1966Ja12	PHRVA	151,	956	A.D. Jackson, Jr., J.S. Evans, R.A. Naumann, J.D. McCullen
1966Jo07	NUPHA	84,	569	M.H. Jorgensen, O.B. Nielsen, O. Skilbreid
1966Ki06	CJPHA	44,	2661	J.E. Kitching, M.W. Johns
1966Kl02	NUPHA	79,	27	H. Klein, H. Leutz
1966La04	NUPHA	78,	1	T. Lauritsen, F. Ajzenberg-Selove
1966Le06	NUPHA	75,	81	H. Leutz, G. Schulz, H. Wenniger
1966Li04	PHRVA	141,	1089	A.C. Li, I.L. Preiss, P.M. Strudler, D.A. Bromley
1966Ma05	ZENAA	21,	63	J.D. Macdougall, W.M. McLatchie, S. Whineray, H.E. Duckworth
1966Ma18	PHLTA	21,	661	N. Mangelson, M. Reed, C.C. Lu, F. Ajzenberg-Selove
1966Ma49	IANFA	30,	1185	E.P. Mazets, Y.V. Sergeenkov
1966Ma51	IANFA	30,	1375	I. Mahunka, L. Tron, T. Fenyes, V.A. Khalkin
1966Ma60	RMPHA	38,	660	J. Marion
1966Mc13	NUPHA	88,	257	J.H. McNally
1966Mo06	PHRVA	141,	1166	C.F. Moore, P. Richard, C.E. Watson, D. Robson, J.D. Fox
1966Ne01	PRLTA	16,	28	E. Newman, J.C. Hiebert, B. Zeidman
1966No05	NUPHA	86,	102	A.E. Norris, G. Friedlander, E.M. Franz
1966Ny01	NUPHA	88,	63	B. Nyman, A. Johansson, C. Bergman, G. Backstrom
1966Pa06	CJPHA	44,	1029	P.J. Pan, Y.S. Horowitz, R.B. Moore, R. Barton
1966Pa18	NUPHA	85,	504	P.B. Parks, P.M. Beard, E.G. Bilpuch, H.W. Newson
1966Pa20	PHLTA	23,	269	B. Parsa, G.E. Gordon
1966Pe10	NUPHA	83,	33	H. Pettersson, G. Backstrom, C. Bergman
1966Po04	PHRVA	146,	774	F.T. Porter, M.S. Freedman, F. Wagner, Jr., K.A. Orlandini
1966Qa02	NUPHA	88,	285	S.N. Qaim
1966Ra03	PHRVA	142,	768	P.V. Rao, B. Crasemann
1966Re02	PHLTA	20,	40	W. Reichart, H.H. Staub, H. Stussi, F. Zamboni
1966Rg01	PHRVA	148,	1192	Research-Group, Combined Radioactivity Group LRL-LASL-UCRL-ANL
1966Ri01	NUPHA	75,	381	P. Riels
1966Ri09	NUPHA	86,	167	G. Rickards, B.E. Bonner, G.C. Phillips
1966Ry01	NUPHA	80,	241	H. Ryde, G.D. Symons, S. Szymanski
1966Sc17	PHRVA	149,	820	J.J. Schwartz, W. Parker, Q. Alford
1966Sc23	NUPHA	89,	401	D. Schwalm, B. Povh
1966Sc24	PHRVA	151,	950	F.J. Schima
1966Se07	NUPHA	85,	227	B. Sethi, S.K. Mukherjee
1966Sh03	PHRVA	143,	857	R.K. Sheline, C.E. Watson, B.P. Maier, U. Gruber, R.H. Koch, O.W.B. Shult, H.T. Motz, E.T. Journey, G.L. Struble, T. von Egidy, T. Elze, E. Bieber
1966Sh14	PHLTA	22,	648	W.N. Shelton, C.E. Watson
1966Sh16	PHRVA	151,	1011	R.K. Sheline, W.N. Shelton, T. Udagawa, E.T. Journey, H.T. Motz
1966Si08	NUPHA	84,	385	A. Siivola
1966Sm05	NUPHA	89,	561	K.M. Smith, G.M. Lewis
1966Sn02	PHRVA	147,	967	R.E. Snyder, G.B. Beard
1966St15	PHRVA	151,	969	M.M. Stautberg, J.J. Kraushaar

1966Va12	PHRVA	150,	886	J. Van Klinken, A.J. Bureau, G.W. Eakins, R.J. Hanson
1966Va.A	UCRL-16580		85	K. Valli, E.K. Hyde
1966Vo05	ZEPYA	195,	343	H. Vonach, H. Munzer, P. Hille
1966Wh01	PHRVA	150,	836	W. Whaling
1966Wi04	ZEPYA	191,	137	K. Wien
1966Wi11	PHLTA	22,	162	D.C. Williams, J.D. Knight, W.T. Leland
1966Wi12	NUPHA	84,	609	I.R. Williams, K.S. Toth, T.H. Handley
1966Yo01	PHLTA	22,	625	D.H. Youngblood, G.C. Morrison, R.E. Segel
1966Za01	NUPHA	77,	81	C.D. Zafiratos, F. Ajzenberg-Selove, F.S. Dietrich
1966Zy02	NUPHA	84,	13	J. Żylicz, P.G. Hansen, H.L. Nielsen, K. Wilsky
1967				
1967Ad03	PHRVA	159,	985	I. Adam, K.S. Toth, R.A. Meyer
1967Ah02	PHRVA	164,	1537	I. Ahmad, A.M. Friedman, R.F. Barnes, R.K. Sjoblom, J. Milsted, P.R. Fields
1967A108	NUPAB	98,	323	A.M. Aldridge, H.S. Plendl, J.P. Aldridge, III
1967An01	NUPAB	94,	289	S. Antman, H. Pettersson, A. Suarez
1967Ar01	PYLBB	24,	84	E. Arei, H. Miessner
1967As02	PHRVA	158,	1073	F. Asaro, I. Perlman
1967Ba01	NUPAB	91,	465	V.A. Balalaev, B.S. Dzelepov, L.N. Moskvina, S.A. Shetopalova, N.A. Voinova
1967Ba15	PHRVA	155,	1319	P.D. Barnes, J.R. Comfort, C.D. Bockelman
1967Ba32	PHRVA	159,	920	P.D. Barnes, J.R. Comfort, C.D. Bockelman, O. Hansen, A. Sperduto
1967Ba34	PHRVA	160,	1011	A. Backlin, A. Suarez, O.W.B. Schult, B.P.K. Mayer, U. Gruber, E.B. Shera, D.W. Hafemeister, W.N. Shelton, R.K. Sheline
1967Ba42	YAFIA	5,	241	S.A. Baranov, I.G. Aliev, L.V. Chistyakov
1967Ba43	YAFIA	5,	518	S.A. Baranov, M.K. Chadzhiev, V.M. Kulakov, V.M. Shatinskii
1967Ba51	CHDBA	265,	863	G. Bastin-Scoffier
1967Ba.A	P-Gatlinburg		261	C.A. Barnes, E.G. Adelsberger, D.C. Hensley, A.B. Macdonald
1967Be46	NUPAB	104,	241	G. Berzins, W.H. Kelly, G. Graeffe, W.B. Walters
1967Bi04	NUPAB	97,	203	L. Birstein, C. Drory, A.A. Jaffe, Y. Zioni
1967Bj01	NUPAB	94,	457	J.H. Bjerregaard, O. Hansen, O. Nathan, S. Hinds
1967Bj02	PHRVA	155,	1229	J.H. Bjerregaard, O. Hansen
1967Bj05	PHRVA	160,	889	J.H. Bjerregaard, O. Hansen, G.R. Satchler
1967Bj06	NUPAB	103,	33	J.H. Bjerregaard, O. Hansen, O. Nathan, R. Chapman, S. Hinds, R. Middleton
1967B119	PYLBB	25,	215	R. Bloch, R.E. Pixley, P. Truol
1967Bo41	YAFIA	6,	893	D.D. Bogdanov, S. Darotsi, V.A. Karnaukhov, L.A. Petrov, G.M. Ter-Akopyan
1967Br10	NUPAB	101,	163	G. Brown, J.G.B. Haigh, F.R. Hudson, A.E. Macgregor
1967Ca18	NUPAB	104,	35	M.J. Canty, R.D. Connor
1967Ch05	NUPAB	94,	417	P. Charoenkwan, J.R. Richardson
1967Ch16	NUPAB	102,	481	P.R. Christensen, B. Herskind, R.R. Borchers, L. Westgaard
1967Co15	PHRVA	157,	1065	J.R. Comfort, C.K. Bockelman, P.D. Barnes
1967Da10	CJPHA	45,	2295	W.F. Davidson, C.R. Cothorn, R.D. Connor
1967De02	NUPAB	94,	673	M.E. De Lopez, M. Mazari, T.A. Belote, W.E. Dorenbusch, O. Hansen
1967De15	JNCEA	21,	833	A.J. De Ruytter, P. Pelfer
1967Do03	NUPAB	102,	681	W.E. Dorenbusch, J. Rapaport, T.A. Belote
1967Dz02	IANFA	31,	568	B.S. Dzelepov, R.B. Ivanov, M.A. Mikhailov, L.N. Moskvina, O.M. Nazarenko, V.F. Radionov
1967Eh02	ZEPYA	207,	268	D. Ehrlich
1967Er02	P-Winnipeg		622	J.R. Erskine, A.M. Friedman, T.H. Braid, R.R. Chasman
1967Es02	PHRVA	156,	1094	R.A. Esterlund, R. McPherson, A.M. Poskanzer, P.L. Reeder
1967Fi04	PYLBB	24,	340	P.R. Fields, R.F. Barnes, R.K. Sjoblom, J. Milsted
1967FI05	YAFIA	5,	1186	G.N. Flerov, S.M. Polikhonov, V.L. Mikheev, V.I. Ilyushchenko, V.F. Kushniruk, M.B. Miller, A.M. Sukhov, V.A. Schegolev
1967FI15	AENGA	22,	342	G.N. Flerov, S.M. Polikhonov, V.L. Mikheev, V.I. Ilyushchenko, M.B. Miller, V.A. Shchegolev
1967Fo04	PHRVA	155,	1248	C.M. Fou, R.W. Zurmuhle, J.M. Joyce
1967Fr02	NUPAB	94,	366	J. Frana, I. Rezanka, Z. Plajner, A. Spalek, J. Jursik, M. Vobecky, A. Mastalka, L. Funke, A. Graber, H. Sodan
1967Gh01	PRLTA	18,	401	A. Ghiorso, T. Sikkeland, M.J. Nurmia

1967Go22	NUPAB	104,	497	P.F.A. Goudsmit, J. Konijn, F.W.N. De Boer
1967Go25	PHYSA	35,	479	P.F.A. Goudsmit
1967Go32	IANFA	31,	1618	N.A. Golovkov, K.Y. Gromov, N.A. Lebedev, B. Makhmudov, A.S. Rudnev, V.G. Chumin
1967Gr01	PYLBB	24,	171	M.W. Greene
1967Gr21	NUPAB	103,	209	A. Graue, E. Jastad, J.R. Lien, P. Torvund, W.H. Moore
1967Gu06	PHRVA	159,	909	S.C. Gujrathi, S.K. Mukherjee
1967Gu11	IJPYA	41,	633	S.C. Gujrathi, S.K. Mukherjee
1967Gu12	IJPYA	41,	667	S.C. Gujrathi, S.K. Mukherjee
1967Ha03	NUPAB	90,	573	S.K. Haynes, M. Velinsky, L.J. Velinsky
1967Ha04	PYLBB	24,	95	P.G. Hansen, H.L. Nielsen, K. Wilsky, J.G. Cuninghame
1967Ha08	NUPAB	92,	260	W.D. Harrison
1967Ha17	NUPAB	98,	330	H.J. Hay, D.C. Kean
1967Ha25	PHRVA	160,	1005	R.A. Harlan, R.K. Sheline
1967Ha.A	P-Winnipeg		527	O. Hansen
1967Hi01	PYLBB	24,	89	S. Hinds, H. Marchant, R. Middleton
1967Hi02	PYLBB	24,	34	S. Hinds, H. Marchant, R. Middleton
1967Hj01	AFYSA	33,	147	S.A. Hjorth
1967Hj03	AFYSA	33,	121	S.A. Hjorth, L.H. Allen
1967Ho01	NUPAB	90,	545	J.L. Honsaker
1967Ho12	PHRVA	159,	1000	K.J. Hofstetter, P.J. Daly
1967Ho19	AFYSA	36,	211	D.C. Hoffman, O.B. Michelsen, W.R. Daniels
1967Hs01	NUPAB	94,	146	S.T. Hsue, M.U. Kim, S.M. Tang
1967Hs03	NUPAB	101,	688	S.T. Hsue, M.U. Kim, L.M. Langer, E.H. Spejewski, J.B. Willet
1967Hu05	ZEPYA	203,	435	E. Huster, H. Verbeek
1967Hu07	CHDBA	265,	162	K. Hubenthal, J. Berthier, J.-C. Hocquenghem, A. Moussa
1967Ii01	YAFIA	6,	1117	V.I. Ilyushchenko, M.B. Miller, V.L. Mikheev, V.A. Shchegolev
1967Jo03	PHRVA	153,	1169	R.R. Johnson, N.M. Hintz
1967Jo18	P-Winnipeg		793	W.H. Johnson, M.C. Hudson, R.A. Britten, D.C. Kayser
1967Ka01	NUPAB	90,	23	V.A. Karnaukhov, G.M. Ter-Akopyan, L.S. Vertogradov, L.A. Petrov
1967Ka11	PHRVA	159,	931	A.A. Katsanos, J.R. Huizenga
1967Ke02	PHRVA	153,	1331	J. Kern, G.L. Struble, R.K. Sheline
1967Ki01	NUPAB	98,	337	J.E. Kitching, M.W. Johns
1967Ko01	NUPAB	90,	558	J. Konijn, E.W.A. Lingeman, S.A. De Wit
1967Le06	NUPAB	98,	273	J. Lehmann
1967Le21	AFYSA	36,	183	Y. Le Beyec, M. Lefort
1967Ma07	NUPAB	95,	632	A. Marelus, P. Sparrman, S.-E. Hagglund
1967Ma35	PHRVA	163,	1098	K.W. Marlow, M.A. Waggoner
1967Mc03	NUPAB	92,	401	W.R. McMurray, P. Van Der Merwe, I.J. Van Heerden
1967Mc07	NUPAB	99,	6	W.R. McMurray, M. Peisach, R. Pretorius, P. Van der Merwe, I.J. Van Heerden
1967Mc10	NUPAB	98,	577	M.F. McCann, G.M. Lewis, K.M. Smith
1967Mc14	PRLTA	19,	1442	R.L. McGrath, J. Cerny, E. Norbeck
1967Mi02	NUPAB	94,	261	R.G. Miller, R.W. Kavanagh
1967Mi03	AENGA	22,	90	V.L. Mikheev, V.I. Ilyushchenko, M.B. Miller, S.M. Polikanov, G.N. Flerov, Y.P. Kharitonov
1967Mi06	YAFIA	5,	49	V.L. Mikheev, V.I. Ilyushchenko, M.B. Miller
1967Mi13	JUPSA	23,	1191	K. Miyano
1967Mo10	CHDBA	264,	330	E. Monnard, J.A. Pinston, R. Henck
1967Mo11	PYLBB	25,	22	H. Morinaga, K. Miyano, K. Fujikawa, R. Chiba, K. Ebisawa, N. Kawai
1967Mo12	NUPAB	99,	652	J.A. Moragues, P. Reyes-Suter, T. Suter
1967Mo13	NUPAB	100,	45	Y. Motavalledi-Nobar, J. Berthier, J. Blachot, R. Henck
1967Mo17	NUPAB	102,	406	W.G. Mourad, K.E. Nielsen, M. Petrilak
1967Mo22	NUPAB	104,	327	W.H. Moore, G.K. Schlegel, S.O. Dell, A. Graue, J.R. Lien
1967Mu16	PHRVA	159,	1039	G. Muehllehner, A.S. Poltorak, W.C. Parkinson, R.H. Bassel
1967Na08	PHRVA	160,	1035	R.A. Naumann, P.K. Hopke
1967Ne04	PHRVA	155,	1314	C.L. Nealy, R.K. Sheline
1967Ne08	PHRVA	164,	1503	C.L. Nealy, R.K. Sheline
1967Ni02	NUPAB	93,	385	H.L. Nielsen, K. Wilsky, J. Żylicz, G. Sorensen
1967Nu01	PYLBB	26,	78	M. Nurmia, T. Sikkeland, R. Silva, A. Ghiorso

1967Oa01	PYLBB	24,	142	N.S. Oakey, R.D. McFarlane
1967Ob04	NUPAB	104,	609	B.J. O'Brien, W.E. Dorenbusch, T.A. Belote, J. Rapaport
1967Od01	PHRVA	158,	957	F.H. O'Donnell, C.P. Browne
1967Pa04	JOPQA	28,	388	P. Paris
1967Pa08	CJPHA	45,	2621	J.J.H. Park, P. Christmas
1967Pi03	PHRVA	159,	939	W.R. Pierson, K. Rengan
1967Pr04	PHRVA	157,	779	F.W. Prosser, Jr., G.U. Din, D.D. Tolbert
1967Pr10	PHRVA	161,	1080	W.V. Prestwich, R.E. Cote, G.E. Thomas
1967Ra13	NUPAB	99,	547	R.C. Ragaini, G.E. Gordon, W.B. Walters
1967Ra14	NUPAB	100,	280	J. Rapaport, T.A. Belote, W.E. Dorenbusch
1967Ri.A	BAPSA	12,	522	F.A. Rickey, Jr., H.C. Britt, and PrvCom AHW
1967Ro17	JOPQA	28,	637	G. Rotbart, J. Kalifa, G. Ronsin, M. Vergnes
1967Sc01	NUPAB	96,	337	S.O. Schriber, M.W. Johns
1967Sc05	PHRVA	154,	1146	O.W.B. Schult, M.E. Bunker, D.W. Hafemeister, E.B. Shera, E.T. Journey, J.W. Starnier, A. Backlin, B. Fogelberg, U. Gruber, B.P.K. Maier, H.R. Koch, W.N. Shelton, M. Minor, R.K. Sheline
1967Sc10	ZEPYA	203,	289	G. Schulz
1967Sc15	NUPAB	101,	177	G. Schulte
1967Sc26	NUPAB	104,	692	G. Schulz, K. Ziegler
1967Sc30	PHRVA	164,	1548	O.W.B. Schult, W.R. Kane, M.A.J. Mariscotti, J.M. Simic
1967Se10	PHRVA	164,	1450	K.K. Seth, J.A. Biggerstaff, P.D. Miller, G.R. Satchler
1967Si02	NUPAB	92,	475	A. Siivola
1967Si07	PYLBB	24,	331	T. Sikkeland, A. Ghiorso
1967Si08	PYLBB	24,	333	T. Sikkeland, A. Ghiorso, J. Maly, M.J. Nurmia
1967Si09	NUPAB	101,	129	A. Siivola
1967Sp03	PHRVA	155,	1368	R.R. Spencer, K.T. Faler
1967Sp06	NUPAB	99,	625	E.H. Spejewski, J.B. Willett
1967Sp08	ZEPYA	204,	129	A. Spalek, I. Rezanka, J. Frana, A. Mastalka
1967Sp09	P-Winnipeg		657	A. Sperduto
1967St14	YAFIA	5,	1205	G.L. Struble, R.K. Sheline
1967St24	NUPAB	104,	67	M.M. Stautberg, R.R. Johnson, J.J. Kraushaar, B.W. Ridley
1967St30	P-Winnipeg		495	H.H. Staub
1967Su05	PHRVA	163,	1091	J.W. Sunier, A.J. Armini, R.M. Polichar, J.R. Richardson
1967Te02	NUPAB	98,	417	R.G. Tee, A. Aspinall
1967Th05	NUIMA	56,	325	G.F. Thomas, D.E. Blatchley, L.M. Bollinger
1967Ti04	NUPAB	100,	425	E. Tielsch-Cassel
1967Tj01	KDVSA	36,	#8	P.O. Tjom, B. Elbek
1967Tr06	NUPAB	97,	405	W. Treytl, K. Valli
1967Va01	NUPAB	91,	157	D. Varga, D. Berenyi, C. Ujhelyi, F. Molnar
1967Va14	NUPAB	99,	473	J. Van Klinken, L.M. Taff
1967Va17	PHRVA	159,	1013	K. Valli, M.J. Nurmia, E.K. Hyde
1967Va20	JINCA	29,	2503	K. Valli, E.K. Hyde, W. Treytl
1967Va22	PHRVA	161,	1284	K. Valli, W. Treytl, E.K. Hyde
1967Va23	NUPAB	102,	369	L. Van Neste, R. Coussement, J.P. Deutsch
1967Va27	IANFA	31,	284	S.S. Vasilev, E.T. George, L.Y. Shavtalo
1967Va.A	P-Winnipeg		296	K. Valli
1967Ve04	NUPAB	103,	188	E. Veje
1967Vo05	PHRVA	164,	1374	D. Von Ehrenstein, J.P. Schiffer
1967Vr04	IANFA	31,	604	J. Vrzal, K.Y. Gromov, J. Liptak, F. Molnar, V.A. Morozov, J. Urbanets, V.G. Chumin
1967Wa09	NUPAB	97,	641	A.H. Wapstra
1967Wa23	PHRVA	164,	1545	T.E. Ward, H. Ihochi, M. Karras, J.L. Meason
1967Wh03	PHRVA	160,	997	C.A. Whitten, Jr., L.C. McIntyre
1967Wi08	NUPAB	103,	433	C.A. Wiedner, A. Heusler, J. Solf, J.P. Wurm
1967Wi14	PHRVA	163,	1094	S. Wirjoamidjojo, B.D. Kern
1967Wi19	NUIMA	52,	77	J.B. Willet, E.H. Spejewski
1967Yt03	PHYSA	34,	559	C. Ythier, J.C. Meyer, J. Konijn, R. van Lieshout

1968Ab14	IANFA	32,	749	A.A. Abdurazakov, J. Vrzal, K. Ya. Gromov, Zh. T. Zhelev, V.G. Kalinnikov, J. Liptak, S.K. Li, F.N. Mukhtasimov, U.K. Nazarov, J. Urbanets
1968Ab17	IANFA	32,	793	L.N. Abesalashvili, K.Y. Gromov, Z.T. Zhelev, V.G. Kalinnikov, J. Liptak, U.K. Nazarov, J. Urbanets
1968Ad03	JPAGB	1,	549	J.M. Adams, A. Adams, J.M. Calvert
1968Ad04	NUPAB	121,	289	I. Adam, K.S. Toth, M.F. Roche
1968Ad08	APPOA	34,	529	B. Adamowicz, Z. Moroz, Z. Preibisz, A. Zglinski
1968Ah01	NUPAB	119,	27	I. Ahmad, A.M. Friedman, J.P. Unik
1968An03	NUPAB	110,	289	S. Antman, H. Petterson, Y. Grunditz
1968An11	NUPAB	121,	337	S. Andre, P. Liaud
1968Ar03	PHRVA	165,	1194	A.J. Armini, J.W. Sunier, J.R. Richardson
1968Au04	NUPAB	116,	14	R.L. Auble, J.B. Ball, C.B. Fulmer
1968Az01	ZEPYA	208,	234	A. Azman, A. Mojlk, J. Pahor
1968Ba25	YAFIA	7,	727	S.A. Baranov, V.M. Kulakov, V.M. Shatinskii
1968Ba53	YAFIA	7,	1153	I. Bacso, D.D. Bogdanov, S. Darocsy, V.A. Karnaukhov, L.A. Petrov
1968Ba73	JO PQS	1,C1	181	G. Bastin, C.F. Leang, R.J. Walen
1968Be02	NUPAB	106,	296	J.E. Benn, E.B. Dally, H.H. Muller, R.E. Pixley, H.H. Staub, H. Winkler
1968Be06	NUPAB	108,	382	H. Beekhuis, R.J. Van Duinen
1968Be10	NUPAB	109,	666	T.A. Belote, W.E. Dorenbusch, J. Rapaport
1968Be13	PHRVA	167,	1043	R.C. Barse, D.H. Youngblood, J.L. Yntema
1968Be21	NUPAB	121,	433	C.E. Bemis, Jr., J. Halperin
1968Be35	ZEPYA	216,	229	E. Beck, H. Daniel
1968Be36	NUPAB	120,	401	T.A. Belote, W.E. Dorenbusch, J. Rapaport
1968Be.A	BAPSA	13,	1430	M.J. Bennet, R.K. Sheline
1968Bj01	NUPAB	107,	241	J.H. Bjerregaard, O. Hanson, O. Nathan, R. Chapman, S. Hinds
1968Bj02	NUPAB	110,	1	J.H. Bjerregaard, O. Hansen, O. Nathan, L. Vistisen, R. Chapman, S. Hinds
1968Bj03	NUPAB	113,	484	J.H. Bjerregaard, O. Hansen, O. Nathan, L. Vistisen, R. Chapman
1968Bj05	NUPAB	118,	241	S. Bjornholm, J. Dubois, B. Elbek
1968Br23	PHRVA	174,	1247	H. Brunnader, J.C. Hardy, J. Cerny
1968Bu02	PHRVA	166,	1096	G.W. Butler, J. Cerny, S.W. Cospser, R.L. McGrath
1968Ch20	NUPAB	119,	305	R. Chapman, S. Hinds, A.E. Macgregor
1968Ch.A	PrvCom	AHW	May	R.E. Chrien
1968Co20	PHRVA	172,	1126	E.R. Cosman, D.C. Slater
1968Co22	NUPAB	117,	449	M. Conjeaud, S. Harar, Y. Cassagnou
1968Da02	NUPAB	107,	569	W.R. Daniels, D.C. Hoffman, F.O. Lawrence, C.J. Orth
1968Da09	PHRVA	172,	1176	J.M. D'Auria, H. Bakhru, J.C. Preiss
1968Da13	NUPAB	112,	241	W.R. Daniels, F.O. Lawrence, D.C. Hoffman
1968De17	YAFIA	8,	255	R.A. Demirkhanov, V.V. Dorokhov, M.I. Dzkuya
1968Do02	PYLBB	26,	148	W.E. Dorenbusch, F.T. Dao, J. Rapaport, T.A. Belote
1968Do03	NUPAB	109,	649	W.E. Dorenbusch, T.A. Belote, J. Rapaport
1968Do06	NUPAB	112,	385	W.E. Dorenbusch
1968Do12	PHRVA	175,	1446	K.W. Dolan, D.K. Daniels
1968En01	NUPAB	107,	305	G.A.P. Engelbertink, H. Lindeman, M.J.N. Jacobs
1968Et01	PHRVA	168,	1249	R.C. Etherton, L.M. Beyer, W.H. Kelly, D.J. Horen
1968Fi01	NUPAB	111,	338	E. Fincke, U. Jahnke
1968Fi04	PHRVA	173,	1078	H.J. Fischbeck
1968Fu07	NUPAB	118,	97	L. Funcke, W. Andrejtscheff, H. Graber, U. Hagemann, K.-H. Kaun, P. Kemnitz, W. Meiling, H. Sodan, F. Stary, G. Winter
1968Fu11	JUPSA	25,	946	S. Fukumoto, T. Matsuo, H. Matsuda
1968Go34	APPOA	34,	511	M. Gonsior, G.I. Lizurei, G. Nevodnichanskii, A.V. Potempa
1968Go.A	BAPSA	13,	1452	K.P. Gopinathan, W. Rubinson
1968Go.B	P-Dubna		54	N.A. Golovkov, R.B. Ivanov, Y.V. Norseev, So Ki Kvan, V.A. Khalkin, V.G. Shumin
1968Go.C	P-Dubna		27	N.A. Golovkov, S.V. Khvan, V.G. Chumin
1968Gr09	NUPAB	113,	353	T.B. Grandy, W.J. McDonald, W.K. Dawson, G.C. Neilson
1968Gr14	PYLBB	27,	274	R.C. Greenwood
1968Gr16	NUPAB	120,	493	A. Graue, E. Hvidsen, J.R. Lien, G. Sandvik, W.H. Moore
1968Gr17	NUPAB	120,	513	A. Graue, L. Herland, J.R. Lien, E.R. Cosman

1968Ha09	PYLBB	26,	432	M. Hagen, K.H. Maier, R. Michaelsen
1968Ha10	PHRVA	168,	1373	R.A. Harlan, R.R. Sheline
1968Ha13	NUPAB	113,	75	O. Hansen, O. Nathan, L. Vistisen, R. Chapman
1968Ha14	NUPAB	113,	206	R.L. Hahn, M.F. Roche, K.S. Toth
1968He03	PYLBB	26,	435	D.C. Hensley, P.H. Nettles, C.A. Barnes
1968Ho10	JOPQA	29,	138	J.C. Hocquenghem, S. Andre, P. Liaud
1968Ho13	NUPAB	115,	225	R.W. Hoff, J.E. Evans, E.K. Hulet, R.J. Dupzyk, B.J. Qualheim
1968Ho22	AFYSA	37,	1	G. Holm
1968Hs01	NUPAB	109,	423	S.T. Hsue, M.U. Kim, L.M. Langer, E.H. Spejewski
1968Hs02	NUPAB	117,	686	S.T. Hsue, M.U. Kim, L.M. Langer, W.F. Piel, E.H. Spejewski
1968Hu05	PHRVA	167,	1064	H.C. Hudson, W.H. Johnson, Jr.
1968Ja06	NUPAB	115,	321	J.F.W. Jansen, W. Pauw, C.J. Touse
1968Ja11	AFYSA	37,	585	A. Jasinski, C.J. Herrlander
1968Jo11	NUPAB	113,	104	L.V. Johnson, T.J. Kennett
1968Ki07	YAFIA	8,	1057	B.G. Kiselev, V.R. Burmistrov
1968Ki08	IANFA	32,	1640	A.A. Klyushnikov, N.F. Mitrokhovich, A.I. Feoktistov
1968La18	PHRVA	175,	1507	I.M. Ladenbauer-Bellis, H. Bakhru
1968Le07	CHDBA	266,	629	C.F. Leang, G. Bastin-Scoffier
1968Li01	ZEPYA	208,	208	E. Liukhonen, J. Kantele
1968Li12	NUPAB	122,	373	H. Lindeman, G.A.P. Engelbertink, M.W. Ockeloen, H.S. Pruyss
1968Lo15	YAFIA	8,	849	Y.V. Lobanov, V.A. Durin
1968Ma35	PHRVA	174,	1485	M.A.J. Mariscotti, W. Gelletly, J.A. Moragues, W.R. Kane
1968Ma45	JUPSA	25,	950	H. Matsuda, T. Matsuo
1968Mc06	PHRVA	168,	1393	M. McDonnell, M.K. Ramaswami
1968Mc09	PHRVA	172,	1253	L.D. McIsaac
1968Mc10	PHRVA	171,	1254	W.J. McDonald, J.T. Sample, D.M. Sheppard, G.M. Stinson, K.W. Jon
1968Mc12	PYLBB	27,	443	R.L. McGrath, J.C. Hardy, J. Cerny
1968Mi08	NUPAB	119,	609	W. Michaelis, F. Weller, H. Schmidt, G. Markus, U. Fanger
1968Mo21	PHRVA	175,	1516	P.A. Moore, P.J. Riley, C.M. Jones, M.D. Mancusi, J.L. Foster, Jr.
1968My.A	P-Debreccen		102	B. Mysek, Z. Sujkowski, B. Kotlinska
1968Pa03	NUPAB	110,	674	B. Parsa, G.E. Gordon, W.B. Walters
1968Pe01	NUPAB	108,	124	H. Petterson, S. Antman, Y. Grunditz
1968Pi03	JOPQA	29,	257	R.A. Pinston, E. Monnard, A. Moussa
1968Re12	JINCA	30,	2887	K. Rengan, H.C. Griffin
1968Ri07	PHRVA	170,	1157	F.A. Rickey, R.K. Sheline
1968Ro09	PHRVA	170,	1013	J.E. Robertshaw, S. Mecca, A. Sperduto, W.W. Buechner
1968Sa09	NUPAB	118,	409	R. Santo, R. Stock, J.H. Bjerregaard, O. Hansen, O. Nathan, R. Chapman, S. Hinds
1968Sa13	NUPAB	121,	65	C. Samour, H.E. Jackson, J. Julien, A. Bloch, C. Lopata, J. Morgenstern
1968Sc01	PHRVA	165,	1184	I.G. Schröder, M. McKeown, G. Scharff-Goldhaber
1968Sc04	PHRVA	166,	1212	D. Schroeer, P.S. Jastram
1968Sc10	JOPQA	29,	385	F. Schussler
1968Sc14	ZEPYA	217,	282	W.D. Schmidt-Ott, W. Weirauch, F. Smend, H. Langhoff, D.G. Foller
1968Sc15	PHRVA	175,	1453	J.J. Schwartz
1968Sh12	PHRVA	170,	1108	E.B. Shera, M.E. Bunker, R.K. Sheline, S.H. Vegors
1968Si01	NUPAB	109,	231	A. Siivola
1968Sn01	NUPAB	113,	581	R.E. Snyder, G.B. Beard
1968Sp01	NUPAB	113,	395	R. Spilling, H. Gruppelaar, H.F. de Vries, A.M.J. Spits
1968Su02	PRLTA	21,	237	A.W. Sunyar, G. Scharff-Goldhaber, M. McKeown
1968Te01	PYLBB	26,	371	B. Teitelman, G.M. Temmer
1968To10	PHRVA	174,	1494	D.F. Torgerson, R.A. Gough, R.D. Macfarlane
1968Tr01	NUPAB	111,	241	A. Trier, L. Gonzáles, J. Rapaport, T.A. Belote, W.E. Dorenbusch
1968Tr07	ZENAA	23,	2127	N. Trautmann, R. Denig, N. Karfeel, G. Herrmann
1968Va04	PHRVA	167,	1094	K. Valli, W.J. Treytl, E.K. Hyde
1968Va06	NUPAB	112,	372	J. Van Klinken, F. Pleiter, H.T. Dijkstra
1968Va08	ATKOA	10,	27	E. Vatai, K. Hohmuth
1968Va17	PHYSA	40,	253	H. Van Krugten, E.W. Koopmans
1968Va18	PHRVA	176,	1377	K. Valli, E.K. Hyde
1968Vi01	PYLBB	26,	285	G.B. Vingiani, G. Chilosi, W. Bruynesteyn

1968Vi05	IANFA	32,	1625	V.D. Vitman, B.S. Dzelepov, A.I. Medvedev
1968We02	NUPAB	109,	561	H. Wenniger, J. Stiewe, H. Leutz
1968Wh03	NUIMA	66,	70	D.H. White, D.J. Groves, R.E. Birket
1968Wi21	IANFA	32,	187	K. Wilsky, K.Y. Gromov, Z.T. Zhelev, V.V. Kuznetsov, G. Muziol, O.B. Nielsen, O. Skillbreit
1968Wi25	ATKEA	13,	383	P. Wille
1968Wo01	NUPAB	107,	332	A.C. Wolff, M.A. Meyer, P.M. Endt
1968Wo02	NUPAB	112,	156	J.L. Wolfson, A.J. Collier
1968Wo09	PYLBB	28,	77	S.S.M. Wong, W.G. Davies
1968Yo01	PYLBB	26,	143	H.J. Young, J. Rapaport, and PrvCom AHW
1968Yo06	PHRVA	173,	949	P.G. Young, R.H. Stoker, G.G. Olsen
1968Ze04	APASA	27,	31	H. Zemann, D. Zemrad
1968Zh04	IANFA	32,	1610	Zh. Zhelev, V.G. Kalinnikov, J. Liptak, L.K. Peker
1969				
1969Aj03	PHRVA	188,	1813	F. Ajzenberg-Selove
1969Ak01	IANFA	33,	104	M.R. Akhmed, K.A. Baskova, S.S. Vasilev, L.Y. Shaftalov
1969An18	PYLBB	30,	160	S. Andre, P. Liaud, F. Perales, S.Y. van der Werf
1969Ar23	IANFA	33,	1218	R. Arlt, Z. Malek, G. Musiol, G. Pfrepper, H. Strusny
1969Ar.A	P-Studsvik			S.E. Arnell, R. Hardell, O. Skeppstedt, E. Wallander
1969Ba02	CJPHA	47,	419	H. Bakhru, R.I. Morse, I.L. Preiss
1969Ba07	PHRVA	177,	1686	H. Bakhru, I.M. Ladenbauer-Bellis
1969Ba31	PHRVA	184,	1142	H. Bakhru, I.M. Ladenbauer-Bellis
1969Ba57	YAFIA	10,	1110	S.A. Baranov, V.M. Shatinskii, V.M. Kulakov
1969Be06	JINCA	31,	599	C.E. Bemis, Jr., J. Halperin, R. Eby
1969Be17	NUPAB	129,	571	K. Beg, R.D. Macfarlane
1969Be74	NUIMA	76,	77	E. Beck
1969Bj01	NUPAB	131,	481	J.H. Bjerregaard, O. Hansen, O. Nathan, R. Chapman, S. Hinds
1969Bl01	PRLTA	22,	470	A.G. Blair, J.G. Beery, E.R. Flynn
1969Bl03	NUPAB	123,	129	R. Bloch, T. Knellwolf, R.E. Pixley
1969Bl16	NUPAB	139,	434	J. Blachot, J.A. Pinston, F. Schussler
1969Bo48	NUIMA	72,	40	H.M.W. Booij, E.A. Van Hoek, J. Blok
1969Bo49	NUIMA	73,	323	H.E. Bosch, M.A. Fariolli, N. Martin, M.C. Simon
1969Br11	PHRVA	185,	1553	H.C. Britt, J.D. Cramer
1969Br21	NUPAB	137,	487	H. Brunnader, J.C. Hardy, J. Cerny
1969Bu01	NUPAB	124,	683	D.G. Burke, D.E. Nelson, C.W. Reich
1969Bu05	PHRVA	179,	1113	D.L. Bushnell, R.P. Chaturvedi, R.K. Smither
1969Bu.A	P-Yerevan		71	V.R. Burmistrov, B.G. Kiselev
1969Ca03	NUPAB	125,	267	G.C. Carlson, W.C. Schick, Jr., W.L. Talbert, Jr., F.K. Wahn
1969Ce01	PRLTA	22,	612	J. Cerny, E.A. Mendelson, Jr., G.J. Wozniak, J.E. Esterl, J.S. Har
1969Ch18	PYLBB	29,	652	J. Chaumont, E. Roeckl, Y. Nir-El, C. Thibault-Philippe, R. Klapisch, R. Bernas
1969Co03	NUPAB	129,	10	M. Conjeaud, S. Harar, E. Thuriere
1969Da15	PHRVA	181,	1618	J.W. Dawson, R.K. Sheline, E.T. Journey
1969De19	YAFIA	10,	433	R.A. Demirkhanov, V.V. Dorokhov
1969De27	PYLBB	30,	639	P. De Wit, C. Van der Leun
1969Do01	NUPAB	133,	146	W.E. Dorenbusch, T.A. Belote, J. Rapaport
1969Fa01	NUPAB	123,	616	K.T. Faler, R.R. Spencer, R.A. Harlan
1969Fi02	ZEPYA	225,	164	D. Flothman, W. Wiesner, R. Lohken, H. Rebel
1969Fr01	NUPAB	127,	33	A.M. Friedman, I. Ahmad, J. Milsted, D.W. Engelkemeir
1969Fr08	NUPAB	132,	593	J.M. Freeman, J.G. Jenkin, G. Murray, D.C. Robinson, W.E. Burcham
1969Fr22	ANPYA	23,	168	V.R. Friedrich, M. Kiesling, G. Otto
1969Ge07	PHRVA	181,	1682	W. Gelletly, J.A. Moragues, M.A.J. Mariscotti, W.R. Kane
1969Gh01	PRLTA	22,	1317	A. Ghiorso, M. Nurmia, J. Harris, K. Eskola, P. Eskola
1969Go23	IANFA	33,	1622	N.A. Golovkov, S. Guetch, B.S. Dzelepov, Yu. V. Norseev, V.A. Chalkin, V.G. Shumin
1969Gr08	NUPAB	131,	180	H. Gruppelaar, A.M.F. Op den Kamp, A.M.J. Spits
1969Gr24	NUPAB	136,	513	A. Graue, J.R. Lien, S. Royrvik, O.J. Aaroy, W.H. Moore
1969Gr28	CHDBA	269,	652	B. Grennberg, A. Rytz

1969Gr31	YAFIA	10,	681	L.V. Groshev, V.N. Dvoretiskii, A.M. Demidov, M.S. Alvash
1969Ha11	NUPAB	127,	71	O. Hansen, O. Nathan, R. Chapman, S. Hinds
1969Ha32	PHRVA	182,	1329	R.L. Hahn, M.F. Roche, K.S. Toth
1969Ha44	NUPAB	136,	414	P.E. Haustein, A.F. Voigt
1969Ha.A	P-Studsvik		209	R. Hardell
1969He05	ZEPYA	218,	137	G. Heymann, P. van der Merwe, I.J. van Heerden, I.C. Dormehl
1969Ho10	NUPAB	131,	551	D.C. Hoffman, F.O. Lawrence, W.R. Daniels
1969Ho37	PHRVA	187,	1709	P.K. Hopke, R.A. Naumann, E.H. Spejewski
1969Jo16	NUPAB	133,	213	K.H. Johansen, B. Bengtson, P.G. Hansen, P. Hornshøj
1969Ka06	JUPSA	26,	1071	T. Katoh, T. Morii, H. Inoue, Y. Yoshizawa, H. Gotoh, E. Sakai
1969Ka13	NUCIA	61,	220	Y. Kabasakal, M.K. Ramaswamy
1969Ki15	IANFA	33,	1340	B.G. Kiselev, V.R. Burmistrov
1969Ki16	YAFIA	10,	1105	B.G. Kiselev, V.R. Burmistrov
1969Ki.A	P-Yerevan		42	B.G. Kiselev, V.N. Lebkovskii
1969Ku03	ZEPYA	222,	144	E. Kuhlmann, K.E.G. Lobner
1969Ku07	NUPAB	133,	554	T. Kuroyanagi, T. Tamura
1969La11	PHRVA	178,	1919	R.G. Lanier, R.K. Sheline, H.F. Mahlein, T. von Egidy, W. Kaiser, H.R. Koch, U. Gruber, B.P.K. Maier, O.W.B. Schult, D.W. Hafemeister, E.B. Shera
1969La15	PHRVA	180,	1015	I.M. Ladenbauer-Bellis, H. Bakhru
1969La33	PHRVA	187,	1739	I.M. Ladenbauer-Bellis, H. Bakhru, A. Luzzati
1969Le05	NUPAB	135,	36	C.M. Lederer, J.M. Jaklevic, S.G. Prussin
1969Le.A	Th.-Paris			C.F. Leang
1969Lu09	APPOA	36,	939	J. Ludziejewski, J. Kownacki, W. Klamra, J. Chaszczewska, W. Przyborski
1969Ly06	NUPAB	135,	97	L.L. Lynn, W.E. Dorenbusch, T.A. Belote, J. Rapaport
1969Mc05	NUPAB	127,	531	M. McDonnel, M.K. Ramaswami
1969Mi10	PHRVA	177,	1455	R.C. Minehart, L. Coulson, W.F. Grubb, III, K. Ziock
1969Mo13	PHRVA	180,	1105	J.A. Moragues, M.A.J. Mariscotti, W. Gelletly, W.R. Kane
1969Mo16	NUPAB	134,	321	E. Monnard, J. Blachot, A. Moussa
1969Na03	PHRVA	178,	1968	T. Nagarajan, M. Ravindranath, K.V. Reddy, S. Janananda
1969Na05	NUPAB	134,	433	T. Nagarajan, M. Ravindranath, K.V. Reddy
1969Na11	NUPAB	137,	467	T. Nagarajan, M. Ravindranath, K.V. Reddy
1969Na21	SHIBA	17,	705	H. Nakabushi, I. Katakuse, K. Ogata
1969Oh01	PHRVA	177,	1695	H. Ohnuma, J.R. Erskine, J.A. Nolen, Jr., J.P. Schiffer, P.G. Roos
1969Ov01	NUIMA	68,	61	J.C. Overley, P.D. Parker, D.A. Bromley
1969Ph01	NUPAB	135,	116	M.E. Phelps, D.G. Sarantes
1969Ph03	RRALA	1,	351	A. Phillippe, C. Ballaux, R. Dams, F. Adams
1969Pi08	NUPAB	133,	124	J.A. Pinston, F. Schussler, A. Moussa
1969Pr04	NUPAB	131,	679	G. Presser, R. Bass, K. Kruger
1969Pr06	PHRVA	180,	945	W.V. Prestwich, G.E. Thomas
1969Pr11	PHRVA	188,	1930	V. Prodi, K.F. Flynn, L.E. Glendenin
1969Ra02	NUPAB	123,	627	J. Rapaport, T.A. Belote, W.E. Dorenbusch
1969Ra24	NUPAB	138,	49	S. Ray, J.N. Mo, S. Murzynski, S.K. Mark
1969Re04	PHYSA	40,	567	E.R. Reddingius, H. Postma
1969Sa08	NUPAB	130,	97	D.G. Sarantites, S. Gronemeyer
1969Sh04	NUPAB	128,	73	M.H. Shapiro, C. Moss, W.M. Denny
1969St02	PHRVA	178,	2024	R.H. Stokes, P.G. Young
1969St07	PHRVA	178,	1789	R.H. Stokes, P.G. Young
1969Te01	PHRVA	177,	1595	J. Tenenbaum, R. Moreh, Y. Wand, B. Arad, G. Ben-David
1969Tj01	KDVSA	37,	#7	P.O. Tjom, B. Elbek
1969To14	AFYSA	38,	261	S. Toernqvist, S. Stroem
1969Va06	NUPAB	130,	586	J.M. Vara, R. Gaeta
1969Va17	NUPAB	134,	215	S.Y. Van der Werf, H. De Waard, H. Beekhuis
1969Wa10	PHRVA	182,	1186	T.E. Ward, P.H. Riley, P.K. Kuroda
1969Wa15	JINCA	31,	2679	T.E. Ward, P.H. Pile, P.K. Kuroda
1969Wa19	PHRVA	185,	1439	J. Walinga, J.C. Manthuruthil, C.P. Poirier
1969Wa24	RAACA	12,	217	T.E. Ward, P.K. Kuroda
1969Wa.A	UCRL-18667		54	D. Ward, F.S. Stephens, R.M. Diamond
1969Wi.A	Th.-Berkeley			J.B. Wilhelmy UCRL-18978]
1969Ya02	NUPAB	130,	456	T. Yamazaki, J. Sato

1969Zo04	PHRVA	185,	1537	W.H. Zoller, W.B. Walters, C.D. Coryell
			1970	
1970Ab05	NUPAB	151,	187	C. Abulaffio, J. Felsteiner, R. Kalish, B. Rosner, G. Vourvopoulos
1970Ab15	NUCIA	70,	391	U. Abbondanno, R. Giacomich, L. Granata, M. Lagonegro, G. Poiani, P. Blasi, R.A. Ricci
1970Ad01	NUPAB	143,	97	E.G. Adelsberger, A.V. Nero, A.B. McDonald
1970Af.A	JINR-P6-4972			V.P. Afanasiev, M. Bocharova, N.A. Golovkov, I. Gromova, R.B. Ivanov, V.I. Kuzmin, Y.V. Narseev, V.G. Chumin
1970Ag01	IANFA	34,	397	V.A. Ageev, N.F. Mitrokhovich, A.I. Feoktistov
1970Ag02	IANFA	34,	435	V.A. Ageev, N.F. Mitrokhovich, A.I. Feoktistov
1970Ag03	IANFA	34,	201	V.A. Ageev, N.F. Mitrokhovich, A.I. Feoktistov
1970Ah01	NUPAB	140,	141	I. Ahmad, R.K. Sjoblom, R.F. Barnes, E.P. Horwitz, P.R. Fields
1970Aj01	NUPAB	142,	641	F. Ajzenberg-Selove, G. Igo
1970Ak02	IANFA	34,	777	A.I. Akhmadzhanov, R. Broda, V. Valyus, I. Zvolski, I. Molnar, Y. Stygen, V.I. Fominikh, A. Krynkevich, V.M. Tsupko-Sitnikov
1970An06	ZEPYA	234,	455	A. Antilla, M. Bister, E. Arminen
1970An14	NUPAB	153,	17	M.L. Andersen, S.A. Andersen, O. Nathan, K.M. Bisgard, K. Gregersen, O. Hansen, S. Hinds, R. Chapman
1970An25	NUPAB	157,	561	T.R. Anfinsen, K. Bjorndal, A. Graue, J.R. Lien, G.E. Sandvik, L.O. Tveita, K. Ytterstad, E.R. Cosman
1970Ar04	IANFA	34,	409	R. Arlt, G. Beyer, G. Musiol, L.K. Peker, G. Pfrepper, H. Strusny
1970As08	NUPAB	158,	146	J. Ashkenazi, E. Friedman, D. Nir, J. Zioni
1970Be24	PRVCA	2,	297	R.W. Bercaw, R.E. Warner
1970Be48	NUPAB	157,	520	G.B. Beard, G.E. Thomas
1970Be.A	P-Leysin		353	E. Beck, ISOLDE
1970Bo13	PRVCA	2,	1841	J. Borggreen, K. Valli, E.K. Hyde
1970Bo19	JINCA	32,	2805	G.G.J. Boswell, T. McGee
1970Bo29	PRVCA	2,	1951	L.M. Bollinger, G.E. Thomas
1970Br01	PRVCA	1,	275	T.H. Braid, R.R. Chasman, J.R. Erskine, A.M. Friedman
1970Br23	NUPAB	153,	289	C.P. Browne, G. Maille, R. Tarara J.R. Duray
1970Br.A	JINR-E6-5197			R. Broda, S. Chojnacki, C. Droste, T. Morek, W. Walus
1970Bu19	PRVCA	2,	1513	D.J. Buss, R.K. Smither
1970Ca01	NUPAB	141,	97	P.E. Cavanagh, C.F. Coleman, A.G. Hardacre, G.A. Gard, J.F. Turner
1970Ce02	PRLTA	24,	1128	J. Cerny, C.U. Cardinal, H.C. Evans, K.P. Jackson, N.A. Jelley
1970Ce04	PYLBB	33,	284	J. Cerny, J.E. Esterl, R.A. Gough, R.G. Sextro
1970Ch02	NUPAB	142,	634	J.C. Chang, G. Schupp, R.R. Hurst
1970Ch28	NUPAB	156,	276	A. Charvet, R. Duffait, A. Emsallem, R. Chéry
1970Ch29	JOQA	31,	737	A. Charvet, R. Duffait, A. Emsallem, R. Chéry
1970Ch.A	BAPSA	15,	87	R.E. Chrien, S. Bokharee, J.B. Garg
1970Cr04	NUPAB	153,	413	F.P. Cranston, R.E. Birkett, D.H. White, J.A. Hughes
1970De39	NUPAB	158,	166	F.W.N. De Boer, E.W.A. Lingeman, R. van Lieshout, R.A. Ricci
1970Do.A	COO-1779-49		47	R. Doebler (Also Thesis Michigan State University)
1970Dz04	PYLBB	33,	302	T.G. Dzubay, A.A. Jaffe, E.J. Ludwig, T.A. White, F. Everling, D.W. Miller, D.A. Outlaw
1970Ei02	NUPAB	141,	289	J. Eidens, E. Roeckl, P. Armbruster
1970El.A	BAPSA	15,	1670	J.L. Ellis, H.E. Hall, Jr.
1970Er03	NUPAB	146,	43	B. Erlandson, A. Marcinkowski
1970Es02	PRVCA	2,	1058	P. Eskola, K. Eskola, M. Nurmi, A. Ghiorso
1970Es03	PYLBB	33,	287	J.E. Esterl, J.C. Hardy, R.G. Sextro, J. Cerny
1970Fa06	NUPAB	146,	549	U. Fanger, D. Heck, W. Michaelis, H. Ottmar, H. Schmidt, R. Gaeta
1970Fi03	NUPAB	144,	67	E. Fincke, U. Jahnke, B. Schreiber, A. Weidinger
1970Fi12	NUPAB	154,	407	P.R. Fields, I. Ahmad, R.F. Barnes, R.K. Sjoblom, E.P. Horwitz
1970Fi.A	CERN-70-29			M. Finger, R. Foucher, J.P. Husson, J. Jastrzebski, A. Johnson, C. Seville, R. Henck, J.M. Kuchly, R. Regal, P. Siffert, G. Astner, B.R. Erdal, E. Hagebo, A. Kjølberg, F. Munnich, P. Patzelt, E. Beck, H. Kugler
1970FI05	NUPAB	154,	225	E.R. Flynn, J.G. Beery, A.G. Blair
1970FI08	NUPAB	157,	1	D.G. Fleming, M. Blann, H.W. Fulbright, J.A. Robbins

1970Fo09	PYLBB	32,	689	I. Fodor, I. Szentpetery, J. Szucz
1970Ga32	IANFA	34,	2048	S. Gabrakov, Z. Zhelev, N.G. Zaitseva, I. Penev, S.S. Sabirov
1970Ge03	PRVCA	1,	1052	W. Gelletly, J.A. Moragues, M.A. Mariscotti, W.R. Kane
1970Gh01	PYLBB	32,	95	A. Ghiorso, M. Nurmia, K. Eskola, P. Eskola
1970Gh02	PRLTA	24,	1498	A. Ghiorso, M. Nurmia, K. Eskola, J. Harris, P. Eskola
1970Go04	PRVCA	1,	123	D.R. Goosman, E.G. Adelsberger, K.A. Snover
1970Go11	PRVCA	1,	1939	D.R. Goosman, R.W. Kavanagh
1970Go20	NUPAB	151,	513	P.F.A. Goudsmit, J. Konijn, F.W.N. De Boer
1970Go39	NUIMA	88,	197	W. Goedbloed, S.C. Goverse, C.P. Gerner, A. Brinkman, J. Blok
1970Go42	PRVCA	2,	2406	D.J. Gorman, F. Asaro
1970Go45	PRVCA	1,	1939	D.R. Goosman, R.W. Kavanagh
1970Gr38	PYLBB	33,	474	J.W. Gruter, K. Sistemich, P. Armbruster, J. Eidens, H. Lawin
1970Gr46	KDVSA	37,	#12	T. Grottdal, K. Nybø, B. Elbek
1970Gu14	JINCA	32,	3425	M.C. Gupta, R.D. MacFarlane
1970Ha10	PRVCA	1,	561	J.C. Hardy, H. Brunnader, J. Cerny
1970Ha18	NUPAB	148,	249	P.G. Hansen, H.L. Nielsen, K. Wilsky, M. Alpsten, M. Finger, A. Lindahl, R.A. Naumann, O.B. Nielsen
1970Ha21	NUPAB	158,	625	T. Hattula, S. Andre, F. Schussler, A. Moussa
1970Ha56	PHSTB	1,	85	R. Hardell, C. Boer
1970Ha60	PHSTB	2,	23	A. Hasselgren
1970He14	CJPHA	48,	1040	A.W. Herman, E.A. Heighway, J.D. McArthur
1970He27	NUPAB	159,	49	D. Heck, N.M. Ahmed, U. Fanger, W. Michaelis, H. Ottmar, H. Schmidt
1970Hi06	PRLTA	25,	829	R.A. Hinrichs, R. Sherr, G.M. Crawley, I. Proctor
1970Ho01	NUPAB	140,	658	K.J. Hofstetter, T.T. Sugihara
1970Ja22	PYLBB	33,	281	K.P. Jackson, C.U. Cardinal, H.C. Evans, N.A. Jelley, J. Cerny
1970Jo08	PRVCA	1,	2030	H.D. Jones, R.K. Sheline
1970Jo11	NUPAB	150,	497	H.D. Jones, R.K. Sheline
1970Jo22	PRVCA	2,	1747	H.D. Jones, R.K. Sheline
1970Ju04	PRVCA	2,	2323	E.T. Journey, R.K. Sheline, E.B. Shera, H.R. Koch, B.P.K. Maier, U. Gruber, H. Baader, D. Breitig, O.W.B. Schult
1970Ka04	NUPAB	147,	120	M. Karras, T.E. Ward, H. Schoche
1970Ka22	PRLTA	25,	953	W.R. Kane
1970Ke05	P-Kyoto			D.P. Kerr, K.T. Bainbridge
1970Ke08	PRVCA	2,	213	K.W. Kemper, C.M. McKenna, J.W. Nelson
1970Ki01	NUPAB	142,	35	H.J. Kim, R.L. Robinson, C.H. Jonnson, S. Raman
1970Ki05	ZEPYA	238,	11	H.V. Klapdor, K. Buchholz, F. Kaestner
1970Kn03	PRLTA	25,	1210	D.W. Kneff, H.W. Lefevre, G.U. Din
1970Kn05	NUPAB	159,	642	K.T. Knoepfle, M. Rogge, C. Mayer-Boricke, J. Pedersen, D. Burch
1970Le05	YAFIA	11,	483	V.N. Levkovskii, I.V. Kazachevskii
1970Li04	AFYSA	40,	197	H. Linusson, R. Hardell, S. Arnell
1970Lo02	NUPAB	152,	463	W. Lourens, B.O. Ten Brink, A.H. Wapstra
1970Ma05	NUPAB	145,	223	J.D. Macdougall, W. McLatchie, S. Whineray, H.E. Duckworth
1970Ma11	CJPHA	48,	2056	J.F. Mason, M.W. Johns
1970Ma19	NUPAB	147,	513	E.S. Macias, J.P. Op den Beeck, W.B. Walters
1970Ma25	NUPAB	149,	593	S. Maripuu
1970Ma31	NUPAB	151,	465	S. Maripuu
1970Ma36	NUPAB	153,	183	S. Maripuu
1970Ma47	JUPSA	29,	1116	Z.-IMatsumoto, T. Tamura
1970Ma.A	P-Leysin		321	M.I. Macias-Marques, R. Foucher, M. Caillau, J. Belhassen
1970Mc01	NUPAB	140,	529	D.K. McMillan, B.D. Pate
1970Mc03	NUPAB	145,	244	W. McLatchie, S. Whineray, J.D. Macdougall, H.E. Duckworth
1970Mc06	NUPAB	144,	593	A.B. McDonald, E.G. Adelsberger
1970Me11	PRLTA	25,	533	R. Mendelson, G.J. Wozniak, A.D. Bacher, J.M. Loiseaux, J. Cerny
1970Mi01	NUPAB	143,	225	W. Michaelis, F. Weller, U. Fanger, R. Gaeta, G. Markus, H. Ottmar, H. Schmidt
1970Mo08	NUPAB	145,	423	C.E. Moss
1970Mu02	NUPAB	142,	21	G. Murray, W.J.K. White, J.C. Wilmott, R.F. Entwistle
1970Mu15	PRVCA	2,	655	T.J. Mulligan, R.K. Sheline, M.E. Bunker, E.T. Journey
1970Mu17	NUPAB	158,	183	F. Münnich, A. Kjelberg, D.J. Hnatowich
1970Ob02	NUPAB	153,	593	B.J. O'Brien, G.E. Coote

1970Oh05	JUPSA	29,	1435	S. Ohya, T. Tamura, S. Kageyama
1970Or.A	DASA-2570			V.J. Orphan, N.C. Rasmussen, T.L. Harper
1970Pe04	ZEPYA	233,	260	H. Petterson, S. Antman, Y. Grunditz
1970Pi01	NUPAB	144,	42	J.A. Pinston, F. Schussler
1970Qa03	NUPAB	154,	145	S.M. Qaim
1970Ra14	APAHA	28,	263	K. Raichev, L. Tron
1970Re02	PRVCA	1,	721	P.L. Reeder
1970Re13	RAACA	14,	46	J.L. Repace
1970Re.A	PrvCom	NDG		A.C. Rester
1970Ro06	PRVCA	1,	1761	A.A. Rollefson, P.F. Jones, R.J. Shea
1970Ro07	NUPAB	147,	235	M.L. Roush, L.A. West, J.B. Marion
1970Ru.A	P-Leysin		341	G. Rudstam, E. Lund, L. Westgaard, B. Grapengieser, and PrvCom AHW
1970Sa19	NUPAB	157,	113	M. Sakai, R. Bertini, C. Gehringer
1970Sc06	ZEPYA	232,	398	W.D. Schmidt-Ott
1970Sc20	ZEPYA	236,	445	W.D. Schmidt-Ott
1970Sc22	NUPAB	153,	502	W. Schlegel, D. Schmitt, R. Santo, F. Puhlhofer
1970Se14	PHSTB	2,	169	E. Selin
1970Sh05	PRVCA	1,	1835	S. Shastri, H. Bakhru, I.M. Ladenbauer-Bellis
1970Si19	PRVCA	2,	1948	R.J. Silva
1970Sm.A	BAPSA	15,	549	R.K. Smither, D.J. Bush, D.L. Bushnell
1970Sp02	NUPAB	145,	449	A.M.J. Spits, A.M.F. Op den Kamp, H. Gruppelaar
1970St25	P-Kyoto		1296	C.M. Stevens, P.E. Moreland
1970Th.A	Th.-Paris			F. Thuriere
1970To07	NUPAB	149,	641	D.F. Torgerson, R.D. Macfarlane
1970To18	PRVCA	2,	2309	D.F. Torgerson, R.D. Macfarlane
1970Um01	PRVCA	2,	1378	C.J. Umbarger, K.W. Kemper, J.W. Nelson, H.S. Plendl
1970Va13	PRVCA	1,	2115	K. Valli, E.K. Hyde, J. Borggreen
1970Va31	NUPAB	157,	385	J. Van Klinken, L.M. Taff, H.T. Dijkstra, A.H. De Haan, H. Hanson, B.K.S. Koene, J.W. Maring, J.J. Schuurman, F.B. Yano
1970Va.A	PrvCom	AHW	Apr	B. Van Nooijen, N.R. Johnson
1970Vo04	PRVCA	1,	2066	D. Von Ehrenstein, G.C. Morrison, J.A. Nolen, Jr., N. Williams
1970Wa14	NUPAB	148,	225	T.E. Ward, P.H. Pile, P.K. Kuroda
1970Wa20	PRVCA	2,	675	O.A. Wasson, R.E. Chrien
1970Wa21	JINCA	32,	2483	T.E. Ward, D.L. Swindle, R.J. Wright, P.K. Kuroda
1970Wh01	NUPAB	151,	377	S. Whineray, J.D. Macdougall, W. McLatchie, H.E. Duckworth
1970Wh04	PRVCA	1,	1455	C.A. Whitten, Jr., M.C. Mermaz, D.A. Bromley
1970Wo05	NUPAB	146,	33	F.K. Wohn, W.L. Talbert
1970Wo08	NUPAB	152,	561	F.K. Wohn, W.L. Talbert, Jr., J.K. Halbig
1970Ya03	PRVCA	1,	290	T. Yamazaki
1970Ya05	NUPAB	149,	45	K. Yagi, Y. Aoki, K. Sato
1971				
1971Af05	IANFA	35,	1618	V.P. Afanasiev, V.S. Buttsev, I.I. Gromova, V.G. Kalinnikov, N.A. Tikhonov
1971Al01	NUPAB	161,	209	G. Alenius, S.E. Arnell, C. Schale, E. Wallander
1971Al14	PHSTB	3,	55	G. Alenius, S.E. Arnell, C. Schale, E. Wallander
1971Al19	NUPAB	174,	148	W.P. Alford, N. Schulz, J. Jamshidi
1971Al22	PHSTB	3,	105	G. Alenius, S.E. Arnell, C. Schale, E. Wallander
1971Ar12	NUPAB	166,	241	S.E. Arnell, H. Linusson, Z. Sawa
1971Ar23	NUPAB	169,	209	N.K. Aras, P. Fettweis, G. Chilosi, G.D. O'Kelley
1971Ar39	PHSTB	4,	89	S.E. Arnell, R. Hardell, A. Hasselgren, C.G. Mattson, O. Skeppstedt
1971Ba01	NUPAB	160,	225	J.B. Ball
1971Ba08	PRVCA	3,	937	H. Bakhru, I.M. Ladenbauer-Bellis, I. Rezanka
1971Ba18	NUPAB	164,	552	F. Bazan, R.A. Meyer
1971Ba43	PRVCA	4,	196	J.B. Ball, R.L. Auble, P.G. Roos
1971Bb10	YAFIA	14,	1101	S.A. Baranov, V.M. Shatinskii, V.M. Kulakov
1971Be10	PRVCA	3,	1294	F.M. Bernthal, J.O. Rasmussen, J.M. Hollander
1971Be29	NUPAB	168,	151	F.D. Becchetti, D. Dehnhard, T.G. Dzubay
1971Be41	NUPAB	171,	113	M.J. Bennet, R.K. Sheline, Y. Shida

1971Bi.A	UCRL-51060		R.E. Birkett
1971Bo01	NUPAB	160,	337 H.M.W. Booij, E.A. Van Hoek, H. Van der Molen, W.F. Slot, J. Blok
1971Bo06	NUPAB	162,	407 J. Borggreen, E.K. Hyde
1971Br13	JOPQA	32,	101 J.P. Briand, P. Chevallier, A. Touati
1971Ca19	PRVCA	4,	130 R.F. Casten, E.R. Flynn, O. Hansen, T.J. Mulligan
1971Ch26	JOPQA	32,	359 A. Charvet, D.H. Phuoc, R. Duffait, A. Emsallem, R. Chery
1971Da16	NUPAB	170,	253 W. Darcey, R. Chapman, S. Hinds
1971Da19	PRVCA	4,	919 W.R. Daniels, D.C. Hoffman
1971Da28	NUPAB	178,	172 J.M. D'Auria, D. Ostrom, S.C. Gujrathi
1971De52	RMXFA	20,	17 H. Del Castillo, R. Roos, A. Tejera, F. Alba
1971Di03	PRLTA	26,	1037 P.F. Dittner, C.E. Bemis, Jr., D.C. Henley, R.J. Silva, C.D. Goodman
1971Do18	PYLBB	37,	173 W.E. Dorenbusch, J.B. Ball, R.L. Auble, J. Rapaport, T.A. Belote
1971Du02	PRVCA	3,	1391 J.L. Dubbard, R.K. Sheline, J.B. Ball
1971Dy01	NUPAB	173,	393 N.C. Dyer, J.H. Hamilton
1971Dz08	IANFA	35,	2249 B.S. Dzelepov, A.G. Dmitriev, N.N. Zhukovskii
1971El05	NUPAB	170,	209 C. Ellegaard, P.D. Barnes, E.R. Flynn
1971En01	PRVCA	3,	180 G.A.P. Engelbertink, J.W. Olness
1971Es01	PRVCA	4,	632 K. Eskola, P. Eskola, M. Nurmi, A. Ghiorso
1971Ev01	CJPHA	49,	402 F. Everling, G.L. Morgan, D.W. Miller, L.W. Seagondollar, P.W. Tillman, Jr.
1971Fi01	NUPAB	160,	460 P.R. Fields, I. Ahmad, A.M. Friedman, J. Lerner, D.N. Metta
1971Fo01	PRVCA	3,	337 H.T. Fortune, G.C. Morrisson, J.A. Nolen, Jr., P. Kienle
1971Fo22	PYLBB	36,	334 B. Fogelberg, A. Backlin, T. Nagarajan
1971Fr03	NUPAB	165,	625 A. Frana, A. Spalek, M. Fiser, A. Kolec
1971Ge05	PRVCA	3,	1678 W. Gelletly, W.R. Kane, D.R. MacKenzie
1971Gh01	PRVCA	4,	1850 A. Ghiorso, M. Nurmi, K. Eskola, P. Eskola
1971Gh03	NATUA	229,	603 A. Ghiorso, M. Nurmi, J. Harris, K. Eskola, P. Eskola
1971Go01	PRVCA	3,	746 D.J. Gorman, F. Asaro
1971Go18	PRVCA	4,	1800 D.R. Goosman, K.W. Jones, E.K. Warburton, D.E. Alburger
1971Go21	YAFIA	14,	3 K.S. Goncharov, A.P. Klyucharev, S.A. Pismnitskii, Y.N. Rakivnenko, V.V. Remaev, I.A. Romani, E.A. Skakun
1971Go35	IANFA	35,	2272 N.A. Golovkov, R.B. Ivanov, A. Kolaczkowski, Y.V. Narseev, V.G. Chumin
1971Gr01	NUPAB	160,	497 A. Graue, J.R. Lien, H. Vinje, P.B. Vold, W.H. Moore
1971Gr04	NUPAB	162,	593 A. Graue, J.R. Lien, L. Rasmussen, G.E. Sandvik, E.R. Cosman
1971Gr17	MTRGA	7,	65 B. Grennberg, A. Rytz
1971Gr22	YAFIA	13,	681 L.V. Groshev, A.M. Demidov, V.F. Leonov, L.L. Sokolovskii
1971Gr28	YAFIA	13,	1129 L.V. Groshev, L.I. Govor, A.M. Demidov, A.S. Rachimov
1971Gr37	YAFIA	14,	473 L.V. Groshev, A.M. Demidov, V.F. Leonov, L.L. Sokolovskii
1971Gr42	IANFA	35,	1644 L.V. Groshev, A.M. Demidov, V.F. Leonov, L.L. Sokolovskii
1971Gr.A	P-Moscow		70 L.V. Groshev, V.N. Dvoret'skii, A.M. Demidov
1971Gu02	NUPAB	161,	410 S.C. Gujrathi, J.M. D'Auria
1971Gu18	NUPAB	172,	353 S.C. Gujrathi, J.M. D'Auria
1971Gu.A	Th.-Strasbourg		G. Guillaume
1971Ha01	NUPAB	175,	428 U. Hagemann, W. Neubert, W. Schulze
1971He10	NUPAB	165,	327 D. Heck, U. Fanger, W. Michaelis, H. Ottmar, J. Schmidt
1971He13	NUPAB	168,	449 R.G. Helmer, R.C. Greenwood, C.W. Reich
1971Ho01	NUPAB	163,	277 P. Hornshøj, K. Wilsky, P.G. Hansen, A. Lindahl, O.B. Nielsen
1971Ho07	PYLBB	34,	591 P. Hornshøj, K. Wilsky, P.G. Hansen, A. Lindahl, O.B. Nielsen
1971Ho16	NUPAB	169,	641 R.W. Hoff, E.K. Hulet, R.J. Dupzyk, R.W. Loughheed, J.E. Evans
1971Ho24	PRVCA	4,	1182 M. Honda, M. Imamura
1971Ho26	PRLTA	27,	1086 H.H. Howard, R.H. Stokes, B.H. Erkila
1971Hs03	NUPAB	174,	365 T.H. Hsu, J.L. Honsaker, W.J. McDonald, G.C. Nelson
1971Hu03	PRLTA	26,	523 E.K. Hulet, J.F. Wild, R.W. Loughheed, J.E. Evans, B.J. Qualheim, M. Nurmi, A. Ghiorso
1971Ib01	PHSTB	4,	161 N. Ibrahim, H. Pettersson
1971Ja09	PRVCA	3,	2489 A.A. Jaffe, G.A. Bissinger, S.M. Shafroth, T.A. White, T.G. Dzubay, F. Everling, D.W. Miller, D.A. Outlaw
1971Jo14	JINCA	33,	1215 K.C. Jordan, G.W. Otto, R.P. Ratay
1971Ka22	ZEPYA	245,	451 N. Kaffrell
1971Ka42	APOBB	2,	423 R. Kaczarowski, W. Kurcewicz, A. Płochocki, J. Żylicz

1971Ke01	CJPHA	49,	756	D.P. Kerr, K.T. Bainbridge
1971Ke02	CJPHA	49,	1950	D.P. Kerr, K.T. Bainbridge
1971Ke07	PRVCA	4,	1431	B.H. Ketelle, A.R. Brosi, J.R. van Hise
1971Ke21	NUPAB	176,	449	R.L. Kernell, H.J. Kim, R.L. Robinson, C.H. Johnson
1971Ki01	NUPAB	170,	187	C.H. King, P.R. Maurenzig, N. Stein, T.P. Cleary
1971Ki15	YAFIA	14,	249	B.G. Kiselev, V.N. Levkovskii, O.I. Artem'ev
1971La02	PRVCA	3,	188	H. Lancman, J.M. Lebowitz
1971Le21	NUPAB	170,	115	J.R. Leslie, W. McLatchie, C.F. Monahan, J.K. Thrasher
1971Li02	NUPAB	160,	630	E.W.A. Lingeman, F.W.N. De Boer, P. Koldewijn, P.R. Maurenzig
1971Lo15	NUPAB	171,	337	W. Lourens, B.O. Ten Brink, A.H. Wapstra
1971Lu01	PRVCA	3,	1243	M.T. Lu, W.P. Alford
1971Ma11	PRVCA	3,	1162	J.V. Maher, J.R. Comfort, G.C. Morrisson
1971Ma24	NUPAB	166,	573	S.G. Malmskog, V. Berg, B. Fogelberg, A. Backlin
1971Ma45	NUPAB	172,	298	P. Manfrass, H. Prade, M.R. Beitins, W.A. Bondarenko, N.D. Kramer, P.T. Prokofjew
1971Ma47	NUPAB	174,	343	S. Matsuki, Y. Yoshida, M. Hyakutake, M. Matoba, S. Nakamura
1971Mi01	PRVCA	3,	766	M.M. Minor, R.K. Sheline, E.T. Journey
1971Mo01	PRVCA	3,	438	J.M. Mosher, R.W. Kavanagh, T.H. Tombrello
1971Mo02	NUPAB	161,	228	J.M. Morton, W.G. Davies, W. McLatchie, W. Darcey, J.E. Kitching
1971Mo03	PRLTA	26,	854	H.T. Motz, E.T. Journey, E.B. Shera, R.K. Sheline
1971Mo20	NUPAB	168,	561	N.A. Morcos, T.E. Ward, P.K. Kuroda
1971My01	APOBB	2,	441	B. Myslek, B. Pietrzek, Z. Sujkowski, J. Szczepankowski
1971Na01	PRVCA	3,	247	T. Nagarajan, M. Ravindranath, K.V. Reddy
1971Na02	PRVCA	3,	254	T. Nagarajan, M. Ravindranath, K.V. Reddy
1971Ne.A	BAPSA	16,	489	P.H. Nettles, C.A. Barbes, D.C. Hensley, C.D. Goodman, and Nettles Thesis
1971Oh01	PRVCA	3,	158	H. Ohnuma, A.M. Sourkes
1971Or04	PRVCA	3,	2402	C.J. Orth, B.J. Dropesky, N.J. Freeman
1971Ot01	NUPAB	164,	69	H. Ottmar, N.M. Ahmed, U. Fanger, D. Heck, W. Michaelis, H. Schmidt
1971Pe23	NUPAB	167,	387	B.I. Person, J.L. Plessler, J.W. Sunier
1971Pi08	ZEPYA	247,	400	M. Piiparinen, A. Anttila, M. Viitasalo
1971PI08	IANFA	35,	1569	Z. Plajner, M. Vejs, I. Prochazka, A. Mashtalka, O. Voitishak, M. Gonusek, A. Kokesh
1971Po.A	P-Legnarò		375	C.P. Poirier, J.C. Manthuruthil
1971Pr03	NUPAB	167,	667	R. Prieels, J.P. Deutsch
1971Pr13	NUPAB	176,	338	R.H. Price, D.G. Burke, M.W. Johns
1971Ra08	ZEPYA	243,	105	F. Rauch
1971Ra09	NUPAB	168,	177	J. Rapaport, T.A. Belote, D.E. Bainum, W.E. Dorenbusch
1971Ra17	NUPAB	170,	199	J. Rapaport, T.A. Belote, D.E. Bainum
1971Ra35	NUPAB	177,	307	J. Rapaport, W.E. Dorenbusch, T.A. Belote
1971Ro19	JINCA	33,	2684	G. Rossner, G. Herrmann
1971Ru17	PYLAA	36,	321	S.L. Ruby, R.G. Clark, L.E. Glendenin
1971Sc07	NUPAB	165,	415	L.A. Schaller, J. Kern, B. Michaud
1971Sh04	ZEPYA	242,	368	W.N. Shelton, R.K. Sheline
1971Sm01	PRVCA	4,	22	L.G. Smith
1971Su14	YAFIA	14,	1297	G.Y. Sung-Ching-Yang, V.A. Druin, A.S. Trofimov
1971Sw01	PRVCA	3,	259	D.L. Swindle, T.E. Ward, P.K. Kuroda
1971Ta07	PRVCA	4,	517	K. Takehashi, D.L. Swindle, P.K. Kuroda
1971To01	PRVCA	3,	854	K.S. Toth, R.L. Hahn
1971To05	NUPAB	171,	305	R. Torti, R. Graetzer
1971To10	PRVCA	4,	2223	K.S. Toth, R.L. Hahn, M.A. Ijaz
1971Tr03	PRVCA	3,	2205	G.F. Trentelman, B.M. Freedom, E. Kashy
1971Um03	NUPAB	169,	109	C.J. Umbarger, J.A. Robinson, R.R. Reece, R.C. Bearce
1971Va18	NUPAB	170,	607	J.G. Vanderbaan, H.G. Leighton
1971Va21	NUPAB	173,	456	J.G. Vanderbaan, B.R. Sikura
1971Ve03	PRVCA	3,	1570	J. Vervier, H.H. Bolotin
1971Vi14	CPHMA	41,	319	M. Viitasalo
1971Wa21	NUPAB	173,	634	B.A. Watson, C.C. Chang, M. Hasinoff
1971We01	PRVCA	3,	1668	C.V. Weiffenbach, R. Tickle
1971Wi04	PRVCA	3,	1199	B.H. Wildenthal, E. Newman, R.L. Auble

1971Wi07	NUPAB	166,	661	D.H. Wilkinson, D.E. Alburger, D.R. Goosman, K.W. Jones, E.K. Warburton, G.T. Garvey, R.L. Williams
1971Ya10	PYLBB	37,	369	K. Yagi, K. Sato, Y. Aoki
1971Zi03	PRVCA	4,	1809	M.S. Zisman, B.G. Harvey
1972				
1972Ah04	NUPAB	186,	620	I. Ahmad, R.K. Sjoblom, R.F. Barnes, F. Wagner, Jr., P.R. Fields
1972Ah07	JINCA	34,	3335	I. Ahmad, R.F. Barnes, R.K. Sjoblom, P.R. Fields
1972A119	NUPAB	186,	209	G. Alenius, S.E. Arnell, C. Schale, E. Wallander
1972Ba08	CJPHA	50,	34	R.C. Barber, R.L. Bishop, J.O. Meredith, F.C.G. Southon, P. Williams, H.E. Duckworth, P. van Rookhuyzen
1972Ba26	PRVCA	5,	1351	T.T. Bardin, J.A. Becker, T.R. Fisher
1972Ba31	NUPAB	184,	609	D. Bachner, H. Kelleter, B. Schmidt, W. Seliger
1972Ba35	PRLTA	28,	1069	G.C. Ball, W.G. Davies, J.S. Forster, J.C. Hardy
1972Ba37	NUPAB	186,	321	H. Bakhru, I.M. Ladenbauer-Bellis, B. Jones
1972Ba91	IANFA	36,	782	G.Y. Baier, V.S. Buttsev, K.Y. Gromov, V.G. Kalinnikov, K.O. Mortensen, G.L. Nilsson, N.A. Tikhonov
1972Bb24	ZETFPA	63,	375	S.A. Baranov, V.M. Shatinskii, V.M. Kulakov, Y.F. Radionov
1972Be07	NUPAB	182,	69	R.R. Betts, O. Hansen, D.J. Pullen
1972Be11	NUPBB	39,	371	K.-E. Bergkvist
1972Be12	PRVCA	5,	1426	W. Benenson, J. Driesbach, I.D. Proctor, G.F. Trentelman, B.M. Freedom
1972Be44	ZEPYA	252,	349	H. Behrens, M. Kobelt, W.G. Thies, H. Appel
1972Be51	PRVCA	6,	957	R.R. Betts, H.T. Fortune, D.J. Pullen
1972B116	NUPAB	197,	620	J. Bleck, R. Butt, K.H. Lindenberger, W. Ribbe, W. Zeitz
1972Bo46	PRVCA	6,	1322	L.M. Bollinger, G.E. Thomas
1972Br13	NUPAB	185,	289	M. Brien, J.E. Kitching, J.K.P. Lee, P.F. Hinrichsen
1972Br31	APOBB	3,	263	R. Broda, M. Rybicka, J. Styczen, W. Walus, K. Krolas
1972Bu05	JINCA	34,	1087	F.T. Bunus
1972Ca01	KDVSA	38,	#13	R.F. Casten, P. Kleinheinz, P.J. Daly, B. Elbek
1972Ca07	NUIMA	98,	432	J.L. Campbell, L.A. McNellen
1972Ca10	NUPAB	184,	357	R.F. Casten, E.R. Flynn, O. Hansen, T.J. Mulligan
1972Ca33	NUPAB	198,	289	P.L. Carson, L.C. McIntyre
1972Ce01	NUPAB	188,	666	J. Cerny, R.A. Gough, R.G. Sextro, J.E. Esterl
1972Ch11	NUPAB	186,	603	R. Chapman, W. McLatchie, J.E. Kitching
1972Ch33	NUPAB	193,	225	H.C. Cheung, J.K.P. Lee, J.E. Kitching, S.K. Mark, Tseh Y. Li
1972Ch44	NUPAB	197,	490	A. Charvet, R. Chery, D.H. Phuoc, R. Duffait, A. Emsallem, G. Marguier
1972Co13	NUPAB	185,	644	W.F. Coetzee, M.A. Meyer, D. Reitmann
1972Cu07	NUPAB	196,	593	J.C. Cunnane, R. Hochel, C.W. Yates, P.J. Daly
1972Da.A	BAPSA	17,	71	C.N. Davids, D.L. Matthews, D. Whitmire
1972De11	P-Teddington		210	R.A. Demirkhanov, V.V. Dorokhov, M.I. Dzkuya see also 72De39
1972De47	NUPAB	195,	385	P. Debenham, N.H. Hintz
1972Dz13	YAFIA	15,	1093	J.D. Dzafar, A.A. Abdullah, N.H. Al Quaraishi, M.S. Alwash, M.A. Khalil, A.M. Demidov
1972EI03	CJPHA	50,	674	S.A. Elbakr, C. Glavina, W.K. Dawson, V.K. Gupta, W.J. McDonald, G.C. Nelson
1972Em01	NSENA	48,	319	J.F. Emery, S.A. Reynolds, E.I. Wyatt, G.I. Gleason
1972Er05	NUPAB	194,	449	B.R. Erdal, L. Westgaard, J. Żylicz, E. Roeckl, ISOLDE
1972Es03	PRVCA	5,	942	K. Eskola
1972Fa08	NUPAB	186,	545	L.C. Farwell, J.J. Kraushaar, H.W. Baer
1972Fe06	NUPAB	187,	123	J.A. Fenton, T.H. Kruse, N. Williams, M.E. Williams, R.N. Boyd, W. Savin
1972Fi.A	AnRpt MSUCL		28	R.B. Firestone, K. Kosanke, W.C. McHarris, W.H. Kelly
1972FI17	PYLBB	42,	49	E.R. Flynn, J.D. Garrett
1972Fo25	PHSTB	6,	309	I. Forsblom, T. Weckstrom, T. Sundius, G. Bergstrom, S. Forss, G. Wansen
1972Fu10	NCLTA	4,	430	A. Fubini
1972Ga27	PRLTA	29,	958	H. Gauvin, Y. Le Beyec, M. Lefort, N.T. Porile
1972Gi17	NUIMA	105,	179	H.J. Gils, R. Lohken, W. Wiesner
1972Go31	PRVCA	6,	820	D.R. Goosman, D.E. Alburger
1972Go33	CHDBA	275,	291	J. Gorman, A. Rytz, H.V. Michel

1972Go.A	PrvCom		91Ry01	J. Gorman, A. Rytz
1972Gr12	NUPAB	187,	141	A. Graue, L.H. Herland, K.J. Lervik, J.T. Nesse, E.R. Cosman
1972Gr19	NUPAB	189,	592	T. Grotdal, J. Limstrand, K. Nybø, K. Skar, T.F. Thorsteinsen
1972Gr23	YAFIA	15,	625	L.V. Groshev, L.I. Govor, A.M. Demidov
1972Gr34	IANFA	36,	833	L.V. Groshev, L.I. Govor, A.M. Demidov
1972Gr39	PRVCA	6,	1756	M.B. Greenfield, C.R. Bingham, E. Newman, M.J. Saltmars
1972Ha74	NUPAB	198,	353	A. Hasselgren
1972He23	NUPAB	193,	357	G. Heymann, P.M. Cronje
1972He36	ZEPYA	255,	385	A. Helppi, A. Pakkanen
1972He.A	AnRpt Grenoble			M. Hermen, A. Gizon also Thesis Grenoble 1971
1972Ho18	NUPAB	187,	599	P. Hornshøj, K. Wilsky, P.G. Hansen, B. Jonson, O.B. Nielsen
1972Ho19	NUPAB	187,	609	P. Hornshøj, K. Wilsky, P.G. Hansen, B. Jonson, O.B. Nielsen
1972Ho40	NUPAB	194,	481	G.A. Hokken, A.J.G. Hendricx, J. De Kogel
1972Hs01	NUPAB	179,	80	T.H. Hsu, R. Fournier, B. Hird, J. Kroon, G.C. Ball, F. Ingebretsen
1972Hu06	NUPAB	189,	264	F.R. Hudson, R.N. Glover
1972Hu10	NUPAB	195,	485	P. Hubert, M.M. Aleonard, D. Castera, F. Leccia, P. Menrath
1972Ja28	APOBB	3,	643	M. Jaskola, K. Nybø, B. Elbek
1972Ja.A	P-Teddington		236	A.A. Jaffe, G.A. Bissinger, S.M. Shafroth, T.A. White, T.G. Dzubay, F. Everling, D.W. Miller, D.A. Outlaw
1972Je02	NUPAB	185,	209	H.B. Jensen, H.B. Mak, C.A. Barnes
1972Jo08	ZEPYA	251,	425	H.W. Jongsma, R. Kamermans, H. Verheul
1972Ka57	SHIBA	20,	255	I. Kakatuse
1972Ke21	NUPAB	195,	177	A. Kerek, G.B. Holm, S. Borg, L.-E. de Geer
1972Ke28	NUPAB	198,	466	A. Kerek, P. Carle, J. McDonald
1972Ki06	ZEPYA	251,	93	A. Kiuru
1972Ki15	CPHMA	42,	11	A. Kiuru, P. Holmberg, L. Vanhanen
1972Ko03	PRVCA	5,	568	J.J. Kolata, W.W. Daehnick
1972Ko47	PRVCA	6,	1713	S.E. Koonin, B.I. Persson
1972La14	IJARA	23,	219	F. Lagoutine, J. Legrand, C. Perrot, J.P. Brethon, J. Morel
1972La20	ZEPYA	253,	16	R. Lasijo, R.K. Sheline, R.D. Griffioen, J.L. Dubbard
1972Le17	PRVCA	6,	517	L. Lessard, S. Gales, J.L. Foster, Jr.
1972Le37	IJARA	23,	279	V.E. Lewis, M.J. Woods, I.W. Goodier
1972Lo26	NUIMA	105,	453	G.D. Lopez, G.E. Thomas
1972Ly01	NUPAB	182,	272	L.L. Lynn, R.C. Schaller, D.A. Barbour, T.A. Belote, W.E. Dorenbusch
1972Ma15	PRVCA	5,	1380	J.V. Maher, J.R. Erskine, A.M. Friedman, R.H. Siemsen, J.P. Schiffer
1972Ma23	NUPAB	185,	465	P. Martin, M. Buenerd, Y. Dupont, M. Chabre
1972Ma42	PHSTB	5,	58	C.G. Mattsson, S.E. Arnell, L. Jonsson
1972Ma50	PRVCA	6,	851	J.C. Manthuruthil, F.W. Prosser, Jr.
1972Ma.A	P-Budapest		90	P. Matusek, H. Ottmar, C. Weitkamp, H. Woods
1972Mc08	PRVCA	5,	922	D.A. McClure, J.W. Lewis, III
1972Mc25	ZEPYA	255,	335	J.C. McGeorge, D.W. Nix, R.W. Fink, J.H. Landrum
1972Me09	NUPAB	185,	625	M.A. Meyer, J.P.L. Reinecke, D. Reitmann
1972Mi16	HPACA	45,	93	B. Michaud, J. Kern, L. Ribordy, L.A. Schaller
1972Mi26	JUPSA	33,	1505	K. Miyano, H. Nakharr, G. Gil
1972Mi27	JUPSA	33,	1509	K. Miyano, C. Gil
1972Mo12	PRVCA	5,	1678	R.A. Moyer
1972Mo33	NUPAB	195,	192	E. Monnard, R. Brissot, L.C. Carraz, J. Crançon, R. Ristori, F. Schussler, A. Moussa
1972Mu02	PRVCA	5,	95	T. Mukoyama, S. Shimizu
1972Mu09	PRVCA	6,	1802	T.J. Mulligan, E.R. Flynn, O. Hansen, R.F. Carsten, R.K. Sheline
1972Mu.A	BAPSA	17,	557	S.F. Mughabghab, G.W. Cole, R.E. Chrien, O.A. Wasson, M.R. Bhat
1972Na04	NCIAA	8,	305	T. Nagarajan, M. Ravindranath, K.V. Reddy
1972Ne05	NUPAB	185,	213	A.V. Nero
1972Ne10	PRVCA	6,	6793	A.V. Nero, R.E. Pixley, E.G. Adelsberger
1972Og03	IJMPD	8,	365	K. Ogata
1972Op01	NUPAB	180,	569	A.M.F. Op den Kamp, A.M.J. Spits
1972Pa02	PRVCA	5,	485	R.A. Paddock
1972Pa06	NUPAB	184,	157	A. Pakkanen, T. Komppa, H. Helppi
1972Pa24	ZEPYA	254,	98	A. Pakkanen, H. Helppi, T. Komppa, P. Puumalainen

1972Pe05	PRVCA	5,	1443	B.I. Persson, S.E. Koonin
1972Pi07	ZEPYA	252,	206	M. Piiparinen
1972Pu02	ZEPYA	252,	283	V. Pursiheimo, T. Tuurnala, T. Raunemaa
1972Ra05	PRVCA	5,	453	J. Rapaport, J.B. Ball, R.L. Auble, T.A. Belote, W.E. Dorenbusch
1972Ra39	NUPAB	197,	129	D. Rabenstein, D. Harrach, H. Vonach, G.G. Dussel, R.P.I. Perazzo
1972Ri08	PRVCA	5,	2072	F.A. Rickey, E.T. Journey, H.C. Britt
1972Sc08	ZEPYA	249,	286	W.D. Schmidt-Ott, R.W. Fink
1972Sh08	NUPAB	189,	220	R.E. Shamu, E.M. Bernstein, D. Blondin, J.J. Ramirez
1972Sh13	PRVCA	6,	537	E.B. Shera, U. Gruber, B.P.K. Maier, H.R. Koch, O.W.B. Schult, R.G. Lanier, N. Onishi, R.K. Sheline
1972Sh27	NUPAB	197,	17	J.R. Sheppard, R. Graetzer, J.J. Kraushaar
1972Sh.A	PrvCom	NDG	Jan	E.B. Shera
1972Si25	PRVCA	6,	1001	W.L. Sievers, D.A. Close, C.J. Umbarger, R.C. Bearse, F.W. Prosser, Jr.
1972Si28	NUPAB	193,	449	M. Singh, J.W. Sunier, R.M. Devries, G.E. Johnson
1972SI03	NUPAB	186,	28	W.F. Slot, G.H. Dulfer, H. Van der Molen, H. Verheul
1972Sv02	PHSTB	5,	23	B. Svahn, C. Bergman, H. Petterson
1972Sw01	NUPAB	185,	561	D.L. Swindle, N.A. Morcos, T.E. Ward, J.L. Meason
1972Ta13	ZEPYA	251,	87	O. Tannila, J. Kantele
1972To05	NUPAB	185,	574	J.P. Torres, P. Paris
1972To06	PRVCA	5,	2060	K.S. Toth, R.L. Hahn, M.A. Ijaz, R.F. Walker, Jr.
1972To07	NUPAB	189,	609	J.P. Torres, P. Paris, D. Lecouturier, P. Kilcher
1972Vi11	RAACA	17,	213	J. Visser, L. Lindner
1972Vo08	PRVCA	6,	266	T. von Egidy, O.W.B. Schult, D. Rabenstein, J.R. Erskine, O.A. Wasson, R.E. Chrien, D. Breitig, R.P. Sharma, H.A. Baader, H.R. Koch
1972Wa04	JINCA	34,	13	T.E. Ward, N.A. Morcos, P.K. Kuroda
1972Wa06	NUPAB	184,	166	G. Wallace, G.J. McCallum, N.G. Chapman
1972Wa10	NUPAB	188,	129	E. Wallander, E. Selin
1972Wa11	JINCA	34,	1767	A.C. Wahl
1972We.A	P-Teddington		94	L. Westgaard, J. Żylicz, O.B. Nielsen, ISOLDE
1972Wh02	PRVCA	5,	513	D.H. White, R.E. Birkett
1972Wh05	NUPAB	187,	12	D.H. White, R.E. Howe
1972Wi07	NUPAB	183,	439	J.L. Wiza, J.D. Garrett, R. Middleton
1972Wi18	NUPAB	191,	166	W. Wiesner, D. Flothman, H.J. Gils, R. Lohken, H. Rebel
1972Za04	PRVCA	6,	506	J.I. Zaitz, R.K. Sheline
1972Zi02	NUPAB	181,	465	J. Zioni, A.A. Jaffe, E. Friedman, N. Haik, R. Schreckman, D. Nir
1973				
1973Ab10	IANFA	37,	1967	S.N. Abramovich, B. Ya. Guzhkovskii, A.G. Zvenigorodskii, S.V. Trusillo
1973Ad02	PRVCA	7,	889	E.G. Adelsberger, A.B. McDonald, C.L. Cocke, C.N. Davis, A.P. Shukla, H.B. Mak, D. Ashery
1973Ah02	PRVCA	8,	737	I. Ahmad, J. Milsted, R.K. Sjoblom, J. Lerner, P.R. Fields
1973Ah04	NUPAB	208,	287	I. Ahmad, H. Diamond, J.M. Isted, J. Lerner, R.K. Sjoblom
1973A111	PRVCA	8,	657	D.E. Alburger, D.H. Wilkinson
1973A113	PRVCA	8,	1011	D.E. Alburger, D.R. Goosman, C.N. Davids
1973A120	IANFA	37,	1035	V.S. Aleksandrov, B.S. Dzelepov, A.I. Medvedev, V.E. Ter-Nersesyants, I.F. Uchevatkin, S.A. Shestopalova
1973Ba20	IANFA	37,	38	L.M. Bak, V.G. Nedovesov, Y.V. Kholnov, G.E. Shchukin
1973Ba22	IANFA	37,	73	K.A. Baskova, S.S. Vasilev, M.A. Mokhsen, T.V. Shugay, L.Y. Shavtalo
1973Ba34	PRLTA	31,	395	G.C. Ball, J.G. Costa, W.G. Davies, J.S. Forster, J.C. Hardy, A.B. McDonald
1973Ba35	JPAGB	6,	1011	D.G. Barnes, J.M. Calvert, T. Toy
1973Ba40	PRLTA	31,	728	R.C. Barber, J.O. Meredith, F.C.G. Southon, P. Williams, J.W. Barnard, K. Sharma, H.E. Duckworth
1973Ba56	PRVCA	8,	1438	J.B. Ball, J.J. Pinajian, J.S. Larsen, A.C. Rester
1973Ba72	NUPAB	217,	116	B.B. Back, E.R. Flynn, O. Hansen, R.F. Casten, J.D. Garrett
1973Be09	PYLBB	43,	117	W. Benenson, E. Kashy, I.D. Proctor, B.M. Freedom
1973Be14	PRVCA	7,	1143	W. Benenson, E. Kashy, I.D. Proctor
1973Be23	PRVCA	8,	210	W. Benenson, E. Kashy, I.D. Proctor

1973Be33	PRLTA	31,	647	C.E. Bemis, Jr., R.J. Silva, D.C. Hensley, O.L. Keller, Jr., J.R. Tarrant, L.D. Hunt, P.F. Dittner, R.L. Hahn, C.D. Goodman
1973Bo13	PRVCA	7,	1686	W.W. Bowman, D.R. Haenni, T.T. Sugihara
1973Bo20	YAFIA	17,	457	D.D. Bogdanov, V.A. Karnaukhov, L.A. Petrov
1973Br06	PRVCA	7,	1545	R.A. Britten, W.H. Johnson
1973Br12	PRVCA	7,	2545	E. Browne, F. Asaro
1973Br27	PRVCA	8,	1805	C.P. Browne, V.D. Coss, A.A. Rollefson
1973Br32	NUPAB	216,	493	R. Broda, A.Z. Hrynkiewicz, J. Styczen, W. Walus
1973Bu02	CJPHA	51,	455	D.G. Burke, J.C. Waddington, D.E. Nelson, J. Buckley
1973Bu17	IANFA	37,	938	V.S. Buttsev, K.Y. Gromov, V.G. Kalinnikov, V.A. Morozov, T.M. Muminov, A.B. Khalikulov
1973Bu18	IANFA	37,	953	V.S. Buttsev, Ts. Vylov, K.Y. Gromov, V.G. Kalinnikov, I.I. Gromova, V.A. Morozov, T.M. Muminov, H. Fuia, A.B. Khalikulov
1973Bu21	IANFA	37,	1024	V.S. Buttsev, K.Y. Gromov, V.G. Kalinnikov
1973Ca10	NUPAB	205,	121	M.H. Cardoso, P.F.A. Goudsmit, J. Konijn
1973Ch24	JINCA	35,	3061	K. Chayawattanangkur, G. Herrmann, N. Trautmann
1973Ci12	NUPAB	215,	429	G.J. Clark, J.M. Freeman, D.C. Robinson, J.S. Ryder, W.E. Burcham, G.T.A. Squier
1973Da01	PRVCA	7,	122	C.N. Davids, D.R. Goosman
1973Da05	CJPHA	51,	686	J.M. D'Auria, R.D. Guy, S.C. Gujrathi
1973Da22	PRVCA	8,	1029	C.N. Davids, D.R. Goosman
1973De16	PRVCA	7,	2131	J.H. Degnan, G.R. Rao
1973De22	ZEPYA	260,	75	F.W.N. De Boer, P.F.A. Goudsmit, B.J. Meyer, and PrvCom AHW
1973De39	IANFA	37,	998	A.M. Demidov, M.R. Akhmed, M.A. Khalil, C. Al-Nadzar
1973Ea01	NUPAB	208,	119	D.A. Eastham, I.S. Grant
1973Ed01	NUPAB	199,	463	F.M. Edwards, J.J. Kraushaar, B.W. Ridley
1973Es01	PRVCA	7,	280	P. Eskola
1973Es02	PHFEA	8,	357	P. Eskola, K. Eskola, M. Nurmi, A. Ghiorso
1973Fi06	NUPAB	208,	269	P.R. Fields, I. Ahmad, R.F. Barnes, R.K. Sjoblom, W.C. McHarris
1973Fr01	PRLTA	30,	102	A. Friedman, K. Katori
1973Ga01	NUPAB	202,	535	S. Gales, L. Lessard, J.L. Foster, Jr.
1973Ga04	CJPHA	51,	203	R.D. Gadsby, D.G. Burke, J.C. Waddington
1973Gh03	PRVCA	7,	2032	A. Ghiorso, K. Eskola, P. Eskola, M. Nurmi
1973Go05	NUPAB	201,	326	S.C. Goorse, J. Van Pelt, J. Vandenberg, J.C. Klein, J. Blok
1973Go11	PRVCA	7,	1133	D.R. Goosman, D.E. Alburger, J.C. Hardy
1973Go19	PRLTA	30,	1255	J.D. Goss, C.P. Browne, A.A. Rollefson
1973Go22	PRVCA	7,	2409	D.R. Goosman, C.N. Davids, D.E. Alburger
1973Go29	CHDBA	276,	669	D.J. Gorman, H.V. Michel, F. Asaro, A. Rytz
1973Go33	PRVCA	8,	1324	D.R. Goosman, C.N. Davids, D.E. Alburger
1973Go34	PRVCA	8,	1331	D.R. Goosman, C.N. Davids, D.E. Alburger
1973Go39	CHDBA	277,	29	D.J. Gorman, A. Rytz
1973Go40	NUPAB	217,	159	J. Godart, A. Gizon
1973Gr26	NUPAB	211,	541	T. Grottdal, L. Loset, K. Nybø, T.F. Thorsteinsen
1973Gu05	NUPAB	205,	574	H. Guratzsch, A.P. Kabachenko, I.V. Kuznetsov, K. Siewek-Wilczynska, N.I. Tarantin
1973Ha02	NUPAB	199,	560	S.I. Hayakawa, S.K. Mark, J.K.P. Lee, J.E. Kitching, G.C. Ball, W.G. Davies
1973Ha11	NUPAB	203,	532	J.K. Halbig, F.K. Wahn, W.L. Talbert, Jr., J.J. Eitter
1973Ha32	PRLTA	31,	323	O. Hausser, W. Witthuhn, T.K. Alexander, A.B. McDonald, J.C.D. Milton, A. Olin
1973Hi.A	HPACA	47,	93	T. Hinderling, H.H. Staub
1973Ho09	NUPAB	211,	165	R. Hochel, P.J. Daly, K.J. Hofstetter
1973Hu07	PYLBB	46,	361	E. Huenges, H. Rosler, H. Vonach
1973Ja06	ZEPYA	258,	337	U. Jäger, H. Münzel, G. Pfennig
1973Ja10	ZEPYA	261,	95	J.F.W. Jansen, A. Faas, W.J.B. Winter
1973Jo11	PHSTB	8,	99	A. Johansson, B. Nyman
1973Ka03	NUPAB	203,	97	N. Kato
1973Ka07	JUPSA	34,	857	K. Kawade, H. Yamamoto, K. Tsuchiya, T. Katoh
1973Ka23	PRVCA	8,	414	N. Kaffrell
1973Ki11	NUPAB	213,	61	K. Kimura

1973Ko03	PRVCA	7,	404	R.L. Kozub, D.H. Youngblood
1973Ko06	PRVCA	8,	285	J.J. Kolata, J.V. Maher
1973Ko10	NUPAB	204,	185	S. Kochan, B. Rosner, I. Tserruya, R. Kalish
1973Ko13	NUIMA	109,	83	J. Konijn, P.F.A. Goudsmit, E.W.A. Lingeman
1973Ku09	JOPQA	34,	159	W. Kurcewicz, K. Stryczniewicz, J. Żylicz, R. Broda, S. Chojnacki, W. Walus, I. Yutlandov
1973La17	PRVCA	7,	2600	H. Lancman, A. Bond
1973Le18	MTRGA	9,	14	V.E. Lewis, D. Smith, A. Williams
1973Lo08	CJPHA	51,	1369	G. Løvholden, D.G. Burke, J.C. Waddington
1973Mc04	PRVCA	7,	2097	J.R. McPherson, F. Gabbard
1973Me09	NUPAB	204,	636	B.J. Meyer, F.W.N. De Boer, P.F.A. Goudsmit
1973Me28	IJMPD	10,	359	J.O. Meredith, F.C.G. Southon, R.C. Barber, P. Williams, H.E. Duckworth
1973Mo03	NUPAB	202,	473	M.A. Moinester, G. Finkel, J. Alster, P. Martin
1973Mo18	JINCA	35,	3659	N.A. Morcos, W.D. James, D.E. Adams, P.K. Kuroda
1973Mo23	PRVCA	8,	1961	A. Moalem, B.H. Wildenthal
1973No09	NUPAB	217,	253	T. Nomura, K. Hiruta, T. Inamura, M. Odera
1973Oe02	ZEPYA	259,	263	W. Oelert
1973Ok.A	PrvCom	NDG	Aug	G.D. O'Kelley, C.F. Goeking, L.L. Collins, Sr.
1973Oo01	NUPAB	213,	221	M.A. Oothoudt, N.M. Hintz
1973Or03	PRVCA	8,	718	C.J. Orth, W.R. Daniels, D.C. Hoffman, F.O. Lawrence
1973Pi01	NUPAB	203,	369	W.F. Piel, Jr.
1973Po16	RAACA	19,	148	P. Polak
1973Pr05	JINCA	35,	1057	I.L. Preiss, J.J. Labrecque
1973Ra13	PYLBB	44,	255	S. Raman, H.J. Kim, T.A. Wakiewicz, M.J. Martin
1973Re03	PRVCA	7,	1663	I. Rezanka, I.M. Ladenbauer-Bellis, T. Tamura, W.B. Jones, F.M. Bernthal
1973Ry01	PYLBB	43,	30	J.S. Ryder, G.J. Clark, J.E. Draper, J.M. Freeman, W.E. Burcham, G.T.A. Squier
1973Sc17	PYLBB	44,	449	H. Schmeing, J.C. Hardy, R.L. Graham, J.S. Geiger, K.P. Jackson
1973Se03	NUPAB	199,	241	J.C. Sens, A. Pape, R. Armbruster
1973Se08	PRVCA	8,	258	R.G. Sextro, R.A. Gough, J. Cerny
1973Se12	JUPSA	34,	1443	T. Seo, T. Hayashi, T. Mitamura
1973Sh.A	PrvCom	NDG	Jan	E.B. Shera in NDS974
1973Si40	NUPAB	216,	97	R.J. Silva, P.F. Dittner, M.L. Mallory, O.L. Keller, K. Eskola, P. Eskola, M. Nurmi, A. Ghiorso
1973Sp06	NUPAB	215,	260	A.M.J. Spits, J.A. Akkermans
1973To08	PRVCA	8,	161	D.F. Torgerson, K. Wien, Y. Fares, N.S. Oakey, R.D. Macfarlane, W.A. Lanford
1973Va11	ZEPYA	259,	45	S.Y. Van der Werf
1973Ve06	PRVCA	8,	178	J. Vernotte, S. Galès, M. Langevin, J.M. Maison
1973Ve08	NUPAB	212,	493	J. Vernotte, S. Galès, M. Langevin, J.M. Maison
1973Vi09	RPHAA	8,	231	C. Vieu, A. Peghaire, J.S. Dionisio
1973Vi10	NUPAB	217,	372	V.E. Viola, Jr., M.M. Minor, C.T. Roche
1973Wa17	PRVCA	8,	297	O.A. Wasson, G.G. Slaughter
1973Wa18	PRVCA	8,	340	T.E. Ward, Y.Y. Chu, J.B. Cunnig
1973Wi06	PRLTA	30,	866	K.H. Willcox, N.A. Jelley, G.J. Wozniak, R.B. Weisenmiller, H.L. Harney, J. Cerny
1973Wo01	PRVCA	7,	160	F.K. Wohn, J.K. Halbig, W.L. Talbert, Jr., J.R. McConnel
1973Ya02	NUPAB	204,	33	S.W. Yates, P.J. Daly, N.R. Johnson, N.K. Arras
1973Za08	ZEPYA	264,	227	J.I. Zaitz, R.K. Sheline, R.D. Griffieon
1974				
1974Aj01	NUPAB	227,	1	F. Ajzenberg-Selove, T. Lauritsen
1974Al03	PRVCA	9,	991	D.E. Alburger
1974An05	IANFA	38,	48	N.M. Antoneva, A.V. Barkov, A.V. Zolotavin, P.P. Dmitriev, S.V. Kamynov, G.S. Katykhin, E.T. Kondrat, N.I. Krasnov, Y.N. Podkopayen, V.A. Sergienko, V.I. Fominikh
1974An22	IANFA	38,	1741	N.M. Antoneva, A.V. Barkov, V.M. Vinogradov, A.V. Zolotavin, G.S. Katykhin, V.M. Makarov, A.G. Shablinskii
1974An23	IANFA	38,	1748	N.M. Antoneva, A.V. Barkov, V.M. Vinogradov, A.V. Zolotavin, G.S. Katykhin, V.M. Makarov, A.G. Shablinskii

1974An24	IANFA	38,	1757	N.M. Antoneva, A.V. Barkov, A.V. Zolotavin, P.P. Zarubin, V.M. Makarov, V.Y. Padalko, Y.N. Podkopaev, V.A. Sergienko
1974Ar27	IANFA	38,	1569	R. Arlt, K.Y. Gromov, A. Latuszynski, K.G. Ortlepp, A. Jasinski
1974Ba15	PYLBB	49,	33	G.C. Ball, J.G. Costa, W.G. Davies, J.S. Forster, J.C. Hardy, A.B. McDonald
1974Ba90	CJPHA	52,	2386	R.C. Barber, J.W. Barnard, D.A. Burrell, J.O. Meredith, F.C.G. Southon, P. Williams, H.E. Duckworth
1974Be07	PRVCA	9,	589	R.R. Betts, H.T. Fortune, D.J. Pullen
1974Be20	PRVCA	9,	2130	W. Benenson, E. Kashy, D.H. Kong, A. Siou, A. Moalem, H. Nann
1974Be.A	ORNL-4967		37	C.E. Bemis, R.J. Silva, D.C. Hensley, O.L. Keller, Jr., O.L. Keller, J.R. Tarrant, L.D. Hunt, P.F. Dittner, R.L. Hahn, C.D. Goodman
1974Bi08	PRVCA	10,	729	P.K. Bindal, D.H. Youngblood, L. Kozun
1974Bo05	PRVCA	9,	836	J.D. Bowman, A.M. Poskanzer, R.G. Korteling, G.W. Butler, J.D. Bowman, A.M. Poska, J.D. Bowman, A.M. Poskanzer, R.G. Korteling, G.W. Butlernzer, R.G. Korteling, G.W. Butler
1974Bo26	NUIMA	117,	213	H.E. Bosch, J. Davidson, M.A. Farioli, V. Silbergleit
1974Bu21	IANFA	38,	1566	V.P. Burminkii, B.G. Kiselev, O.D. Kovrigin
1974Bu22	PRVCA	10,	2483	D.L. Bushnell, D.J. Buss, R.K. Smither
1974By01	NUPAB	223,	125	T. Byrski, F.A. Beck, P. Engelstein
1974Ca.A	Th.-Amsterdam			M.H. Cardoso
1974Ce05	PRVCA	10,	2654	J. Cerny, N.A. Jelley, D.L. Hendrie, C.F. Maguire, J. Mahoney, D.K. Scott, R.B. Weisenmiller
1974Ch17	JPSLB	35,	41	A. Charvet, R. Chery, R. Duffait
1974Ch18	PRVCA	9,	1839	R.E. Chrien, D.I. Garber, J.L. Holm, K. Rimawi
1974Ch21	ZEPYA	267,	355	A. Charvet, R. Chery, D.P. Phuoc, R. Duffait
1974Co21	CJPHA	52,	1215	A.H. Colenbrander, T.J. Kennett
1974Co27	PRVCA	10,	1236	J.R. Comfort, R.W. Finlay, C.M. McKenna, P.T. Debevec
1974Co35	NUPAB	233,	185	F. Corvi, M. Stefanon
1974Da02	PRVCA	9,	216	C.N. Davids, D.R. Goosman, D.E. Alburger, A. Gallmann, G. Guillaume, D.H. Wilkinson, W.A. Lanford
1974De09	NUPAB	225,	317	F.W.N. De Boer, P.F.A. Goudsmit, P. Koldewijn, B.J. Meyer
1974De22	YAFIA	19,	1161	R.A. Demirkhanov, M.I. Dzkuya, V.V. Dorokhov, G.A. Dorokhova
1974De31	CJPHA	52,	1416	P. Debenham, W.R. Falk, M. Canty
1974De37	NUPAB	230,	490	E.O. Deneijs, M.A. Meyer, J.P.L. Reinecke, D. Reitman
1974De47	NUPAB	236,	349	F.W.N. De Boer, P.F.A. Goudsmit, B.J. Meijer, P. Koldewijn, J. Konijn, R. Beetz
1974Di03	PRVCA	10,	1172	M. Diksie, L. Yaffe, D.G. Sarantites
1974Di.A	P-Amsterdam		114	J.S. Dionisio, C. Vieu, V. Berg, C. Bourgeois
1974Do09	NUPAB	229,	47	G. Doukellis, C. McKenna, R. Finlay, J. Rappaport, H.J. Kim
1974Em01	NUPAB	231,	437	A. Emsallem, D.P. Huoc, R. Chery, M. Ashgar
1974Er.A	AnRpt Julich			R. Ermer, W. Delang, P. Gottel, H.H. Guven, B. Hrastnik, O.W.B. Schult, H. Seyfarth
1974Ev02	NUPAB	230,	109	D. Evers, W. Assmann, K. Rudolph, S.J. Skorka, P. Sperr
1974FI01	PRVCA	9,	210	E.R. Flynn, J.D. Garrett
1974Fr01	PRVCA	9,	760	A.M. Friedman, K. Katori, D. Albroght, J.P. Schiffer
1974Ge05	PRVCA	9,	2363	W. Gelletly, W.R. Kane, D.R. MacKenzie
1974Gh04	PRLTA	33,	1490	A. Ghiorso, J.M. Nitschke, J.R. Alonso, C.T. Alonso, M. Nurmia, G.T. Seaborg, E.K. Hulet, R.W. Loughheed
1974Gi09	NUPAB	233,	81	S. Gilad, S. Cochavi, M.A. Moinester, J. Alster, M. Buenard, P. Nartin
1974GI10	AENGA	37,	78	V.M. Glazov, R.I. Borisova, A.I. Shaviev
1974Go17	PRVCA	10,	756	D.R. Goosman, D.E. Alburger
1974Go20	ZEPYA	269,	111	S.C. Goverse, J. Kuiper, J. Blok
1974Gr11	NUPAB	223,	66	R.C. Greenwood, C.W. Reich
1974Gr22	PRVCA	10,	624	R.D. Griffioen, R.K. Sheline
1974Gr37	NUIMA	121,	385	R.C. Greenwood, R.G. Helmer
1974Gr41	IANFA	38,	2499	E.P. Grigorev, A.V. Zolotavin, S.V. Kaminov
1974Gu10	YAFIA	19,	1167	K. Gurach, A.P. Kabachenko, I.V. Kuznetsov, N.I. Tarantin
1974Ha02	PRVCA	9,	252	J.C. Hardy, H. Schmeing, W. Benenson, G.M. Crawley, E. Kashy, H. Nann
1974Ha35	PRLTA	33,	320	J.C. Hardy, G.C. Ball, J.S. Geiger, R.L. Graham, J.A. Macdonald, H. Schmeing
1974Ha55	PRVCA	10,	1829	G. Hardie, D. Gloeckner, L. Meyer-Schutzmeister, T.H. Braid
1974Ho21	PYLBB	51,	345	S.D. Hoath, R.J. Petty, J.M. Freeman, G.T.A. Squier, W.E. Burcham

1974Ho27	NUPAB	230,	380	P. Hornshøj, P.G. Hansen, B. Jonson
1974Hr01	NUPAB	219,	381	B. Hrustnik, H. Seyfarth, A.M. Hassan, W. Delang, P. Gottel
1974Hu15	NUIMA	121,	307	E. Huenges, H. Vonach, J. Labetzki
1974Ia01	CJPHA	52,	96	R. Iafigliola, S.C. Gujrathi, B.L. Tracy, J.K.P. Lee
1974Is01	PRVCA	9,	1662	H.A. Ismail, W.H. Moore, J.N. Hallock, H.A. Enge
1974Ja10	PYLBB	49,	341	K.P. Jackson, J.C. Hardy, H. Schmeing, R.L. Graham, J.S. Geiger, K.W. Allen
1974Je01	PRVCA	9,	2067	N.A. Jelley, K.H. Wilcox, R.B. Weisenmiller, G.J. Wozniak, J. Cerny
1974Jo14	PRVCA	10,	2449	P.L. Jolivet, J.D. Goss, G.L. Marolt, A.A. Rollefson, C.P. Browne
1974Ju.A	PrvCom		74AjLa	E.T. Jurney
1974Ju.B	PrvCom	AHW		E.T. Jurney
1974Ka05	ZEPYA	266,	21	N. Kaffrell, N. Trautmann, R. Denig
1974Ka15	PRVCA	9,	2102	E. Kashy, W. Benenson, J.A. Nolen, Jr.
1974Ke01	NUPAB	221,	333	J. Kern, G. Mauron, B. Michaud, K. Schreckenbach, T. von Egidy, W. Mampe, H.R. Koch, H.A. Baader, D. Breitig, U. Gruber
1974Ke13	PRVCA	10,	1554	J. Kern, D. Duc
1974Ke14	ZEPYA	270,	129	J. Keinonen, A. Anttila, M. Bister
1974Ki02	PRVCA	9,	767	J. Kim, R.L. Robinson
1974Kn02	PRVCA	9,	1467	J.D. Knight, C.J. Orth, W.T. Leland, A.B. Tucker
1974Ko08	NUPAB	221,	45	D.H. Kong-A-Siou, A.J. Cole, A. Giorni, J.P. Longequeue
1974Ko20	NUPAB	231,	266	D.G. Kovar, N. Stein, C.K. Bockelman
1974Ku01	NUPAB	218,	201	I. Kumabe, S. Matsuki, S. Nakamura, M. Hyakutake, M. Matoba, T. Sato
1974Le02	PRVCA	9,	1091	Y. Le Beyec, M. Lefort, J. Livet, N.T. Porile, A. Siivola
1974Ma09	PRVCA	9,	1633	R.G. Markham, H.W. Fulbright
1974Me15	YAFIA	19,	437	R.J. Metskvarishvili, Z.N. Miminoshvili, M.A. Elizbarashvili
1974Mu10	NUPAB	224,	437	F. Münnich, D. Lode, H. Schrader, A. Høglund, W. Pessara
1974Na07	PRVCA	9,	1848	H. Nann, W. Benenson, E. Kashy, P. Turek
1974Ne10	PRVCA	10,	320	K. Neubeck, H. Schober, H. Waffler
1974No02	PRVCA	9,	1168	T. Nomura, K. Hiruta, M. Yoshie, O. Hashimoto
1974No07	NUIMA	115,	189	J.A. Nolen, Jr., G. Hamilton, E. Kashy, D. Proctor
1974Oe03	NUPAB	230,	413	W. Oelert, G. Lindstrom, V. Riech
1974Pe15	NUPAB	235,	205	R.J. Peel, D.R. Dixon, M.W. Hill, G.L. Jensen, N.F. Mangelson, N. Nath, V.C. Rogers
1974Po08	PRVCA	10,	803	F.T. Porter, I. Ahmad, M.S. Freedman, J. Milsted, A.M. Friedman
1974Pr15	IANFA	38,	2135	P.T. Prokofev, L.I. Simonov
1974Ra31	PHFEA	9,	103	V. Rahkonen, J. Kantele
1974Ra.A	P-Bombay		10	C.N. Rao, B.M. Rao, P.M. Rao, K.V. Reddy
1974Ri03	PRVCA	9,	1978	K. Rimawi, J.B. Garg, R.E. Chrien, G.W. Cole, O.A. Wasson
1974Ri08	NUPAB	228,	461	A. Riccato, P. David
1974Ro11	ZEPYA	266,	65	E. Roeckl, D. Lode, K. Bächmann, B. Neidhart, G.K. Wolf, W. Lauppe, N. Kaffrell, P. Patzelt
1974Ro12	ZEPYA	266,	123	E. Roeckl, D. Lode, W. Pessar
1974Ro16	PRVCA	9,	1801	R.G.H. Robertson, S.M. Austin
1974Ro17	PRLTA	32,	1207	R.G.H. Robertson, S. Martin, W.R. Falk, D. Ingham, A. Djalois
1974Ro18	PRVCA	9,	2272	S.J. Rothman, N.L. Peterson, W.K. Chen, J.J. Hines, R. Bastar, L.C. Robinson, L.J. Nowicki, J.B. Anderson
1974Ro44	PRAMC	3,	186	A. Roy, K.V.K. Iyengar, M.L. Jhingan, S.K. Bhattacharjee
1974Ru08	NUIMA	120,	333	G. Rudstam, S. Shalev, O.C. Jonsson
1974Sc02	CJPHA	52,	131	R.L. Schulte, J.D. King, W. Taylor
1974Sc06	ZEPYA	266,	129	H.M. Schupferling, K.-W. Hoffmann
1974Sc19	PRVCA	10,	296	W.D. Schmidt-Ott, K.S. Toth, E. Newman, C.R. Bingham
1974Sc26	PRLTA	33,	1343	D.K. Scott, B.G. Harvey, D.L. Hendrie, L. Krauss, C.F. Maguire, J. Mahoney, Y. Terrien, K. Yagi
1974Se05	PRLTA	33,	233	K.K. Seth, A. Saha, W. Benenson, W.A. Langford, H. Nann, B.H. Wildenthal
1974Sp04	NUPAB	224,	517	A.M. Spits, J. de Boer
1974To04	ZEPYA	268,	289	F. Tolea, K.R. Baker, W.D. Schmidt-Ott, R.W. Fink
1974To07	PRVCA	10,	2550	K.S. Toth, C.R. Bingham, W.D. Schmidt-Ott
1974Vi02	ZEPYA	269,	173	M. Viitasalo, I. Forsblom
1974Vo08	IANFA	38,	672	I. Votsilka, K.U. Zibert, B. Kracik, J. Liptak, A.F. Novgorodov, K.G. Ortlepp, M. Toshev, V. Habenicht

1974Vy01	IANFA	38,	701	Ts. Vylov, N.A. Golovkov, K.Y. Gromov, I.I. Gromova, A. Kolachkovsky, M.Y. Kuznetsova, Y.V. Norseev, V.G. Chumin
1974Wa08	PRVCA	9,	1396	C.W. Wang, Y.C. Liu, E.K. Lin, C.C. Hsu, G.C. Kiang
1974Wa14	PRVCA	10,	1983	T.R. Ward, P.F. Hausteine, J.B. Cumming, Y.Y. Chu
1974Wi17	PRVCA	10,	2184	B.H. Wildenthal, J.A. Rice, B.M. Freedom
1974Ya07	JUPSA	37,	10	H. Yamamoto, K. Kawade, H. Fukaya, T. Katoh
1975				
1975Ad08	IANFA	39,	1681	I. Adam, G. Baier, K.Y. Gromov, T.A. Islamov, K.G. Ortlepp, K. Tiroff, E. Herrmann, H. Strusnii
1975Ad09	NUPAB	254,	63	I. Adam, K.Y. Gromov
1975Ah01	NUPAB	239,	1	I. Ahmad, J. Milsted
1975Ah05	PRVCA	12,	541	I. Ahmad, F.T. Porter, M.S. Freedman, R.K. Sjoblom, J. Lerner, R.F. Barnes, J. Milsted, P.R. Fields
1975Aj03	PRVCA	12,	1868	F. Ajzenberg-Selove, R. Middleton, J.D. Garrett
1975Al.A	P-Leningrad			A.A. Aleksandrov, et al
1975An07	NUPAB	242,	93	R.E. Anderson, R.L. Bunting, J.D. Burch, S.R. Chinn, J.J. Kraushaar, R.J. Peterson, D.E. Prull, B.W. Ridley, R.A. Ristinen
1975As04	NUPAB	247,	359	M. Asghar, J.P. Gautheron, G. Bailleul, J.P. Bocquet, J. Greif, H. Schrader, G. Siegert, C. Ristori, J. Crancon, G.I. Crawford
1975Ba25	YAFIA	21,	230	S.A. Baranov, V.M. Shatinskii, L.V. Chistyakov, V.M. Shubko
1975Ba27	ZETFPA	68,	8	S.A. Baranov, V.M. Shatinskii
1975Ba65	YAFIA	22,	670	S.A. Baranov, V.M. Shatinskii
1975Ba.B	AnRpt CSNSM		35	G. Bastin, C.F. Liang
1975Be09	ZENAA	30,	356	M.J. Bechara, O. Dietsch
1975Be21	NUPAB	245,	515	H. Behrens, M. Kobelt, L. Szybisz, W.G. Thies
1975Be28	NUPAB	246,	317	H. Behrens, M. Kobelt, L. Szybisz, W.G. Thies
1975Be38	PYLB	58,	46	W. Benenson, A. Guilchard, E. Kashy, D. Mueller, H. Nann, L.W. Robinson
1975Be.B	P-Paris		54	U. Bertsche, F. Rauch, K. Stelzer
1975Bh01	PRVCA	12,	1457	M.R. Bhat, R.E. Chrien, G.W. Cole, O.A. Wasson
1975B101	PRVCA	11,	939	J.N. Black, W.C. McHarris, W.H. Kelly, B.H. Wildenthal
1975Bo11	YAFIA	21,	233	D.D. Bogdanov, A.V. Demyanov, V.A. Karnaukhov, L.A. Petrov
1975Bo14	NUPAB	245,	107	W. Bohne, H. Fuchs, K. Grabisch, D. Hilscher, U. Jahnke, H. Kluge, T.G. Masterson, H. Morgenstern
1975Bo29	ZPAAD	273,	373	H.E. Bosch, J. Davidson, V. Silbergleit, C.A. Heras, S.M. Abecassis
1975Bo59	RBFSA	5,	215	L.C.S. Boueres, O. Dietsch, T. Polga
1975Br02	PRVCA	11,	546	D. Breitig, R.F. Casten, W.R. Kane, G.W. Cole, J.A. Cizewski
1975Br16	NUPAB	245,	243	A.R. Brosi, B.H. Ketelle
1975Br29	NCIAA	30,	483	A. Brondi, R. Moro, P. Pelter, F. Terassi
1975Br.A	Th.-Mainz			W. Brüchele
1975Bu01	PRVCA	11,	1401	D.L. Bushnell, J. Hawkins, R. Goebbert, R.K. Smither
1975Bu02	CJPHA	53,	948	D.G. Burke, J.M. Balogh, and erratum CJPHA 63(1985)649
1975Bu.A	BAPSA	20,	625	M.E. Bunker, B.S. Nielsen, J.W. Starnes, B.J. Dropesky, W.R. Daniels
1975Ca06	NUPAB	241,	341	C. Cabot, C. Deprun, H. Gauvin, B. Lagarde, Y. Le Beyec, M. Lefort
1975Ca07	NUPAB	242,	221	T. Caldwell, D.J. Pullen, O. Hansen
1975Ch05	NUPAB	238,	333	A. Charvet, R. Chery, R. Duffait, M. Morgue
1975Ch11	PRVCA	11,	1237	J. Chao, D.K. Olsen, C. Newson, P.J. Riley
1975Ch21	JPHGB	1,	657	R. Chapman, G.D. Dracoulis
1975Co.A	AnRpt CSNSM			Collaboration CSNSM-IPN-Marbourg-Stockholm-Varsovie
1975Da14	NUPAB	250,	221	J.M. Davidson, T. Taylor, D.A. Hutcheon, D.M. Sheppard, W.C. Olsen
1975De.A	P-Petten		609	J. de Boer
1975Em04	ZPAAD	275,	157	A. Emsallem, M. Ashgar
1975Em.A	P-Petten		395	A. Emsallem, M. Ashgar
1975Er.A	PrvCom	NDG	Jul	J.R. Erskine
1975FI07	ZPAAD	272,	219	D. Flothman, H.J. Gils, W. Wiesner, R. Loehken
1975Fr16	PRVCA	12,	616	E.M. Franz, S. Katcoff
1975Fr.A	P-Paris		126	J.M. Freeman, R.J. Petty, S.H. Hoath, J.S. Ryder, W.E. Burcham, G.T.A. Squier
1975Fr.B	AnRpt AFI		146	K. Fransson, M. af Ugglas, P. Carle

1975Gr32	NUPAB	252,	260	R.C. Greenwood, C.W. Reich, S.H. Vegors, Jr.
1975Gu01	JPHGB	1,	67	S.C. Gujrathi, C. Weiffenbach, J.K.P. Lee
1975Gu15	PRVCA	12,	1109	A. Guichard, H. Nann, B.H. Wildenthal
1975Ha43	ZPAAD	274,	335	H.H. Hansen, D. Mouchet
1975He.C	KFK-2223			D. Heck, J.A. Pinston, H. Börner, F. Braumandl, P. Jeuch, H.R. Koch, W. Mampe, R. Rousille, K. Schreckenbach
1975Ho09	PYLBB	57,	147	P. Hornshøj, P. Tidemand-Petersson, R. Bethoux, A.A. Caretto, J.W. Grüter, P.G. Hansen, B. Jonson, E. Hagberg, S. Mattsson
1975Ho14	NUPAB	248,	406	P. Hornshøj, P. Tidemand-Petersson, R. Kaczarowski, B. Kotlinska
1975Jj.A	BAPSA	20,	1154	M.A. Ijaz, Vpi e su, E.L. Robinson, K.S. Toth, C.R. Bingham
1975Is04	PRVCA	12,	708	H.A. Ismail, J.N. Hallock, W.H. Moore, H.A. Enge
1975Ja10	PRVCA	11,	2114	J. Jänecke, F.D. Becchetti, L.T. Chua, A.M. Vandermolten
1975Jo.A	BAPSA	20,	625	O.P. Jolly, D.G. Burke
1975Ka15	JUPSA	38,	314	K. Kawade, H. Yamamoto, Y. Ikeda, T. Katoh
1975Ka18	PRVCA	11,	1959	E. Kashy, W. Benenson, D. Mueller, R.G.H. Robertson, D.R. Goosman
1975Ka25	PRVCA	12,	1054	D. Kaiser, W.H. Johnson, Jr.
1975Ka.A	P-Petten		544	B. Kardon, H. Seyfarth, P. Gottel, H.H. Guven
1975Ke08	PRVCA	12,	553	G.G. Kennedy, S.C. Gujrathi, S.K. Mark
1975Ke09	ZPAAD	274,	233	G.G. Kennedy, S.C. Gujrathi, S.K. Mark
1975Ke12	NUPAB	255,	296	J.J. Kent, S.L. Blatt
1975Kl06	NUPAB	245,	133	H.V. Klapdor, M. Schrader, G. Bergdolt, A.M. Bergdolt
1975Ko18	PRVCA	12,	1511	R. Kouzes, W.H. Moore, and erratum PRVCA 13,890
1975Ku14	NUPAB	247,	152	A.W. Kuhfeld, N.M. Hintz
1975La02	JINCA	37,	623	J.J. Labreque, I.L. Preiss, H. Bakhru, R.I. Morse
1975Li14	JUPSA	39,	1	C.Y. Liu, T.H. Hsue, K. Lin, P.K. Tseng, C.C. Hsu, C.W. Wang
1975Li22	NUPAB	253,	165	J.R. Lien, J.S. Vaagen, A. Graue
1975Lo03	NUPAB	243,	413	M.A. Lone, E.D. Earle, G.A. Bartholemew
1975Lu02	PRVCA	11,	1470	D.H. Lueders, J.M. Daley, S.G. Buccino, F.E. Durham, C.E. Hollandsworth, W.P. Bucher, H.D. Jones
1975Ma04	NUPAB	237,	285	M.R. MacPhail, R.G. Summers-Gill, see also thesis Winnipeg, and PrvCom AHW September 1980
1975Ma05	PRVCA	11,	587	G.J. Matthews, F.M. Bernthal, J.D. Immele
1975Ma.A	P-Petten		655	P. Matussek
1975Me10	PRVCA	12,	401	L.R. Medsker, H.T. Fortune, S.C. Headley
1975Me13	PYLBB	58,	297	L.R. Medsker, H.T. Fortune
1975Me20	ZPAAD	275,	67	B.J. Meijer, J. Konijn
1975Me23	PRVCA	12,	2010	R.A. Meyer, R.G. Lanier, J.T. Larsen
1975Mo26	PYLBB	58,	286	A. Moallem, M.A.M. Shahabuddin, R.G. Markham, H. Nann
1975Mo29	NUPAB	252,	477	P. Morgen, J.H. Onsgaard, B.S. Nielsen, C. Sondergaard
1975Mu08	PYLBB	57,	44	L.G. Multhauf, K.G. Tirsell, S. Raman, J.B. McGrory
1975Mu09	PRVCA	12,	51	D. Mueller, E. Kashy, W. Benenson, H. Nann
1975Na.A	P-Petten		566	M.R. Najam, A.F.M. Ishaq, M. Anwar, A.M. Khan, J.A. Mirza
1975No.A	P-Paris		140	J. Nolen
1975PI06	IJARA	26,	579	J. Plch, J. Zderadicka, O. Dragoun
1975Ra07	NUPAB	242,	189	D. Rabenstein, D. Harrach
1975Ra08	JPHGB	1,	461	C.N. Rao, B.M. Rao, P.M. Rao, K.V. Reddy see 75Ra09
1975Ra09	PRVCA	11,	1735	C.N. Rao, B.M. Rao, K.V. Reddy
1975Re09	NUPAB	249,	166	W. Reiter, W.H. Breunlich, P. Hille
1975Ro01	PRLTA	34,	33	R.G.H. Robertson, W.S. Chien, D.R. Goosman
1975Ro05	NUPAB	240,	221	C. Rolfs, W.S. Rodney, S. Durrance, H. Winkler
1975Ro16	NUPAB	246,	380	R. Rousille, J.A. Pinston, H. Börner, H.R. Koch, D. Heck
1975Ro25	ZEPYA	275,	45	S. Roodbergen, H. Visser, W. Molendijk, H.S. Bedet, H. Verheul
1975Sc07	NUPAB	242,	232	H. Schmeing, J.C. Hardy, R.L. Graham, J.S. Geiger
1975Se.A	BAPSA	20,	73	F.J.D. Serduke, W. Henning
1975Si03	CJPHA	53,	391	B. Singh, M.W. Johns
1975Sl.A	BAPSA	20,	560	G.G. Slaughter, S. Raman
1975Sm02	PRVCA	11,	1392	L.G. Smith, A.H. Wapstra
1975Sq01	NUPAB	242,	62	G.T.A. Squier, W.E. Burcham, J.M. Freedman, R.J. Petty, S.D. Hoath, J.S. Ryder

1975St07	NUPAB	242,	30	H. Strusny, H. Tyrroff, E. Herrmann, G. Musiol, M.I. Baznat, G. Beyer, K.Y. Gromov, M. Honusek, T.A. Islamov, V.V. Kuznetsov, H.-U. Siebert
1975St08	CJPHA	53,	922	W.R. Stott, J.C. Waddington, D.G. Burke, G. Løvhøiden
1975St12	CZYPA	25,	626	H. Strusny, H. Tyrroff, E. Herrmann, G. Musiol
1975Ta06	ZPAAD	272,	301	C.W. Tang, A. Pakkanen, Z.C. Mester, C.D. Coryell, G. Chilosi, A.H. Wapstra, K. Bos
1975Ta12	PRVCA	12,	108	H. Taketani, H.L. Sharma, N.M. Hintz
1975Th04	NUPAB	242,	1	R.C. Thompson, J.S. Boyno, J.R. Huizenga, D.G. Burke, T.W. Elze
1975Th06	NUPAB	245,	444	R. Thompson, A. Ikeda, R.K. Sheline
1975Th08	PRVCA	12,	644	C. Thibault, R. Klapisch, C. Rigaud, A.M. Poskanzer, R. Prieels, L. Lessard, W. Reisdorf
1975To05	PRVCA	12,	533	K.S. Toth, W.D. Schmidt-Ott, C.R. Bingham, M.A. Ijaz
1975Un.A	P-Paris		81	UNISOR consortium
1975Va24	PHFEA	10,	133	S. Vaisala, T. Raunemaa, A. Fontell, G. Graeffe, A. Siivola
1975Va.A	P-Leningrad		156	V.M. Vachte, N.A. Golovkov, B.S. Dzelepov, R.B. Ivanov, A. Lyushenski, M.A. Michailova, A.B. Mozhuchin, B.G. Shumin
1975Vi01	JINCA	37,	11	V.E. Viola, Jr., C.T. Roche, M.M. Minor
1975Vy02	IANFA	39,	1671	Ts. Vylvov, I.I. Gromova, V.G. Kalinnikov, V. Kuznetsov, T.M. Muminov, V.A. Morozov, V.I. Fominikh, R.R. Uzmanov, E.R. Shavgulidze
1975We03	CJPHA	53,	101	C. Weiffenbach, S.C. Gujrathi, J.K.P. Lee
1975We10	PHSTB	11,	10	T. Westrom, B. Fant, I. Forsblom, M. Viitasalo
1975We23	ZPAAD	275,	127	L. Westgaard, K. Aleklett, G. Nyman, E. Roeckl
1975We24	PHFEA	10,	167	T. Weckstrom, I. Forsblom, P. Holmberg
1975We.A	P-Petten		749	C. Weitkamp, P. Matusek, H. Ottmar
1975Wi06	PRVCA	11,	1477	W.M. Wilson, G.E. Thomas, H.E. Jackson
1975Wi08	ZPAAD	272,	291	G. Wirth, N. Kaffrell, K. Chayawattanangkur, G. Herrmann, K.E. Seyb
1975Wi26	PYLBB	59,	142	K.H. Wilcox, R.B. Weisenmiller, G.J. Wozniak, N.A. Jelley, D. Ashery, J. Cerny
1975Yo01	NUPAB	243,	143	N. Yoshikawa
1975Ze.A	JINR-P6-8929			A. Zelinsky, K. Zuber, Y. Zuber, V.V. Kuznetsov, A. Kolachkovsky, A. Lyatshinsky, Y.V. Norseev, H.G. Ortlepp, I. Penev, A.V. Potempa
			1976	
1976Aj03	PRVCA	14,	767	F. Ajzenberg-Selove, E.R. Flynn, O. Hansen, J.D. Sherman, N. Stern, J.W. Sunier
1976Al01	NUPAB	257,	490	M.M. Aleonard, P. Hubert, L. Sarger, P. Mennrath
1976Al16	NUIMA	136,	323	D.E. Alburger
1976An05	PYLBB	61,	234	G. Andersson, M. Ashgar, A. Emsallem, E. Hagberg, B. Jonson
1976Ba99	AENGA	41,	342	S.A. Baranov, et al
1976Ba.A	P-Cargese		106	T. Batsch, M. Nowicki, J. Żylicz
1976Be02	NUPAB	256,	87	D. Berenyi, G. Hock, A. Menes, G. Szekeley, Cs. Ujhelyi, B.A. Zon
1976Be08	PRVCA	13,	1479	W. Benenson, A. Guichard, E. Kashy, D. Mueller, H. Nann
1976Be11	NUPAB	260,	269	G. Beyer, A. Jasinski, O. Knotek, H.G. Ortlepp, H.U. Siebert, R. Aelt, E. Herrmann, G. Musiol, H. Tyrroff
1976Be50	PRVCA	14,	2095	D. Benson, Jr., P. Kleinheinz, R.K. Sheline, R.B. Shera
1976Be.A	AnRpt OakRidge		73	C.E. Bemis, Jr., C.E. Bemis, D.C. Hensley, P.F. Dittner, R.L. Hahn, R.J. Silva, J.R. Tarrant, L.D. Hunt, and PrvCom AHW July 1981
1976Be.B	AnRpt MSUCL		11	F.M. Bernthal
1976Bi09	PRVCA	14,	1586	C.R. Bingham, L.L. Riedinger, F.E. Turner, B.D. Kern, J.L. Weil, K.J. Hofstetter, J. Lin, E.F. Zganjar, A.V. Ramayya, J.H. Hamilton, J.L. Wood, G.M. Gowdy, R.W. Fink, E.H. Spejewski, W.D. Schmidt-Ott, R.L. Mlekodaj, H.K. Carter, K.S.R. Sastry
1976Ca10	NUPAB	261,	445	R.F. Casten, D. Burke, O. Hansen
1976Ca24	PRVCA	14,	1439	R.F. Carlton, S. Raman, J.A. Harvey, G.G. Slaughter
1976Ca25	PRVCA	14,	912	R.F. Casten, W.R. Kane, J.R. Erskine, A.M. Friedman, D.S. Gale
1976Ch02	PRVCA	13,	578	R.E. Chrien, G.W. Cole, G.C. Slaughter, J.A. Harvey
1976Cr03	PYLBB	64,	143	G.M. Crawley, W.F. Steele, J.N. Bishop, P.A. Smith, S. Maripuu
1976Cr.B	JINR-P6-9711			T. Cretzu, V.V. Kuznetsov, G. Luzurej, G. Macarie, M. Finger
1976Da20	PRVCA	14,	2011	W.W. Daehnick, M.M. Spisak, R.M. Del Vecchio

1976Da.C	P-Cargese		100	J.M. D'Auria, J.W. Grüter, L. Westgaard, G. Nyman, P. Peuser, E. Roeckl, H. Otto, ISOLDE
1976Da.D	P-Cargese		262	J.M. D'Auria, L.C. Carraz, P.G. Hansen, B. Jonson, S. Mattsson, H.L. Ravn, M. Skarestad, L. Westgaard
1976Di15	NUIMA	139,	181	J.S. Dionisio, C. Vieu, C.M. Truong, G. Leur
1976Di.A	AnRpt OakRidge			P.F. Dittner, R.J. Silva, D.C. Hensley, R.L. Hahn, J.R. Tarrant, L.D. Hunt, and PrvCom AHW July 1981
1976Do05	NUPAB	263,	210	P. Doll, G.J. Wagner, K.T. Knopfle
1976Ed.A	P-Cargese		258	M.D. Edmiston, R.A. Warner, W.C. McHarris, W.H. Kelly
1976EI11	PRVCA	14,	583	D. Elmore, W.P. Alford
1976EI12	CJPHA	54,	1493	D. Elmore, W.P. Alford
1976FI02	PRVCA	13,	568	E.R. Flynn, J.D. Sherman, N. Stein, D.K. Olsen, P.J. Riley
1976Fo01	PRVCA	13,	1049	S. Fortier, H. Laurent, J.P. Schapira, M.S. Antony, A. Knipper
1976Fr13	NUIMA	134,	153	J.M. Freeman
1976Fr.A	USIP-76-09			K. Fransson, M. af Ugglas, P. Carle, T. Erikson
1976Ga19	NUPAB	268,	257	S. Galès, S. Fortier, H. Laurent, J.M. Maison, J.P. Schapira
1976Ga.A	P-Baku			M. Gasior, B.G. Kalinnikov, T. Kretsu
1976Ge02	PRVCA	13,	1434	W. Gelletly, W.R. Kane, R.F. Casten
1976Ge06	NUIMA	134,	309	H. Genz, J. Reisberg, A. Richter, B.M. Schmitz, G. Schrieder, K. Werner
1976Ge08	NUPAB	267,	13	H. Genz, A. Richter, B.M. Schmitz, H. Behrens
1976Ge14	PRVCA	14,	1896	R.J. Gehrke, R.G. Helmer, C.W. Reich, R.A. Anderl
1976Go02	PRVCA	13,	1601	G.M. Gowdy, A.C. Xenoulis, J.L. Wood, K.R. Baker, R.W. Fink, J.L. Weil, B.D. Kern, K.J. Hofstetter, E.H. Spejewski, R.L. Mlekodaj, H.K. Carter, W.D. Schmidt-Ott, J. Lin, C.B. Ringham, L.L. Riedinger, E.F. Zganjar, K.S. Sasstry, A.V. Ramayya, J.H. Hamilton
1976Gr09	NUPAB	270,	29	R.C. Greenwood, R.J. Gehrke, R.G. Helmer, C.W. Reich, J.D. Baker
1976Gr19	PHSTB	14,	263	T. Grottdal, L. Guldberg, K. Nybø, T.F. Thorsteinsen
1976Gr20	APOBB	7,	507	K.Y. Gromov, D.T. Dzelev, K. Zuber, Y. Zuber, T.A. Islamov, V.V. Kuznetsov, H.G. Ortlepp, A.V. Potempa
1976Gr.A	P-Cargese		428	J.W. Grüter, B. Jonson, O.B. Nielsen
1976Ha29	PYLBB	63,	27	J.C. Hardy, J.A. Macdonald, H. Schmeing, T. Faestermann, H.R. Andrews, J.S. Geiger, R.L. Graham, K.P. Jackson
1976Ha36	ZPAAD	278,	183	W. Hartl, J.W. Hammer
1976Ha39	PRVCA	14,	645	P.E. Haustein, E.M. Franz, S. Katcoff, N.A. Morcos, H.A. Smith, Jr., T.E. Ward
1976He04	NUPAB	258,	83	R.G. Helmer, R.J. Gehrke, R.C. Greenwood, C.W. Reich, L.D. McIsaac
1976He10	ZPAAD	276,	393	W. Herzog, N. Trautmann, R. Denig, G. Herrmann
1976He.B	NDSBA	17,	287	E.A. Henry
1976Hi08	CJPHA	54,	1360	C.R. Hirning, D.G. Burke
1976Hi09	NUPAB	263,	460	F. Hintenberger, P. von Rossen, B. Schuller, J. Bisping, R. Jahn
1976Hi10	PRLTA	37,	130	G.T. Hickey, D.C. Weisser, J. Cerny, G.M. Crawley, A.F. Zeller, T.R. Ophel, D.F. Hebbard
1976Hi14	JPHGB	2,	L143	G.T. Hickey, G.M. Crawley, D.C. Weisser, N. Shikazono
1976Hu01	PRVCA	13,	1786	A. Huck, G.J. Costa, G. Walter, M.M. Aleonard, J. Dalmas, P. Hubert, F. Leccia, P. Mennrath, J. Verotte, M. Langevin, J.M. Maison
1976In06	PRVCA	14,	254	P.D. Ingalls
1976Jo01	PRVCA	13,	439	P.L. Jolivet, J.D. Goss, J.A. Bieszk, R.D. Hichwa, C.P. Browne
1976Jo.A	P-Cargese		277	B. Jonson, E. Hagberg, P.G. Hansen, P. Hornshøj, P. Tidemand-Petersson, ISOLDE
1976Ka08	NUPAB	260,	141	E.J. Kaptein, H.P. Blok, L. Hulstman, J. Blok
1976Ka19	NUPAB	266,	346	R. Kamermans, H.W. Jongsma, T.J. Ketel, R. van der Wey, H. Verheul
1976Ka24	PRVCA	14,	1773	E. Kashy, W. Benenson, D. Mueller, H. Nann, L. Robinson
1976Ka50	SHIBA	24,	247	I. Kakatuse, H. Nakabushi, K. Ogata
1976Ki12	NUPAB	272,	381	K. Kimura, N. Takagi, M. Tanaka
1976Lu02	PRVCA	13,	1544	E. Lund, G. Rudstam
1976Lu04	NUIMA	134,	173	E. Lund, G. Rudstam
1976Ma03	PRVCA	13,	118	J.F. Mateja, G.F. Neal, J.D. Goss, P.R. Chagnon, C.P. Browne
1976Ma16	PRVCA	13,	1117	D.J. Martin, M.R. MacPhail
1976Ma35	PRVCA	14,	1141	L.G. Mann, W.B. Walters, R.A. Meyer
1976Ma40	PRVCA	14,	1320	D.J. Martin, H.C. Evans, J.A. Szucs

1976Ma49	ZPAAD	278,	327	P. Maier-Komor, P. Glassel, E. Huengas, H. Rossler, H.K. Vonach, H. Baier
1976Me08	PRVCA	13,	1751	L.R. Medsker
1976Mi01	PRVCA	13,	879	G.F. Millington, R.M. Hutcheon, J.R. Leslie, W.M. McLatchie
1976Mo32	NUPAB	272,	82	S. Mordechai, E. Friedman, A.A. Jaffe, D. Nir, M. Paul
1976Na23	PRVCA	14,	2338	H. Nann, D. Mueller, A. Saha, E. Kashy
1976No07	PYLBB	65,	125	J.W. Noé, D.F. Geesaman, P. Paul, M. Suffert
1976Nu01	PRVCA	13,	2017	L.L. Nunnolley, W. Loveland
1976Pa11	PRVCA	14,	1573	B.P. Pathak, L. Lesard, L. Nikkinen
1976Pi04	NUPAB	264,	1	J.A. Pinston, R. Rousille, H. Börner, H.R. Koch
1976Pi13	NUPAB	270,	61	J.A. Pinston, R. Rousille, H. Börner, W.F. Davidson, P. Jeuch, H.R. Koch, K. Schreckenbach
1976Ra16	JPGPE	2,	243	B.M. Rao, C.N. Rao, P.M. Rao, R. Mathews, K.V. Reddy
1976Ra33	CUSCA	45,	606	K.V. Ramaniam, G.K. Raju, K.V. Reddy
1976Ra37	ZPAAD	279,	301	D.G. Raich, H.R. Bowman, R.E. Eppley, J.O. Rasmussen, I. Rezanka
1976Ro04	PRVCA	13,	1018	R.G.H. Robertson, W. Benenson, E. Kashy, D. Mueller
1976Sc13	NUPAB	263,	193	M. Schrader, H. Reiss, G. Rosner, H.V. Klapdor
1976Sh24	NUIMA	135,	583	J.F. Sharpey-Schafer, A.M. Al Naser, A.H. Behbehani, L.L. Green, A.N. James, C. Lister, P.J. Nolan
1976SI06	NUPAB	274,	93	D.N. Slater, W. Booth
1976Sp08	NUPAB	265,	416	R.J. Sparks
1976Sq01	PYLBB	65,	122	G.T.A. Squier, W.E. Burcham, S.D. Hoath, J.M. Freeman, P.H. Barker, R.J. Petty
1976St10	NUPAB	266,	390	O. Straume, G. Løvhøiden, D.G. Burke
1976St11	NUPAB	266,	424	W.F. Steele, P.A. Smith, J.E. Finck, G.M. Crawley
1976Su.A	BAPSA	21,	658	E. Sugarbaker, W.S. Gray
1976Su.B	BAPSA	21,	984	E. Sugarbaker, W.S. Gray
1976To06	PYLBB	63,	150	K.S. Toth, M.A. Ijaz, J. Lin, E.L. Robinson, B.O. Hannah, E.H. Spejewski, J.D. Cole, J.H. Hamilton, A.V. Ramayya
1976Tr01	PRVCA	13,	50	R.E. Tribble, R.A. Kenefick, R.L. Spross
1976Tr03	PYLBB	61,	353	R.E. Tribble, J.D. Cossairt, R.A. Kenefick
1976Tr07	IANFA	40,	2026	E.F. Tretyakov, N.F. Myasoedov, A.M. Apalikov, V.F. Konyaev, V.A. Lyubimov, E.G. Novikov
1976Tu.A	Th.-Berkeley			D.G. Tuggle
1976Vi02	PYLBB	60,	261	D.J. Vieira, D.F. Sherman, M.S. Zisman, R.A. Gough, J. Cerny
1976Vi.A	P-Cargese		462	C. Vieu, J.S. Dionisio, V. Berg, C. Bourgeois
1977				
1977Aj01	PRVCA	15,	1	F. Ajzenberg-Selove, E.R. Flynn, S. Orbesen, J.W. Sunier
1977Al09	NUPAB	281,	213	K. Aleklett, E. Lund, G. Nyman, G. Rudstam
1977Al17	NUPAB	285,	1	K. Aleklett, E. Lund, G. Nyman, G. Rudstam
1977Az01	PRVCA	15,	1847	G. Azuelos, J.E. Kitching, K. Ramavataram
1977Ba10	CJPHA	55,	200	J.W. Barnard, P. Williams, R.C. Barber, S.S. Hague, K.S. Kozier, K.K. Sharma, H.E. Duckworth
1977Ba16	NUPAB	279,	199	P.H. Barker, R.E. White, H. Naylor, N.S. Wyatt
1977Ba33	IANFA	41,	101	I.F. Barchuk, G.V. Belykh, V.I. Golyshkin, A.F. Ogorodnik, M.M. Tuschinski
1977Ba69	YAFIA	26,	461	S.A. Baranov, V.M. Shatinskii
1977Be03	PRVCA	15,	146	M.J. Bennet, R.K. Sheline
1977Be09	PRVCA	15,	705	C.E. Bemis, Jr., R.L. Ferguson, F. Plasil, R.J. Silva, F. Pleasanton, R.L. Hahn
1977Be13	PRVCA	15,	1187	W. Benenson, D. Mueller, E. Kashy, H. Nann, L.W. Robinson
1977Be15	ZPAAD	281,	145	D. Benson, Jr., P. Kleinheinz, R.K. Sheline
1977Be36	PRVCA	16,	1146	C.E. Bemis, Jr., P.F. Dittner, R.J. Silva, R.L. Hahn, J.R. Tarrant, L.D. Hunt, D.C. Hensley
1977Bh03	ZPAAD	281,	65	T.S. Bhatia, H. Hafner, R. Haupt, R. Maschuw, G.J. Wagner
1977Bo02	NUPAB	275,	229	D.D. Bogdanov, A.V. Demyanov, V.A. Karnaukhov, L.A. Petrov, A. Płochocki, V.G. Subbotin, J. Voboril
1977Bo28	PYLBB	71,	67	D.D. Bogdanov, J. Vobořil, A.V. Demyanov, L.A. Petrov
1977Bo31	IANFA	41,	1149	N.A. Bonch-Osmolovskaya, V.M. Gorodzankin, K.Y. Gromov, T. Kretsu, V.V. Kuznetsov, G. Makarie, A.S. Khamidov, M. Yatiski

1977Bo32	IANFA	41,	1189	B. Bogdan, M. Gasior, T. Kretsu, V.V. Kuznetsov, N.A. Lebedev, G.I. Lizurei, G. Makarie, D.G. Popescu, A.S. Khamidov
1977Bo.A	PrvCom	AHW	Oct	V.R. Bom, D. De Bruin
1977Ca09	PRVCA	15,	883	R.F. Carlton, S. Raman, G.G. Slaughter
1977Ca19	NUPAB	285,	235	R.F. Casten, R.C. Greenwood, M.R. MacPhail, R.E. Chrien, W.R. Kane, G.J. Smith, J.A. Cizewski BNL-22352
1977Ca23	ZPAAD	283,	221	C. Cabot, S. Della Negra, C. Deprun, H. Gauvin, Y. Le Beyec
1977Ch06	ZPAAD	280,	149	H.C. Cheung, S.I. Hayakawa, J.E. Kitching, J.K.P. Lee, S.K. Mark, J.C. Waddington
1977Co08	PRVCA	15,	1685	J.D. Cossairt, R.E. Tribble, R.A. Kenefick
1977Cr05	IANFA	41,	2032	T. Cretsu, G. Makarie, A.V. Potempa, E. Senyavski
1977De06	PRVCA	15,	800	J. Deslauriers, S.C. Gujrathi, S.K. Mark
1977De25	ZPAAD	283,	33	J. Deslauriers, S.C. Gujrathi, S.K. Mark
1977De32	JPSLB	38,	393	S. Della Negra, B. Lagarde, Y. Le Beyec
1977Dr07	AENGA	42,	314	A.A. Druzhinin, V.K. Grigorev, A.A. Lbov, S.P. Vesnovskii, N.G. Krylov, V.N. Polynov
1977Em02	NUPAB	293,	379	R.A. Emigh, R.E. Anderson
1977Er02	ZPAAD	280,	79	B. Erlandson, J. Lyttkens
1977Fi08	NUPAB	288,	57	L.K. Fifield, F.P. Calaprice, C.H. Zimmermann, M.J. Hurst, A. Pakkanen, T.J.M. Symons, F. Watt, K.W. Allen
1977Fi03	PRVCA	15,	879	E.R. Flynn, J.W. Sunier, F. Ajzenberg-Selove
1977Fo02	ZPAAD	281,	89	B. Fogelberg, W. Maup
1977Fo09	PYLBB	70,	408	H.T. Fortune, R. Middleton, M.E. Coburn, G.E. Moore, S. Mordechai, R.V. Kolarits, H. Nann, W. Chung, B.H. Wildenthal
1977Fr20	ZPAAD	281,	211	T. Freie, H. Lorenz-Wirba, B. Cleff, H.P. Trautvetter, C. Rolfs
1977Ge03	NUPAB	283,	45	J. Genevey-Rivier, A. Charvet, G. Marguier, C. Richard-Serre, J. D'Auria, A. Huck, G. Klotz, A. Knipper, G. Walter
1977Gu02	PRVCA	15,	894	P. Guibault, D. Ardouin, R. Tamisier, P. Avignon, M. Vergnes, G. Rotbard, G. Berrier
1977Ha31	PRVCA	16,	1129	D.R. Haenni, T.T. Sugihara
1977Ha32	PRVCA	16,	1559	P.E. Hausteine, E.M. Franz, R.F. Petry, J.C. Hill
1977Ha48	NUPAB	293,	1	E. Hagberg, P.G. Hansen, J.C. Hardy, P. Hornshøj, B. Jonson, S. Mattsson, P. Tidemand-Petersson
1977He26	NUIMA	147,	425	J.C.P. Heggie, Z.E. Zwickowski
1977Ho02	NUPAB	276,	1	C.L. Hollas, K.A. Aniol, D.W. Gebbie, M. Borsaru, J. Nurzinski, L.O. Barbopoulos
1977Ho09	JUPSA	42,	1098	M. Hoshi, M. Fujiwara, Y. Yoshisama
1977Ho18	PRLTA	39,	537	P. Hornshøj, H.L. Nielsen, N. Rud
1977Ho25	NUPAB	288,	429	P. Hornshøj, L. Hojsholt-Poulsen, N. Rud
1977Ij01	PRVCA	15,	2251	M.A. Ijaz, C.R. Bingham, H.K. Carter, E.L. Robinson, K.S. Toth
1977Is01	ZPAAD	281,	365	A.F.M. Ishaq, S. Robertson, W.V. Prestwich, T.J. Kennett
1977Je03	PRVCA	15,	1972	C.M. Jensen, W.R.G. Lanier, G.L. Struble, L.G. Mann, S.G. Prussin
1977Jo03	PRVCA	15,	915	C.H. Johnson, J.K. Bair, C.M. Jones
1977Ka08	NUPAB	279,	269	K. Kawade, H. Yamamoto, Y. Ikeda, V.N. Bhoraskar, T. Katoh
1977Ke03	PRVCA	15,	792	G. Kennedy, J. Deslauriers, S.C. Gujrathi, S.K. Mark
1977Ko04	PRVCA	15,	1947	J.J. Kolata, M. Oothoudt
1977Ko10	PRVCA	16,	132	R.L. Kozub, B.E. Cooke, J.R. Leslie, B.C. Robertson
1977Ko15	PRVCA	16,	588	B.K.S. Koene, R.E. Chrien
1977Ko.A	PrvCom	AHW	Feb	B.K. Koene, R.E. Chrien, M. Yachim
1977Ko.B	P-Tashkent		65	T. Kozlowski, T. Kormitski, Y. Lushtshnski, A. Yasinski
1977Kr.A	JINR-P6-10748			T. Kretsu, V.V. Kuznetsov, G. Luzurej, Chan Chen Mo, V.M. Gorodzankin, G. Makarie
1977Li14	NUPAB	286,	263	J. Liptak, K. Kristiakova, J. Kristiak
1977Li16	PHSTB	15,	205	E. Lingeman
1977Lu06	NUPAB	286,	403	E. Lund, K. Aleklett, G. Rudstam
1977Ma12	PRVCA	15,	1708	J.F. Mateja, C.P. Browne
1977Ma24	NUPAB	288,	1	J.A. Macdonald, J.C. Hardy, H. Schmeing, T. Faestermann, H.R. Andrews, J.S. Geiger, R.L. Graham, K.P. Jackson
1977Mc05	NUPAB	281,	325	A.B. McDonald, E.D. Earle, M.A. Lone, F.C. Khanna, H.C. Lee

1977Mc09	PRVCA	16,	1278	D.A. McClure, S. Raman, G.C. Slaughter
1977Me04	PRVCA	15,	649	L.R. Medsker, L.H. Fry, Jr., J.L. Yntema
1977Mi10	PRVCA	16,	1605	R.J. Mitchell, T.V. Ragland, R.P. Scharenberg, R.E. Holland, F.J. Lynch
1977Mi.A	KFK-2438			M. Mirkiditsian
1977Mo13	NUPAB	289,	36	S. Mordechai, M.E. Coburn, G.E. Moore, H.T. Fortune
1977Mu03	PRVCA	15,	1282	D. Mueller, E. Kashy, W. Benenson
1977Na05	PRVCA	15,	1448	A.M. Nathan, D.E. Alburger
1977Na17	PRVCA	16,	1566	A.M. Nathan, D.E. Alburger, J.W. Olness, E.K. Warburton
1977Na24	NUIMA	144,	331	H. Naylor, R.E. White
1977No08	PYLBB	71,	314	J.A. Nolen, T.S. Bhatia, H. Hafner, P. Doll, C.A. Wiedner, G.J. Wagner
1977Nu01	PRVCA	15,	444	L.L. Nunnelley, W.D. Loveland
1977Pa01	PRVCA	15,	730	L.A. Parks, C.N. Davids, R.C. Pardo
1977Pa13	PRVCA	15,	1811	R.C. Pardo, C.N. Davids, M.J. Murphy, E.B. Norman, L.A. Parks
1977Pa18	PRVCA	16,	370	R.C. Pardo, C.N. Davids, M.J. Murphy, E.B. Norman, L.A. Parks
1977Pa24	NUPAB	289,	94	M. Paul, A. Murinov, J. Burde, C. Drory, J. Lichtenstadt, S. Mordechai, E. Navon
1977Pe17	PRVCA	16,	1878	F. Pellegrini, P. Guazzoni, D. Sinclair, E. Garman
1977Pr07	PRVCA	16,	1001	S.G. Prussin, R.G. Lanier, G.L. Struble, L.G. Mann, S.M. Schoenung
1977Ra08	IJOPA	15,	41	K.V. Ramaniah, G.R. Raju, K.V. Reddy
1977Ra17	JPHGB	3,	637	Venkata Ramaniahah, G. Kusa Raju, K. Venkata Reddy
1977Ra18	JPHGB	3,	633	Venkata Ramaniahah, K. Venkata Reddy
1977Re12	CUSCA	46,	95	T.S. Reddy, R. Matthews, K.V. Reddy
1977Re.A	Th.-Montreal			D.M. Rehfield DABBB 38,4874(1978)
1977Ri04	PRVCA	15,	1271	K. Rimawi, R.E. Chrien
1977Ro03	CJPHA	55,	206	D.W.O. Rogers, N. Anyas-Weiss, S.P. Dolan, N.A. Jelley, T.K. Alexander
1977Sc03	PYLBB	66,	133	A.G. Schmidt, R.L. Mlekodaj, E.L. Robinson, F.T. Avignone, J. Lin, G.M. Gowdy, J.L. Wood, R.W. Fink
1977Sc21	ZPAAD	283,	43	F. Schussler, J. Blachot, E. Monnard, J.A. Pinston, B. Pfeiffer, K. Hawerkamp, R. Stippler
1977Sh04	CJPHA	55,	506	S.H. Sharma, K.S. Kozier, J.W. Barnard, R.C. Barber, S.S. Haque, H.E. Duckworth
1977Sh06	PRVCA	15,	903	J.D. Sherman, D.L. Hendrie, M.S. Zisman
1977Sh08	PYLBB	67,	275	J.D. Sherman, E.R. Flynn, O. Hansen, N. Stein, J.W. Sunier
1977Sh12	CJPHA	55,	1360	K.S. Sharma, J.O. Meredith, R.C. Barber, K.S. Kozier, S.S. Hague, J.W. Barnard, F.C.G. Southon, P. Williams, H.E. Duckworth
1977So02	CJPHA	55,	383	F.C.G. Southon, J.O. Meredith, R.C. Barber, H.E. Duckworth
1977St10	NUPAB	281,	240	M. Stefanon, F. Corvi
1977St15	PRVCA	16,	574	M.L. Stelts, J.C. Browne
1977St22	CJPHA	55,	1687	O. Straume, D.G. Burke
1977Tr03	PRVCA	15,	2028	R.E. Tribble, J.D. Cossairt, R.A. Kenefick
1977Tr05	PRVCA	16,	917	R.E. Tribble, J.D. Cossairt, D.P. May, R.A. Kenefick
1977Tr07	PRVCA	16,	1835	R.E. Tribble, J.D. Cossairt, D.P. May, R.A. Kenefick
1977Tu01	ZPAAD	280,	309	T. Tuurnala, K. Katajanheimo, E. Hammaren
1977Vo02	NUPAB	278,	189	H. Vonach, P. Glässel, E. Huenges, P. Maier-Komor, H. Rösler, H.J. Scheerer, H. Paul, D. Semrad
1977Vy02	IANFA	41,	1634	Ts. Vylov, N.A. Golovkov, B.S. Dzelepov, R.B. Ivanov, M.A. Mikhailova, Y.V. Norseev, V.G. Shumin
1977Wh01	NUPAB	276,	333	R.E. White, H. Naylor
1977Wh03	AUJPA	30,	365	R.E. White, H. Naylor
1977Ya07	JUPSA	43,	8	H. Yamamoto, K. Kawade, K. Ikeda, T. Katoh
1977Zo02	PRVCA	16,	408	D.R. Zolnowski, T.T. Sugihara
			1978	
1978Aj01	PRVCA	17,	960	F. Ajzenberg-Selove, E.R. Flynn, J.W. Sunier, D.L. Hanson
1978A118	PRVCA	18,	462	K. Aleklett, E. Lund, G. Rudstam
1978A129	PRVCA	18,	2727	D.E. Alburger, S. Mordechai, H.T. Fortune, R. Middleton
1978An10	NUPAB	303,	154	K.A. Aniol, D.W. Gebbie, C.L. Hollas, J. Nurzinski
1978An14	PHSTB	18,	165	G. Andersson, M. Ashgar, A. Emsallem, E. Hagberg, B. Jonson, P. Tidemand-Petersson

1978Ar12	PRVCA	18,	1201	D. Ardouin, C. Lebrun, F. Guilbault, B. Remand, E.R. Flynn, D.L. Hanson, S.D. Orbesen, M.N. Vergnes, G. Rotbard, K. Kumar
1978As06	ZPAAD	288,	45	M. Ashgar, A. Emsallem, E. Hagberg, B. Jonson, P. Tidemand-Petersson
1978Az01	PRVCA	17,	443	G. Azuelos, G.R. Rao, P. Taras
1978Ba30	IANFA	42,	205	Y.A. Badenko, K.I. Derebshova, V.N. Kushmin, Y.A. Nemilov, L.M. Solin, E.D. Teterin, V.S. Romanov
1978Ba44	PRLTA	41,	738	P.A. Baisden, R.E. Leber, M. Nurmia, J.M. Nitschke, M. Michel, A. Ghiorso
1978Ba.C	P-Alma Ata		123	S.A. Baranov, V.M. Shatinskii, L.V. Chistyakov, N.I. Aleshin
1978Be09	PRVCA	17,	529	G. Berrier-Ronsin, M. Vergnes, G. Rotbard, J. Vernotte, J. Kalifa, R. Seltz, H.L. Sharma
1978Be22	ZPAAD	285,	405	D. Benson, Jr., P. Kleinheinz, R.K. Sheline, E.B. Shera
1978Be26	PRVCA	17,	1939	W. Benenson, E. Kashy, A.G. Ledebuhr, R.C. Pardo, R.G.H. Robertson, L.W. Robinson
1978Bh02	PYLBB	76,	562	T.S. Bhatia, H. Hafner, J.A. Nolen, Jr., W. Saathoff, R. Schuhmacher, R.E. Tribble, G.J. Wagner, C.A. Wiedner
1978Bo20	NUPAB	303,	145	D.D. Bogdanov, A.V. Demyanov, V.A. Karnaukhov, L.A. Petrov, J. Voboril
1978Bo32	NUPAB	307,	421	D.D. Bogdanov, A.V. Demyanov, V.A. Karnaukhov, M. Nowicki, L.A. Petrov, J. Voboril, A. Plochocki
1978Bo.A	P-Alma Ata		54	D.D. Bogdanov, I. Bobordzil, A.V. Demianov, L.A. Petrov
1978Bu18	PRVCA	18,	693	D.G. Burke, G. Løvhøiden, E.R. Flynn, J.W. Sunier
1978Ca11	ZPAAD	287,	71	C. Cabot, S. Della Negra, C. Deprun, H. Gauvin, Y. Le Beyec
1978Ch22	MTRGA	14,	157	P. Christmas, P. Cross
1978Co.A	AnRpt Texas AM			J.D. Cossairt, D.P. May
1978Cr02	IANFA	42,	56	T. Cretzu, V.V. Kuznetsov, G. Luzurej, V.M. Gorodzankin, G. Macarie
1978Cr03	ZPAAD	287,	45	J. Crançon, C. Ristori, H. Ohm, W. Rudolph, K.-L. Kratz, M. Asghar
1978Da04	PRVCA	17,	1815	C.N. Davids, D.F. Geesaman, S.L. Tabor, M.J. Murphy, E.B. Norman, R.C. Pardo
1978Da07	NUPAB	301,	397	J.M. D'Auria, J.W. Grüter, E. Hagberg, P.G. Hansen, J.C. Hardy, P. Hornshøj, B. Jonson, S. Mattsson, H.L. Ravn, P. Tidemand-Petersson
1978De18	NUPAB	302,	186	P. Decowski, W. Benenson, B.A. Brown, A.A. Rollefson
1978De.A	AnRpt Berkeley			R.J. De Meyer, D.P. Stahel, A.N. Bice, R. Jahn, J. Cerny
1978Di09	YAFIA	28,	273	R.A. Demirkhanov, V.V. Dorokhov, M.I. Dzkuya, G.A. Dorokhova, see also report SFTII Suchumi
1978Do06	ZPAAD	286,	107	P.H. Do, R. Chery, H.G. Börner, W.F. Davidson, J.A. Pinston, R. Rousille, K. Schreckenbach, H.R. Koch, H. Seyfarth, D. Heck
1978Du06	ZPAAD	287,	165	F. Dubbers, L. Funke, P. Kemnitz, G. Winter, S. Elfstrom, T. Lindblad, C.G. Linden
1978Ek02	PHSTB	18,	51	C. Ekstrom, S. Ingelman, G. Wannberg, M. Skarestad
1978El11	PRVCA	18,	2713	Y.A. Ellis, K.S. Toth, H.K. Carter
1978Fi02	PRVCA	17,	718	R.B. Firestone, R.A. Warner, W.C. McHarris, W.H. Kelly
1978Ga07	YAFIA	27,	894	Yu. P. Gangrskii, G.M. Marinescu, M.B. Miller, V.N. Samosyuk, I.F. Kharisov
1978Ge01	NUPAB	295,	221	C.P. Gerner, J. Van Pelt, O.W. De Ridder, J. Blok
1978Go15	NUPAB	312,	56	G.M. Gowdy, J.L. Wood, R.C. Fink
1978Gr10	NUPAB	303,	265	H.C. Griffin, I. Ahmad, A.M. Friedman, L.E. Glendenin
1978Gr13	YAFIA	27,	1421	I.I. Gromova, T. Kretsu, V.V. Kuznetsov, G.I. Lizurei, N.A. Lebedev, V.M. Gorozhankin, G. Macarie
1978Gu14	ZPAAD	287,	271	H.H. Guven, B. Kardon, H. Seyfarth
1978Ha07	PYLBB	73,	127	O. Hausser, T.K. Alexander, T. Faestermann, D. Horn, D. Ward, H.R. Andrews, I.S. Towner
1978Ha11	NUPAB	296,	251	S.I. Hayakama, I.R. Hyman, J.K.P. Lee
1978Ha14	PRVCA	17,	1414	J.E. Halverson, W.H. Johnson, Jr.
1978Ha52	HYIND	4,	196	O. Häusser, T. Faestermann, I.S. Towner, T.K. Alexander, H.R. Andrews, J.R. Beene, D. Horn, D. Ward, C. Broude
1978Hi06	NUPAB	308,	61	F. Hintenberger, R. Schonhagen, P. von Rossesn, B. Schuller, F.E. Blumenberg, P.D. Eversheim, R. Gorgen
1978Hu06	CJPHA	56,	936	H. Huang, B.P. Pathek, J.K.P. Lee
1978Ik02	PYLBB	74,	326	H. Ikegami, T. Yamazaki, S. Morinobu, I. Katayama, M. Fujiwara, Y. Fujita, N. Koori
1978Ik03	JUPSA	45,	725	Y. Ikeda, H. Yamamoto, K. Kawade, T. Katoh, K. Nagahara

1978Ja06	JPHGB	4,	579	A.N. James, J.F. Sharpey-Schafer, A.M. Al Naser, A.H. Behbehani, C.J. Lister, P.J. Nolan, P.H. Barker, W.E. Burcham
1978Ka10	JUPSA	44,	25	M. Kanazawa, S. Ohya, T. Tamura, Z. Ishibashi, N. Mutsuro
1978Ka12	PRVCA	17,	1555	R. Kamermans, J. Van Driel, H.P. Blok, P.J. Blankhorst
1978Ke06	PRVCA	17,	1929	G.J. KeKelis, M.S. Zisman, D.K. Scott, R. Jahn, D.J. Vieira, J. Cerny, F. Ajzenberg-Selove
1978Ke10	PRVCA	18,	1938	B.D. Kern, F. Gabbard, R.G. Kruzek, M.R. McPherson, K.K. Sekharan, F.D. Snyder
1978Ko24	NUPAB	307,	71	R.T. Kouzes, D. Mueller
1978Ko27	NUPAB	309,	329	R.T. Kouzes, P. Kutt, D. Mueller, R. Sherr
1978Ko28	PRVCA	18,	1587	R.T. Kouzes, D. Mueller, C. Yu
1978Ko29	ZPAAD	288,	319	E. Koglin, G. Jung, G. Siegert, R. Decker, K.D. Wunsch, H. Wollnik
1978Le.A	Table of Isotopes			C.M. Lederer, V.S. Shirley, E. Browne, J.M. Dairiki, R.E. Doebler, A.A. Shihab-Eldin, L.J. Jardine, J.K. Tuli, A.B. Buyrn
1978Lo07	NUPAB	302,	51	G. Løvghøiden, O. Straume, D.G. Burke
1978Lo13	JINCA	40,	1865	R.W. Loughheed, J.F. Wild, E.K. Hulet, R.W. Hoff, J.H. Landrum
1978Ma18	JUPSA	44,	1070	Z. Matumoto, T. Tamura
1978Ma23	NUPAB	301,	213	J.W. Maas, E. Somorjai, H.D. Graber, C.A. Vandenwijngaard, C. Van der Leun, P.M. Endt
1978Ma24	NUPAB	301,	237	J.W. Maas, A.J.C. Holvast, A. Baghus, H.J.M. Aarts, P.M. Endt
1978Mo12	NUPAB	305,	29	L.A. Montestruque, M.C. Cobian Rozak, G. Szaloky, J.D. Zumbro, S.E. Darden
1978Mu05	PRVCA	17,	1574	M.J. Murphy, C.N. Davids, E.B. Norman, R.C. Pardo
1978Na02	PRVCA	17,	830	F. Naulin, C. Détraz, M. Bernas, E. Kashy, M. Langevin, F. Pougheon, P. Roussel
1978Na11	PRVCA	18,	1619	H. Nann, A. Saha, S. Raman
1978No03	PRVCA	17,	2176	E.B. Norman, C.N. Davids, M.J. Murphy, R.C. Pardo
1978No05	PRVCA	18,	102	E.B. Norman, C.N. Davids
1978Pa11	PRVCA	18,	1249	R.C. Pardo, E. Kashy, W. Benenson, L.W. Robinson
1978Pa12	PRVCA	18,	1277	I. Paschopoulos, E. Müller, H.J. Körner, I.C. Oelrich, K.E. Rehm, H.J. Scheerer
1978Pe08	NUPAB	302,	1	J.G. Pengra, H. Genz, R.W. Fink
1978Pf01	PRLTA	41,	63	L.P. Pfeiffer, A.P. Mills, Jr., R.S. Raghavan, F. Achandros
1978Ra15	PRVCA	18,	1085	G.R. Rao, G. Azuelos, J.C. Kim, J.P. Martin, P. Taras
1978Ra16	PRVCA	18,	1158	S. Raman, R.F. Carlton, G.G. Slaughter, M.R. Meder
1978Re01	ZPAAD	284,	403	T.S. Reddy, R. Matthews, K.V. Reddy
1978Ro01	PRVCA	17,	4	R.G. HRobertson, E. Kashy, W. Benenson, A. Ledebuhr
1978Ro03	ZPAAD	284,	407	A. Robertson, T.J. Kennett, W.V. Prestwich
1978Ro08	PRVCA	17,	1535	R.G.H. Robertson, T.L. Khoo, G.M. Crawley, A.B. McDonald, E.G. Adelberger, S.J. Freedman
1978Ro14	PRVCA	18,	86	G. Rotbard, L. Larana, M. Vergnes, G. Berrier, J. Kalifa, F. Guilbault, R. Tamisier
1978Ro19	PYLBB	78,	393	E. Roeckl, R. Kirchner, O. Klepper, G. Nyman, W. Reisdorf, D. Schardt, K. Wien, R. Fass, S. Mattsson
1978Sc26	ZPAAD	288,	189	U.J. Schrewe, W.D. Schmidt-Ott, R.-D. von Dincklage, E. Georg, P. Lemmert, H. Jungclas, D. Hirdes
1978Se04	PRVCA	17,	1919	R.R. Sercely, R.J. Peterson, E.R. Flynn
1978Se07	PRLTA	41,	1589	K. Seth, H. Nann, S. Iversen, M. Kaletka
1978Sh11	NUPAB	304,	40	S. Shastri, R.A. Emigh, R.J. Peterson, R.E. Anderson
1978St02	ZPAAD	284,	95	R. Stippler, F. Münnich, H. Schrader, J.P. Bocquet, M. Asghar, G. Siegert, R. Decker, B. Pfeiffer, H. Wollnik, E. Monnard, F. Schussler
1978St25	NUIMA	155,	253	H.L. Stelts, R.E. Chrien
1978Su03	ZPAAD	287,	287	K. Sümmerer, N. Kaffrell, H. Otto, P. Peuser, N. Trautmann
1978Sz04	PRVCA	17,	2253	A. Szanto De Toledo, H.V. Klapdor, H. Hafner, W. Saathoff, E.M. Szanto, M. Schrader
1978Sz09	JPHGB	4,	L187	A. Szanto De Toledo, H.V. Klapdor, H. Hafner, W. Saathoff, E.M. Szanto, M. Schrader, H. Dias
1978Ta10	PRVCA	18,	1064	R.W. Tarara, J.P. Zumbro, C.P. Browne
1978Tu04	PHSTB	18,	31	T. Tuurnala, R. Katajanheimo, O. Heinonen
1978Va04	NUPAB	295,	211	J. Van Pelt, C.P. Gerner, O.W. De Ridder, J. Blok
1978Ve10	JPSLB	39,	291	L. Vergnes, G. Rotbard, J. Kalifa, G. Berrier, J. Vernotte, Y. Deschamps, R. Selz
1978We12	PHSTB	18,	275	T. Weckstrom

1978We14	NUPAB	308,	222	D.C. Weisser, A.F. Zeller, T.R. Ophel, D.F. Hebbard
1978Wi04	PRVCA	18,	401	D.H. Wilkinson, A. Gallmann, D.E. Alburger
1978Wo01	PRVCA	17,	66	C. Woods
1978Wo15	PRVCA	18,	2328	F.K. Wohn, W.L. Talbert, Jr.
1978Ya07	PRVCA	17,	2061	Y. Yamazaki, R.K. Sheline, E.B. Shera corr PRVCA 18,2450
1978Ze04	PRVCA	18,	2122	B. Zeidman, J.A. Nolen, Jr.
1978Zg.A	PrvCom	AHW	Sep	E.F. Zganjar, W.R. Kane, G.J. Smith, J.A. Cizewski
1979				
1979Ad08	IANFA	43,	1089	I.A. Adam, A.V. Budzyak, M. Gonusek, V.M. Gorodzhankin, B.S. Dzelepov, V.G. Kalinnikov, A.V. Kudryavtseva, V.V. Kuznetsov, V.I. Stegaylov, A. Shshalek
1979Ah03	PRVCA	20,	290	I. Ahmad, S.W. Yates, R.K. Sjoblom, A.M. Friedman
1979Aj02	PRVCA	19,	1742	F. Ajzenberg-Selove, E.R. Flynn, D.L. Hanson, S. Orbesen
1979Aj03	PRVCA	19,	2068	F. Ajzenberg-Selove, E.R. Flynn, D.L. Hansen, S. Orbesen
1979Al04	JPHGB	5,	423	A.M. Al Naser, A.H. Behbehani, P.A. Butler, L.L. Green, A.N. James, C.J. Lister, P.J. Nolan, N.R.F. Ramsmo, J.F. Sharpey-Schafer, H.M. Sheppard, L.H. Zyber, R. Zyber
1979Al05	ZPAAD	290,	173	K. Aleklett, E. Lund, G. Rudstam
1979Al07	NUPAB	321,	45	W.P. Alford, R.E. Anderson, P.A. Batay-Csorba, R.A. Emigh, D.A. Lind, P.A. Smith, C.D. Zafiratos
1979Al16	ZPAAD	291,	397	G.D. Alkhazov, L.K. Batist, E.Y. Berlovich, Y.S. Blinnikov, Y.V. Yelkin, K.A. Mezilev, Y.N. Novikov, V.N. Pantelejev, A.G. Poljakov, N.D. Schigolev, V.N. Tatasov, V.P. Afanasjev, K.Y. Gromov, M. Jachim, M. Janicki, V.G. Kalinnikov, J. Kormicki, A. Potempa, E. Rurarz, F. Tarkanyi, Y.V. Yushkievich
1979Al19	NUPAB	330,	77	W.P. Alford, R.E. Anderson, P.A. Batay-Csorba, R.A. Emigh, D.A. Lind, P.A. Smith, C.D. Zafiratos
1979An36	IANFA	43,	1076	N.M. Antoneva, V.M. Vinogradov, E.P. Grigorev, P.P. Dimitrev, A.V. Zolotavin, G.S. Katichin, N.N. Krasnov, V.M. Makarov
1979Ay01	PYLBB	82,	43	J. Åystö, D.M. Moltz, M.D. Cable, R.D. Von Dincklage, R.F. Parry, J.M. Wouters, J. Cerny
1979Ba06	ZPAAD	289,	325	J.N. Barkman, J.E. McFee, T.J. Kennett, W.V. Prestwich
1979Ba31	NUPAB	325,	305	G.C. Ball, W.G. Davies, J.S. Forster, H.R. Andrews, D. Horn, W. McLatchie
1979Ba67	AENGA	47,	404	S.A. Baranov, V.M. Shatinskii, L.V. Chistyakov
1979Be.A	P-Brookhaven		561	Z. Berant, Y. Birenbaum, R. Moreh, see NUIMA 166(1979)81, and PrvCom AHW February 1980
1979Bo37	ZENAA	34,	1536	T. Borello-Lewin, O. Dietsch
1979Br05	ZPAAD	289,	289	P. Brodeur, B.P. Pathek, S.K. Mark
1979Br19	PRVCA	20,	1301	R.E. Brown, J.A. Cizewski, E.R. Flynn, J.W. Sunier
1979Br25	NUIMA	166,	243	F. Braumandl, K. Schreckenbach, T. von Egidy
1979Br26	ZPAAD	292,	397	F. Braumandl, T. von Egidy, D.D. Warner
1979Br.A	Th.-McMaster			P.M. Brewste
1979Br.B	AnRpt NotrDame			C.P. Browne, et al
1979Bu05	NUPAB	318,	77	D.G. Burke, G. Løvhøiden, E.R. Flynn, J.W. Sunier
1979Ca02	NUPAB	316,	61	R.F. Casten, M.R. MacPhail, W.R. Kane, D. Breitig, K. Schreckenbach, J.A. Cizewski
1979Da04	PRVCA	19,	1463	C.N. Davids, C.A. Gagliardi, M.J. Murphy, E.B. Norman
1979Da.A	P-Lansing		419	C.N. Davids
1979De44	NUPAB	332,	382	K.R.S. Devan, C.E. Brient
1979Do09	PRVCA	20,	1112	R.E. Doebler, W.M. McHarris, W.H. Kelly
1979Du02	NUPAB	315,	317	F. Dubbers, L. Funke, P. Kemnitz, K.D. Schilling, H. Strusny, E. Will, G. Winter, M.K. Balodis
1979E111	ZPAAD	293,	261	K. Elix, H.W. Becker, L. Buchmann, J. Görres, K.U. Kettner, M. Wiescher, C. Rolfs
1979Fi07	PYLBB	89,	36	R.B. Firestone, R.C. Pardo, W.C. McHarris
1979FI02	PRVCA	19,	355	E.R. Flynn, D.L. Hansen, R.A. Hardekopf
1979Fo09	NUPAB	321,	137	S. Fortier, S. Galès
1979Fo10	NUPAB	323,	205	B. Fogelberg, P. Carlé

1979Ge02	PRVCA	19,	1938	D.F. Geesaman, R.L. McGrath, J.W. Noé, R.E. Malmin
1979Ha09	ZPAAD	290,	113	H.H. Hansen, E. Cellen, G. Grosse, D. Mouchel, A. Larsen, R. Vaninbrouckx
1979Ha10	NUPAB	318,	29	E. Hagberg, P.G. Hansen, P. Hornshøj, B. Jonson, S. Mattsson, P. Tidemand-Petersson, ISOLDE
1979Ha26	PRVCA	19,	2332	P.E. Hausteine, H.-C. Hseuh, R.L. Klobuchar, E.M. Franz, S. Katcoff, L.K. Peker
1979Ha32	PRVCA	20,	345	J.E. Halvarson, W.H. Johnson, Jr.
1979Ho10	ZPAAD	291,	53	S. Hofmann, W. Faust, G. Münzenberg, W. Reisdorf, P. Armbruster, K. Güttner, H. Ewald
1979Ho27	NUPAB	330,	429	J. Honkanen, M. Kortelahti, K. Valli, K. Eskola, A. Hautojärvi, K. Vierinen
1979Ik04	NUPAB	329,	84	H. Ikegami, T. Yamazaki, S. Morinobu, I. Katayama, M. Fujiwara, Y. Fujita, H. Taketani, M. Adachi, T. Matsuzaki, N. Koori, M. Matoba
1979Ik06	JUPSA	47,	1039	Y. Ikeda, H. Yamamoto, K. Kawade, T. Takeuchi, T. Katoh, T. Nagahara
1979Ik07	JUPSA	47,	1389	Y. Ikeda, H. Yamamoto, K. Kawade, T. Katoh, T. Nagahara
1979Io01	NUPAB	313,	283	V.A. Ionescu, J. Kern, R.F. Casten, W.R. Kane, I. Ahmad, J. Erskine, A.M. Friedman, K. Katori
1979Ja21	NUPAB	325,	337	J. Jänecke, F.D. Becchetti, C.E. Thorn
1979Ka.A	P-Lansing		39	E. Kashy, W. Benenson, J.A. Nolen, Jr., R.G.H. Robertson
1979Ka.B	PrvCom	NDG	Sep	N. Kaffrell
1979Ke02	ZPAAD	289,	407	U. Keyser, H. Berg, F. Münnich, K. Hawerkamp, H. Schrader, B. Pfeiffer, E. Monnard
1979Ke.D	P-Brookhaven		646	M.J. Kenny, M.L. Stelts, R.E. Chrien
1979Ko10	CJPHA	57,	266	K.S. Koziar, K.S. Sharma, R.C. Barber, J.W. Barnard, R.J. Ellis, V.P. Derenchuk
1979Ko.B	P-Lansing		45	R.T. Kouzes, R. Sherr
1979Lu01	NUPAB	313,	191	J. Lukasiak, R. Kaczarowski, J. Jastrzebski, S. André, J. Treherne
1979Me13	NUPAB	324,	335	T.C. Meyer
1979Mo02	PRLTA	42,	43	D.M. Moltz, J. Äystö, M.D. Cable, R.D. von Dincklage, R.F. Parry, J.M. Wouters, J. Cerny
1979Pa14	NUPAB	331,	16	V. Paar
1979Pe17	NUPAB	332,	95	P. Peuser, H. Otto, N. Kaffrell, G. Nyman, E. Roeckl
1979Pi08	NUPAB	321,	25	J.A. Pinston, W. Mampe, R. Rousille, K. Schreckenbach, D. Heck, H.G. Börner, H.R. Koch, S. Andre, D. Barnéoud
1979PI06	NUPAB	332,	29	A. Plochocki, G.M. Gowdy, R. Kirchner, O. Klepper, W. Reisdorf, E. Roeckl, P. Tidemand-Petersson, J. Żylicz, U.J. Schrewe, R. Kantus, R.-D. von Dincklage, W.D. Schmidt-Ott
1979Pr15	ZENAA	34,	387	H.-J. Probst, C. Alderliesten, P. Jahn
1979Ry.A	P-Lansing		249	A. Rytz
1979Sa.A	AnRpt KVI			A. Saha, R.H. Siemsen, J.W. Smits, J. Van Popta, and PrvCom AHW
1979Sc09	NUPAB	318,	253	K.-H. Schmidt, W. Faust, G. Münzenberg, H.-G. Clerc, W. Lang, K. Pielenz, D. Vermeulen, H. Wohlfarth, H. Ewald, K. Güttner
1979Sc11	ZPAAD	290,	359	F. Schussler, J. Blachot, E. Monnard, B. Fogelberg, S.H. Feenstra, J. van Klinken, G. Jung, K.D. Wünsch
1979Sc22	NUPAB	326,	65	D. Schardt, R. Kirchner, O. Klepper, W. Reisdorf, E. Roeckl, P. Tidemand-Petersson, G.T. Ewan, E. Hagberg, B. Jonson, S. Mattsson, G. Nyman
1979Sc.A	NDSBA	26,	81	M.R. Schmorak
1979Sw01	NUIMA	159,	407	Z.E. Switkowski, R.J. Petty, J.C.P. Heggie, G.J. Clark
1979Ta22	JUPSA	47,	1735	Y. Tagishi, K. Katori, Y. Toba, M. Sasagase, M. Sato, T. Mikumo
1979Ta.B	BAPSA	24,	836	R.W. Tarara, J.D. Zumbro, C.P. Browne
1979To06	PRVCA	19,	2399	K.S. Toth, M.A. Ijaz, C.R. Bingham, L.L. Riedinger, H.K. Carter, D.C. Sousa
1979To18	PRVCA	20,	1902	K.S. Toth, Y.A. Ellis, D.C. Sousa, H.K. Carter, D. Sen, E.F. Zganjar
1979Ve.A	P-Lansing		431	J. Verplancke, D. Vandeplasseche, M. Huyse, K. Cornelis, G. Lhersonneau
1979Vi01	PRVCA	19,	177	D.J. Vieira, R.A. Gough, J. Cerny
1979Vo05	PRVCA	20,	944	T. von Egidy, J.A. Cizewski, C.M. McCullagh, S.S. Malik, M.L. Stelts, R.E. Chrien, D. Breitig, R.F. Casten, W.R. Kane, G.J. Smith
1979Wa04	NUPAB	316,	13	D.D. Warner, W.F. Davidson, H.G. Börner, R.F. Casten, A.I. Namenson
1979Wa22	JPHGB	5,	1723	D.D. Warner, W.F. Davidson, W. Gelletly
1979We02	NUPAB	313,	385	D. Weber, G.M. Crawley, W. Benenson, E. Kashy, H. Nann
1979We07	PRVCA	20,	115	H. Weigmann, S. Raman, J.A. Harvey, R.L. Macklin, G.G. Slaughter

1980Ad04	ZPAAD	295,	251	M. Adachi, A. Muroi, T. Matsuzaki, H. Taketani
1980A102	PRVCA	21,	705	D.E. Alburger, P. Richards, T.H. Ku
1980A114	ZPAAD	295,	305	G.D. Alkhazov, E.Y. Berlovich, K.A. Mezilev, Y.N. Novikov, V.N. Pantelejev, A.G. Poljakov, K.Y. Gromov, V.G. Kalinnikov, J. Kormicki, A. Potempa, E. Rurarz, F. Tarkanyi
1980A115	ZPAAD	295,	331	K. Aleklett, P. Hoff, E. Lund, G. Rudstam
1980An.A	P-Berkeley		134	M.S. Antony, A. Huck, G. Klotz, A. Knipper, C. Miehé, G. Walter
1980Ba.A	Th.-Utrecht			J.R. Balder
1980Bl.A	Th.-Giessen			A. Blönnigen Diplomarbeit
1980Br23	NUPAB	349,	61	R.A. Braga, W.R. Western, J.L. Wood, R.W. Fink, R. Stone, C.R. Bingham, L.L. Riedinger
1980Bu04	IANFA	44,	79	A.V. Budzyak, T. Kretsu, V.V. Kuznetsov, N.A. Lebedev, G.I. Lizurei, Y.V. Yushkovich, M. Yanitski
1980Bu15	PRVCA	22,	1180	G.R. Burleson, G.S. Blanpied, G.H. Daw, A.J. Viescas, C.L. Morris, H.A. Thiessen, S.J. Greene, W.J. Braithwaite, W.B. Cottingham, D.B. Holtkamp, I.B. Moore, C.F. Moore
1980Ca02	PRVCA	21,	65	R.F. Casten, G.J. Smith, M.R. MacPhail, D. Breitig, W.R. Kane, M.L. Stelts, S.F. Mughabghab, J.A. Cizewski, H.G. Börner, W.F. Davidson, K. Schreckenbach
1980De02	ZPAAD	294,	35	R. Decker, K.D. Wunsch, H. Wollnik, E. Koglin, G. Siegert, G. Jung
1980De35	PRVCA	22,	2163	E. De Geer, G.B. Holm
1980Di07	PRVCA	21,	2101	A.C. Di Rienzo, H.A. Enge, D.B. Gazes, M.K. Salomaa, A. Sperduto, W. Schier, H.E. Wegner
1980Du02	ZPAAD	294,	107	J.P. Dufour, A. Fleury, F. Hubert, Y. Llabador, M.B. Mahourat, R. Bimbert, D. Gardes
1980Ew03	ZPAAD	296,	223	G.T. Ewan, E. Hagberg, B. Jonson, S. Mattsson, P. Tidemand-Petersson
1980Ga07	YAFIA	31,	306	Yu. P. Gangrskii, M.B. Miller, L.V. Mikhailov, I.F. Kharisov
1980Gi04	PRVCA	21,	2041	J. Gilat, S. Katcoff, L.K. Peker
1980Go11	NUPAB	344,	1	H. Gokturk, N.K. Aras, P. Fettweis, P. Del Marmol, J. Vanhorenbeek, K. Cornelis
1980Gr02	PRVCA	21,	498	R.C. Greenwood, R.E. Chrien
1980Gr12	NUIMA	175,	515	R.C. Greenwood, R.E. Chrien
1980Gr.A	DABBB	40,	3235	S.A. Gronemeyer in Diss. Abst. Int. 40B, 3235 (1980)
1980Ha20	PRVCA	22,	247	H.I. Hayakawa, I. Hyman, J.K.P. Lee
1980Ha36	PHSTB	22,	439	R. Hanninen, G.U. Din
1980Ho17	IJARA	31,	153	H. Houtermans, O. Milosevic, F. Reichel
1980Ho29	CZYPA	30,	763	J. Hinzatko, K. Konesny, F. Becvar, E.A. Eissa
1980Is02	CJPHA	58,	168	M.A. Islam, T.J. Kennett, S.A. Kerr, W.V. Prestwich
1980Ja.A	AnRpt KVI		31	J. Jänecke, E.H.L. Aarts, A.G. Drentje, C. Gaarde, M.H. Harakeh
1980Ka19	PRVCA	22,	997	J. Kalifa, G. Berrier-Ronsin, M. Vergnes, G. Rotbard, J. Vernotte, Y. Deschamps, R. Seltz
1980Ko01	NUPAB	334,	35	J. Kopecky, R.E. Chrien, H. Liou
1980Ko25	CJPHA	58,	1311	K.S. Kozier, K.S. Sharma, R.C. Barber, J.W. Barnard, R.J. Ellis, V.P. Derenchuk, H.E. Duckworth
1980Kr07	ZPAAD	295,	199	K.L. Kratz, H. Ohm
1980Kr.A	P-Berkeley		135	L. Krauss, I. Linck, A. Poves, J.C. Sens
1980Le18	PRVCA	22,	1976	A.G. Ledebuhr, L.H. Harwood, R.G.H. Robertson, T.J. Bowles
1980Li07	NUPAB	337,	401	H.I. Liou, R.E. Chrien, J. Kopecky, J.A. Konter
1980Lo10	PHSTB	22,	203	G. Løvholden, D.G. Burke, E.R. Flynn, J.W. Sunier
1980Lu04	ZPAAD	294,	233	E. Lund, P. Hoff, K. Aleklett, O. Glomset, G. Rudstam
1980Ma40	PRVCA	22,	2449	W. Mayer, K.E. Rehm, H.J. Körner, W. Mayer, E. Müller, I. Oelrich, H.J. Scheerer, R.E. Segel, P. Sperr, W. Wagner
1980Mu10	NUPAB	344,	89	M. Muller-Veggian, H. Beuscher, D.R. Haenni, R.M. Lieder, A. Neskakis, C. Mayer-Boricke
1980Mu12	PRVCA	22,	2204	M.J. Murphy, C.N. Davids, E.B. Norman
1980Na12	PYLB	96,	261	H. Nann, K.K. Seth, S.G. Iversen, M.O. Kaletka, D.B. Barlow, D. Smith
1980Na14	JPSLB	41,	79	F. Naulin, C. Détraz, M. Bernas, D. Guillemaud, E. Kashy, M. Langevin, F. Pougheon, P. Roussel, M. Roy-Stephan
1980Ox01	ZPAAD	294,	389	K. Oxorn, B. Singh, S.K. Mark

1980Pa02	PRVCA	21,	462	R.C. Pardo, L.W. Robinson, W. Benenson, E. Kashy, R.M. Ronnigen
1980Pa07	PYLBB	91,	41	R.C. Pardo, S. Gales, R.M. Ronningen, L.H. Harwood
1980Ro04	ZPAAD	294,	221	E. Roeckl, G.M. Gowdy, R. Kirchner, O. Klepper, A. Piotrowski, A. Plochocki, W. Reisdorf, P. Tidemand-Petersson, J. Żylicz, D. Schardt, G. Nyman, W. Lindenzweig
1980Sa11	JPHGB	6,	525	J. Sala-Lizzaraga, J. Byrne
1980Sc09	PYLBB	91,	46	U.J. Schrewe, P. Tidemand-Petersson, G.M. Gowdy, R. Kirchner, O. Klepper, A. Plochocki, W. Reisdorf, E. Roeckl, J.L. Wood, J. Żylicz, R. Fass, D. Schardt
1980Sh06	PYLBB	91,	211	K.S. Sharma, R.J. Ellis, V.P. Derenchuk, R.C. Barber, H.E. Duckworth
1980Sh14	CJPHA	58,	837	M.A.M. Shababuddin, D.G. Burke
1980St10	ZPAAD	295,	259	O. Straume, G. Løvhøiden, D.G. Burke
1980Ta07	PRVCA	21,	1667	E.M. Takagui, O. Dietzsch
1980Tr04	PRVCA	22,	17	R.E. Tribble, D.M. Tanner, A.F. Zeller
1980Ve01	ZPAAD	294,	144	D. Vermeulen, H.-G. Clerc, W. Lang, K.H. Schmidt, G. Münzenberg
1980Ve05	NUPAB	344,	421	R. Vennink, J. Kopecky, P.M. Endt, P.W.W. Glaudemans
1980Vi.A	PrvCom	AHW		V.D. Vitman, F.V. Moroz, Yu. Ya. Sergeev, V.K. Tarasov
1980Vy01	IANFA	44,	67	Ts. Vylov, S. Omanov, V. Csaleksandrov, N.B. Badalov, A. Budzyak, V.V. Kuznetsov, A.I. Muminov, Han Ken Mo
1980Wa24	PRVCA	22,	2330	E.K. Warburton, D.E. Alburger, D.J. Millener
1980Ya07	JINCA	42,	1539	H. Yamamoto, Y. Ikeda, K. Kawade, T. Katoh, T. Nagahara
1980Ya.A	AnRpt Berkeley			S. Yashita, M. Leino, A. Ghiorso
			1981	
1981Ad02	NUPAB	356,	129	I. Adam, M. Honusek, Z. Hons, V.V. Kuznetsov, T.M. Muminov, R.R. Usmanov, A. Budzyak
1981Aj02	PRVCA	24,	1762	F. Ajzenberg-Selove, R.E. Brown, E.R. Flynn, J.W. Sunier
1981Al03	PRVCA	23,	473	D.E. Alburger, D.J. Millener, D.H. Wilkinson
1981Al07	PRVCA	23,	2217	D.E. Alburger, C.J. Lister, J.W. Olness, D.J. Millener
1981Al20	ZPAAD	302,	241	K. Aleklett, P. Hoff, E. Lund, G. Rudstam
1981Ar13	PYLBB	104,	186	Y. Arai, M. Fujioka, E. Tanaka, J. Shinozuka, H. Miyatake, M. Yoshii, T. Ishimatsu, see also NUPAB 420(84)193
1981Ar.A	JINR-P6-81-524			K.P. Artamonova, A. Budzyak, E.P. Grigorev, A. Dzumamuratov, A.V. Zolotavin, A.I. Ivanov, V.G. Kalinnikov, V.V. Kuznetsov, V.O. Sergeev, R. Usmanov
1981Ay01	PRVCA	23,	879	J. Äystö, M.D. Cable, R.F. Parry, J.M. Wouters, D.M. Moltz, J. Cerny
1981Ba40	ZPAAD	302,	329	G.K. Bavaria, J.E. Crawford, S. Calamawy, J.E. Kitching
1981Ba53	IANFA	45,	727	I.F. Barchuck, V.I. Goyskhin, E.N. Gorban, A.F. Ogorodnik
1981Be03	PRVCA	23,	555	C.E. Bemis, Jr., P.F. Dittner, R.L. Ferguson, D.C. Hensley, F. Plasil, F. Pleasonton
1981Be40	PRVCA	24,	756	M. Bernas, J.C. Peng, H. Doubre, M. Langevin, M.J. Le Vine, F. Pougheon, P. Roussel
1981Bo30	ZPAAD	302,	121	J. Bonn, P. Hartmann, D. Weskott
1981Bo.B	AnRpt Julich		76	M. Bogdanovic, T.D. MacMahon, H. Seyfarth
1981Bu.A	P-Samarkand		621	M. Budzinski, K. Ya. Gromov, V.V. Kuznetsov, T.M. Muminov, P.R. Usmanov, T. Chazratov
1981Ci01	PRVCA	23,	1453	J.A. Cizewski, E.R. Flynn, R.E. Brown, D.L. Hanson, S.D. Orbesen, J.W. Sunier
1981Co17	PRVCA	24,	911	T. Cousins, T.J. Kennett, W.V. Prestwich
1981Da06	PRVCA	23,	1612	E. Dafni, H.E. Mahnke, J.W. Noe, M.H. Rafailovich, G.D. Sprouse
1981De22	ZPAAD	300,	251	S. Della Negra, C. Deprun, D. Jacquet, Y. Le Beyec
1981De25	ZPAAD	301,	165	R. Decker, K.D. Wunsch, H. Wollnik, G. Jung, J. Münzel, G. Siegert, E. Koglin
1981De38	ZPAAD	303,	151	J. Deslauriers, S.C. Gujrathi, S.K. Mark
1981Dr07	ZPAAD	302,	361	S. Drissi, S. André, J. Genevey, V. Barci, A. Gizon, J. Gizon, J.A. Pinston, J. Jas-trzebski, R. Kossakowski, Z. Preibisz
1981Eb01	ZPAAD	299,	209	I.D.U. Ebong, R.R. Roy
1981El03	PRVCA	23,	480	Y.A. Ellis-Akovali, K.S. Toth, C.R. Bingham, H.K. Carter, D.C. Sousa
1981En07	NUPAB	372,	125	G. Engler, R.E. Chrien, H.I. Liou
1981Fe05	NUPAB	369,	425	M. Fernandez, G. Murillo, J. Ramirez, O. Avila, S.E. Darden, M.C. Rozak, J.L. Foster, B.P. Hichwa, P.L. Jolivet

1981Fi02	NUPAB	363,	311	C.A. Fields, F.W.N. De Boer, J.J. Kraushaar, R.A. Ristinen, L.E. Samuelson, E. Sugarbaker
1981FI02	PRVCA	24,	902	E.R. Flynn, F. Ajzenberg-Selove, R.E. Brown, J.A. Cizewski, J.W. Sunier, and erratum PRVCA 25(1982)2851
1981FI05	PYLBB	105,	125	E.R. Flynn, R.E. Brown, J.W. Sunier, J.M. Gurski, J.A. Cizewski, D.G. Burke
1981Fl.A	P-Helsingor		107	E.R. Flynn, R.E. Brown, J.W. Sunier, D.G. Burke, F. Ajzenberg-Selove, J.A. Cizewski
1981Ga36	IANFA	45,	1861	N. Ganbaatar, J. Kormicki, K.A. Mezilev, Y.N. Novikov, Y.P. Prokofiev, A. Potempa, F. Tarkani
1981Gi01	PYLBB	98,	29	F. Girshik, K. Krien, R.A. Naumann, G.L. Struble, R.G. Lanier, L.G. Mann, J.A. Cizewski, E.R. Flynn, T. Nail, R.K. Sheline
1981Ha08	NUPAB	357,	356	J.C. Hardy, G.C. Ball, W.G. Davies, J.S. Forster, H. Schmeing, E.T.H. Clifford
1981Ha44	NUPAB	371,	349	J.C. Hardy, T. Faestermann, H. Schmeing, J.A. Macdonald, H.R. Andrews, J.S. Geiger, R.L. Graham, K.P. Jackson
1981Hi01	NUPAB	352,	93	F. Hintenberger, P. von Rossen, S. Cierjacks, G. Schmalz, D. Erbe, B. Leugers
1981Ho10	ZPAAD	299,	281	S. Hofmann, G. Münzenberg, F. Heßberger, W. Reisdorf, P. Armbruster, B. Thuma
1981Ho17	ZPAAD	300,	289	P. Hoff, K. Aleklett, E. Lund, G. Rudstam
1981Ho18	NUIMA	186,	257	P. Hornshøj, H.L. Nielsen, N. Rud, H.L. Ravn
1981Ho.A	P-Helsingor		190	S. Hofmann, G. Münzenberg, W. Faust, F. Heßberger, W. Reisdorf, J.R.H. Schneider, P. Armbruster, K. Güttner, B. Thuma
1981Ho.B	PrvCom	AHW	Oct	C. Hofmeyr, D. Warner, H.G. Börner, G. Barreau, R.F. Casten, M. Stelts, J.S. Dionisio
1981Hs02	PRVCA	23,	1217	H.-C. Hseuh, E.-M. Franz, P.E. Haustein, S. Katcoff, L.K. Peker
1981Hu03	NUPAB	352,	247	M. Huyse, K. Cornelis, G. Lhersonneau, J. Verplancke, W.B. Wolters, K. Heyde, P. Van Isacker, M. Warnquier, G. Wenes, H. Vincx
1981Jo.B	P-Helsingor		640	B. Jonson, O.B. Nielsen, L. Westgaard, J. Żylicz
1981Ka07	PRVCA	23,	1274	R. Kantus, U.J. Schrewe, W.D. Schmidt-Ott, R. Michaelsen
1981Ke02	CJPHA	59,	93	T.J. Kennett, M.A. Islam, W.V. Prestwich
1981Ke03	ZPAAD	299,	323	T.J. Kennett, W.V. Prestwich, M.A. Islam
1981Ke11	CJPHA	59,	1212	T.J. Kennett, W.V. Prestwich, M.A. Islam
1981Ko13	PRVCA	23,	2743	R.T. Kouzes, K. Krien
1981Ko.A	PrvCom	NDG	Oct	B.K. Koene, R.E. Chrien, M.L. Stets, L.K. Peker
1981Le23	PRVCA	24,	2370	M.E. Leino, S. Yashita, A. Ghiorso
1981Li12	PRVCA	24,	260	C.J. Lister, P.E. Haustein, D.E. Alburger, J.W. Olness
1981Lo.A	P-Grenoble		383	M.A. Lone
1981Lu07	ZETFA	81,	1158	V.A. Lyubimov, E.G. Novikov, V.Z. Nozik, E.F. Tretyakov, V.S. Kozik, N.F. Myasoedov
1981Ma30	NUPAB	370,	1	S. Matsuki, N. Sakamoto, K. Ogino, Y. Kadota, T. Tanabe, Y. Okuma
1981Mi12	ZPAAD	301,	199	P. Misaelides, P. Tidemand-Petersson, U.J. Schrewe, I.S. Grant, R. Kirchner, O. Klepper, I.C. Malcolm, P.J. Nolan, E. Roeckl, W.-D. Schmidt-Ott, J.L. Wood
1981Mu06	ZPAAD	300,	107	G. Münzenberg, S. Hofmann, F.P. Heßberger, W. Reisdorf, K.H. Schmidt, J.R.H. Schneider, P. Armbruster, C.C. Sahn, B. Thuma
1981Mu12	ZPAAD	302,	7	G. Münzenberg, S. Hofmann, W. Faust, F.P. Heßberger, W. Reisdorf, K.-H. Schmidt, T. Kitahara, P. Armbruster, K. Güttner, B. Thuma, D. Vermeulen
1981Na.A	P-Helsingor		376	F. Naulin, C. Détraz, M. Roy-Stephan, M. Bernas, J. de Boer, D. Guillemaud, M. Langevin, F. Pougheon, P. Roussel
1981Ni08	RAACA	29,	113	K. Nishiizumi, R. Gensho, M. Honda
1981Ox01	ZPAAD	303,	63	K. Oxorn, S.K. Mark
1981Pa11	PYLBB	103,	297	A.D. Panagiotou, I. Paschopoulos, A. Huck, N. Schulz
1981Pa17	ZPAAD	302,	117	A.D. Panagiotou, P.K. Kananis, E.N. Gazis, M. Bernas, C. Détraz, M. Langevin, D. Guillemaud, E. Plagnol
1981Pr06	PRVCA	24,	1346	R.J. Prestwood, D.B. Curtis, J.H. Capps
1981Ra07	PRVCA	23,	1979	S. Raman, O. Shahal, A.Z. Hussein, G.C. Slaughter, J.A. Harvey
1981Ri04	PRVCA	23,	2342	B.G. Ritchie, K.S. Toth, H.K. Carter, R.L. Mlekodaj, E.H. Speje
1981Ro02	PRVCA	23,	973	R.G.H. Robertson, J.A. Nolen, Jr., T. Chapuran, R. Vodhanel
1981Sa09	PRVCA	23,	1713	T. Saito, T. Toriyama, M. Kanbe, K. Hisatake
1981Sc17	NUPAB	368,	153	D. Schardt, T. Batsch, R. Kirchner, O. Klepper, W. Kurcewicz, E. Roeckl, P. Tidemand-Petersson

1981Sc21	PRVCA	24,	2695	W.D. Schmidt-Ott, R. Kantus, E. Runte, U.J. Schrewe, R. Michaelsen
1981Se11	PYLBB	103,	409	U. Sennhauser, L. Felawka, T. Kozlowski, H.K. Walter, F.W. Schlepuetz, R. Engfer, E.A. Hermes, P. Heusi, H.P. Isaak, H.S. Pruys, A. Zgliniski, W.H.A. Heselung
1981Se.A	P-Helsingor		655	K.T. Seth
1981Sm02	PYLBB	102,	114	L.G. Smith, E. Koets, A.H. Wapstra
1981So06	PRVCA	24,	1615	K. Sofia, B.N. Subba Rao, J.E. Cramfort
1981Sp03	ZPAAD	299,	112	L. Spanier, S.Z. Gui, H. Hick, E. Nolte
1981St18	PRVCA	24,	1785	P. Stephans, E. Mordechai, H.T. Fortune
1981Su.A	Leninst-YF-644			L.A. Sushkov, V.L. Alekseev, L.D. Kabina, I.A. Kondurov, D.D. Uorner
1981Th04	PRVCA	23,	2720	C. Thibault, F. Touchard, S. Buttgenbach, R. Klapisch, M. de Saint Simon, H.T. Duong, P. Jacquinet, P. Juncar, S. Liberman, P. Pillet, J. Pinar, J.L. Vialle, A. Pesnelle, G. Huber
1981To02	NUPAB	356,	26	K.S. Toth, Y.A. Ellis-Akovali, D.M. Moltz, C.R. Bingham, H.K. Carter, D.C. Sousa
1981Va11	IJARA	32,	589	R. Vaninbroukx, G. Grosse, W. Zehner
1981Va27	IANFA	45,	1861	V.M. Vakhtel, N.A. Golovkov, R.B. Ivanov, M.I. Mikhailova, A.F. Novgorodov, Y.V. Norseev, V.G. Chumin, Y.V. Yushkevich
1981Va.B	P-Grenoble		548	C. Van der Leun, P. De Wit, C. Alderliesten, and PrvCom AHW
1981Vo03	NUPAB	365,	26	T. von Egidy, G. Barreau, H.G. Börner, W.F. Davidson, J. Larysz, D.D. Warner, P.H.M. Van Assche, K. Nybo, T.F. Thorsteinsen, G. Lovhoiden, E.R. Flynn, J.A. Cizewski, R.K. Sheline, D. Decman, D.G. Burke, G. Sletten, N. Kaffrell, W. Kurcewicz, T. Bjornstad, G. Nyman
1981Wa11	NUPAB	362,	1	C. Wagemans, E. Allaert, A. De Clerq, P. D'Hondt, A. De Ruytter, G. Barreau, A. Emsallem
1981Wa31	NUIMA	190,	167	C. Wagemans, E. Allaert, G. Barreau, A. Emsallem, P. D'Hondt
1981We12	NUPAB	368,	117	H. Weigmann, C. Wagemans, A. Emsallem, M. Ashgar
1981Wh03	PYLBB	105,	116	R.E. White, H. Naylor, P.H. Barker, D.M.J. Lovelock, R.M. Smythe
1981Ya06	JINCA	43,	855	H. Yamamoto, Y. Ikeda, K. Kawade, T. Katoh, T. Nagahara
			1982	
1982Ah01	NUPAB	373,	434	I. Ahmad, E.P. Horwitz
1982Al19	NUIMA	197,	383	P.F. AALKemade, C. Alderliesten, P. De Wit, C. Van der Leun
1982Al29	PRVCA	26,	1157	K. Aleklett, P. Hoff, E. Lund, G. Rudstam
1982Al.A	LNPI-820			G.D. Alkhozov, N. Ganbaatar, K.Y. Gromov, V.G. Kalinnikov, K.A. Mezilev, Y.N. Novikov, A.M. Nurmukhamedov, A. Potempa, F. Tarkanyi
1982Al.C	PrvCom	NDG	Dec	D.E. Alburger, J.W. Olness, T.W. Burrows
1982An12	JPHGB	8,	1659	M.S. Antony
1982An19	PYLBB	113,	72	J.U. Andersen, G.J. Beyer, G. Charpak, A. De Rújula, B. Elbek, H.A. Gustavson, P.G. Hansen, B. Jonson, P. Knudsen, E. Laegsgaard, J. Pedersen, H.L. Ravn
1982Au01	NUPAB	378,	443	G. Audi, M. Epherre, C. Thibault, A.H. Wapstra, K. Bos
1982Ba15	IANFA	46,	63	I.F. Barchuk, V.I. Golyshkin, E.N. Gorban
1982Ba28	NUPAB	380,	189	A. Backlin, G. Hedin, B. Fogelberg, M. Saraceno, R.C. Greenwood, C.W. Reich, H.R. Koch, H.A. Baader, H.D. Breitig, O.W.B. Schult, K. Schreckenbach, T. von Egidy, W. Mampe
1982Ba69	IANFA	46,	2077	I.F. Barchuk, V.I. Golyshkin, E.N. Gorbinj
1982Be20	NCLTA	33,	273	E. Bellotti, E. Fiorini, C. Liguori, A. Pullia, A. Sarracino, L. Zanotti
1982Be21	PRVCA	25,	2848	G. Berrier-Ronsin, M. Vergnes, G. Rotbard, J. Vernotte, S. Fortier, J.M. Maison, R. Tamisier
1982Be38	PRVCA	26,	914	J.A. Becker, J.B. Carlson, R.G. Lanier, L.G. Mann, G.L. Struble, K.H. Maier, L. Ussery, W. Stoffl, T. Nail, R.K. Sheline, J.A. Cizewski
1982Be.A	P-Kiev		127	R.B. Begdzanov, K. Sh. Azimov
1982Bo04	PRVCA	25,	941	J.D. Bowman, R.E. Eppley, E.K. Hyde
1982Br10	RAACA	30,	1	W. Brüche, G. Herrmann
1982Br23	PRVCA	26,	2166	D.S. Brenner, M.K. Martel, A. Aprahamian, R.E. Chrien, R.L. Gill, H.I. Liou, M. Shmid, M.L. Stelts, A. Wolf, F.K. Wohn, D.M. Rehfield, H. Dejbakhsh, C. Chung

1982Ca04	PYLBB	109,	419	L.C. Carraz, P.G. Hansen, A. Huck, B. Jonson, G. Klotz, A. Knipper, K.L. Kratz, C. Mi��ch��, S. Mattsson, G. Nyman, H. Ohm, A.M. Poskanzer, A. Poves, H.L. Ravn, C. Richard-Serre, A. Schr��der, G. Walter, W. Ziegert
1982Ca16	PRVCA	26,	1778	M.D. Cable, J. Honkanen, R.F. Parry, H.M. Thierens, J.M. Wouters, Z.Y. Zhou, J. Cerny
1982Cr01	PYLBB	109,	8	G.M. Crawley, W. Benenson, G. Bertsch, S. Gales, D. Weber, B. Zwieglinsky
1982De03	PRVCA	25,	146	P. De Gelder, D. De Frenne, E. Jacobs, K. Heyde, S. Fortier, J.M. Maison, M.N. Rao, C.P. Massolo
1982De06	PRVCA	25,	504	J. Deslauriers, S.C. Gujrathi, S.K. Mark
1982De11	ANPHA	7,	149	S. Della Negra, C. Deprun, D. Jacquet, Y. Le Beyec
1982De36	ZPAAD	307,	305	S. Della Negra, H. Gauvin, D. Jacquet, Y. Le Beyec
1982De43	ZPAAD	308,	243	S. Della Negra, D. Jacquet, Y. Le Beyec
1982De.A	Th.-Orsay			Ph. Dessagne
1982Di01	PYLBB	108,	265	W.R. Dixon, W.F. Davidson, R.S. Storey, D.M. Rehfield
1982Di05	NUPAB	378,	273	W.R. Dixon, R.S. Storey, A.F. Bielajew
1982En03	PRVCA	25,	1830	H.A. Enge, M. Salomaa, A. Sperduto, J. Ball, W. Schier, A. Graue, A. Graue
1982Ew01	NUPAB	380,	423	G.T. Ewan, E. Hagberg, B. Jonson, S. Mattsson, P. Tidemand-Petersson
1982Fi10	NUPAB	385,	505	L.K. Fifield, J.L. Durell, M.A.C. Hotchkis, J.R. Leigh, T.R. Ophel, D.C. Weisser
1982Fi09	PRVCA	25,	2851	E.R. Flynn, F. Ajzenberg-Selove, R.E. Brown, J.A. Cizewski, J.W. Sunier
1982Ga05	PRLTA	48,	914	C.A. Gagliardi, G.T. Garvey, J.R. Wrobel, S.J. Freedman
1982Ga24	ZPAAD	308,	359	H. Gabelmann, J. Munzel, B. Pfeiffer, G.I. Crawford, H. Wollnik, K.-L. Kratz
1982Gi.A	Th.-Mainz			H. Gietz
1982Gr.A	P-Amsterdam			K.Y. Gromov, et al
1982Hi14	ZPAAD	309,	27	R. Hingmann, H.-G. Clerc, C.C. Sahm, D. Vermeulen, K.H. Schmidt, J.G. Keller
1982Ho04	ZPAAD	305,	111	S. Hofmann, W. Reisdorf, G. M��nzenberg, F.P. He��berger, J.R.H. Schneider, P. Armbruster
1982Ho07	PRVCA	25,	2232	R.W. Hoff, W.F. Davidson, D.D. Warner, H.G. B��rner, T. von Egidy
1982Ho11	PYLBB	116,	4	P. Hornshoj, J. Kolind, N. Rud
1982Hu02	NUIMA	192,	609	P. Hungerford, H.H. Schmidt
1982Is05	PRVCA	25,	3184	M.A. Islam, T.J. Kennett, W.V. Prestwich
1982Jo03	JPHGB	8,	1405	M.G. Johnson, I.S. Grant, P. Miscalides, P.J. Nolan, P. Peuser, R. Kirchner, O. Klepper, E. Roeckl, P. Tidemand-Petersson
1982Ka25	ZPAAD	308,	33	K. Kawade, K. Sistemich, G. Battistuzzi, H. Lawin, K. Shizuma, J. Blomqvist
1982Ka.A	PrvCom	AHW	Jul	W. Kane, et al
1982KI03	ZPAAD	305,	125	O. Klepper, T. Batsch, S. Hofmann, R. Kirchner, W. Kurcewicz, W. Reisdorf, E. Roeckl, D. Schardt, G. Nymann
1982Ko06	PRVCA	25,	1076	R.T. Kouzes, M.M. Lowry, C.L. Bennett, and PrvCom AHW May 1988
1982Kr05	ZPAAD	304,	307	H. Kr��winkel, H.W. Becker, L. Buchmann, J. G��rres, K.U. Kettner, W.E. Kieser, R. Santo, P. Schmalbrock, H.P. Trautvetter, A. Vlieks, C. Rolfs, J.W. Hammer, R.E. Azuma, W.S. Rodney
1982Kr12	NUPAB	386,	245	B. Krusche, K.P. Lieb, H. Daniel, T. von Egidy, G. Barreau, H.G. B��rner, R. Brissot, C. Hofmeyr, R. Rascher
1982Ku15	ZPAAD	308,	21	W. Kurcewicz, E.F. Zganjar, R. Kirchner, O. Klepper, E. Roeckl, P. Komninos, E. Nolte, D. Schardt, P. Tidemand-Petersson
1982La22	NUIMA	196,	559	R.G. Lanier, L.G. Mann, G.L. Stuble
1982La25	IJARA	33,	711	F. Lagoutine, J. Legrand
1982Mo04	PRVCA	25,	1276	S. Mordechai, S. Lafrance, H.T. Fortune
1982Mo10	PYLBB	113,	16	D.M. Moltz, K.S. Toth, F.T. Avignone III, H. Noma, B.G. Ritchie, B.D. Kern
1982Mo12	PRVCA	25,	3218	C.L. Morris, H.T. Fortune, L.C. Bland, R. Gilman, S.J. Greene, W.B. Cottingame, D.B. Holtkamp, G.R. Bursleson, C.F. Moore
1982Mo23	PRVCA	26,	1914	D.M. Moltz, K.S. Toth, R.E. Tribble, R.E. Neese, J.P. Sullivan
1982Na04	PRVCA	25,	1074	F. Naulin, C. D��traz, M. Roy-St��phan, M. Bernas, J. de Boer, D. Guillemaud, M. Langevin, F. Pougheon, P. Roussel
1982No06	ZPAAD	305,	289	E. Nolte, H. Hick
1982No08	ZPAAD	306,	223	E. Nolte, S.Z. Gui, G. Colombo, G. Korschinek, K. Eskola
1982Oh04	JUPSA	51,	43	M. Ohshima, Z. Matumoto, T. Tamura
1982OI01	NUPAB	373,	13	J.W. Olness, E.K. Warburton, D.E. Alburger, C.J. Lister, D.J. Millener
1982Pa24	ZPAAD	308,	345	B. Pahlmann, U. Keyser, F. M��nnich, B. Pfeiffer

1982PI05	NUPAB	388,	93	A. Plochocki, J. Żylicz, R. Kirchner, O. Klepper, E. Roeckl, P. Tidemand-Petersson, I.S. Grant, P. Miscalides
1982Ra13	ZPAAD	305,	359	M.S. Rapaport, G. Engler, A. Gayer, I. Yoresh
1982Ra.A	PrvCom	AHW	Nov	A. Raemy, J.C. Dousse, J. Kern, W. Schwitz
1982Sc03	NUPAB	376,	144	K. Schreckenbach, A.I. Namenson, W.F. Davidson, T. von Egidy, H.G. Börner, J.A. Pinston, R.K. Smither, D.D. Warner, R.F. Casten, M.L. White, W. Stoff
1982Sc14	PRVCA	25,	2888	H.H. Schmidt, P. Hungerford, H. Daniel, T. von Egidy, S.A. Kerr, R. Brissot, G. Barreau, H.G. Börner, C. Hofmeyr, K.P. Lieb
1982Sc15	PRVCA	25,	3091	U.J. Schrewe, E. Hagberg, H. Schmeing, J.C. Hardy, V.T. Koslowsky, K.S. Sharma, E.T.H. Clifford
1982Sc25	ZPAAD	308,	183	H.J. Scheerer, D. Pereira, A. Chalupka, R. Gyufko
1982So.A	P-Kiev		51	L.M. Solin, V.A. Yakovlev, V.N. Kushmin, Yu. A. Nemilov
1982So.B	AnRpt Julich		54	F. Soramel-Stanco, R. Julin, B. Rubio, A. Ercan, P. Kleinheinz, J. Tain, G.P.A. Berg, W. Huerliman, I. Katayama, S.A. Martin, J. Messburger, J.G.M. Roemer, B. Styczen, H.J. Scheerer
1982Ta18	NUPAB	388,	498	M. Tan, R.A. Braga, R.W. Fink, P.V. Rao
1982Th01	PRVCA	25,	331	C.E. Thorn, W.F. Piel, Jr., M.J. LeVine, P.D. Bond, A. Gallmann
1982Ti02	NUPAB	376,	421	T.A.A. Tielens, J. Kopecky, F. Stecher-Rasmussen, W. Ratinsky, K. Abrahams, P.M. Endt
1982To14	PYLBB	117,	11	K.S. Toth, Y.A. Ellis-Akovali, D.M. Moltz, R.L. Mlekodaj
1982Va13	NUPAB	380,	261	C. Van der Leun, C. Alderliesten
1982Ve.A	P-Kiev		91	G.V. Veselov, N. Ganbataar, K.A. Mezilev
1982Vy02	IANFA	46,	16	Ts. Vylov, V.M. Gorodzhankin, K. Ya. Gromov, V.G. Kalinnikov, T. Kretsu, V.V. Kuznetsov
1982Vy03	IANFA	46,	834	Ts. Vylov, V.M. Gorodzhankin, K. Ya. Gromov, V.V. Kuznetsov
1982Vy06	IANFA	46,	2066	Ts. Vylov, V.G. Kalinnikov, V.V. Kuznetsov, Z.N. Li, A.A. Solnyshkin, Y.U. Yuskevich
1982Vy07	IANFA	46,	2239	Ts. Vylov, V.M. Gorodzhankin, K.Y. Gromov, V.V. Kuznetsov, T. Kretsu, N.A. Lebedev, Yu. V. Yushkevich
1982Vy10	YAFIA	36,	812	Ts. Vylov, V.M. Gorodzhankin, K. Ya. Gromov, A.I. Ivanov, I.F. Uchevatkin, V.G. Chumin
1982Wi.A	Th.-Un.N.Caroln			J.F. Wilkerson
1982Zu02	PRVCA	26,	965	J.D. Zumbro, C.P. Browne, J.F. Mateja, H.T. Fortune, R. Middleton
1982Zu04	PRVCA	26,	2668	J.D. Zumbro, A.A. Rollefson, R.W. Tarara, C.P. Browne
1982Zw02	NUPAB	389,	301	B. Zwiegliński, W. Benenson, G.M. Crawley, S. Galès, D. Weber
1983				
1983Ad05	CZYPA	33,	465	J. Adam, V. Hnatowicz, A. Kugler
1983Al06	ZPAAD	310,	247	G.D. Alkhazov, K.A. Mezilev, Yu. N. Novikov, N. Ganbataar, K. Ya. Gromov, V.G. Kalinnikov, A. Potempa, E. Sieniawski, F. Tarkanyi
1983Al18	PZETA	38,	144	G.D. Alkhazov, A.A. Bykov, V.D. Vitman, Yu. V. Naukov, S. Yu. Orlov, V.K. Tarasov
1983Al20	YAFIA	37,	797	D.V. Aleksandrov, E.A. Ganza, Yu. A. Glukhov, V.I. Dukhanov, I.B. Mazurov
1983Al.A	PrvCom	AHW	Jan	G.D. Alkhazov
1983Al.B	P-Moscow		87	G.D. Alkhazov, A.A. Akhmonen, L. Kh. Batist, Yu. S. Blinnikov, N. Ganbataar, K. Ya. Gromov, Yu. V. Elkin, V.G. Kalinnikov, K.A. Mezilev, F.V. Moroz, Yu. N. Novikov, A.M. Nurmukhamedov, V.N. Panteleev, A.G. Polyakov, A. Potempa, E. Senyavski, V.K. Tarasov, F. Tarkani
1983An15	JPHGB	9,	L245	M.S. Antony, J. Britz, J.B. Buep, A. Papp
1983Ay01	NUPAB	404,	1	J. Äystö, J. Honkanen, W. Trzaska, K. Eskola, K. Vierinen, S. Messelt
1983Ba32	PRVCA	28,	337	P.A. Baisden, D.H. Sisson, S. Niemeyer, B. Hudson, C.L. Bennet, R.A. Naumann
1983Be18	NUPAB	399,	131	H. Behrens, P. Christmas
1983Be42	NUPAB	408,	87	G.J. Beyer, A. De Rújula, R.-D. von Dincklage, H. Å. Gustafsson, P.G. Hansen, P. Hoff, B. Jonson, H.L. Ravn, K. Riisager
1983Be.C	PrvCom	GAu	Sep	M. Bernas, et al
1983BI16	ZPAAD	314,	199	J. Blomqvist, A. Kerek, B. Fogelberg
1983Bo29	PYLBB	130,	167	P.D. Bond, R.F. Casten, D.D. Warner, D. Horn

1983Bu03	CJPHA	61,	460	D.G. Burke, I. Nowikov, Y.K. Peng, J.C. Yanch
1983Ca04	PRVCA	27,	1310	R.F. Casten, D.D. Warner, G.M. Gowdy, N. Rofail, K.P. Lieb
1983Ca06	PYLBB	123,	25	M.D. Cable, J. Honkanen, R.F. Parry, S.H. Zhou, Z.Y. Zhou, J. Cerny for 26Sii
1983Ch08	ZPAAD	310,	135	A. Chalupka, H. Vonach, E. Hueges, H.J. Scheerer
1983Ch39	PRVCA	28,	2099	C. Chung, W.B. Walters, D.S. Brenner, A. Aprahamian, R.L. Gill, M. Shmid, R.E. Chrien, L.-J. Yuan, A. Wolf, Z. Berant
1983Ch47	NUIMA	215,	397	P. Christmas, S.M. Judge, T.B. Ryves, D. Smith, G. Winkler
1983Ci01	PRVCA	27,	1040	J.A. Cizewski, D.G. Burke, E.R. Flynn, R.E. Brown, J.W. Sunier
1983De03	PRVCA	27,	892	R.A. Dewberry, R.T. Kouzes, R.A. Neumann
1983De04	NUPAB	394,	378	C. Détraz, M. Langevin, M.C. Goffri-Kouassi, D. Guillemaud, M. Epherre, G. Audi, C. Thibault, F. Touchard
1983De17	ZPAAD	312,	209	D.J. Decman, R.K. Sheline, Y. Tanaka, E.T. Jurney
1983De20	NUPAB	401,	397	P. De Gelder, D. De Frenne, K. Heyde, N. Kaffrell, A.M. VanDenBerg, N. Blasi, M.N. Harakah, W. Sterrenburg
1983De28	NUPAB	404,	225	M.G. Delfini, J. Kopecky, J.B.M. de Haas, H.I. Liou, R.E. Chrien, P.M. Endt
1983De29	NUPAB	404,	250	M.G. Delfini, J. Kopecky, R.E. Chrien, H.I. Liou, P.M. Endt
1983De47	YAFIA	38,	1105	A.V. Derbin, L.A. Popeko
1983De51	YAFIA	38,	1377	R.A. Demirkhanov, V.V. Dorokhov, M.I. Dzkuya, G.A. Dorokhova, see also report SFTII Suchumi
1983Do11	ZPAAD	313,	207	Zs. Dombbrádi, A. Krasznahorkay, J. Gulyás
1983En03	NSENA	85,	139	T.R. England, W.B. Wilson, R.E. Schenter, F.M. Mann
1983Fe06	ZPAAD	314,	159	P. Fettweiss, J.C. Dehaes
1983FI05	PRVCA	28,	97	E.R. Flynn, J. van der Plicht, J.B. Wilhelmy, L.G. Mann, G.L. Struble, R.G. Lanier
1983FI06	PRVCA	28,	575	E.R. Flynn, R.E. Brown, F. Ajzenberg-Selove, J.A. Cizewski
1983Fo.B	PrvCom	AHW	Jun	I. Förster
1983Ga18	PRVCA	28,	2423	C.A. Gagliardi, G.T. Garvey, J.R. Wrobel, S.J. Freedman
1983Ga.A	P-Moscow		90	N. Ganbaatar, Ya. Kormitski, K.A. Mezilev, Yu. N. Novikov, A.M. Nur-mukhamedov, A. Potempa, E. Senyavski, F. Tarkani
1983Ge08	NUIMA	211,	89	W. Gelletly
1983Gn01	NUPAB	406,	29	B.E. Gnade, R.E. Fink, J.L. Wood
1983Gr01	PYLBB	120,	63	H. Grawe, H. Haas
1983Ha06	NUPAB	395,	152	E. Hagberg, J.C. Hardy, H. Schmeing, E.T.H. Clifford, V.T. Koslowsky
1983Ha35	IJARA	34,	1241	H.H. Hansen
1983He08	PRVCA	27,	2248	R.G. Helmer, C.W. Reich
1983Hi05	PRVCA	27,	2857	J.C. Hill, H. Yamamoto, A. Wolf
1983Hi08	NUPAB	404,	51	R. Hingmann, H.-G. Clerc, C.-C. Sahn, D. Vermeulen, K.-H. Schmidt, J.G. Kekeller
1983Ho08	NUPAB	398,	130	M.A.C. Hotchkis, L.K. Fifield, J.R. Leigh, T.R. Ophel, G.D. Putt, D.C. Weiser
1983Ho23	PYLBB	133,	146	J. Honkanen, M.D. Cable, R.F. Parry, S.H. Zhou, Z.Y. Zhou, J. Cerny
1983Hu11	ZPAAD	313,	325	P. Hungerford, T. von Egidy, H.H. Schmidt, S.A. Kerr, H.G. Börner, E. Monnard
1983Hu12	ZPAAD	313,	337	P. Hungerford, T. von Egidy, H.H. Schmidt, S.A. Kerr, H.G. Börner, E. Monnard
1983Hu13	ZPAAD	313,	349	P. Hungerford, T. von Egidy, H.H. Schmidt, S.A. Kerr, H.G. Börner, E. Monnard
1983Ia02	CJCHA	61,	694	R. Iafigliola, M. Chatterjee, H. Dautet, J.K.P. Lee
1983Iw02	IJARA	34,	1537	Y. Iwata, M. Kawamoto, Y. Yoshizawa
1983Jo04	NUPAB	396,	479c	B. Jonson, J.U. Andersen, G.J. Beyer, G. Charpak, A. De Rújula, B. El-bek, H.A. Gustavson, P.G. Hansen, P. Knudsen, E. Laegsgaard, J. Pedersen, H.L. Ravn
1983Ke.A	P-Florence		B118	S.A. Kerr, F. Hoyler, K. Schreckenbach, H.G. Börner, G.G. Colvin, see also P-Knoxville(1984)416
1983Kr11	ZPAAD	312,	43	K.-L. Kratz, H. Ohm, A. Schroder, H. Gabelmann, W. Ziegert, B. Pfeiffer, G. Jung, E. Monnard, J.A. Pinston, F. Schussler, G.I. Crawford, S.G. Prussin, Z.M. de Oliveira
1983La12	PYLBB	125,	116	M. Langevin, C. Détraz, D. Guillemaud-Mueller, A.C. Mueller, C. Thibault, F. Touchard, M. Epherre
1983La23	PYLBB	130,	251	M. Langevin, C. Détraz, D. Guillemaud-Mueller, A.C. Mueller, C. Thibault, F. Touchard, G. Klotz, C. Miehé, G. Walter, M. Epherre, C. Richard-Serre
1983La.A	VDPEA	18,	1138	P.O. Larsson, T. Batsch, R. Kirchner, O. Klepper, W. Kurcewicz, E. Roeckl, D. Schardt, G. Nymann, P. Tidemand-Petersson, and verbal report

1983Le.A	Th.-Helsinki			M. Leino (Report HU-P-D37)
1983Li11	PRVCA	28,	2127	C.J. Lister, B.J. Varley, D.E. Alburger, P.E. Haustein, S.K. Saha, J.W. Olness, H.G. Price, A.D. Irving
1983Mi20	PYLBB	130,	1	T. Minamisono, K. Takeyama, T. Ishigai, H. Takeshima, Y. Nojiri, K. Asahi
1983Mo09	PRVCA	28,	623	S. Mordechai, S. LaFrance, H.T. Fortune
1983Ni05	ZPAAD	312,	265	J.M. Nitschke, M.D. Cable, W.-D. Zeitz
1983Ny01	NUPAB	408,	127	K. Nybø, T.F. Thorsteinsen, G. Løvhøiden, E.R. Flynn, J.A. Cizewski, R.K. Shelton, D. Decman, D.G. Burke, G. Sletten, P. Hill, N. Kaffrell, W. Kurcewicz, G. Nymann
1983Og.A	JINR-D7-83-644			Yu. Ts. Oganessian
1983Pa.A	Th.-Berkeley			R.F. Parry DABBB 44,2472(1984)
1983Pu01	NUPAB	399,	190	G.P. Putt, L.K. Field, M.A.C. Hotchkis, T.R. Ophel, D.C. Weisser
1983Ra04	PRVCA	27,	1188	S. Raman, E.T. Journey, D.A. Outlaw, I.S. Towner
1983Ra25	PRLTA	51,	975	R.S. Raghavan
1983Ra.A	P-Florence		I-1	K.V. Ramaniah, S.B. Reddy, V.V. Rama Murthi, K.L. Narasimham
1983Re05	PRVCA	27,	3002	P.L. Reeder, R.A. Warner, R.L. Gill
1983Ro08	NUPAB	401,	41	M. Rotbard, M. Vergnes, J. Vernotte, G. Berrier-Ronsin, J. Kalifa, R. Tamisier
1983Ru06	NUPAB	399,	163	E. Runte, W.-D. Schmidt-Ott, P. Tidemand-Petersson, R. Kirchner, O. Klepper, W. Kurcewicz, E. Roeckl, N. Kaffrell, P. Peuser, K. Rykaczewski, M. Bernas, P. Dessagne, M. Langevin
1983Ru08	NUPAB	407,	60	J.F.G.A. Ruyf, P.M. Endt
1983Sc18	ZPAAD	310,	295	U.J. Schrewe, E. Hagberg, H. Schmeing, J.C. Hardy, V.T. Koslowsky, K.S. Sharma
1983Sc23	PRVCA	28,	435	N. Schulz, A. Chevallier, J. Chevallier, S. Khazrouni, L. Kraus, I. Linck
1983Sc24	ZPAAD	312,	21	J.R.H. Schneider, S. Hofmann, F.P. Heßberger, G. Müntenberg, W. Reisdorf, P. Armbruster
1983Sc28	ZPAAD	313,	137	U.J. Schrewe, W.D. Schmidt-Ott
1983Se17	IANFA	47,	885	V.A. Sergienko, A.V. Borontsovskii, M.A. Nain
1983Sh06	ZPAAD	311,	71	K. Shizuma, H. Lawin, K. Sistemich
1983Sh31	PRVCA	28,	1712	B. Sherrill, K. Beard, W. Benenson, B.A. Brown, E. Kashy, W.E. Ormand, H. Nann, J.J. Kehayias, A.D. Bacher, T.E. Ward
1983Ta.A	BAPSA	28,	658	R.W. Tarara, C.P. Browne, see BAPSA 28,968
1983Ti02	NUPAB	403,	13	T.A.A. Tielens, J. Kopecky, K. Abrahams, P.M. Endt
1983To01	PRVCA	27,	889	K.S. Toth
1983To20	NUPAB	411,	209	Y. Tokunaga, H. Seyfarth, O.W.B. Schult, H.G. Börner, Ch. Hofmeyr, G. Barreau, R. Brissot, Ch. Monkemeyer, U. Kaup
1983Ts01	PRVCA	27,	2397	J.S. Tsai, T.J. Kennett, W.V. Prestwich
1983Ve06	IANFA	47,	834	G.V. Veselov, N. Ganbaatar, Ya. Kormitski, Yu. N. Novikov, A. Potempa, E. Senyavski, V.A. Sergienko, F. Tarkani
1983Ve.A	P-Moscow		99	G.V. Veselov, N. Ganbaatar, K.A. Mezilev, Yu. N. Novikov, A. Potempa, V.A. Sergienko, F. Tarkanyi, A.G. Teterin
1983Vi.A	P-Moscow		575	V.D. Vitman, F.V. Moroz, S. Yu. Orlov, V.K. Tarasov
1983Vo10	ZPAAD	313,	167	E. Voth, W.D. Schmidt-Ott, H. Behrens
1983Vo.A	PrvCom	AHW	Jul	H. Vonach
1983Wa26	IJARA	34,	1191	K.F. Walz, K. Debertin, H. Schrader
1983Wa27	NUPAB	411,	81	F.B. Waanders, J.P.L. Reinecke, H.N. Jacobs, J.J.A. Smit, M.A. Meyer, P.M. Endt
1983We07	ZPAAD	313,	173	B. Weiss, C.F. Liang, P. Paris, A. Peghaire, A. Gizon, and Prv-Com GAu Oct 1983
1983Wi14	NUPAB	411,	151	C.A. Wiedner, R. Haupt, W. Saathoff, J. Haas, R. Gyufko, K.R. Cordell, S.T. Thornton, R.A. Cecil, R.L. Parks
1983Wi.A	PrvCom	AHW	Jan	C.A. Wiedner, et al
1983Wi.B	PrvCom	AHW	Jun	C.-A. Wiedner, et al
1983Wo01	PRVCA	27,	27	C.J. Woodward, R.E. Tribble, D.M. Tanner
1983Wo04	PRVCA	27,	1745	J.M. Wouters, H.M. Thierens, J. Äystö, M.D. Cable, P.E. Haustein, R.F. Parry, J. Cerny
1983Wo10	PRLTA	51,	873	F.K. Wahn, J.C. Hill, R.F. Petry, H. Dejbakhsh, Z. Berant, R.L. Gill
1983Zu01	NUPAB	393,	15	J.D. Zumbro, R.W. Tarara

1984

1984Ah02	NUPAB	413,	423	I. Ahmad, J.L. Lerner
1984A108	YAFIA	39,	513	D.V. Aleksandrov, E.A. Ganza, Yu. A. Glukhov, B.G. Novatskiĭ, A.A. Ogloblin, D.N. Stepanov
1984A136	IANFA	48,	834	G.D. Alkhazov, N. Ganbaatar, K. Ya. Gromov, V.K. Kalinnikov, K.A. Mezilev, Yu. N. Novikov, A.M. Nurmukhamedov, A. Potempa, F. Tarkani
1984An03	NCIAA	79,	100	M.S. Antony, J. Britz, J.B. Bueb, A. Pape
1984An17	NCIAA	81,	414	M.S. Antony, J. Britz, J. Bueb, A. Pape
1984Ay01	PYLBB	138,	369	J. Äystö, J. Arje, V. Koponen, P. Taskinen, H. Hyvonen, A. Hautajarvi, K. Vierinen
1984Ba12	PRVCA	29,	1530	P.H. Barker, R.E. White
1984Ba.B	P-Darmstadt		55	P.H. Barker, R.E. White, D.M.J. Lovelock, R.M. Smythe
1984Be10	NUPAB	413,	363	M. Bernas, Ph. Dessagne, M. Langevin, J. Payet, F. Pougheon, P. Roussel, W.-D. Schmidt-Ott, P. Tidemand-Petersson, M. Girod
1984Be.A	PrvCom		84De33	M. Bernas, Ph. Dessagne, M. Langevin, J. Payet, F. Pougheon, P. Roussel, I. Turkevicz, M. Girod confirmed PrvCom GAu 1988
1984Bh02	NCIAA	79,	471	P. Bhattacharya
1984Bl.A	P-Darmstadt		134	F. Blönnigen, G. Bewersdorf, C. Geisse, W. Lippert, B. Pfeiffer, U. Stöhlker, H. Wollnik
1984Bo.C	P-Knoxville		382	M. Bogdanovic, H. Seyfarth, H.R. Börner, S. Kerr, F. Hoyler, K. Schreckenbach, G.G. Colvin
1984Br.A	AnRpt IPN		13	F. Bragança Gil, C. Bourgeois, P. Kilcher, M.G. Porquet, B. Roussière, J. Sauvage, ISOCELE
1984Bu09	NUPAB	415,	93	L. Buchmann, M. Hilgemeier, A. Krauss, A. Redder, C. Rolfs, H.P. Trautvetter, T.R. Donoghue
1984Bu14	PRVCA	29,	2339	D.G. Burke
1984Bu23	PRVCA	30,	742	B.L. Burks, R.E. Anderson, Y. Aoki, B.C. Karp, E.J. Ludwig, W.J. Thompson, R.L. Varner
1984Ca32	PRVCA	30,	1671	F. Calaprice, G.T. Ewan, R.-D. von Dincklage, B. Jonson, O.C. Jonsson, H.L. Ravn
1984Ch02	PRVCA	29,	592	C. Chung, W.B. Walters, N.K. Aras, F.K. Wohn, D.S. Brenner, Y.Y. Chu, M. Schmid, R.L. Gill, R.E. Chrien, L.-J. Yuan
1984Co19	ZPAAD	319,	107	M.D. Cohler, D.L. Watson, R. Wadsworth, S.M. Lane, M.J. Smithson, R.E. Brown, J.-C. Peng, N. Stein, J.W. Sunier, D.M. Drake
1984Co.A	P-Darmstadt		272	E. Coenen, K. Deneffe, M. Huysse, P. Van Duppen, and PrvCom AHW July 1984
1984Cr01	JPGPE	10,	1133	D.A. Craig, H.W. Taylor
1984Da.A	P-Darmstadt		257	H. Dautet, N. Campeau, J.K.P. Lee, C. Bourgeois, B. Roussière, A. Houdayer
1984De15	NUPAB	419,	101	J.B.M. De Hass, K. Abrahams, T.A.A. Tielens, H. Postma, W.J. Huiskamp
1984De16	NUPAB	419,	165	D.J. Decman, H. Grawe, H. Kluge, K.H. Maier, A. Maj, M. Menningen, N. Roy, W. Wiegner
1984De33	NUPAB	426,	399	Ph. Dessagne, M. Bernas, M. Langevin, G.C. Morrison, J. Payet, F. Pougheon, P. Roussel
1984El05	PYLBB	141,	306	R.J. Ellis, K.S. Sharma, R.C. Barber, S.R. Loewen, H.E. Duckworth
1984Fa04	PYLBB	137,	23	T. Faestermann, A. Gillitzer, K. Hartel, P. Kienle, E. Nolte, and AMCO-7, p.177,184
1984Fi02	NUPAB	417,	534	L.K. Fifield, M.A.C. Hotchkis, P.V. Drumm, T.R. Ophel, G.D. Putt, D.C. Weisser
1984Fi05	PRVCA	29,	2118	B.W. Filippone, C.N. Davids, R.C. Pardo, J. Äystö
1984Fi.A	BAPSA	29,	1056	S.A. Fisher, R.L. Hershberger, F. Gabbard
1984Fo19	NUPAB	429,	205	B. Fogelberg, J. Blomqvist
1984Fo.A	P-Knoxville		427	I. Förster, H.G. Börner, P. von Brentano, G.G. Colvin, A.M.I. Haque, S.A. Kerr, R. Rascher, R. Richter, K. Schreckenbach
1984Ga.B	BAPSA	29,	1041	Z. Gacsi, Ya. Guyash, T. Kibedi, E. Koltai, A. Krasnakhorkai, T. Fenesh
1984Gi09	PRVCA	30,	958	R. Gilman, H.T. Fortune, L.C. Bland, R.R. Kiziah, C.F. Moore, P.A. Seidl, C.L. Morris, W.B. Cottingham
1984Ha20	PYLBB	138,	260	B.J. Hall, R.J. Ellis, G.R. Dyck, C.A. Lander, R. Beach, K.S. Sharma, R.C. Barber, H.E. Duckworth
1984Ha27	NUPAB	420,	351	R. Hanninen

1984Ha31	ZPAAD	317,	193	R. Haupt, C.-A. Wiedner, G.J. Wagner, K. Wannebo, T.S. Bhatia, H. Hafner, R. Maschuw, W. Saathoff, S.T. Thornton
1984Ha.A	P-Darmstadt		89	W. Hampel, R. Schlotz
1984Ha.B	P-Darmstadt		244	W. Habenicht, L. Spanier, G. Korschinek, H. Ernst, E. Nolte
1984He.A	Th.-Montreal			D.W. Hetherington
1984Ho02	PRVCA	29,	618	R.W. Hoff, T. von Egidy, R.W. Lougheed, D.H. White, H.G. Börner, K. Schreck-enbach, G. Barreau, D.D. Warner
1984Ho.A	P-Darmstadt		184	S. Hofmann, Y.K. Agarwal, P. Armbruster, F.P. Heßberger, P.O. Larsson, G. Münzenberg, K. Poppensieker, W. Reisdorf, J.R.H. Schneider, H.J. Schött
1984Ho.B	Th.-Canberra			M.A.C. Hotchkis
1984Ia.A	P-Darmstadt		141	R. Iafigliola, H. Dautet, S.W. Xu, J.K.P. Lee, R. Chrien, R. Gill, M. Shmid
1984Is09	KURAA	17,	132	T. Ishii, H. Yamamoto, M. Yoshida, K. Kawade, H. Miyade, Y. Iwata, T. Katoh, J.-Z. Ruan, Y. Fumakoshi, Y. Kawase, K. Okano
1984Ka07	PYLBB	137,	150	I. Katayama, S. Morinobu, M. Fujiwara, Y. Fujita, T. Yamazaki, H. Ikegami
1984Ka22	PRVCA	30,	807	S. Kahane, S. Raman, G.G. Slaughter, C. Coceva, M. Stefanon
1984Ka.A	P-Alma Ata		128	V.G. Kalinnikov, V.V. Kuznetsov, V.I. Stegailov, see also P-Yurmala(1987)p119
1984Ke11	CJPHA	62,	861	T.J. Kennett, W.V. Prestwich, J.S. Tai
1984Ke15	PRVCA	30,	1840	T.J. Kennett, M.A. Islam, W.V. Prestwich
1984Ko10	PRVCA	29,	2343	R.T. Kouzes, M.M. Lowry, C.L. Bennett, and PrvCom AHW May 1988
1984Ko29	NUPAB	427,	413	J. Kopecky, M.G. Delfini, R.E. Chrien
1984Kr05	NUPAB	417,	231	B. Krusche, K.P. Lieb, L. Ziegler, H. Daniel, T. von Egidy, R. Rascher, H.G. Börner, G. Barreau, D.D. Warner
1984Kr.B	P-Darmstadt		127	K.-L. Kratz, A. Schröder, H. Ohm, H. Gabelmann, W. Ziegert, B. Steinmüller, B. Pfeiffer
1984Ku28	NIMBE	5,	430	W. Kutschera, P.J. Billquist, D. Frekers, W. Henning, K.J. Jensen, Ma Xiuzeng, R. Pardo, M. Paul, K.E. Rehm, R.K. Smither, J.L. Yntema, L.F. Mausner
1984La03	NUPAB	414,	151	M. Langevin, C. Détraz, D. Guillemaud-Mueller, A.C. Mueller, C. Thibault, F. Touchard, M. Epherre
1984La06	NUPAB	413,	236	R.G. Lanier, R.K. Sheline, G.L. Struble, L.G. Mann, J.A. Cizewski, and erratum NUPAB 427,650
1984La.A	P-Darmstadt		652	E. Laegsgaard, J.U. Andersen, G.J. Beyer, A. De Rújula, P.G. Hansen, B. Jonson, H.L. Ravn
1984Li05	NUPAB	417,	365	Y.-F. Liu, K.J. Moody, D. Lee, Y. Morita, G.T. Seaborg, H.R. von Gunten
1984Li24	PZETA	39,	529	É.T. Lippmaa, R. I. Pikver, É.R. Suurmaa, Ya. O. Past, Yu. Kh. Puskar, I.A. Koppel', A.A. Tammik
1984Li.A	AnRpt Berkeley			W.X. Li, K.E. Gregorich, R.B. Welch, W. Kot, D. Lee, G.T. Seaborg
1984Lu02	ZPAAD	315,	295	E. Lund, B. Fogelberg
1984Ma49	ZPAAD	319,	287	W.A. Mayer, W. Henning, R. Holzwarth, H.J. Körner, G. Korschinek, W.U. Mayer, G. Rosner, H.J. Scheerer
1984Mi.A	AnRpt Munich		40	C. Mittag, H. Puchta, F. Riess, M. Stallknecht
1984Mo22	NUPAB	427,	317	D.M. Moltz, K.S. Toth, F.T. Avignone III, H. Noma, B.D. Kern, R.E. Tribble, J.P. Sullivan
1984Mu07	ZPAAD	315,	145	G. Münzenberg, W. Reisdorf, S. Hofmann, Y.K. Agarwal, F.P. Heßberger, K. Poppensieker, J.R.H. Schneider, W.F.W. Schneider, K.-H. Schmidt, H.J. Schött, P. Armbruster, C.-C. Sahn, D. Vermeulen
1984Ni03	ZPAAD	316,	249	J.M. Nitschke, P.A. Wilmarth, P.K. Lemmertz, W.-D. Zeitz, J.A. Honkanen
1984Ni16	PZETA	39,	441	E.N. Nikolaev, Yu. I. Neronov, M.V. Gorshkov, V.L. Talroze
1984No05	NUPAB	423,	197	G.J.L. Nooren, C. van der Leun
1984Ox01	ZPAAD	316,	97	K. Oxorn, S.K. Mark
1984Pi03	NUPAB	414,	219	Š. Piskoř, P. Franc, J. Kremenek, W. Schäferlingová
1984Po09	RAACA	35,	23	P. Polak, L. Lindner
1984Ra09	PRVCA	30,	26	S. Raman, W. Ratynski, E.T. Journey, M.E. Bunker, J.W. Starnier
1984Ro.A	BAPSA	29,	1041	G. Rotbard, M. Vergnes, J. Vernotte, G. Berrier Ronsin, S. Gales, G.M. Crawley
1984Ru06	NUPAB	419,	439	J.F.A.G. Ruyf, J.B.M. de Haas, P.M. Endt, L. Zybert
1984Ru.A	P-Darmstadt		196	B. Rubio, R. Julin, A. Ercan, K. Zuber, P. Kleinheinz, J.L. Tain, G.P.A. Berg, G. Hlawatsch, I. Katayama, J. Meissburger, D. Paul, J.G. Roemer, J. Blomqvist
1984Ry02	NUIMA	223,	325	A. Rytz, R.A.P. Wiltshire
1984Sc06	ZPAAD	315,	49	U.J. Schrewe, E. Hagberg, H. Schmeing, J.C. Hardy, V.T. Koslowsky, K.S. Sharma

1984Sc13	ZPAAD	316,	19	K.-H. Schmidt, C.-C. Sahn, K. Pielenz, H.-G. Clerc
1984Sc18	ZPAAD	317,	305	U.J. Schrewe, E. Voth, U. Bosch, W.-D. Schmidt-Ott, H. Behrens
1984Sc.A	GSI-84-3			J. Schneider Thesis
1984Sc.B	P-Darmstadt		203	U.J. Schrewe, P. Tidemand-Petersson, H. Behrens, H. Dornhöfer, R. Michaelsen, E. Runte, W.-D. Schmidt-Ott, E. Voth
1984Sc.C	P-Darmstadt		229	D. Schardt, P.O. Larsson, R. Kirchner, O. Klepper, V.T. Koslowsky, E. Roeckl, K. Rykaczewski, P. Kleinheinz, K. Zuber
1984Sh28	PRVCA	30,	2111	T. Shinozuka, M. Fujioka, H. Miyatake, M. Yoshii, H. Hama, T. Kamiya
1984Sh31	AENGA	56,	245	V.M. Shatinsky
1984Th08	PRVCA	30,	1442	C.E. Thorn, J.W. Olness, E.K. Warburton, S. Raman
1984To09	PRLTA	53,	1623	K.S. Toth, Y.A. Ellis-Akovali, C.R. Bingham, D.M. Moltz, D.C. Sousa, H.K. Carter, R.L. Mlekodaj, E.H. Spejewski
1984To11	NUPAB	430,	269	Y. Tokunaga, H. Seyfarth, O.W.B. Schult, S. Brant, V. Paar, D. Vretenar, H.G. Börner, G. Barreau, H. Faust, Ch. Hofmeyr, K. Schreckenbach, R.A. Meyer
1984Vo01	JPHGB	10,	221	T. von Egidy, H. Daniel, P. Hungerford, H.H. Schmidt, K.P. Lieb, B. Krusche, S.A. Kerr, G. Barreau, H.G. Börner, R. Brissot, C. Hofmeyr, R. Rascher
1984Vo07	PRVCA	29,	1243	T. von Egidy, R.W. Hoff, R.W. Loughheed, D.H. White, H.G. Börner, K. Schreckenbach, D.D. Warner, G. Barreau, E. Hungerford
1984Ya.A	Th.-Berkeley			S. Yashita
1985				
1985Ad.A	P-Leningrad		93	Dz. Adam, T. Dzelev, D. Zakoutski, B. Kratsik, I. Penev
1985Af.A	P-Leningrad		1083	V.P. Afanasiev, Yu. S. Blinnikov, N. Ganbaatar, V. Dzeleznyakov, V.G. Kalinikov, Ya. Kormitski, K.A. Mezilev, Yu. N. Novikov, A.M. Nurmuzamedov, V.N. Panteleev, A.G. Polyakov, A. Potempa, F. Tarkani
1985Ah.A	P-Bombay			S.A. Ahmad, et al, and 89Ot.1
1985Al02	PRVCA	31,	360	T. Altzitzoglou, R.T. Kouzes, F.W. Loeser, M.M. Lowry, R.A. Naumann, R.E. Chrien, and erratum PRVCA 32,665
1985Al08	NUPAB	438,	482	G.D. Alkhazov, A.A. Bykov, V.D. Wittmann, V.E. Starodubsky, S.Y. Orlov, V.N. Panteleyev, A.G. Polyakov, V.K. Tarasov
1985Al11	PRLTA	55,	799	T. Altzitzoglou, F. Calaprice, M. Dewey, M. Lowry, L. Piilonen, J. Brorson, S. Hagen, F. Loeser
1985Al13	PYLBB	157,	350	G.D. Alkhazov, A.A. Bykov, V.D. Wittmann, S. Yu. Orlov, V.K. Tarasov
1985An17	NCIAA	88,	265	M.S. Antony, J. Britz, J.B. Bueb, V.B. Ndocko-Ndongué
1985Ap01	PZETA	42,	233	A.M. Apalikov, S.D. Boris, A.I. Golutvin, L.P. Laptin, V.A. Lyubimov, N.F. Myasoedov, V.V. Nagovitsyn, E.G. Novikov, V.Z. Nozik, V.A. Soloshchenko, I.N. Tikhomirov, E.F. Tretyakov
1985Au07	ZPAAD	321,	533	G. Audi, R.L. Graham, J.S. Geiger
1985Ay01	PRLTA	55,	1384	J. Äystö, D.M. Moltz, X.J. Xu, J.E. Reiff, J. Cerny
1985Ba57	ZPAAD	322,	457	A. Baas-May, J.V. Kratz, N. Trautmann
1985Be17	ZPAAD	320,	693	F.J. Bergmeister, K.P. Lieb, K. Pampus, M. Uhrmacher
1985Be20	PYLBB	156,	159	Z. Berant, R.L. Gill, M.H. Rafailovich, R.E. Chrien, J.C. Hill, F.K. Wohn, R.F. Petry, C. Chung, G. Peaslee, M. Mohsen
1985Be24	ZPAAD	321,	435	M. Bernas, M. Langevin, G. Parrot, E. Pougheon, E. Quiniou, P. Roussel, Ph. Dessagne, W.D. Schmidt-Ott
1985Be50	PYLBB	162,	87	W. Benenson, K. Beard, C. Bloch, B. Sherrill, B.A. Brown, A.D. Panagiotou, J. van der Plicht, J.S. Winsfield, C.E. Thorn
1985Bj01	NUPAB	443,	283	T. Bjornstad, M.J.G. Borge, P. Dessagne, R.-D. von Dincklage, G.T. Ewan, P.G. Hansen, A. Huck, B. Jonson, G. Klotz, A. Knipper, P.O. Larsson, G. Nyman, H.L. Ravn, C. Richard-Serre, K. Riisager, D. Schardt, G. Walter
1985Bo34	PYLBB	159,	217	S. Boris, A. Golutvin, L. Laptin, V. Lubimov, V. Nagovizin, E. Novikov, V. Nozik, V. Soloshenko, I. Tikhomirov, E. Tretjakov
1985Bo46	PRLTA	55,	2269	J.A. Bounds, C.R. Bingham, P. Juncar, H.K. Carter, G.A. Leander, R.L. Mlekodaj, E.H. Spejewski, W.M. Fairbank, Jr.
1985Bo49	PYLBB	164,	22	U. Bosch, W.-D. Schmidt-Ott, P. Tidemand-Petersson, E. Runte, W. Hillebrandt, M. Lechle, F.-K. Thielemann, R. Kirchner, O. Klepper, E. Roeckl, K. Rykaczewski, D. Schardt, N. Kaffrell, M. Bernas, Ph. Dessagne, W. Kurcewicz

1985Bo58	NUIMA	228,	387	V.R. Bom, P.C. Coops
1985Br03	PYLBB	150,	75	M. Brauner, D. Rychel, R. Gyufko, C.A. Wiedner, S.T. Thornton
1985Br08	NUIMA	234,	218	M. Brugger, N. Hildebrand, T. Karlewski, N. Trautmann, A.K. Mazumdar, G. Herrmann
1985Co06	PRLTA	54,	1783	E. Coenen, K. Deneffe, M. Huyse, P. Van Duppen, J.L. Wood
1985Co24	PYLBB	163,	66	A. Coc, C. Thibault, F. Touchard, H.T. Duong, P. Juncar, S. Liberman, J. Pinard, J. Lermé, J.L. Vialle, S. Büttgenbach, A.C. Mueller, A. Pesnelle, and the ISOLDE Collaboration
1985Co.B	PrvCom	AHW	Dec	G.G. Colvin
1985Da15	PRVCA	32,	713	N.J. Davis, J.A. Kuehner, A.A. Pilt, A.J. Trudel, M.C. Vetterli, C. Bamber, E.K. Warburton, J.W. Olness, S. Raman
1985De08	JPHGB	11,	L59	K. Deneffe, E. Coenen, M. Huyse, P. Van Duppen, J. Vanhorenbeeck, P. del Marmol, P. Fettweis
1985De14	NUPAB	436,	311	D.J. Decman, H. Grawe, H. Kluge, K.H. Maier, A. Maj, N. Roy, Y.K. Agarwal, K.P. Blume, M. Guttormsen, H. Hubel, J. Recht
1985De40	CJPHA	63,	966	V.P. Derenchuk, R.J. Ellis, K.S. Sharma, R.C. Barber, H.E. Duckworth
1985Dr06	NUPAB	441,	95	P.V. Drumm, L.K. Fifield, R.A. Bark, M.A.C. Hotchkis, C.L. Woods, P. Maier-Komor
1985Dy04	PYLBB	157,	139	G.R. Dyck, R.J. Ellis, K.S. Sharma, C.A. Lander, M.H. Sidky, R.C. Barber, H.E. Duckworth
1985EI01	NUPAB	435,	34	R.J. Ellis, R.C. Barber, G.R. Dyck, B.J. Hall, K.S. Sharma, C.A. Lander, H.E. Duckworth, and PrvCom AHW October 1991
1985Ev01	PYLBB	153,	25	P.D. Eversheim, F. Hinterberger, S. Kuhn, P. Von Rossen, J. Romer, R.P. Trelle
1985Fi03	NUPAB	440,	531	L.K. Fifield, C.L. Woods, R.A. Bark, P.V. Drumm, M.A.C. Hotchkis
1985Fi08	NUPAB	437,	141	L.K. Fifield, P.V. Drumm, M.A.C. Hotchkis, T.R. Ophel, C.L. Woods
1985Fr01	NUPAB	433,	351	R. Franke, H. Kockskamper, B. Steinheuer, K. Wingender, W. von Witsch
1985Fu03	NUPAB	435,	7	Y. Fujita, S. Morinobu, I. Katayama, M. Fujiwara, T. Yamazaki, H. Ikegami, H. Taketani, M. Adachi, T. Matsuzaki, M. Matoba, N. Koori
1985Ge02	JPHGB	11,	1055	W. Gelletly, J.R. Larysz, H.G. Börner, R.F. Casten, W.F. Davidson, W. Mampe, K. Schreckenbach, D.D. Warner
1985Gy01	PYLBB	150,	335	R. Gyufko, D. Rychel, M. Steck, C.-A. Wiedner, R.L. Parks, S.T. Thornton
1985Ha12	PRVCA	31,	1594	F.X. Hartmann, R.A. Naumann
1985He06	ZPAAD	321,	317	F.P. Heßberger, G. Münzenberg, S. Hofmann, W. Reisdorf, K.-H. Schmidt, H.J. Schött, P. Armbruster, R. Hingmann, B. Thuma, D. Vermeulen
1985He22	ZPAAD	322,	557	F.P. Heßberger, G. Münzenberg, S. Hofmann, Y.K. Agarwal, K. Poppensieker, W. Reisdorf, K.-H. Schmidt, J.R.H. Schneider, W.F.W. Schneider, H.J. Schött, P. Armbruster, B. Thuma, C.-C. Sahm, D. Vermeulen
1985He.A	GSI-85-11			F.P. Heßberger
1985Hi.A	AnRpt GSI		88	R. Hingmann, W. Kuehn, V. Metag, R. Novotny, A. Ruckelshausen, H. Strocher, F.P. Heßberger, S. Hofmann, G. Münzenberg, W. Reisdorf
1985Ho21	PYLBB	160,	375	E. Hourani, M. Hussonnois, L. Stab, L. Brillard, S. Gales, J.P. Schapira
1985Ho.A	PrvCom	NDG	876	C. Hofmeyr, C. Franklyn, G. Barreau, H.G. Börner, R. Brissot, H. Faust, K. Schreckenbach
1985Hu03	PRVCA	31,	2226	A. Huck, G. Klotz, A. Knipper, C. Miehé, C. Richard-Serre, G. Walter, A. Poves, H.L. Ravn, G. Marguier
1985Ke08	ZPAAD	322,	121	T.J. Kennett, W.V. Prestwich, J.S. Tsai
1985Ke11	PRVCA	32,	2148	T.J. Kennett, W.V. Prestwich, J.S. Tsai
1985Ke.A	PrvCom	AHW	Jan	T.J. Kennett
1985Kh04	PYLBB	156,	155	S. Khan, Th. Kihm, K.T. Knöpfle, G. Mairle, V. Bechtold, L. Friedrich
1985Ko47	NIMBE	12,	325	P.J.J. Kok, K. Abrahams, H. Postma, W.J. Huiskamp
1985Kr06	NUPAB	439,	219	B. Krusche, Ch. Winter, K.P. Lieb, P. Hungerford, H.H. Schmidt, T. von Egidy, H.J. Scheerer, S.A. Kerr, H.G. Börner
1985La17	IJARA	36,	443	R.M. Lambrecht, S. Mirzadeh
1985Le10	PRVCA	32,	277	R.S. Lee, J.H. Hamilton, A.V. Ramayya, A.P. de Lima, D.L. Sastry, K.S.R. Sasstry, E.H. Spejewski, R.L. Mlekodaj, H.K. Carter, W.-D. Schmidt-Ott, J. Lin, C.R. Bingham, L.L. Riedinger, E.F. Zganjar, J.L. Weil, B.D. Kern, A.C. Xenoulis, R.W. Fink, Sun Xi-jun, Guo Jun-sheng, Cho Chi-cheng, Pan Zong-you, Guo Ying-xian
1985Li02	PRLTA	54,	285	E. Lippmaa, R. Pikver, E. Suurmaa, J. Past, J. Puskar, I. Koppel, A. Tammik

1985Ma54	JPHGB	11,	1231	T.D. MacMahon, G.R. Massoumi, T. Mitsunari, M. Thein, O. Chalhoub, D. Breitung, H.A. Baader, U. Heim, H.R. Koch, L. Wimmwer, H. Seyfarth, K. Schreckenbach, G.B. Orr, G.J. Smith, W.R. Kane, I.A. Kondurov, P.A. Sushkov, Yu. E. Loginov, D. Rabenstein, M. Bogdanovic
1985Ma59	PRVCA	32,	2215	J. Markey, F. Boehm
1985Mu11	ZPAAD	322,	227	G. Münzenberg, S. Hofmann, H. Folger, F.P. Heßberger, J. Keller, K. Poppensieker, B. Quint, W. Reisdorf, K.-H. Schmidt, H.J. Schött, P. Armbruster, M.E. Leino, R. Hingmann
1985No03	PRVCA	31,	1937	E.B. Norman
1985Oh06	PYLBB	160,	322	T. Ohi, M. Nakajima, H. Tamura, T. Matsuzaki, T. Yamazaki, O. Hashimoto, R.S. Hayano
1985Pf.A	P-Birmingham		75	B. Pfeiffer, K.-L. Kratz, H. Gabelmann, W. Ziegert, V. Harms, B. Leist, and 93Ru01
1985Pi03	PRVCA	31,	1032	A.A. Pilt, J.A. Cameron, R.B. Schubank, E.E. Habib
1985Re02	NUPAB	435,	333	J.P.L. Reinecke, F.B. Waanders, P. Oberholzer, P.J.C. Janse van Rensburg, J.A. Cilliers, J.J.A. Smit, M.A. Meyer, P.M. Endt
1985Ry02	ZPAAD	322,	263	K. Rykaczewski, I.S. Grant, R. Kirchner, O. Klepper, V.T. Koslowsky, P.O. Larson, E. Nolte, G. Nyman, E. Roeckl, D. Schardt, L. Spanier, P. Tidemand-Petersson, E.F. Zganjar, J. Żylicz
1985Sa15	ZPAAD	321,	255	M. Samri, J.G. Costa, G. Klotz, D. Magnac, R. Selz, J.P. Zirnfeld
1985Sc09	ZPAAD	320,	595	U.J. Schrewe, H. Dornhöfer, E. Runte, W.D. Schmidt-Ott, T. Tidemand-Petersson, R. Michaelsen
1985Sc16	NUIMA	236,	225	H. Schölermann, B.R.L. Siebert
1985Sh03	PRVCA	31,	875	B. Sherrill, K. Beard, W. Benenson, C. Bloch, B.A. Brown, E. Kashy, J.A. Nolen, Jr., A.D. Panagiotou, J. van der Plicht, J.S. Winfield, see P-Darmstadt p. 82
1985Si07	PRVCA	31,	1891	J.J. Simpson, W.R. Dixon, R.S. Storey
1985Si25	JPSLB	46,	L1095	C. Signarbieux, G. Simon, J. Trochon, F. Brisard and PrvCom GAu Jan 1988
1985So03	PRVCA	31,	1801	L.P. Somerville, M.J. Nurmia, J.M. Nitschke, A. Ghiorso, E.K. Hulet, R.W. Loughheed
1985St02	PRVCA	32,	582	R.E. Stone, C.E. Bingham, L.L. Riedinger, R.W. Lide, H.K. Carter, R.L. Mlekosdaj, E.H. Spejewski
1985St16	ZPAAD	322,	83	[190Pb]C. Stenzel, H. Grawe, H. Haas, H.-E. Mahnke, K.H. Maier
1985Ta.A	P-Swansea		343	V.L. Talrose, E.N. Nikolaev
1985Ti01	ZPAAD	320,	405	P. Tidemand-Petersson, E. Runte, W.-D. Schmidt-Ott, U.J. Schrewe
1985Ti02	NUPAB	437,	342	P. Tidemand-Petersson, R. Kirchner, O. Klepper, E. Roeckl, D. Schardt, A. Plochocki, J. Żylicz
1985To10	NUPAB	439,	427	Y. Tokunaga, H. Seyfarth, R.A. Meyer, O.W.B. Schult, H.G. Börner, G. Barreau, H.R. Faust, K. Schreckenbach, S. Brant, V. Paar, M. Vouk, D. Vretenar
1985Ts01	ZPAAD	322,	295	J.S. Tsai, T.J. Kennett, W.V. Prestwich
1985Ts02	ZPAAD	322,	597	J.S. Tsai, W.V. Prestwich, T.J. Kennett
1985Uh01	NIMBE	9,	234	M. Uhrmacher, K. Pampus, F.J. Bergmeister, D. Purschke, K.P. Lieb
1985Va03	PYLBB	154,	354	P. Van Duppen, E. Coenen, K. Deneffe, M. Huyse, J.L. Wood
1985Va.A	JINR-R6-85-22			E.V. Vasileva, et al
1985Vo03	PRVCA	31,	1510	R.-D. von Dincklage, J. Gerl, H.L. Ravn, G.J. Beyer
1985Vo09	ZPAAD	321,	375	R.-D. von Dincklage, H.J. Hay
1985Vo13	NUPAB	445,	113	R.-D. von Dincklage, H.J. Hay, H.L. Ravn
1985Vo15	ZPAAD	322,	669	T. von Egidy, H.G. Börner, F. Hoyler
1985Wh03	MTRGA	21,	193	R.E. White, P.H. Barker, D.M.J. Lovelock
1985Wi07	ZPAAD	321,	179	P.A. Wilmarth, J.M. Nitschke, P.K. Lemmertz, R.B. Firestone
1985Wi15	NUPAB	444,	49	K. Wick, U. Berghaus, H. Bruckmann, P. Lara, W. Schutte, B. Anders, Y. Koike
1985Wo01	PYLBB	150,	79	P.J. Woods, R. Chapman, J.L. Durell, J.N. Mo, N.E. Sanderson, R.A. Cunningham, B.R. Fulton
1985Wo04	NUPAB	437,	454	C.L. Woods, L.K. Fifield, R.A. Bark, P.V. Drumm, M.A.C. Hotchkis
1985Wo07	ZPAAD	321,	119	P.J. Woods, R. Chapman, J.L. Durell, J.N. Mo, R.J. Smith, N.E. Sanderson, B.R. Fulton, R.A. Cunningham
1985Wo.A	PrvCom	GAu	Feb	P.J. Woods

1986Ad07	IANFA	50,	855	J. Adam, V. Vagner, M. Gonusek, B. Kratick
1986Ag.A	P-Charkov		98	V.A. Ageev, V.S. Belyavenko, V.A. Dzeltonodzkii, A.A. Klyushnikov
1986Au02	NUPAB	449,	491	G. Audi, A. Coc, M. Epherre, G. Le Scornet, C. Thibault, F. Touchard, ISOLDE
1986Ba26	PRVCA	34,	362	S.W. Barwick, P.B. Price, H.L. Ravn, E. Hourani, M. Hussonnois
1986Ba72	IANFA	50,	1898	K.A. Baskova, G.I. Borisov, A.B. Vovk, T.M. Gerus, L.I. Go
1986Be35	NUPAB	460,	352	A.V. Belozyorov, C. Borcea, Z. Dlouhy, A.M. Kalinin, R. Kalpakchieva, Nguyen Hoai Chau, Yu. Ts. Oganessian, Yu. E. Penionzhkevich
1986Be53	UFZHA	31,	1773	V.S. Belyavenko, G.P. Borozenets, I.N. Vishnevsky, V.A. Zheltonozhsky
1986Bj01	NUPAB	453,	463	T. Björnstad, M.J.G. Borge, J. Blomqvist, R.D. von Dincklage, G.T. Ewan, P. Hoff, B. Jonson, K. Kawade, A. Kerek, O. Klepper, G. Løvvhøiden, S. Mattsson, G. Nyman, H.L. Ravn, G. Rudstam, K. Sistemich, O. Tengblad, ISOLDE
1986Bo28	ZPAAD	325,	149	V.R. Bom, P.C. Coops, R.W. Hollander, E. Coenen, K. Deneffe, P. Van Duppen, M. Huyse
1986Bo46	PHSTB	34,	591	M.J.G. Borge, A. De Rújula, P.G. Hansen, B. Jonson, G. Nyman, H.L. Ravn, K. Riisager, ISOLDE
1986Bu18	PRVCA	34,	2316	B.L. Burks, R.L. Varner, E.J. Ludwig
1986Ch01	PRVCA	33,	130	T. Chapuran, K. Dybdal, D.B. Fossan, T. Lönnroth, W.F. Piel, Jr., D. Horn, E.K. Warburton
1986Co12	ZPAAD	324,	485	E. Coenen, K. Deneffe, M. Huyse, P. Van Duppen, J.L. Wood
1986Cu01	PRLTA	56,	34	M.S. Curtin, L.H. Harwood, J.A. Nolen, B. Sherrill, Z.Q. Xie, B.A. Brown
1986Da.A	AnRpt McGill		29	H. Dautet, R. Turcotte, S.K. Mark
1986De13	NUPAB	454,	1	H.P.L. De Esch, C. van der Leun
1986De14	NUPAB	454,	48	H.P.L. De Esch, J.B.J.M. Lanen, C. van der Leun
1986Di01	PRVCA	33,	103	G.U. Din, A.M. Al Soraya, J.A. Cameron, V.P. Janzen, R.B. Schubank
1986Ek01	PHSTB	34,	614	B. Ekström, B. Fogelberg, P. Hoff, E. Lund, A. Sangiyavanish
1986Fi06	NUPAB	453,	497	L.K. Fifield, C.L. Woods, W.N. Catford, R.A. Bark, P.V. Drumm, K.T. Keoghán
1986Fr09	PYLBB	173,	485	M. Fritschi, E. Holzschuh, W. Kündig, J.W. Petersen, R.E. Pixley, H. Stüssi, and PrvCom AHW
1986Ga19	PRVCA	34,	1663	C.A. Gagliardi, D.R. Semon, R.E. Tribble, L.A. Van Ausdeln
1986Gi07	PRLTA	56,	1874	R.L. Gill, R.F. Casten, D.D. Warner, A. Piotrowski, H. Mach, J.C. Hill, K.K. Wohn, J.A. Winger, R. Moreh
1986Gi08	NUPAB	453,	1	K.-L. Gippert, E. Runte, W.-D. Schmidt-Ott, P. Tidemand-Petersson, N. Kaffrell, P. Peuser, R. Kirchner, O. Klepper, W. Kurcewicz, P.O. Larsson, E. Roeckl, D. Schardt, K. Rykaczewski
1986Go10	ZPAAD	324,	117	H. Göktürk, B. Ekstrom, E. Lund, B. Fogelberg
1986Gr01	PRLTA	56,	819	G.L. Greene, E.G. Kessler, Jr., R.D. Deslattes, H. Börner
1986Ha22	NUPAB	455,	231	A.M.I. Hague, R.F. Casten, I. Förster, A. Gelberg, R. Rascher, R. Richter, P. von Brentano, G. Barreau, H.G. Börner, S.A. Kerr, K. Schreckenbach, D.D. Warner
1986Hi08	PRVCA	34,	2312	J.C. Hill, F.K. Wohn, K. Leininger, J.A. Winger, M.E. Nieland, R.L. Gill, A. Piotrowski, R.F. Petry, J.D. Goulden
1986Hu01	PRLTA	56,	313	E.K. Hulet, J.F. Wild, R.J. Dougan, R.W. Lougheed, J.H. Landrum, A.D. Dougan, M. Schädel, R.L. Hahn, P.A. Baisden, C.M. Henderson, R.J. Dupzyk, K. Sümmmerer, G.R. Bethune
1986Hu05	PRVCA	34,	1394	E.K. Hulet, R.W. Lougheed, J.F. Wild, R.J. Dougan, K.J. Moody, R.L. Hahn, C.M. Henderson, R.J. Dupzyk, G.R. Bethune
1986Ka38	JUPSA	55,	3014	H. Kawakami, S. Shibita, J. Tanaka, T. Toriyama, S. Noguchi, M. Mushano, K. Hisatake
1986Ka43	NUPAB	460,	437	N. Kaffrell, P. Hill, J. Rogowski, H. Tetzlaff, N. Trautmann, E. Jacobs, P. De Gelder, D. De Frenne, K. Heyde, G. Skarnemark, J. Alstad, N. Blasi, M.N. Harakeh, W.A. Sterrenburg, K. Wolfsberg
1986Ke03	NUPAB	452,	173	J.G. Keller, K.-H. Schmidt, F.P. Heßberger, G. Münzenberg, W. Reisdorf, H.-G. Clerc, C.-C. Sahn, and PrvCom K.-H. Schmidt to AHW November 1992
1986Ke14	NIMAE	249,	366	T.J. Kennett, W.V. Prestwich, J.S. Tsai
1986Ko01	PRVCA	33,	392	T. Kohno, M. Adachi, S. Fukuda, M. Taya, M. Fukuda, H. Taketani, Y. Gono, M. Sugawara, Y. Ishikawa
1986Ko19	ZPAAD	324,	271	P.J.J. Kok, J.B.M. de Haas, K. Abrahams, H. Postma, W.J. Huiskamp

1986Lo16	JCOMA	122,	461	R.W. Loughheed, E.K. Hulet, R.J. Dougan, J.F. Wild, R.J. Dupzyk, C.M. Henderson, K.J. Moody, R.L. Hahn, K. Summerer, G. Bethune
1986Ma12	PRLTA	56,	1547	H. Mach, A. Piotrowski, R.L. Gill, R.F. Casten, D.D. Warner
1986Ma40	PRVCA	34,	729	L.G. Mann, R.G. Lanier, G.L. Struble, R.A. Naumann, R.T. Kouzes
1986Mi08	PRVCA	33,	1736	C. Miehé, Ph. Dessagne, P. Baumann, A. Huck, G. Klotz, A. Knipper, G. Walter, C. Richard-Serre
1986Mi14	PRVCA	33,	2204	D. Miljanic, S. Blagus, M. Zadro
1986Pr03	NUPAB	455,	1	P.T. Prokofjev, V.A. Bondarenko, T.V. Guseva, N.D. Kramer, L.I. Simonova, J.J. Tambergs, K. Schreckenbach, W.F. Davidson, J.A. Pinston, D.D. Warner, P.H.M. van Assche, A.M.J. Spits
1986Pr05	ZPAAD	325,	321	W.V. Prestwich, T.J. Kennett, J.S. Tsai
1986Ru04	ZPAAD	324,	27	B. Rubio, A. Ercan, G. de Angelis, P. Kleinheinz, J.L. Tain, B. Brinkmoeller, D. Paul, J. Meissburger, L.G. Mann, D.J. Decman, T.N. Massey, G.L. Struble, H.J. Scheerer, J. Blomqvist
1986Ru05	ZPAAD	324,	119	E. Runte, T. Hild, W.-D. Schmidt-Ott, U.J. Schrewe, P. Tidemand-Petersson, R. Michaelsen
1986Ry04	NIMAE	253,	47	A. Rytz, R.A.P. Wiltshire, M. King
1986Sc16	NUPAB	454,	267	H.H. Schmidt, T. von Egidy, H.J. Scheerer, P. Hungerford, H.G. Börner, S.A. Kerr, K. Schreckenbach, R.F. Casten, W.R. Kane, D.D. Warner, A. Chalupka, M.K. Balodis, T.V. Guseva, P.T. Prokofjev, J.J. Tambergs
1986Sc21	NUPAB	457,	182	P. Schmalbrock, T.R. Donoghue, M. Wiescher, V. Wijekumar, C.P. Browne, A.A. Rollefson, C. Rolfs, A. Vliks
1986Sc25	JPHGB	12,	411	H.H. Schmidt, W. Stöfl, T. von Egidy, P. Hungerford, H.J. Scheerer, K. Schreckenbach, H.G. Börner, D.D. Warner, R.E. Chrien, R.C. Greenwood, C.W. Reich
1986Se04	PYLBB	173,	397	K.K. Seth, S. Iversen, M. Kaletka, D. Barlow, A. Saha, R. Soundranayagam
1986Si20	ZPAAD	325,	139	K. Sistemich, K. Kawade, H. Lawin, G. Lhersonneau, H. Ohm, U. Paffrath, V. Lopac, S. Brant, V. Paar
1986Sm05	ZPAAD	324,	283	R.J. Smith, P.J. Woods, R. Chapman, J.L. Durell, J.N. Mo, B.R. Fulton, R.A. Cunningham
1986To12	PYLBB	178,	150	K.S. Toth, Y.A. Ellis-Akovali, J.M. Nitschke, P.A. Wilmarth, P.K. Lemmertz, D.M. Moltz, F.T. Avignone III
1986Ts04	CJPHA	64,	1569	J.S. Tsai, W.V. Prestwich, T.J. Kennett
1986U102	ZPAAD	325,	247	G. Ulm, S.K. Bhattacharjee, P. Dabkiewicz, G. Huber, H.-J. Kluge, T. Kuhl, H. Lochmann, E.-W. Otten, K. Wendt, S.A. Ahmad, W. Klempt, R. Neugart, ISOLDE
1986Va08	PRVCA	33,	1141	G. Vandenput, P.H.M. van Assche, L. Jacobs, J.M. van den Cruyce, R.K. Smither, K. Schreckenbach, T. von Egidy, D. Breitig, H.A. Baader, H.R. Koch
1986Ve.A	P-Charkov		107	G.V. Veselov, K.A. Mezilev, Yu. N. Novikov, A.V. Lopov, V.A. Sergienko
1986Ve.B	P-Charkov		138	G.V. Veselov, K.A. Mezilev, Yu. N. Novikov, A.V. Lopov, Yu. Ya. Sergeev, V.A. Sergienko, V.I. Tichonov
1986Vi09	PRLTA	57,	3253	D.J. Vieira, J.M. Wouters, K. Vaziri, R.H. Krauss, Jr., H. Wollnik, G.W. Butler, F.K. Wohn, A.H. Wapstra
1986Wa17	RAEFB	94,	27	R.A. Warner, P.L. Reeder
1986Wi15	ZPAAD	325,	485	P.A. Wilmarth, J.M. Nitschke, R.B. Firestone, J. Gilat
1986Wi16	NUPAB	460,	501	Ch. Winter, B. Krusche, K.P. Lieb, H.H. Schmidt, T. von Egidy, P. Hungerford, F. Hoyler, H.G. Börner
1986Wo07	PYLBB	182,	297	P.J. Woods, R. Chapman, J.L. Durell, J.N. Mo, R.J. Smith, B.R. Fulton, R.A. Cunningham, P.V. Drumm, L.K. Fifield
1986Ya17	PYLBB	181,	169	S. Yasumi, M. Ando, H. Maezawa, H. Kitamura, T. Ohta, F. Ochiai, A. Mikuni, M. Maruyama, M. Fujioka, K. Ishii, T. Shinozuka, K. Sera, T. Omori, G. Izawa, M. Yagi, K. Masumoto, K. Shima, T. Mukoyama, Y. Inagaki, I. Sugai, A. Masuda, O. Kawakami
			1987	
1987Aj.A	PrvCom	AHW	Jul	F. Ajzenberg-Selove

1987Ba52	NUPAB	472,	445	M.K. Balodis, P.T. Prokofjev, N.D. Kramer, L.I. Simonova, K. Schreckenbach, W.F. Davidson, J.A. Pinston, P. Hungerford, H.H. Schmidt, H.J. Scheerer, T. von Egidy, P.H.M. van Assche, A.M.J. Spits, R.F. Casten, W.R. Kane, D.D. Warner, J. Kern
1987Bo07	PRLTA	58,	2019	S. Boris, A. Golutvin, L. Laptin, V. Lubimov, V. Nagovizin, V. Nozik, E. Novikov, V. Soloshenko, I. Tihomirov, E. Tretjakov, N. Myasoedov
1987Bo21	PHSTB	36,	218	M.J.G. Borge, P. Dessagne, G.T. Ewan, P.G. Hansen, A. Huck, B. Jonson, G. Klotz, A. Knipper, S. Mattsson, G. Nyman, C. Richard-Serre, K. Riisager, G. Walter, ISOLDE
1987Bo24	NUPAB	470,	13	M. Bogdanović, R. Brissot, G. Barreau, K. Schreckenbach, S. Kerr, H.G. Börner, I.A. Kondurov, Yu. E. Loginov, V.V. Martynov, P.A. Sushkov, H. Seyfarth, T. von Egidy, P. Hungerford, H.H. Schmidt, H.J. Scheerer, A. Chalupka, W. Kane, G. Alaga
1987Bo29	HYIND	34,	25	W. Borchers, R. Neugart, E.W. Otten, H.T. Duong, G. Ulm, K. Wendt, ISOLDE, and 89Ot.1
1987Bo59	HYIND	38,	793	G. Bollen, P. Dabkiewicz, P. Egelhof, T. Hilberath, H. Kalinowsky, F. Kern, H. Schnatz, L. Schweikhard, H. Stolzenberg, R.B. Moore, H.J. Kluge, G.M. Temmer, G. Ulm
1987Br05	NUPAB	465,	221	A. Bruce, D. Hicks, D.D. Wagner
1987Br33	JPHGB	13,	1565	V.B. Brudanin, T. Vylov, Ch. Briançon, V.M. Gorojankin, K.Y. Gromov, A. Marinov, A.P. Novgorodov, V.N. Pokrovski, N.I. Rukhadze
1987Br.B	AnRpt Julich		9	B. Brinkmoeller, H.P. Morsch, R. Siebert, P. Decowski, M. Rogge, P. Turek
1987Bu.A	BAPSA	32,	1063	B. Budick, Hong Lin
1987Ch.A	AnRpt Daresb		7	R. Chapman, J.L. Durell, J.N. Mo, P.J. Woods, B.R. Fulton, R.A. Cunningham, P.V. Drumm, L.K. Fifield
1987Ci.A	P-Leuven		S103	J.A. Cizewski, G.G. Colvin, H.G. Börner, P. Geltenbort, F. Hoyler, S.A. Kerr, K. Schreckenbach, and PrvCom AHW
1987Co08	NUPAB	465,	240	G.G. Colvin, H.G. Börner, P. Geltenbort, F. Hoyler, S.A. Kerr, K. Schreckenbach, J.A. Cizewski, and PrvCom AHW December 1988
1987De04	ZPAAD	326,	155	J. Deslauriers, S.C. Gujrathi, S.K. Mark
1987De33	JPHGB	13,	1283	C.T.A.M. De Laat, P. Polak, A. Taal, J. Konijn, W. Lourens, A.H. Wapstra
1987De.A	AnRpt Leuven		47	P. Dendooven, M. Huysse, G. Reusen, J. Wouters, P. Van Duppen, I. Ahmad, R. Holzmann, R.V.F. Janssens
1987Eb02	NUPAB	464,	9	J. Eberz, U. Dinger, G. Huber, H. Lochmann, R. Menges, R. Neugart, R. Kirchner, O. Klepper, T. Kuhl, D. Marx, G. Ulm, K. Wendt, ISOLDE
1987EI02	JPHGB	13,	93	A.M.Y. El-Lawindy, J.D. Burrows, P.A. Butler, J.R. Cresswell, V. Holliday, G.D. Jones, R. Tanner, R. Wadsworth, D.L. Watson, K.A. Connell, J. Simpsom, C. Lauterbach, J.R. Mines
1987EI09	PRVCA	36,	1529	Y.A. Ellis-Akovali, K.S. Toth, H.K. Carter, C.R. Bingham, I.C. Girit, M.O. Kortelahti
1987Fa.A	P-Rosseau		675	T. Faestermann, A. Gillitzer, K. Hartel, W. Henning, P. Kienle
1987Fo20	NUPAB	475,	301	B. Fogelberg, A.M. Bruce, D.D. Warner
1987Ga.A	P-Yurmala		86	N. Ganbaatar, G.V. Veselov, K.A. Mezilev, V.G. Kalinnikov
1987Ge01	JPHGB	13,	69	W. Gelletly, J.R. Larysz, H.G. Börner, R.F. Casten, W.F. Davidson, W. Mampe, K. Schreckenbach, D.D. Warner
1987Gi05	PYLBB	192,	39	A. Gillibert, W. Mittag, L. Bianchi, A. Cunsolo, B. Fernandez, A. Foti, J. Gastebois, C. Gregoire, Y. Schutz, C. Stephan
1987Gi07	NUPAB	473,	717	C. Giusti, F.D. Pacati
1987Go25	PZETA	45,	205	M.G. Gornov, Y.B. Gurov, V.P. Koptev, P.V. Morokhov, K.O. Oganessian, B.P. Osipenko, V.A. Pechkurov, V.I. Savel'ev, F.M. Sergeev, A.A. Khomutov, B.A. Chernyshev, R.R. Shafigullin, A.V. Shishkov
1987Gr12	PRVCA	35,	1965	R.C. Greenwood, R.A. Anderl, J.D. Cole, H. Willmes
1987Gr18	ZPAAD	327,	383	M. Graefenstedt, U. Keyser, F. Münnich, F. Schreiber, H.R. Faust, H. Weikard
1987Gr.A	P-Rosseau		30	M. Graefenstedt, U. Keyser, F. Münnich, F. Schreiber
1987Gr.B	VHDPG	PG,	81,89	M. Graefenstedt, et al
1987Ha.A	AnRpt Tohoku		43	H. Hama, et al
1987Ha.B	P-Rosseau		650	H. Hama, M. Yoshii, K. Taguchi, T. Ishimatsu, T. Shinozuka, M. Fujioka
1987He10	EULEE	3,	895	F.P. Heßberger, S. Hofmann, G. Münzenberg, A.B. Quint, K. Sümmerer, P. Armbruster

1987He14	PRVCA	36,	1504	D.W. Hetherington, R.L. Graham, M.A. Lone, J.S. Geiger, G.E. Lee-Whiting
1987He21	NUPAB	474,	484	K. Heiguchi, S. Mitarai, B.J. Min, T. Kuroyanagi
1987He28	NUPAB	474,	77	R.G. Helmer, M.A. Lee, C.W. Reich, I. Ahmad
1987Ho06	ARISE	38,	195	D.D. Hoppes, B.M. Coursey, F.J. Schima, D. Yang
1987Ho.A	AnRpt LBL		39	M.A.C. Hotchkis, J.E. Reiff, D.J. Vieira, F. Blönnigen, T.F. Lang, D.M. Moltz, X. Xu, J. Cerny
1987Ju02	ARISE	38,	193	S.M. Judge, A.M. Privitera, M.J. Woods
1987Ju04	ARISE	38,	839	S.M. Judge, P. Christmas, P. Cross, D. Smith, W.D. Hamilton, and PrvCom AHW February 1989
1987Ka29	NUPAB	470,	141	N. Kaffrell, P. Hill, J. Rogowski, H. Tetzlaff, N. Trautmann, E. Jacobs, P. De Gelder, D. De Frenne, K. Heyde, S. Borjesson, G. Skarnemark, J. Alstad, N. Blasi, M.N. Harakeh, W.A. Sterrenburg, K. Wolfsberg
1987Ka.A	AnRpt RCNP		86	K. Katori, H. Miyatake, A. Higashi, A. Shinohara, N. Ikeda, I. Katayama, S. Morinobu
1987Ke09	CJPHA	65,	1111	T.J. Kennett, W.V. Prestwich, J.S. Tsai
1987Ke.A	P-Leuven		S571	J. Kern, H.G. Börner, G.G. Colvin, S. Drissi, T. von Egidy, M. Kalanga, J.-L. Salici
1987Ko34	NUPAB	472,	419	V.T. Koslowsky, J.C. Hardy, E. Hagberg, R.E. Azuma, G.C. Ball, E.T.H. Clifford, W.G. Davies, H. Schmeing, U.J. Schrewe, K.S. Sharma
1987Li.A	P-Rosseau		521	C.F. Liang, P. Paris, Ch. Briançon
1987Me08	ZPAAD	327,	171	F. Meissner, W.-D. Schmidt-ott, L. Ziegeler
1987Mh.A	P-Leuven		199	A.K. Mheemed, S.S. Kamoona, S.A. Abbas, T. Al-Janabi
1987Mi10	PRVCA	36,	420	G.J. Miller, J.C. McGeorge, I. Anthony, R.O. Owens
1987Mo06	PRVCA	35,	1275	D.M. Moltz, A.C. Betker, J.P. Sullivan, R.H. Burch, C.A. Gagliardi, R.E. Tribble, K.S. Toth, F.T. Avignone III
1987Mu15	ZPAAD	328,	49	G. Münzenberg, P. Armbruster, G. Berthes, H. Folger, F.P. Heßberger, S. Hofmann, J. Keller, K. Poppensieker, A.B. Quint, W. Reisdorf, K.-H. Schmidt, H.-J. Schött, K. Sümmerner, I. Zychor, M.E. Leino, R. Hingmann, U. Gollerthan, E. Hanelt
1987Ne.A	P-Rosseau		126	R. Neugart, E. Arnold, W. Borchers, W. Neu, G. Ulm, K. Wendt
1987Pe06	PRVCA	35,	1617	K.I. Pearce, N.M. Clarke, R.J. Griffiths, P.J. Simmonds, A.C. Dodd, D. Barker, J.B.A. England, M.C. Mannion, C.A. Ogilvie
1987Ra04	NUPAB	464,	349	V. Rahkonen, T. Lonnroth
1987Ra06	PRVCA	36,	303	M.S. Rapaport, C.F. Liang, P. Paris, and PrvCom GAU July 1988
1987Ru05	ZPAAD	328,	373	E. Runte, F. Meissner, V. Freystein, T. Hild, H. Salewski, W.-D. Schmidt-Ott, R. Michaelsen
1987Sa53	JUPSA	56,	3881	H.S. Sahota, T. Iwashita, B.S. Grewal
1987Sc.A	P-Rosseau		477	D. Schardt, R. Barden, R. Kirchner, O. Klepper, A. Plochocki, E. Roeckl, P. Kleinheinz, M. Piiparinen, B. Rubio, K. Zuber, C.F. Liang, P. Paris, A. Huck, G. Walter, G. Marguier, H. Gabelmann, J. Blomqvist
1987Se04	NUPAB	464,	381	P.B. Semmes, R.A. Braga, R.W. Fink, J.L. Wood, J.D. Cole
1987Se05	PRLTA	58,	1930	K.K. Seth, M. Artuso, D. Barlow, S. Iversen, M. Kaletka, H. Nann, B. Parker, R. Soundranayagam
1987Se.A	P-Rosseau		324	K.K. Seth
1987Sp02	PRVAA	35,	679	P.T. Springer, C.L. Bennett, P.A. Baisden
1987Sp09	NUPAB	474,	359	L. Spanier, K. Aleklett, B. Ekström, B. Fogelberg
1987Sp.A	P-Leuven		S559	A.M.J. Spits, S.J. Robinson
1987St04	ZPAAD	326,	139	E. Stiliaris, H.G. Bohlen, X.S. Chen, B. Gebauer, A. Miczaika, W. von Oertzen, W. Weller, T. Wilpert
1987St11	PRVCA	35,	2033	G.S.F. Stephans, H.T. Fortune, L.C. Bland, M. Carchidi, R. Gilman, G.P. Gilfoyle, J.W. Sweet
1987St.A	P-Rosseau		489	J. Styczen, P. Kleinheinz, W. Starzecki, B. Rubio, G. de Angelis, H.J. Hahn, C.F. Liang, P. Paris, R. Reinhardt, P. von Brentano, J. Blomqvist
1987To02	PRVCA	35,	310	K.S. Toth, D.C. Sousa, J.M. Nitschke, P.A. Wilmarth
1987To09	PRVCA	35,	2330	K.S. Toth, D.M. Moltz, F. Blönnigen, F.T. Avignone, III
1987Va09	PRVCA	35,	1861	P. Van Duppen, E. Coenen, K. Deneffe, M. Huyse, J.L. Wood
1987Va20	NUPAB	469,	531	L. Van Elmbt, J. Deutsch, R. Prieels, and NUPAB 493(1989)611
1987Ve.A	P-Yurmala		146	G.V. Veselov, K.A. Mezilev, Yu. N. Novikov, A.V. Lopov, V.A. Sergienko
1987Vi01	NUPAB	463,	605	K. Vierinen

1987Wh01	PRVCA	35,	81	D.H. White, H.G. Börner, R.W. Hoff, K. Schreckenbach, W.F. Davidson, T. von Egidy, D.D. Warner, P. Jeuch, G. Barreau, W.R. Kane, M.L. Stelts, R.E. Chrien, R.F. Casten, R.G. Lanier, R.W. Lougheed, R.T. Kouzes, R.A. Naumann, R. Dewberry
1987Wi03	NUPAB	464,	315	A. Willis, M. Morlet, N. Marty, C. Djalali, G.M. Crawley, A. Galonsky, V. Rotberg, B.A. Brown
1987Wi15	NUPAB	473,	129	Ch. Winter, B. Krusche, K.P. Lieb, T. Weber, G. Hlawatsch, T. von Egidy, F. Hoyler
1987Zi02	NUPAB	466,	280	F. Zijderhand, R.C. Makkus, C. van der Leun
			1988	
1988Ah02	NUPAB	483,	244	S.A. Ahmad, W. Klempt, R. Neugart, E.W. Otten, P.-G. Reinhard, G. Ulm, K. Wendt, ISOLDE
1988Ax01	PYLBB	210,	249	H. Axelsson, M. Cronqvist, A. De Rújula, P.G. Hansen, L. Johannsen, B. Jonson, R.A. Naumann, G. Nyman, J.W. Petersen, H.L. Ravn, K. Riisager, J.A. Scircle, ISOLDE
1988Ay01	PYLBB	201,	211	J. Äystö, P. Taskinen, M. Yoshii, J. Honkanen, P. Jauho, H. Penttilä, C.N. Davids
1988Ay02	NUPAB	480,	104	J. Äystö, C.N. Davids, J. Hattula, J. Honkanen, P. Jauho, R. Julin, S. Juutinen, J. Kumpulainen, T. Loenroth, A. Pakkanen, A. Passoja, H. Penttilä, P. Taskinen, E. Verho, A. Virtanen, M. Yoshi
1988Ba10	ZPAAD	329,	319	R. Barden, R. Kirchner, O. Klepper, A. Plochocki, G.-E. Rathke, E. Roeckl, K. Rykaczewski, D. Schardt, J. Żylicz
1988Ba42	ZPAAD	330,	341	D. Barnéoud, J. Blachot, J. Genevey, A. Gizon, R. Béraud, R. Duffait, A. Emsallem, M. Meyer, N. Redon, D. Rolando-Eugio
1988Be.A	P-StMalo		A1	R. Béraud, R. Duffait, A. Emsallem, M. Meyer, N. Redon, D. Rolando-Eugio, D. Barnéoud, J. Blachot, J. Genevey, A. Gizon
1988Bo06	NUPAB	477,	89	U. Bosch, W.-D. Schmidt-Ott, E. Runte, P. Tidemand-Petersson, P. Koschel, F. Meissner, R. Kirchner, O. Klepper, E. Roeckl, K. Rykaczewski, D. Schardt
1988Bo20	ZPAAD	330,	227	H.G. Bohlen, B. Gebauer, D. Kolbert, W. von Oertzen, E. Stiliaris, M. Wilpert, T. Wilpert
1988Bo28	ZPAAD	331,	21	V.R. Bom, R.W. Hollander, E. Coenen, K. Deneffe, P. Van Duppen, M. Huyse
1988Bo39	NUPAB	490,	287	M.J.G. Borge, H. Cronberg, M. Cronqvist, H. Gabelmann, P.G. Hansen, L. Johannsen, B. Jonson, S. Mattsson, G. Nyman, A. Richter, K. Riisager, O. Tengblad, M. Tomaselli
1988Bu08	NUPAB	483,	221	D.G. Burke, G. Løvhøiden, T.F. Thorsteinsen
1988Ca21	NUPAB	489,	347	W.N. Catford, L.K. Fifield, T.R. Ophel, N.A. Orr, D.C. Weisser, C.L. Woods
1988C104	JPHGB	14,	1399	N.M. Clarke, P.R. Hayes, M.B. Becha, K.I. Pearce, R.J. Griffiths, J.B.A. England, L. Zybert, C.N. Pinder, G.M. Field, R.S. Mackintosh
1988Co18	JPHGB	14,	1411	G.G. Colvin, S.J. Robinson, F. Hoyler
1988CoTa	CODBA	63,	1	E.R. Cohen, B.N. Taylor
1988De03	NUPAB	476,	316	H.P.L. De Esch, C. van der Leun
1988Du09	PYLBB	206,	195	J.P. Dufour, R. Del Moral, F. Hubert, D. Jean, M.S. Pravikoff, A. Fleury, A.C. Mueller, K.-H. Schmidt, K. Sümmerner, E. Hanelt, J. Frehaut, M. Beau, G. Giraudet
1988Fi04	NUPAB	484,	117	L.K. Fifield, R. Chapman, J.L. Durell, J.N. Mo, R.J. Smith, P.J. Woods, B.R. Fulton, R.A. Cunningham, P.V. Drumm
1988Fo05	PYLBB	209,	173	B. Fogelberg, Ye Zongyuan, L. Spanier
1988Fu10	JUPSA	57,	2976	Y. Fukuchi, T. Komatsubara, H. Sakamoto, T. Aoki, K. Furuno
1988Gi04	PRVCA	37,	2600	M. Girod, Ph. Dessagne, M. Bernas, M. Langevin, F. Pougheon, P. Roussel
1988Gr30	RAACA	43,	223	K.E. Gregorich, R.A. Henderson, D.M. Lee, M.J. Nurmia, R.M. Chasteler, H.L. Hall, D.A. Bennett, C.M. Gannett, R.B. Chadwick, J.D. Leyba, D.C. Hoffman, G. Herrmann
1988Ho.B	VHDPG	6,	67	S. Hofmann, P. Armbruster, G. Berthes, F. Heßberger, G. Münzenberg, K. Poppensieker, T. Faestermann, A. Gillitzer, W. Kurcewicz, I. Zychor
1988Hu07	ZPAAD	330,	121	M. Huyse, P. del Marmol, E. Coenen, K. Deneffe, P. Van Duppen, J. Vanhorenbeeck
1988Ka14	ZPAAD	330,	55	T. Karlewski, N. Hildebrand, M. Brügger, N. Kaffrell, N. Trautmann, G. Herrmann

1988Ka32	JUPSA	57,	2873	H. Kawakami, S. Kato, F. Naito, K. Nisimura, T. Ohshima, S. Shibata, T. Suzuki, K. Ukai, N. Morikawa, N. Nogawa, T. Nagafuchi, H. Taketani, M. Iwahashi, K. Hisatake, Y. Fukushima, T. Matsuda, T. Taniguchi
1988Ke03	ZPAAD	330,	37	B.D. Kern, R.L. Mlekodaj, M.O. Kortelahti, R.A. Braga, R.W. Fink
1988Ke09	CJPHA	66,	947	T.J. Kennett, W.V. Prestwich, J.S. Tsai
1988Ku14	NUPAB	484,	264	T. Kuroyanagi, S. Mitarai, B.J. Min, H. Tomura, Y. Haruta, K. Heiguchi, S. Sue-matsu, Y. Onizuka
1988Ma.A	P-BadHonnet		391	H. Mach, E.K. Warburton, R.L. Gill, R.F. Casten, A. Wolf, Z. Berant, J.A. Winger, K. Sistemich, G. Molnár, S.M. Yates
1988Me.A	Th.-Mainz			R. Menges, et al, and 89Ot.1
1988Mi13	PRVCA	38,	895	L.W. Mitchell, P.H. Fisher
1988Mo18	PRVCA	38,	737	M.F. Mohar, E. Adamides, W. Benenson, C. Bloch, B.A. Brown, J. Clayton, E. Kashy, M. Lowe, J.A. Nolen, Jr., W.E. Ormand, J. van der Plicht, B. Sherrill, J. Stevenson, J.S. Winfield
1988Ni02	PRVCA	37,	2694	J.M. Nitschke, P.A. Wilmarth, J. Gilat, K.S. Toth, F.T. Avignone III
1988No02	PRVCA	37,	860	E.B. Norman, K.T. Lesko, A.E. Champagne
1988Or01	NUPAB	477,	523	N.A. Orr, W.N. Catford, L.K. Fifield, T.R. Ophel, D.C. Weisser, C.L. Woods and erratum Nucl. Phys. A485(1988)734.
1988Or.A	Th.-Canberra			N.A. Orr
1988Qu.A	AnRpt GSI		16	A.B. Quint, W. Morawek, K.-H. Schmidt, P. Armbruster, F.P. Heßberger, S. Hofmann, G. Müntenberg, W. Reisdorf, H. Stelzer, H.-G. Clerc, C.-C. Sahn
1988Sa06	ZPAAD	329,	169	H. Salewski, W.-D. Schmidt-Ott
1988Sa18	PRVCA	37,	2371	J.-L. Salicio, S. Drissi, M. Gasser, J. Kern, H.G. Börner, G.G. Colvin, K. Schreckenbach, R.W. Hoff, R.W. Loughheed
1988Sc.A	VHDPG	6,	113	D. Schardt, R. Barden, R. Kirchner, O. Klepper, E. Roeckl, P. Kleinheinz, B. Rubio, A. Huck, G. Walter
1988Si22	JUPSA	57,	3762	K. Singh, T.S. Gill, K. Singh
1988St.A	P-BadHonnet		239	M.L. Stolzenwald, S. Brant, H. Ohm, K. Sistemich, G. Lhersonneau
1988Vi02	PRVCA	38,	1509	K.S. Vierinen, A.A. Shihab-Eldin, J.M. Nitschke, P.A. Wilmarth, R.M. Chasteler, R.B. Firestone, K.S. Toth
1988Wi05	ZPAAD	329,	503	P.A. Wilmarth, J.M. Nitschke, K. Vierinen, K.S. Toth, M. Kortelahti
1988Wo02	NUPAB	476,	392	C.L. Woods, W.N. Catford, L.K. Fifield, N.A. Orr, R.J. Sadleir
1988Wo07	NUPAB	484,	145	C.L. Woods, W.N. Catford, L.K. Fifield, N.A. Orr
1988Wo09	ZPAAD	331,	229	J.M. Wouters, R.H. Kraus, Jr., D.J. Vieira, G.W. Butler, K.E.G. Lobner
1989				
1989A133	IANFA	53,	2089	G.D. Alkhozov, B.N. Belyayev, V.D. Domkin, Yu. G. Korobulin, V.V. Lukashevich, V.S. Mukhin
1989An13	YAFIA	50,	619	A.N. Andreyev, D.D. Bogdanov, A.V. Yerimin, A.P. Kabachenko, O.A. Orlova, G.M. Ter-Akopian, V.I. Chepigin
1989An.A	P-Dubna		508	A.N. Andreyev, D.D. Bogdanov, V.I. Chepigin, A.P. Kabachenko, O.A. Orlova, S. Sharo, G.M. Ter-Akopian, A.V. Yeremin, and 89An13
1989Ay.A	P-Dubna		427	J. Äystö, P. Dendooven, P. Jauho, A. Jokinen, J. Parmonen, H. Penttilä, P. Taskinen, M. Leino, K. Eskola
1989Ba22	PYLBB	223,	273	A.S. Barabash, V.V. Kuzminov, V.M. Lobashev, V.M. Novikov, B.M. Ovchinnikov, A.A. Pomansky
1989Ba28	PRVCA	40,	940	S.C. Baker, M.J. Brown, P.H. Barker
1989Ba42	NUPAB	500,	1	E.L. Bakkum, C. van der Leun
1989Bo.A	PrvCom	GAu	Dec	H.G. Bohlen
1989Bu09	ZPAAD	333,	131	D.G. Burke, H. Folger, H. Gabelmann, E. Hagebø, P. Hill, P. Hoff, O. Jonsson, N. Kaffrell, W. Kurcewicz, G. Løvhøiden, K. Nybø, G. Nyman, H. Ravn, K. Riisager, J. Rogowski, K. Steffensen, T.F. Thorsteinsen, ISOLDE
1989Bu.A	Th.-Bordeaux			J. Busto PrvCom of F. Leccia 1988
1989Ca25	NUPAB	503,	263	W.N. Catford, L.K. Fifield, N.A. Orr, C.L. Woods
1989Ch01	PRVCA	39,	248	A.E. Champagne, R.T. Kouzes, A.B. McDonald, M.M. Lowry, D.R. Benton, K.P. Coulter, Z.Q. Mao
1989CI02	NUPAB	493,	293	E.T.H. Clifford, E. Hagberg, J.C. Hardy, H. Schmeing, R.E. Azuma, H.C. Evans, V.T. Koslowsky, U.J. Schrewe, K.S. Sharma, I.S. Towner

1989Dr03	NUPAB	496,	530	P.V. Drumm, L.K. Fifield, R.A. Bark, M.A.C. Hotchkis, C.L. Woods
1989Fi01	PRVCA	39,	219	R.B. Firestone, J.M. Nitschke, P.A. Wilmarth, K. Vierinen, J. Gilat, K.S. Toth, Y.A. Akovali
1989Gr03	NUPAB	491,	373	M. Graefenstedt, U. Keyser, F. Münnich, F. Schreiber, ISOLDE
1989Gr23	ZPAAD	334,	239	M. Graefenstedt, P. Jürgens, U. Keyser, F. Münnich, F. Schreiber, K. Balog, T. Winkelmann, H.R. Faust
1989Gu03	ZPAAD	332,	189	D. Guillemaud-Mueller, Y.E. Penionzhkevich, R. Anne, A.G. Artukh, D. Bazin, V. Borrel, C. Détraz, D. Guerreau, B.A. Gvozdev, J.C. Jacmart, D.X. Jiang, A.M. Kalinin, V.V. Kamanin, V.B. Kutner, M. Lewitowicz, S.M. Lukyanov, A.C. Mueller, N. Hoai Chau, F. Pougheon, A. Richard, M.G. Saint-Laurent, W.D. Schmidt-Ott (see also 93Po.A)
1989Ha27	NUPAB	500,	90	Y. Hatsukawa, T. Ohtsuki, K. Sueki, H. Nakahara, I. Kohno, M. Magara, N. Shinohara, H.L. Hall, R.A. Henderson, C.M. Gannett, J.A. Leyba, R.B. Chadwick, K.E. Gregorich, D. Lee, M.J. Nurmia, D.C. Hoffman
1989Ha.A	PENUC	III,	99	J.C. Hardy, E. Hagberg
1989He03	NIMAE	274,	522	F.P. Heßberger, S. Hofmann, G. Münzenberg, K.-H. Schmidt, P. Armbruster, R. Hingmann
1989He11	NUPAB	494,	1	D.W. Hetherington, A. Alousi, R.B. Moore
1989He13	ZPAAD	333,	111	F.P. Heßberger, H. Gäggeler, P. Armbruster, W. Brüchle, H. Folger, S. Hofmann, D. Jost, J.V. Kratz, M.E. Leino, G. Münzenberg, V. Ninov, M. Schädel, U. Scherer, K. Sümmerer, A. Türler, D. Ackermann
1989Hi04	NUPAB	492,	237	T. Hild, W.-D. Schmidt-Ott, V. Freystein, F. Meissner, E. Runte, H. Salewski, R. Michaelsen
1989Ho08	ZPAAD	332,	407	P. Hoff, B. Ekström, B. Fogelberg PrvCom of L. Spanier et al to ref.
1989Ho12	ZPAAD	333,	107	S. Hofmann, P. Armbruster, G. Berthes, T. Faestermann, A. Gillitzer, F.P. Heßberger, W. Kurcewicz, G. Münzenberg, K. Poppensieker, H.J. Schött, I. Zychor
1989Ho13	NUPAB	496,	462	J. Honkanen, V. Kopenon, P. Taskinen, J. Aysto, K. Eskola, S. Messelt, K. Ogawa
1989Ho15	NUPAB	500,	111	C. Hofmeyr
1989Hu03	PRVCA	39,	997	H. Huck, A. Jech, G. Marti, M.L. Perez, J.J. Rossi, H.M. Sofia
1989Je07	NUPAB	503,	77	C. Jeanperrin, L.H. Rosier, B. Ramstein, E.I. Obiajunwa
1989Jo.A	AnRpt JYFL		81	A. Jokinen, J. Äystö, C.N. Davids, K. Eskola, P. Jauho, M. Leino, J.M. Parnonen, H. Penttilä, P. Taskinen
1989Ka04	PRVCA	39,	818	S. Kato, S. Kubono, M.H. Tanaka, M. Yasue, T. Nomura, Y. Fuchi, S. Ohkawa, T. Miyachi, K. Iwata, T. Suehiro, Y. Yoshida
1989Ki11	NUPAB	496,	429	S.W. Kikstra, C. van der Leun, S. Raman, E.T. Journey, I.S. Towner
1989Ko07	ZPAAD	332,	229	M.O. Kortelahti, H.K. Carter, R.A. Braga, R.W. Fink, B.D. Kern
1989Ko22	ZPAAD	333,	339	V. Kopenon, J. Äystö, J. Honkanen, P. Jauho, H. Penttilä, J. Suhonen, P. Taskinen, K. Rykaczewski, J. Żylicz, C.N. Davids
1989Ku08	NUPAB	494,	203	H. Kudo, T. Nomura, K. Sueki, M. Magara, N. Yoshida
1989Lo07	NUPAB	494,	157	G. Løvghøiden, T.F. Thorsteinsen, E. Andersen, M.F. Kiziltan, D.G. Burke
1989Ma05	JPGPE	15,	173	A.M. Mandal, S.K. Saha, S.M. Sahakundu, A.P. Patro
1989Me02	ZPAAD	332,	153	F. Meissner, W.-D. Schmidt-Ott, V. Freystein, T. Hild, E. Runte, H. Salewski, R. Michaelsen
1989Mi03	PRVCA	39,	992	Ch. Miehé, Ph. Dessagne, P. Baumann, A. Huck, G. Klotz, A. Knipper, G. Walter, G. Marguier
1989Mi16	NUPAB	501,	437	S. Michaelsen, Ch. Winter, K.P. Lieb, B. Krusche, S. Robinson, T. von Egidy
1989Mi17	NUPAB	501,	557	H. Miyatake, T. Nomura, S. Kubono, J. Tanaka, M. Oyaizu, H. Okawa, N. Ikeda, K. Sueki, H. Kudo, K. Morita, T. Shinozuka
1989Mi.A	P-Dubna		66	V.L. Mikheev, et al
1989Mu09	ZPAAD	333,	163	G. Münzenberg, P. Armbruster, S. Hofmann, F.P. Heßberger, H. Folger, J.G. Keller, V. Ninov, K. Poppensieker, A.B. Quint, W. Reisdorf, K.-H. Schmidt, J.R.H. Schneider, H.J. Schött, K. Sümmerer, I. Zychor, M.E. Leino, D. Ackermann, U. Gollerthan, E. Hanelt, W. Morawek, D. Vermeulen, Y. Fujita, T. Schwab
1989Mu16	NUPAB	502,	571	G. Münzenberg
1989Ok.A	NEANDC(J)-140/U			K. Okano, Y. Kawase
1989Or03	NUPAB	491,	443	N.A. Orr, W.N. Catford, L.K. Fifield, M.A.C. Hotchkis, T.R. Ophel, D.C. Weisser, C.L. Woods

1989Or04	NUPAB	491,	457	N.A. Orr, L.K. Fifield, W.N. Catford, C.L. Woods
1989Ot.A	THISc	8,	517	E.W. Otten
1989Po09	NUPAB	499,	495[184Ir] M.G. Porquet, C. Bourgeois, P. Kilcher, B. Roussière, J. Sauvage, H. Dautet, J.K.P. Lee, ISOCELE
1989Po10	NUPAB	500,	287	F. Pougheon, V. Borrel, J.C. Jacmart, R. Anne, C. Détraz, D. Guillemaud-Mueller, A.C. Mueller, D. Bazin, R. Del Moral, J.P. Dufour, F. Hubert, M.S. Pravikoff, G. Audi, E. Roeckl, B.A. Brown
1989Pr.A	PENUC	II,	205	P.B. Price, S.W. Barwick
1989Re04	PRVCA	40,	368	A. Redondo, R.G.H. Robertson
1989Re.A	P-Miami			P.L. Reeder, et al
1989Ri03	NUPAB	499,	221	R. Richter, I. Förster, A. Gelberg, A.M.I. Haque, P. von Brentano, R.F. Casten, H.G. Börner, G.G. Colvin, K. Schreckenbach, G. Barreau, S.A. Kerr, H.H. Schmidt, P. Hungerford, H.J. Scheerer, T. von Egidy, R. Rascher
1989Ry02	ZPAAD	332,	275	K. Rykaczewski, A. Płochocki, I.S. Grant, H. Gabelmann, R. Barden, D. Schardt, J. Żylicz, G. Nyman, ISOLDE
1989Sa01	JPGPE	15,	73	S.K. Saha, S.M. Sahakundu
1989Sa11	NUPAB	494,	36	S.L. Sakharov, I.A. Kondurov, Yu. E. Loginov, V.V. Martynov, A.A. Radionov, P.A. Sushkov, Yu. L. Khazov, A.I. Egorov, V.K. Isupov, H.G. Börner, F. Hoyler, S. Kerr, K. Schreckenbach, G. Hlawatsch, T. von Egidy, H. Lindner
1989Sc24	NUPAB	501,	86	H. Schölermann, R. Böttger
1989Sc31	NUPAB	504,	1	H.H. Schmidt, P. Hungerford, T. von Egidy, H.J. Scheerer, H.G. Börner, S.A. Kerr, K. Schreckenbach, F. Hoyler, G.G. Colvin, A.M. Bruce, R.F. Casten, D.D. Warner, I.L. Kugava, V.A. Bondarenko, N.D. Kramer, P.T. Prokofjef, A. Chalupka
1989Sc.A	NDSAA	57,	515	M.R. Schmorak
1989Sh10	NIMAE	275,	123	K.S. Sharma, H. Schmeing, H.C. Evans, E. Hagberg, J.C. Hardy, V.T. Koslowsky
1989Si04	PRVDA	39,	1825	J.J. Simpson, A. Hime
1989Sm06	SAPHD	12,	74	J.J.A. Smit, Z.H.J. Pretorius, F.B. Waanders, J.P.L. Reinecke, J. Keilonen
1989St05	PRVCA	39,	1503	S.T. Staggs, R.G.H. Robertson, D.L. Wark, P.P. Nguyen, J.F. Wilkerson, T.J. Bowles
1989St06	PRVCA	39,	1963	C.A. Stone, S.H. Faller, W.B. Walters
1989Su.A	BAPSA	34,	1819	B. Sur, E.B. Norman, K.T. Lesko, E. Browne, R.M. Larimer, H.L. Hall, J.D. Leyba, D.C. Hoffman
1989Ta11	ZPAAD	333,	29	J.L. Tain, B. Rubio, P. Kleinheinz, D. Schardt, R. Barden, J. Blomqvist
1989To01	PRVCA	39,	1150	K.S. Toth, D.M. Moltz, J.D. Robertson
1989Vi02	PRVCA	39,	1972	K.S. Vierinen, J.M. Nitschke, P.A. Wilmarth, R.M. Chasteler, A.A. Shihab-Eldin, R.B. Firestone, K.S. Toth, Y.A. Akovali
1989Vi04	NUPAB	499,	1	K.S. Vierinen, J.M. Nitschke, P.A. Wilmarth, R.B. Firestone, J. Gilat
1989Wa10	PRVCA	39,	1647	S. Wang, D. Snowden-Ifft, P.B. Price, K.J. Moody, E.K. Hulet
1989Wi01	ZPAAD	332,	33	G. Winter, J. Döring, L. Funke, L. Kaubler, R. Schwengner, H. Prade
1989Wi05	NUPAB	491,	395	Ch. Winter, B. Krusche, K.P. Lieb, S. Michaelsen, G. Hlawatsch, H. Linder, T. von Egidy, F. Hoyler, R.F. Casten
1989Yu01	PRVCA	39,	256	S. Yuan, T. Zhang, S. Xu, W. Li, L. Zhang, M. Liu, X. Ou, W. Li
1989Zh04	PRVCA	39,	1985	Z. Zhao, M. Gai, B.J. Lund, S.L. Rugari, D. Mikolas, B.A. Brown, J.A. Nolen, Jr., M. Samuel
1989Zl.A	PrvCom	GAu	May	I. Žilimen
1990				
1990Aj01	NUPAB	506,	1	F. Ajzenberg-Selove, and PrvCom AHW
1990Ak01	PRVCA	41,	1126	Y.A. Akovali, K.S. Toth, A.L. Goodman, J.M. Nitschke, P.A. Wilmarth, D.M. Moltz, M.N. Rao, D.C. Sousa
1990Ak04	PRVCA	42,	1130	Y.A. Akovali, K.S. Toth, C.R. Bingham, M.B. Kassim, M. Zhang, H.K. Carter, W.D. Hamilton, J. Kormicki
1990Am04	PZETA	51,	607	A.I. Amelin, M.G. Gornow, Yu. B. Gurov, A.I. Ilin, V.P. Koplev, P.V. Morokhov, K.O. Oganessian, V.A. Pechkurov, V.I. Saveliev, E.M. Sergeev, B.A. Chern'yshev, R.R. Shafigulin, A.V. Shishkov

1990Am05	YAFIA	52,	1231	A.I. Amelin, M.G. Gornov, Y.B. Gurov, A.L. Il'in, P.V. Morokhov, V.A. Pechkurov, V.I. Savelev, F.M. Sergeev, S.A. Smirnov, B.A. Chernyshev, R.R. Shafigullin, A.V. Shishkov
1990An19	ZPAAD	337,	229	A.N. Andreyev, D.D. Bogdanov, V.I. Chepigin, A.P. Kabachenko, S. Sharo, G.M. Ter-Akopian, A.V. Yeremin
1990An22	ZPAAD	337,	231	A.N. Andreyev, D.D. Bogdanov, V.I. Chepigin, A.P. Kabachenko, S. Sharo, G.M. Ter-Akopian, A.V. Yeremin, O.N. Malyshev
1990An31	JRNCD	142,	203	R.A. Anderl, R.C. Greenwood
1990Be.A	PrvCom	AHW	Jun	C.E. Bemis
1990Be.B	P-Leningrad		132	E.A. Belomytseva, G.V. Veselov, K.A. Mezilev, Yu. N. Novikov, A.G. Polyakov, A.V. Popov, Yu. Ya. Sergeev, V.A. Sergienko, V.I. Tichonov
1990Bo24	NUPAB	515,	21	M.J.G. Borge, H. Gabelmann, L. Johannsen, B. Jonson, G. Nyman, K. Riisager, O. Tengblad, ISOLDE
1990Bo39	YAFIA	52,	358	D.D. Bogdanov, V.P. Bugrov, S.G. Kadmenskiĭ
1990Bo52	IANFA	54,	1787	S.T. Boneva, E.V. Vasileva, V.D. Kulik, L.K. Khem, Yu. P. Popov, A.M. Sukhovi, V.A. Khitrov, Yu. V. Kholnov
1990Bu17	PRVCA	42,	499	D.G. Burke, P.E. Garrett, Tao Qu, R.A. Naumann
1990Bu28	YAFIA	52,	305	E. Bukhner, I.N. Vishnevsky, F.A. Danevich, Yu. G. Zdesenko, H.V. Klapdor, B.N. Kropivnyansky, V.N. Kuts, A. Piepke, V.I. Tretyak, G. Heusser, J. Schneider, H. Strecker
1990Ch34	PRVCA	42,	1171	R.M. Chasteler, J.M. Nitschke, R.B. Firestone, K.S. Vierinen, P.A. Wilmarth
1990Ch37	PRVCA	42,	1796	R.M. Chasteler, J.M. Nitschke, R.B. Firestone, K.S. Vierinen, P.A. Wilmarth
1990De43	NUPAB	519,	529	C. Détraz, R. Anne, P. Bricault, D. Guillemaud-Mueller, M. Lewitowicz, A.C. Mueller, Yu Hu Zhang, V. Borrel, J.C. Jacmart, F. Pougheon, A. Richard, D. Bazin, J.P. Dufour, A. Fleury, F. Hubert, M.S. Pravikoff
1990Dy04	PYLBB	245,	343	G.R. Dyck, M.H. Sidky, J.G. Hykawy, C.A. Lander, K.S. Sharma, R.C. Barber, H.E. Duckworth
1990En02	NUPAB	510,	209	P.M. Endt, C. Alderliesten, F. Zijderhand, A.A. Wolters, A.G.M. van Hees
1990En08	NUPAB	521,	1	P.M. Endt
1990Fa03	PHSTB	41,	652	B. Fant, T. Weckstrom, A. Kallberg
1990Fo07	ZPAAD	337,	251	B. Fogelberg, Y. Zongyuan, B. Ekström, E. Lund, K. Aleklett, L. Sihver
1990Ge12	ZDACE	17,	119	Ch. Gerz, D. Wilsdorf, G. Werth
1990Gr10	ZPAAD	336,	247	M. Graefenstedt, P. Jürgens, U. Keyser, F. Münnich, F. Schreiber, K. Balog, T. Winkelman, H.R. Faust, B. Pfeiffer
1990Ha02	PRVCA	41,	618	H.L. Hall, K.E. Gregorich, R.A. Henderson, C.M. Gannett, R.B. Chadwick, J.D. Leyba, K.R. Czerwinski, B. Kadkhodayan, S.A. Kreek, D.M. Lee, M.J. Nurmia, D.C. Hoffman, C.E.A. Palmer, P.A. Baisden
1990He11	PRVCA	41,	2325	M. Hellström, B. Fogelberg, L. Spanier, H. Mach
1990Ho02	PRVCA	41,	484	R.W. Hoff, S. Drissi, J. Kern, W. Strassmann, H.G. Börner, K. Schreckenbach, G. Barreau, W.D. Ruhter, L.G. Mann, D.H. White, J.H. Landrum, R.J. Dupzyk, R.F. Casten, W.R. Kane, D.D. Warner
1990Ho03	PRVCA	41,	631	D.C. Hoffman, D.M. Lee, K.E. Gregorich, M.J. Nurmia, R.B. Chadwick, K.B. Chen, K.R. Czerwinski, C.M. Gannett, H.L. Hall, R.A. Henderson, B. Kadkhodayan, S.A. Kreek, J.D. Leyba
1990Ho10	NUPAB	512,	189	F. Hoyler, J. Jolie, G.G. Colvin, H.G. Börner, K. Schreckenbach, P. Van Isacker, P. Fettweis, H. Göktürk, J.C. Dehaes, R.F. Casten, D.D. Warner, A.M. Bruce
1990Is02	PRVCA	41,	1272	M.A. Islam, T.J. Kennett, W.V. Prestwich
1990Is03	ZPAAD	335,	173	M.A. Islam, T.J. Kennett, W.V. Prestwich
1990Is06	ZPAAD	335,	243	M.C.P. Isaac, V.R. Vanin, O.A.M. Helene
1990Is07	PRVCA	42,	207	M.A. Islam, T.J. Kennett, W.V. Prestwich
1990Is09	CJPHA	68,	1237	M.A. Islam, T.J. Kennett, W.V. Prestwich
1990Ka01	PRVCA	41,	1276	S. Kato, S. Kubono, M.H. Tanaka, M. Yasue, T. Nomura, Y. Fuchi, Y. Funatsu, S. Ohkawa, T. Miyachi, K. Iwata, T. Suehiro, Y. Yoshida, O. Nitoh
1990Ka10	PRVCA	41,	2004	S. Kato, S. Kubono, T. Nomura, Y. Fuchi, Y. Funatsu, S. Ohkawa, T. Miyachi, T. Suehiro, Y. Yoshida
1990Ka19	PRVCA	42,	563	S. Kato, S. Kubono, M.H. Tanaka, T. Nomura, Y. Fuchi, Y. Funatsu, S. Ohkawa, T. Miyachi, T. Suehiro, Y. Yoshida
1990Ka21	NUPAB	514,	173	A. Kaerts, P.H.M. van Assche, S.A. Kerr, F. Hoyler, H.G. Börner, R.F. Casten, D.D. Warner

1990Ka27	PRVCA	42,	1918	S. Kato, S. Kubono, M.H. Tanaka, M. Yasue, Y. Fuchi, Y. Funatsu, S. Ohkawa, T. Miyashi, T. Suehiro, Y. Yoshida
1990Ki07	NUPAB	512,	425	S.W. Kikstra, C. van der Leun, P.M. Endt, J.G.L. Booten, A.G.M. van Hees, A.A. Wolters
1990Ko25	PRVCA	42,	1267	M.O. Kortelahti, B.D. Kern, R.A. Braga, R.W. Fink, I.C. Girit, R.L. Mlekodaj
1990Le03	ZPAAD	335,	117	M. Lewitowicz, R. Anne, A.G. Artukh, D. Bazin, A.V. Belozyorov, P. Bricault, C. Détraz, D. Guillemaud-Mueller, J.C. Jacmart, E. Kashy, A. Latimier, S.M. Lukyanov, A.C. Mueller, Yu. E. Penionzhkevich, F. Pougheon, A. Richard, W.D. Schmidt-Ott, Y. Zhang
1990Li14	NUCIA	103,	553	Sr. Little Flower, B.R.S. Babu, P. Venkataramaiah, H. Sanjeeviah
1990Li40	NIMAE	297,	217	H. Lindner, H. Trieb, T. von Egidy, H. Hiller, J. Klora, U. Mayerhofer, A. Walter, A.H. Wapstra
1990Ma03	PRVCA	41,	226	H. Mach, E.K. Warburton, R.L. Gill, R.F. Casten, J.A. Becker, B.A. Brown, J.A. Winger
1990Me08	PRVCA	41,	2921	J.T. Meek, W.G. Millen, G.W. Stockton, R.T. Kouzes
1990Mu06	NUPAB	513,	1	A.C. Mueller, D. Guillemaud-Mueller, J.C. Jacmart, E. Kashy, F. Pougheon, A. Richard, A. Staudt, H.V. Klapdor-Kleingrothaus, M. Lewitowicz, R. Anne, P. Bricault, C. Détraz, Yu. E. Penionzhkevich, A.G. Artukh, A.V. Belozyorov, S.M. Lukyanov, D. Bazin, W.D. Schmidt-Ott
1990Ne.A	PrvCom		Gizon	R. Neugart
1990Ne.B	P-Monterey			Zs. Netmeth, Karlsruhe
1990Ni05	ZPAAD	336,	473	V. Ninov, F.P. Heßberger, P. Armbruster, S. Hofmann, G. Münzenberg, M. Leino, Y. Fujita, D. Ackermann, W. Morawek, A. Lüttgen
1990Og01	PYLBB	235,	35	A.A. Ogloblin, N.I. Venikov, S.K. Lisin, S.V. Pirozhkov, V.A. Pchelin, Yu. F. Rodionov, V.M. Semochkin, V.A. Shabrov, I.K. Shvetsov, V.M. Shubko, S.P. Tretyakova, V.L. Mikheev
1990Pi05	NUPAB	510,	301	Š. Piskoř, W. Schäferlingová
1990Po13	IANFA	54,	852	A.V. Potempa, V.P. Afanasjev, Ya. Vavryshchuk, K. Ya. Gromov, V.G. Kalinikov, N. Yu. Kovotskii, V.V. Kuznetsov, M. Lewandowski, Ya. A. Saidimov, M. Yakhim, Zh. Sereter, V.I. Fominykh, V. Charnadski, Yu. V. Yushkevich, M. Yanistki, A. Yasinski
1990Pr02	CJPHA	68,	261	W.V. Prestwich, T.J. Kennett, and erratum CJPHA 68,1352
1990Re08	ZPAAD	336,	381	G. Reusen, V.R. Bom, P. Decroock, P. Dendooven, M. Huyse, R.W. Hollander, P. Van Duppen, J. Vanhorenbeeck, J. Wauters
1990Sa32	ZPAAD	337,	161	H. Salewski, K. Becker, W.-D. Schmidt-Ott, T. Hild, F. Meissner, E. Runte, R. Michaelsen
1990Sa.A	Th.-Gottingen			H. Salewski
1990Se17	FZKAA	22,	183	H. Seyfarth, H.H. Guven, B. Kardon, G. Lhersonneau, K. Sistemich, S. Brant, N. Kaffrell, P. Maier-Komor, H.K. Vonach, V. Paar, D. Vorkapic, R.A. Meyer
1990Sh15	IMPAE	5,	2821	R.K. Sheline, C.F. Liang, P. Paris
1990Sh.A	AnRpt LBL		114	A.A. Shihab-Eldin, P.A. Wilmarth, K.S. Vierinen, J.M. Nitschke, R.M. Chasteler, R.B. Firestone
1990So08	PRAMC	35,	329	P.C. Sood, R.K. Sheline
1990St13	ZPAAD	336,	369	U. Stöhlker, A. Blönnigen, W. Lippert, H. Wollnik
1990St25	PRLTA	65,	3104	H. Stolzenberg, St. Becker, G. Bollen, F. Kern, H.-J. Kluge, Th. Otto, G. Savard, L. Schweikhard, G. Audi, R.B. Moore
1990Tu01	ZPAAD	337,	361	X.L. Tu, X.G. Zhou, D.J. Vieira, J.M. Wouters, Z.Y. Zhou, H.L. Seifert, V.G. Lind
1990Wa22	NIMAE	292,	671	A.H. Wapstra
1990We01	PRVCA	41,	778	D. Weselka, P. Hille, A. Chalupka
1990Wi12	PRVCA	42,	954	J.A. Winger, J.C. Hill, F.K. Wahn, E.K. Warburton, R.L. Gill, A. Piotrowski, R.B. Schuhmann, D.S. Brenner
1990Zh.A	GANIL-T-9002			Y.H. Zhang
			1991	
1991Aj01	NUPAB	523,	1	F. Ajzenberg-Selove
1991An10	ZPAAD	338,	363	A.N. Andreyev, D.D. Bogdanov, V.I. Chepigin, A.P. Kabachenko, O.N. Malyshev, G.M. Ter-Akopian, A.V. Yeremin

1991Ba06	NUPAB	523,	261	M.K. Balodis, N.D. Kramer, P.T. Prokofjev, A.V. Afanasjev, T.V. Guseva, J.J. Tambergs, K. Schreckenbach, W.F. Davidson, D.D. Warner, J.A. Pinston, P.H.M. van Assche, A.M.J. Spits
1991Be25	NUPAB	533,	113	A. Ben Braham, C. Bourgeois, P. Kilcher, F. Le Blanc, B. Roussière, J. Sauvage, A.J. Kreiner, M.G. Porquet, ISOCELE
1991Bi04	PRVCA	44,	1208	C.R. Bingham, M.B. Kassim, M. Zhang, Y.A. Akovali, K.S. Toth, W.D. Hamilton, H.K. Carter, J. Kormicki, J. von Schwarzenberg, M.M. Jarrio
1991BI05	PRVCA	44,	325	S. Blagus, D. Miljanic, M. Zadro, G. Calvi, M. Lattuada, F. Riggi, C. Spitaleri, C. Blyth, O. Karban
1991Bo22	ZPAAD	339,	311	A. Bouldjedri, A. Astier, R. Béraud, R. Duffait, A. Emsallem, H. Haas, ISOLDE
1991Bo32	NUPAB	531,	353	V. Borrel, J.C. Jacmart, F. Pougheon, R. Anne, C. Détraz, D. Guillemaud-Mueller, A.C. Mueller, D. Bazin, R. Del Moral, J.P. Dufour, F. Hubert, M.S. Pravikoff, E. Roeckl
1991Bo35	NUPAB	534,	255	H.G. Börner, R.F. Casten, I. Förster, D. Lieberz, P. von Brentano, S.J. Robinson, T. von Egidy, G. Hlawatsch, H. Lindner, P. Geltenbort, F. Hoyler, H. Faust, G. Colvin, W.R. Kane, M. MacPhail
1991Bo.B	P-Niigata		83	H.G. Bohlen
1991Br17	ZPAAD	339,	495	T. Brohm, H.-G. Clerc, U. Gollerthan, W. Schwab, K.-H. Schmidt, R.S. Simon
1991Bu12	PRLTA	67,	2626	B. Budick, J. Chen, H. Lin
1991Du07	ZPAAD	341,	39	S.B. Dutta, R. Kirchner, O. Klepper, T.U. Kuhl, D. Marx, G.D. Sprouse, R. Menges, U. Dinger, G. Huber, S. Schroder
1991Fi03	PRVCA	43,	1066	R.B. Firestone, J. Gilat, J.M. Nitschke, P.A. Wilmarth, K.S. Vierinen
1991Go19	NUPAB	531,	613	M.G. Gornov, Yu. B. Gurov, P.V. Morokhov, V.A. Pechkurov, V.I. Savelyev, F.M. Sergeev, B.A. Chernyshev, R.R. Shafigullin, A.V. Shishkov, V.P. Koptev, K.O. Oganessian, B.P. Osipenco
1991Gr12	NUPAB	530,	401	J.C. Griffin, R.A. Braga, R.W. Fink, J.L. Wood, H.K. Carter, R.L. Mlekodaj, C.R. Bingham, E. Coenen, M. Huyse, P. Van Duppen
1991Gr13	PRVCA	44,	1728	V. Grafen, B. Ackermann, H. Baltzer, T. Bihn, C. Günther, J. de Boer, N. Gollwitzer, G. Graw, R. Hertenberg, H. Kader, A. Levon, A. Lösch
1991Ha31	EULEE	15,	491	D. Hagena, G. Werth
1991He04	ZPAAD	338,	7	K. Heiguchi, T. Hosoda, T. Komatsubara, T. Nomura, K. Furuno, R. Nakatani, S. Mitarai, T. Kuroyanagi
1991He21	ZPAAD	340,	225	F. Heine, T. Faestermann, A. Gillitzer, J. Homolka, M. Köpf, W. Wagner, see also 92He. A
1991Hi11	PRVCA	44,	1581	Y. Hirabayashi
1991Hi.A	AnRpt LBL		69	M.M. Hindi, K.L. Wedding, E.B. Norman, K.T. Lesko, B. Sur, R.-M. Larimer, M.T.F. da Cruz, K.R. Czerwinski
1991Ho05	JPGPE	17,	145	T.H. Hoare, P.A. Butler, G.D. Jones, M. Loiselet, O. Naviliat-Cuncic, J. Vervier, M. Dahlinger, A.M.Y. El-Lawindy, R. Wadsworth, D.L. Watson
1991Ho08	CZYPA	41,	525	J. Honzatko, K. Konecny, Z. Kosina
1991Hy01	PRLTA	67,	1708	J.G. Hykawy, J.N. Nxumalo, P.P. Unger, C.A. Lander, R.C. Barber, K.S. Sharma, R.D. Peters, H.E. Duckworth
1991Io02	NUPAB	531,	112	M. Ionescu-Bujor, A. Iordachescu, G. Pascovici
1991Is01	PRVCA	43,	1086	M.A. Islam, T.J. Kennett, W.V. Prestwich
1991Is02	CJPHA	69,	658	M.A. Islam, T.J. Kennett, W.V. Prestwich
1991Jo11	ZPAAD	340,	21	A. Jokinen, J. Äystö, P. Dendooven, K. Eskola, Z. Janas, P.P. Jauho, M.E. Leino, J.M. Parmonen, H. Penttilä, K. Rykaczewski, P. Taskinen
1991Ka41	PYLB	256,	105	H. Kawakami, S. Kato, T. Ohshima, S. Shibata, K. Ukai, N. Morikawa, N. Nogawa, K. Haga, T. Nagafuchi, M. Shigeta, Y. Fukushima, T. Taniguchi
1991Ke06	NIMAE	300,	67	H. Keller, R. Kirchner, O. Klepper, E. Roeckl, D. Schardt, R.S. Simon, P. Kleinheinz, C.F. Liang, P. Paris
1991Ke08	ZPAAD	339,	355	H. Keller, R. Barden, R. Kirchner, O. Klepper, E. Roeckl, D. Schardt, I.S. Grant, A. Plochocki, K. Rykaczewski, J. Szerypo, J. Żylicz, ISOLDE
1991Ke10	NUPAB	534,	77	J. Kern, A. Raemy, W. Beer, J.-Cl. Dousse, W. Schwitz, M.K. Balodis, P.T. Prokofjev, N.D. Kramer, L.I. Simonova, R.W. Hoff, D.G. Gardner, M.A. Gardner, R.F. Casten, R.L. Gill, R. Eder, T. von Egidy, E. Hagn, P. Hungerford, H.J. Scheerer, H.H. Schmidt, E. Zech, A. Chalupka, A.V. Murzin, V.A. Libman, I.V. Kononenko, C. Coceva, P. Giacobbe, I.A. Kondurov, Yu. E. Loginov, P.A. Sushkov, S. Brant, V. Paar

1991Ke11	ZPAAD	340,	363	H. Keller, R. Kirchner, O. Klepper, E. Roeckl, D. Schardt, R.S. Simon, P. Kleinheinz, R. Menegazzo, C.F. Liang, P. Paris, K. Rykaczewski, J. Żylicz, and Thesis H. Keller THD report GSI-91-6 February 1991
1991Ki04	NUPAB	529,	39	S.W. Kikstra, Z. Guo, C. van der Leun, P.M. Endt, S. Raman, T.A. Walkiewicz, J.W. Starnier, E.T. Jurney, I.S. Towner
1991Kl02	PRVCA	44,	2801	N. Klay, F. Kaeppler, H. Beer, G. Schatz, H. Börner, F. Hoyler, S.J. Robinson, K. Schreckenbach, B. Krusche, U. Mayerhofer, G. Hlawatsch, H. Lindner, T. von Egidy, W. Andrejtscheff, P. Petkov
1991Ko.A	P-Minsk		117	I.A. Kondurov, Yu. E. Loginov, P.A. Sushkov
1991Ko.B	P-Niigata		187	T. Kobayashi
1991Kr15	ZPAAD	340,	419	K.-L. Kratz, H. Gabelmann, P. Möller, B. Pfeiffer, H.L. Ravn, A. Wöhr, ISOLDE
1991Kr.A	AnRpt LBL		57	S.A. Kreek, et al
1991Le09	PRVCA	44,	336	M. Leino, P.P. Jauho, J. Aysto, P. Decrock, P. Dendooven, K. Eskola, M. Huyse, A. Jokinen, J.M. Parmonen, H. Penttilä, G. Reusen, P. Taskinen, P. Van Duppen, J. Wauters
1991Le15	ZPAAD	340,	107	M. Lewandowski, A.W. Potempa, V.I. Fominikh, K.Y. Gromov, M. Janicki, J.V. Juschkevich, V.G. Kalinnikov, N.J. Kotovskij, V.V. Kuznetsov, N. Raschkova, J.A. Sajdimov, J. Wawryszczuk
1991Ly01	PRVCA	44,	764	J.E. Lynn, E.T. Jurney, S. Raman
1991Ma65	ZPAAD	341,	1	U. Mayerhofer, T. von Egidy, J. Jolie, H.G. Börner, G. Colvin, S. Judge, B. Kruschke, S.J. Robinson, K. Schreckenbach, S. Brant, V. Paar
1991Me05	ZPAAD	339,	315	F. Meissner, W.-D. Schmidt-Ott, K. Becker, U. Bosch-Wicke, U. Ellmers, H. Salewski, R. Michaelsen
1991Mi08	ZPAAD	338,	371	S. Michaelsen, K.P. Lieb, S.J. Robinson
1991Mi15	NUPAB	530,	211	B.J. Min, S. Suematsu, S. Mitarai, T. Kuroyanagi, K. Heiguchi, M. Matsuzaki
1991No07	JPGPE	17,	s291	E.B. Norman, B. Sur, K.T. Lesko, M.M. Hindi, R.-M. Larimer, T.R. Ho, J.T. Witort, P.N. Luke, W.L. Hansen, E.E. Haller
1991Or01	PYLBB	258,	29	N.A. Orr, W. Mittag, L.K. Fifield, M. Lewitowicz, E. Plagnol, Y. Schutz, W.L. Zhan, L. Bianchi, A. Gillibert, A.V. Belozorov, S.M. Lukanov, Yu. E. Penionzhkevich, A.C.C. Villari, A. Cunsolo, A. Foti, G. Audi, C. Stephan, L. Tassan-Got, and PrvCom GAu December 1990, and erratum PYLBB 271(1991)468
1991Pa05	ZPAAD	338,	295	R.D. Page, P.J. Woods, S.J. Bennett, M. Freer, B.R. Fulton, R.A. Cunningham, J. Groves, M.A.C. Hotchkis, A.N. James
1991Pe04	ZPAAD	338,	291	H. Penttilä, J. Äystö, K. Eskola, Z. Janas, P.P. Jauho, A. Jokinen, M.E. Leino, J.M. Parmonen, P. Taskinen
1991Pe10	PRVCA	44,	935	H. Penttilä, P.P. Jauho, J. Äystö, P. Decrock, P. Dendooven, M. Huyse, G. Reusen, P. Van Duppen, J. Wauters
1991Ra01	PRVCA	43,	521	S. Raman, T.A. Walkiewicz, S. Kahane, E.T. Jurney, J. Sa, Z. Gacsi, J.L. Weil, K. Allaart, G. Bonsignori, J.F. Shriner, Jr.
1991Re02	PRVCA	44,	1435	P.L. Reeder, R.A. Warner, W.K. Hensley, D.J. Vieira, J.M. Wouters
1991Re.A	PrvCom	GAu	Sep	G. Reusen, M. Huyse
1991Ro07	PRLTA	67,	957	R.G.H. Robertson, T.J. Bowles, G.J. Stephenson, Jr., D.L. Wark, J.F. Wilkerson, D.A. Knapp
1991Ro.A	P-PacGrove		440	S.J. Robinson, H.G. Börner, S. Judge, J. Jolie, P. Schillebeeckx
1991Ry01	ADNDA	47,	205	A. Rytz
1991Sh19	PRVCA	44,	2439	K.S. Sharma, E. Hagberg, G.R. Dyck, J.C. Hardy, V.T. Koslowsky, H. Schmeing, R.C. Barber, S. Yuan, W. Perry, M. Watson
1991Su09	PRLTA	66,	2444	B. Sur, E.B. Norman, K.T. Lesko, M.M. Hindi, R.-M. Larimer, P.N. Luke, W.L. Hansen, E.E. Haller
1991To08	PRVCA	44,	1868	K.S. Toth, K.S. Vierinen, M.O. Kortelahti, D.C. Sousa, J.M. Nitschke, P.A. Wilmarth
1991To09	ZPAAD	340,	343	K.S. Toth, K.S. Vierinen, J.M. Nitschke, P.A. Wilmarth, R.M. Chasteler
1991Tu02	PRLTA	67,	3211	A.L. Turkevich, T.E. Economou, G.A. Cowan
1991Va04	NUPAB	529,	268	P. Van Duppen, P. Decrock, P. Dendooven, M. Huyse, G. Reusen, J. Wauters
1991Wa21	ZPAAD	339,	533	J. Wauters, P. Decrock, P. Dendooven, M. Huyse, G. Reusen, P. Van Duppen
1991Wa.A	PrvCom	AHW		A.H. Wapstra
1991Zh24	PYLBB	260,	285	X.G. Zhou, X.L. Tu, J.M. Wouters, D.J. Vieira, K.E.G. Lobner, H.L. Seifert, Z.Y. Zhou, G.W. Butler

1991ZI01	PRLTA	67,	560	I. Žilimen, A. Ljubičić, S. Kaučić, B.A. Logan
			1992	
1992A1.A	B-Bernkastel		PC2	D.V. Aleksandrov, Yu. A. Glukhov, E. Yu. Nikolskii, B.G. Novatskii, A.A. Ogloblin, D.N. Stepanov
1992A1.B	B-Bernkastel		PA6	G.D. Alkhozov, B.N. Belyaev, V.D. Domkin, Yu. G. Korobulin, V.V. Lukashevich, V.S. Mukhin, Yu. A. Suchilin, V.G. Khlopin
1992An04	ZPAAD	342,	123	A.N. Andreyev, D.D. Bogdanov, V.I. Chepigina, A.P. Kabachenko, O.N. Malyshev, R.N. Sagajdak, G.M. Ter-Akopian, A.V. Yeremin
1992An13	JRNCD	164,	303	M.S. Antony, D. Oster, A. Hachem
1992An.A	P-Bernkastel		759	A.N. Andreyev, D.D. Bogdanov, V.I. Chepigina, M. Florek, A.P. Kabachenko, O.N. Malyshev, S. Saro, G.M. Ter-Akopian, M. Veselsky, A.V. Yeremin
1992Ba01	PRVCA	45,	69	D. Bazin, R. Del Moral, J.P. Dufour, A. Fleury, F. Hubert, M.S. Pravikoff, R. Anne, P. Bricault, C. Détraz, M. Lewitowicz, Y. Zheng, D. Guillemaud-Mueller, J.C. Jacmart, A.C. Mueller, F. Pougheon, A. Richard
1992Ba28	ZPAAD	342,	125	K. Balog, M. Graefenstedt, M. Groß, P. Jürgens, U. Keyser, F. Münnich, T. Otto, F. Schreiber, T. Winkelmann, J. Wulff, ISOLDE
1992Ba.A	P-Bernkastel		777	P.H. Barker, S.A. Brindhaban
1992Be17	ZPAAD	341,	155	M.R. Beitins, S.T. Boneva, V.A. Khitrov, L.A. Malov, Y.P. Popov, P.T. Prokofjev, G.L. Rezvaya, L.I. Simonova, A.M. Sukhovoij, E.V. Vasilieva
1992Bo02	NUPAB	536,	260	R. Böttger, H. Schölermann
1992Bo05	NUPAB	539,	249	M.J.G. Borge, D.G. Burke, H. Gietz, P. Hill, N. Kaffrell, W. Kurcewicz, G. Løvhøiden, S. Mattsson, R.A. Naumann, K. Nybø, G. Nyman, T.F. Thorsteinson, ISOLDE
1992Bo28	JMOPE	39,	257	G. Bollen, H.-J. Kluge, Th. Otto, G. Savard, L. Schweikhard, H. Stolzenberg, G. Audi, R.B. Moore, G. Rouleau, ISOLDE, and PrvCom GAU November 1991
1992Bo37	ZPAAD	344,	135	V. Borrel, R. Anne, D. Bazin, C. Borcea, G.G. Chubarian, R. Del Moral, C. Détraz, S. Dogny, J.P. Dufour, L. Faux, A. Fleury, L.K. Fifield, D. Guillemaud-Mueller, F. Hubert, E. Kashy, M. Lewitowicz, C. Marchand, A.C. Mueller, F. Pougheon, M.S. Pravikoff, M.G. Saint-Laurent, O. Sorlin
1992Bo.B	PrvCom	AHW	Apr	R. Böttger
1992Bo.D	P-Bernkastel		743	V.A. Bolshakov, A.G. Dernjatin, K.A. Mezilev, Yu. N. Novikov, A.V. Popov, Yu. Ya. Sergeev, V.I. Tikhonov, V.A. Sergienko, G.V. Veselov
1992Br17	NUPAB	542,	1	A.M. Bruce, W. Gelletly, G.G. Colvin, P. Van Isacker, D.D. Warner
1992Bu10	ZPAAD	342,	403	D. Bucurescu, M.S. Rapaport, C.F. Liang, P. Paris, G. Cata-Danil
1992Bu12	NUPAB	550,	179	D.G. Burke, P.E. Garrett
1992Bu13	PRVCA	46,	1267	B. Budick, J. Chen, H. Lin
1992Ch09	PRVCA	45,	1720	W.-T. Chou, E.K. Warburton
1992Ch27	PRLTA	69,	3151	M. Chen, D.A. Imel, T.J. Radcliffe, H. Henrikson, F. Boehm
1992Co23	PYLBB	295,	143	E. Cosulich, G. Gallinaro, F. Gatti, S. Vitale
1992Cz.A	LBL-32		233	K.R. Czerwinski (thesis)
1992Da03	ARISE	43,	69	J. Dalmasso, G. Barci-Funel, G.J. Ardisson
1992Da14	ZPAAD	343,	161	B. Dasmahapatra, S. Bhattacharya
1992Do10	PRVCA	46,	2127	J. Döring, G. Winter, L. Funke, B. Cederwall, F. Lidén, A. Johnson, A. Atac, J. Nyberg, G. Sletten, M. Sugawara
1992Ga15	NUPAB	550,	1	P.E. Garret, D.G. Burke
1992Ge08	PRLTA	68,	3412	H. Geissel, K. Beckert, F. Bosch, H. Eickhoff, B. Franczak, B. Franzke, M. Jung, O. Klepper, R. Moshhammer, G. Münzenberg, F. Nickel, F. Nolden, U. Schaaf, C. Scheidenberger, P. Spädtke, M. Steck, K. Sümmerer, A. Magel
1992Go10	PRVCA	46,	833	J. Görres, M. Wiescher, K. Scheller, D.J. Morrissey, B.M. Sherrill, D. Bazin, J.A. Winger
1992Gr02	PRVCA	45,	1058	K.E. Gregorich, H.L. Hall, R.A. Henderson, J.D. Leyba, K.R. Czerwinski, S.A. Kreek, B.A. Khadkodayan, M.J. Nurmia, D.M. Lee, D.C. Hoffman
1992Gr06	NIMAE	311,	512	M. Groß, P. Jürgens, U. Keyser, S. Kluge, M. Mehrrens, S. Müller, F. Münnich, J. Wulff
1992Gr09	ZPAAD	341,	247	H. Grawe, P. Hoff, J.P. Omtvedt, K. Steffensen, R. Eder, H. Haas, H. Ravn, ISOLDE

1992Gr.A	P-Bernkastel		77	M. Groß, P. Jürgens, S. Kluge, M. Mehrstens, S. Müller, F. Münnich, J. Wulff, see also 87Gr18
1992Gu03	NUPAB	540,	117	Z. Guo, C. Alderliesten, C. van der Leun, P.M. Endt
1992Ha03	PRVCA	45,	900	F.X. Hartmann
1992Ha10	PRVCA	45,	1609	E. Hagberg, X.J. Sun, V.T. Koslowsky, H. Schmeing, J.C. Hardy
1992Ha15	NIMAE	313,	237	F.X. Hartmann, R.A. Naumann
1992Ha21	ZPAAD	343,	7	A. Harder, S. Michaelsen, A. Jungclaus, K.P. Lieb, A.P. Williams, H.G. Börner, M. Trautmannsheimer
1992Ha22	PRVCA	46,	1873	T.M. Hamilton, K.E. Gregorich, D.M. Lee, K.R. Czerwinski, N.J. Hannink, C.D. Kacher, B. Kadkhodayan, S.A. Kreek, M.J. Nurmia, M.R. Lane, M.P. Neu, A. Türler, D.C. Hoffman
1992He.A	P-Bernkastel		331	F. Heine, T. Faestermann, A. Gillitzer, H.J. Körner
1992Ho09	PYLBB	287,	381	E. Holzschuh, M. Fritschi, W. Kündig
1992Hu04	PRVCA	46,	1209	M. Huysse, P. Decrock, P. Dendooven, G. Reusen. P. Van Duppen, J. Wauters
1992Id01	ZPAAD	341,	427	N. Idrissi, A. Gizon, J. Genevey, P. Paris, V. Barci, D. Barnéoud, J. Blachot, D. Bucurescu, R. Duffait, J. Gizon, C.F. Liang, B. Weiss
1992Iv.A	Th-Pennsylvania			R.A. Ivie Master's Thesis
1992Jo05	NUPAB	549,	420	A. Jokinen, J. Äystö, P.P. Jauho, M. Leino, J.M. Parmonen, H. Penttilä, K. Eskola, Z. Janas
1992Ju01	PRLTA	69,	2164	M. Jung, F. Bosch, K. Beckert, H. Eickhoff, H. Folger, B. Franzke, A. Gruber, P. Kienle, O. Klepper, W. Koenig, C. Kozhuharov, R. Mann, R. Moshhammer, F. Nolden, U. Schaaf, G. Soff, P. Spädtke, M. Steck, T. Stöhlker, K. Sümmerner
1992Ka29	PYLBB	287,	45	H. Kawakami, S. Kato, T. Ohshima, C. Rosenfeld, H. Sakamoto, T. Sato, S. Shibata, J. Shirai, Y. Sugaya, T. Suzuki, K. Takahashi, T. Tsukamoto, K. Ueno, K. Ukai, S. Wilson, Y. Yonezawa
1992Ke06	PHSTB	46,	575	J. Kern, T. Engel, D. Hagen, G. Werth
1992Kr01	PRVCA	45,	1064	J.V. Kratz, M.K. Gober, H.P. Zimmermann, M. Schädel, W. Brüchle, E. Schimpf, K.E. Gregorich, A. Türler, N.J. Hannink, K.R. Czerwinski, B. Kadkhodayan, D.M. Lee, M.J. Nurmia, D.C. Hoffman, H. Gäggeler, D. Jost, J. Kovacs, U.W. Scherer, A. Weber
1992Kr.A	AnRpt LBL		58	S.A. Kreek, et al
1992Ku02	NUPAB	537,	153	S. Kubono, Y. Funatsu, N. Ikeda, M. Yasue, T. Nomura, Y. Fuchi, H. Kawashima, S. Kato, H. Miyatake, H. Orihara, T. Kajino
1992Li09	ZPAAD	341,	401	C.F. Liang, P. Paris, A. Gizon, V. Barci, D. Barneou, R. Béraud, J. Blachot, Ch. Briançon, J. Genevey, R.K. Sheline, and PrvCom GAU September 1992
1992Lo.B	UCRL-JC-109951			R.W. Loughheed, et al
1992Me10	ZPAAD	343,	283	F. Meissner, H. Salewski, W.-D. Schmidt-Ott, U. Bosch-Wicke, R. Michaelsen
1992Mo03	PRVCA	45,	1392	K.J. Moody, E.K. Hulet, P.B. Price
1992Mo15	ZPAAD	342,	273	D.M. Moltz, J.C. Batchelder, T.F. Lang, T.J. Ognibene, J. Cerny, P.E. Haustein, P.L. Reeder
1992Mo25	PRVCA	46,	2624	K.J. Moody, R.W. Loughheed, E.K. Hulet
1992Mu12	ZPAAD	342,	393	J. Mukai, A. Odahara, R. Nakatani, Y. Haruta, H. Tomura, B.J. Min, K. Heiguchi, S. Suematsu, S. Mitarai, T. Kuroyanagi
1992Os04	ZPAAD	343,	489	A.N. Ostrowski, H.G. Bohlen, A.S. Demyanova, B. Gebauer, R. Kalpakchieva, Ch. Langner, H. Lenske, M. von Lucke-Petsch, W. von Oertzen, A.A. Ogloblin, Y.E. Penionzhkevich, M. Wilpert, Th. Wilpert
1992Os07	NIMBE	70,	551	A. Osa, T. Ikuta, A. Taniguchi, H. Yamamoto, K. Kawade, S. Ichikawa, Y. Kawase
1992Ot.A	PrvCom	GAU	Mar	E.W. Otten
1992Pa05	PRLTA	68,	1287	R.D. Page, P.J. Woods, R.A. Cunningham, T. Davinson, N.J. Davis, S. Hofmann, A.N. James, K. Livingston, P.J. Sellin, A.C. Shotter
1992PI01	ZPAAD	342,	43	A. Plochocki, K. Rykaczewski, T. Batsch, J. Szerypo, J. Żylicz, R. Barden, O. Klepper, E. Roeckl, D. Schardt, H. Gabelmann, P. Hill, H. Ravn, T. Thorsteinssen, I.S. Grant, H. Grawe, P. Manakos, L.D. Skouras, ISOLDE
1992Po14	BRSPE	56,	666	A.V. Potempa, K. Ya. Gromov, J. Wawryszczuk, V.G. Kalinnikov, V.V. Kuznetsov, M. Levandovsky, J. Saraatar, Ya. Saidimov, V.I. Fominykh, Yu. V. Yushkevich, M.B. Yuldashev
1992Pr03	ZPAAD	342,	23	M. Przewloka, A. Przewloka, P. Wächter, H. Wollnik
1992Pr04	ZPAAD	342,	27	M. Przewloka, A. Przewloka, P. Wächter, H. Wollnik

1992Ra18	PRVCA	46,	2241	S. Raman, J.L. Campbell, A. Prindle, R. Gunnink, J.C. Palathingal
1992Ra19	PRVCA	46,	972	S. Raman, E.T. Jurney, J.W. Starnner, J.E. Lynn
1992Sa03	NUPAB	540,	83	J. Sauvage, C. Bourgeois, P. Kilcher, F. Le Blanc, B. Roussière, M.I. Macias-Marques, F. Bragança Gil, M.G. Porquet, H. Dautet, ISOCELE
1992Sc16	NUPAB	545,	646	W.-D. Schmidt-Ott, H. Salewski, F. Meissner, U. Bosch-Wicke, P. Koschel, V. Kunze, R. Michaelsen
1992Sh.A	P-Bernkastel		31	K.S. Sharma, P. Unger, G.R. Dyck, R.C. Barber, E. Hagberg, J.G. Hykawy, V.T. Koslowsky, J.C. Hardy, H. Schmeing, G. Savard, W. Perry, M. Watson, and PrvCom AHW October 1992
1992Sp.A	PrvCom		92Ch09	L. Spanier, B. Fogelberg, M. Hellström
1992Th06	NUPAB	548,	71	K. Theine, A.P. Byrne, H. Hubel, M. Murzel, R. Chapman, D. Clarke, F. Khaz-aie, J.C. Lisle, J.N. Mo, J.D. Garrett, H. Ryde, R. Wyss
1992To02	PRVCA	45,	856	K.S. Toth, H.J. Kim, J.W. McConnell, C.R. Bingham, D.C. Sousa
1992Ul.A	PrvCom	AHW	Mar	S. Ulbig
1992Un01	NIMAE	312,	349	M.P. Unterweger, D.D. Hoppes, F.J. Schima
1992Va.A	P-Bernkastel		3	R.S. Van Dyck, Jr., D.L. Farnham, P.B. Schwinberg
1992Wa06	PRVCA	45,	1597	T.A. Walkiewicz, S. Raman, E.T. Jurney, J.W. Starnner, J.E. Lynn
1992Wo03	ARISE	43,	551	D.H. Woods, S.A. Woods, M.J. Woods, J.L. Makepeace, C.W.A. Downey, D. Smith, A.S. Munster, S.E.M. Lucas, H. Sharma
1992Wo06	NIMAE	312,	346	M.J. Woods, S.E.M. Lucas, D.F.G. Reher, G. Sibbens
1992Wu09	ZPAAD	344,	205	S. Wüstenbecker, H.W. Becker, H. Ebbing, W.H. Schulte, M. Berheide, M. Buschmann, C. Rolfs, G.E. Mitchell, J.S. Schweitzer
1992Xu04	PRVCA	46,	510	S.-W. Xu, J.-S. Guo, S.-G. Yuan, M.-Q. Liu, E. Hagberg, V.T. Koslowsky, J.C. Hardy, G. Dyck, H. Schmeing, and erratum PRVCA 46(1992)2644
1993				
1993Ab11	PYLBB	316,	26	H. Abele, G. Helm, U. Kania, C. Schmidt, J. Last, D. Dubbers
1993Al03	ZPAAD	344,	425	G.D. Alkhazov, L.H. Batist, A.A. Bykov, F.V. Moroz, S. Yu. Orlov, V.K. Tarasov, V.D. Wittmann
1993An07	ZPAAD	345,	247	A.N. Andreyev, D.D. Bogdanov, V.I. Chepigin, A.P. Kabachenko, O.N. Malyshv, R.N. Sagaidak, G.M. Ter-Akopian, M. Veselsky, A.V. Yeremin
1993An11	PYLBB	312,	49	A.N. Andreyev, D.D. Bogdanov, S. Saro, G.M. Ter-Akopian, M. Veselsky, A.V. Yeremin
1993An19	NIMAE	330,	125	A.N. Andreyev, D.D. Bogdanov, V.I. Chepigin, V.A. Gorshkov, K.V. Mikhailov, A.P. Kabachenko, G.S. Popeko, S. Daro, G.M. Ter-Akopian, A.V. Yeremin
1993As02	PRVCA	47,	2954	K. Ashktorab, J.W. Jänecke, F.D. Becchetti, D.A. Roberts
1993Ba12	PRVCA	47,	2038	J.C. Batchelder, D.M. Moltz, T.J. Ognibene, M.W. Rowe, J. Cerny
1993Ba61	PRVCA	48,	2593	J.C. Batchelder, D.M. Moltz, T.J. Ognibene, M.W. Rowe, R.J. Tighe, J. Cerny
1993Be21	PRVCA	48,	R1	G.E. Berman, M.L. Pitt, F.P. Calaprice, M.M. Lowry
1993Be46	ZPAAD	346,	325	P. Bednarczyk, G. de Angelis, P. Spolaore, D. Ackermann, J. Rico, D. Bazzacco, S. Lunardi, L. Müller, C. Rossi Alvarez, F. Scarlassara, G.F. Segato, F. Soramel
1993Bo01	NUPAB	551,	54	V.A. Bondarenko, I.L. Kuvaga, P.T. Prokofjev, V.A. Khitrov, Yu. V. Kholnov, Le Hong Khiem, Yu. P. Popov, A.M. Sukhovej, S. Brant, V. Paar, V. Lopac
1993Bo03	ZPAAD	344,	381	H.G. Bohlen, B. Gebauer, M. von Lucke-Petsch, W. von Oertzen, A.N. Ostrowski, M. Wilpert, Th. Wilpert, H. Lenske, D.V. Alexandrov, A.S. Demyanova, E. Nikolskii, A.A. Korshennikov, A.A. Ogloblin, R. Kalpakchieva, Y.E. Penionzhkevich, Š. Piskoř
1993Bo20	NUPAB	556,	115	R. Bonetti, C. Chiesa, A. Guglielmetti, C. Migliorino, A. Cesana, M. Terrani
1993Bo.A	AnRpt GSI		65	F. Bosch, M. Jung
1993Bu02	PRVCA	47,	131	D.G. Burke, P.C. Sood, P.E. Garrett, Tao Qu, R.K. Sheline, R.W. Hoff
1993Ch21	PRVCA	48,	109	R.E. Chrien, B.K.S. Koene, M.L. Stelts, R.A. Meyer, S. Brant, V. Paar, V. Lopac
1993Di03	PRVCA	47,	2916	D.E. DiGregorio, S. Gil, H. Huck, E.R. Batista, A.M.J. Ferrero, A.O. Gattone
1993Dm02	ARISE	44,	1097	S.N. Dmitriev, Yu. Ts. Oganessian, G.V. Buklabov, Yu. P. Kharitonov, A.F. Novgorodov, L.I. Salamatin, G. Ya. Starodub, S.V. Shishkin, Yu. V. Yushkevich, D. Newton
1993Do05	PRVCA	47,	2560	J. Döring, J.W. Holcomb, T.D. Johnson, M.A. Riley, S.L. Tabor, P.C. Womble, G. Winter

1993Dr.A	P-Fribourg		305	S. Drissi, M. Deleze, P.E. Garrett, J. Jolie, J. Kern, S.J. Mannanal, P.A. Tercier, J.P. Vorlet, N. Warr, G. Mouze, C. Ythier, H.G. Borner, F. Hoyler, S. Judge, K. Schreckenbach, A. Williams
1993Go37	PRVAA	47,	3433	M.V. Gorshkov, G.M. Alber, L. Schweikhard, A.G. Marshall
1993Go38	IJMPD	128,	47	M.V. Gorshkov, S. Guan, A.G. Marshall
1993Gr17	NIMAE	337,	106	R.C. Greenwood, M.H. Putnam
1993Gr.C	AnRpt Berkeley		76	K.E. Gregorich, C.D. Kacher, M.F. Mohar, D.M. Lee, M.R. Lane, E.R. Sylvester, D.C. Hoffman, M. Schädel, W. Bröchle, J.V. Kratz, R. Günther and AnRpt GSI p.14
1993Ha05	ZPAAD	345,	143	A. Harder, S. Michaelsen, K.P. Lieb, A.P. Williams
1993Ho.A	AnRpt GSI		64	S. Hofmann, V. Ninov, F.P. Heßberger, H. Folger, G. Münzenberg, H.J. Schött, P. Armbruster, A.N. Andreyev, A.G. Popeko, A.V. Yeremin, M.E. Leino, R. Janik, S. Saro, M. Veselsky, and PrvCom AHW September 1995
1993Ja03	NUPAB	552,	340	Z. Janas, J. Äystö, K. Eskola, P.P. Jauho, A. Jokinen, J. Kownacki, M. Leino, J.M. Parmonen, H. Penttilä, J. Szerypo, J. Żylicz
1993Je06	PHSTB	48,	399	R. Jertz, D. Beck, G. Bollen, J. Emmes, H.-J. Kluge, E. Schark, S. Schwarz, T. Schwarz, L. Schweikhard, P. Senne C. Carlberg, I. Bergström, H. Borgenstrand, G. Rouleau, R. Schuch, F. Söderberg
1993KI02	PRVCA	47,	2502	G. Klotz, P. Baumann, M. Bounajma, A. Huck, A. Knipper, G. Walter, G. Marguier, C. Richard-Serre, A. Poves, J. Retamosa
1993Li10	NUCIA	106,	163	Sr. Little Flower, B.R.S. Babu, K. Neelakandan, R.N. Mukherjee, B.B. Baliga
1993Li18	PYLBB	312,	46	K. Livingston, P.J. Woods, T. Davinson, N.J. Davis, S. Hofmann, A.N. James, R.D. Page, P.J. Sellin, A.C. Shotter
1993Li34	PRVCA	48,	2151	K. Livingston, P.J. Woods, T. Davinson, N.J. Davis, S. Hofmann, A.N. James, R.D. Page, P.J. Sellin, A.C. Shotter
1993Li40	PRVCA	48,	3113	K. Livingston, P.J. Woods, T. Davinson, N.J. Davis, A.N. James, R.D. Page, P.J. Sellin, A.C. Shotter
1993Ma50	NUPAB	565,	543	G. Mairle, M. Seeger, H. Reinhardt, T. Kihm, K.T. Knöpfle, Chen Lin Wen
1993Ma.A	PrvCom	GAu	Feb	A.G. Marshall
1993Mi04	NUPAB	552,	232	S. Michaelsen, A. Harder, K.P. Lieb, G. Graw, R. Hertenberger, D. Hofer, P. Schiemenz, E. Zanotti, H. Lenske, A. Weigel, H.H. Wolter, S.J. Robinson, A.P. Williams
1993Mo01	PRLTA	70,	394	J.L. Mortara, I. Ahmad, K.P. Coulter, S.J. Freedman, B.K. Fujikawa, J.P. Greene, J.P. Schiffer, W.H. Trzaska, A.R. Zeuli
1993Mo18	NUPAB	563,	21	K.J. Moody, R.W. Lougheed, J.F. Wild, R.J. Dougan, E.K. Hulet, R.W. Hoff, C.M. Henderson, R.J. Dupzyk, R.L. Hahn, K. Sümmerer, G.D. O'Kelley, G.R. Bethune
1993Nx01	PYLBB	302,	13	J.N. Nxumalo, J.G. Hykawy, P. P Unger, C.A. Lander, R.C. Barber, K.S. Sharma, H.E. Duckworth
1993Nx02	PYLBB	312,	388	J.N. Nxumalo, J.G. Hykawy, K.J. Aarts, R.C. Barber, K.S. Sharma, H.E. Duckworth
1993Oh02	PRVDA	47,	4840	T. Ohshima, H. Sakamoto, T. Sato, J. Shirai, T. Tsukamoto, Y. Sugaya, K. Takahashi, T. Suzuki, C. Rosenfeld, S. Wilson, K. Ueno, Y. Yonezawa, H. Kawakami, S. Kato, S. Shibata, K. Ukai
1993Os06	NIMAE	332,	169	A. Osa, T. Ikuta, M. Shibata, M. Miyachi, H. Yamamoto, K. Kawade, Y. Kawase, S. Ichikawa
1993Pe11	NUPAB	561,	416	H. Penttilä, T. Enqvist, P.P. Jauho, A. Jokinen, M. Leino, J.M. Parmonen, J. Äystö, K. Eskola
1993Po.A	PrvCom	GAu	Dec	F. Pougheon
1993Pr.A	P-Fribourg		441	P.T. Prokofjev, A.V. Afanasjev, M.R. Beitins, L.I. Simonova, M.K. Balodis, G.L. Rezvaja
1993Qu03	ZPAAD	346,	119	A.B. Quint, W. Reisdorf, K.-H. Schmidt, P. Armbruster, F.P. Heßberger, S. Hofmann, J. Keller, G. Münzenberg, H. Stelzer, H.-G. Clerc, W. Morawek, C.-C. Sahn
1993Ru01	ADNDA	53,	1	G. Rudstam, K. Aleklett, L. Sihver
1993Ru03	PRVCA	47,	2574	D. Rudolph, C.J. Gross, M.K. Kabadiyski, K.P. Lieb, M. Weiszflog, H. Grawe, J. Heese, K.-H. Maier, J. Eberth
1993Sc16	ZPAAD	345,	265	D. Schardt, K. Riisager

1993Se04	PRVCA	47,	1933	P.J. Sellin, P.J. Woods, T. Davinson, N.J. Davis, K. Livingston, R.D. Page, A.C. Shotter, S. Hofmann, A.N. James
1993Se09	ZPAAD	346,	323	P.J. Sellin, P.J. Woods, T. Davinson, N.J. Davis, A.N. James, K. Livingston, R.D. Page, A.C. Shotter
1993Sh07	JPGPE	19,	617	R.K. Sheline, J. Kvasil, C.F. Liang, P. Paris
1993Sh23	ARISE	44,	923	M. Shibata, M. Asai, T. Ikuta, H. Yamamoto, J. Ruan, K. Okano, K. Aoki, K. Kawade
1993Si05	NIMAE	330,	195	M.H. Sidky, J.G. Hyckawy, G.R. Dyck, R.C. Barber, K.S. Sharma, C.A. Lander, H.E. Duckworth
1993Sp.A	AnRpt JYFL		95	A.M. Spits, P.H.M. Van Assche, H.G. Borner, W.F. Davidson, D.D. Warner, K. Schreckenbach, G.G. Colvin, R.C. Greenwood, C.W. Reich, P.O. Lipas, J. Suhonen, P. Sinkko, A. Backlin
1993To04	PRVCA	48,	436	K.S. Toth, D.C. Sousa, J.M. Nitschke, K.S. Vierinen, P.A. Wilmarth
1993To05	PRVCA	48,	445	K.S. Toth, P.A. Wilmarth, J.M. Nitschke, D.C. Sousa
1993Va04	PRLTA	70,	2888	R.S. Van Dyck, Jr., D.L. Farnham, P.B. Schwinberg
1993Va.C	PrvCom	GAu	May	R.S. Van Dyck, Jr., D.L. Farnham, P.B. Schwinberg
1993Wa03	ZPAAD	345,	21	J. Wauters, P. Dendooven, M. Huyse, G. Reusen, P. Van Duppen, R. Kirchner, O. Klepper, E. Roeckl
1993Wa04	PRVCA	47,	1447	J. Wauters, P. Dendooven, M. Huyse, G. Reusen, P. Van Duppen, P. Lievens, ISOLDE
1993We03	PYLBB	300,	210	Ch. Weinheimer, M. Przyrembel, H. Backe, H. Barth, J. Bonn, B. Degen, Th. Edling, H. Fischer, L. Fleischmann, J.U. Grooß, R. Haid, A. Hermanni, G. Kube, P. Leiderer, Th. Loeken, A. Moltz, R.B. Moore, A. Osipowicz, E.W. Otten, A. Picard, M. Schrader, M. Steininger
1993Wi03	PYLBB	299,	214	J.A. Winger, D. Bazin, W. Benenson, G.M. Crawley, D.J. Morrissey, N.A. Orr, R. Pfaff, B.M. Sherrill, M. Steiner, M. Thoennessen, S.J. Yennello, B.M. Young
1993Wi05	PRLTA	70,	1759	F.E. Wietfeldt, Y.D. Chan, M.T.F. da Cruz, A. García, R.-M. Larimer, K.T. Lesko, E.B. Norman, R.G. Stokstad, I. Žilimen
1993Wo04	PRVCA	47,	2546	P.C. Womble, J. Döring, T. Glasmacher, J.W. Holcomb, G.D. Johns, T.D. Johnson, T.J. Petters, M.A. Riley, V.A. Wood, S.L. Tabor, P. Semmes
1993Yo07	PRLTA	71,	4124	B.M. Young, W. Benenson, M. Fauerbach, J.H. Kelley, R. Pfaff, B.M. Sherrill, M. Steiner, J.S. Winfield, T. Kubo, M. Hellström, N.A. Orr, J. Stetson, J.A. Winger, S.J. Yennello
			1994	
1994Ah03	NUPAB	576,	246	I. Ahmad, J.E. Gindler, M.P. Carpenter, D.J. Henderson, E.F. Moore, R.V.F. Janssens, I.G. Bearden, C.C. Foster
1994An01	NUPAB	568,	323	A.N. Andreyev, D.D. Bogdanov, V.I. Chepigin, A.P. Kabachenko, O.N. Malyshv, Yu. A. Muzychka, B.I. Pustyl'nik, G.M. Ter-Akopian, A.V. Yeremin
1994An02	ZPAAD	347,	225	A.N. Andreyev, D.D. Bogdanov, V.I. Chepigin, A.P. Kabachenko, O.N. Malyshv, A.G. Popeko, R.N. Sagaidak, G.M. Ter-Akopian, M. Veselsky, A.V. Yeremin
1994Ba06	PRVCA	49,	1221	V. Banerjee, A. Banerjee, G.S.N. Murthy, R.P. Sharma, S.K. Pardha Saradhi, A. Chakrabarti
1994Ba50	PRVCA	50,	1180	P. Baumann, M. Bounajma, A. Huck, G. Klotz, A. Knipper, G. Walter, G. Marguier, C. Richard-Serre, H. Ravn, E. Hagebø, P. Hoff, K. Steffensen
1994Be24	PYLBB	331,	19	M. Bernas, S. Czajkowski, P. Armbruster, H. Geissel, Ph. Dessagne, C. Donzaud, H.-R. Faust, E. Hanelt, A. Heinz, M. Heese, C. Kozhuharov, Ch. Miché, G. Münzenberg, M. Pfützner, C. Röhl, K.-H. Schmidt, W. Schwab, C. Stéphan, K. Sümmerer, L. Tassan-Got, B. Voss
1994B110	PRVCA	50,	2398	B. Blank, S. Andriamonje, R. Del Moral, J.P. Dufour, A. Fleury, T. Josso, M.S. Pravikoff, S. Czajkowski, Z. Janas, A. Piechaczek, E. Roeckl, K.-H. Schmidt, K. Sümmerer, W. Trinder, M. Weber, T. Brohm, A. Grewe, E. Hanelt, A. Heinz, A. Junghans, C. Rohl, S. Steinhauser, B. Voss, M. Pfützner
1994Bo28	NUPAB	576,	21	R. Bonetti, C. Chiesa, A. Guglielmetti, C. Migliorino, P. Monti, A.L. Pasinetti, H.L. Ravn
1994Br11	PRVCA	49,	2401	S.A. Brindhavan, P.H. Barker
1994Br37	NIMAE	340,	436	S.A. Brindhavan, P.H. Barker, M.J. Keeling, W.B. Wood

1994Bu18	ZPAAD	349,	3	D. Bucurescu, D. Barnéoud, R. Béraud, G. Cata-Danil, T. von Egidy, A. Emsallem, J. Genevey, A. Gizon, J. Gizon, C.F. Liang, P. Paris, C.A. Ur, B. Weiss
1994De04	NUPAB	568,	141	M.E. Debray, A.J. Kreiner, M. Davidson, J. Davidson, D. Hojman, D. Santos, V.R. Vanin, N. Schutz, M. Aiche, A. Chevallier, J. Chevallier, J.C. Sens
1994Do08	PRVCA	49,	1867	M. Domsbky, L. Buchmann, J.M. D'Auria, U. Giesen, K.P. Jackson, J.D. King, E. Korkmaz, R.G. Korteling, P. McNeely, J. Powell, G. Roy, M. Trinczek, J. Vincent
1994Fa06	PRVCA	49,	2440	L. Faux, M.S. Pravikoff, S. Andriamonje, B. Blank, R. Del Moral, J.-P. Dufour, A. Fleury, C. Marchand, K.-H. Schmidt, K. Sümmerner, T. Brohm, H.-G. Clerc, A. Grewe, E. Hanelt, B. Voss, C. Ziegler
1994Fo08	PRVCA	50,	1355	H.T. Fortune, G.-B. Liu, D.E. Alburger
1994Fo14	PRLTA	73,	2413	B. Fogelberg, M. Hellström, D. Jerrestam, H. Mach, J. Blomqvist, A. Kerek, L.O. Norlin, J.P. Omtvedt
1994Gi07	PRVCA	50,	2612	R.L. Gill
1994Go.A	PrvCom	AHW	Jul	M.V. Gorshkov
1994Gr07	PRVCA	49,	2971	P. Grabmayer, A. Mondry, G.J. Wagner, P. Woldt, G.P.A. Berg, J. Lisantti, D.W. Miller, H. Nann, E.J. Stephenson
1994Gr08	PRLTA	72,	1423	K.E. Gregorich, M.R. Lane, M.F. Mohar, D.M. Lee, C.D. Kacher, E.R. Sylwester, D.C. Hoffman
1994Ha.A	Th.-Mainz			H. Hartmann
1994He08	PRVCA	49,	1845	R.G. Helmer, C.W. Reich
1994He28	PRVCA	50,	2219	M. Hencheck, R.N. Boyd, M. Hellström, D.J. Morrissey, M.J. Balbes, F.R. Chloupek, M. Fauerbach, C.A. Mitchell, R. Pfaff, C.F. Powell, G. Raimann, B.M. Sherrill, M. Steiner, J. Vandegriff, S.J. Yennello
1994Hi04	PRVCA	49,	3289	M.M. Hindi, R.L. Kozub, S.J. Robinson
1994Hi05	PRVCA	50,	728	M.M. Hindi, A.E. Champagne, M.T.F. da Cruz, R.-M. Larimer, K.T. Lesko, E.B. Norman, B. Sur
1994Hy01	PRVCA	50,	1249	J.G. Hykawy, R.C. Barber, K.S. Sharma, K.J. Aarts, J.N. Nxumalo, H.E. Duckworth
1994Ib01	ZPAAD	350,	9	F. Ibrahim, P. Kilcher, B. Roussière, J. Sauvage, J. Genevey, A. Gizon, A. Knipper, G. Marguier, D. Barnéoud, R. Béraud, G. Cata-Danil, J. Blachot, I. Deloncle, R. Duffait, A. Emsallem, D. Hojman, A.J. Kreiner, F. Le Blanc, J. Libert, J. Oms
1994It.A	P-Tokai		185	S. Itoh, M. Yasuda, H. Yamamoto, T. Iida, A. Takahashi, K. Kawade
1994Jo.A	Th.-Jyvaskyla			A. Jokinen
1994Ko16	PYLBB	326,	31	A.A. Korshennikov, K. Yoshida, D.V. Aleksandrov, N. Aoi, Y. Doki, N. Inabe, M. Fujimaki, T. Kobayashi, H. Kumagai, C.-B. Moon, E. Yu. Nikolskii, M.M. Obuti, A.A. Ogloblin, A. Ozawa, S. Shimoura, T. Suzuki, I. Tanihata, Y. Watanabe, M. Yanokura
1994Ko.A	AnRpt AECL		3-1	V.T. Koslowsky, E. Hagberg, G. Savard, M.J. Watson, J.C. Hardy
1994Kr13	PRVCA	50,	2288	S.A. Kreek, H.L. Hall, K.E. Gregorich, R.A. Henderson, J.D. Leyba, K.R. Czerwinski, B. Kadkhodayan, M.P. Neu, C.D. Kacher, T.M. Hamilton, M.R. Lane, E.R. Sylwester, A. Türler, D.M. Lee, M.J. Nurmia, D.C. Hoffman
1994La22	PRLTA	73,	624	Yu. A. Lazarev, Yu. V. Lobanov, Yu. Ts. Oganessian, V.K. Utyonkov, F. Sh. Abdullin, G.V. Buklanov, B.N. Gikal, S. Iliev, A.N. Mezentsev, A.N. Polyakov, I.M. Sedykh, I.V. Shirokovsky, V.G. Subbotin, A.M. Sukhov, Yu. S. Tsyganov, V.E. Zhuchko, R.W. Loughheed, K.J. Moody, J.F. Wild, E.K. Hulet, J.H. McQuaid
1994Le05	ZPAAD	348,	151	M. Leino, J. Uusitalo, T. Enqvist, K. Eskola, A. Jokinen, K. Loberg, W.H. Trzaska, J. Äystö
1994Le22	NUPAB	576,	267	A.I. Levon, J. de Boer, G. Graw, R. Hertenberger, D. Hofer, J. Kvasil, A. Löscher, E. Müller-Zanotti, M. Würkner, H. Baltzer, V. Grafen, C. Günther
1994Li12	PRVCA	49,	2230	C.F. Liang, R.K. Sheline, P. Paris, M. Hussonois, J.F. Ledu, D.B. Isabelle
1994Li20	PRVCA	49,	3098	S. Lin, S.A. Brindhaban, P.H. Barker
1994Ma14	PRVCA	49,	1755	P.V. Magnus, E.G. Adelberger, A. García
1994Mu02	NUPAB	568,	202	J. Mukai, A. Odahara, H. Tomura, S. Suematsu, S. Mitarai, T. Kuroyanagi, D. Jerrestam, J. Nyberg, G. Sletten, A. Atac, S.E. Arnell, H.A. Roth, Ö. Skeppstedt
1994Os04	PYLBB	338,	13	A.N. Ostrowski, H.G. Bohlen, B. Gebauer, S.M. Grimes, R. Kalpakchieva, Th. Kirchner, T.N. Massey, W. von Oertzen, Th. Stolla, M. Wilpert, Th. Wilpert

1994Ot01	NUPAB	567,	281	T. Otto, G. Bollen, G. Savard, L. Schweikhard, H. Stolzenberg, G. Audi, R.B. Moore, G. Rouleau, J. Szerypo, Z. Patyk, ISOLDE
1994Pa11	PRVCA	49,	3312	R.D. Page, P.J. Woods, R.A. Cunningham, T. Davinson, N.J. Davis, A.N. James, K. Livingston, P.J. Sellin, A.C. Shotter
1994Pa12	PRLTA	72,	1798	R.D. Page, P.J. Woods, R.A. Cunningham, T. Davinson, N.J. Davis, A.N. James, K. Livingston, P.J. Sellin, A.C. Shotter
1994Pa37	NUPAB	580,	173	G. Passler, J. Rikovska, E. Arnold, H.-J. Kluge, L. Monz, R. Neugart, H. Ravn, K. Wendt, ISOLDE
1994Po26	IANFA	58,	41	A.V. Potempa, G.V. Veselov, V.A. Sergienko, K. Ya. Gromov, S.V. Evtisov, V.G. Kalinnikov, V.V. Kuznetsov, Zh. Sereeter, V.I. Fominykh, M.B. Yuldashev
1994Ru19	PLSSA	42,	227	W. Rühm, B. Schneck, K. Knie, G. Korschinek, L. Zerle, E. Nolte, D. Weselka, H. Vonach
1994Sa31	PRVCA	50,	1170	C. Sáenz, E. Cerezo, E. Garcia, A. Morales, J. Morales, R. Nunez-Lagos, A. Ortiz de Solorzano, J. Puimedon, A. Salinas, M.L. Sarsa, J.A. Villar, A. Klimenko, V. Kuzminov, N. Metlinsky, V. Novikov, A. Pomansky, B. Pritychenko
1994Sc01	PRVCA	49,	46	K.W. Scheller, J. Gorres, J.G. Ross, M. Wiescher, R. Harkewicz, D.J. Morrissey, B.M. Sherrill, M. Steiner, N.A. Orr, J.A. Winger
1994Se12	ZPAAD	349,	25	H.L. Seifert, J.M. Wouters, D.J. Vieira, H. Wollnik, X.G. Zhou, X.L. Tu, Z.Y. Zhou, G.W. Butler
1994Sh02	PRVCA	49,	725	R.K. Sheline, C.F. Liang, P. Paris, A. Gizon, V. Barci
1994Sh07	ZPAAD	348,	25	T. Shizuma, M. Kidera, E. Ideguchi, A. Odahara, H. Tomura, S. Suematsu, T. Kuroyanagi, Y. Gono, S. Mitarai, J. Mukai, T. Komatsubara, K. Furuno, K. Heiguchi
1994Si26	ARISE	45,	669	B.R.S. Simpson, B.R. Meyer
1994St31	ZPAAD	347,	287	M.-L. Stolzenwald, G. Lhersonneau, M. Liang, G. Molnar, H. Ohm, K. Sistemich
1994Ti03	PRVCA	49,	2871	R.J. Tighe, D.M. Moltz, J.C. Batchelder, T.J. Ognibene, M.W. Rowe, J. Cerny
1994To10	PRVCA	50,	518	K.S. Toth
1994Wa05	NUPAB	568,	397	P.M. Walker, G.D. Dracoulis, A.P. Byrne, B. Fabricius, T. Kibédi, A.E. Stuchbery, N. Rowley
1994Wa17	PRVCA	50,	487	C. Wagemans, S. Druyts, P. Geltenbort
1994Wa23	PRVCA	50,	2768	J. Wauters, N. Bijnens, H. Folger, M. Huyse, H.Y. Hwang, R. Kirchner, J. von Schwarzenberg, P. Van Duppen
1994We02	ZPAAD	347,	185	C. Wennemann, W.-D. Schmidt-Ott, T. Hild, K. Krumbholz, V. Kunze, F. Meissner, H. Keller, R. Kirchner, E. Roeckl
1994Ya07	PYLBB	334,	229	S. Yasumi, H. Maezawa, K. Shima, Y. Inagaki, T. Mukoyama, T. Mizogawa, K. Sera, S. Kishimoto, M. Fujioka, K. Ishii, T. Omori, G. Izawa, O. Kawakami
1994Ye08	NIMAE	350,	608	A.V. Yeremin, A.N. Andreyev, D.D. Bogdanov, G.M. Ter-Akopian, V.I. Chepigin, V.A. Gorshkov, A.P. Kabachenko, O.N. Malyshev, A.G. Popeko, R.N. Sagaidak, S. Sharo, E.N. Voronkov, A.V. Taranenko, A. Yu. Lavrentjev
1994Yo01	PRVCA	49,	279	B.M. Young, W. Benenson, J.H. Kelley, N.A. Orr, R. Pfaff, B.M. Sherrill, M. Steiner, M. Thoennessen, J.S. Winfield, J.A. Winger, S.J. Yennello, A. Zeller
1995				
1995Al31	PZETA	62,	18	D.V. Aleksandrov, E. Yu. Nikolsky, B.G. Novatsky, D.N. Stepanov, V. Buryan, V. Kroga, Ya. Novak
1995Ap.A	PrvCom	GAu	May	A. Aprahamian, D.S. Brenner, R. Gill, A. Piotrowski, R.F. Casten
1995Ba28	PRLTA	74,	3569	D. Bazin, B.A. Brown, J. Brown, M. Fauerbach, M. Hellström, S.E. Hirzebruch, J.H. Kelley, R.A. Kryger, D.J. Morrissey, R. Pfaff, C.F. Powell, B.M. Sherrill, M. Thoennessen
1995Ba75	PRVCA	52,	1807	J.C. Batchelder, K.S. Toth, D.M. Moltz, T.J. Ognibene, M.W. Rowe, C.R. Bingham, E.F. Zganjar, B.E. Zimmerman
1995Bi01	PRVCA	51,	125	C.R. Bingham, M.B. Kassim, M. Zhang, Y.A. Akovali, K.S. Toth, W.D. Hamilton, H.K. Carter, J. Kormicki, J. von Schwarzenberg, M.M. Jarrio
1995Bi17	PRLTA	75,	4571	N. Bijnens, P. Decrock, S. Franchoo, M. Gaelens, M. Huyse, H.-Y. Hwang, I. Reusen, J. Szerypo, J. von Schwarzenberg, J. Wauters, J.G. Correia, A. Jokinen, P. Van Duppen, ISOLDE

1995Bi.A	P-Arles		545	C.R. Bingham, J.D. Richards, B.E. Zimmerman, Y.A. Akovali, W.B. Walters, J. Rikovska, P. Joshi, E.F. Zganjar, M. Lindroos, O. Tengblad, P. Van Duppen, ISOLDE, and PrvCom GAU June 1995
1995B105	NUPAB	588,	171c	B. Blank, S. Andriamonje, T. Brohm, S. Czajkowski, F. Davi, R. Del Moral, C. Donzaud, J.P. Dufour, A. Fleury, A. Grewe, R. Grzywacz, E. Hanelt, A. Heinz, Z. Janas, T. Josso, A. Junghans, M. Lewitowicz, A. Musquere, A. Piechaczek, M.S. Pravikoff, M. Pfützner, E. Roeckl, C. Rohl, J.E. Sauvestre, K.-H. Schmidt, S. Steinhäuser, K. Summerer, W. Trinder, B. Voss, M. Weber
1995B106	PRLTA	74,	4611	B. Blank, S. Andriamonje, S. Czajkowski, F. Davi, R. Del Moral, J.P. Dufour, A. Fleury, A. Musquere, M.S. Pravikoff, R. Grzywacz, Z. Janas, M. Pfützner, A. Grewe, A. Heinz, A. Junghans, M. Lewitowicz, J.-E. Sauvestre, C. Donzaud
1995B123	PYLBB	364,	8	B. Blank, S. Andriamonje, S. Czajkowski, F. Davi, R. Del Moral, C. Donzaud, J.P. Dufour, A. Fleury, A. Grewe, R. Grzywacz, A. Heinz, Z. Janas, A. Junghans, M. Lewitowicz, A. Musquere, M.S. Pravikoff, M. Pfützner, J.-E. Sauvestre
1995Bo03	NUPAB	582,	1	V.A. Bondarenko, I.L. Kuvaga, P.T. Prokofjev, A.M. Sukhovej, V.A. Khitrov, Yu. P. Popov, S. Brant, V. Paar
1995Bo05	NUPAB	584,	279	V.A. Bondarenko, I.L. Kuvaga, P.T. Prokofjev, A.M. Sukhovej, V.A. Khitrov, Yu. P. Popov, S. Brant, V. Paar, Lj. Šimičić
1995Bo10	NUPAB	583,	775c	H.G. Bohlen, B. Gebauer, Th. Kirchner, M. von Lucke-Petsch, W. von Oertzen, A.N. Ostrowski, Ch. Seyfert, Th. Stolla, M. Wilpert, Th. Wilpert, S.M. Grimes, T.N. Massey, R. Kalpakchieva, Y.E. Penionzhkevich, D.V. Alexandrov, I. Mukha, A.A. Ogloblin, C. Détraz
1995Bo.B	P-StPetersbg			H.G. Bohlen, B. Gebauer, M. von Lucke-Petsch, W. von Oertzen, A.N. Ostrowski, Ch. Seyfert, Th. Stolla, M. Wilpert, Th. Wilpert, R. Kalpakchieva, Yu. E. Penionzhkevich, S.M. Grimes, T.N. Massey, I. Mukha, D.V. Alexandrov, A.A. Ogloblin, H. Lenske
1995Br10	PRLTA	74,	868	R. Broda, B. Fornal, W. Królas, T. Pawlat, D. Bazzacco, S. Lunardi, C. Rossi-Alvarez, R. Menegazzo, G. de Angelis, P. Bednarczyk, J. Rico, D. De Acuña, P.J. Daly, R.H. Mayer, M. Sferrazza, H. Grawe, K.H. Maier, R. Schubart
1995Br24	NUPAB	595,	481	J.B. Breitenbach, J.L. Wood, M. Jarrio, R.A. Braga, H.K. Carter, J. Kormicki, P.B. Semmes
1995Bu11	NUPAB	587,	475	D. Bucurescu, D. Barnéoud, Gh. Cata-Danil, T. von Egidy, J. Genevey, A. Gizon, J. Gizon, C.F. Liang, P. Paris, B. Weiss, S. Brant, V. Paar, R. Pezer
1995Ca27	NUPAB	592,	89	H. Carlsson, R.A. Bark, L.P. Ekstrom, A. Nordlund, H. Ryde, G.B. Hagemann, S.J. Freeman, H.J. Jensen, T. Lonnroth, M.J. Piiparinen, H. Schnack-Petersen, F. Ingelbretsen, P.O. Tjøm
1995Ch74	BRSPE	59,	1854	V.G. Chumin, S.S. Eliseev, K. Ya. Gromov, Yu. V. Norseev, V.I. Fominykh, V.V. Tsupko-Sitnikov
1995Da14	ZPAAD	351,	225	M. Daszewski, Z. Janas, W. Kurcewicz, B. Szeweryn
1995Da.A	P-Arles		263	C.N. Davids, P.J. Woods, J.C. Batchelder, C.R. Bingham, D.J. Blumenthal, L.T. Brown, B.C. Busse, L.F. Conticchio, T. Davinson, S.J. Freeman, M. Freer, D.J. Henderson, R.J. Irvine, R.D. Page, H.T. Penttilä, A.V. Ramayya, D. Seweryniak, K.S. Toth, W.B. Walters, A.H. Wuosmaa, B.E. Zimmerman, and PrvCom GAU June 1995
1995Di08	PHSTT	59,	144	F. DiFilippo, V. Natarajan, M. Bradley, F. Palmer, D.E. Pritchard
1995Fa.A	AnRpt GSI		21	T. Faestermann, J. Friese, H. Geissel, R. Gernhäuser, H. Gilg, F. Heine, J. Homolka, P. Kienle, H.-J. Korner, G. Munzenberg, J. Reinhold, R. Schneider, K. Summerer, K. Zeitelhack
1995Fe12	ZPAAD	353,	9	V.N. Fedoseyev, Y. Jading, O.C. Jonsson, R. Kirchner, K.-L. Kratz, M. Krieg, E. Kugler, J. Lettry, T. Mehren, V.I. Mishin, H.L. Ravn, T. Rauscher, H.L. Ravn, F. Scheerer, O. Tengblad, P. Van Duppen, A. Woehr, ISOLDE
1995Ga04	NUPAB	581,	267	P.E. Garrett, D.G. Burke
1995Ga16	PRVCA	51,	3487	A. García, E.G. Adelberger, P.V. Magnus, H.E. Swanson, F.E. Wietfeldt, O. Tengblad, ISOLDE
1995Ga.A	P-Arles		595	A. Gadea, B. Rubio, J.L. Tain, J. Bea, L. Garcia-Raffi, J. Rico, L. Batist, V. Wittmann, A. Bykov, F. Moroz, H. Keller, R. Kirchner, E. Roeckl

1995Ge06	NUPAB	592,	307	R. Georgii, T. von Egidy, J. Klora, H. Lindner, U. Mayerhofer, J. Ott, W. Schauer, P. von Neumann-Cosel, A. Richter, C. Schlegel, R. Schulz, V.A. Khitrov, A.M. Sukhovoj, A.V. Vojnov, J. Berzins, V. Bondarenko, P. Prokofjevs, L.J. Simonova, M. Grinberg, Ch. Stojanov
1995Ge14	YAFIA	58,	1170	A. Sh. Georgadze, F.A. Danevich, Yu. G. Zdesenko, V.V. Kobychyev, B.N. Kropivnyansky, V.N. Kuts, A.S. Nikolaiko, V.I. Tretyak and 02Tr04
1995Gh04	NUPAB	583,	861c	A. Ghiorso, D. Lee, L.P. Somerville, W. Loveland, J.M. Nitschke, W. Ghiorso, G.T. Seaborg, P. Wilmarth, R. Leres, A. Wydler, M. Nurmia, K. Gregorich, R. Gaylord, T. Hamilton, N.J. Hannink, D.C. Hoffman, C. Jarzynski, C. Kacher, B. Kadkhodayan, S. Kreek, M. Lane, A. Lyon, M.A. McMahan, M. Neu, T. Sikkeland, W.J. Swiatecki, A. Türler, J.T. Walton, S. Yashita
1995Gj01	NUPAB	582,	369	N.L. Gjorup, P.M. Walker, G. Sletten, M.A. Bentley, B. Fabricius, J.F. Sharpey-Schafer
1995Gu01	NUPAB	583,	867c	A. Guglielmetti, B. Blank, R. Bonetti, Z. Janas, H. Keller, R. Kirchner, O. Klepper, A. Piechaczek, A. Płochocki, G. Poli, P.B. Price, E. Roeckl, K. Schmidt, J. Szerypo, A.J. Westphal
1995Ha.B	P-Arles		487	J.H. Hamilton, Q.H. Lu, S.J. Zhu, K. Butler-Moore, A.V. Ramayya, B.R.S. Babu, L.K. Peker, W.C. Ma, T.N. Ginter, J. Kormicki, D. Shi, J.K. Deng, J.O. Rasmussen, M.A. Stoyer, S.Y. Chu, K.E. Gregorich, M.F. Mohar, S. Prussin, J.D. Cole, R. Aryaeinejad, N.R. Johnson, I.Y. Lee, F.K. McGowan, G.M. Ter-Akopian, Yu. Ts. Oganessian
1995Hi02	PRVCA	51,	1736	T. Hild, W.-D. Schmidt-Ott, V. Kunze, F. Meissner, C. Wennemann, H. Grawe
1995Hi12	PRVCA	52,	2236	T. Hild, W.-D. Schmidt-Ott, V. Kunze, F. Meissner, H. Salewski, K.S. Toth, R. Michaelson
1995Hi14	JPGPE	21,	639	K.-H. Hiddemann, H. Daniel, O. Schwentker
1995Ho03	ZPAAD	350,	277	S. Hofmann, V. Ninov, F.P. Heßberger, P. Armbruster, H. Folger, G. Münzenberg, H.J. Schött, A.G. Popeko, A.V. Yeremin, A.N. Andreyev, S. Saro, R. Janik, M. Leino
1995Ho04	ZPAAD	350,	281	S. Hofmann, V. Ninov, F.P. Heßberger, P. Armbruster, H. Folger, G. Münzenberg, H.J. Schött, A.G. Popeko, A.V. Yeremin, A.N. Andreyev, S. Saro, R. Janik, M. Leino
1995Ho26	RAACA	70,	93	S. Hofmann
1995Ho.B	PrvCom	GAu	Mar	S. Hofmann, V. Ninov, F.P. Heßberger, and GSI Annual report 1995
1995Ho.C	P-Arles		571	S. Hofmann, F.P. Heßberger, H. Folger, V. Ninov, A.N. Andreyev, D.D. Bogdanov, V.I. Chepigin, A.P. Kabachenko, O.N. Malyshev, A.G. Popeko, G.M. Ter-Akopian, A.V. Yeremin, S. Saro
1995Ik03	JUPSA	64,	3244	T. Ikuta, A. Taniguchi, H. Yamamoto, K. Kawade, Y. Kawase
1995Ir01	PRLTA	75,	4182	H. Irnich, H. Geissel, F. Nolden, K. Beckert, F. Bosch, H. Eickhoff, B. Franzke, Y. Fujita, M. Hausmann, H.C. Jung, O. Klepper, C. Kozuharov, G. Kraus, A. Magel, G. Münzenberg, F. Nickel, T. Radon, H. Reich, B. Schlitt, W. Schwab, M. Steck, K. Sümmerner, T. Suzuki, H. Wollnik
1995Jo02	NUPAB	584,	489	A. Jokinen, T. Enqvist, P.P. Jauho, M. Leino, J.M. Parmonen, H. Penttilä, J. Äystö, K. Eskola
1995Jo.A	P-Arles		499	A. Jokinen, et al
1995Ka.A	B-Arles		PD22	V.G. Kalinnikov, B.P. Osipenko, F. Pražak, A.A. Solnyshkin, V.I. Stegailov, P. Čaloun, S.E. Zaporov
1995Ke04	NUPAB	586,	219	M. Keim, E. Arnold, W. Borchers, U. Georg, A. Klein, R. Neugart, L. Vermeeren, R.E. Silverans, P. Lievens
1995Ke05	ZPAAD	352,	1	H. Keller, R. Kirchner, B. Rubio, J.L. Tain, Th. Dörfler, W.-D. Schmidt-Ott, E. Roeckl
1995Ko54	RAACA	68,	155	A. Koua Aka, V. Barci, G. Ardisson, R. Righetti, J.F. Le Du, D. Trubert
1995Kr03	PRLTA	74,	860	R.A. Kryger, A. Azhari, M. Hellström, J.H. Kelley, T. Kubo, R. Pfaff, E. Ramakrishnan, B.M. Sherrill, M. Thoennessen, S. Yokoyama, R.J. Charity, J. Dempsey, A. Kirov, N. Robertson, D.G. Sarantites, L.G. Sobotka, J.A. Winger
1995Kr04	ZPAAD	351,	11	K. Krumbholz, W.-D. Schmidt-Ott, T. Hild, V. Kunze, F. Meissner, C. Wennemann, H. Keller, R. Kirchner, O. Klepper, E. Roeckl, D. Schardt, K. Rykaczewski
1995La09	NUPAB	588,	501	Yu. A. Lazarev, I.V. Shirokovsky, V.K. Utyonkov, S.P. Tretyakova, V.B. Kutner

1995La20	PRLTA	75,	1903	Yu. A. Lazarev, Yu. V. Lobanov, Yu. Ts. Oganessian, Yu. S. Tsyganov, V.K. Utyonkov, F. Sh. Abdullin, S. Iliev, A.N. Polyakov, J. Rigol, I.V. Shirokovsky, V.G. Subbotin, A.M. Sukhov, G.V. Buklanov, B.N. Gikal, V.B. Kutner, A.N. Mezentsev, I.M. Sedykh, D.V. Vakarov, R.W. Lougheed, J.F. Wild, K.J. Moody, E.K. Hulet
1995Le04	PRVCA	51,	1047	M.J. Leddy, S.J. Freeman, J.L. Durell, A.G. Smith, S.J. Warburton, D.J. Blumenthal, C.N. Davids, C.J. Lister, H.T. Penttilä
1995Le15	APOBB	26,	309	M. Leino, J. Äystö, T. Enqvist, A. Jokinen, M. Nurmia, A. Ostrowski, W.H. Trzaska, J. Uusitalo, K. Eskola, P. Armbruster, V. Ninov
1995Le19	PRVCA	51,	2770	Y.S. Lee, M. Kobayashi, T. Hukotome, T. Horiguchi, H. Inoue
1995Le.A	P-Arles		505	M. Leino, T. Enqvist, W.H. Trzaska, J. Uusitalo, K. Eskola, P. Armbruster, V. Ninov, and PrvCom GAU June 1995
1995Lh04	ZPAAD	352,	293	G. Lhersonneau, H. Gabelmann, B. Pfeiffer, K.-L. Kratz, ISOLDE
1995Me03	PRVCA	51,	1558	F. Meissner, T. Hild, V. Kunze, W.-D. Schmidt-Ott, C. Wennemann, P.C. Sood, R. Kirchner, E. Roeckl, K. Rykaczewski
1995Me16	PHSTT	56,	272	K.A. Mezilev, Yu. N. Novikov, A.V. Popov, B. Fogelberg, L. Spanier
1995Mo14	ZPAAD	352,	7	K. Morita, Y.H. Pu, J. Feng, M.G. Hies, K.O. Lee, A. Yoshida, S.C. Jeong, S. Kubono, T. Nomura, Y. Tagaya, M. Wada, M. Kurokawa, T. Motobayashi, H. Ogawa, T. Uchibori, K. Sueki, T. Ishizuka, K. Uchiyama, Y. Fujita, H. Miyatake, T. Shimoda, T. Shinozuka, H. Kudo, Y. Nagai, S.A. Shin
1995Mo26	NUPAB	588,	203c	D.J. Morrissey, and the A1200 Group
1995Ni05	ZPAAD	351,	125	V. Ninov, F.P. Heßberger, S. Hofmann, H. Folger, A.V. Yeremin, A.G. Popeko, A.N. Andreyev, S. Saro
1995Ni.A	P-Arles		571	V. Ninov, F.P. Heßberger, H. Folger, S. Hofmann, A.G. Popeko, A.V. Yeremin, A.N. Andreyev, S. Šaro, and Abstracts PD19
1995No.A	P-Arles		363	T. Nomura
1995Ok02	ZPAAD	351,	243	K. Okano, A. Taniguchi, S. Yamada, T. Sharshar, M. Shibata, K. Yamauchi
1995Os03	NUPAB	588,	185	A. Osa, M. Asai, M. Koizumi, T. Sekine, S. Ichikawa, Y. Kojima, H. Yamamoto, K. Kawade
1995Oz02	NUPAB	592,	244	A. Ozawa, G. Raimann, R.N. Boyd, F.R. Chloupek, M. Fujimaki, K. Kimura, H. Kitagawa, T. Kobayashi, J.J. Kolata, S. Kubono, I. Tanihata, Y. Watanabe, K. Yoshida
1995Pe12	NUPAB	588,	259c	Yu. E. Penionzhkevich
1995Pf04	ZPAAD	353,	1	B. Pfeiffer, G. Lhersonneau, H. Gabelmann, K.-L. Kratz, ISOLDE
1995Pi03	NUPAB	584,	509	A. Piechaczek, M.F. Mohar, R. Anne, V. Borrel, B.A. Brown, J.M. Corre, D. Guillemaud-Mueller, R. Hue, H. Keller, S. Kubono, V. Kunze, M. Lewitowicz, P. Magnus, A.C. Mueller, T. Nakamura, M. Pfützner, E. Roeckl, K. Rykaczewski, M.G. Saint-Laurent, W.-D. Schmidt-Ott, O. Sorlin
1995Po01	PRVCA	51,	519	K.R. Pohl, D.F. Winchell, J.W. Arrison, D.P. Balamuth
1995Re.A	P-Arles		587	P.L. Reeder, Y. Kim, W.K. Hensley, H.S. Miley, R.A. Warner, Z.Y. Zhou, D.J. Vieira, J.M. Wouters, H.L. Seifert, and PrvCom GAU June 1995
1995Ry03	PRVCA	52,	2310	K. Rykaczewski, R. Anne, G. Auger, D. Bazin, C. Borcea, V. Borrel, J.M. Corre, T. Dörfler, A. Fomichev, R. Grzywacz, D. Guillemaud-Mueller, R. Hue, M. Huyse, Z. Janas, H. Keller, M. Lewitowicz, S. Lukyanov, A.C. Mueller, Yu. Penionzhkevich, M. Pfützner, F. Pougheon, M.G. Saint-Laurent, K. Schmidt, W.D. Schmidt-Ott, O. Sorlin, J. Szerypo, O. Tarasov, J. Wauters, J. Żylicz
1995Sa42	NUPAB	592,	221	J. Sauvage, D. Hojman, F. Ibrahim, B. Roussière, P. Kilcher, F. Le Blanc, J. Oms, J. Libert, ISOCELE
1995Sc03	NUPAB	582,	109	K. Scheller, J. Görres, S. Vouzoukas, M. Wiescher, B. Pfeiffer, K.-L. Kratz, D.J. Morrissey, B.M. Sherrill, M. Steiner, M. Hellström, J.A. Winger
1995Sc28	NUPAB	588,	191c	R. Schneider, T. Faestermann, J. Friese, R. Gernhäuser, H. Geissel, H. Gilg, F. Heine, J. Homolka, P. Kienle, H.-J. Korner, G. Münzenberg, J. Reinhold, K. Sümmerer, K. Zeitelhack
1995So03	NUPAB	583,	763c	O. Sorlin, D. Guillemaud-Mueller, R. Anne, L. Axelsson, D. Bazin, W. Böhmer, V. Borrel, Y. Jading, H. Keller, K.-L. Kratz, M. Lewitowicz, S.M. Lukyanov, T. Mehren, A.C. Mueller, Yu. E. Penionzhkevich, F. Pougheon, M.G. Saint-Laurent, V.S. Salamatina, S. Shoedder, A. Wöhr
1995So11	PRVCA	52,	88	P.C. Sood, A. Gizon, D.G. Burke, B. Singh, C.F. Liang, R.K. Sheline, M.J. Martin, R.W. Hoff

1995St26	PRLTA	75,	3237	W. Stoeffl, D.J. Decman
1995Sy01	PRVCA	51,	2765	I. Sykora, K. Janko, P.P. Povinec
1995Sz01	NUPAB	584,	221	J. Szerypo, M. Huyse, G. Reusen, P. Van Duppen, Z. Janas, H. Keller, R. Kirchner, O. Klepper, A. Piechaczek, E. Roeckl, D. Schardt, K. Schmidt, R. Grzywacz, M. Pfützner, A. Płochocki, K. Rykaczewski, J. Żylicz, G.D. Alk-hazov, L. Batist, A. Bykov, V. Wittmann, B.A. Brown
1995Tr02	PYLBB	348,	331	W. Trinder, E.G. Adelberger, B.A. Brown, Z. Janas, H. Keller, K. Krumbholz, V. Kunze, P. Magnus, F. Meissner, A. Piechaczek, M. Pfützner, E. Roeckl, K. Rykaczewski, W.-D. Schmidt-Ott, M. Weber
1995Tr03	PYLBB	349,	267	W. Trinder, E.G. Adelberger, Z. Janas, H. Keller, K. Krumbholz, V. Kunze, P. Magnus, F. Meissner, A. Piechaczek, M. Pfützner, E. Roeckl, K. Rykaczewski, W.-D. Schmidt-Ott, M. Weber
1995Uu01	PRVCA	52,	113	J. Uusitalo, T. Enqvist, M. Leino, W.H. Trzaska, K. Eskola, P. Armbruster, V. Ni-nov
1995Va38	PHSTT	59,	134	R.S. Van Dyck, Jr., D.L. Farnham, P.B. Schwinberg
1995Ve08	BRSPE	59,	1851	G.V. Veselov, V.A. Sergienko, A.V. Potempa, K. Ya. Gromov, V.G. Kalinnikov, N. Yu. Kotovsky, V.I. Fominykh, M.B. Yuldashev
1995Wi20	PRVCA	52,	1028	F.E. Wietfeldt, E.B. Norman, Y.D. Chan, M.T.F. da Cruz, A. García, E.E. Haller, W.L. Hansen, M.M. Hindi, R.-M. Larimer, K.T. Lesko, P.N. Luke, R.G. Stock-stad, B. Sur, I. Žilimen
1995Zh10	NUPAB	586,	483	K. Zhao, J.S. Lilley, P.V. Drumm, D.D. Warner, R.A. Cunningham, J.N. Mo
1995Zh36	ZPAAD	353,	3	X. Zhou, Y. Guo, X. Sun, X. Lei, X. Chen, Z. Liu, Y. Zhang, H. Jin, Y. Luo, S.X. Wen, G.J. Yuan, G.S. Li, C.X. Yang
1995Zi03	PRLTA	75,	1719	M. Zinser, F. Humbert, T. Nilsson, W. Schwab, T. Blaich, M.J.G. Borge, L.V. Chulkov, H. Eickhoff, T.W. Elze, H. Emling, B. Franzke, H. Freiesleben, H. Geissel, K. Grimm, D. Guillemaud-Mueller, P.G. Hansen, R. Holzmann, H. Irnich, B. Jonson, J.G. Keller, O. Klepper, H. Klingler, J.V. Kratz, R. Kulesa, D. Lambrecht, Y. Leifels, A. Magel, M. Mohar, A.C. Mueller, G. Münzenberg, F. Nickel, G. Nyman, A. Richter, K. Riisager, C. Scheidenberger, G. Schrieder, B.M. Sherrill, H. Simon, K. Stelzer, J. Stroth, O. Tengblad, W. Trautmann, E. Wajda, E. Zude, preprint GSI-95-03
			1996	
1996An21	BRSPE	60,	119	A.N. Andreyev, A.G. Popeko, A.V. Eremin, S. Hofmann, F. Heßberger, H. Fol-ger, V. Ninov, S. Saro
1996Ar36	ZPCFD	72,	239	R. Arnold, C. Augier, A. Barabash, D. Blum, V. Brudanin, J.E. Campagne, D. Dassié, V. Egorov, R. Eschbach, J.L. Guyonnet, F. Hubert, Ph. Hubert, S. Jullian, O. Kochetov, I. Kisel, V.N. Kornoukhov, V. Kovalenko, D. Lalanne, F. Laplanche, F. Leccia, I. Linck, C. Longuemare, F. Mauger, P. Mennrath, H.W. Nicholson, A. Nozdrin, F. Piquemal, O. Purtov, J-L. Reyss, F. Scheib-ling, J. Suhonen, C.S. Sutton, G. Szklarz, V.I. Tretyak, V. Umatov, I. Vanushin, A. Varelle, Yu. Vasilyev, Ts. Vylov, V. Zerkov, NEMO
1996Ax01	PRVCA	54,	1511	L. Axelsson, M.J.G. Borge, S. Fayans, V.Z. Goldberg, S. Grévy, D. Guillemaud-Mueller, B. Jonson, K.-M. Källman, T. Lönnroth, M. Lewitowicz, P. Manngård, K. Markenroth, I. Martel, A.C. Mueller, I. Mukha, T. Nilsson, G. Nyman, N.A. Orr, K. Riisager, G.V. Rogatchev, M.-G. Saint-Laurent, I.N. Serikov, O. Sorlin, O. Tengblad, F. Wenander, J.S. Winfield, R. Wolski
1996Ba24	YAFIA	59,	197	A.S. Barabash, R.R. Saakyan and 02Tr04
1996Ba35	PRVCA	54,	949	J.C. Batchelder, K.S. Toth, E.F. Zganjar, D.M. Moltz, C.R. Bingham, T.J. Og-nibene, J. Powell, M.W. Rowe
1996Bi07	PRVCA	54,	R20	C.R. Bingham, K.S. Toth, J.C. Batchelder, D.J. Blumenthal, L.T. Brown, B.C. Busse, L.F. Conticchio, C.N. Davids, T. Davinson, D.J. Henderson, R.J. Irvine, D. Seweryniak, W.B. Walters, P.J. Woods, B.E. Zimmerman
1996Bi21	PRLTA	77,	2893	B. Blank, S. Czajkowski, F. Davi, R. Del Moral, J.P. Dufour, A. Fleury, C. Marc-hand, M.S. Pravikoff, J. Benlliure, F. Boue, R. Collatz, A. Heinz, M. Hellström, Z. Hu, E. Roeckl, M. Shibata, K. Sümmerer, Z. Janas, M. Karny, M. Pfützner, M. Lewitowicz

1996Bo37	PRLTA	77,	5190	F. Bosch, T. Faestermann, J. Friese, F. Heine, P. Kienle, E. Wefers, K. Zeitelhack, K. Beckert, B. Franzke, O. Klepper, C. Kozhuharov, G. Menzel, R. Moshhammer, F. Nolden, H. Reich, B. Schlitt, M. Steck, T. Stöhlker, T. Winkler, K. Takahashi
1996Ca02	NUPAB	598,	61	P. Campbell, J.A. Behr, J. Billowes, G. Gwinner, G.D. Sprouse, F. Xu
1996Ch32	PRLTA	77,	2400	M. Chartier, G. Auger, W. Mittig, A. Lepine-Szilly, L.K. Fifield, J.M. Casandjian, M. Chabert, J. Ferme, A. Gillibert, M. Lewitowicz, M. MacCormick, M.H. Moscatello, O.H. Odland, N.A. Orr, G. Politi, C. Spitaels, A.C.C. Villari
1996Da06	PRLTA	76,	592	C.N. Davids, P.J. Woods, H.T. Penttilä, J.C. Batchelder, C.R. Bingham, D.J. Blumenthal, L.T. Brown, B.C. Busse, L.F. Conticchio, T. Davinson, D.J. Henderson, R.J. Irvine, D. Seweryniak, K.S. Toth, W.B. Walters, B.E. Zimmerman
1996De60	YAFIA	59,	2117	A.V. Derbin, A.I. Egorov, V.N. Muratova, S.V. Baklanov and 02Tr04
1996Do23	PRVCA	54,	2894	T. Dörfler, W.-D. Schmidt-Ott, T. Hild, T. Mehren, W. Böhmer, P. Möller, B. Pfeiffer, T. Rauscher, K.-L. Kratz, O. Sorlin, V. Borrel, S. Grévy, D. Guillemaud-Mueller, A.C. Mueller, F. Pougheon, R. Anne, M. Lewitowicz, A. Ostrowsky, M. Robinson, M.G. Saint-Laurent
1996Dr07	NUPAB	601,	234	S. Drissi, S. Andre, D. Barnéoud, C. Foin, J. Genevey, J. Kern
1996Dr.A	PrvCom	JBl	Sep	S. Drissi
1996En01	ZPAAD	354,	1	T. Enqvist, K. Eskola, A. Jokinen, M. Leino, W.H. Trzaska, J. Uusitalo, V. Ninov, P. Armbruster
1996En02	ZPAAD	354,	9	T. Enqvist, P. Armbruster, K. Eskola, M. Leino, V. Ninov, W.H. Trzaska, J. Uusitalo
1996Fa09	NUPAB	602,	167	L. Faux, S. Andriamonje, B. Blank, S. Czajkowski, R. Del Moral, J.P. Dufour, A. Fleury, T. Josso, M.S. Pravikoff, A. Piechaczek, E. Roeckl, K.-H. Schmidt, K. Sümmerer, W. Trinder, M. Weber, T. Brohm, A. Grewe, E. Hanelt, A. Heinz, A. Junghans, C. Rohl, S. Steinhäuser, B. Voss, Z. Janas, M. Pfützner
1996Ga30	NUPAB	611,	68	P.E. Garrett, N. Warr, H. Baltzer, S. Boehmsdorff, D.G. Burke, M. Deleze, S. Drissi, J. Groger, C. Gunther, J. Kern, S.J. Mannanal, J. Manns, U. Muller, J.-P. Vorlet, T. Weber
1996Gi08	NUPAB	605,	301	A. Gizon, J. Genevey, D. Bucurescu, Gh. Cata-Danil, J. Gizon, J. Inchaouh, D. Barnéoud, T. von Egidy, C.F. Liang, B.M. Nyako, P. Paris, I. Penev, A. Płochocki, E. Ruchowska, C.A. Ur, B. Weiss, L. Zolnai
1996Go06	JPGPE	22,	377	V.M. Gorozhankin, V.G. Kalinnikov, A. Kovalik, A.A. Solnyshkin, A.F. Novgorodov, N.A. Lebedev, N. Yu. Kotovskij, E.A. Yakushev, M.A. Mahmoud, M. Rysavy
1996Ho12	PRVCA	54,	78	R.W. Hoff, H.G. Borner, K. Schreckenbach, G.G. Colvin, F. Hoyler, W. Schauer, T. von Egidy, R. Georgii, J. Ott, S. Schrunder, R.F. Casten, R.L. Gill, M. Balodis, P. Prokofjevs, L. Simonova, J. Kern, V.A. Khitrov, A.M. Sukhovojev, O. Bersillon, S. Joly, G. Graw, D. Hofer, B. Valnion
1996Ho13	ZPAAD	354,	229	S. Hofmann, V. Ninov, F.P. Heßberger, P. Armbruster, H. Folger, G. Münzenberg, H.J. Schött, A.G. Popeko, A.V. Yeremin, S. Saro, R. Janik, M. Leino
1996Ho16	PRLTA	77,	1020	P. Hoff, P. Baumann, A. Huck, A. Knipper, G. Walter, G. Marguier, B. Fogelberg, A. Lindroth, H. Mach, M. Sanchez-Vega, R.B.E. Taylor, P. Van Duppen, A. Jokinen, M. Lindroos, M. Ramdane, W. Kurcewicz, B. Jonson, G. Nyman, Y. Jading, K.-L. Kratz, A. Wöhr, G. Løvhøiden, T.F. Thorsteinsen, J. Blomqvist, ISOLDE
1996Hw03	NIMAE	383,	447	H.Y. Hwang, C.B. Lee, T.S. Park, H.J. Kim
1996Ik01	PRVCA	54,	2043	H. Ikezoe, T. Ikuta, S. Hamada, Y. Nagame, I. Nishinaka, K. Tsukada, Y. Oura, T. Ohtsuki
1996Ki23	HYIND	103,	49	P. Kienle
1996Kl.A	AnRpt JYFL		30	I. Klöckl, K.-L. Kratz, G. Lhersonneau, P. Pfeiffer, S. Schoedder, P. Dendooven, A. Honkanen, M. Huhta, M. Oinonen, J. Persson, K. Peräjärvi, J.C. Wang, J. Äystö
1996Ko13	PRVCA	54,	R459	F.G. Kondev, G.D. Dracoulis, A.P. Byrne, T. Kibédi, S. Bayer, G.J. Lane
1996Ko17	NUPAB	601,	195	F.G. Kondev, G.D. Dracoulis, A.P. Byrne, M. Dasgupta, T. Kibédi, G.J. Lane
1996La11	PRVCA	53,	2893	M.R. Lane, K.E. Gregorich, D.M. Lee, M.F. Mohar, M. Hsu, C.D. Kacher, B. Kadkhodayan, M.P. Neu, N.J. Stoyer, E.R. Sylwester, J.C. Yang, D.C. Hoffman

1996La12	PRVCA	54,	620	Yu. A. Lazarev, Yu. V. Lobanov, Yu. Ts. Oganessian, V.K. Utyonkov, F. Sh. Abdullin, A.N. Polyakov, J. Rigol, I.V. Shirokovsky, Yu. S. Tsyganov, S. Iliev, V.G. Subbotin, A.M. Sukhov, G.V. Buklanov, B.N. Gikal, V.B. Kutner, A.N. Mezentsev, K. Subotic, J.F. Wild, R.W. Lougheed, K.J. Moody
1996Le09	ZPAAD	355,	157	M. Leino, J. Uusitalo, R.G. Allatt, P. Armbruster, T. Enqvist, K. Eskola, S. Hofmann, S. Hurskanen, A. Jokinen, V. Ninov, R.D. Page, W.H. Trzaska
1996Lh03	PRVCA	54,	1117	G. Lhersonneau, P. Dendooven, S. Hankonen, A. Honkanen, M. Huhta, R. Julin, S. Juutinen, M. Oinonen, H. Penttilä, A. Savelius, S. Tormanen, J. Aysto, P.A. Butler, J.F.C. Cocks, P.M. Jones, J.F. Smith
1996Lh04	PRVCA	54,	1592	G. Lhersonneau, P. Dendooven, A. Honkanen, M. Huhta, M. Oinonen, H. Penttilä, J. Äystö, J. Kurpeta, J.R. Persson, A. Popov
1996Li05	ZPAAD	354,	153	C.F. Liang, P. Paris, A. Płochocki, E. Ruchowska, A. Gizon, D. Barnéoud, J. Genevey, G. Cata, R.K. Sheline
1996Li37	PRVCA	54,	2304	C.F. Liang, P. Paris, R.K. Sheline, P. Alexa, A. Gizon
1996Ma72	RAACA	72,	39	M. Magara, N. Shinohara, Y. Hatsukawa, K. Tsukada, H. Imura, S. Utsuda, S.-I. Ichikawa, T. Suzuki, Y. Nagame, Y. Kobayashi, M. Oshima, T. Horichuchi
1996Me09	PRLTA	77,	458	T. Mehren, B. Pfeiffer, S. Schoedder, K.-L. Kratz, M. Huhta, P. Dendooven, A. Honkanen, G. Lhersonneau, M. Oinonen, J.-M. Parmonen, H. Penttilä, A. Popov, V. Rubchenya, J. Äystö
1996Ni09	ZPAAD	356,	11	V. Ninov, F.P. Heßberger, S. Hofmann, H. Folger, G. Münzenberg, P. Armbruster, A.V. Yeremin, A.G. Popeko, M. Leino, S. Saro
1996Od01	ZPAAD	354,	231	A. Odahara, Y. Gono, S. Mitarai, T. Shizuma, E. Ideguchi, J. Mukai, H. Tomura, B.J. Min, S. Suematsu, T. Kuroyanagi, K. Heiguchi, T. Komatsubara, K. Furuno
1996Os04	JUPSA	65,	928	A. Osa, T. Ikuta, K. Kawade, H. Yamamoto, S. Ichikawa
1996Pa01	PRVCA	53,	660	R.D. Page, P.J. Woods, R.A. Cunningham, T. Davinson, N.J. Davis, A.N. James, K. Livingston, P.J. Sellin, A.C. Shotter, and PrvCom AHW August 1996
1996Pf01	PRVCA	53,	1753	R. Pfaff, D.J. Morrissey, W. Benenson, M. Fauerbach, M. Hellström, C.F. Powell, B.M. Sherrill, M. Steiner, J.A. Winger
1996Ra04	PRVCA	53,	616	S. Raman, E.K. Warburton, J.W. Starner, E.T. Jurney, J.E. Lynn, P. Tikkanen, J. Keinonen
1996Ra16	PRVCA	53,	2732	S. Raman, J.B. McGrory E.T. Jurney, J.W. Starner
1996Ri12	PRVCA	54,	2041	J.D. Richards, C.R. Bingham, Y.A. Akevali, J.A. Becker, E.A. Henry, P. Joshi, J. Kormicki, P.F. Mantica, K.S. Toth, J. Wauters, E.F. Zganjar
1996Ry.B	AnRpt JYFL		33	K. Rykaczewski
1996Sh27	JUPSA	65,	3172	M. Shibata, A. Odahara, S. Mitarai, Y. Gono, M. Kidera, K. Miyazaki, T. Kuroyanagi
1996Ta18	PRVCA	54,	2926	R.B.E. Taylor, S.J. Freeman, J.L. Durell, M.J. Leddy, A.G. Smith, D.J. Blumenthal, M.P. Carpenter, C.N. Davids, C.J. Lister, R.V.F. Janssens, D. Seweryniak
1996To01	PRVCA	53,	2513	K.S. Toth, J.C. Batchelder, C.R. Bingham, L.F. Conticchio, W.B. Walters, C.N. Davids, D.J. Henderson, R. Herman, H. Penttilä, J.D. Richards, A.H. Wuosmaa, B.E. Zimmerman
1996To05	ZPAAD	355,	345	Y. Toh, K. Okano, A. Taniguchi, S. Yamada, Y. Kawase
1996To08	ZPAAD	355,	225	K.S. Toth, J.C. Batchelder, D.M. Moltz, J.D. Robertson
1996Ur02	PRVCA	54,	945	W. Urban, W.R. Phillips, J.L. Durell, M.A. Jones, M. Leddy, C.J. Pearson, A.G. Smith, B.J. Varley, I. Ahmad, L.R. Morss, M. Benteleb, E. Lubkiewicz, N. Schulz
1996Wa33	PRVCA	54,	2916	P.M. Wallace, E.G. Bilpuch, C.R. Bybee, G.E. Mitchell, E.F. Moore, J.D. Shriner, J.F. Shriner, Jr., G.A. Vavrina, C.R. Westerfeldt
1996WaZX	AnRpt Tohoku		25	A. Watanabe, T. Shinozuka, M. Fujita, Y. Kanai, T. Kohda, M. Fujioka
1996Wo.A	P-Amsterdam		D14	A. Wöhr, V. Fedoseyev, Y. Jading, A. Jokinen, T. Kautzsch, I. Klöckl, K.-L. Kratz, V.I. Mishin, H.-L. Ravn, P. Van Duppen, W.B. Walters, ISOLDE
1996Ya12	JUPSA	65,	3390	S. Yamada, A. Taniguchi, Y. Toh, K. Okano
1996Ya.A	P-Kyoto		51	K. Yamauchi, Y. Kojima, H. Sakane, Y. Tsurita, H. Yamamoto, K. Kawade, A. Taniguchi, Y. Kawase, K. Okano, J.Z. Ruan and report KURRI-KR3 p. 51
			1997	
1997An09	ZPAAD	358,	63	A.N. Andreyev, N. Bijnens, T. Enqvist, M. Huyse, P. Kuusiniemi, M. Leino, W.H. Trzaska, J. Uusitalo, P. Van Duppen

1997As05	PRVCA	56,	3045	M. Asai, T. Sekine, A. Osa, M. Koizumi, Y. Kojima, M. Shibata, H. Yamamoto, K. Kawade
1997Ba21	ZPAAD	357,	121	J.C. Batchelder, K.S. Toth, C.R. Bingham, L.T. Brown, L.F. Conticchio, C.N. Davids, T. Davinson, D.J. Henderson, R.J. Irvine, D. Seweryniak, W.B. Walters, P.J. Woods, J. Wauters, E.F. Zganjar
1997Ba25	PRVCA	55,	2142	J.C. Batchelder, K.S. Toth, C.R. Bingham, L.T. Brown, L.F. Conticchio, C.N. Davids, D. Seweryniak, J. Wauters, J.L. Wood, E.F. Zganjar
1997Ba35	ZPAAD	357,	351	A.S. Barabash, R. Gurriaran, F. Hubert, Ph. Hubert, V.I. Umatov
1997Be70	PYLBB	415,	111	M. Bernas, C. Engelmann, P. Armbruster, S. Czajkowski, F. Ameil, C. Bockstiegel, Ph. Dessagne, C. Donzaud, H. Geissel, A. Heinz, Z. Janas, C. Kozuharov, Ch. Miché, G. Münzenberg, M. Pfützner, W. Schwab, C. Stephan, K. Sümmerer, L. Tassan-Got, B. Voss
1997B103	NUPAB	615,	52	B. Blank, F. Boué, S. Andriamonje, S. Czajkowski, R. Del Moral, J.P. Dufour, A. Fleury, P. Pourre, M.S. Pravikoff, N.A. Orr, K.-H. Schmidt, E. Hanelt
1997B104	ZPAAD	357,	247	B. Blank, F. Boué, S. Andriamonje, S. Czajkowski, R. Del Moral, J.P. Dufour, A. Fleury, P. Pourre, M.S. Pravikoff, E. Hanelt, N.A. Orr, K.-H. Schmidt
1997Bo10	NUPAB	616,	254c	H.G. Bohlen, W. von Oertzen, Th. Stolla, R. Kalpakchieva, B. Gebauer, M. Wilpert, Th. Wilpert, A.N. Ostrowski, S.M. Grimes, T.N. Massey
1997Ch53	BRSPE	61,	1606	V.G. Chumin, J.K. Jabber, K.V. Kalyapkin, S.A. Kudrya, V.V. Tsupko-Sitnikov, K. Ya. Gromov, V.I. Fominykh, T.A. Furyaev
1997Da07	PRVCA	55,	2255	C.N. Davids, P.J. Woods, J.C. Batchelder, C.R. Bingham, D.J. Blumenthal, L.T. Brown, B.C. Busse, L.F. Conticchio, T. Davinson, S.J. Freeman, D.J. Henderson, R.J. Irvine, R.D. Page, H.T. Penttilä, D. Seweryniak, K.S. Toth, W.B. Walters, B.E. Zimmerman
1997Ga12	PYLBB	398,	415	F. Gatti, P. Meunier, C. Salvo, S. Vitale
1997Gi07	ZPAAD	358,	369	A. Gizon, J. Genevey, Gh. Cata-Danil, D. Barnéoud, R. Béraud, A. Emsallem, C. Foin, J. Gizon, C.F. Liang, P. Paris, I. Penev, A. Płochocki, B. Weiss
1997Go18	PRLTA	79,	2415	M. Górska, M. Lipoglavšek, H. Grawe, J. Nyberg, A. Atac, A. Axelsson, R. Bark, J. Blomqvist, J. Cederkäll, B. Cederwall, G. de Angelis, C. Fahlander, A. Johnson, S. Leoni, A. Likar, M. Matiuzzi, S. Mitarai, L.-O. Norlin, M. Palacz, J. Persson, H.A. Roth, R. Schubart, D. Seweryniak, T. Shizuma, Ö. Skeppstedt, G. Sletten, W.B. Walters, M. Weiszflog
1997Gr02	PRVCA	55,	1126	R. Grzywacz, R. Anne, G. Auger, C. Borcea, J.M. Corre, T. Dorfler, A. Fomichev, S. Grevy, H. Grawe, D. Guillemaud-Mueller, M. Huyse, Z. Janas, H. Keller, M. Lewitowicz, S. Lukyanov, A.C. Mueller, N. Orr, A. Ostrowski, Yu. Penionzhkevich, A. Piechaczek, F. Pougheon, K. Rykaczewski, M.G. Saint-Laurent, W.D. Schmidt-Ott, O. Sorlin, J. Szerypo, O. Tarasov, J. Wauters, J. Żylicz
1997Gu32	YTHLD	19,	180	J. Guo, K. Zhao, X. Lu, Y. Cheng, T. Li, C. Fu, S. Li
1997Ha04	NUPAB	613,	183	E. Hagberg, I.S. Towner, J.C. Hardy, V.T. Koslowsky, G. Savard, S. Sterbenz
1997Ha30	ZPAAD	358,	15	T. Hayakawa, T. Komatsubara, J. Lu, J. Mukai, K. Furuno
1997He29	ZPAAD	359,	415	F.P. Heßberger, S. Hofmann, V. Ninov, P. Armbruster, H. Folger, G. Münzenberg, H.J. Schött, A.G. Popeko, A.V. Yeremin, A.N. Andreyev, S. Saro
1997Ho12	NUPAB	621,	689	A. Honkanen, P. Dendooven, M. Huhta, G. Lhersonneau, P.O. Lipas, M. Oinonen, J.-M. Parmonen, H. Penttilä, K. Peräjärvi, T. Siiskonen, J. Äystö
1997Ho14	ZPAAD	358,	377	S. Hofmann, F.P. Heßberger, V. Ninov, P. Armbruster, G. Münzenberg, C. Stodel, A.G. Popeko, A.V. Yeremin, S. Saro, M. Leino
1997Ir01	PRVCA	55,	1621	R.J. Irvine, C.N. Davids, P.J. Woods, D.J. Blumenthal, L.T. Brown, L.F. Conticchio, T. Davinson, D.J. Henderson, J.A. Mackenzie, H.T. Penttilä, D. Seweryniak, W.B. Walters
1997Is13	NIMAE	395,	210	T. Ishii, M. Itoh, M. Ishii, A. Makishima, M. Ogawa, I. Hossain, T. Hayakawa, T. Kohno
1997Ja12	NUPAB	627,	119	Z. Janas, A. Płochocki, J. Szerypo, R. Collatz, Z. Hu, H. Keller, R. Kirchner, O. Klepper, E. Roeckl, K. Schmidt, R. Bonetti, A. Guglielmetti, G. Poli, A. Piechaczek
1997Ju02	PRVCA	56,	118	E.T. Journey, J.W. Starnner, J.E. Lynn, S. Raman
1997Ko13	NUPAB	617,	91	F.G. Kondev, G.D. Dracoulis, A.P. Byrne, T. Kibédi, S. Bayer
1997Ko65	NIMAE	401,	289	V.T. Koslowsky, E. Hagberg, J.C. Hardy, G. Savard, H. Schmeing, K.S. Sharma, X.J. Sun

1997Li12	PRVCA	55,	2768	C.F. Liang, P. Paris, R.K. Sheline
1997Li23	PRVCA	56,	2324	C.F. Liang, P. Paris, R.K. Sheline
1997Li25	ZPAAD	359,	1	W. Liu, M. Hellström, R. Collatz, J. Benlliure, L. Chulkov, D. Cortina Gil, F. Farget, H. Grawe, Z. Hu, N. Iwasa, M. Pfützner, A. Piechaczek, R. Raabe, I. Reusen, E. Roeckl, G. Vancraeynest, A. Wöhr
1997Lo.A	PrvCom	GAu	May	R.W. Loughheed
1997Ma75	NIMAE	390,	267	R.H. Martin, K.I.W. Burns, J.G.V. Taylor
1997Mi03	PRVCA	55,	1555	S. Mitsuoka, H. Ikezoe, T. Ikuta, Y. Nagame, K. Tsukada, I. Nishinaka, Y. Oura, Y.L. Zhao
1997Mu02	ZPAAD	356,	367	J. Mukai, N. Hashimoto, T. Saitoh, M. Matsuda, T. Hayakawa, J. Lu, T. Komatsubara, K. Furuno
1997Mu08	PRVCA	55,	2267	U. Müller, P. Sevenich, K. Freitag, C. Günther, P. Herzog, G.D. Jones, C. Kliem, J. Manns, T. Weber, B. Will, ISOLDE
1997No.A	AnRpt Riken		74	M. Notani, N. Aoi, N. Fukuda, E. Ideguchi, M. Ishihara, H. Iwasaki, H. Ogawa, T. Kubo, S.M. Lukyanov, T. Nakamura, Yu. E. Penionzhkevich, H. Sakurai, T. Teranishi, Y.X. Watanabe, K. Yoneda, A. Yoshida
1997Oi01	PRVCA	56,	745	M. Oinonen, A. Jokinen, J. Äystö, P. Baumann, F. Didierjean, A. Honkanen, A. Huck, M. Huysse, A. Knipper, G. Marguier, Yu. Novikov, A. Popov, M. Ramdhané, D.M. Seliverstov, P. Van Duppen, G. Walter, ISOLDE
1997Pu01	ZPAAD	357,	3	Y.H. Pu, K. Morita, M.G. Hies, K.O. Lee, A. Yoshida, T. Nomura, Y. Tagaya, T. Motobayashi, M. Kurokawa, H. Minemura, T. Uchibori, T. Ariga, K. Sueki, S.A. Shin
1997Ro26	IEIMA	46,	560	S. Röttger, A. Paul, U. Keyser
1997Sc30	NUPAB	624,	185	K. Schmidt, P.C. Divari, Th. W. Elze, R. Grzywacz, Z. Janas, I.P. Johnstone, M. Karny, H. Keller, R. Kirchner, O. Klepper, A. Płochocki, E. Roeckl, K. Rykaczewski, L.D. Skouras, J. Szerypo, J. Żylicz
1997Sh09	PRVCA	55,	1162	R.K. Sheline, C.F. Liang, P. Paris, A. Gizon
1997Su06	NUPAB	616,	341c	K. Sümmerer, R. Schneider, T. Faestermann, J. Friese, H. Geissel, R. Gernhäuser, H. Gilg, F. Heine, J. Homolka, P. Kienle, H.-J. Korner, G. Münzenberg, J. Reinhold, K. Zeitelhack
1997Sz04	ZPAAD	359,	117	J. Szerypo, R. Grzywacz, Z. Janas, M. Karny, M. Pfützner, A. Płochocki, K. Rykaczewski, J. Żylicz, M. Huysse, G. Reusen, J. Schwarzenberg, P. Van Duppen, A. Woehr, H. Keller, R. Kirchner, O. Klepper, A. Piechaczek, E. Roeckl, K. Schmidt, L. Batist, A. Bykov, V. Wittman, B.A. Brown
1997Ta22	PYLBB	409,	64	O. Tarasov, R. Allatt, J.C. Angélique, R. Anne, C. Borcea, Z. Dlouhy, C. Donzaud, S. Grevy, D. Guillemaud-Mueller, M. Lewitowicz, S. Lukyanov, A.C. Mueller, F. Nowacki, Yu. Oganessian, N.A. Orr, A.N. Ostrowski, R.D. Page, Yu. Penionzhkevich, F. Pougheon, A. Reed, M.G. Saint-Laurent, W. Schwab, E. Sokol, O. Sorlin, W. Trinder, J.S. Winfield
1997Te07	PYLBB	407,	110	T. Teranishi, S. Shimoura, Y. Ando, M. Hirai, N. Iwasa, T. Kikuchi, S. Moriya, T. Motobayashi, H. Murakami, T. Nakamura, T. Nishio, H. Sakurai, T. Uchibori, Y. Watanabe, Y. Yanagisawa, M. Ishihara
1997Uu01	ZPAAD	358,	375	J. Uusitalo, M. Leino, R.G. Allatt, T. Enqvist, K. Eskola, P.T. Greenlees, S. Hurskanen, A. Keenan, H. Kettunen, P. Kuusiniemi, R.D. Page, W.H. Trzaska
1997Wa05	PRVCA	55,	1192	J. Wauters, J.C. Batchelder, C.R. Bingham, D.J. Blumenthal, L.T. Brown, L.F. Conticchio, C.N. Davids, T. Davinson, R.J. Irvine, D. Seweryniak, K.S. Toth, W.B. Walters, P.J. Woods, E.F. Zganjar
1997Wo06	NUPAB	621,	289c	A. Wöhr, A. Andreev, N. Bijmens, J. Breitenbach, S. Franchoo, M. Huysse, Y.A. Kudryavtsev, A. Piechaczek, R.R. Raabe, G. Reusen, L. Vermeeren, P. Van Duppen
1997Xu01	PRVCA	55,	R553	X.J. Xu, W.X. Huang, R.C. Ma, Z.D. Gu, Y.F. Yang, Y.Y. Wang, C.F. Dong, L.L. Xu
1997Za07	PRLTA	79,	4306	K. Zaerpoor, Y.D. Chan, D.E. DiGregorio, M.R. Dragowsky, M.M. Hindi, M.C.P. Isaac, K.S. Krane, R.M. Larimer, A.O. Macchiavelli, R.W. Macleod, P. Mincinovic, E.B. Norman

1997Zi04	NUPAB	619,	151	M. Zinser, F. Humbert, T. Nilsson, W. Schwab, H. Simon, T. Aumann, M.J.G. Borge, L.V. Chulkov, J. Cub, Th. W. Elze, H. Emling, H. Geissel, D. Guillemaud-Mueller, P.G. Hansen, R. Holzmann, H. Irnich, B. Jonsson, J.V. Kratz, R. Kulessa, Y. Leifels, H. Lenske, A. Magel, A.C. Mueller, G. Münzenberg, F. Nickel, G. Nyman, A. Richter, K. Riisager, C. Scheidenberger, G. Schrieder, K. Stelzer, J. Stroth, A. Surowiec, O. Tengblad, E. Wajda, E. Zude
			1998	
1998Ag.A	P-Bellaire		809	J. Agramunt, A. Algora, L. Batist, R. Borcea, D. Cano-Ott, R. Collatz, A. Gadea, J. Gerl, M. Gierlik, M. Gorska, O. Guilbaud, H. Grawe, M. Hellström, Z. Hu, Z. Janas, M. Karny, R. Kirchner, P. Kleinheinz, W. Liu, T. Martinez, F. Moroz, A. Płochocki, M. Rejmund, E. Roeckl, B. Rubio, K. Ryckaczewski, M. Shibata, J. Szerypo, J.L. Tain, V. Wittmann, EUROBALL
1998Am04	EPJAA	1,	275	F. Ameil, M. Bernas, P. Armbruster, S. Czajkowski, P. Dessagne, H. Geissel, E. Hanelt, C. Kozhuharov, C. Miché, C. Donzaud, A. Grewe, A. Heinz, Z. Janas, M. de Jong, W. Schwab, S. Steinhäuser
1998At04	ARISE	49,	1175	M.R.P. Attie, M.F. Koskinas, M.S. Dias, K.A. Fonseca
1998Ax02	NUPAB	634,	475	L. Axelsson, J. Äystö, M.J.G. Borge, L.M. Fraile, H.O.U. Fynbo, A. Honkanen, P. Hornshøj, A. Jokinen, B. Jonson, P.O. Lipas, I. Martel, I. Mukha, T. Nilsson, G. Nyman, B. Petersen, K. Riisager, M.H. Smedberg, O. Tengblad, ISOLDE, and PrvCom GAU December 1997, and erratum NUPAB 641,529
1998Az01	PRVCA	57,	628	A. Azhari, T. Baumann, J.A. Brown, M. Hellström, J.H. Kelley, R.A. Kryger, D.J. Millener, H. Madani, E. Ramakrishnan, D.E. Russ, T. Suomijarvi, M. Thoennessen, S. Yokoyama
1998Ba13	PRVCA	57,	1042	J.C. Batchelder, C.R. Bingham, K. Rykaczewski, K.S. Toth, T. Davinson, J.A. McKenzie, P.J. Woods, T.N. Ginter, C.J. Gross, J.W. McConnell, E.F. Zganjar, J.H. Hamilton, W.B. Walters, C. Baktash, J. Greene, J.F. Mas, W.T. Milner, S.D. Paul, D. Shapira, X.J. Xu, C.H. Yu
1998Ba83	PRVCA	58,	2571	P.H. Barker, P.A. Amundsen
1998Ba85	NUPAB	641,	133	M. Balodis, P. Prokofjevs, N. Krāmere, L. Simonova, J. Bērziņš, T. Krasta, J. Kern, A. Raemy, J.C. Dousse, W. Schwitz, J.A. Cizewski, G.G. Colvin, H.G. Börner, P. Geltenbort, F. Hoyler, S.A. Kerr, K. Schreckenbach, R. Georgii, T. von Egidy, J. Klora, H. Lindner, U. Mayerhofer, A. Walter, A.V. Murzin, V.A. Libman, I.A. Kondurov, Yu. E. Loginov, P.A. Sushkov, S. Brant, V. Paar, V. Lopac
1998Ba.A	P-Bellaire		90	Y. Bai, D.J. Vieira, H.L. Seifert, J.M. Wouters, and PrvCom AHW June 1998
1998Ba.B	P-Bellaire		264	J.C. Batchelder, C.R. Bingham, K. Rykaczewski, K.S. Toth, T. Davinson, T.N. Ginter, C.J. Gross, R. Grzywacz, Z. Janas, M. Karny, S.H. Kim, B.D. MacDonald, J.F. Mas, J.W. McConnell, A. Piechaczek, J.J. Ressler, R.C. Slinger, J. Szerypo, W.B. Walters, W. Weintraub, P.J. Woods, C.-H. Yu, E.F. Zganjar
1998Be19	PRVCA	57,	2740	T. Belgya, B. Fazekas, Zs. Kasztovszky, Zs. Revay, G. Molnar, M. Yeh, P.E. Garrett, S.W. Yates
1998Be28	NUPAB	636,	419	A.V. Belozorov, R. Kalpakchieva, Yu. E. Penionzhkevich, Z. Dlouhy, S. Piskor, J. Vincour, H.G. Bohlen, M. von Lucke-Petsch, A.N. Ostrowski, D.V. Alexandrov, E. Yu. Nikolsky, B.G. Novatsky, D.N. Stepanov
1998Bh04	PRVCA	58,	1247	M. Bhattacharya, A. García, M.M. Hindi, E.B. Norman, C.E. Ortiz, N.I. Kaloskamis, C.N. Davids, O. Civitarese, J. Suhonen
1998Bh12	PRVCA	58,	3677	M. Bhattacharya, A. García, N.I. Kaloskamis, E.G. Adelberger, H.E. Swanson, R. Anne, M. Lewitowicz, M.G. Saint-Laurent, W. Trindler, C. Donzaud, D. Guillemaud-Mueller, S. Leenhardt, A.C. Mueller, F. Pougheon, O. Sorlin
1998Bi.A	P-Bellaire		474	C.R. Bingham, J.C. Batchelder, J.A. Cizewski, C.N. Davids, R.J. Irvine, W. Reviol, D. Sewerniak, K.S. Toth, W.B. Walters, J. Wauters, J.L. Wood, X.J. Xu, J. Uusitalo, E.F. Zganjar
1998Bo30	NUPAB	642,	419	R. Böttger, H. Schölermann

1998Ch20	NUPAB	637,	3	M. Chartier, W. Mittig, N.A. Orr, J.-C. Angélique, G. Audi, J.-M. Casandjian, A. Cunsolo, C. Donzaud, A. Foti, A. Lépine-Szily, M. Lewitowicz, S. Lukyanov, M. MacCormick, D.J. Morrissey, A.N. Ostrowski, B.M. Sherril, C. Stéphan, T. Suomijärvi, L. Tassan-Got, D.J. Vieira, A.C.C. Villari, J.M. Wouters
1998Co27	EPJAA	3,	17	J.F.C. Cocks, M. Muikku, W. Korten, R. Wadsworth, S. Chmel, J. Domscheit, P.T. Greenlees, K. Helariutta, I. Hibbert, M. Houry, D. Jenkins, P. Jones, R. Julin, S. Juutinen, H. Kankaanpää, H. Kettunen, P. Kuusiniemi, M. Leino, Y. Le Coz, R. Lucas, E. Mergel, R.D. Page, A. Savelius, W. Trzaska
1998Cz01	NUPAB	628,	537	C. Czajkowski, S. Andriamonje, B. Blank, F. Boué, R. Del Moral, J.P. Dufour, A. Fleury, P. Pourre, M.S. Pravikoff, E. Hanelt, K.-H. Schmidt, N.A. Orr
1998Da03	PRLTA	80,	1849	C.N. Davids, P.J. Woods, D. Seweryniak, A.A. Sonzogni, J.C. Batchelder, C.R. Bingham, T. Davinson, D.J. Henderson, R.J. Irvine, G.L. Poli, J. Uusitalo, W.B. Walters
1998Da23	NUPAB	643,	317	F.A. Danevich, A. Sh. Georgadze, V.V. Kobychyev, B.N. Kropivnyansky, A.S. Nikolaiko, O.A. Ponkratenko, V.I. Tretyak, Yu. G. Zdesenko
1998Dr09	PRVCA	58,	1837	G.D. Dracoulis, A.P. Byrne, S.M. Mullins, T. Kibédi, F.G. Kondev, P.M. Davidson
1998En.A	PrvCom	AHW	Aug	T. Enqvist, et al (PrvCom of H. Geissel)
1998Es02	PRVCA	57,	417	K. Eskola, P. Kuusiniemi, M. Leino, J.F.C. Cocks, T. Enqvist, S. Hurskanen, H. Kettunen, W.H. Trzaska, J. Uusitalo, R.G. Allat, P.T. Greenlees, R.D. Page
1998Fo06	PRVCA	58,	749	B.D. Foy, D.S. Brenner, C.N. Davids, D. Seweryniak, D. Blumenthal, R.L. Gill, N.V. Zamfir, D.D. Warner, C.J. Barton
1998Ge13	EPJAA	3,	225	U. Georg, W. Borchers, M. Keim, A. Klein, P. Lievens, R. Neugart, M. Neuroth, P.M. Rao, Ch. Schulz, ISOLDE
1998Gr12	PYLBB	429,	247	R. Grzywacz, S. Andriamonje, B. Blank, F. Boué, S. Czajkowski, F. Davi, R. Del Moral, C. Donzaud, J.P. Dufour, A. Fleury, H. Grawe, A. Grewe, A. Heinz, Z. Janas, A.R. Junghans, M. Karny, M. Lewitowicz, A. Musquère, M. Pfützner, M.-G. Porquet, M.S. Pravikoff, J.-E. Sauvestre, K. Sümmerer
1998Gr14	PRLTA	81,	766	R. Grzywacz, R. Béraud, C. Borcea, A. Emsallem, M. Glogowski, H. Grawe, D. Guillemaud-Mueller, M. Hjorth-Jensen, M. Houry, M. Lewitowicz, A.C. Mueller, A. Nowak, A. Płochocki, M. Pfützner, K. Rykaczewski, M.G. Saint-Laurent, J.-E. Sauvestre, M. Schaefer, O. Sorlin, J. Szerypo, W. Trinder, S. Viteritti, J. Winfield
1998Gr.A	B-Bellaire		C7	R. Grzywacz (and oral presentation)
1998Gr.B	P-Bellaire		430	R. Grzywacz
1998Gu10	PRVCA	58,	116	V. Guimarães, S. Kubono, N. Ikeda, I. Katayama, T. Nomura, M.H. Tanaka, Y. Fuchi, H. Kawashima, S. Kato, H. Toyokawa, C.C. Yun, T. Niizeki, T. Kubo, M. Ohura, M. Hosaka
1998Ha36	PRVCA	58,	821	P.D. Harty, N.S. Bowden, P.H. Barker, P.A. Amundsen
1998He.B	Th.-Boulder			T.P. Heavner
1998Ho13	RPPHA	61,	639	S. Hofmann
1998Ic02	PRVCA	58,	1329	S. Ichikawa, K. Tsukada, I. Nishinaka, Y. Hatsukawa, H. Iimura, K. Hata, Y. Nagame, M. Asai, Y. Kojima, T. Hirose, M. Shibata, K. Kawade, Y. Oura
1998Ik01	PRVCA	57,	2804	T. Ikuta, H. Ikezoe, S. Mitsuoka, I. Nishinaka, K. Tsukada, Y. Nagame, J. Lu, T. Kuzumaki
1998Ik02	EPJAA	2,	379	H. Ikezoe, T. Ikuta, S. Mitsuoka, Y. Nagame, I. Nishinaka, K. Tsukada, T. Ohtsuki, T. Kuzumaki, J. Lu
1998Is06	EPJAA	2,	173	S. Issmer, M. Fruneau, J.A. Pinston, M. Asghar, D. Barnéoud, J. Genevey, Th. Kerscher, K.E.G. Löbner
1998Is11	PRLTA	81,	4100	T. Ishii, M. Asai, I. Hossain, P. Kleinheinz, M. Ogawa, A. Makishima, S. Ichikawa, M. Itoh, M. Ishii, J. Blomqvist
1998Jo.A	PrvCom	AHW	Mar	T. Johansson, I. Bergström, et al
1998Ka42	NUPAB	640,	3	M. Karny, L. Batist, B.A. Brown, D. Cano-Ott, R. Collatz, A. Gadea, R. Grzywacz, A. Guglielmetti, M. Hellström, Z. Hu, Z. Janas, R. Kirchner, F. Moroz, A. Piechaczek, A. Płochocki, E. Roeckl, B. Rubio, K. Rykaczewski, M. Shibata, J. Szerypo, J.L. Tain, V. Wittmann, A. Wöhr

1998Ka.A	AnRpt GSI		22	M. Karny, L. Batist, D. Cano, R. Collatz, A. Gadea, M. Gierlik, R. Grzywacz, A. Guglielmetti, M. Hellström, Z. Hu, Z. Janas, R. Kirchner, F. Moroz, A. Piechaczek, A. Plochocki, E. Roeckl, B. Rubio, K. Rykaczewski, M. Shibata, J. Szerypo, J.L. Tain, V. Wittmann, A. Wöhr
1998Ki20	PYLBB	443,	82	S.L. King, J. Simpson, R.D. Page, N. Amzal, T. Bäck, B. Cederwall, J.F.C. Cocks, D.M. Cullen, P.T. Greenlees, M.K. Harder, K. Helariutta, P. Jones, R. Julin, S. Juutinen, H. Kankaanpää, A. Keenan, H. Kettunen, P. Kuusiniemi, M. Leino, R. Lemmon, M. Muikku, A. Savelius, J. Uusitalo, P. Van Isacker
1998Ko09	NUPAB	632,	473	F.G. Kondev, G.D. Dracoulis, A.P. Byrne, T. Kibédi
1998Ko66	JUPSA	67,	3405	Y. Kojima, M. Asai, A. Osa, M. Koizumi, T. Sekine, M. Shibata, H. Yamamoto, K. Kawade, T. Tachibana
1998Ku17	EPJAA	2,	241	J. Kurpeta, G. Lhersonneau, J.C. Wang, P. Dendooven, A. Honkanen, M. Huhta, M. Oinonen, H. Penttilä, K. Peräjärvi, J.R. Persson, A. Plochocki, J. Äystö
1998Le15	EPJAA	2,	9	A.I. Levon, J. de Boer, M. Loewe, M. Würkner, T. Czosnyka, J. Iwanicki, P.J. Napiorkowski
1998Li50	PYLBB	440,	246	M. Lipoglavšek, D. Seweryniak, C.N. Davids, C. Fahlander, M. Górská, R.V.F. Janssens, J. Nyberg, J. Uusitalo, W.B. Walters, I. Ahmad, J. Blomqvist, M.P. Carpenter, J.A. Cizewski, S.M. Fischer, H. Grawe, G. Hackman, M. Huhta, C.J. Lister, D. Nisius, G. Poli, P. Reiter, J. Ressler, J. Schwartz, A. Sonzogni
1998Lu08	EPJAA	2,	149	X. Lu, J. Guo, K. Zhao, Y. Cheng, Y. Ma, Z. Li, S. Li, M. Ruan
1998Mo30	EPJAA	3,	99	T. Morek, K. Starosta, Ch. Droste, D. Fossan, G. Lane, J. Sears, J. Smith, P. Vaska
1998No.A	P-Bellaire		359	M. Notani, N. Aoi, N. Fukuda, H. Iwasaki, K. Yoneda, H. Ogawa, T. Teranishi, S.M. Lukyanov, Yu. E. Penionzhkevich, T. Nakamura, H. Sakurai, E. Ideguchi, A. Yoshida, Y. Watanabe, T. Kubo, M. Ishihara
1998Pf02	PYLBB	444,	32	M. Pfützner, P. Armbruster, T. Baumann, J. Benlliure, M. Bernas, W.N. Catford, D. Cortina-Gil, J.M. Daugas, H. Geissel, M. Górská, H. Grawe, R. Grzywacz, M. Hellström, N. Iwasa, Z. Janas, A.R. Junghans, M. Karny, S. Leenhardt, M. Lewitowicz, A.C. Mueller, F. de Oliveira, P.H. Regan, M. Rejmund, K. Rykaczewski, K. Sümmerer
1998Po.A	PrvCom	GAu	Mar	F. Pougheon
1998Ru04	PRVCA	58,	771	D. Rupnik, E.F. Zganjar, J.L. Wood, P.B. Semmes, P.F. Mantica
1998Sh21	ARISE	49,	1481	M. Shibata, Y. Satoh, S. Itoh, H. Yamamoto, K. Kawade, Y. Kasugai, Y. Ikeda
1998Si12	ARISE	49,	1397	H. Siegert, H. Schrader, U. Schötzgig
1998So03	NUPAB	632,	205	O. Sorlin, V. Borrel, S. Grévy, D. Guillemaud-Mueller, A.C. Mueller, F. Pougheon, W. Böhmer, K.-L. Kratz, T. Mehren, P. Möller, B. Pfeiffer, T. Rauscher, M.G. Saint-Laurent, R. Anne, M. Lewitowicz, A. Ostrowski, T. Dörfler, W.-D. Schmidt-Ott
1998St24	NUPAB	641,	401	A.E. Stuchbery, G.D. Dracoulis, T. Kibedi, A.P. Byrne, B. Fabricius, A.R. Poletti, G.J. Lane, A.M. Baxter
1998Su16	EPJAA	2,	237	M. Sugawara, H. Kusakari, T. Murakami, T. Kohno
1998Ti06	NUPAB	636,	249	D.R. Tilley, C.M. Cheves, J.H. Kelley, S. Raman, H.R. Weller
1998To14	PRVCA	58,	1310	K.S. Toth, X.-J. Xu, C.R. Bingham, J.C. Batchelder, L.F. Conticchio, W.B. Walters, L.T. Brown, C.N. Davids, R.J. Irvine, D. Seweryniak, J. Wauters, E.F. Zganjar
1998Tu01	PRVCA	57,	1648	A. Türler, R. Dressler, B. Eichler, H.W. Gäggeler, D.T. Jost, M. Schädel, W. Bröchle, K.E. Gregorich, N. Trautmann, S. Taut
1998Ut02	PRVCA	57,	2731	S. Utku, J.G. Ross, N.P.T. Bateman, D.W. Bardayan, A.A. Chen, J. Görres, A.J. Howard, C. Iliadis, P.D. Parker, M.S. Smith, R.B. Vogelaar, M. Wiescher, K. Yildiz; erratum Phys. Rev. C58, 1354 (1998)
1998Vi06	PYLBB	437,	264	S.M. Vincent, P.H. Regan, D.D. Warner, R.A. Bark, D. Blumenthal, M.P. Carpenter, C.N. Davids, W. Gelletly, R.V.F. Janssens, C.D. O'Leary, C.J. Lister, J. Simpson, D. Seweryniak, T. Saitoh, J. Schwartz, S. Törmänen, O. Juillet, F. Nowacki, P. Van Isacker
1998Wa.A	PrvCom	AHW	Feb	A.H. Wapstra
1998Wh01	PRVCA	57,	1112	D.H. White, R.W. Hoff, H.G. Börner, K. Schreckenbach, F. Hoyler, G. Colvin, I. Ahmad, A.M. Friedman, J.R. Erskine

1998Wh02	PYLBB	425,	239	C. Wheldon, R. D'Alarcao, P. Chowdhury, P.M. Walker, E. Seabury, I. Ahmad, M.P. Carpenter, D.M. Cullen, G. Hackman, R.V.F. Janssens, T.L. Khoo, D. Nisius, C.J. Pearson, P. Reiter
1998Wi.A	P-Bellaire		606	J.A. Winger, H.H. Yousif, W.C. Ma, V. Ravikumar, W. Lui, S.K. Phillips, R.B. Piercy, P.F. Mantica, B. Pritychenko, R.M. Ronningen, M. Steiner
1998Wu01	PRLTA	80,	2085	A.H. Wuosmaa, I. Ahmad, S.M. Fischer, J.P. Greene, G. Hackman, V. Nanal, G. Savard, J.P. Schiffer, P. Wilt, S.M. Austin, B.A. Brown, S.J. Freedman, J.J. Connell
1998Zh03	EPJAA	1,	1	Y.H. Zhang, Q.Z. Zhao, S.F. Zhu, H.S. Xu, X.H. Zhou, Y.X. Guo, X.G. Lei, J. Lu, Q.B. Gou, H.J. Jin, Z. Liu, Y.X. Luo, X.F. Sun, Y.T. Zhu
1998Zh09	NUPAB	628,	386	C.T. Zhang, P. Bhattacharyya, P.J. Daly, Z.W. Grabowski, R.H. Mayer, M. Sferazza, R. Broda, B. Fornal, W. Królas, T. Pawlat, D. Bazzacco, S. Lunardi, C. Rossi Alvarez, G. de Angelis
1998Zh22	PRVCA	58,	156	L. Zhang, J. Zhao, J. Zheng, J. Wang, Z. Qin, Y. Yang, C. Zhang, G. Jin, G. Guo, Y. Du, T. Guo, T. Wang, B. Guo, J. Tian, Y. Lou
			1999	
1999Al20	PYLBB	457,	253	A. Alessandrello, J.W. Beeman, C. Brofferio, O. Cremonesi, E. Fiorini, A. Giuliani, E.E. Haller, B. Margesin, A. Monfardini, A. Nucciotti, M. Pavan, G. Pessina, G. Pignatelli, E. Previtali, L. Zanotti, M. Zen
1999Am05	NUPAB	651,	3	F. Ames, G. Audi, D. Beck, G. Bollen, M. de Saint Simon, R. Jertz, H.-J. Kluge, A. Kohl, M. König, D. Lunney, I. Martel, R.B. Moore, T. Otto, Z. Patyk, H. Raimbault-Hartmann, G. Rouleau, G. Savard, E. Scharck, S. Schwarz, L. Schweikhard, H. Stolzenberg, J. Szerypo, ISOLDE
1999An10	PRLTA	82,	1819	A.N. Andreyev, M. Huyse, P. Van Duppen, J.F.C. Cocks, K. Helariutta, H. Kettunen, P. Kuusiniemi, M. Leino, W.H. Trzaska, K. Eskola, R. Wyss
1999An36	APOBB	30,	1255	A.N. Andreyev, N. Bijmens, J.F. Cocks, K. Eskola, K. Helariutta, M. Huyse, H. Kettunen, P. Kuusiniemi, M. Leino, W.H. Trzaska, P. Van Duppen, R. Wyss
1999An52	EPJAA	6,	381	A.N. Andreyev, D. Ackermann, P. Cagarda, J. Gerl, F. Heßberger, S. Hofmann, M. Huyse, A. Keenan, H. Kettunen, A. Kleinbohl, A. Lavrentiev, M. Leino, B. Lommel, M. Matos, G. Münzenberg, C. Moore, C.D. O'Leary, R.D. Page, S. Reshitko, S. Saro, C. Schlegel, H. Schaffner, M. Taylor, P. Van Duppen, L. Weissman, R. Wyss
1999Ar25	NUPAB	658,	299	R. Arnold, C. Augier, J. Baker, A. Barabash, D. Blum, V. Brudanin, A.J. Caffrey, J.E. Campagne, E. Caurier, D. Dassié, V. Egorov, T. Filipova, R. Gurriaran, J.L. Guyonnet, F. Hubert, Ph. Hubert, S. Jullian, I. Kisel, O. Kochetov, V.N. Kornoukhov, V. Kovalenko, D. Lalanne, F. Laplanche, F. Leccia, I. Linck, C. Longuemare, Ch. Marquet, F. Mauger, H.W. Nicholson, I. Pilugin, F. Piquemal, J.-L. Reyss, X. Sarazin, F. Scheibling, J. Suhonen, C.S. Sutton, G. Szklarz, V. Timkin, R. Torres, V.I. Tretyak, V. Umatov, I. Vanyushin, A. Varelle, Yu. Vasilyev, Ts. Vylov
1999As03	PRVCA	59,	3060	M. Asai, S. Ichikawa, K. Tsukada, M. Sakama, M. Shibata, Y. Kojima, A. Osa, I. Nishinaka, Y. Nagame, K. Kawade, T. Tachibana
1999Ba45	EPJAA	5,	49	J.C. Batchelder, K.S. Toth, C.R. Bingham, L.T. Brown, L.F. Conticchio, C.N. Davids, R.J. Irvine, D. Sewerniak, W.B. Walters, J. Wauters, E.F. Zganjar, J.L. Wood, C. De Coster, B. Decroix, K. Heyde
1999Be53	NUPAB	658,	129	U.C. Bergmann, L. Axelsson, M.J.G. Borge, V.N. Fedoseyev, C. Forssén, H.O.U. Fynbo, S. Grévy, P. Hornshøj, Y. Jading, B. Jonson, U. Köster, K. Markenroth, F.M. Marqués, V.I. Mishin, T. Nilsson, G. Nyman, A. Oberstedt, H.L. Ravn, K. Riisager, G. Schrieder, V. Sebastian, H. Simon, O. Tengblad, F. Wenander, K. Wilhelmssen Rolander, ISOLDE
1999Be63	NUPAB	660,	87	J. Benlliure, K.-H. Schmidt, D. Cortina-Gil, T. Enqvist, F. Farget, A. Heinz, A.R. Junghans, J. Pereira, J. Taieb
1999Be64	NUPBB	563,	97	P. Belli, R. Bernabei, C.J. Dai, F. Grianti, H.L. He, G. Ignesti, A. Incicchitti, H.H. Kuang, J.M. Ma, F. Montecchia, O.A. Ponkratenko, D. Prospero, V.I. Tretyak, Yu. G. Zdesenko

1999Bi14	PRVCA	59,	2984	C.R. Bingham, J. Batchelder, K. Rykaczewski, K.S. Toth, C.-H. Yu, T.N. Ginter, C.J. Gross, R. Grzywacz, M. Karny, S.H. Kim, B.D. MacDonald, J.F. Mas, J.W. McConnell, P.B. Semmes, J. Szerypo, W. Weintraub, E.F. Zganjar
1999Bo26	PPNPD	42,	17	H.G. Bohlen, A. Blazevic, B. Gebauer, W. von Oertzen, S. Thummerer, R. Kalpakchieva, S.M. Grimes, T.N. Massey
1999Br47	PRLTA	83,	4510	M.P. Bradley, J.V. Porto, S. Rainville, J.K. Thompson, D.E. Pritchard, and Prv-Com GAU Nov 1999
1999Ca21	EPJAA	5,	1	G. Canchell, R. Béraud, E. Chabanat, E. Emsallem, N. Redon, P. Dendooven, J. Huikari, A. Jokinen, V. Kolhinen, G. Lhersonneau, M. Oinonen, A. Nieminen, H. Penttilä, K. Peräjärvi, J.C. Wang
1999Ca46	PRLTA	83,	4506	C. Carlberg, T. Fritioff, I. Bergström
1999Co13	JPGPE	25,	839	J.F.C. Cocks, and the JUROSPHERE Collaboration
1999Da.A	GANIL-T9905			J.-M. Daugas Thesis
1999DI01	JPGPE	25,	859	Z. Dlouhý, Yu. Penionzhkevich, R. Anne, D. Baiborodin, C. Borcea, A. Fomichev, D. Guillemaud-Mueller, R. Kalpakchieva, M. Lewitowicz, S. Lukyanov, A.C. Mueller, Yu. Oganessian, R.D. Page, A. Reed, M.G. Saint-Laurent, E. Sokol, N. Skobelev, O. Sorlin, O. Tarasov, V. Toneev, W. Trinder
1999Dr09	PRVCA	59,	3433	R. Dressler, B. Eichler, D.T. Jost, D. Piguët, A. Tuerler, Ch. Duehlmann, R. Eichler, H.W. Gaeggeler, M. Gaertner, M. Schaedel, S. Taut, A.B. Yakushev
1999Dr10	PRVCA	60,	014303	G.D. Dracoulis, A.P. Byrne, A.M. Baxter, P.M. Davidson, T. Kibedi, T.R. McGoram, R.A. Bark, S.M. Mullins
1999Dr13	JPGPE	25,	1839	O. Dragoun, A. Spalek, M. Rysavy, A. Kovalik, E.A. Yakushev, V. Brabec, A.F. Novgorodov, N. Dragounova, J. Rizek
1999Fe10	EPJAA	6,	235	X.C. Feng, Y.X. Guo, X.H. Zhou, X.F. Sun, X.G. Lei, W.X. Huang, J.J. He, Z. Liu, Y.H. Zhang, S.F. Zhu, Y.X. Luo, S.X. Wen, G.J. Yuan, X.G. Wu
1999Fo01	PRLTA	82,	1823	B. Fogelberg, K.A. Mezilev, H. Mach, V.I. Isakov, J. Slivova
1999Fo.A	PrvCom	GAU	Oct	K. Foehl
1999Ga41	EPJAA	6,	59	Z.G. Gan, Z. Qin, J.S. Guo, L.J. Shi, H.Y. Liu, T.R. Guo, X.G. Lei, R.C. Ma, W.X. Huang, S.G. Yuan, X.Q. Zhang, G.M. Jin
1999Ga.A	B-Seeheim		034	H.W. Gäggeler, R. Dressler, A. Türler, D.T. Jost, B. Eichler, H.R. von Gunten
1999Ge01	PRVCA	59,	82	J. Genevey, F. Ibrahim, J.A. Pinston, H. Faust, T. Friedrichs, M. Gross, S. Oberstedt
1999Gi14	NUPAB	658,	97	J. Gizon, A. Gizon, J. Timár, Gh. Cata-Danil, B.M. Nyakó, L. Zolnai, A.J. Boston, D.T. Joss, E.S. Paul, A.T. Semple, N.J. O'Brien, C.M. Parry, D. Bucurescu, S. Brant, V. Paar
1999Gr28	EPJAA	6,	269	P.T. Greenlees, P. Kuusiniemi, N. Amzal, A. Andreyev, P.A. Butler, K.J. Cann, J.F.C. Cocks, O. Dorvaux, T. Enqvist, P. Fallon, B. Gall, M. Guttormsen, D. Hawcroft, K. Helariutta, F.P. Heßberger, F. Hoellinger, G.D. Jones, P. Jones, R. Julin, S. Juutinen, H. Kankaanpää, H. Kettunen, M. Leino, S. Messelt, M. Muikku, S. Ødegård, R.D. Page, A. Savelius, A. Schiller, S. Siem, W.H. Trzaska, T. Tveter, J. Uusitalo
1999Ha05	PRLTA	82,	1391	M. Hannawald, T. Kautsch, A. Wöhr, W.B. Walters, K.-L. Kratz, V.N. Fedoseyev, V.L. Mishin, W. Böhmer, B. Pfeiffer, V. Sebastian, Y. Jading, U. Köster, J. Lettry, H.L. Ravn, ISOLDE
1999He11	JPGPE	25,	877	F.P. Heßberger
1999Ho01	NUPAB	645,	331	J. Honzátko, I. Tomandl, V. Bondarenko, D. Bucurescu, T. von Egidy, J. Ott, W. Schauer, H.-F. Wirth, C. Doll, A. Gollwitzer, G. Graw, R. Hertenberg, B.D. Valnion see also 98Ho16
1999Ho09	PYLBB	451,	247	E. Holzschuh, W. Kündig, L. Palermo, H. Stüssi, P. Wenk
1999Ho28	PRVCA	60,	057301	F. Hoellinger, B.J.P. Gall, N. Schulz, N. Amzahl, P.A. Butler, P.T. Greenlees, D. Hawcroft. J.F.C. Cocks, K. Helariutta, P.M. Jones, R. Julin, S. Juutinen, H. Kankaanpää, H. Kettunen, P. Kuusiniemi, M. Leino, M. Muikku, D. Savelius
1999Hu05	PRVCA	59,	2402	W.X. Huang, R.C. Ma, S.W. Xu, X.J. Xu, J.S. Guo, X.F. Sun, Y.X. Xie, Z.K. Li, Y.X. Ge, Y.Y. Wang, C.F. Wang, T.M. Zhang, G.M. Jin. Y.X. Luo
1999Hu10	PRVCA	60,	024315	Z. Hu, L. Batist, J. Agramunt, A. Algora, B.A. Brown, D. Cano-Ott, R. Collatz, A. Gadea, M. Gierlik, M. Górska, H. Grawe, M. Hellström, Z. Janas, M. Karny, R. Kirchner, F. Moroz, A. Płochocki, M. Rejmund, E. Roeckl, B. Rubio, M. Shibata, T. Szerypo, J.L. Tain, V. Wittmann

1999Ja02	PRLTA	82,	295	Z. Janas, C. Chandler, B. Blank, P.H. Regan, A.M. Bruce, W.N. Catford, N. Curtis, S. Czajkowski, Ph. Dessagne, A. Fleury, W. Gelletly, J. Giovino, R. Grzywacz, M. Lewitowicz, C. Longour, C. Marchand, C. Miché, N.A. Orr, R.D. Page, C.J. Pearson, M.S. Pravikoff, A.T. Reed, M.G. Saint-Laurent, J.A. Sheikh, S.M. Vincent, R. Wadsworth, D.D. Warner, J.S. Winfield
1999Ke05	PYLAA	255,	221	E.G. Kessler, Jr., M.S. Dewey, R.D. Deslattes, A. Henins, H.G. Börner, M. Jentschel, C. Doll, H. Lehmann
1999La14	PRVCA	59,	3086	C.A. Laue, K.E. Gregorich, R. Sudowe, M.B. Hendricks, J.L. Adams, M.R. Lane, D.M. Lee, C.A. McGrath, D.A. Shaughnessy, D.A. Strellis, E.R. Sylwester, P.A. Wilk, D.C. Hoffman
1999Le68	NUPAB	654,	687c	M. Lewitowicz, J.M. Daugas, R. Grzywacz, L. Achouri, J.C. Angélique, D. Baborodin, R. Bentida, R. Béraud, C. Bingham, C. Borcea, W. Catford, A. Emsallem, G. de France, M. Glogowski, H. Grawe, D. Guillemaud-Mueller, M. Houry, S. Hurskanen, K.L. Jones, R.C. Lemmon, A.C. Mueller, A. Nowak, F. de Oliveira-Santos, A. Płochocki, M. Pfützner, P.H. Regan, K. Rykaczewski, M.G. Saint-Laurent, J.E. Sauvestre, M. Sawicka, M. Schaefer, G. Sletten, O. Sorlin, M. Stanoiu, J. Szerypo, W. Trinder, S. Viteritti, J. Winfield
1999Lh01	PRVCA	60,	014315	G. Lhersonneau, J.C. Wang, S. Hankonen, P. Dendooven, P. Jones, R. Julin, J. Äystö
1999Mo30	NUPAB	657,	251	C.-B. Moon, S.J. Chae, T. Komatsubara, T. Shizuma, Y. Sasaki, H. Ishiyama, T. Jumatsu, K. Furuno
1999Na27	PRLTA	83,	1112	T. Nakamura, N. Fukuda, T. Kobayashi, N. Aoi, H. Iwasaki, T. Kubo, A. Mengoni, M. Notani, H. Otsu, H. Sakurai, S. Shimoura, T. Teranishi, Y.X. Watanabe, K. Yoneda, M. Ishihara
1999Ni03	PRLTA	83,	1104	V. Ninov, K.E. Gregorich, W. Loveland, A. Ghiorso, D.C. Hoffman, D.M. Lee, H. Nitsche, W.J. Swiatecki, U.W. Kirbach, C.A. Laue, J.L. Adams, J.B. Patin, D.A. Shaughnessy, D.A. Strellis, P.A. Wilk
1999Og03	PYLBB	451,	11	H. Ogawa, K. Asahi, K. Sakai, A. Yoshimi, M. Tsuda, Y. Uchiyama, T. Suzuki, K. Suzuki, N. Kurokawa, M. Adachi, H. Izumi, H. Ueno, T. Shimoda, S. Tanimoto, N. Takahashi, W.-D. Schmidt-Ott, M. Schäfer, S. Fukuda, A. Yoshida, M. Notani, T. Kubo, H. Okuno, H. Sato, N. Aoi, K. Yoneda, H. Iwasaki, N. Fukuda, N. Fukunishi, M. Ishihara, H. Miyatake
1999Og05	EPJAA	5,	63	Yu. Ts. Oganessian, A.V. Yeremin, G.G. Gulbekian, S.L. Bogomolov, V.I. Chepigin, B.N. Gikal, V.A. Gorshkov, M.G. Itkis, A.P. Kabachenko, V.B. Kutner, A. Yu. Lavrentev, O.N. Malyshev, A.G. Popeko, J. Roháč, R.N. Sagaidak, S. Hofmann, G. Münzenberg, M. Veselsky, S. Saro, N. Iwasa, K. Morita
1999Og07	NATUA	400,	242	Yu. Ts. Oganessian, A.V. Yeremin, A.G. Popeko, S. L. Bogomolov, G.V. Buklanov, M.L. Chelnokov, V.I. Chepigin, B.N. Gikal, V.A. Gorshkov, G.G. Gulbekian, M.G. Itkis, A.P. Kabachenko, A. Yu. Lavrentev, O.N. Malyshev, J. Rohac, R.N. Sagaidak, S. Hofmann, S. Saro, G. Giardina, K. Morita
1999Og10	PRLTA	83,	3154	Yu. Ts. Oganessian, V.K. Utyonkov, Yu. V. Lobanov, F. Sh. Abdullin, A.N. Polyakov, I.V. Shirokovsky, Yu. S. Tsyganov, G.G. Gulbekian, S.L. Bogomolov, B.N. Gikal, A.N. Mezentsev, S. Iliev, V.G. Subbotin, A.M. Sukhov, G.V. Buklanov, K. Subotic, M.G. Itkis, K.J. Moody, J.F. Wild, N.J. Stoyer, M.A. Stoyer, R.W. Loughheed
1999Og.B	B-Seeheim		O5	Yu. Ts. Oganessian, V.K. Utyonkov, Yu. V. Lobanov, F. Sh. Abdullin, A.N. Polyakov, I.V. Shirokovsky, Yu. S. Tsyganov, G.G. Gulbekian, S.L. Bogomolov, B.N. Gikal, A.N. Mezentsev, S. Iliev, V.G. Subbotin, A.M. Sukhov, G.V. Buklanov, K. Subotik, M.G. Itkis, K.J. Moody, J.F. Wild, N.J. Stoyer, R.W. Loughheed, and email
1999Po09	PRVCA	59,	2979	G.L. Poli, C.N. Davids, P.J. Woods, D. Seweryniak, J.C. Batchelder, L.T. Brown, C.R. Bingham, M.P. Carpenter, L.F. Conticchio, T. Davinson, J. de Boer, S. Hamada, D.J. Henderson, R.J. Irvine, R.V.F. Janssens, H.J. Maier, L. Müller, F. Soramel, K.S. Toth, W.B. Walters, J. Wauters
1999Pr10	PRVCA	60,	054307	J.I. Prisciandaro, P.F. Mantica, A.M. Oros-Peusquens, D.W. Anthony, M. Huhta, P.A. Lofy, R.M. Ronningen
1999Re06	PRVCA	59,	2416	I. Reusen, I. Reusen, A. Andreyev, J. Andrzejewski, N. Bijnens, S. Franchoo, M. Huyse, Yu. Kudryavtsev, K. Kruglov, W.F. Mueller, A. Piechaczek, R. Raabe, K. Rykaczewski, J. Szerypo, P. Van Duppen, L. Vermeeren, J. Wauters, A. Wöhr

1999Re16	PRVCA	60,	024311	A.T. Reed, O. Tarasov, R.D. Page, D. Guillemaud-Mueller, Yu. E. Penionzhkevich, R.G. Allatt, J.C. Angélique, R. Anne, C. Borcea, V. Burjan, W.N. Catford, Z. Dlouhý, C. Donzaud, S. Grévy, M. Lewitowicz, S.M. Lukyanov, F.M. Marqués, G. Martinez, A.C. Mueller, P.J. Nolan, J. Novák, N.A. Orr, F. Pougheon, P.H. Regan, M.G. Saint-Laurent, T. Siiskonen, E. Sokol, O. Sorlin, J. Suhonen, W. Trinder, S.M. Vincent
1999Ry04	PRVCA	60,	011301	K. Rykaczewski, J.C. Batchelder, C.R. Bingham, T. Davinson, T.N. Ginter, C.J. Gross, R. Grzywacz, M. Karny, B.D. MacDonald, J.F. Mas, J.W. McConnell, A. Piechaczek, R.C. Slinger, K.S. Toth, W.B. Walters, P.J. Woods, E.F. Zganjar, B. Barmore, L. Gr. Ixaru, A.T. Kruppa, W. Nazarewicz, M. Rizea, T. Vertse
1999Sa06	PYLBB	448,	180	H. Sakurai, S.M. Lukyanov, M. Notani, N. Aoi, D. Beaumel, N. Fukuda, M. Hirai, E. Ideguchi, N. Imai, M. Ishihara, H. Iwasaki, T. Kubo, K. Kusaka, H. Kumagai, T. Nakamura, H. Ogawa, Yu. E. Penionzhkevich, T. Teranishi, Y.X. Watanabe, K. Yoneda, A. Yoshida
1999Sa.A	P-Bormio			F. Sarazin, et al, and PrvCom to D. Lunney March 1999
1999Sa.D	B-Seeheim		PW4	M. Sakama, K. Tsukuda, M. Asai, S. Ichikawa, Y. Oura, A. Osa, M. Shibata, I. Nishinaka, Y. Nagame, M. Ebihara, K. Kawade, H. Nakahara and poster
1999Se14	PRVCA	60,	031304	D. Seweryniak, J. Uusitalo, M.P. Carpenter, D. Nisius, C.N. Davids, C.R. Bingham, L.T. Brown, I. Conticchio, D.J. Henderson, R.V.F. Janssens, W.B. Walters, J. Wauters, P.J. Woods
1999Sh03	PRVCA	59,	101	R.K. Sheline, P. Alexa, C.F. Liang, P. Paris
1999Sm07	EPJAA	5,	43	M.B. Smith, R. Chapman, J.F.C. Cocks, O. Dorvaux, K. Helariutta, P.M. Jones, R. Julin, S. Juutinen, H. Kankaanpaa, H. Kettunen, P. Kuusiniemi, Y. Le Coz, M. Leino, D.J. Middleton, M. Muikku, P. Nieminen, P. Rakhila, A. Savelius, K.-M. Spohr
1999So08	PRVCA	59,	1324	D. Sohler, J. Cederkall, M. Lipoglavsek, Zs. Dombradi, M. Gorska, J. Persson, D. Seweryniak, I. Ahmad, A. Atac, R.A. Bark, J. Blomqvist, M.P. Carpenter, B. Cederwall, C.N. Davids, C. Fahlander, S.M. Fischer, H. Grawe, G. Hackman, R.V.F. Janssens, A. Johnson, A. Kerek, W. Klamra, J. Kownacki, C.J. Lister, S. Mitarai, D. Nisius, L.-O. Norlin, J. Nyberg, G. Poli, P. Reiter, J.J. Ressler, H.A. Roth, J. Schwartz, G. Sletten, J. Uusitalo, W.B. Walters, M. Weiszflog
1999So17	PRLTA	83,	1116	A.A. Sonzogni, C.N. Davids, P.J. Woods, D. Seweryniak, M.P. Carpenter, J.J. Ressler, J. Schwartz, J. Uusitalo, W.B. Walters
1999So20	NUPAB	660,	3	O. Sorlin, C. Donzaud, L. Axelsson, M. Belleguic, R. Béraud, C. Borcea, G. Canchel, E. Chabanat, J.M. Daugas, A. Emsallem, D. Guillemaud-Mueller, K.-L. Kratz, S. Leenhardt, M. Lewitowicz, C. Longour, M.J. Lopez, F. de Oliveira Santos, L. Petizon, B. Pfeiffer, F. Pougheon, M.G. Saint-Laurent, J.E. Sauvestre, and erratum Nucl. Phys. A669 (2000) 351
1999Ta20	EPJAA	5,	123	Y. Tagaya, S. Hashimoto, K. Morita, Y.H. Pu, T. Ariga, K. Ohta, T. Minemura, I. Hisinaga, T. Motobayashi, T. Nomura
1999To04	EPJAA	4,	233	Y. Toh, S. Yamada, A. Taniguchi, Y. Kawase
1999To11	PRVCA	60,	011302	K.S. Toth, C.R. Bingham, J.C. Batchelder, L.T. Brown, L.F. Contecchio, C.N. Davids, R.J. Irvine, D. Sewerniak, D.M. Moltz, W.B. Walters, J. Wauters, E.F. Zganjar
1999Uu01	PRVCA	59,	2975	J. Uusitalo, C.N. Davids, P.J. Woods, D. Sewerniak, A.A. Sonzogni, J.C. Batchelder, C.R. Bingham, T. Davinson, J. de Boer, D.J. Henderson, H.J. Maier, J. Ressler, R. Slinger, W.B. Walters
1999Wa09	PYLBB	454,	1	J.C. Wang, P. Dendooven, M. Hannawald, A. Honkanen, M. Huhta, A. Jokinen, K.-L. Kratz, G. Lhersonneau, M. Oinonen, H. Penttilä, K. Peräjärvi, B. Pfeiffer, J. Äystö
1999Xi03	EPJAA	5,	341	Y. Xie, S. Xu, Z. Li, Y. Yu, Q. Pan, C. Wang, T. Zhang, G. Long, Y. Li
1999Xi04	EPJAA	6,	239	Y. Xie, S. Xu, Z. Li, Y. Yu, Q. Pan, C. Wang, T. Zhang
1999Ya.A	P-Dubna		118	E.A. Yakushev, V.M. Gorozhankin, O. Dragoun, A. Kovalik, A.F. Novgorodov, M. Rysavy, A. Shpalek
				2000
2000Ah02	PRVCA	61,	044301	I. Ahmad, R.R. Chasman, P.R. Fields

2000An14	NATUA	405,	430	A.N. Andreyev, M. Huyse, P. Van Duppen, L. Weissman, D. Ackermann, J. Gerl, F.P. Heßberger, S. Hofmann, A. Kleinböhl, G. Münzenberg, S. Reshitko, C. Schlegel, H. Schaffner, P. Cagarda, M. Matos, S. Saro, A. Keenan, C. Moore, C.D. O'Leary, R.D. Page, M. Taylor, H. Kettunen, M. Leino, A. Lavrentiev, R. Wyss, K. Heyde
2000As.A	AnRpt JAERI		13	M. Asai, K. Tsukada, S. Ichikawa, H. Haba, A. Osa, Y. Nagame, S. Goto, M. Sakama, Y. Kojima, M. Shibata, K. Akiyama, A. Toyoshima
2000Be42	EPJAA	8,	307	D. Beck, F. Ames, G. Audi, G. Bollen, F. Herfurth, H.-J. Kluge, A. Kohl, M. König, D. Lunney, I. Martel, R.B. Moore, H. Raimbault-Hartmann, E. Schark, S. Schwarz, M. de Saint Simon, J. Szerypo, ISOLDE
2000Bo24	NUPAB	673,	85	V. Bondarenko, T. von Egidy, J. Honzátko, I. Tomandl, D. Bucurescu, N. Mărginean, J. Ott, W. Schauer, H.-F. Wirth, C. Doll
2000Ca.A	Th.-Valencia			Cano-Ott
2000Ch07	PRVCA	61,	044309	C. Chandler, P.H. Regan, B. Blank, C.J. Pearson, A.M. Bruce, W.N. Catford, N. Curtis, S. Czajkowski, Ph. Dessagne, A. Fleury, W. Gelletly, J. Giovinazzo, R. Grzywacz, Z. Janas, M. Lewitowicz, C. Marchand, Ch. Mische, N.A. Orr, R.D. Page, M.S. Pravikoff, A.T. Reed, M.G. Saint-Laurent, S.M. Vincent, R. Wadsworth, D.D. Warner, J.S. Winfield, F. Xu
2000Da07	PYLBB	476,	213	J.M. Daugas, R. Grzywacz, M. Lewitowicz, L. Achouri, J.C. Angélique, D. Baiborodin, K. Bennaceur, R. Bentida, R. Béraud, C. Borcea, C. Bingham, W.N. Catford, A. Emsallem, G. de France, H. Grawe, K.L. Jones, R.C. Lemmon, M.J. Lopez Jimenez, F. Nowacki, F. de Oliveira Santos, M. Pfützner, P.H. Regan, K. Rykaczewski, J.E. Sauvestre, M. Sawicka, G. Sletten, M. Stanoiu
2000Do10	JRNBA	105,	43	J. Döring, A. Aprahamian, M. Wiescher
2000Fy01	NUPAB	677,	38	H.O.U. Fynbo, M.J.G. Borge, L. Axelsson, J. Äystö, U.C. Bergmann, L.M. Fraile, A. Honkanen, P. Hornshøj, Y. Jading, A. Jokinen, B. Jonson, I. Martel, I. Mukha, T. Nilsson, G. Nyman, M. Oinonen, I. Piqueras, K. Riisager, T. Siiskonen, M.H. Smedberg, O. Tengblad, J. Thaysen, F. Wenander, ISOLDE
2000Ge01	NUPAB	662,	3	L. Genilloud, H.G. Börner, F. Corminboeuf, Ch. Doll, S. Drissi, M. Jentschel, J. Jolie, J. Kern, H. Lehmann, N. Warr, and erratum NUPAB 669(2000)407
2000Ge07	PYLBB	480,	77	T. Gehrman
2000Gi01	PRVCA	61,	014308	T.N. Ginter, J.C. Batchelder, C.R. Bingham, C.J. Gross, R. Grzywacz, J.H. Hamilton, Z. Janas, M. Karny, S.H. Kim, J.F. Mas, J.W. McConnell, A. Piechaczek, A.V. Ramayya, K. Rykaczewski, P.B. Semmes, J. Szerypo, K.S. Toth, R. Wadsworth, C.-H. Yu, E.F. Zganjar
2000He17	EPJAA	8,	521	F.P. Heßberger, S. Hofmann, D. Ackermann, V. Ninov, M. Leino, S. Saro, A. Andreyev, A. Lavrentev, A.G. Popeko, A.V. Yeremin, and erratum EPJAA 9(2000)433
2000Hi08	PRVCA	61,	055501	M.M. Hindi, R.-M. Larimer, E.B. Norman, G.A. Rech
2000Ho13	PYLBB	482,	1	E. Holzschuh, L. Palermo, H. Stussi, P. Wenk
2000Ho19	RAACA	88,	139	A. Hohn, H.H. Coenen, S.M. Qaim
2000Hu17	PRVCA	62,	064315	Z. Hu, L. Batist, J. Agramunt, A. Algora, B.A. Brown, D. Cano-Ott, R. Collatz, A. Gadea, M. Gierlik, M. Górska, H. Grawe, M. Hellström, Z. Janas, M. Karny, R. Kirchner, F. Moroz, A. Płochocki, M. Rejmund, E. Roeckl, B. Rubio, M. Shibata, J. Szerypo, J.L. Tain, V. Wittmann
2000Io02	PRVCA	62,	014306	M. Ionescu-Bujor, A. Iordachescu, D. Bucurescu
2000Je09	PRVCA	62,	021302	D.G. Jenkins, M. Muikku, P.T. Greenlees, K. Hauschild, K. Helariutta, P.M. Jones, R. Julin, S. Juutinen, H. Kankaanpaa, N.S. Kelsall, H. Kettunen, P. Kuusiniemi, M. Leino, C.J. Moore, P. Nieminen, C.D. O'Leary, R.D. Page, P. Rakhila, W. Reviol, M.J. Taylor, J. Uusitalo, R. Wadsworth
2000Jo18	EPJAA	9,	9	A. Jokinen, J.C. Wang, J. Äystö, P. Dendooven, S. Nummela, J. Huikari, V. Kolhinen, A. Nieminen, K. Peräjärvi, S. Rinta-Antila
2000Ka21	EPJAA	7,	451	R. Kalpakchieva, H.G. Bohlen, W. von Oertzen, B. Gebauer, M. von Lucke-Petsch, T.N. Massey, A.N. Ostrowski, Th. Stolla, M. Wilpert, Th. Wilpert
2000Ko15	EPJAA	7,	167	A. Korgul, W. Urban, T. Rzaca-Urban, M. Rejmund, J.L. Durell, M.J. Leddy, M.A. Jones, W.R. Phillips, A.G. Smith, B.J. Varley, N. Schulz, M. Bentalab, E. Lubkiewicz, I. Ahmad, L.R. Morss

2000Ko16	PRVCA	61,	044323	F.G. Kondev, M.P. Carpenter, R.V.F. Janssens, I. Wiedenhöver, M. Alcorta, L.T. Brown, C.N. Davids, T.L. Khoo, T. Lauritsen, C.J. Lister, D. Seweryniak, S. Siem, A.A. Sonzogni, J. Uusitalo, P. Bhattacharyya, S.M. Fischer, W. Reviol, L.L. Riedinger, R. Nouicer
2000Ko48	PRVCA	62,	044305	F.G. Kondev, R.V.F. Janssens, M.P. Carpenter, K. Abu Saleem, I. Ahmad, M. Alcorta, H. Amro, P. Bhattacharyya, L.T. Brown, J. Caggiano, C.N. Davids, S.M. Fischer, A. Heinz, B. Herskind, R.A. Kaye, T.L. Khoo, T. Lauritsen, C.J. Lister, W.C. Ma, R. Nouicer, J. Ressler, W. Reviol, L.L. Riedinger, D.G. Sarantites, D. Seweryniak, S. Siem, A. Sonzogni, J. Uusitalo, P.G. Varmette, I. Wiedenhöver
2000Kr18	HYIND	129,	185	K. Kratz, B. Pfeiffer, F. Thielemann, W.B. Walters
2000Kr.A	PrvCom	GAu	Jun	K.-L. Kratz, B. Pfeiffer
2000Ku25	YAFIA	63,	1365	V.V. Kuzminov, N. Ja. Osetrova
2000La25	PRVCA	61,	067603	C.A. Laue, K.E. Gregorich, R. Sudowe, J.L. Adams, M.R. Lane, D.M. Lee, C.A. McGrath, D.A. Shaughnessy, D.A. Strellis, E.R. Sylwester, P.A. Wilk, D.C. Hoffman
2000La34	PRVCA	62,	064307	Yu. A. Lazarev, Yu. V. Lobanov, Yu. Ts. Oganessian, V.K. Utyonkov, F. Sh. Abdullin, A.N. Polyakov, J. Rigol, I.V. Shirokovsky, Yu. S. Tsyganov, S. Iliev, V.G. Subbotin, A.M. Sukhov, G.V. Buklanov, A.N. Mezentssev, K. Subotic, K.J. Moody, N.J. Stoyer, J.F. Wild, R.W. Loughheed
2000Li08	EPJAA	7,	1	Z. Li, S. Xu, Y. Xie, T. Zhang, R. Ma, J. Du, Y. Guo, Y. Ge, C. Wang, B. Guo, J. Xing
2000Li37	PRVCA	62,	047303	C.F. Liang, P. Paris, R.K. Sheline
2000Ma62	PRVCA	62,	034308	K. Markenroth, L. Axelsson, S. Baxter, M.J.G. Borge, C. Donzaud, S. Fayans, H.O.U. Fynbo, V.Z. Goldberg, S. Grévy, D. Guillemaud-Mueller, B. Jonson, K.-M. Källman, S. Leenhardt, M. Lewitowicz, T. Lönnroth, P. Manngård, I. Martel, A.C. Mueller, I. Mukha, T. Nilsson, G. Nyman, N.A. Orr, K. Riisager, G.V. Rogachev, M.-G. Saint-Laurent, I.N. Serikov, N.B. Shul'gina, O. Sorlin, M. Steiner, O. Tengblad, M. Thoennessen, E. Tryggestad, W.H. Trzaska, F. Wenzander, J.S. Winfield, R. Wolski
2000Ma65	EPJAA	8,	295	O.N. Malyshev, A.V. Belozеров, M.L. Chelnokov, V.I. Chepigina, V.A. Gorchakov, A.P. Kabachenko, A.G. Popeko, J. Rohach, R.N. Sagaidak, A.V. Yeremin, S.I. Mulgin, S.V. Zhdanov
2000Ma95	PRVCA	62,	057303	H. Mahmud, C.N. Davids, P.J. Woods, T. Davinson, D.J. Henderson, R.J. Irvine, D. Seweryniak, W.B. Walters
2000Me.A	PrvCom	AHW	Sep	K.A. Mezilev, B. Fogelberg, V.I. Isakov, H. Mach
2000Ni02	PRVCA	61,	034309	K. Nishio, H. Ikezoe, S. Mitsuoka, J. Lu
2000O101	PRLTA	84,	4056	J.M. Oliveira, Jr., A. Lépine-Szily, H.G. Bohlen, A.N. Ostrowski, R. Lichtenthaler, A. Di Pietro, A.M. Laird, G.F. Lima, L. Maunoury, F. de Oliveira Santos, P. Roussel-Chomaz, H. Savajols, W. Trinder, A.C.C. Villari, A. de Vismes
2000Pe28	PYLBB	492,	1	K. Peräjärvi, T. Siiskonen, A. Honkanen, P. Dendooven, A. Jokinen, P.O. Lipas, M. Oinonen, H. Penttilä, J. Äystö
2000Pi03	PRVCA	61,	024312	J.A. Pinston, C. Foin, J. Genevey, R. Béraud, E. Chabanat, H. Faust, S. Oberstedt, B. Weiss
2000Po26	PYLBB	491,	225	Zs. Podolyák, P.H. Regan, M. Pfutzner, J. Gerl, M. Hellström, M. Caamano, P. Mayet, Ch. Schlegel, A. Aprahamian, J. Benlliure, A.M. Bruce, P.A. Butler, D. Cortina Gil, D.M. Cullen, J. Doring, T. Enqvist, F. Rejmund, C. Fox, J. Garces Narro, H. Geissel, W. Gelletly, J. Giovinazzo, M. Gorska, H. Grawe, R. Grzywacz, A. Kleinbohl, W. Korten, M. Lewitowicz, R. Lucas, H. Mach, M. Mineva, C.D. O'Leary, F. de Oliveira, C.J. Pearson, M. Rejmund, M. Sawicka, H. Schaffner, K. Schmidt, Ch. Theisen, P.M. Walker, D.D. Warner, C. Wheldon, H.J. Wollersheim, S.C. Wooding, F.R. Xu
2000Ra23	NUPAB	677,	75	T. Radon, H. Geissel, G. Münzenberg, B. Franzke, Th. Kerscher, F. Nolden, Yu. N. Novikov, Z. Patyk, C. Scheidenberger, F. Attallah, K. Beckert, T. Beha, F. Bosch, H. Eickhoff, M. Falch, Y. Fujita, M. Hausmann, F. Herfurth, H. Irnich, H.C. Jung, O. Klepper, C. Kozhuharov, Yu. A. Litvinov, K.E.G. Löbner, F. Nickel, H. Reich, W. Schwab, B. Schlitt, M. Steck, K. Sümmerner, T. Winkler, H. Wollnik

2000Re03	PRLTA	84,	2104	J.J. Ressler, A. Piechaczek, W.B. Walters, A. Aprahamian, M. Wiescher, J.C. Batchelder, C.R. Bingham, D.S. Brenner, T.N. Ginter, C.J. Gross, R. Grzywacz, D. Kulp, B. MacDonald, W. Reviol, J. Rikowska, K. Rykaczewski, J.A. Winger, E.F. Zganjar
2000Ri14	PRLTA	85,	1392	J. Rikowska, T. Giles, N.J. Stone, K. van Esbroeck, G. White, A. Wöhr, M. Veskovic, I.S. Towner, P.F. Mantica, J.I. Prisciandaro, D.J. Morrissey, V.N. Fedoseyev, V.I. Mishin, U. Köster, W.B. Walters, NICOLE, ISOLDE
2000Sa21	PRLTA	84,	5062	F. Sarazin, H. Savajols, W. Mittig, F. Nowacki, N.A. Orr, Z. Ren, P. Roussel-Chomaz, G. Auger, D. Baiborodin, A.V. Belozyorov, C. Borcea, E. Caurier, Z. Dlouhý, A. Gillibert, A.S. Lalleman, M. Lewitowicz, S.M. Lukyanov, F. de Oliveira, Y.E. Penionzhkevich, D. Ridikas, H. Sakurai, O. Tarasov, A. de Vismes
2000Sa52	EPJAA	9,	303	M. Sakama, K. Tsukada, M. Asai, S. Ichikawa, H. Haba, S. Goto, Y. Oura, I. Nishinaka, Y. Nagame, M. Shibata, Y. Kojima, K. Kawade, M. Ebihara, H. Nakahara
2000Sh10	PRVCA	61,	044609	D.A. Shaughnessy, J.L. Adams, K.E. Gregorich, M.R. Lane, C.A. Laue, D.M. Lee, C.A. McGrath, J.B. Patin, D.A. Strellis, E.R. Sylwester, P.A. Wilk, D.C. Hoffman
2000Si02	ARISE	52,	467	G. Sibbens, B. Denecke
2000Sm06	JPGPE	26,	787	M.B. Smith, R. Chapman, J.F.C. Cocks, K.-M. Spohr, O. Dorvaux, K. Helariutta, P.M. Jones, R. Julin, S. Juutinen, H. Kankaanpää, H. Kettunen, P. Kuusiniemi, Y. Le Coz, M. Leino, D.J. Middleton, M. Muikku, P. Nieminen, P. Rakhila, A. Savelius
2000So11	PHSTT	88,	153	G.A. Souliotis
2000We.A	AnRpt GSI		10	E. Wefers, T. Faestermann, R. Schneider, A. Stolz, K. Sümerrerr, J. Friese, H. Geissel, M. Hellström, P. Kienle, H.-J. Körner, M. Münch, G. Münzenberg, P. Thirolf, H. Weick
2000Wh04	PRVCA	62,	057301	C. Wheldon, P.M. Walker, P. Chowdhury, I. Shestakova, R. D'Alarcao, I. Ahmad, M.P. Carpenter, D.M. Cullen, R.V.F. Janssens, T.L. Khoo, F.G. Kondev, C.J. Lister, C.J. Pearson, Zs. Podolyák, D. Seweryniak, I. Wiedenhoever
2000Wi15	PRLTA	85,	2697	P.A. Wilk, K.E. Gregorich, A. Türler, C.A. Laue, R. Eichler, V. Ninov, J.L. Adams, U.W. Kirbach, M.R. Lane, D.M. Lee, J.B. Patin, D.A. Shaughnessy, D.A. Strellis, H. Nitsche, D.C. Hoffman
2000Xu08	EPJAA	8,	435	S. Xu, Y. Xie, Y. Yu, Z. Li, Q. Pan, C. Wang, J. Xing, T. Zhang
2000Ye02	JPGPE	26,	839	G. Yeandle, J. Billowes, P. Campbell, E.C.A. Cochrane, P. Dendooven, D.E. Evans, D.H. Forest, J.A.R. Griffith, J. Huikari, A. Jokinen, I.D. Moore, A. Nieminen, K. Peräjärvi, G. Tungate, J. Äystö
			2001	
2001Ba06	PRVCA	63,	024302	P.H. Barker
2001Be53	EPJAA	11,	279	U.C. Bergmann, M.J.G. Borge, J. Cederkäll, C. Forssén, E. Fumero, H.O.U. Fynbo, H. Gausemel, H. Jeppesen, B. Jonson, K. Markenroth, T. Nilsson, G. Nyman, K. Riisager, H. Simon, O. Tengblad, L. Weissman, F. Wenander, K. Wilhelmsen Rolander, ISOLDE
2001Bo11	NUPAB	686,	64	R. Bonetti, C. Carbonini, A. Guglielmetti, M. Hussonnois, D. Trubert, C. Le Naour
2001Bo54	NUPAB	695,	69	R. Borcea, J. Äystö, E. Caurier, P. Dendooven, J. Döring, M. Gierlik, M. Górská, H. Grawe, M. Hellström, Z. Janas, A. Jokinen, M. Karny, R. Kirchner, M. La Commara, K. Langanke, G. Martínez-Pinedo, P. Mayet, A. Nieminen, F. Nowacki, H. Penttilä, A. Płochocki, M. Rejmund, E. Roeckl, C. Schlegel, K. Schmidt, R. Schwengner, M. Sawicka, and erratum NUPAB 703(2002)889
2001Bo59	HYIND	132,	215	G. Bollen, F. Ames, G. Audi, D. Beck, J. Dilling, O. Engels, S. Henry, F. Herfurth, A. Kellerbauer, H.-J. Kluge, A. Kohl, E. Lamour, D. Lunney, R.B. Moore, M. Oinonen, C. Scheidenberger, S. Schwarz, G. Sikler, J. Szerypo, C. Weber, ISOLDE
2001Br27	EPJDD	15,	181	S. Brunner, T. Engel, A. Schmitt, G. Werth

2001Ca37	PRVCA	64,	025802	J.A. Caggiano, D. Bazin, W. Benenson, B. Davids, R. Ibbotson, H. Scheit, B.M. Sherrill, M. Steiner, J. Yurkon, A.F. Zeller, B. Blank, M. Chartier, J. Greene, J.A. Nolen, Jr., A.H. Wuosmaa, M. Bhattacharya, A. García, M. Wiescher
2001Ca60	EPJAA	12,	377	G. Canchel, L. Achouri, J. Äystö, R. Béraud, B. Blank, E. Chabanat, S. Czajkowski, P. Dendooven, A. Emsallem, J. Giovinazzo, J. Honkanen, A. Jokinen, M. Lewitowicz, C. Longour, F. de Oliveira-Santos, K. Peräjärvi, M. Staniou, J.C. Thomas
2001Ca.B	AnRpt GSI		15	P. Cagarda, S. Antalic, D. Ackermann, F.P. Heßberger, S. Hofmann, B. Kindler, J. Kojouharova, B. Lommel, R. Mann, A.G. Popeko, Š. Šáro, J. Uusitalo, A.V. Yeremin
2001Ch31	PYLBB	505,	21	L. Chen, B. Blank, B.A. Brown, M. Chartier, A. Galonsky, P.G. Hansen, M. Thoennessen
2001Da22	NUPAB	694,	375	F.A. Danevich, V.V. Kobychyev, O.A. Ponkratenko, V.I. Tretyak, Yu. G. Zdesenko
2001Do08	PRLTA	86,	4259	G. Douysset, T. Fritioff, C. Carlberg, I. Bergström, M. Björkhage
2001Dr05	PRVCA	63,	061302	G.D. Dracoulis, T. Kibédi, A.P. Byrne, A.M. Baxter, S.M. Mullins, R.A. Bark
2001Fo08	PRLTA	87,	212501	B. Fornal, R. Broda, K.H. Maier, J. Wrzesinski, G.J. Lane, M. Cromaz, A.O. Macchiavelli, R.M. Clark, K. Vetter, A.P. Byrne, G.D. Dracoulis, M.P. Carpenter, R.V.F. Janssens, I. Wiedenhoever, M. Rejmund, J. Blomqvist
2001Fr18	EPJDD	15,	141	T. Fritioff, C. Carlberg, G. Douysset, R. Schuch, I. Bergström
2001Ga01	PRVCA	63,	014302	M. Galeazzi, F. Fontanelli, F. Gatti, S. Vitale
2001Ga20	EPJAA	10,	21	Z.G. Gan, Z. Qin, H.M. Fan, X.G. Lei, Y.B. Xu, J.J. He, H.Y. Liu, X.L. Wu, J.S. Guo, X.H. Zhou, S.G. Yuan, G.M. Jin
2001Ga24	PRVCA	63,	044307	J. Garcés Narro, C. Longour, P.H. Regan, B. Blank, C.J. Pearson, M. Lewitowicz, C. Miehé, W. Gelletly, D. Appelbe, L. Axelsson, A.M. Bruce, W.N. Catford, C. Chandler, R.M. Clark, D.M. Cullen, S. Czajkowski, J.M. Daugas, P. Dessagne, A. Fleury, L. Frankland, J. Giovinazzo, B. Greenhalgh, R. Grzywacz, M. Harder, K.L. Jones, N. Kelsall, T. Kszczot, R.D. Page, A.T. Reed, O. Sorlin, R. Wadsworth
2001Ga59	EPJAA	11,	413	M. Gaelens, J. Andrzejewski, J. Camps, P. Decrock, M. Huyse, K. Kruglov, W.F. Mueller, A. Piechaczek, N. Severijns, J. Szerypo, G. Vancaeynest, P. Van Duppen, J. Wauters
2001Gi01	EPJAA	10,	73	J. Giovinazzo, B. Blank, C. Borcea, M. Chartier, S. Czajkowski, G. de France, R. Grzywacz, Z. Janas, M. Lewitowicz, F. de Oliveira Santos, M. Pfützner, M.S. Pravikoff, J.C. Thomas
2001Gi17	EPJAA	12,	309	A. Gizon, J. Genevey, C.F. Liang, P. Paris, D. Barnéoud, J. Inchaouh, I. Penev, A. Plochocki
2001Gr07	NUPAB	682,	41c	R. Grzywacz, C.H. Yu, Z. Janas, S.D. Paul, J.C. Batchelder, C.R. Bingham, T.N. Ginter, C.J. Gross, J. McConnell, M. Lipoglavsek, A. Piechaczek, D.C. Radford, J.J. Ressler, K. Rykaczewski, J. Shergur, W.B. Walters, E.F. Zganjar, C. Baktash, M.P. Carpenter, R.V.F. Janssens, C.E. Svensson, J.C. Waddington, D. Ward, E. Dragulescu
2001Ha39	NUPAB	688,	578c	M. Hannawald, V.N. Fedoseyev, U. Koster, K.-L. Kratz, V.I. Mishin, W.F. Mueller, H.L. Ravn, J. Van Roosbroeck, H. Schatz, V. Sebastian, W.B. Walters, ISOLDE
2001Ha46	PRLTA	87,	072501	K. Hauschild, M. Rejmund, H. Grawe, E. Caurier, F. Nowacki, F. Becker, Y. Le Coz, W. Korten, J. Döring, M. Górska, K. Schmidt, O. Dorvaux, K. Helariutta, P. Jones, R. Julin, S. Juutinen, H. Kettunen, M. Leino, M. Muikku, P. Nieminen, P. Rahkila, J. Uusitalo, F. Azaiez, M. Belleguic
2001Ha66	HYIND	132,	291	M. Hausmann, J. Stadlmann, F. Attallah, K. Beckert, P. Beller, F. Bosch, H. Eickhoff, M. Falch, B. Franczak, B. Franzke, H. Geissel, Th. Kerscher, O. Klepper, H.-J. Kluge, C. Kozhuharov, Yu. A. Litvinov, K.E.G. Lobner, G. Munzenberg, N. Nankov, F. Nolden, Yu. N. Novikov, T. Ohtsubo, T. Radon, H. Schatz, C. Scheidenberger, M. Steck, Z. Sun, H. Weick, H. Wollnik
2001He29	PRLTA	87,	142501	F. Herfurth, J. Dilling, A. Kellerbauer, G. Audi, D. Beck, G. Bollen, H.-J. Kluge, D. Lunney, R.B. Moore, C. Scheidenberger, S. Schwarz, G. Sikler, J. Szerypo, ISOLDE

2001He35	EPJAA	12,	57	F.P. Heßberger, S. Hofmann, D. Ackermann, V. Ninov, M. Leino, G. Münzenberg, S. Saro, A. Lavrentev, A.G. Popeko, A.V. Yeremin, Ch. Stodel and PrvCom
2001He36	PRVAA	64,	062504	T.P. Heavner, S.R. Jefferts, G.H. Dunn
2001He.A	AnRpt GSI		3	F.P. Heßberger, S. Hofmann, D. Ackermann
2001Hi06	PRVCA	63,	065502	M.M. Hindi, B.O. Faircloth, R.L. Kozub, K.R. Czerwinski, R.-M. Larimer, E.B. Norman, B. Sur, I. Žilimen
2001Ho06	EPJAA	10,	5	S. Hofmann, F.P. Heßberger, D. Ackermann, S. Antalic, P. Cagarda, S. Ćwiok, B. Kindler, J. Kojouharova, B. Lommel, R. Mann, G. Münzenberg, A.G. Popeko, S. Saro, H.J. Schött, A.V. Yeremin
2001Ke05	APOBB	32,	989	H. Kettunen, P.T. Greenlees, K. Helariutta, P. Jones, R. Julin, S. Juutinen, P. Kuusiniemi, M. Leino, M. Muikku, P. Nieminen, J. Uusitalo
2001Ke06	PRVCA	63,	044315	H. Kettunen, J. Uusitalo, M. Leino, P. Jones, K. Eskola, P.T. Greenlees, K. Helariutta, R. Julin, S. Juutinen, H. Kankaanpaa, P. Kuusiniemi, M. Muikku, P. Nieminen, P. Rahkila
2001Ke14	PRAMC	56,	735	S.L. Keshava, K. Gopala, P. Venkataramaiah
2001Ki13	PPNPD	46,	73	P. Kienle, T. Faestermann, J. Friese, H.-J. Körner, M. Münch, R. Schneider, A. Stolz, E. Wefers, H. Geissel, G. Münzenberg, C. Schlegel, K. Sümmerer, H. Weick, M. Hellström, P. Thiof
2001K113	MPLAE	16,	2409	H.V. Klapdor-Kleingrothaus, A. Dietz, H.L. Harney, I.V. Krivosheina
2001Ko07	NIMAE	458,	656	Y. Kojima, M. Shibata, H. Uno, K. Kawade, A. Taniguchi, Y. Kawase, K. Shizuma
2001Ko44	PYLBB	512,	268	F.G. Kondev, M.P. Carpenter, R.V.F. Janssens, K. Abu Saleem, I. Ahmad, H. Amro, J.A. Cizewski, M. Danchev, C.N. Davids, D.J. Hartley, A. Heinz, T.L. Khoo, T. Lauritsen, C.J. Lister, W.C. Ma, G.L. Poli, J. Ressler, W. Reviol, L.L. Riedinger, D. Seweryniak, M.B. Smith, I. Wiedenhöver and PrvCom AHW August 2001
2001Ko52	PRLTA	87,	092501	A.A. Korshennikov, M.S. Golovkov, I. Tanihata, A.M. Rodin, A.S. Fomichev, S.I. Sidorchuk, S.V. Stepantsov, M.L. Chelnokov, V.A. Gorshkov, D.D. Bogdanov, R. Wolski, G.M. Ter-Akopian, Yu. Ts. Oganessian, W. Mittig, P. Roussel-Chomaz, H. Savajols, E.A. Kuzmin, E. Yu. Nikolsky, A.A. Ogloblin
2001Ko.B	PrvCom	AHW	Aug	F.G. Kondev
2001Ku07	APOBB	32,	1009	P. Kuusiniemi, J.F.C. Cocks, K. Eskola, P.T. Greenlees, K. Helariutta, P. Jones, R. Julin, S. Juutinen, H. Kankaanpaa, A. Keenan, H. Kettunen, M. Leino, M. Muikku, P. Nieminen, P. Rahkila, J. Uusitalo
2001La09	NUPAB	682,	71c	G.J. Lane, R. Broda, B. Fornal, A.P. Byrne, G.D. Dracoulis, J. Blomqvist, R.M. Clark, M. Cromaz, M.A. Deleplanque, R.M. Diamond, P. Fallon, R.V.F. Janssens, I.Y. Lee, A.O. Macchiavelli, K.H. Maier, M. Rejmund, F.S. Stephens, C.E. Svensson, K. Vetter, D. Ward, I. Wiedenhover, J. Wrzesinski
2001La31	HYIND	132,	315	A.S. Lalleman, G. Auger, W. Mittig, M. Chabert, M. Chartier, J. Ferme, A. Gillibert, A. Lepine-Szily, M. Lewitowicz, M.H. Moscatello, N.A. Orr, G. Politi, F. Sarazin, H. Savajols, P. Van Isacker, A.C.C. Villari
2001Li17	PRVCA	63,	047307	K. Lindenberg, F. Neumann, D. Galaviz, T. Hartmann, P. Mohr, K. Vogt, S. Volz, A. Zilges
2001Li44	PRVCA	64,	034310	C.F. Liang, P. Paris, R.K. Sheline
2001Lu17	PRVCA	64,	054311	D. Lunney, G. Audi, H. Doubre, S. Henry, C. Monsanglant, M. de Saint Simon, C. Thibault, C. Toader, C. Borcea, G. Bollen, ISOLDE
2001Lu20	HYIND	132,	299	D. Lunney, C. Monsanglant, G. Audi, G. Bollen, C. Borcea, H. Doubre, C. Gaulard, S. Henry, M. de Saint Simon, C. Thibault, C. Toader, N. Vieira, ISOLDE
2001Ma08	PRVCA	63,	024613	V. Maddalena, T. Aumann, D. Bazin, B.A. Brown, J.A. Caggiano, B. Davids, T. Glasmacher, P.G. Hansen, R.W. Ibbotson, A. Navin, B.V. Pritychenko, H. Scheit, B.M. Sherrill, M. Steiner, J.A. Tostevin, J. Yurkon
2001Ma69	PRVCA	64,	031303	H. Mahmud, C.N. Davids, P.J. Woods, T. Davinson, A. Heinz, G.L. Poli, J.J. Ressler, K. Schmidt, D. Seweryniak, M.B. Smith, A.A. Sonzogni, J. Uusitalo, W.B. Walters

2001Ma96	EPJAA	12,	269	C. Mazzocchi, Z. Janas, J. Döring, M. Axiotis, L. Batist, R. Borcea, D. Cano-Ott, E. Caurier, G. de Angelis, E. Farnea, A. Faßbender, A. Gadea, H. Grawe, A. Jungclaus, M. Kapica, R. Kirchner, J. Kurcewicz, S.M. Lenzi, T. Martínez, I. Mukha, E. Nácher, D.R. Napoli, E. Roeckl, B. Rubio, R. Schwengner, J.L. Tain, C.A. Ur
2001Mi22	EPJAA	11,	9	M.N. Mineva, M. Hellström, M. Bernas, J. Gerl, H. Grawe, M. Pfützner, P.H. Regan, M. Rejmund, D. Rudolph, F. Becker, C.R. Bingham, T. Enqvist, B. Fogelberg, H. Gausemel, H. Geissel, J. Genevey, M. Górska, R. Grzywacz, K. Hauschild, Z. Janas, I. Kojouharov, Y. Kopatch, A. Korgul, W. Korten, J. Kurcewicz, M. Lewitowicz, R. Lucas, H. Mach, S. Mandal, P. Mayet, C. Mazzocchi, J.A. Pinston, Zs. Podolyák, H. Schaffner, Ch. Schlegel, K. Schmidt, K. Sümmerer, H.J. Wollersheim
2001No07	EPJAA	11,	257	Yu. N. Novikov, H. Schatz, P. Dendooven, R. Béraud, Ch. Miehé, A.V. Popov, D.M. Seliverstov, G.K. Vorobjev, P. Baumann, M.J.G. Borge, G. Canchel, Ph. Dessagne, A. Emsallem, W. Huang, J. Huikari, A. Jokinen, A. Knipper, V. Kolhinen, A. Nieminen, M. Oinonen, H. Penttilä, K. Peräjärvi, I. Piqueras, S. Rinta-Antila, J. Szerypo, Y. Wang, J. Äystö
2001Og01	PRVCA	63,	011301	Yu. Ts. Oganessian, V.K. Utyonkov, Yu. V. Lobanov, F. Sh. Abdullin, A.N. Polyakov, I.V. Shirokovsky, Yu. S. Tsyganov, G.G. Gulbekian, S.L. Bogomolov, B.N. Gikal, A.N. Mezentsev, S. Iliev, V.G. Subbotin, A.M. Sukhov, O.V. Ivanov, G.V. Buklanov, K. Subotic, M.G. Itkis, K.J. Moody, J.F. Wild, N.J. Stoyer, M.A. Stoyer, R.W. Lougheed, C.A. Laue, Ye. A. Karelin, A.N. Tatarinov
2001Og08	PRVCA	64,	054606	Yu. Ts. Oganessian, V.K. Utyonkov, Yu. V. Lobanov, F. Sh. Abdullin, A.N. Polyakov, I.V. Shirokovsky, Yu. S. Tsyganov, A.N. Mezentsev, S. Iliev, V.G. Subbotin, A.M. Sukhov, K. Subotic, O.V. Ivanov, A.N. Voinov, V.I. Zagrebaev, K.J. Moody, J.F. Wild, N.J. Stoyer, M.A. Stoyer, R.W. Lougheed
2001Pa52	HYIND	132,	189	A. Paul, S. Röttger, A. Zimbal, U. Keyser
2001Pe14	YAFIA	64,	1197	Yu. E. Penionzhkevich
2001Po05	PRVCA	63,	044304	G.L. Poli, C.N. Davids, P.J. Woods, D. Seweryniak, M.P. Carpenter, J.A. Cizewski, T. Davinson, A. Heinz, R.V.F. Janssens, C.J. Lister, J.J. Ressler, A.A. Sonzogni, J. Uusitalo, W.B. Walters
2001Ro35	HYIND	132,	153	E. Roeckl
2001Ro.B	B-Aulanko		PH23	M.W. Rowe, J.C. Batchelder, T.N. Ginter, K.E. Gregorich, F.Q. Guo, F.P. Heßberger, V. Ninov, J. Powell, K.S. Toth, X.J. Xu, J. Cerny
2001Ry01	NUPAB	682,	270c	K.P. Rykaczewski, R.K. Grzywacz, M. Karny, J.W. McConnell, M. Momayezi, J. Wahl, Z. Janas, J.C. Batchelder, C.R. Bingham, D. Hartley, M.N. Tantawy, C.J. Gross, T.N. Ginter, J.H. Hamilton, W.D. Kulp, M. Lipoglavsek, A. Piechaczek, E.F. Zganjar, W.B. Walters, J.A. Winger
2001Sc23	ARISE	55,	89	U. Schotzig, H. Schrader, E. Schonfeld, E. Gunther, R. Klein
2001Sc41	NUPAB	693,	533	S. Schwarz, F. Ames, G. Audi, D. Beck, G. Bollen, C. De Coster, J. Dilling, O. Engels, R. Fossion, J.-E. Garcia Ramos, S. Henry, F. Herfurth, K. Heyde, A. Kellerbauer, H.-J. Kluge, A. Kohl, E. Lamour, D. Lunney, I. Martel, R.B. Moore, M. Oinonen, H. Raimbault-Hartmann, C. Scheidenberger, G. Sikler, J. Szerypo, C. Weber, ISOLDE
2001Sh36	PRVCA	64,	054307	I. Shestakova, G. Mukherjee, P. Chowdhury, R. D'Alarcao, C.J. Pearson, Zs. Podolyák, P.M. Walker, C. Wheldon, D.M. Cullen, I. Ahmad, M.P. Carpenter, M.P. Carpenter, R.V.F. Janssens, T.L. Khoo, F.G. Kondev, C.J. Lister, D. Seweryniak, I. Wiedenhoever
2001So02	PRVCA	63,	031304	F. Soramel, A. Guglielmetti, L. Stroe, L. Müller, R. Bonetti, G.L. Poli, F. Malerba, E. Bianchi, A. Andrighetto, J.Y. Guo, Z.C. Li, E. Maglione, F. Scarlassara, C. Signorini, Z.H. Liu, M. Ruan, M. Ivascu, C. Broude, P. Bednarczyk, L.S. Ferreira
2001St.A	AnRpt GSI		7	A. Stolz, T. Faestermann, R. Schneider, K. Sümmerer, E. Wefers, J. Friese, H. Geissel, J. Gerl, M. Hellstroem, P. Kienle, H.-J. Koerner, M.N. Mineva, M. Muench, G. Muenzenberg, C. Schlegel, R.S. Simon, P. Thirolf, H. Weick, K. Zeitelhack

2001Ta23	PYLBB	515,	255	S. Takeuchi, S. Shimoura, T. Motobayashi, H. Akiyoshi, Y. Ando, N. Aoi, Zs. Fülöp, T. Gomi, Y. Higurashi, M. Hirai, N. Iwasa, H. Iwasaki, Y. Iwata, H. Kobayashi, M. Kurokawa, Z. Liu, T. Minemura, S. Ozawa, H. Sakurai, M. Serata, T. Teranishi, K. Yamada, Y. Yanagisawa, M. Ishihara
2001Th01	PRVCA	63,	014308	M. Thoennessen, S. Yokoyama, P.G. Hansen
2001To06	PRVCA	63,	034314	B.E. Tomlin, C.J. Barton, N.V. Zamfir, M.A. Caprio, R.L. Gill, R. Krücken, J.R. Novak, J.R. Cooper, K.E. Zyromski, G. Cata-Danil, C.W. Beusang, A. Wolf, N.A. Pietralla, H. Newman, J. Cederkall, B. Liu, Z. Wang, R.F. Casten, D.S. Brenner
2001Va33	HYIND	132,	163	R.S. Van Dyck, Jr., S.L. Zafonte, P.B. Schwinberg
2001Va.A	PrvCom	AHW	Oct	R.S. Van Dyck, Jr.
2001Va.B	AnRpt GSI		14	K. Van de Vel, A.N. Andreyev, D. Ackermann, S. Antalic, H.J. Boardman, P. Cargada, J. Gerl, F.P. Heßberger, S. Hofmann, M. Huyse, D. Karlgren, B. Kindstler, I. Kozhoukharov, M. Leino, B. Lommel, G. Muenzenberg, C. Moore, R.D. Page, C. Schlegel, P. Van Duppen
2001Wa50	HYIND	132,	323	C. Wagemans, J. Wagemans, G. Goeminne
2001Ze.A	Th.-Orsay			T. Zerguerras
			2002	
2002Aa.A	MPLAE to be pd			C.E. Aalseth, F.T. Avignone III, A. Barabash, F. Boehm, R.L. Brodzinski, J.I. Collar, P.J. Doe, H. Ejiri, S.R. Elliott, E. Fiorini, R.J. Gaitskell, G. Gratta, R. Hazama, K. Kazkaz, G.S. King III, R.T. Kouzes, H.S. Miley, M.K. Moe, A. Morales, J. Morales, A. Piepke, R.G.H. Robertson, W. Tornow, P. Vogel, R.A. Warner, J.F. Wilkerson arXiv:hep-ex/0202018 v1 7 Feb 2002
2002An15	EPJAA	14,	63	A.N. Andreyev, K. Van de Vel, A. Barzakh, A. De Smet, H. De Witte, D.V. Fedorov, V.N. Fedoseyev, S. Franchoo, M. Górska, M. Huyse, Z. Janas, U. Köster, W. Kurcewicz, J. Kurpeta, V.I. Mishin, K. Partes, A. Płochocki, P. Van Duppen, L. Weissman
2002An19	PRVCA	66,	014313	A.N. Andreyev, M. Huyse, K. Van de Vel, P. Van Duppen, O. Dorvaux, P. Greenlees, K. Helariutta, P. Jones, R. Julin, S. Juutinen, H. Kettunen, P. Kusunniemi, M. Leino, M. Muikku, P. Nieminen, P. Rakhila, J. Uusitalo, R. Wyss, K. Hauschild, Y. Le Coz
2002As08	JNRSA	3,	187	M. Asai, M. Sakama, K. Tsukada, S. Ichikawa, H. Haba, I. Nishinaka, Y. Nagame, S. Goto, K. Akiyama, A. Toyoshima, Y. Kojima, Y. Oura, H. Nakahara, M. Shibata, K. Kawade
2002At01	NUPAB	701,	561c	F. Attallah, M. Hausmann, Y.A. Litvinov, T. Radon, J. Stadlmann, K. Beckert, F. Bosch, M. Falch, B. Franzke, H. Geissel, Th. Kerscher, O. Klepper, H.-J. Kluge, C. Kozuharov, K.E.G. Löbner, G. Munzenberg, F. Nolden, Y.N. Novikov, Z. Patyk, W. Quint, H. Schatz, C. Scheidenberger, B. Schlitt, M. Steck, K. Sümmerner, H. Weick, H. Wollnik
2002Be64	PHSTB	66,	201	I. Bergström, T. Fritioff, R. Schuch, J. Schönfelder
2002Be74	PYLBB	546,	23	R. Bernabei, P. Belli, F. Cappella, R. Cerulli, F. Montecchia, A. Incicchitti, D. Prosperi, C.J. Dai
2002Bf02	NIMAE	487,	618	I. Bergström, C. Carlberg, T. Fritioff, G. Doussset, J. Schönfelder, R. Schuch
2002Bo11	NIMAE	480,	696	S.B. Borzakov, R.E. Chrien, H. Faikow-Stanczyk, Yu. V. Grigoriev, Ts. Ts. Pan-teleev, S. Pospisil, L.M. Smotritsky, S.A. Telezhnikov
2002Bo41	NUPAB	709,	3	V. Bondarenko, J. Berzins, P. Prokofjevs, L. Simonova, T. von Egidy, J. Honzátko, I. Tomandl, P. Alexa, H.-F. Wirth, U. Köster, Y. Eisermann, A. Metz, G. Graw, R. Hertenberger, L. Rubacek
2002Ca37	PRLTA	89,	082501	P. Campbell, H.L. Thayer, J. Billowes, P. Dendooven, K.T. Flanagan, D.H. Forrest, J.A.R. Griffith, J. Huikari, A. Jokinen, R. Moore, A. Nieminen, G. Tungate, S. Zemlyanoi, J. Äystö
2002Cl.A	P-Aulanko		39	J.A. Clark, R.C. Barber, C. Boudreau, F. Buchinger, J.A. Caggiano, J.E. Crawford, H. Fukutani, S. Gulick, J.C. Hardy, A. Heinz, J.K.P. Lee, M. Maier, R.B. Moore, G. Savard, J. Schwarz, D. Sewerniak, K.S. Sharma, G. Sprouse, J. Vaz, J.C. Wang
2002Di12	EPJAA	13,	281	I. Dillmann, M. Hannawald, U. Köster, V.N. Fedoseyev, A. Wöhr, B. Pfeiffer, D. Fedorov, J. Shergur, L. Weissman, W.B. Walters, K.-L. Kratz

2002Do19	PRVCA	66,	064321	D.J. Dobson, S.J. Freeman, P.T. Greenlees, A.N. Qadir, S. Juutinen, J.L. Durell, T. Enqvist, P. Jones, R. Julin, A. Keenan, H. Kettunen, P. Kuusiniemi, M. Leino, P. Nieminen, P. Rahkila, S.D. Robinson, J. Uusitalo, B.J. Varley
2002Fa13	EPJAA	15,	185	T. Faestermann, R. Schneider, A. Stolz, K. Sümmerer, E. Wefers, J. Friese, H. Geissel, M. Hellström, P. Kienle, H.-J. Körner, M. Mineva, M. Münch, G. Münzenberg, C. Schlegel, K. Schmidt, P. Thirolf, H. Weick, K. Zeitelhack
2002Ga12	NUPAB	700,	117	E. Garrido, D.V. Fedorov, A.S. Jensen
2002Ge07	PRVCA	65,	034322	J. Genevey, J.A. Pinston, C. Foin, M. Rejmund, H. Faust, B. Weiss
2002Ge16	JPGPE	28,	2993	G. Georgiev, G. Neyens, M. Hass, D.L. Balabanski, C. Bingham, C. Borcea, N. Coulier, R. Coussement, J.M. Daugas, G. De France, F. de Oliveira Santos, M. Gorska, H. Grawe, R. Grzywacz, M. Lewitowicz, H. Mach, I. Matea, R.D. Page, M. Pfützner, Yu. E. Penionzhkevich, Z. Podolyák, P.H. Regan, K. Rykaczewski, M. Sawicka, N.A. Smirnova, Y.G. Sobolev, M. Stanoiu, S. Teughels, K. Vyvey
2002Gi09	PRLTA	89,	102501	J. Giovinazzo, B. Blank, M. Chartier, S. Czajkowski, A. Fleury, M.J. Lopez Jimenez, M.S. Pravikoff, J.-C. Thomas, F. de Oliveira Santos, M. Lewitowicz, V. Maslov, M. Stanoiu, R. Grzywacz, M. Pfützner, C. Borcea, B.A. Brown
2002He23	EPJAA	15,	17	F. Herfurth, A. Kellerbauer, F. Ames, G. Audi, D. Beck, K. Blaum, G. Bollen, O. Engels, H.-J. Kluge, D. Lunney, R.B. Moore, M. Oinonen, E. Sauvan, C. Scheidenberger, S. Schwarz, G. Sikler, C. Weber, ISOLDE
2002He29	EPJAA	15,	335	F.P. Heßberger, S. Hofmann, I. Kojouharov, D. Ackermann, S. Antalic, P. Cagarda, B. Kindler, B. Lommel, R. Mann, A.G. Popeko, S. Saro, J. Uusitalo, A.V. Yeremin
2002He.A	P-Aulanko		337	F.P. Heßberger, S. Hofmann, D. Ackermann
2002Ho11	EPJAA	14,	147	S. Hofmann, F.P. Heßberger, D. Ackermann, G. Münzenberg, S. Antalic, P. Cagarda, B. Kindler, J. Kojouharova, M. Leino, B. Lommel, R. Mann, A.G. Popeko, S. Reshitko, S. Šaro, J. Uusitalo, A.V. Yeremin
2002Hu14	EPJAA	15,	329	A. Hürstel, M. Rejmund, E. Bouchez, P.T. Greenlees, K. Hauschild, S. Juutinen, H. Kettunen, W. Kortzen, Y. Le Coz, P. Nieminen, Ch. Theisen, A.N. Andreyev, F. Becker, T. Enqvist, P.M. Jones, R. Julin, H. Kankaanpää, A. Keenan, P. Kuusiniemi, M. Leino, A.-P. Leppänen, M. Muikku, J. Pakarinen, P. Rahkila, J. Uusitalo
2002Iz01	FECLA	111,	36	I.N. Izosimov, A.A. Kazimov, A.A. Solnyshkin
2002Je09	PRVCA	66,	011301	D.G. Jenkins, A.N. Andreyev, R.D. Page, M.P. Carpenter, R.V.F. Janssens, C.J. Lister, F.G. Kondev, T. Enqvist, P.T. Greenlees, P.M. Jones, R. Julin, S. Juutinen, H. Kettunen, P. Kuusiniemi, M. Leino, A.-P. Leppänen, P. Nieminen, J. Pakarinen, P. Rahkila, J. Uusitalo, C.D. O'Leary, P. Raddon, A. Simons, R. Wadsworth, D.T. Joss
2002Je11	NUPAB	709,	119	H. Jeppesen, U.C. Bergmann, M.J.G. Borge, J. Cederkäll, V.N. Fedoseyev, H.O.U. Fynbo, V.Y. Hansper, B. Jonson, K. Markenroth, V.I. Mishin, T. Nilsson, G. Nyman, K. Riisager, O. Tengblad, K. Wilhelmsen Rolander, ISOLDE
2002Jo09	EPJDR	4,	A3	A. Jokinen, A. Nieminen, J. Äystö, R. Borcea, E. Caurier, P. Dendooven, M. Gierlik, M. Górka, H. Grawe, M. Hellström, M. Karny, Z. Janas, R. Kirchner, M. La Commara, G. Martinez-Pinedo, P. Mayet, H. Penttilä, A. Plochocki, M. Rejmund, E. Roeckl, M. Sawicka, C. Schlegel, K. Schmidt, R. Schwengner
2002Ke.A	Th.-Heidelberg			A. Kellerbauer
2002Ke.C	PrvCom	NDG	May	H. Kettunen
2002Ko09	PYLBB	528,	221	F.G. Kondev, M.P. Carpenter, R.V.F. Janssens, C.J. Lister, K. Abu Saleem, I. Ahmad, H. Amro, J. Caggiano, C.N. Davids, A. Heinz, B. Herskind, T.L. Khoo, T. Lauritsen, W.C. Ma, J.J. Ressler, W. Reviol, L.L. Riedinger, D.G. Sarantites, D. Seweryniak, S. Siem, A.A. Sonzogni, P.G. Varnette, I. Wiedenhöver
2002La18	NUPAB	708,	167	M. La Commara, K. Schmidt, H. Grawe, J. Döring, R. Borcea, S. Galanopoulos, M. Górka, S. Harissopoulos, M. Hellström, Z. Janas, R. Kirchner, C. Mazzocchi, A.N. Ostrowski, C. Plettner, G. Rainovski, E. Roeckl
2002Le16	PRVCA	65,	054318	A. Lépine-Szily, J.M. Oliveira, Jr, V.R. Vanin, A.N. Ostrowski, R. Lichtenthaler, A. Di Pietro, V. Guimarães, A.M. Laird, I. Mannoury, G.F. Lima, F. de Oliveira Santos, P. Roussel-Chomaz, H. Savajois, W. Trindler, A.C.C. Villari, A. de Vismes

2002Le.A	PrvCom	GAu	Jun	Lettre électronique de l'In2p3
2002Li24	PRVCA	65,	044618	G.F. Lima, A. Lépine-Szily, G. Audi, W. Mittig, M. Chartier, N.A. Orr, R. Lichenthaler, J.-C. Angélique, J.-M. Casandjian, A. Cunsolo, C. Donzaud, A. Foti, A. Gillibert, M. Lewitowicz, S. Lukyanov, M. MacCormick, D.J. Morrissey, A.N. Ostrowski, B.M. Sherrill, C. Stéphan, T. Suomijärvi, L. Tassan-Got, D.J. Vieira, A.C.C. Villari, J.M. Wouters
2002Lo13	PRVCA	66,	025803	M.J. López Jiménez, B. Blank, M. Chartier, S. Czajkowski, P. Dessagne, G. de France, J. Giovinazzo, D. Karamanis, M. Lewitowicz, V. Maslov, C. Miehé, P.H. Regan, M. Stanoiu, M. Wiescher
2002Lu15	EPJAA	15,	315	R. Lucas, M.-G. Porquet, Ts. Venkova, I. Deloncle, M. Houry, Ch. Theisen, A. Astier, A. Bauchet, S. Lalkovski, G. Barreau, N. Buforn, T.P. Doan, L. Donadille, O. Dorvaux, J. Durell, Th. Ethvignot, B.P.J. Gall, D. Grimwood, W. Korten, Y. Le Coz, M. Meyer, A. Minkova, A. Prévost, N. Redon, A. Roach, N. Schulz, A.G. Smith, O. Stézowski, B.J. Varley
2002Ma19	PYLBB	532,	29	C. Mazzocchi, Z. Janas, L. Batist, V. Belleguic, J. Döring, M. Gierlik, M. Kapica, R. Kirchner, G.A. Lalazissis, H. Mahmud, E. Roeckl, P. Ring, K. Schmidt, P.J. Woods, J. Żylicz
2002Ma61	EPJAA	15,	85	H. Mahmud, C.N. Davids, P.J. Woods, T. Davinson, A. Heinz, J.J. Ressler, K. Schmidt, D. Seweryniak, J. Shergur, A.A. Sonzogni, W.B. Walters
2002Me07	PRLTA	88,	102501	M. Meister, K. Markenroth, D. Aleksandrov, T. Aumann, L. Axelsson, T. Baumann, M.J.G. Borge, L.V. Chulkov, W. Dostal, B. Eberlein, Th. W. Elze, H. Emling, C. Forssén, H. Geissel, M. Hellström, R. Holzmann, B. Jonson, J.V. Kratz, R. Kulesa, Y. Leifels, A. Leistenschneider, I. Mukha, G. Münzenberg, F. Nickel, T. Nilsson, G. Nyman, A. Richter, K. Riisager, C. Scheidenberger, G. Schrieder, H. Simon, O. Tengblad, M.V. Zhukov
2002Mo31	PYLBB	547,	200	R. Moore, A.M. Bruce, P. Dendooven, J. Billowes, P. Campbell, A. Ezwam, K.T. Flanagan, D.H. Forest, J. Huikari, A. Jokinen, A. Nieminen, H.L. Thayer, G. Tungate, S. Zemlyanoi, J. Äystö
2002Mo.B	P-Aizu		140	Morimoto
2002Mu.A	AnRpt ANL,		51	G. Mukherjee et al
2002Ni10	PRLTA	89,	039901	V. Ninov, K.E. Gregorich, W. Loveland, A. Ghiorso, D.C. Hoffman, D.M. Lee, H. Nitsche, W.J. Swiatecki, U.W. Kirbach, C.A. Laue, J.L. Adams, J.B. Patin, D.A. Shaughnessy, D.A. Strellis, P.A. Wilk
2002No11	PYLBB	542,	49	M. Notani, H. Sakurai, N. Aoi, Y. Yanagisawa, A. Saito, N. Imai, T. Gomi, M. Miura, S. Michimasa, H. Iwasaki, N. Fukuda, M. Ishihara, T. Kubo, S. Kubono, H. Kumagai, S.M. Lukyanov, T. Motobayashi, T.K. Onishi, Yu. E. Penionzhkevich, S. Shimoura, T. Teranishi, K. Ue, V. Ugryumov, A. Yoshida
2002Pe15	EPJAA	14,	439	C.M. Petrache, G. Lo Bianco, P.G. Bizzeti, A.M. Bizzeti-Sona, D. Bazzacco, S. Lunardi, M. Nespolo, G. de Angelis, P. Spolaore, N. Blasi, S. Brant, V. Krstić, D. Vretenar
2002Pf02	EPJAA	14,	279	M. Pfützner, E. Badura, C. Bingham, B. Blank, M. Chartier, H. Geissel, J. Giovinazzo, L.V. Grigorenko, R. Grzywacz, M. Hellström, Z. Janas, J. Kurcewicz, A.S. Lalleman, C. Mazzocchi, I. Mukha, G. Münzenberg, C. Plettner, E. Roeckl, K.P. Rykaczewski, K. Schmidt, R.S. Simon, M. Stanoiu, J.-C. Thomas
2002PI03	PRVCA	66,	044319	Plettner, C. , L. Batisit, J. Doering, A. Blazhev, H. Grawe, V. Belleguic, C.R. Bingham, R. Borcea, M. Gierlik, M. Goerska, N. Harringyon, Z. Janas, M. Karny, R. Kirchner, C. Mazzocchi, P. Munro, E. Roeckl, K. Schmidt, R. Schwengner
2002Py01	PRLTA	88,	122501	M.C. Pyle, A. García, E. Tatar, J. Cox, B.K. Nayak, S. Triambak, B. Laughman, A. Komives, L.O. Lamm, J.E. Rolon, T. Finnessy, L.D. Knutson, P.A. Voytas
2002Py02	NIMAE	488,	381	Yu. V. Pyatkov, V.G. Tishchenko, V.V. Pashkevich, V.A. Maslov, D.V. Kamanin, I.V. Kljuev, W.H. Trzaska
2002Ra23	NUPAB	706,	3	H. Raimbault-Hartmann, G. Audi, D. Beck, G. Bollen, M. de Saint Simon, H.-J. Kluge, M. König, R.B. Moore, S. Schwarz, G. Savard, J. Szerypo, ISOLDE
2002Ro17	PRVCA	65,	054310	M.W. Rowe, J.C. Batchelder, T.N. Ginter, K.E. Gregorich, F.Q. Guo, F.P. Heßberger, V. Ninov, J. Powell, K.S. Toth, X.J. Xu, J. Cerny

2002Sh08	PRVCA	65,	034313	J. Shergur, B.A. Brown, V. Fedoseyev, U. Köster, K.-L. Kratz, D. Seweryniak, W.B. Walters, A. Wöhr, D. Fedorov, M. Hannawald, M. Hjorth-Jensen, V. Mishin, B. Pfeiffer, J.J. Ressler, H.O.U. Fynbo, P. Hoff, H. Mach, T. Nilsson, K. Wilhelmsen-Rolander, H. Simon, A. Bickley, ISOLDE
2002Sh16	JUPSA	71,	1401	M. Shibata, T. Shindou, A. Taniguchi, Y. Kojima, K. Kawade, S.-I. Ichikawa, Y. Kawase
2002Sh43	PTPSA	146,	60	B.-M. Sherrill
2002Sh.A	AnRpt JAERI		26	M. Shibata, T. Shindou, Y. Kojima, M. Asai, K. Tsukada, S. Ichikawa, H. Haba, Y. Nagame, K. Kawade
2002Sh.B	P-Aulanko		479	M. Shibata, T. Shindou, K. Kawade, V. Kojima, A. Taniguchi, Y. Kawase, S. Ichikawa
2002Sh.C	AnRpt JAERI		45	N. Shinohara, Yu. N. Novikov, G. Münzenberg, H. Wollnik, Y. Hatsukawa, M. Asai, K. Tsukada, A. Osa, M. Oshima, H. Haba, S. Ichikawa, Y. Nagame, A.V. Popov, D.M. Seliverstov and PrvCom to 2008Qi03
2002So.A	PrvCom	GAu	Oct	O. Sorlin
2002Tr04	ADNDA	80,	83	V.I. Tretyak, Yu. G. Zdesenko
2002Tu05	EPJAA	15,	271	A. Türler "Heavy-element chemistry - Status and perspectives"
2002Un02	ARISE	56,	125	M.P. Unterweger
2002Va13	PRVCA	65,	064301	K. Van de Vel, A.N. Andreyev, M. Huyse, P. Van Duppen, J.F.C. Cocks, O. Dorvaux, P.T. Greenlees, K. Helariutta, P. Jones, R. Julin, S. Juutinen, H. Kettunen, P. Kuusiniemi, M. Leino, M. Muikku, P. Nieminen, K. Eskola, R. Wyss
2002We07	PRVCA	65,	044321	L. Weissman, J. Cederkall, J. Äystö, H. Fynbo, L. Fraile, V. Fedoseyev, S. Franchoo, A. Jokinen, U. Köster, G. Martinez-Pinedo, T. Nilsson, M. Oinonen, K. Peräjärvi, M.D. Seliverstov, ISOLDE
2002Xu11	PRVCA	66,	047302	S.W. Xu, Z.K. Li, F.R. Xu, Y.X. Xie, X.D. Wang
2002Zd02	PYLBB	546,	206	Yu. G. Zdesenko, F.A. Danevich, V.I. Tretyak
2003				
2003Ah07	PRVCA	68,	044306	I. Ahmad, R.R. Chasman, J.P. Greene, F.G. Kondev, E.F. Moore, E. Browne, C.E. Porter, L.K. Felker
2003A102	PRVCA	67,	014323	A. Alessandrello, C. Arnaboldi, C. Brofferio, S. Capelli, O. Cremonesi, E. Fiorini, A. Nucciotti, M. Pavan, G. Pessina, S. Pirro, E. Previtali, M. Sisti, M. Vanzini, L. Zanotti, A. Giuliani, M. Pedretti, C. Bucci, C. Pobes
2003An26	EPJAA	18,	39	A.N. Andreyev, D. Ackermann, S. Antalic, H.J. Boardman, P. Cagarda, J. Gerl, F.P. Heßberger, S. Hofmann, M. Huyse, D. Karlgren, A. Keenan, H. Kettunen, A. Kleinböhl, B. Kindler, I. Kojouharov, A. Lavrentiev, C.D. O'Leary, M. Leino, B. Lommel, M. Matos, C.J. Moore, G. Münzenberg, R.D. Page, S. Reshitko, S. Saro, H. Schaffner, C. Schlegel, M.J. Taylor, K. Van de Vel, P. Van Duppen, L. Weissman, K. Heyde
2003An27	EPJAA	18,	55	A.N. Andreyev, D. Ackermann, F.P. Heßberger, S. Hofmann, M. Huyse, I. Kojouharov, B. Kindler, B. Lommel, G. Münzenberg, R.D. Page, K. Van de Vel, P. Van Duppen, K. Heyde
2003Ar36	PRLTA	91,	161802	C. Arnaboldi, C. Brofferio, O. Cremonesi, E. Fiorini, C. Lo Bianco, L. Martensson, A. Nucciotti, M. Pavan, G. Pessina, S. Pirro, E. Previtali, M. Sisti, A. Giuliani, B. Margesin, M. Zen
2003Ba18	PRVCA	67,	034310	C.J. Barton, D.S. Brenner, N.V. Zamfir, M.A. Caprio, A. Aprahamian, M.C. Wiescher, C.W. Beausang, Z. Berant, R.F. Casten, J.R. Cooper, R.L. Gill, R. Krücken, J.R. Novak, N. Pietralla, M. Shawcross, A. Teymurazyan, A. Wolf
2003Ba20	EPJAA	16,	489	T. Bäck, B. Cederwall, K. Lagergren, R. Wyss, A. Johnson, D. Karlgren, P. Greenlees, D. Jenkins, P. Jones, D.T. Joss, R. Julin, S. Juutinen, A. Keenan, H. Kettunen, P. Kuusiniemi, M. Leino, A.-P. Leppänen, M. Muikku, P. Nieminen, J. Pakarinen, P. Rahkila, J. Uusitalo
2003Ba39	NUPAB	720,	245	L. Batist, J. Döring, I. Mukha, C. Plettner, C.R. Bingham, R. Borcea, M. Gierlik, H. Grawe, K. Hauschild, Z. Janas, I.P. Johnstone, M. Karny, M. Kavatsyuk, R. Kirchner, M. La Commara, C. Mazzocchi, F. Moroz, J. Pavan, A. Płochocki, E. Roeckl, B. Salvachúa, K. Schmidt, R. Schwengner, L.D. Skouras, S.L. Tabor, M. Wiedeking
2003Ba49	PRVCA	67,	064316	D.K. Barillari, J.V. Vaz, R.C. Barber, K.S. Sharma

2003Ba.A	PrvCom	GAu	Apr	C. Bachelet
2003Be02	EPJDD	22,	41	I. Bergström, M. Björkhage, K. Blaum, H. Bluhme, T. Fritioff, Sz. Nagy, R. Schuch
2003Be05	NUPAB	714,	21	U.C. Bergmann, C.A. Diget, K. Riisager, L. Weissman, G. Auböck, J. Cederkäll, L.M. Fraile, H.O.U. Fynbo, H. Gausemel, H. Jeppesen, U. Köster, K.-L. Kratz, P. Möller, T. Nilsson, B. Pfeiffer, H. Simon, K. Van de Vel, J. Äystö, ISOLDE
2003Be18	EPJAA	16,	447	A.V. Belozеров, M.L. Chelnokov, V.I. Chepigín, T.P. Drobina, V.A. Gorshkov, A.P. Kabachenko, O.N. Malyshev, I.M. Merkin, Yu. Ts. Oganessian, A.G. Popeko, R.N. Sagaidak, A.I. Svirikhin, A.V. Yeremin, G. Berek, I. Brida, Š. Šáro
2003Bi05	PRVCA	67,	065801	I. Bikit, N. Zikić-Todorović, J. Slivka, M. Vesković, M. Krmar, Lj. Čonkić, J. Pužović, I.V. Aničin
2003B117	PRLTA	91,	260801	K. Blaum, G. Audi, D. Beck, G. Bollen, F. Herfurth, A. Kellerbauer, H.-J. Kluge, E. Sauvan, S. Schwarz
2003Bo25	NUPAB	726,	175	V. Bondarenko, A.V. Afanasjev, F. Bečvář, J. Honzátka, M.-E. Montero-Cabrera, I. Kuvaga, S.J. Robinson, A.M.J. Spits, S.A. Telezchnikov
2003Ce01	PYLBB	556,	14	S. Cebrián, N. Coron, G. Dambier, P. de Marcillac, E. García, I.G. Irastorza, J. Leblanc, A. Morales, J. Morales, A. Ortiz de Solórzano, J. Puimedón, M.L. Sarsa, J.A. Villar
2003Da05	PRVCA	67,	014310	F.A. Danevich, A. Sh. Georgadze, V.V. Kobychyev, S.S. Nagorny, A.S. Nikolaiko, O.A. Ponkratenko, V.I. Tretyak, S. Yu. Zdesenko, Yu. G. Zdesenko, P.G. Bizzeti, T.F. Fazzini, P.R. Maurenzig
2003Da09	NUPAB	717,	129	F.A. Danevich, A.S. Georgadze, V.V. Kobychyev, A.S. Nikolaiko, O.A. Ponkratenko, V.I. Tretyak, S.Y. Zdesenko, Y.G. Zdesenko, P.G. Bizzeti, T.F. Fazzini, P.R. Maurenzig
2003De11	NATUA	422,	876	P. de Marcillac, N. Coron, G. Dambier, J. Leblanc, J.-P. Moalic
2003Di06	PRLTA	91,	162503	I. Dillmann, K.-L. Kratz, A. Wöhr, O. Arndt, B.A. Brown, P. Hoff, M. Hjorth-Jensen, U. Köster, A.N. Ostrowski, B. Pfeiffer, D. Seweryniak, J. Shergur, W.B. Walters, ISOLDE
2003Do09	PRVCA	68,	034306	J. Döring, H. Grawe, K. Schmidt, R. Borcea, S. Galanopoulos, M. Górska, S. Harissopoulos, M. Hellström, Z. Janas, R. Kirchner, M. La Commara, C. Mazzocchi, E. Roeckl, R. Schwengner
2003Fr08	PHSTB	67,	276	T. Fritioff, G. Douysset
2003Fu10	NUPAB	718,	688c	Zs. Fülöp, L. Bartha, Gy. Gyürky, E. Somorjai, S. Kubono, H. Kudo, D. Kaji
2003Ge04	PRVCA	67,	054312	J. Genevey, J.A. Pinston, H.R. Faust, R. Orlandi, A. Scherillo, G.S. Simpson,, I.S. Tsekhanovich, A. Covello, A. Gargano, W. Urban
2003Gi05	PRVCA	67,	064609	T.N. Ginter, K.E. Gregorich, W. Loveland, D.M. Lee, U.W. Kirbach, R. Sudowe, C.M. Folden III, J.B. Patin, N. Seward, P.A. Wilk, P.M. Zielinski, K. Aleklett, R. Eichler, H. Nitsche, D.C. Hoffman
2003Gi06	NUPAB	724,	313	M. Gierlik, A. Plochocki, M. Karny, W. Urban, Z. Janas, L. Batist, F. Moroz, R. Collatz, M. Górska, H. Grawe, M. Hellström, Z. Hu, R. Kirchner, W. Liu, M. Rejmund, E. Roeckl, M. Shibata, J. Agramunt, A. Algora, A. Gadea, B. Rubio, J.L. Tain, D. Cano-Ott, S. Harissopoulos
2003Gi10	PRVCA	68,	034330	T.N. Ginter, J.C. Batchelder, C.R. Bingham, C.J. Gross, R. Grzywacz, J.H. Hamilton, Z. Janas, M. Karny, A. Piechaczek, A.V. Ramayya, K.P. Rykaczewski, W.B. Walters, E.F. Zganjar
2003Go11	PYLBB	566,	70	M.S. Golovkov, Yu. Ts. Oganessian, D.D. Bogdanov, A.S. Fomichev, A.M. Rodin, S.I. Sidorchuk, R.S. Slepnev, S.V. Stepantsov, G.M. Ter-Akopian, R. Wolski, V.A. Gorshkov, M.L. Chelnokov, M.G. Itkis, E.M. Kozulin, A.A. Bogatchev, N.A. Kondratiev, I.V. Korzyukov, A.A. Yukhimchuk, V.V. Perevozchikov, Yu. I. Vinogradov, S.K. Grishechkin, A.M. Demin, S.V. Zlatoustovsky, A.V. Kuryakin, S.V. Fil'chagin, R.I. Il'kayev, F. Hanappe, T. Matera, L. Stuttge, A.H. Ninane, A.A. Korshennikov, E. Yu. Nikolskii, I. Tanihata, P. Roussel-Chomaz, W. Mittig, N. Alamanos, V. Lapoux, E.C. Pollacco, L. Nalpas
2003Gr13	NUPAB	724,	14	C. Granja, S. Pospíšil, J. Kubašta, S.A. Telezchnikov
2003Gr27	NUPAB	729,	679	C. Granja, S. Pospíšil, S.A. Telezchnikov, R.E. Chrien

2003Gu06	PRVCA	67,	064601	V. Guimarães, S. Kubono, F.C. Barker, M. Hosaka, S.C. Jeong, I. Katayama, T. Miyachi, T. Nomura, M.H. Tanaka, Y. Fuchi, H. Kawashima, S. Kato, C.C. Yun, K. Ito, H. Orihara, T. Terakawa, T. Kishida, Y. Pu, S. Hamada, M. Hirai, H. Miyatake
2003He06	EPJAA	16,	365	F.P. Heßberger, S. Hofmann, D. Ackermann
2003Hu01	EPJAA	16,	359	J. Huikari, M. Oinonen, A. Algora, J. Cederkäll, S. Courtin, P. Dessagne, L. Fraile, S. Franchoo, H. Fynbo, W.X. Huang, A. Jokinen, A. Knipper, F. Marechal, C. Miehe, E. Nacher, K. Peräjärvi, E. Poirier, L. Weissman, J. Äystö, ISOLDE
2003Ke04	EPJAA	16,	457	H. Kettunen, T. Enqvist, M. Leino, K. Eskola, P.T. Greenlees, K. Helariutta, P. Jones, R. Julin, S. Juutinen, H. Kankaanpää, H. Koivisto, P. Kuusiniemi, M. Muikku, P. Nieminen, P. Rakkila, J. Uusitalo
2003Ke08	EPJAA	17,	537	H. Kettunen, T. Enqvist, T. Grahn, P.T. Greenlees, P. Jones, R. Julin, S. Juutinen, A. Keenan, P. Kuusiniemi, M. Leino, A.-P. Leppänen, P. Nieminen, J. Pakarinen, P. Rakkila, J. Uusitalo
2003Ki08	NUPAB	723,	499	H. Kiel, D. Münstermann, K. Zuber
2003Ko.A	Th.-Jyvaskyla			V. Kolhinen
2003Kr20	RAACA	91,	59	J.V. Kratz, A. Nähler, U. Rieth, A. Kronenberg, B. Kuczewski, E. Strub, W. Brühle, M. Schädel, B. Schausten, A. Türler, H.W. Gäggeler, D.T. Jost, K.E. Gregorich, H. Nitsche, C. Laue, R. Sudowe, P.A. Wilk
2003Ku25	EPJAA	18,	5	J. Kurpeta, A. Plochocki, A.N. Andreyev, J. Äystö, A. De Smet, H. De Witte, A.-H. Evensen, V. Fedoseyev, S. Franchoo, M. Górska, M. Huhta, M. Huyse, Z. Janas, A. Jokinen, M. Karny, E. Kugler, W. Kurcewicz, U. Köster, J. Lettry, A. Nieminen, K. Partes, M. Ramdhane, H.L. Ravn, K. Rykaczewski, J. Szerypo, K. Van de Vel, P. Van Duppen, L. Weissman, G. Walter, A. Wöhr, ISOLDE
2003Le26	NUPAB	722,	512	A. Lepine-Szily, J.M. Oliveira, D. Galante, G. Amadio, V. Vanin, R. Lichtenhaler, V. Guimaraes, G.F. Lima, H.G. Bohlen, A.N. Ostrowski, A. Di Pietro, A.M. Laird, L. Maunoury, F. de Oliveira Santos, P. Roussel-Chomaz, H. Savajols, W. Trinder, A.C.C. Villari, A. de Vismes
2003Li42	PYLBB	573,	80	Yu. A. Litvinov, F. Attallah, K. Beckert, F. Bosch, D. Boutin, M. Falch, B. Franzke, H. Geissel, M. Hausmann, Th. Kerscher, O. Klepper, H.-J. Kluge, C. Kozhuharov, K.E.G. Löbner, G. Münzenberg, F. Nolden, Yu. N. Novikov, Z. Patyk, T. Radon, C. Scheidenberger, J. Stadlmann, M. Steck, M.B. Trzhaskovskaya, H. Wollnik
2003Li.A	PrvCom	GAu	Jul	Y. Litvinov, Ch. Scheidenberger
2003Li.B	PrvCom	GAu	Aug	Y. Litvinov
2003Ma02	PRVCA	67,	014311	P.F. Mantica, A.C. Morton, B.A. Brown, A.D. Davies, T. Glasmacher, D.E. Groh, S.N. Liddick, D.J. Morrissey, W.F. Mueller, H. Schatz, A. Stolz, S.L. Tabor, M. Honma, M. Horoi, T. Otsuka
2003Ma34	EPJAA	17,	519	C. Mazzocchi, E. Badura, C. Bingham, B. Blank, M. Chartier, H. Geissel, J. Giovinazzo, E. Grodner, R. Grzywacz, M. Hellström, Z. Janas, J. Kurcewicz, A.S. Lalleman, I. Mukha, G. Münzenberg, M. Pfützner, C. Plettner, E. Roeckl, K.P. Rykaczewski, K. Schmidt, R.S. Simon, M. Stanoiu, J.-C. Thomas
2003Me11	NUPAB	723,	13	M. Meister, L.V. Chulkov, H. Simon, T. Aumann, M.J.G. Borge, Th. W. Elze, H. Emling, H. Geissel, M. Hellström, B. Jonson, J.V. Kratz, R. Kulesa, Y. Leifels, K. Markenroth, G. Münzenberg, F. Nickel, T. Nilsson, G. Nyman, V. Pribora, A. Richter, K. Riisager, C. Scheidenberger, G. Schrieder, O. Tengblad
2003Me20	PRVCA	68,	041301	A. Melerangi, D. Appelbe, R.D. Page, H.J. Boardman, P.T. Greenlees, P. Jones, D.T. Joss, R. Julin, S. Juutinen, H. Kettunen, P. Kuusiniemi, M. Leino, M.H. Muikku, P. Nieminen, J. Pakarinen, P. Rakkila, J. Simpson
2003Mo36	NUPAB	728,	350	C.-B. Moon, T. Komatsubara, T. Shizuma, Y. Sasaki, K. Furuno, C.S. Lee
2003Ni10	PRVCA	68,	064305	K. Nishio, H. Ikezoe, S. Mitsuoka, K. Satou, C.J. Lin
2003Ni11	PRVCA	68,	067301	Y. Nir-El, G. Haquin
2003Oz01	PRVCA	67,	014610	A. Ozawa, Y. Yamaguchi, M. Chiba, R. Kanungo, K. Kimura, S. Momota, T. Suda, T. Suzuki, I. Tanihata, T. Zheng, S. Watanabe, T. Yamaguchi, K. Yoshida

2003Pe23	PRVCA	68,	034607	W.A. Peters, T. Baumann, D. Bazin, B.A. Brown, R.R.C. Clement, N. Frank, P. Heckman, B.A. Luther, F. Nunes, J. Seitz, A. Stolz, M. Thoennessen, E. Tryggestad
2003Pi03	EPJAA	16,	313	I. Piqueras, M.J.G. Borge, Ph. Dessagne, J. Giovinazzo, A. Huck, A. Jokinen, A. Knipper, C. Longour, G. Marguier, M. Ramdhane, V. Rauch, O. Tengblad, G. Walter, Ch. Miché, ISOLDE
2003Pi08	PRVCA	67,	051305	A. Piechaczek, E.F. Zganjar, G.C. Ball, P. Bricault, J.M. D'Auria, J.C. Hardy, D.F. Hodgson, V. Iacob, P. Klages, W.D. Kulp, J.R. Leslie, M. Lipoglavsek, J.A. Macdonald, H.-B. Mak, D.M. Moltz, G. Savard, J. von Schwarzenberg, C.E. Svensson, I.S. Towner, J.L. Wood
2003Ro21	PRVCA	68,	054301	A.P. Robinson, C.N. Davids, G. Mukherjee, D. Seweryniak, S. Sinha, P. Wilt, P.J. Woods
2003Sa02	EPJAA	16,	51	M. Sawicka, J.M. Daugas, H. Grawe, S. Ćwiok, D.L. Balabanski, R. Béraud, C. Bingham, C. Borcea, M. La Commara, G. de France, G. Georgiev, M. Górka, R. Grzywacz, M. Hass, M. Hellström, Z. Janas, M. Lewitowicz, H. Mach, I. Matea, G. Neyens, C. O'Leary, F. de Oliveira Santos, R.D. Page, M. Pfützner, Zs. Podolyák, K. Rykaczewski, M. Stanoiu, J. Żylicz
2003So02	EPJAA	16,	55	O. Sorlin, C. Donzaud, F. Nowacki, J.C. Angélique, F. Azaiez, C. Bourgeois, V. Chiste, Z. Dlouhy, S. Grévy, D. Guillemaud-Mueller, F. Ibrahim, K.-L. Kratz, M. Lewitowicz, S.M. Lukyanov, J. Mrazek, Yu.-E. Penionzhkevich, F. de Oliveira Santos, B. Pfeiffer, F. Pougheon, A. Poves, M.G. Saint-Laurent, M. Stanoiu
2003So21	NUPAB	719,	193c	O. Sorlin, C. Donzaud, F. Azaiez, C. Bourgeois, L. Gaudefroy, F. Ibrahim, D. Guillemaud-Mueller, F. Pougheon, M. Lewitowicz, F. de Oliveira Santos, M.G. Saint-Laurent, M. Stanoiu, S.M. Lukyanov, Yu. E. Penionzhkevich, J.C. Angélique, S. Grévy, K.-L. Kratz, B. Pfeiffer, F. Nowacki, Z. Dlouhy, J. Mrasek
2003To03	PRVCA	67,	035503	N.R. Tolich, P.H. Barker, P.D. Harty, P.A. Amundsen
2003To08	NUPAB	717,	149	I. Tomandl, T. von Egidy, J. Honzátko, V. Bondarenko, H.-F. Wirth, D. Bucurescu, V.Y. Ponomarev, G. Graw, R. Hertenberg, Y. Eisermann, S. Raman
2003Tu05	EPJAA	17,	505	A. Türler, Ch. E. Düllmann, H.W. Gäggeler, U.W. Kirbach, A.B. Yakushev, M. Schädel, W. Bruchle, R. Dressler, K. Eberhardt, B. Eichler, R. Eichler, T.N. Ginter, F. Glaus, K.E. Gregorich, D.C. Hoffman, E. Jäger, D.T. Jost, D.M. Lee, H. Nitsche, J.B. Patin, V. Pershina, D. Piguet, Z. Qin, B. Schausten, E. Schimpf, H.-J. Schött, S. Soverna, R. Sudowe, P. Thörle, S.N. Timokhin, N. Trautmann, A. Vahle, G. Wirth, P.M. Zielinski
2003Va16	PRVCA	68,	054311	K. Van de Vel, A.N. Andreyev, D. Ackermann, H.J. Boardman, P. Cagarda, J. Gerl, F.P. Heßberger, S. Hofmann, M. Huyse, D. Karlgren, I. Kojouharov, M. Leino, B. Lommel, G. Münzenberg, C. Moore, R.D. Page, S. Saro, P. Van Duppen, R. Wyss
2003Va.A	PrvCom	GAu	Aug	R.S. Van Dyck, Jr.
2003Vo03	NUPAB	714,	355	T. von Egidy, C. Doll, J. Jolie, N.V. Warr, J. Kern, M. Crittin, L. Genilloud
2003Wa13	PRVCA	67,	064303	Y. Wang, S. Rinta-Antila, P. Dendooven, J. Huikari, A. Jokinen, V.S. Kolhinen, G. Lhersonneau, A. Nieminen, S. Nummela, H. Penttilä, K. Peräjärvi, J. Szerypo, J.C. Wang, J. Äystö
2003Wi02	NUPAB	716,	3	H.-F. Wirth, T. von Egidy, I. Tomandl, J. Honzátko, D. Bucurescu, N. Mrginean, V. Yu. Ponomarev, R. Hertenberg, Y. Eisermann, G. Graw
2003Xu04	EPJAA	16,	347	S.W. Xu, Y.X. Xie, Z.K. Li, X.D. Wang, B. Guo, C.G. Leng, C.F. Wang, Y. Yu
2003Ye02	YAFIA	66,	1078	A.V. Yeremin, A.V. Belozarov, M.L. Chelnokov, V.I. Chepigina, V.A. Gorskov, A.P. Kabachenko, O.N. Malyshev, Yu. Ts. Oganessian, A.G. Popeko, R.N. Sagaidak, A.I. Svirikhin, S. Hofmann, G. Berek, I. Brida, S. Saro
2003Yo02	PRVCA	67,	014316	K. Yoneda, N. Aoi, H. Iwasaki, H. Sakurai, H. Ogawa, T. Nakamura, W.-D. Schmidt-Ott, M. Schäfer, M. Notani, N. Fukuda, E. Ideguchi, T. Kishida, S.S. Yamamoto, M. Ishihara

2004

2004A104	PRVCA	69,	024320	S.D. Al-Garni, P.H. Regan, P.M. Walker, E. Roeckl, R. Kirchner, F.R. Xu, L. Batist, A. Blazhev, R. Borcea, D.M. Cullen, J. Döring, H.M. El-Masri, J. Garces Narro, H. Grawe, M. La Commara, C. Mazzocchi, I. Mukha, C.J. Pearson, C. Plettner, K. Schmidt, W.D. Schmidt-Ott, Y. Shimbara, C. Wheldon, R. Wood, S.C. Wooding
2004An07	PRVCA	69,	054308	A.N. Andreyev, D. Ackermann, F.P. Heßberger, K. Heyde, S. Hofmann, M. Huyse, D. Karlgren, I. Kojouharov, B. Kindler, B. Lommel, G. Münzenberg, R.D. Page, K. Van de Vel, P. Van Duppen, W.B. Walters, R. Wyss
2004As12	EPJAA	22,	411	M. Asai, M. Sakama, K. Tsukada, S. Ichikawa, H. Haba, I. Nishinaka, Y. Nagame, S. Goto, Y. Kojima, Y. Oura, H. Nakahara, M. Shibata, K. Kawade
2004Ba78	PRVCA	70,	024302	P.H. Barker, I.C. Barnett, G.J. Baxter, A.P. Byrne
2004Ba.A	PrvCom	GAu	Jul	C. Bachelet
2004B110	PRVCA	69,	064304	A. Blazhev, M. Górska, H. Grawe, J. Nyberg, M. Palacz, E. Caurier, O. Dorvaux, A. Gadea, F. Nowacki, C. Andreoiu, G. de Angelis, D. Balabanski, Ch. Beck, B. Cederwall, D. Curien, J. Döring, J. Ekman, C. Fahlander, K. Lagergren, J. Ljungvall, M. Moszyński, L.-O. Norlin, C. Plettner, D. Rudolph, D. Soehler, K.M. Spohr, O. Thelen, M. Weiszflog, M. Wisell, M. Wolińska, W. Wolski
2004B116	EULEE	67,	586	K. Blaum, D. Beck, G. Bollen, P. Delahaye, C. Guenaut, F. Herfurth, A. Kellerbauer, H.-J. Kluge, D. Lunney, S. Schwarz, L. Schweikhard, C. Yazidjian
2004B120	NUPAB	746,	305c	K. Blaum, G. Audi, D. Beck, G. Bollen, C. Guénaut, P. Delahaye, F. Herfurth, A. Kellerbauer, H.-J. Kluge, D. Lunney, D. Rodríguez, S. Schwarz, L. Schweikhard, C. Weber, C. Yazidjian
2004Br14	PRVCA	69,	034327	S. Brant, G. Lhersonneau, K. Sistemich
2004Br19	EPJAA	20,	145	R. Broda, B. Fornal, W. Krolas, T. Pawlat, J. Wrzesinski, D. Bazzacco, G. de Angelis, S. Lunardi, C. Rossi Alvarez
2004C103	PRLTA	92,	192501	J.A. Clark, G. Savard, K.S. Sharma, J. Vaz, J.C. Wang, Z. Zhou, A. Heinz, B. Blank, F. Buchinger, J.E. Crawford, S. Gulick, J.K.P. Lee, A.F. Levand, D. Seweryniak, G.D. Sprouse, W. Trimble
2004Co26	PRVCA	70,	064606	C. Cozzini, G. Angloher, C. Bucci, F. von Feilitzsch, D. Hauff, S. Henry, Th. Jagemann, J. Jochum, H. Kraus, B. Majorovits, V. Mikhailik, J. Ninkovic, F. Petricca, W. Potzel, F. Pröbst, Y. Ramachers, W. Rau, M. Razeti, W. Seidel, M. Stark, L. Stodolsky, A.J.B. Tolhurst, W. Westphal, H. Wulandari
2004Da04	PRVCA	69,	011302	C.N. Davids, P.J. Woods, H. Mahmud, T. Davinson, A. Heinz, J.J. Ressler, K. Schmidt, D. Seweryniak, J. Shergur, A.A. Sonzogni, W.B. Walters
2004De16	PRVCA	69,	044305	H. De Witte, A.N. Andreyev, I.N. Borzov, E. Caurier, J. Cederkäll, A. De Smet, S. Eeckhaudt, D.V. Fedorov, V.N. Fedosseev, S. Franchoo, M. Górska, H. Grawe, G. Huber, M. Huyse, Z. Janas, U. Köster, W. Kurcewicz, J. Kurpeta, A. Plochocki, K. Van de Vel, P. Van Duppen, L. Weissman
2004De40	EPJAA	21,	243	S. Dean, M. Gorska, F. Aksouh, H. de Witte, M. Facina, M. Huyse, O. Ivanov, K. Krouglov, Yu. Kudryavtsev, I. Mukha, D. Smirnov, J.-C. Thomas, K. Van de Vel, J. Van de Walle, P. Van Duppen, J. Van Roosbroeck
2004Di18	EPJAA	22,	163	J. Dilling, F. Herfurth, A. Kellerbauer, G. Audi, G. Bollen, H.-J. Kluge, R.B. Moore, C. Scheidenberger, S. Schwarz, G. Sikler, ISOLDE
2004Dr04	PRVCA	69,	054318	G.D. Dracoulis, G.J. Lane, A.P. Byrne, T. Kibédi, A.M. Baxter, A.O. Macchiavelli, P. Fallon, R.M. Clark
2004Dr06	PYLBB	584,	22	G.D. Dracoulis, F.G. Kondev, G.J. Lane, A.P. Byrne, T. Kibedi, I. Ahmad, M.P. Carpenter, S.J. Freeman, R.V.F. Janssens, N.J. Hammond, T. Lauritsen, C.J. Lister, G. Mukherjee, D. Seweryniak, P. Chowdhury, S.K. Tandel, R. Gramer
2004Fo06	PRVCA	70,	34312	B. Fogelberg, H. Gausemel, K.A. Mezilev, P. Hoff, H. Mach, M. Sanchez-Vega, A. Lindroth, E. Ramstrom, J. Genevey, J.A. Pinston, M. Rejmund
2004Fo08	PRLTA	93,	212702	C.M. Folden III, K.E. Gregorich, Ch. E. Düllmann, H. Mahmud, G.K. Pang, J.M. Schwantes, R. Sudowe, P.M. Zielinski, H. Nitsche, D.C. Hoffman
2004Fu.A	P-Santa Fe		1454	K. Furutaka, H. Harada, S. Raman, AIP Conf. Proc. 769, 1454 (2005)
2004Ga24	PRVCA	69,	054307	H. Gausemel, B. Fogelberg, T. Engeland, M. Hjorth-Jensen, P. Hoff, H. Mach, K.A. Mezilev, J.P. Omtvedt
2004Ga29	EPJAA	20,	385	Z.G. Gan, J.S. Guo, X.L. Wu, Z. Qin, H.M. Fan, X.G. Lei, H.Y. Liu, B. Guo, H.G. Xu, R.F. Chen, C.F. Dong, F.M. Zhang, H.L. Wang, C.Y. Xie, Z.Q. Feng, Y. Zhen, L.T. Song, P. Luo, H.S. Xu, X.H. Zhou, G.M. Jin, Z. Ren

2004Ga44	PRVCA	70,	037301	H. Gausemel, K.A. Mezilev, B. Fogelberg, P. Hoff, H. Mach, E. Ramström
2004GI04	PRVCA	69,	024617	K.A. Gladniskhi, Zs. Podolyák, P.H. Regan, J. Gerl, M. Hellström, Y. Kopatch, S. Mandal, M. Górska, R.D. Page, H.J. Wollersheim, A. Banu, G. Benzoni, H. Boardman, M. La Commara, J. Ekman, C. Fahlander, H. Geissel, H. Grawe, E. Kaza, A. Korgul, M. Matos, M.N. Mineva, C.J. Pearson, C. Plettner, D. Rudolph, Ch. Scheidenberger, K.-H. Schmidt, V. Shishkin, D. Sohler, K. Sümmerer, J.J. Valiente-Dobón, P.M. Walker, H. Weick, M. Winkler, O. Yordanov
2004Go15	PRVCA	69,	031302	V.Z. Goldberg, G.G. Chubarian, G. Tabacaru, L. Trache, R.E. Tribble, A. Aprahamian, G.V. Rogachev, B.B. Skorodumov, X.D. Tang
2004Go38	PRVCA	70,	014309	J. TM. Goon, D.J. Hartley, L.L. Riedinger, M.P. Carpenter, F.G. Kondev, R.V.F. Janssens, K.H. Abu Saleem, I. Ahmad, H. Amro, J.A. Cizewski, C.N. Davids, M. Danchev, T.L. Khoo, A. Heinz, T. Lauritsen, W.C. Ma, G.L. Poli, J. Ressler, W. Reviol, D. Seweryniak, M.B. Smith, I. Wiedenhover, J. Zhang
2004Gr20	PYLBB	594,	252	S. Gřevy, J.C. Angélique, P. Baumann, C. Borcea, A. Buta, G. Canchel, W.N. Catford, S. Courtin, J.M. Daugas, F. de Oliveira, P. Dessagne, Z. Dlouhy, A. Knipper, K.L. Kratz, F.R. Lecolley, J.L. Lecouey, G. Lhersonneau, M. Lewitowicz, E. Liénard, S. Lukyanov, F. Maréchal, C. Miehé, J. Mrazek, F. Negoita, N.A. Orr, D. Pantelica, Y. Penionzhkevich, J. Péter, B. Pfeiffer, S. Pietri, E. Poirier, O. Sorlin, M. Stanoiu, I. Stefan, C. Stodel, C. Timis
2004He25	EPJAA	22,	253	F.P. Heßberger, S. Hofmann, I. Kojouharov, D. Ackermann
2004He28	EPJAA	22,	417	F.P. Heßberger, S. Hofmann, D. Ackermann, P. Cagarda, R.-D. Herzberg, I. Kojouharov, P. Kuusiniemi, M. Leino, R. Mann
2004Io01	PRVCA	70,	034305	M. Ionescu-Bujor, A. Iordachescu, D.L. Balabanski, S. Chmel, G. Neyens, G. Baldsiefen, D. Bazzacco, F. Brandolini, D. Bucurescu, M. Danchev, M. De Poli, G. Georgiev, A. Górgen, H. Haas, H. Hubel, G. Ilie, N. Marginean, R. Menegazzo, P. Pavan, G. Rainovski, R.V. Ribas, C. Rossi Alvarez, C.A. Ur, K. Vyvey, S. Frauendorf
2004Iz02	YAFIA	67,	1901	N. Izosimov, A.A. Kazimov, V.G. Kalinnikov, A.A. Solnyshkin, J. Suhonen
2004Jo12	PRVCA	70,	017302	D.T. Joss, K. Lagergren, D.E. Appelbe, C.J. Barton, J. Simpson, B. Cederwall, B. Hadinia, R. Wyss, S. Eeckhauert, T. Grahn, P.T. Greenlees, P.M. Jones, R. Julin, S. Juutinen, H. Kettunen, M. Leino, A.-P. Leppänen, P. Nieminen, J. Pakarinen, P. Rahkila, C. Scholey, J. Uusitalo, R.D. Page, E.S. Paul, D.R. Wiseman
2004Ka38	PRVCA	70,	014310	M. Karny, L. Batist, D. Jenkins, M. Kavatsyuk, O. Kavatsyuk, R. Kirchner, A. Korgul, E. Roeckl, J. Zylicz
2004Ke06	PRVCA	69,	054323	H. Kettunen, T. Enqvist, T. Grahn, P.T. Greenlees, P. Jones, R. Julin, S. Juutinen, A. Keenan, P. Kuusiniemi, M. Leino, A.-P. Leppänen, P. Nieminen, J. Pakarinen, P. Rahkila, J. Uusitalo
2004Ke10	PRLTA	93,	072502	A. Kellerbauer, G. Audi, D. Beck, K. Blaum, G. Bollen, B.A. Brown, P. Delahaye, C. Guénaut, F. Herfurth, H.-J. Kluge, D. Lunney, S. Schwarz, L. Schweikhard, C. Yazidjian and PrvCom GAU September 2003
2004Kl03	PYLBB	578,	54	H.V. Klapdor-Kleingrothaus, I.V. Krivosheina, A. Dietz, O. Chkvoretz
2004Ko.A	P-Santa Fe		225	F.G. Kondev
2004Ku24	EPJAA	22,	429	P. Kuusiniemi, F.P. Heßberger, D. Ackermann, S. Hofmann, I. Kojouharov
2004Le12	NUPAB	734,	331	A. Lépine-Szily, J.M. Oliveira, D. Galante, G. Amadio, R. Lichtenthäler, H.G. Bohlen, A.N. Ostrowski, A. Blazevic, C. Borcea, V. Guimarães, V. Lapoux, G. Lima, F. de Oliveira Santos, N.A. Orr, P. Roussel-Chomaz, Th. Stolla, J.S. Winfield
2004Li28	CZYPA	54,	189	C.F. Liang, P. Paris, R.K. Sheline, P. Alexa
2004Li75	PRVCA	70,	064303	S.N. Liddick, P.F. Mantica, R. Broda, B.A. Brown, M.P. Carpenter, A.D. Davies, B. Fornal, T. Glasmacher, D.E. Groh, M. Honma, M. Horoi, R.V.F. Janssens, T. Mizusaki, D.J. Morrissey, A.C. Morton, W.F. Mueller, T. Otsuka, J. Pavan, H. Schatz, A. Stolz, S.L. Tabor, B.E. Tomlin, M. Wiedeking
2004Ma.A	Th.-Giessen			M. Matoš
2004Mo15	NUPAB	734,	188	K. Moody, for the Dubna-Livermore Collaboration

2004Mo26	JUPSA	73,	1738	K. Morita, K. Morimoto, D. Kaji, H. Haba, E. Ideguchi, J.C. Peter, R. Kanungo, K. Katori, H. Koura, H. Kudo, T. Ohnishi, A. Ozawa, T. Suda, K. Sueki, I. Tanihata, H. Xu, A.V. Yeremin, A. Yoneda, A. Yoshida, Y.L. Zhao, T. Zheng, S. Goto, F. Tokanai
2004Mo40	EPJAA	21,	257	K. Morita, K. Morimoto, D. Kaji, H. Haba, E. Ideguchi, R. Kanungo, K. Katori, H. Koura, H. Kudo, T. Ohnishi, A. Ozawa, T. Suda, K. Sueki, I. Tanihata, H. Xu, A.V. Yeremin, A. Yoneda, A. Yoshida, Y.-L. Zhao, T. Zheng
2004MoZU	PrvCom	NDG		K. Morita (to be published in Proc. EXON 2004)
2004Mu26	PRLTA	93,	150801	M. Mukherjee, A. Kellerbauer, D. Beck, K. Blaum, G. Bollen, F. Carrel, P. Delahaye, J. Dilling, S. George, C. Guénaut, F. Herfurth, A. Herlert, H.-J. Kluge, U. Köster, D. Lunney, S. Schwarz, L. Schweikhard, C. Yazidjian
2004Mu30	PRVCA	70,	044311	I. Mukha, L. Batist, E. Roeckl, H. Grawe, J. Doring, A. Blazhev, C.R. Hoffman, Z. Janas, R. Kirchner, M. La Commara, S. Dean, C. Mazzocchi, C. Plettner, S.L. Tabor, M. Wiedeking
2004Mu32	NUPAB	746,	66	I. Mukha, L. Batist, F. Becker, A. Blazhev, W. Brühle, J. Döring, M. Gorska, H. Grawe, T. Faestermann, C. Hoffman, Z. Janas, A. Jungclaus, M. Karny, M. Kavatsyuk, O. Kavatsyuk, R. Kirchner, M. La Commara, C. Mazzocchi, C. Plettner, A. Plochocki, E. Roeckl, M. Romoli, M. Schädel, R. Schwengner, S.L. Tabor, M. Wiedeking, and the GSI ISOL Collaboration
2004Na.A	Th.-Valencia			E. Nacher
2004Og03	PRVCA	69,	021601	Yu. Ts. Oganessian, V.K. Utyonkov, Yu. V. Lobanov, F. Sh. Abdullin, A.N. Polyakov, I.V. Shirokovsky, Yu. S. Tsyganov, G.G. Gulbekian, S.L. Bogomolov, A.N. Mezentsev, S. Iliev, V.G. Subbotin, A.M. Sukhov, A.A. Voinov, G.V. Buklanov, K. Subotic, V.I. Zagrebaev, M.G. Itkis, J.B. Patin, K.J. Moody, J.F. Wild, M.A. Stoyer, N.J. Stoyer, D.A. Shaughnessy, J.M. Kenneally, R.W. Loughheed
2004Og05	NUPAB	734,	109	Yu. Ts. Oganessian, V.K. Utyonkov, Yu. V. Lobanov, F. Sh. Abdullin, A.N. Polyakov, I.V. Shirokovsky, Yu. S. Tsyganov, G.G. Gulbekian, S.L. Bogomolov, B.N. Gikal, A.N. Mezentsev, S. Iliev, V.G. Subbotin, A.M. Sukhov, A.A. Voinov, G.V. Buklanov, K. Subotic, V.I. Zagrebaev, M.G. Itkis, J.B. Patin, K.J. Moody, J.F. Wild, M.A. Stoyer, N.J. Stoyer, D.A. Shaughnessy, J.M. Kenneally, R.W. Loughheed
2004Og07	PRVCA	69,	054607	Yu. Ts. Oganessian, V.K. Utyonkov, Yu. V. Lobanov, F. Sh. Abdullin, A.N. Polyakov, I.V. Shirokovsky, Yu. S. Tsyganov, G.G. Gulbekian, S.L. Bogomolov, B.N. Gikal, A.N. Mezentsev, S. Iliev, V.G. Subbotin, A.M. Sukhov, A.A. Voinov, G.V. Buklanov, K. Subotic, V.I. Zagrebaev, M.G. Itkis, J.B. Patin, K.J. Moody, J.F. Wild, M.A. Stoyer, N.J. Stoyer, D.A. Shaughnessy, J.M. Kenneally, R.W. Loughheed
2004Og12	PRVCA	70,	064609	Yu. Ts. Oganessian, V.K. Utyonkov, Yu. V. Lobanov, F. Sh. Abdullin, A.N. Polyakov, I.V. Shirokovsky, Yu. S. Tsyganov, G.G. Gulbekian, S.L. Bogomolov, B.N. Gikal, A.N. Mezentsev, S. Iliev, V.G. Subbotin, A.M. Sukhov, A.A. Voinov, G.V. Buklanov, K. Subotic, V.I. Zagrebaev, M.G. Itkis, J.B. Patin, K.J. Moody, J.F. Wild, M.A. Stoyer, N.J. Stoyer, D.A. Shaughnessy, J.M. Kenneally, P.A. Wilk, R.W. Loughheed, R.I. Ilkaev, S.P. Vesnovskii, and erratum PRVCA 71(2005)029902
2004Ra23	PRVCA	70,	044318	S. Raman, X. Ouyang, M.A. Islam, J.W. Starner, E.T. Journey, J.E. Lynn, G. Martínez-Pinedo
2004Ra28	PRVCA	70,	064308	P.M. Raddon, D.G. Jenkins, C.D. O'Leary, A.J. Simons, R. Wadsworth, A.N. Andreyev, R.D. Page, M.P. Carpenter, F.G. Kondev, T. Enqvist, P.T. Greenlees, P.M. Jones, R. Julin, S. Juutinen, H. Kettunen, M. Leino, A.-P. Leppänen, P. Nieminen, J. Pakarinen, P. Rahkila, J. Uusitalo, D.T. Joss
2004Ra33	SCIEA	303,	334	S. Rainville, J.K. Thompson, D.E. Pritchard
2004Re04	PRVCA	69,	034331	J.J. Ressler, C.W. Beausang, H. Ai, H. Amro, M.A. Caprio, R.F. Casten, A.A. Hecht, S.D. Langdown, E.A. McCutchan, D.A. Meyer, P.H. Regan, M.J.S. Sciacchitano, A. Yamamoto, N.V. Zamfir
2004Ri12	PRVCA	70,	11301	S. Rinta-Antila, S. Kopecky, V.S. Kolhinen, J. Hakala, J. Huikari, A. Jokinen, A. Nieminen, J. Äystö, J. Szerypo

2004Ro32	PRLTA	93,	161104	D. Rodríguez, V.S. Kolhinen, G. Audi, J. Äystö, D. Beck, K. Blaum, G. Bollen, F. Herfurth, A. Jokinen, A. Kellerbauer, H.-J. Kluge, M. Oinonen, H. Schatz, E. Sauvan, S. Schwarz
2004Sa05	PRVCA	69,	014308	M. Sakama, M. Asai, K. Tsukada, S. Ichikawa, I. Nishinaka, Y. Nagame, H. Haba, S. Goto, M. Shibata, K. Kawade, Y. Kojima, Y. Oura, M. Ebihara, H. Nakahara
2004Sa53	PRVCA	70,	042501	G. Savard, J.A. Clark, F. Buchinger, J.E. Crawford, S. Gulick, J.C. Hardy, A.A. Hecht, V.E. Jacob, J.K.P. Lee, A.F. Levand, B.F. Lundgren, N.D. Scielzo, K.S. Sharma, I. Tanihata, I.S. Towner, W. Trimble, J.C. Wang, Y. Wang, Z. Zhou
2004Sc04	ARISE	60,	317	H. Schrader
2004Sc42	PRVCA	70,	054318	A. Scherillo, J. Genevey, J.A. Pinston, A. Covello, H. Faust, A. Gargano, R. Orlandi, G.S. Simpson, I. Tsekhanovich, N. Warr
2004Sh15	EPJAA	20,	207	T. Shizuma, Z.G. Gan, K. Ogawa, H. Nakada, M. Oshima, Y. Toh, T. Hayakawa, Y. Hatsukawa, M. Sugawara, Y. Utsuno, Z. Liu
2004St05	PYLBB	586,	27	J. Stadlmann, M. Hausmann, F. Attallah, K. Beckert, P. Beller, F. Bosch, H. Eickhoff, M. Falch, B. Franczak, B. Franzke, H. Geissel, Th. Kerscher, O. Klepper, H.-J. Kluge, C. Kozhuharov, Yu. A. Litvinov, K.E.G. Löbner, M. Matoš, G. Münzenberg, N. Nankov, F. Nolden, Yu. N. Novikov, T. Ohtsubo, T. Radon, H. Schatz, C. Scheidenberger, M. Steck, H. Weick, H. Wollnik
2004St18	NUPAB	738,	43	S.V. Stepantsov, M.S. Golovkov, A.S. Fomichev, A.M. Rodin, S.I. Sidorchuk, R.S. Slepnev, G.M. Ter-Akopian, M.L. Chelnokov, V.A. Gorshkov, Yu. Ts. Oganessian, R. Wolski, A.A. Korshennikov, E. Yu. Nikolskii, I. Tanihata
2004Th09	EPJAA	21,	419	J.C. Thomas, L. Achouri, J. Äystö, R. Beraud, B. Blank, G. Canchel, S. Czajkowski, P. Dendooven, A. Ensalle, J. Giovinazzo, N. Guillet, J. Honkanen, A. Jokinen, A. Laird, M. Lewitowicz, C. Longour, F. de Oliveira Santos, K. Peräjärvi, M. Stanoiu
2004Th17	NATUA	430,	58	J.K. Thompson, S. Rainville, D.E. Pritchard
2004Ti06	NUPAB	745,	155	D.R. Tilley, J.H. Kelley, J.L. Godwin, D.J. Millener, J.E. Purcell, C.G. Sheu, H.R. Weller
2004To03	PRVCA	69,	014312	I. Tomandl, J. Novák, V. Burjan, S. Raman, T. von Egidy, H.-F. Wirth, U. Köster, W. Schauer, J.W. Starner, E.T. Jurney, G. Graw, R. Hertzenberger, A. Gollwitzer, B. Valnion, A. Metz
2004Ur04	EPJAA	22,	157	W. Urban, A. Zlomaniec, G. Simpson, J.A. Pinston, J. Kurpeta, T. Rzaca-Urban, J.L. Durell, A.G. Smith, B.J. Varley, N. Schulz, I. Ahmad
2004Va03	PRVCA	69,	024316	J.J. Valiente-Dobón, P.H. Regan, C. Wheldon, C.Y. Wu, N. Yoshinaga, K. Higashiyama, J.F. Smith, D. Cline, R.S. Chakravarthy, R. Chapman, M. Cromaz, P. Fallon, S.J. Freeman, A. Görgen, W. Gelletly, A. Hayes, H. Hua, S.D. Langdown, I.Y. Lee, X. Liang, A.O. Macchiavelli, C.J. Pearson, Zs. Podolyák, G. Sletten, R. Teng, D. Ward, D.D. Warner, A.D. Yamamoto
2004Va07	PRLTA	92,	112501	J. Van Roosbroeck, C. Guénaut, G. Audi, D. Beck, K. Blaum, G. Bollen, J. Cederkall, P. Delahaye, A. De Maesschalck, H. De Witte, D. Fedorov, V.N. Fedoseyev, S. Franchoo, H.O.U. Fynbo, M. Górska, F. Herfurth, K. Heyde, M. Huyse, A. Kellerbauer, H.-J. Kluge, U. Köster, K. Kruglov, D. Lunney, V.I. Mishin, W.F. Mueller, Sz. Nagy, S. Schwarz, L. Schweikhard, N.A. Smirnova, K. Van de Vel, P. Van Duppen, A. Van Dyck, W.B. Walters, L. Weissman, C. Yazidjian
2004Va14	PRLTA	92,	220802	R.S. Van Dyck, Jr., S.L. Zafonte, S. Van Liew, D.B. Pinegar, P.B. Schwinber
2004Wa26	PRVCA	70,	034314	W.B. Walters, B.E. Tomlin, P.F. Mantica, B.A. Brown, J. Rikowska Stone, A.D. Davies, A. Estrade, P.T. Hosmer, N. Hoteling, S.N. Liddick, T.J. Mertzimekis, F. Montes, A.C. Morton, W.F. Mueller, M. Ouellette, E. Pellegrini, P. Santi, D. Seweryniak, H. Schatz, J. Shergur, A. Stolz
2004Wo07	PRVCA	69,	051302	P.J. Woods, P. Munro, D. Seweryniak, C.N. Davids, T. Davinson, A. Heinz, H. Mahmud, F. Sarazin, J. Shergur, W.B. Walters, A. Woehr
2004Wo16	NUPAB	742,	349	A. Wöhr, A. Aprahamian, P. Boutachkov, J.L. Galache, J. Gorres, M. Shawcross, A. Teymurazyan, M.C. Wiescher, D.S. Brenner, C.N. Davids, S.M. Fischer, A.M. Heinz, R.V.F. Janssens, D. Seweryniak
2004Xu08	JUPSA	73,	2588	Y. Xu, W. Yang, S. Yuan, Y. Niu, H. Ding, X. Wang, L. Zhao, P. Wang, H. Li

2004Ze05	EPJAA	20,	389	T. Zerguerras, B. Blank, Y. Blumenfeld, T. Suomijärvi, D. Beaumel, B.A. Brown, M. Chartier, M. Fallot, J. Gio vinazzo, C. Jouanne, V. Lapoux, I. Lhenry-Yvon, W. Mittig, P. Roussel-Chomaz, H. Savajols, J.A. Scarpaci, A. Shrivastava, M. Thoennessen
			2005	
2005Ah03	PRVCA	71,	054305	I. Ahmad, F.G. Kondev, E.F. Moore, M.P. Carpenter, R.R. Chasman, J.P. Greene, R.V.F. Janssens, T. Lauritsen, C.J. Lister, D. Seweryniak, R.W. Hoff, J.E. Evans, R.W. Loughheed, C.E. Porter, L.K. Felker
2005As05	PRLTA	95,	102502	M. Asai, K. Tsukada, M. Sakama, S. Ichikawa, T. Ishii, Y. Nagame, I. Nishinaka, K. Akiyama, A. Osa, Y. Oura, K. Sueki, M. Shibata
2005Ba51	PRVCA	71,	054302	A.M. Baxter, A.P. Byrne, G.D. Dracoulis, P.M. Davidson, T. Kibédi, R.V.F. Janssens, M.P. Carpenter, C.N. Davids, T.L. Khoo, T. Lauritsen
2005Ba64	PRVCA	72,	017301	A.E. Barzakh, D.V. Fedorov, A.M. Ionan, V.S. Ivanov, F.V. Moroz, K.A. Mezilev, S. Yu. Orlov, V.N. Panteleev, Yu. M. Volkov
2005Bb02	EPJAA	25,	s149	J.C. Batchelder, M. Tantawy, C.R. Bingham, M. Danchev, D.J. Fong, T.N. Ginter, C.J. Gross, R. Grzywacz, K. Hagino, J.H. Hamilton, M. Karny, W. Krolas, C. Mazzocchi, A. Piechaczek, A.V. Ramayya, K.P. Rykaczewski, A. Stolz, J.A. Winger, C.-H. Yu, E.F. Zganjar
2005Bh06	NUPAB	750,	199	T. Bhattacharjee, S. Chanda, S. Bhattacharyya, S.K. Basu, R.K. Bhowmik, S. Muralithar, R.P. Singh, N.S. Pattabiraman, S.S. Ghugre, U. Datta Pramanik, S. Bhattacharya
2005B115	PRLTA	94,	232501	B. Blank, A. Bey, G. Canchel, C. Dossat, A. Fleury, J. Giovinazzo, I. Matea, N. Adimi, F. de Oliveira, I. Stefan, G. Georgiev, S. Grévy, J.C. Thomas, C. Borcea, D. Cortina, M. Caamano, M. Stanoiu, F. Aksouh, B.A. Brown, F.C. Barker, W.A. Richter
2005Ca02	EPJAA	23,	201	M. Caamano, P.M. Walker, P.H. Regan, M. Pfitzner, Zs. Podolyák, J. Gerl, M. Hellstrom, P. Mayet, M.N. Mineva, A. Aprahamian, J. Benlliure, A.M. Bruce, P.A. Butler, D. Cortina Gil, D.M. Cullen, J. Doring, T. Enqvist, C. Fox, J. Garces Narro, H. Geissel, W. Gelletly, J. Giovinazzo, M. Gorska, H. Grawe, R. Grzywacz, A. Kleinbohl, W. Korten, M. Lewitowicz, R. Lucas, H. Mach, C.D. O'Leary, F. de Oliveira, C.J. Pearson, F. Rejmund, M. Rejmund, M. Sawicka, H. Schaffner, C. Schlegel, K. Schmidt, K.-H. Schmidt, P.D. Stevenson, Ch. Theisen, F. Vives, D.D. Warner, C. Wheldon, H.J. Wollersheim, S. Wooding, F. Xu, O. Yordanov
2005Ca03	NUPAB	748,	333	C.M. Cattadori, M. De Deo, M. Laubenstein, L. Pandola, V.I. Tretyak
2005Ca43	JPGPE	31,	s1599	M.P. Carpenter, F.G. Kondev, R.V.F. Janssens
2005Ca.A	AnRpt ANL,		51	M.P. Carpenter et al
2005Ch65	PRVCA	72,	054309	A. Chakraborty, Krishichayan, S.S. Ghugre, R. Goswami, S. Mukhopadhyay, N.S. Pattabiraman, S. Ray, A.K. Sinha, S. Sarkar, P.V. Madhusudhana Rao, U. Garg, S.K. Basu, M.B. Chatterjee, M.S. Sarkar, L. Chaturvedi, A. Dhal, R.K. Sinha, I.M. Govil, R.K. Bhowmik, A. Jhingan, N. Madhavan, S. Muralithar, S. Nath, R.P. Singh, P. Sugathan
2005De01	EPJAA	23,	243	H. De Witte, A.N. Andreyev, S. Dean, S. Franchoo, M. Huyse, O. Ivanov, U. Köster, W. Kurcewicz, J. Kurpeta, A. Płochocki, K. Van de Vel, J. Van de Walle, P. Van Duppen
2005Do20	PRVCA	72,	054315	C. Dossat, A. Bey, B. Blank, G. Canchel, A. Fleury, J. Giovinazzo, I. Matea, F. de Oliveira Santos, G. Georgiev, S. Grévy, I. Stefan, J.C. Thomas, N. Adimi, C. Borcea, D. Cortina Gil, M. Caamano, M. Stanoiu, F. Aksouh, B.A. Brown, L.V. Grigorenko
2005Dr05	PRVCA	71,	044326	G.D. Dracoulis, G.J. Lane, F.G. Kondev, A.P. Byrne, T. Kibédi, H. Watanabe, I. Ahmad, M.P. Carpenter, S.J. Freeman, R.V.F. Janssens, N.J. Hammond, T. Lauritsen, C.J. Lister, G. Mukherjee, D. Seweryniak, P. Chowdhury, S.K. Tandel
2005El10	PRVCA	72,	054306	H.M. El-Masri, P.M. Walker, G.D. Dracoulis, T. Kibédi, A.P. Byrne, A.M. Bruce, J.N. Orce, A. Emmanouilidis, D.M. Cullen, C. Wheldon, F.R. Xu
2005Fr.A	IPNO-DRE-NS		5	S. Franchoo, N. Barre, B. Roussiere, J. Sauvage

2005Ga01	EPJAA	23,	41	L. Gaudefroy, O. Sorlin, C. Donzaud, J.C. Angeli, F. Azaiez, C. Bourgeois, V. Chisté, Z. Dlouhy, S. Grevy, D. Guillemaud-Mueller, F. Ibrahim, K.-L. Kratz, M. Lewitowicz, S.M. Lukyanov, I. Matea, J. Mrazek, F. Nowacki, F. de Oliveira Santos, Yu.-E. Penionzhkevich, B. Pfeiffer, F. Pougheon, M.G. Saint-Laurent, M. Stanoiu
2005Ga.B	Th.-Orsay Sept			L. Gaudefroy
2005Gi15	JPGPE	31,	s1509	J. Giovinazzo
2005Gr32	EPJAA	25,	s145	R. Grzywacz, M. Karny, K.P. Rykaczewski, J.C. Batchelder, C.R. Bingham, D. Fong, C.J. Gross, W. Krolas, C. Mazzocchi, A. Piechaczek, M.N. Tantawy, J.A. Winger, E.F. Zganjar
2005Gu25	PRVCA	72,	034312	F.Q. Guo, J. Powell, D.W. Lee, D. Leitner, M.A. McMahan, D.M. Moltz, J.P. O'Neil, K. Perajarvi, L. Phair, C.A. Ramsey, X.J. Xu, J. Cerny
2005Gu27	JPGPE	31,	s1765	C. Guénaut, G. Audi, D. Beck, K. Blaum, G. Bollen, P. Delahaye, F. Herfurth, A. Kellerbauer, H.-J. Kluge, D. Lunney, S. Schwarz, L. Schweikhard, C. Yazidjian
2005Gu37	EPJAA	25,	s35	C. Guénaut, G. Audi, D. Beck, K. Blaum, G. Bollen, P. Delahaye, F. Herfurth, A. Kellerbauer, H.-J. Kluge, D. Lunney, S. Schwarz, L. Schweikhard, C. Yazidjian
2005Ha45	PRVCA	72,	024303	S. Harissopulos, J. Döring, M. La Commara, K. Schmidt, C. Mazzocchi, R. Borcea, S. Galanopoulos, M. Górska, H. Grawe, M. Hellström, Z. Janas, R. Kirchner, E. Roeckl, I.P. Johnstone, R. Schwengner, L.D. Skouras
2005He26	EPJAA	25,	s17	F. Herfurth, G. Audi, D. Beck, K. Blaum, G. Bollen, P. Delahaye, S. George, C. Guénaut, A. Herlert, A. Kellerbauer, H.-J. Kluge, D. Lunney, M. Mukherjee, S. Rahaman, S. Schwarz, L. Schweikhard, C. Weber, C. Yazidjian
2005He27	EPJAA	26,	233	F.P. Heßberger, S. Antalic, B. Streicher, S. Hofmann, D. Ackermann, B. Kindler, I. Kojouharov, P. Kuusiniemi, M. Leino, B. Lommel, R. Mann, K. Nishio, S. Saro, B. Sulignano
2005He.A	PrvCom	GAu	Aug	A. Herlert
2005Ho15	NUPAB	756,	249	J. Honzátko, V. Bondarenko, I. Tomandl, T. von Egidy, H.-F. Wirth, D. Bucurescu, V. Yu. Ponomarev, N. Mărginean, R. Hertzenberger, Y. Eisermann, G. Graw, L. Rubáček
2005Hu.A	PrvCom	GAu	Jul	M. Huyse
2005Ic02	PRVCA	71,	067302	S. Ichikawa, M. Asai, K. Tsukada, H. Haba, Y. Nagame, M. Shibata, M. Sakama, Y. Kojima
2005Ja03	EPJAA	23,	197	Z. Janas, C. Mazzocchi, L. Batist, A. Blazhev, M. Górska, M. Kavatsyuk, O. Kavatsyuk, R. Kirchner, A. Korgul, M. La Commara, K. Miernik, I. Mukha, A. Plochocki, E. Roeckl, K. Schmid
2005Ja06	EPJAA	23,	401	Z. Janas, L. Batist, J. Döring, M. Gierlik, R. Kirchner, J. Kurcewicz, H. Mahmud, C. Mazzocchi, A. Plochocki, E. Roeckl, K. Schmidt, P.J. Woods, J. Żylicz
2005Ja10	EPJAA	24,	205	Z. Janas, L. Batist, R. Borcea, J. Döring, M. Gierlik, M. Karny, R. Kirchner, M. La Commara, S. Mandal, C. Mazzocchi, F. Moroz, S. Orlov, A. Plochocki, E. Roeckl, J. Żylicz
2005Ka34	EPJAA	25,	211	O. Kavatsyuk, M. Kavatsyuk, L. Batist, A. Banu, F. Becker, A. Blazhev, W. Bröchle, J. Döring, T. Faestermann, M. Górska, H. Grawe, Z. Janas, A. Jungclaus, M. Karny, R. Kirchner, M. La Commara, S. Mandal, C. Mazzocchi, I. Mukha, S. Muralithar, C. Plettner, A. Plochocki, E. Roeckl, M. Romoli, M. Schädel, R. Schwengner, J. Żylicz
2005Ka39	EPJAA	25,	355	A. Kankainen, G.K. Vorobjev, S.A. Eliseev, W. Huang, J. Huikari, A. Jokinen, A. Nieminen, Yu. N. Novikov, H. Penttilä, A.V. Popov, S. Rinta-Antila, H. Schatz, D.M. Seliverstov, Yu. P. Suslov, J. Äystö
2005Kr20	EPJAA	25,	s633	K.-L. Kratz, B. Pfeiffer, O. Arndt, S. Hennrich, A. Wöhr, ISOLDE
2005Ku06	EPJAA	23,	417	P. Kuusiniemi, F.P. Heßberger, D. Ackermann, S. Hofmann, I. Kojouharov
2005Ku31	EPJAA	25,	397	P. Kuusiniemi, F.P. Heßberger, D. Ackermann, S. Hofmann, B. Sulignano, I. Kojouharov, R. Mann
2005Ku.A	P-Debrecen		73	T. Kurtukian Nieto, J. Benlliure, K.-H. Schmidt, E. Casarejos, D. Cortina-Gil, M. Fernandez-Ordóñez, J. Pereira, L. Audouin, B. Blank, F. Becker, J. Giovinazzo, D. Henzlova, B. Jurado, F. Rejmund, O. Yordanov

2005La01	PYLBB	606,	34	G.J. Lane, K.H. Maier, A.P. Byrne, G.D. Dracoulis, R. Broda, B. Fornal, M.P. Carpenter, R.M. Clark, M. Cromaz, R.V.F. Janssens, A.O. Macchiavelli, I. Wiedenhover, K. Vetter
2005Le34	PRVCA	72,	034305	F. Le Blanc, L. Cabaret, E. Cottureau, J.E. Crawford, S. Essabaa, J. Genevey, R. Horn, G. Huber, J. Lassen, J.K.P. Lee, G. Le Scornet, J. Lettry, J. Obert, J. Oms, A. Ouchrif, J. Pinard, H. Ravn, B. Roussière, J. Sauvage, D. Verney
2005Le42	EPJAA	25,	s183	A.-P. Leppänen, J. Uusitalo, S. Eeckhaudt, T. Enqvist, K. Eskola, T. Grahn, F.P. Heßberger, P.T. Greenlees, P. Jones, R. Julin, S. Juutinen, H. Kettunen, P. Kuusiniemi, M. Leino, P. Nieminen, J. Pakarinen, J. Perkowski, P. Rakhila, C. Scholey, G. Sletten
2005Li17	NIMAE	543,	591	Z. Liu, J. Kurcewicz, P.J. Woods, C. Mazzocchi, F. Attallah, E. Badura, C.N. Davids, T. Davinson, J. Döring, H. Geissel, M. Górska, R. Grzywacz, M. Hellström, Z. Janas, M. Karny, A. Korgul, I. Mukha, M. Pfützner, C. Plettner, A. Robinson, E. Roeckl, K. Rykaczewski, K. Schmidt, D. Seweryniak, H. Weick
2005Li24	NUPAB	756,	3	Yu. A. Litvinov, H. Geissel, T. Radon, F. Attallah, G. Audi, K. Beckert, F. Bosch, M. Falch, B. Franzke, M. Hausmann, M. Hellström, Th. Kerscher, O. Klepper, H.-J. Kluge, C. Kozhuharov, K.E.G. Löbner, G. Münzenberg, F. Nolden, Yu. N. Novikov, W. Quint, Z. Patyk, H. Reich, C. Scheidenberger, B. Schlitt, M. Steck, K. Sümmerner, L. Vermeeren, M. Winkler, Th. Winkler, H. Wollnik
2005Li47	PRVCA	72,	047301	Z. Liu, P.J. Woods, K. Schmidt, H. Mahmud, P.S.L. Munro, A. Blazhev, J. Döring, H. Grawe, M. Hellstrom, R. Kirchner, Z.K. Li, C. Mazzocchi, I. Mukha, C. Plettner, E. Roeckl, M. La Commara
2005Li53	PRVCA	72,	054321	S.N. Liddick, P.F. Mantica, R. Broda, B.A. Brown, M.P. Carpenter, A.D. Davies, B. Fornal, M. Horoi, R.V.F. Janssens, A.C. Morton, W.F. Mueller, J. Pavan, H. Schatz, A. Stolz, S.L. Tabor, B.E. Tomlin, M. Wiedeking
2005Li60	PRVCA	72,	064327	Z.H. Li, Y.L. Ye, H. Hua, D.X. Jiang, Y.M. Zhang, F.R. Xu, Q.Y. Hu, G.L. Zhang, Z.Q. Chen, T. Zheng, C.E. Wu, J.L. Lou, X.Q. Li, D.Y. Pang, S. Wang, C. Li, H.S. Xu, Z.Y. Sun, L.M. Duan, Z.G. Hu, R.J. Hu, H.G. Xu, R.S. Mao, Y. Wang, X.H. Yuan, H. Gao, L.J. Wu, H.R. Qi, T.H. Huang, F. Fu, F. Jia, Q. Gao, X.L. Ding, J.L. Han, X.Y. Zhang
2005Ma59	PYLBB	622,	45	C. Mazzocchi, R. Grzywacz, J.C. Batchelder, C.R. Bingham, D. Fong, J.H. Hamilton, J.K. Hwang, M. Karny, W. Krolas, S.N. Liddick, A.F. Lisetskiy, A.C. Morton, P.F. Mantica, W.F. Mueller, K.P. Rykaczewski, M. Steiner, A. Stolz, J.A. Winger
2005Ma95	EPJAA	25,	s93	C. Mazzocchi, R. Grzywacz, J.C. Batchelder, C.R. Bingham, D. Fong, J.H. Hamilton, J.K. Hwang, M. Karny, W. Krolas, S.N. Liddick, A.C. Morton, P.F. Mantica, W.F. Mueller, K.P. Rykaczewski, M. Steiner, A. Stolz, J.A. Winger
2005Ma.A	PrvCom	GAu	Oct	M. Martin
2005Mu15	PRLTA	95,	022501	I. Mukha, E. Roeckl, J. Döring, L. Batist, A. Blazhev, H. Grawe, C.R. Hoffman, M. Huyse, Z. Janas, R. Kirchner, M. La Commara, C. Mazzocchi, C. Plettner, S.L. Tabor, P. Van Duppen, M. Wiedeking
2005Og02	PRVCA	72,	034611	Yu. Ts. Oganessian, V.K. Utyonkov, S.N. Dmitriev, Yu. V. Lobanov, M.G. Itkis, A.N. Polyakov, Yu. S. Tsyganov, A.N. Mezentsev, A.V. Yeremin, A.A. Voinov, E.A. Sokol, G.G. Gulbekian, S.L. Bogomolov, S. Iliev, V.G. Subbotin, A.M. Sukhov, G.V. Buklanov, S.V. Shishkin, V.I. Chepygin, G.K. Vostokin, N.V. Aksenov, M. Hussonnois, K. Subotic, V.I. Zagrebaev, K.J. Moody, J.B. Patin, J.F. Wild, M.A. Stoyer, N.J. Stoyer, D.A. Shaughnessy, J.M. Kenneally, P.A. Wilk, R.W. Lougheed, H.W. Gäggeler, D. Schumann, H. Bruchertseifer, R. Eichler
2005Oh08	PRLTA	95,	052501	T. Ohtsubo, F. Bosch, H. Geissel, L. Maier, C. Scheidenberger, F. Attallah, K. Beckert, P. Beller, D. Boutin, T. Faestermann, B. Franczak, B. Franzke, M. Hausmann, M. Hellstrom, E. Kaza, P. Kienle, O. Klepper, H.-J. Kluge, C. Kozhuharov, Yu. A. Litvinov, M. Matos, G. Munzenberg, F. Nolden, Yu. N. Novikov, M. Portillo, T. Radon, J. Stadlmann, M. Steck, T. Stohlker, K. Summerer, K. Takahashi, H. Weick, M. Winkler, T. Yamaguchi
2005Pa31	PRVCA	71,	055804	A. Parikh, J.A. Caggiano, C. Deibel, J.P. Greene, R. Lewis, P.D. Parker, C. Wrede
2005Pi13	PRVCA	71,	064327	J.A. Pinston, J. Genevey, R. Orlandi, A. Scherillo, G.S. Simpson, I. Tsekhanovich, W. Urban, H. Faust, N. Warr

2005Po03	EPJAA	24,	39	M.-G. Porquet, Ts. Venkova, R. Lucas, A. Astier, A. Bauchet, I. Deloncle, A. Prevost, F. Azaiez, G. Barreau, A. Bogachev, N. Buforn, A. Buta, D. Curien, T.P. Doan, L. Donadille, O. Dorvaux, G. Duchene, J. Durell, Th. Ethvignot, B.P.J. Gall, D. Grimwood, M. Houry, F. Khalfallah, W. Kortten, S. Lalkovski, Y. Le Coz, M. Meyer, A. Minkova, I. Piqueras, N. Redon, A. Roach, M. Rousseau, N. Schulz, A.G. Smith, O. Stezowski, Ch. Theisen, B.J. Varley
2005Ra34	NATUA	438,	1096	S. Rainville, J.K. Thompson, E.G. Myers, J.M. Brown, M.S. Dewey, E.G. Kessler, Jr., R.D. Deslattes, H.G. Börner, M. Jentschel, P. Mutti, D.E. Pritchard
2005Re02	PRVCA	71,	014302	J.J. Ressler, C.W. Beausang, H. Ai, H. Amro, M. Babilon, J.A. Caggiano, R.F. Casten, G. Gurdal, A. Heinz, R.O. Hughes, E.A. McCutchan, D.A. Meyer, C. Plettner, J. Qian, M.J.S. Sciacchitano, N.J. Thomas, E. Williams, N.V. Zamfir
2005Ri17	JPHGB	31,	s1949	S. Rigby, D.M. Cullen, D.T. Scholes, C. Scholey, P. Rahkila, S. Eeckhauht, T. Grahn, P. Greenlees, P.M. Jones, R. Julin, S. Juutinen, H. Kettunen, M. Leino, A. Leppänen, P. Nieminen, M. Nyman, J. Pakarinen, J. Uusitalo
2005Ro19	PRLTA	95,	032502	A.P. Robinson, P.J. Woods, D. Seweryniak, C.N. Davids, M.P. Carpenter, A.A. Hecht, D. Peterson, S. Sinha, W.B. Walters, S. Zhu
2005Ro40	EPJAA	25,	s155	A.P. Robinson, C.N. Davids, D. Seweryniak, P.J. Woods, B. Blank, M.P. Carpenter, T. Davinson, S.J. Freeman, N. Hammond, N. Hoteling, R.V.F. Janssens, T.L. Khoo, Z. Liu, G. Mukherjee, C. Scholey, J. Shergur, S. Sinha, A.A. Sonzogni, W.B. Walters, A. Woehr
2005Sa44	PRLTA	95,	102501	G. Savard, F. Buchinger, J.A. Clark, J.E. Crawford, S. Gulick, J.C. Hardy, A.A. Hecht, J.K.P. Lee, A.F. Levand, N.D. Scielzo, H. Sharma, K.S. Sharma, I. Tanihata, A.C.C. Villari, Y. Wang
2005Sc22	JPGPE	31,	s1719	C. Scholey, M. Sandzelius, S. Eeckhauht, T. Grahn, P.T. Greenlees, P. Jones, R. Julin, S. Juutinen, M. Leino, A.-P. Leppanen, P. Nieminen, M. Nyman, J. Perkowski, J. Pakarinen, P. Rahkila, P.M. Rahkila, J. Uusitalo, K. Van de Vel, B. Cederwall, B. Hadinia, K. Lagergren, D.T. Joss, D.E. Appelbe, C.J. Barton, J. Simpson, D.D. Warner, I.G. Darby, R.D. Page, E.S. Paul, D. Wiseman
2005Sh24	PRVCA	71,	064323	J. Shergur, D.J. Dean, D. Seweryniak, W.B. Walters, A. Wöhr, P. Boutachkov, C.N. Davids, I. Dillmann, A. Juodagalvis, G. Mukherjee, S. Sinha, A. Teymurazyan, I. Zartova
2005Sh38	PRVAA	72,	022510	W. Shi, M. Redshaw, E.G. Myers, and PrvCom GAU February 2006
2005Sh52	EPJAA	25,	s45	K.S. Sharma, J. Vaz, R.C. Barber, F. Buchinger, J.A. Clark, J.E. Crawford, H. Fukutani, J.P. Greene, S. Gulick, A. Heinz, J.K.P. Lee, G. Savard, Z. Zhou, J.C. Wang
2005Si34	NUPAB	763,	45	G. Sikler, G. Audi, D. Beck, K. Blaum, G. Bollen, F. Herfurth, A. Kellerbauer, H.-J. Kluge, D. Lunney, M. Oinonen, C. Scheidenberger, S. Schwarz, J. Szerypo, C. Weber, and erratum NUPAB 768(2006)160
2005Th03	PRVCA	71,	021302	J.S. Thomas, D.W. Bardayan, J.C. Blackmon, J.A. Cizewski, U. Greife, C.J. Gross, M.S. Johnson, K.L. Jones, R.L. Kozub, J.F. Liang, R.J. Livesay, Z. Ma, B.H. Moazen, C.D. Nesaraja, D. Shapira, M.S. Smith
2005Th.A	P-Cadarache		131	J.-C. Thomas, et al
2005Tr13	EPJAA	25,	s101	V. Tripathi, S.L. Tabor, P.F. Mantica, C.R. Hoffman, M. Wiedeking, A.D. Davies, S.N. Liddick, W.F. Mueller, A. Stolz, B.E. Tomlin, A. Volya
2005Uu02	PRVCA	71,	024306	J. Uusitalo, M. Leino, T. Enqvist, K. Eskola, T. Grahn, P.T. Greenlees, P. Jones, R. Julin, S. Juutinen, A. Keenan, H. Kettunen, H. Koivisto, P. Kuusiniemi, A.-P. Leppänen, P. Nieminen, J. Pakarinen, P. Rahkila, C. Scholey
2005Va04	EPJAA	24,	57	K. Van de Vel, A.N. Andreyev, D. Ackermann, H.J. Boardman, P. Cagarda, J. Gerl, F.P. Heßberger, S. Hofmann, M. Huyse, D. Karlgren, I. Kojouharov, M. Leino, B. Lommel, G. Münzenberg, C. Moore, R.D. Page, S. Saro, P. Van Duppen, R. Wyss
2005Va19	PRVCA	71,	054307	J. Van Roosbroeck, H. De Witte, M. Gorska, M. Huyse, K. Kruglov, D. Pauwels, J.-Ch. Thomas, K. Van de Vel, P. Van Duppen, S. Franchoo, J. Cederkall, V.N. Fedoseyev, H. Fynbo, U. Georg, O. Jonsson, U. Koster, L. Weissman, W.F. Mueller, V.I. Mishin, D. Fedorov, A. De Maesschalck, N.A. Smirnova, K. Heyde

2005We11	PYLAA	347,	81	C. Weber, G. Audi, D. Beck, K. Blaum, G. Bollen, F. Herfurth, A. Kellerbauer, H.-J. Kluge, D. Lunney, S. Schwarz
2005Xu04	PRVCA	71,	054318	S.W. Xu, Z.K. Li, Y.X. Xie, Q.Y. Pan, W.X. Huang, X.D. Wang, Y. Yu, Y.B. Xing, N.C. Shu, Y.S. Chen, F.R. Xu, K. Wang
				2006
2006Ac04	EPJAA	27,	287	N.L. Achouri, F. de Oliveira Santos, M. Lewitowicz, B. Blank, J. Ajstó, G. Canchel, S. Czajkowski, P. Dendooven, A. Emsallem, J. Giovinazzo, N. Guillet, A. Jokinen, A.M. Laird, C. Longour, K. Peräjärvi, N. Smirnova, M. Stanoiu, J.-C. Thomas
2006An04	PRVCA	73,	024317	A.N. Andreyev, S. Antalic, D. Ackermann, S. Franchoo, F.P. Heßberger, S. Hofmann, M. Huyse, I. Kojouharov, B. Kindler, P. Kuusiniemi, S.R. Leshner, B. Lommel, R. Mann, G. Münzenberg, K. Nishio, R.D. Page, J.J. Ressler, B. Streicher, S. Saro, B. Sulignano, P. Van Duppen, D.R. Wiseman
2006An11	PRVCA	73,	044324	A.N. Andreyev, S. Antalic, D. Ackermann, S. Franchoo, F.P. Heßberger, S. Hofmann, M. Huyse, I. Kojouharov, B. Kindler, P. Kuusiniemi, S.R. Leshner, B. Lommel, R. Mann, G. Münzenberg, K. Nishio, R.D. Page, J.J. Ressler, B. Streicher, S. Saro, B. Sulignano, P. Van Duppen, D. Wiseman, R. Wyss
2006An36	PRVCA	74,	064303	A.N. Andreyev, S. Antalic, M. Huyse, P. Van Duppen, D. Ackermann, L. Bianco, D.M. Cullen, I.G. Darby, S. Franchoo, S. Heinz, F.P. Heßberger, S. Hofmann, I. Kojouharov, B. Kindler, A.-P. Leppänen, B. Lommel, R. Mann, G. Münzenberg, J. Pakarinen, R.D. Page, J.J. Ressler, S. Saro, B. Streicher, B. Sulignano, J. Thomson, R. Wyss
2006As03	PRVCA	73,	067301	M. Asai, K. Tsukada, S. Ichikawa, M. Sakama, H. Haba, I. Nishinaka, Y. Nagame, S. Goto, Y. Kojima, Y. Oura, M. Shibata
2006Ba09	PRVCA	73,	024308	J.E. Bastin, R.-D. Herzberg, P.A. Butler, G.D. Jones, R.D. Page, D.G. Jenkins, N. Amzal, P.M.T. Brew, N.J. Hammond, R.D. Humphreys, P.J.C. Ikin, T. Page, P.T. Greenlees, P.M. Jones, R. Julin, S. Juutinen, H. Kankaanpää, A. Keenan, H. Kettunen, P. Kuusiniemi, M. Leino, A.P. Leppänen, M. Muikku, P. Nieminen, P. Rahkila, C. Scholey, J. Uusitalo, E. Bouchez, A. Chatillon, A. Hürstel, W. Kortten, Y. Le Coz, Ch. Theisen, D. Ackermann, J. Gerl, K. Helariutta, F.P. Hessberger, Ch. Schlegel, H.J. Wollersheim, M. Lach, A. Maj, W. Meczynski, J. Styczen, T.L. Khoo, C.J. Lister, A.V. Afanasjev, H.J. Maier, P. Reiter, P. Bednarczyk, K. Eskola, K. Hauschild
2006Ba55	EPJAA	29,	175	L. Batist, A. Blazhev, J. Doring, H. Grawe, M. Kavatsyuk, O. Kavatsyuk, R. Kirchner, M. La Commara, C. Mazzocchi, I. Mukha, C. Plettner, E. Roeckl, M. Romoli
2006Be33	PRVCA	74,	024603	T. Belgya
2006Bo11	PRLTA	96,	152501	G. Bollen, D. Davies, M. Facina, J. Huikari, E. Kwan, P.A. Lofy, D.J. Morrissey, A. Prinke, R. Ringle, J. Savory, P. Schury, S. Schwarz, C. Sumithrarachchi, T. Sun, L. Weissman
2006Bo33	PHSTT	125,	180	M.J.T. Borge, R. Boutami, L.M. Fraile, K. Gulda, W. Kurcewicz, H. Mach, T. Martinez, B. Rubio, O. Tengblad
2006Bu12	PRVCA	74,	025501	J.T. Burke, P.A. Vetter, S.J. Freedman, B.K. Fujikawa, W.T. Winter
2006Ca05	PRVCA	73,	014319	E. Casarejos, C. Angulo, P.J. Woods, F.C. Barker, P. Descouvemont, M. Aliotta, T. Davinson, P. Demaret, M. Gaelens, P. Leleux, Z. Liu, M. Loiselet, A.S. Murphy, A. Ninane, I.A. Roberts, G. Ryckewaert, J.S. Schweitzer, F. Vanderbist
2006Ch10	PRVCA	73,	024306	R.S. Chakrawarthy, P.M. Walker, J.J. Ressler, E.F. Zganjar, G.C. Ball, M.B. Smith, A.N. Andreyev, S.F. Ashley, R.A.E. Austin, D. Bandyopadhyay, J.A. Becker, J.J. Carroll, D.S. Cross, D. Gohlke, J.J. Daoud, P.E. Garrett, G.F. Grinyer, G. Hackman, G.A. Jones, R. Kanungo, W.D. Kulp, Y. Litvinov, A.C. Morton, W.J. Mills, C.J. Pearson, R. Propri, C.E. Svensson, R. Wheeler, S.J. Williams

- 2006Ch52 EPJAA 30, 397 A. Chatillon, Ch. Theisen, P.T. Greenlees, G. Auger, J.E. Bastin, E. Bouchez, B. Bouriquet, J.M. Casandjian, R. Cee, E. Clément, R. Dayras, G. de France, R. de Turreil, S. Eeckhaut, A. Görgen, T. Grahn, S. Grévy, K. Hauschild, R.-D. Herzberg, P.J.C. Ikin, G.D. Jones, P. Jones, R. Julin, S. Juutinen, H. Kettunen, A. Korichi, W. Korten, Y. Le Coz, M. Leino, A. Lopez-Martens, S.M. Lukyanov, Yu. E. Penionzhkevich, J. Perkowski, A. Pritchard, P. Rahkila, M. Rejmund, J. Saren, C. Scholey, S. Siem, M.G. Saint-Laurent, C. Simenel, Yu. G. Sobolev, Ch. Stodel, J. Uusitalo, A. Villari, M. Bender, P. Bonche, P.-H. Heenen
- 2006De21 PRVCA 73, 044303 M.S. Dewey, E.G. Kessler Jr., R.D. Deslattes, H.G. Börner, M. Jentschel, C. Doll, P. Mutti
- 2006De36 PRVCA 74, 034331 P. Delahaye, G. Audi, K. Blaum, F. Carrel, S. George, F. Herfurth, A. Herlert, A. Kellerbauer, H.-J. Kluge, D. Lunney, L. Schweikhard, C. Yazidjian
- 2006Dr04 PYLBB 635, 200 G.D. Dracoulis, G.J. Lane, F.G. Kondev, A.P. Byrne, R.O. Hughes, P. Nieminen, H. Watanabe, M.P. Carpenter, R.V.F. Janssens, T. Lauritsen, D. Seweryniak, S. Zhu, P. Chowdhury, F.R. Xu
- 2006Dv01 PRLTA 97, 242501 J. Dvorak, W. Brühlle, M. Chelnokov, R. Dressler, Ch. E. Düllmann, K. Eberhardt, V. Gorshkov, E. Jäger, R. Krücken, A. Kuznetsov, Y. Nagame, F. Nebel, Z. Novackova, Z. Qin, M. Schädel, B. Schausten, E. Schimpf, A. Semchenkov, P. Thörle, A. Türler, M. Wegrzecki, B. Wierczinski, A. Yakushev, A. Yereimin
- 2006Er03 PYLBB 636, 191 T. Eronen, V. Elomaa, U. Hager, J. Hakala, A. Jokinen, A. Kankainen, I. Moore, H. Penttilä, S. Rahaman, S. Rinta-Antila, A. Saastamoinen, T. Sonoda, J. Äystö, A. Bey, B. Blank, G. Canchel, C. Dossat, J. Giovinozzo, I. Matea, N. Adimi
- 2006Er08 PRLTA 97, 232501 T. Eronen, V. Elomaa, U. Hager, J. Hakala, A. Jokinen, A. Kankainen, I. Moore, H. Penttilä, S. Rahaman, J. Rissanen, A. Saastamoinen, T. Sonoda, J. Äystö, J.C. Hardy, V.S. Kolhinen
- 2006Fi.A IAEA-Library 45 R.B. Firestone, S.M. Mughabghab, G.L. Molnar in Database of prompt gamma rays from slow neutron capture for elemental analysis - Vienna : International Atomic Energy Agency, 2006.
- 2006Fo02 PRVCA 73, 014611 C.M. Folden III, S.L. Nelson, Ch. E. Düllmann, J.M. Schwantes, R. Sudowe, P.M. Zielinski, K.E. Gregorich, H. Nitsche, D.C. Hoffman
- 2006Ga04 NUPAB 766, 52 C. Gaulard, G. Audi, C. Bachelet, D. Lunney, M. de Saint Simon, C. Thibault, N. Vieira
- 2006Ga28 PRLTA 97, 092501 L. Gaudefroy, O. Sorlin, D. Beaumel, Y. Blumenfeld, Z. Dombrádi, S. Fortier, S. Franchoo, M. Gélin, J. Gibelin, S. Grévy, F. Hammache, F. Ibrahim, K.W. Kemper, K.-L. Kratz, S.M. Lukyanov, C. Monrozeau, L. Nalpas, F. Nowacki, A.N. Ostrowski, T. Otsuka, Yu.-E. Penionzhkevich, J. Piekarewicz, E.C. Pollacco, P. Roussel-Chomaz, E. Rich, J.A. Scarpaci, M.G. Saint-Laurent, D. Sohler, M. Stanoiu, T. Suzuki, E. Tryggestad, D. Verney
- 2006Ge05 PRVCA 73, 037308 J. Genevey, R. Guglielmini, R. Orlandi, J.A. Pinston, A. Scherillo, G. Simpson, I. Tsekhanovich, N. Warr, J. Jolie
- 2006Gr24 PRVCA 74, 044611 K.E. Gregorich, J.M. Gates, Ch. E. Düllmann, R. Sudowe, S.L. Nelson, M.A. Garcia, I. Dragojević, C.M. Folden III, S.H. Neumann, D.C. Hoffman, H. Nitsche
- 2006Ha03 PRLTA 96, 042504 U. Hager, T. Eronen, J. Hakala, A. Jokinen, V.S. Kolhinen, S. Kopecky, I. Moore, A. Nieminen, M. Oinonen, S. Rinta-Antila, J. Szerypo, J. Äystö
- 2006Ha17 NIMAE 560, 388 K. Hauschild, A.V. Yereimin, O. Dorvaux, A. Lopez-Martens A.V. Belozerov, Ch. Briannon, M.L. Chelnokov, V.I. Chepigin, S.A. Garcia-Santamaria, V.A. Gorshkov, F. Hanappe, A.P. Kabachenko, A. Korichi, O.N. Malyshev, Yu. Ts. Oganessian, A.G. Popeko, N. Rowley, A.V. Shutov, L. Stuttgé, A.I. Svirikhin
- 2006Ha62 IJMPD 251, 119 P.A. Hausladen, J.R. Beene, A. Galindo-Uribarri, Y. Larochele, J.F. Liang, P.E. Mueller, D. Shapira, D.W. Stracener, J. Thomas, R.L. Varner, H. Wollnik
- 2006He19 NATUA 442, 896 R.D. Herzberg, P.T. Greenlees, P.A. Butler, G.D. Jones, M. Venhart, I.G. Darby, S. Eeckhaut, K. Eskola, T. Grahn, C. Gray-Jones, F.P. Heßberger, P. Jones, R. Julin, S. Juutinen, S. Ketelhut, W. Korten, M. Leino, A.-P. Leppänen, S. Moon, M. Nyman, R.D. Page, J. Pakarinen, A. Pritchard, P. Rahkila, J. Sarén, C. Scholey, A. Steer, Y. Sun, Ch. Theisen, J. Uusitalo

2006He20	EPJAA	29,	165	F.P. Heßberger, S. Hofmann, D. Ackermann, S. Antalic, B. Kindler, I. Kojouharov, P. Kuusiniemi, M. Leino, B. Lommel, R. Mann, K. Nishio, A.G. Popeko, B. Sulignano, S. Saro, B. Streicher, M. Venhart, A.V. Yeremin
2006He27	EPJAA	30,	561	F.P. Heßberger, S. Hofmann, D. Ackermann, S. Antalic, B. Kindler, I. Kojouharov, P. Kuusiniemi, M. Leino, B. Lommel, R. Mann, K. Nishio, A.G. Popeko, B. Sulignano, S. Saro, B. Streicher, M. Venhart, A.V. Yeremin
2006He29	IJMPD	251,	131	A. Herlert, S. Baruah, K. Blaum, P. Delahaye, M. Dworschak, S. George, C. Guenaut, U. Hager, F. Herfurth, A. Kellerbauer, M. Marie-Jeanne, S. Schwarz, L. Schweikhard, C. Yazidjian
2006Hi18	PYLBB	643,	257	P. Himpe, G. Neyens, D.L. Balabanski, G. Belier, D. Borremans, J.M. Daugas, F. de Oliveira Santos, M. De Rydt, K. Flanagan, G. Georgiev, M. Kowalska, S. Mallion, I. Matea, P. Morel, Yu. E. Penionzhkevich, N.A. Smirnova, C. Stodel, K. Turzó, N. Vermeulen, D. Yordanov
2006Hw01	PRVCA	73,	044316	J.K. Hwang, A.V. Ramayya, J.H. Hamilton, Y.X. Luo, A.V. Daniel, G.M. Ter-Akopian, J.D. Cole, S.J. Zhu
2006Jo10	PYLBB	641,	34	D.T. Joss, I.G. Darby, R.D. Page, J. Uusitalo, S. Eeckhaudt, T. Grahn, P.T. Greenlees, P.M. Jones, R. Julin, S. Juutinen, S. Ketelhut, M. Leino, A.-P. Leppänen, M. Nyman, J. Pakarinen, P. Rahkila, J. Sarén, C. Scholey, A. Steer, A.J. Cannon, P.D. Stevenson, J.S. Al-Khalili, S. Ertürk, M. Venhart, B. Gall, B. Hadinia, J. Simpson
2006Ka48	EPJAA	29,	271	A. Kankainen, L. Batist, S.A. Eliseev, V.-V. Elomaa, T. Eronen, U. Hager, J. Hakala, A. Jokinen, I. Moore, Yu. N. Novikov, H. Penttilä, K. Peräjärvi, A.V. Popov, S. Rahaman, S. Rinta-Antila, P. Ronkanen, A. Saastamoinen, D.M. Seliverstov, T. Sonoda, G.K. Vorobjev, J. Äystö
2006Ka74	IJMPD	251,	138	M. Kavatsyuk, L. Batist, M. Karny, E. Roeckl
2006Ko25	NIMAE	564,	275	Y. Kojima, M. Shibata, A. Taniguchi, Y. Kawase, R. Doi, A. Nagao, K. Shizuma
2006Ku26	EPJAA	30,	551	P. Kuusiniemi, F.P. Heßberger, D. Ackermann, S. Antalic, S. Hofmann, K. Nishio, B. Sulignano, I. Kojouharov, R. Mann
2006La16	PRVCA	74,	024316	K. Lagergren, D.T. Joss, R. Wyss, B. Cederwall, C.J. Barton, S. Eeckhaudt, T. Grahn, P.T. Greenlees, B. Hadinia, P.M. Jones, R. Julin, S. Juutinen, D. Karlgren, H. Kettunen, M. Leino, A.-P. Leppänen, P. Nieminen, M. Nyman, R.D. Page, J. Pakarinen, E.S. Paul, P. Rahkila, C. Scholey, J. Simpson, J. Uusitalo, D.R. Wiseman
2006Li41	PRLTA	97,	082501	S.N. Liddick, R. Grzywacz, C. Mazzocchi, R.D. Page, K.P. Rykaczewski, J.C. Batchelder, C.R. Bingham, I.G. Darby, G. Drafta, C. Goodin, C.J. Gross, J.H. Hamilton, A.A. Hecht, J.K. Hwang, S. Ilyushkin, D.T. Joss, A. Korgul, W. Królas, K. Lagergren, K. Li, M.N. Tantawy, J. Thomson, J.A. Winger
2006Lo12	PRVCA	74,	044303	A. Lopez-Martens, K. Hauschild, A.V. Yeremin, A.V. Belozero, Ch. Briançon, M.L. Chelnokov, V.I. Chepigin, D. Curien, O. Dorvaux, B. Gall, V.A. Gorschkov, M. Guttormsen, F. Hanappe, A.P. Kabachenko, F. Khalfallah, A. Korichi, A.C. Larsen, O.N. Malyshev, A. Minkova, Yu. Ts. Oganessian, A.G. Popeko, M. Rousseau, N. Rowley, R.N. Sagaidak, S. Sharo, A.V. Shutov, S. Siem, A.I. Svirikhin, N.U.H. Syed, Ch. Theisen
2006Lu03	ARISE	64,	588	J. Luo, X. Kong
2006Lu19	IJMPD	251,	286	D. Lunney, N. Vieira, G. Audi, C. Gaulard, M. de Saint Simon, C. Thibault
2006Ma.A	PrvCom	GAu	Jul	M. Martin
2006Me03	PRVCA	73,	024307	D.A. Meyer, C.W. Beausang, J.J. Ressler, H. Ai, H. Amro, M. Babilon, R.F. Casten, C.R. Fitzpatrick, G. Gurdal, A. Heinz, E.A. McCutchan, C. Plettner, J. Qian, N.J. Thomas, V. Werner, E. Williams, N.V. Zamfir, J. Zhang
2006Me04	PRVCA	73,	024318	T.J. Mertzimekis, P.F. Mantica, A.D. Davies, S.N. Liddick, B.E. Tomlin
2006Mo07	PRVCA	73,	035801	F. Montes, A. Estrade, P.T. Hosmer, S.N. Liddick, P.F. Mantica, A.C. Morton, W.F. Mueller, M. Ouellette, E. Pellegrini, P. Santi, H. Schatz, A. Stolz, B.E. Tomlin, O. Arndt, K.-L. Kratz, B. Pfeiffer, P. Reeder, W.B. Walters, A. Aprahamian, A. Wohr
2006Mu03	NATUA	439,	298	I. Mukha, E. Roeckl, L. Batist, A. Blazhev, J. Döring, H. Grawe, L. Grigorenko, M. Huyse, Z. Janas, R. Kirchner, M. La Commara, C. Mazzocchi, S.L. Tabor, P. Van Duppen
2006Na13	PRLTA	96,	163004	Sz. Nagy, T. Fritioff, M. Suhonen, R. Schuch, K. Blaum, M. Björkhage, I. Bergström also arXiv:1209.5281v1 24 Sep 2012

2006Na18	EPJDD	39,	1	Sz. Nagy, T. Fritioff, A. Solders, R. Schuch, M. Björkhage, I. Bergström
2006Na49	EULEE	74,	404	Sz. Nagy, T. Fritioff, M. Björkhage, I. Bergström, R. Schuch
2006Og05	PRVCA	74,	044602	Yu. Ts. Oganessian, V.K. Utyonkov, Yu. V. Lobanov, F. Sh. Abdullin, A.N. Polyakov, R.N. Sagaidak, I.V. Shirokovsky, Yu. S. Tsyganov, A.A. Voinov, G.G. Gulbekian, S.L. Bogomolov, B.N. Gikal, A.N. Mezentsev, S. Iliev, V.G. Subbotin, A.M. Sukhov, K. Subotic, V.I. Zagrebaev, G.K. Vostokin, M.G. Itkis, K.J. Moody, J.B. Patin, D.A. Shaughnessy, M.A. Stoyer, N.J. Stoyer, P.A. Wilk, J.M. Kenneally, J.H. Landrum, J.F. Wild, R.W. Loughheed
2006PaDG	JPGPE	33,	1	Particle Data Group
2006Pe16	PRVCA	74,	014313	F. Perrot, F. Maréchal, C. Jollet, Ph. Dessagne, J.-C. Angélique, G. Ban, P. Baumann, F. Benrachi, U. Bergmann, C. Borcea, A. Buta, J. Cederkall, S. Courtin, J.-M. Daugas, L.M. Fraile, S. Grévy, A. Jokinen, F.R. Lecolley, E. Liénard, G. Le Scornet, V. Méot, Ch. Miehé, F. Negoita, N.A. Orr, S. Pietri, E. Poirier, M. Ramdhane, O. Roig, I. Stefan, W. Wang
2006Pe17	PRVCA	74,	014316	D. Peterson, B.B. Back, R.V.F. Janssens, T.L. Khoo, C.J. Lister, D. Seweryniak, I. Ahmad, M.P. Carpenter, C.N. Davids, A.A. Hecht, C.L. Jiang, T. Lauritsen, X. Wang, S. Zhu, F.G. Kondev, A. Heinz, J. Qian, R. Winkler, P. Chowdhury, S.K. Tandel, U.S. Tandel
2006Ph01	PRVCA	74,	027302	A.A. Phillips, C. Andreoiu, G.C. Ball, D. Bandyopadhyay, J.A. Behr, T.E. Chupp, P. Finlay, P.E. Garrett, G.F. Grinyer, G. Hackman, M.E. Hayden, B. Hyland, S.R. Nuss-Warren, M.R. Pearson, M.A. Schumaker, M.B. Smith, C.E. Svensson, E.R. Tardiff, J.J. Valiente-Dobón, T. Warner
2006Qi03	YWPIF	23,	400	Z. Qin, X.L. Wu, H.J. Ding, W. Wu, W.X. Huang, X.G. Lei, Y.B. Xu, X.H. Yuan, B. Guo, W.F. Yang, Z.G. Gan, H.M. Fan, J.S. Guo, H.S. Xu, G.Q. Xiao
2006Re19	IJMPD	251,	125	M. Redshaw, J. McDaniel, W. Shi, E.G. Myers, and PrvCom GAU February 2006
2006Ri15	IJMPD	251,	300	R. Ringle, P. Schury, T. Sun, G. Bollen, D. Davies, J. Huikari, E. Kwan, D.J. Morrissey, A. Prinke, J. Savory, S. Schwarz, C. Sumithrarachchi
2006Ro11	NUPAB	769,	1	D. Rodríguez, G. Audi, J. Äystö, D. Beck, K. Blaum, G. Bollen, F. Herfurth, A. Jokinen, A. Kellerbauer, H.-J. Kluge, V.S. Kolhinen, M. Oinonen, E. Sauvan, S. Schwarz
2006Sa56	IJMPD	251,	252	G. Savard, J.C. Wang, K.S. Sharma, H. Sharma, J.A. Clark, C. Boudreau, F. Buchinger, J.E. Crawford, J.P. Greene, S. Gulick, A.A. Hecht, J.K.P. Lee, A.F. Levand, N.D. Scielzo, W. Trimble, J. Vaz, B.J. Zabransky
2006Se08	PRVCA	73,	061301	D. Seweryniak, K. Starosta, C.N. Davids, S. Gros, A.A. Hecht, N. Hoteling, T.L. Khoo, K. Lagergren, G. Lotay, D. Peterson, A. Robinson, C. Vaman, W.B. Walters, P.J. Woods, S. Zhu
2006Si36	PRVCA	74,	064308	G.S. Simpson, J.A. Pinston, D. Balabanski, J. Genevey, G. Georgiev, J. Jolie, D.S. Judson, R. Orlandi, A. Scherillo, I. Tsekhanovich, W. Urban, N. Warr
2006Sk03	PRVCA	73,	044301	F. Skaza, V. Lapoux, N. Keeley, N. Alamanos, E.C. Pollacco, F. Auger, A. Drouart, A. Gillibert, D. Beaumel, E. Becheva, Y. Blumenfeld, F. Delaunay, L. Giot, K.W. Kemper, L. Nalpas, A. Obertelli, A. Pakou, R. Raabe, P. Roussel-Chomaz, J.-L. Sida, J.-A. Scarpaci, S. Stepantsov, R. Wolski
2006Su12	PRVCA	74,	024322	C.S. Sumithrarachchi, D.W. Anthony, P.A. Lofy, D.J. Morrissey
2006Ta08	PRVCA	73,	024316	M.N. Tantawy, C.R. Bingham, K.P. Rykaczewski, J.C. Batchelder, W. Królas, M. Danchev, D. Fong, T.N. Ginter, C.J. Gross, R. Grzywacz, K. Hagino, J.H. Hamilton, D.J. Hartley, M. Karny, K. Li, C. Mazzocchi, A. Piechaczek, A.V. Ramayya, K. Rykaczewski, D. Shapira, A. Stolz, J.A. Winger, C.-H. Yu, E.F. Zganjar
2006Ta13	PRVCA	73,	044306	S.K. Tandel, P. Chowdhury, E.H. Seabury, I. Ahmad, M.P. Carpenter, S.M. Fischer, R.V.F. Janssens, T.L. Khoo, T. Lauritsen, C.J. Lister, D. Seweryniak, Y.R. Shimizu
2006Ta19	PRLTA	97,	082502	S.K. Tandel, T.L. Khoo, D. Seweryniak, G. Mukherjee, I. Ahmad, B. Back, R. Blinstrup, M.P. Carpenter, J. Chapman, P. Chowdhury, C.N. Davids, A.A. Hecht, A. Heinz, P. Ikin, R.V.F. Janssens, F.G. Kondev, T. Lauritsen, C.J. Lister, E.F. Moore, D. Peterson, P. Reiter, U.S. Tandel, X. Wang, S. Zhu
2006Th07	PRVCA	74,	034329	P. Thakur, V. Kumar, A.K. Bhati, S.C. Bedi, R.P. Singh, R.K. Bhowmik, A.E. Stuchbery

2006Tr02	PRVCA	73,	054303	V. Tripathi, S.L. Tabor, C.R. Hoffman, M. Wiedeking, A. Volya, P.F. Mantica, A.D. Davies, S.N. Liddick, W.F. Mueller, A. Stolz, B.E. Tomlin, T. Otsuka, Y. Utsuno
2006Tr10	PRVCA	74,	054306	S. Triambak, A. Garcia, D. Melconian, M. Mella, O. Biesel
2006Va22	IJMPD	251,	231	R.S. Van Dyck, Jr., D.B. Pinegar, S. Van Liew, S.L. Zafonte
2006Vo09	PRVCA	74,	034319	T. von Egidy, H.-F. Wirth, I. Tomandl, J. Honzátko
2006Wh02	PRVCA	74,	027303	C. Wheldon, J.J. Valiente-Dobón, P.H. Regan, C.J. Pearson, C.Y. Wu, J.F. Smith, A.O. Macchiavelli, D. Cline, R.S. Chakrawarthy, R. Chapman, M. Cromaz, P. Fallon, S.J. Freeman, W. Gelletly, A. Görgen, A.B. Hayes, H. Hua, S.D. Langdown, I.Y. Lee, X. Liang, Zs. Podolyák, G. Sletten, R. Teng, D. Ward, D.D. Warner, A.D. Yamamoto
2006Wi10	PRVCA	73,	044318	J.A. Winger, P.F. Mantica, R.M. Ronningen
2006Xu03	EPJAA	28,	37	S.-W. Xu, Y.-X. Xie, F.-R. Xu, H.-L. Liu, Z.-K. Li
2006Xu07	EPJAA	29,	161	S.W. Xu, Y.X. Xie, Z.K. Li, F.R. Xu, H.L. Liu, Y.B. Xing, B. Guo, J.P. Xing, C.F. Wang
2007				
2007Be16	PRLTA	98,	142501	B.R. Beck, J.A. Becker, P. Beiersdorfer, G.V. Brown, K.J. Moody, J.B. Wilhelmy, F.S. Porter, C.A. Kilbourne, R.L. Kelley
2007Be48	NUPAB	789,	15	P. Belli, R. Bernabei, F. Cappella, R. Cerulli, C.J. Dai, F.A. Danevich, A. d'Angelo, A. Incicchitti, V.V. Kobychiev, S.S. Nagorny, S. Nisi, F. Nozzoli, D. Prosperi, V.I. Tretyak, S.S. Yurchenko
2007Be61	PRVCA	76,	064603	P. Belli, R. Bernabei, N. Bukilic, F. Cappella, R. Cerulli, C.J. Dai, F.A. Danevich, J.R. de Laeter, A. Incicchitti, V.V. Kobychiev, S.S. Nagorny, S. Nisi, F. Nozzoli, D.V. Poda, D. Prosperi, V.I. Tretyak, S.S. Yurchenko
2007Bo50	EPJST	150,	337	G. Bollen, C. Bachelet, M. Block, D.A. Davies, M. Facina, C.M. Folden III, C. Guénaut, J. Huikari, E. Kwan, A. Kwiatowski, D.J. Morrissey, G. Pang, A. Prinke, R. Ringle, J. Savory, P. Schury, S. Schwarz, C. Sumithrarachchi, T. Sun
2007Ch07	PYLBB	645,	133	B. Cheal, M.D. Gardner, M. Avgoulea, J. Billowes, M.L. Bissell, P. Campbell, T. Eronen, K.T. Flanagan, D.H. Forest, J. Huikari, A. Jokinen, B.A. Marsh, I.D. Moore, A. Nieminen, H. Penttilä, S. Rinta-Antila, B. Tordoff, G. Tungate, J. Äystö
2007CI01	PRVCA	75,	032801	J.A. Clark, K.S. Sharma, G. Savard, A.F. Levand, J.C. Wang, Z. Zhou, B. Blank, F. Buchinger, J.E. Crawford, S. Gulick, J.K.P. Lee, D. Seweryniak, W. Trimble
2007DaZU	P-Lisbon		3	C.N. Davids
2007Do17	NUPAB	792,	18	C. Dossat, N. Adimi, F. Aksouh, F. Becker, A. Bey, B. Blank, C. Borcea, R. Borcea, A. Boston, M. Caamano, G. Canchel, M. Chartier, D. Cortina, S. Czajkowski, G. de France, F. de Oliveira Santos, A. Fleury, G. Georgiev, J. Giovino, S. Grévy, R. Grzywacz, M. Hellström, M. Honma, Z. Janas, D. Karamanis, J. Kurcewicz, M. Lewitowicz, M.J. López Jiménez, C. Mazzocchi, I. Matea, V. Maslov, P. Mayet, C. Moore, M. Pfützner, M.S. Pravikoff, M. Stanoiu, I. Stefan, J.C. Thomas
2007Ei02	NUPAB	787,	373c	R. Eichler, N.V. Aksenov, A.V. Belozеров, G.A. Bozhikov, V.I. Chepigin, R. Dressler, S.N. Dmitriev, H.W. Gäggeler, V.A. Gorshkov, F. Haenssler, M.G. Itkis, V. Ya. Lebedev, A. Laube, O.N. Malyshev, Yu. Ts. Oganessian, O.V. Petruschkin, D. Piguet, P. Rasmussen, S.V. Shishkin, A.V. Shutov, A.I. Svirikhin, E.E. Tereshatov, G.K. Vostokin, M. Wegrzecki, A.V. Yereimin
2007Fo02	PRVCA	75,	054308	B. Fogelberg, K.A. Mezilev, V.I. Isakov, K.I. Erokhina, H. Mach, E. Ramström, H. Gausemel
2007Ge07	PRLTA	98,	162501	S. George, S. Baruah, B. Blank, K. Blaum, M. Breitenfeldt, U. Hager, F. Herfurth, A. Herlert, A. Kellerbauer, H.-J. Kluge, M. Kretzschmar, D. Lunney, R. Savreux, S. Schwarz, L. Schweikhard, C. Yazidjian
2007Go24	PRVCA	76,	021605	M.S. Golovkov, L.V. Grigorenko, A.S. Fomichev, A.V. Gorshkov, V.A. Gorshkov, S.A. Krupko, Yu. Ts. Oganessian, A.M. Rodin, S.I. Sidorchuk, R.S. Slepnev, S.V. Stepantsov, G.M. Ter-Akopian, R. Wolski, A.A. Korshennikov, E. Yu. Nikolskii, V.A. Kuzmin, B.G. Novatskii, D.N. Stepanov, P. Roussel-Chomaz, W. Mittig

2007Gr18	PRVCA	76,	025503	G.F. Grinyer, M.B. Smith, C. Andreoiu, A.N. Andreyev, G.C. Ball, P. Bricault, R.S. Chakrawarthy, J.J. Daoud, P. Finlay, P.E. Garrett, G. Hackman, B. Hyland, J.R. Leslie, A.C. Morton, C.J. Pearson, A.A. Phillips, M.A. Schumaker, C.E. Svensson, J.J. Valiente-Dobon, S.J. Williams, E.F. Zganjar
2007Gu09	PRVCA	75,	044303	C. Guénaut, G. Audi, D. Beck, K. Blaum, G. Bollen, P. Delahaye, F. Herfurth, A. Kellerbauer, H.-J. Kluge, J. Libert, D. Lunney, S. Schwarz, L. Schweikhard, C. Yazidjian
2007Ha20	PRVCA	75,	064302	U. Hager, V.-V. Elomaa, T. Eronen, J. Hakala, A. Jokinen, A. Kankainen, S. Rahaman, S. Rinta-Antila, A. Saastamoinen, T. Sonoda, J. Äystö
2007Ha32	NUPAB	793,	20	U. Hager, A. Jokinen, V.-V. Elomaa, T. Eronen, J. Hakala, A. Kankainen, S. Rahaman, J. Rissanen, I.D. Moore, S. Rinta-Antila, A. Saastamoinen, T. Sonoda, J. Äystö
2007Ha45	PRVCA	76,	044312	B. Hadinia, B. Cederwall, D.T. Joss, R. Wyss, R.D. Page, C. Scholey, A. Johnson, K. Lagergren, E. Ganioglu, K. Andgren, T. Bäck, D.E. Appelbe, C.J. Barton, S. Eeckhauert, T. Grahn, P. Greenlees, P. Jones, R. Julin, S. Juutinen, H. Kettunen, M. Leino, A.-P. Lepänen, R.J. Liotta, P. Nieminen, J. Pakarinen, J. Perkowski, P. Rahkila, M. Sandzelius, J. Simpson, J. Uusitalo, K. Van de Vel, D.D. Warner, D.R. Wiseman
2007Ha57	EPJAA	34,	363	H. Hayashi, Y. Akita, O. Suematsu, M. Shibata, M. Asai, T.K. Sato, S. Ichikawa, I. Nishinaka, Y. Nagame, A. Osa, K. Tsukada, T. Ishii, Y. Kojima, A. Taniguchi
2007Ho18	EPJAA	32,	251	S. Hofmann, D. Ackermann, S. Antalic, H.G. Burkhard, V.F. Comas, R. Dressler, Z. Gan, S. Heinz, J.A. Heredia, F.P. Heßberger, J. Khuyagbaatar, B. Kindler, I. Kojouharov, P. Kuusiniemi, M. Leino, B. Lommel, R. Mann, G. Münzenberg, K. Nishio, A.G. Popeko, S. Saro, H.J. Schott, B. Streicher, B. Sulignano, J. Uusitalo, M. Venhart, A.V. Yeremin
2007Io03	PYLBB	650,	141	M. Ionescu-Bujor, A. Iordachescu, N. Marginean, C.A. Ur, D. Bucurescu, G. Suliman, D.L. Balabanski, F. Brandolini, S. Chmel, P. Detistov, K.A. Gladniskhi, H. Hubel, S. Mallion, R. Marginean, N.H. Medina, D.R. Napoli, G. Neyens, P. Pavan, R.V. Ribas, C. Rusu, K. Turzo, N. Vermeulen
2007Je07	EPJAA	32,	31	H.B. Jeppesen, J. Byskov-Nielsen, P. Wright, J.G. Correia, L.M. Fraile, H.O.U. Fynbo, K. Johnston, K. Riisager
2007Ju03	PYLBB	649,	43	B. Jurado, H. Savajols, W. Mittig, N.A. Orr, P. Roussel-Chomaz, D. Baiborodin, W.N. Catford, M. Chartier, C.E. Demonchy, Z. Dlouhý, A. Gillibert, L. Giot, A. Khouaja, A. Lépine-Szily, S. Lukyanov, J. Mrazek, Y.E. Penionzhkevich, S. Pita, M. Rousseau, A.C. Villari
2007Ju05	PRLTA	99,	132501	A. Jungclaus, L. Cáceres, M. Górska, M. Pfützner, S. Pietri, E. Werner-Malento, H. Grawe, K. Langanke, G. Martinez-Pinedo, F. Nowacki, A. Poves, J.J. Cuenca-Garcia, D. Rudolph, Z. Podolyák, P.H. Regan, P. Detistov, S. Lalkovski, V. Modamio, J. Walker, P. Bednarczyk, P. Doornenbal, H. Geissel, J. Gerl, J. Grebosz, I. Kojouharov, N. Kurz, W. Prokopowicz, H. Schaffner, H.J. Wollersheim, K. Andgren, J. Benlliure, G. Benzoni, A.M. Bruce, E. Casarejos, B. Cederwall, F.C.L. Crespi, B. Hadinia, M. Hellström, R. Hoischen, G. Ilie, J. Jolie, A. Khaplanov, M. Kmiecik, R. Kumar, A. Maj, S. Mandal, F. Montes, S. Myalski, G.S. Simpson, S.J. Steer, S. Tashenov, O. Wieland
2007Ju06	PRVCA	76,	054306	D.S. Judson, A.M. Bruce, T. Kibedi, G.D. Dracoulis, A.P. Byrne, G.J. Lane, K.H. Maier, C.-B. Moon, P. Nieminen, J.N. Orce, M.J. Taylor
2007Ka15	EPJAA	31,	319	O. Kavatsyuk, C. Mazzocchi, Z. Janas, A. Banu, L. Batist, F. Becker, A. Blazhev, W. Brühle, J. Döring, T. Faestermann, M. Górska, H. Grawe, A. Jungclaus, M. Karny, M. Kavatsyuk, O. Klepper, R. Kirchner, M. La Commara, K. Miernik, I. Mukha, C. Plettner, A. Plochocki, E. Roeckl, M. Romoli, K. Rykaczewski, M. Schadel, K. Schmidt, R. Schwengner, J. Zylicz
2007Ke09	PRVCA	76,	045504	A. Kellerbauer, G. Audi, D. Beck, K. Blaum, G. Bollen, C. Guénaut, F. Herfurth, A. Herlert, H.-J. Kluge, D. Lunney, S. Schwarz, L. Schweikhard, C. Weber, C. Yazidjian
2007Kh22	EPJAA	34,	355	J. Khuyagbaatar, S. Hofmann, F.P. Heßberger, D. Ackermann, S. Antalic, H.G. Burkhard, S. Heinz, B. Kindler, A.F. Lisetskiy, B. Lommel, R. Mann, K. Nishio, H.J. Schött, B. Sulignano

- 2007Ku23 EPJAA 33, 307 J. Kurpeta, W. Urban, Ch. Droste, A. Plochocki, S.G. Rohozinski, T. Rzaca-Urban, T. Morek, L. Prochniak, K. Starosta, J. Aysto, H. Penttila, J.L. Durell, A.G. Smith, G. Lhersonneau, I. Ahmad
- 2007Ku30 PRVCA 76, 054320 J. Kurcewicz, W. Czarnacki, M. Karny, M. Kasztelan, M. Kisieliński, A. Korgul, W. Kurcewicz, J. Kurpeta, S. Lewandowski, P. Majorkiewicz, H. Penttilä, A. Plochocki, B. Roussi re, O. Steczkiewicz, A. Wojtasiewicz
- 2007Le14 PRVCA 75, 054307 A.-P. Lepp nen, J. Uusitalo, M. Leino, S. Eeckhaudt, T. Grahn, P.T. Greenlees, P. Jones, R. Julin, S. Juutinen, H. Kettunen, P. Kuusiniemi, P. Nieminen, J. Pakarinen, P. R hki la, C. Scholey, G. Sletten
- 2007Li71 PRLTA 99, 262501 Yu. A. Litvinov, F. Bosch, H. Geissel, J. Kurcewicz, Z. Patyk, N. Winckler, L. Batist, K. Beckert, D. Boutin, C. Brandau, L. Chen, C. Dimopoulou, B. Fabian, T. Faestermann, A. Fregner, L. Grigorenko, E. Haettner, S. Hess, P. Kienle, R. Kn obel, C. Kozhuharov, S.A. Litvinov, L. Maier, M. Mazzocco, F. Montes, G. M nzenberg, A. Musumarra, C. Nociforo, F. Nolden, M. Pf tzner, W.R. Plass, A. Prochazka, R. Reda, R. Reuschl, C. Scheidenberger, M. Steck, T. Stohlker, S. Torilov, M. Trassinelli, B. Sun, H. Weick, M. Winkler
- 2007Lo11 EPJAA 32, 245 A. Lopez-Martens, K. Hauschild, A.V. Yeremin, O. Dorvaux, A.V. Belozerov, Ch. Briancon, M.L. Chelnokov, V.I. Chepigin, D. Curien, P. Desesquelles, B. Gall, V.A. Gorshkov, M. Guttormsen, F. Hanappe, A.P. Kabachenko, F. Khal-fallah, A. Korichi, A.C. Larsen, O.N. Malyshev, A. Minkova, Yu. Ts. Oganessian, A.G. Popeko, M. Rousseau, N. Rowley, R.N. Sagaidak, S. Sharo, A.V. Shutov, S. Siem, L. Stuttge, A.I. Svirikhin, N.U.H. Syed, Ch. Theisen
- 2007Ma35 PRLTA 98, 212501 C. Mazzocchi, R. Grzywacz, S.N. Liddick, K.P. Rykaczewski, H. Schatz, J.C. Batchelder, C.R. Bingham, C.J. Gross, J.H. Hamilton, J.K. Hwang, S. Ilyushkin, A. Korgul, W. Krolas, K. Li, R.D. Page, D. Simpson, J.A. Winger
- 2007Ma92 EPJAA 34, 341 A. Mart n, D. Ackermann, G. Audi, K. Blaum, M. Block, A. Chaudhuri, Z. Di, S. Eliseev, R. Ferrer, D. Habs, F. Herfurth, F.P. He bberger, S. Hofmann, H.-J. Kluge, M. Mazzocco, M. Mukherjee, J.B. Neumayr, Yu. Novikov, W. Pla , S. Rahaman, C. Rauth, D. Rodr guez, C. Scheidenberger, L. Schweikhard, P.G. Thirolf, G. Vorobjev, C. Weber
- 2007Mu15 PRLTA 99, 182501 I. Mukha, K. S mmerer, L. Acosta, M.A.G. Alvarez, E. Casarejos, A. Chatillon, D. Cortina-Gil, J. Espino, A. Fomichev, J.E. Garc a-Ramos, H. Geissel, J. G mez-Camacho, L. Grigorenko, J. Hoffmann, O. Kiselev, A. Korshenin-nikov, N. Kurz, Yu. Litvinov, I. Martel, C. Nociforo, W. Ott, M. Pf tzner, C. Rodr guez-Tajes, E. Roeckl, M. Stanoiu, H. Weick, P.J. Woods
- 2007My02 APOBB 38, 1277 S. Myalski, M. Kmiecik, A. Maj, P.H. Regan, A.B. Garnsworthy, S. Pietri, D. Rudolph, Zs. Podoly k, S.J. Steer, F. Becker, P. Bednarczyk, J. Gerl, M. Gorska, H. Grawe, I. Kojouharov, H. Schaffner, H.J. Wollersheim, W. Prokopowicz, J. Grebosz, G. Benzoni, B. Blank, C. Brandau, A.M. Bruce, L. Caceres, F. Camera, W.N. Catford, I.J. Cullen, Zs. Dombradi, P. Doornenbal, E. Estevez, H. Geissel, W. Gelletly, A. Heinz, R. Hoischen, G. Ilie, G.A. Jones, A. Jungclaus, A. Kelic, F.G. Kondev, T. Kurtukian-Nieto, N. Kurz, S. Lalkovski, Z. Liu, F. Montes, M. Pf tzner, T. Saito, T. Shizuma, A.J. Simons, S. Schwertel, S. Tachenov, P.M. Walker, E. Werner-Malento, O. Wieland
- 2007Og01 JPHGB 34, R165 Y. Oganessian
- 2007Og02 PRVCA 76, 011601 Yu. Ts. Oganessian, V.K. Utyonkov, Yu. V. Lobanov, F. Sh. Abdullin, A.N. Polyakov, R.N. Sagaidak, I.V. Shirokovsky, Yu. S. Tsyganov, A.A. Voinov, G.G. Gulbekian, S.L. Bogomolov, B.N. Gikal, A.N. Mezentsev, V.G. Subbotin, A.M. Sukhov, K. Subotic, V.I. Zagrebaev, G.K. Vostokin, M.G. Itkis, R.A. Henderson, J.M. Kenneally, J.H. Landrum, K.J. Moody, D.A. Shaughnessy, M.A. Stoyer, N.J. Stoyer, P.A. Wilk
- 2007Ok05 PRVCA 76, 044315 Y. Oktem, D.L. Balabanski, B. Akkus, C.W. Beausang, M. Bostan, R.B. Cakirli, R.F. Casten, M. Danchev, M. Djongolov, M.N. Erduran, S. Erturk, K.A. Glad-niski, G. Gurdal, J. Tm. Goon, D.J. Hartley, A.A. Hecht, R. Krucken, N. Nikolov, J.R. Novak, G. Rainovski, L.L. Riedinger, I. Yigitoglu, N.V. Zamfir, O. Zeidan

2007Pa27	PRVCA	75,	061302	R.D. Page, L. Bianco, I.G. Darby, J. Uusitalo, D.T. Joss, T. Grahn, R.-D. Herzberg, J. Pakarinen, J. Thomson, S. Eeckhaudt, P.T. Greenlees, P.M. Jones, R. Julin, S. Juutinen, S. Ketelhut, M. Leino, A.-P. Leppänen, M. Nyman, P. Rahkila, J. Sarén, C. Scholey, A. Steer, M.B. Gómez Hornillos, J.S. Al-Khalili, A.J. Cannon, P.D. Stevenson, S. Ertürk, B. Gall, B. Hadinia, M. Venhart, J. Simpson
2007Ra23	EPJAA	32,	87	S. Rahaman, U. Hager, V.-V. Elomaa, T. Eronen, J. Hakala, A. Jokinen, A. Kankainen, P. Karvonen, I.D. Moore, H. Penttilä, S. Rinta-Antila, J. Rissanen, A. Saastamoinen, T. Sonoda, J. Äystö
2007Ra27	EPJAA	34,	5	S. Rahaman, J. Hakala, V.-V. Elomaa, T. Eronen, U. Hager, A. Jokinen, A. Kankainen, I.D. Moore, H. Penttilä, S. Rinta-Antila, J. Rissanen, A. Saastamoinen, C. Weber, J. Äystö
2007Ra37	EPJST	150,	329	C. Rauth, D. Ackermann, G. Audi, M. Block, A. Chaudhuri, S. Eliseev, F. Herfurth, F.P. Heßberger, S. Hofmann, H.-J. Kluge, A. Martín, G. Marx, M. Mukherjee, J.B. Neumayr, W.R. Plaß, S. Rahaman, D. Rodríguez, L. Schweikhard, P.G. Thirolf, G. Vorobjev, C. Weber, and the SHIPTRAP Collaboration
2007Re03	PRLTA	98,	053003	M. Redshaw, E. Wingfield, J. McDaniel, E.G. Myers
2007Ri01	EPJAA	31,	1	S. Rinta-Antila, T. Eronen, V.-V. Elomaa, U. Hager, J. Hakala, A. Jokinen, P. Karvonen, H. Penttilä, J. Rissanen, T. Sonoda, A. Saastamoinen, J. Äystö
2007Ri08	PRVCA	75,	055503	R. Ringle, T. Sun, G. Bollen, D. Davies, M. Facina, J. Huikari, E. Kwan, D.J. Morrissey, A. Prinke, J. Savory, P. Schury, S. Schwarz, C.S. Sumithrarachchi and Prcvcom GAU Nov 2009
2007Sa36	PRLTA	99,	022501	M. Sandzelius, B. Hadinia, B. Cederwall, K. Andgren, E. Ganioglu, I.G. Darby, M.R. Dimmock, S. Eeckhaudt, T. Grahn, P.T. Greenlees, E. Ideguchi, P.M. Jones, D.T. Joss, R. Julin, S. Juutinen, A. Khaplanov, M. Leino, L. Nelson, M. Niikura, M. Nyman, R.D. Page, J. Pakarinen, E.S. Paul, M. Petri, P. Rahkila, J. Saren, C. Scholey, J. Sorri, J. Uusitalo, R. Wadsworth, R. Wyss
2007Sc24	PRVCA	75,	055801	P. Schury, C. Bachelet, M. Block, G. Bollen, D.A. Davies, M. Facina, C.M. Folden III, C. Guénaut, J. Huikari, E. Kwan, A. Kwiatkowski, D.J. Morrissey, R. Ringle, G.K. Pang, A. Prinke, J. Savory, H. Schatz, S. Schwarz, C.S. Sumithrarachchi, T. Sun, and erratum PRVCA 80(2009)029905
2007Se04	PRLTA	99,	022504	D. Seweryniak, M.P. Carpenter, S. Gros, A.A. Hecht, N. Hoteling, R.V.F. Janssens, T.L. Khoo, T. Lauritsen, C.J. Lister, G. Lotay, D. Peterson, A.P. Robinson, W.B. Walters, X. Wang, P.J. Woods, S. Zhu
2007Se06	PRLTA	99,	082502	D. Seweryniak, B. Blank, M.P. Carpenter, C.N. Davids, T. Davinson, S.J. Freeman, N. Hammond, N. Hoteling, R.V.F. Janssens, T.L. Khoo, Z. Liu, G. Mukherjee, A. Robinson, C. Scholey, S. Sinha, J. Shergur, K. Starosta, W.B. Walters, A. Woehr, P.J. Woods
2007Sh05	EPJAA	31,	171	M. Shibata, O. Suematsu, Y. Kojima, K. Kawade, A. Taniguchi, Y. Kawase
2007Sh34	PYLBB	654,	87	S. Shimoura, S. Ota, K. Demichi, N. Aoi, H. Baba, Z. Elekes, T. Fukuchi, T. Gomi, K. Hasegawa, E. Ideguchi, M. Ishihara, N. Iwasa, H. Iwasaki, S. Kanno, S. Kubono, K. Kurita, M. Kurokawa, Y.U. Matsuyama, S. Michimasa, K. Miller, T. Minemura, T. Motobayashi, T. Murakami, M. Notani, A. Odahara, A. Saito, H. Sakurai, E. Takeshita, S. Takeuchi, M. Tamaki, T. Teranishi, K. Yamada, Y. Yanagisawa, I. Hamamoto
2007Sh42	EPJAA	34,	1	T. Shizuma, T. Ishii, H. Makii, T. Hayakawa, S. Shigematsu, M. Matsuda, E. Ideguchi, Y. Zheng, M. Liu, T. Morikawa
2007Si24	NUPAB	791,	267	H. Simon, M. Meister, T. Aumann, M.J.G. Borge, L.V. Chulkov, U. Datta Pramanik, Th. W. Elze, H. Emling, C. Forssen, H. Geissel, M. Hellstrom, B. Jonson, J.V. Kratz, R. Kulesa, Y. Leifels, K. Markenroth, G. Munzenberg, F. Nickel, T. Nilsson, G. Nyman, A. Richter, K. Riisager, C. Scheidenberger, G. Schrieder, O. Tengblad, M.V. Zhukov
2007Si27	PRVCA	76,	041303	G.S. Simpson, J.C. Angelique, J. Genevey, J.A. Pinston, A. Covello, A. Gargano, U. Köster, R. Orlandi, A. Scherillo
2007St12	APOBB	38,	1561	B. Streicher, S. Antalic, S. Saro, M. Venhart, F.P. Heßberger, S. Hofmann, D. Ackermann, B. Kindler, I. Kojouharov, B. Lommel, R. Mann, B. Sulignano, P. Kuusiniemi

2007St18	NUPAB	787,	388c	N.J. Stoyer, J.H. Landrum, P.A. Wilk, K.J. Moody, J.M. Kenneally, D.A. Shaughnessy, M.A. Stoyer, J.F. Wild, R.W. Loughheed, S.N. Dmitriev, Yu. Ts. Oganessian, S.V. Shishkin, N.V. Aksenov, E.E. Tereshatov, G.A. Bozhikov, G.K. Vostokin, V.K. Utyonkov, A.A. Yeremin
2007Su05	PRVCA	75,	024305	C.S. Sumithrarachchi, D.J. Morrissey, B.A. Brown, A.D. Davies, D.A. Davies, M. Fancina, E. Kwan, P.F. Mantica, M. Portillo, Y. Shimbara, J. Stoker, R.R. Weerasiri
2007Su07	EPJAA	31,	393	B. Sun, Yu. A. Litvinov, P.M. Walker, K. Beckert, P. Beller, F. Bosch, D. Boutin, C. Brandau, L. Chen, C. Dimopoulou, H. Geissel, R. Knöbel, C. Kozhuharov, J. Kurcewicz, S.A. Litvinov, M. Mazzocco, J. Meng, C. Nociforo, F. Nolden, W.R. Plass, C. Scheidenberger, M. Steck, H. Weick, M. Winkler
2007Su19	EPJAA	33,	327	B. Sulignano, S. Heinz, F.P. Heßberger, S. Hofmann, D. Ackermann, S. Antalic, B. Kindler, I. Kojouharov, P. Kuusiniemi, B. Lommel, R. Mann, K. Nishio, A.G. Popeko, S. Saro, B. Streicher, M. Venhart, A.V. Yeremin
2007To23	EPJST	150,	183	B.E. Tomlin, P.F. Mantica, W.B. Walters
2007Tr08	PRVCA	76,	021301	V. Tripathi, S.L. Tabor, P.F. Mantica, Y. Utsuno, P. Bender, J. Cook, C.R. Hoffman, S. Lee, T. Otsuka, J. Pereira, M. Perry, K. Pepper, J.S. Pinter, J. Stoker, A. Volya, D. Weisshaar
2007Ya08	PRVCA	76,	024308	C. Yazidjian, G. Audi, D. Beck, K. Blaum, S. George, C. Guénaut, F. Herfurth, A. Herlert, A. Kellerbauer, H.-J. Kluge, D. Lunney, L. Schweikhard
			2008	
2008Ah02	PRVCA	77,	054302	I. Ahmad, F.G. Kondev, Z.M. Koenig, Wm. C. McHarris, S.W. Yates
2008Ak03	PYLBB	666,	430	Yu. Aksyutina, H.T. Johansson, P. Adrich, F. Aksouh, T. Aumann, K. Boretzky, M.J.G. Borge, A. Chatillon, L.V. Chulkov, D. Cortina-Gil, U. Datta Pramanik, H. Emling, C. Forssén, H.O.U. Fynbo, H. Geissel, M. Hellström, G. Ickert, K.L. Jones, B. Jonson, A. Kliemkiewicz, J.V. Kratz, R. Kulesa, M. Lantz, T. LeBlais, A.O. Lindahl, K. Mahata, M. Matos, M. Meister, G. Münzenberg, T. Nilsson, G. Nyman, R. Palit, M. Pantea, S. Paschalis, W. Prokopowicz, R. Reifarth, A. Richter, K. Riisager, G. Schrieder, H. Simon, K. Sümmerer, O. Tengblad, W. Walus, H. Weick, M.V. Zhukov
2008An05	PRVCA	77,	054303	K. Andgren, B. Cederwall, J. Uusitalo, A.N. Andreyev, S.J. Freeman, P.T. Greenlees, B. Hadinia, U. Jakobsson, A. Johnson, P.M. Jones, D.T. Joss, S. Juutinen, R. Julin, S. Ketelhut, A. Khaplanov, M. Leino, M. Nyman, R.D. Page, P. Rakhila, M. Sandzelius, P. Sapple, J. Sarén, C. Scholey, J. Simpson, J. Sorri, J. Thomson, R. Wyss
2008An11	PRVCA	78,	044328	K. Andgren, U. Jakobsson, B. Cederwall, J. Uusitalo, T. Bäck, S.J. Freeman, P.T. Greenlees, B. Hadinia, A. Hugues, A. Johnson, P.M. Jones, D.T. Joss, S. Juutinen, R. Julin, S. Ketelhut, A. Khaplanov, M. Leino, M. Nyman, R.D. Page, P. Rakhila, M. Sandzelius, P. Sapple, J. Sarén, C. Scholey, J. Simpson, J. Sorri, J. Thomson, R. Wyss
2008An16	EPJAA	38,	219	S. Antalic, F.P. Heßberger, S. Hofmann, D. Ackermann, S. Heinz, B. Kindler, I. Kojouharov, P. Kuusiniemi, M. Leino, B. Lommel, R. Mann, K. Nishio, Š. Šáro, B. Streicher, B. Sulignano, M. Venhart
2008Ba53	PRLTA	101,	252501	D. Bazin, F. Montes, A. Becerril, G. Lorusso, A. Amthor, T. Baumann, H. Crawford, A. Estrade, A. Gade, T. Ginter, C.J. Guess, M. Hausmann, G.W. Hitt, P. Mantica, M. Matos, R. Meharchand, K. Minamisono, G. Perdikakis, J. Pereira, J. Pinter, M. Portillo, H. Schatz, K. Smith, J. Stoker, A. Stolz, R.G.T. Zegers
2008Ba54	PRLTA	101,	262501	S. Baruah, G. Audi, K. Blaum, M. Dworschak, S. George, C. Guénaut, U. Hager, F. Herfurth, A. Herlert, A. Kellerbauer, H.-J. Kluge, D. Lunney, H. Schatz, L. Schweikhard, C. Yazidjian
2008Bh08	PRVCA	77,	065503	M. Bhattacharya, D. Melconian, A. Komives, S. Triambak, A. García, E.G. Adelberger, B.A. Brown, M.W. Cooper, T. Glasmacher, V. Guimaraes, P.F. Mantica, A.M. Oros-Peusquens, J.I. Prisciandaro, M. Steiner, H.E. Swanson, S.L. Tabor, M. Wiedeking
2008BI05	PRLTA	100,	132501	M. Block, C. Bachelet, G. Bollen, M. Facina, C.M. Folden III, C. Guénaut, A.A. Kwiatkowski, D.J. Morrissey, G.K. Pang, A. Prinke, R. Ringle, J. Savory, P. Schury, S. Schwarz

2008Bo26	NUPAB	811,	28	V. Bondarenko, I. Tomandl, H.-F. Wirth, J. Honzatko, A.M. Sukhovo, L.A. Malov, L.I. Simonova, R. Hertzenberger, T. von Egidy, J. Berzins
2008Br.A	PrvCom	GAu	Dec	M. Breitenfeldt
2008Br.C	PrvCom	GAu	Mar	M. Brodeur
2008Br.D	PrvCom	GAu	Aug	M. Brodeur
2008Ca22	PRVCA	78,	044001	M. Caamano, D. Cortina-Gil, W. Mittig, H. Savajols, M. Chartier, C.E. Demonchy, B. Fernandez, M.B. Gomez Hornillos, A. Gillibert, B. Jurado, O. Kiselev, R. Lemmon, A. Obertelli, F. Rejmund, M. Rejmund, P. Roussel-Chomaz, R. Wolski
2008Ch07	NUPAB	801,	101	G. Christian, W.A. Peters, D. Absalon, D. Albertson, T. Baumann, D. Bazin, E. Breitbach, J. Brown, P.L. Cole, D. Denby, P.A. DeYoung, J.E. Finck, N. Frank, A. Fritsch, C. Hall, A.M. Hayes, J. Hinnefeld, C.R. Hoffman, R. Howes, B. Luther, E. Mosby, S. Mosby, D. Padilla, P.V. Pancella, G. Peaslee, W.F. Rogers, A. Schiller, M.J. Strongman, M. Thoennessen, L.O. Wagner
2008Ch28	PRVCA	78,	054307	R.J. Charity, S.A. Komarov, L.G. Sobotka, J. Clifford, D. Bazin, A. Gade, J. Lee, S.M. Lukyanov, W.G. Lynch, M. Mocko, S.P. Lobastov, A.M. Rogers, A. Saneltullaev, M.B. Tsang, M.S. Wallace, R.G.T. Zegers, S. Hudan, C. Metelko, M.A. Famiano, A.H. Wuosmaa, M.J. van Goethem
2008Ch.A	Th.-Giessen			Lixin Chen
2008De29	PRVCA	78,	044303	D.H. Denby, P.A. DeYoung, T. Baumann, D. Bazin, E. Breitbach, J. Brown, N. Frank, A. Gade, C.C. Hall, J. Hinnefeld, C.R. Hoffman, R. Howes, R.A. Jensen, B. Luther, S.M. Mosby, C.W. Olson, W.A. Peters, A. Schiller, A. Spyrou, M. Thoennessen
2008Dr05	PRVCA	78,	024605	I. Dragojevic, K.E. Gregorich, Ch. E. Düllmann, M.A. Garcia, J.M. Gates, S.L. Nelson, L. Stavsetra, R. Sudowe, H. Nitsche
2008Du09	PRVCA	77,	064320	Ch. E. Düllmann, A. Türler and erratum PRVCA 78(2008)029901
2008Dv02	PRLTA	100,	132503	J. Dvorak, W. Brüche, M. Chelnokov, Ch. E. Düllmann, Z. Dvorakova, K. Eberhardt, E. Jäger, R. Krücken, A. Kuznetsov, Y. Nagame, F. Nebel, K. Nishio, R. Perego, Z. Qin, M. Schädel, B. Schausten, E. Schimpf, R. Schuber, A. Semchenkov, P. Thörle, A. Türler, M. Wegrzecki, B. Wierczinski, A. Yakushev, A. Yereimin
2008Dw01	PRLTA	100,	072501	M. Dworschak, G. Audi, K. Blaum, P. Delahaye, S. George, U. Hager, F. Herfurth, A. Herlert, A. Kellerbauer, H.-J. Kluge, D. Lunney, L. Schweikhard, C. Yazidjian and PrvCom GAu May 2007
2008Ea01	PRVCA	77,	024303	M.C. Eastman, K.S. Krane
2008Er04	PRLTA	100,	132502	T. Eronen, V.-V. Elomaa, U. Hager, J. Hakala, J.C. Hardy, A. Jokinen, A. Kankainen, I.D. Moore, H. Penttilä, S. Rahaman, S. Rinta-Antila, J. Rissanen, A. Saastamoinen, T. Sonoda, C. Weber, J. Äystö
2008Fa11	PRVCA	78,	022801	J. Fallis, J.A. Clark, K.S. Sharma, G. Savard, F. Buchinger, S. Caldwell, J.E. Crawford, C.M. Deibel, J.L. Fisker, S. Gulick, A.A. Hecht, D. Lascar, J.K.P. Lee, A.F. Levand, G. Li, B.F. Lundgren, A. Parikh, S. Russell, M. Scholtzvan de Vorst, N.D. Scielzo, R.E. Segel, H. Sharma, S. Sinha, M. Sternberg, T. Sun, I. Tanihata, J. Van Schelt, J.C. Wang, Y. Wang, C. Wrede, Z. Zhou
2008Fe02	EPJAA	35,	167	M. Ferraton, R. Bourgain, C.M. Petrache, D. Verney, F. Ibrahim, N. de Séville, S. Franchoo, M. Lebois, C. Phan Viet, L. Sagui, I. Stefan, J.F. Clavelin, M. Vilmay
2008Fi.A	PrvCom	BPf	Oct	R.B. Firestone
2008Ga04	PYLBB	660,	326	A.B. Garnsworthy, P.H. Regan, L. Cáceres, S. Pietri, Y. Sun, D. Rudolph, M. Górka, Zs. Podolyák, S.J. Steer, R. Hoischen, A. Heinz, F. Becker, P. Bednarczyk, P. Doornenbal, H. Geissel, J. Gerl, H. Grawe, J. Grebosz, A. Kelic, I. Kojouharov, N. Kurz, F. Montes, W. Prokopowicz, T. Saito, H. Schaffner, S. Tachenov, E. Werner-Malento, H.J. Wollersheim, G. Benzoni, B.B. Blank, C. Brandau, A.M. Bruce, F. Camera, W.N. Catford, I.J. Cullen, Zs. Dombrádi, E. Estevez, W. Gelletly, G. Ilie, J. Jolie, G.A. Jones, A. Jungclaus, M. Kmiecik, F.G. Kondev, T. Kurtukian-Nieto, S. Lalkovski, Z. Liu, A. Maj, S. Myalski, M. Pfützner, S. Schwertel, T. Shizuma, A.J. Simons, P.M. Walker, O. Wieland, F.R. Xu

2008Ga08	PRVCA	77,	034603	J.M. Gates, M.A. Garcia, K.E. Gregorich, Ch. E. Düllmann, I. Dragojević, J. Dvorak, R. Eichler, C.M. Folden III, W. Loveland, S.L. Nelson, G.K. Pang, L. Stavsetra, R. Sudowe, A. Türler, H. Nitsche
2008Ga.A	PrvCom		08Bh08	A. Garcia et al at ISOLDE
2008Ge07	PRLTA	101,	252502	W. Geithner, T. Neff, G. Audi, K. Blaum, P. Delahaye, H. Feldmeier, S. George, C. Guenaut, F. Herfurth, A. Herlert, S. Kappertz, M. Keim, A. Kellerbauer, H.-J. Kluge, M. Kowalska, P. Lievens, D. Lunney, K. Marinova, R. Neugart, L. Schweikhard, S. Wilbert, C. Yazidjian and PrvCom from A. Herlert February 2005
2008Ge08	EULEE	82,	50005	S. George, G. Audi, B. Blank, K. Blaum, M. Breitenfeldt, U. Hager, F. Herfurth, A. Herlert, A. Kellerbauer, H.-J. Kluge, M. Kretzschmar, D. Lunney, R. Savreux, S. Schwarz, L. Schweikhard, C. Yazidjian
2008Go23	PRVCA	78,	014311	M.B. Gómez Hornillos, M. Chartier, W. Mittig, A. Lépine-Szily, L. Caballero, C.E. Demonchy, G. Georgiev, N.A. Orr, G. Politi, M. Rousseau, P. Roussel-Chomaz, A.C.C. Villari
2008Go.A	AnRpt GSI		140	A. Gorshkov et al
2008Gr17	PRVCA	78,	021303	P.T. Greenlees, R.-D. Herzberg, S. Ketelhut, P.A. Butler, P. Chowdhury, T. Grahn, C. Gray-Jones, G.D. Jones, P. Jones, R. Julin, S. Juutinen, T.-L. Khoo, M. Leino, S. Moon, M. Nyman, J. Pakarinen, P. Rakhila, D. Rostron, J. Sarén, C. Scholey, J. Sorri, S.K. Tandel, J. Uusitalo, M. Venhart
2008Ha12	PRVCA	77,	047305	K. Hauschild, A. Lopez-Martens, A.V. Yeremin, O. Dorvaux, A.V. Belozerov, M.L. Chelnokov, V.I. Chepigin, B. Gall, V.A. Gorshkov, M. Guttormsen, P. Jones, A.P. Kabachenko, A. Khouaja, A.C. Larsen, O.N. Malyshev, A. Minkova, H.T. Nyhus, Yu. Ts. Oganessian, D. Pantelica, A.G. Popeko, F. Rotaru, S. Saro, A.V. Shutov, S. Siem, A.I. Svirikhin, N.U.H. Syed
2008Ha21	PRVCA	77,	068801	T. Hayakawa, T. Shizuma, S. Miyamoto, S. Amano, K. Horikawa, K. Ishihara, M. Mori, K. Kawase, M. Kando, N. Kikuzawa, S. Chiba, T. Mochizuki, T. Kajino, M. Fujiwara
2008Ha23	PRLTA	101,	052502	J. Hakala, S. Rahaman, V.-V. Elomaa, T. Eronen, U. Hager, A. Jokinen, A. Kankainen, I.D. Moore, H. Penttilä, S. Rinta-Antila, J. Rissanen, A. Saastamoinen, T. Sonoda, C. Weber, J. Äystö
2008Ha31	PRVCA	78,	021302	K. Hauschild, A. Lopez-Martens, A.V. Yeremin, O. Dorvaux, S. Antalic, A.V. Belozerov, Ch. Briançon, M.L. Chelnokov, V.I. Chepigin, D. Curien, B. Gall, A. Görgen, V.A. Gorshkov, M. Guttormsen, F. Hanappe, A.P. Kabachenko, F. Khalfallah, A.C. Larsen, O.N. Malyshev, A. Minkova, A.G. Popeko, M. Rousseau, N. Rowley, S. Saro, A.V. Shutov, S. Siem, L. Stuttgè, A.I. Svirikhin, N.U.H. Syed, Ch. Theisen, M. Venhart
2008Ha.A	PrvCom	BPf	Sep	P.A. Hausladen
2008Hi05	PRVCA	77,	034305	T.A. Hinnens, V. Tripathi, S.L. Tabor, A. Volya, P.C. Bender, C.R. Hoffman, S. Lee, M. Perry, P.F. Mantica, A.D. Davies, S.N. Liddick, W.F. Mueller, A. Stolz, B.E. Tomlin
2008Ho03	PRLTA	100,	152502	C.R. Hoffman, T. Baumann, D. Bazin, J. Brown, G. Christian, P.A. DeYoung, J.E. Finck, N. Frank, J. Hinnefeld, R. Howes, P. Mears, E. Mosby, S. Mosby, J. Reith, B. Rizzo, W.F. Rogers, G. Peaslee, W.A. Peters, A. Schiller, M.J. Scott, S.L. Tabor, M. Thoennessen, P.J. Voss, T. Williams
2008Ia01	PRVCA	77,	045501	V.E. Iacob, J.C. Hardy, V. Golovko, J. Goodwin, N. Nica, H.I. Park, L. Trache, R.E. Tribble
2008Jo03	PRVCA	77,	034311	G.A. Jones, S.J. Williams, P.M. Walker, Zs. Podolyák, S. Zhu, M.P. Carpenter, J.J. Carroll, R.S. Chakravarthy, P. Chowdhury, I.J. Cullen, G.D. Dracoulis, A.B. Garnsworthy, G. Hackman, R.V.F. Janssens, T.L. Khoo, F.G. Kondev, G.J. Lane, Z. Liu, D. Seweryniak, N.J. Thompson
2008Jo04	PRVCA	77,	064316	E.K. Johansson, D. Rudolph, L.-L. Andersson, D.A. Torres, I. Ragnarsson, C. Andreoiu, C. Baktash, M.P. Carpenter, R.J. Charity, C.J. Chiara, J. Ekman, C. Fahlander, C. Hoel, O.L. Pechenaya, W. Reviol, R. du Rietz, D.G. Sarantites, D. Seweryniak, L.G. Sobotka, C.H. Yu, S. Zhu
2008Kh10	EPJAA	37,	177	J. Khuyagbaatar, S. Hofmann, F.P. Heßberger, D. Ackermann, H.G. Burkhard, S. Heinz, B. Kindler, I. Kojouharov, B. Lommel, R. Mann, J. Maurer, K. Nishio, Yu. Novikov
2008Kn.A	Th.-GSI			Knöbel

2008Lo07	PRVCA	77,	064313	R.L. Lozeva, G.S. Simpson, H. Grawe, G. Neyens, L.A. Atanasova, D.L. Balabanski, D. Bazzacco, F. Becker, P. Bednarczyk, G. Benzoni, N. Blasi, A. Blazhev, A. Bracco, C. Brandau, L. Cáceres, F. Camera, S.K. Chamoli, F.C.L. Crespi, J.-M. Daugas, P. Detistov, M. De Rydt, P. Doornenbal, C. Fahlander, E. Farnea, G. Georgiev, J. Gerl, K.A. Gladnishki, M. Górska, J. Grebosz, M. Hass, R. Hoischen, G. Ilie, M. Ionescu-Bujor, A. Iordachescu, J. Jolie, A. Jungclaus, M. Kmiecik, I. Kojouharov, N. Kurz, S.P. Lakshmi, G. Lo Bianco, S. Mallion, A. Maj, D. Montanari, O. Perru, M. Pfützner, S. Pietri, J.A. Pinston, Zs. Podolyák, W. Prokopowicz, D. Rudolph, G. Rusev, T.R. Saitoh, A. Saltarelli, H. Schaffner, R. Schwengner, S. Tashenov, K. Turzó, J.J. Valiente-Dobón, N. Vermeulen, J. Walker, E. Werner-Malento, O. Wieland, H.-J. Wollersheim
2008Ma01	PRVCA	77,	014313	P.F. Mantica, R. Broda, H.L. Crawford, A. Damaske, B. Fornal, A.A. Hecht, C. Hoffman, M. Horoi, N. Hoteling, R.V.F. Janssens, J. Pereira, J.S. Pinter, J.B. Stoker, S.L. Tabor, T. Sumikama, W.B. Walters, X. Wang, S. Zhu
2008Mo09	NUPAB	805	172c	K. Morita
2008Mu05	EPJAA	35,	31	M. Mukherjee, D. Beck, K. Blaum, G. Bollen, P. Delahaye, J. Dilling, S. George, C. Guénaut, F. Herfurth, A. Herlert, A. Kellerbauer, H.-J. Kluge, U. Köster, D. Lunney, S. Schwarz, L. Schweikhard, C. Yazidjian
2008Mu13	PRVCA	77,	061303	I. Mukha, L. Grigorenko, K. Sümmerer, L. Acosta, M.A.G. Alvarez, E. Casarejos, A. Chatillon, D. Cortina-Gil, J.M. Espino, A. Fomichev, J.E. García-Ramos, H. Geissel, J. Gómez-Camacho, J. Hofmann, O. Kiselev, A. Korshennikov, N. Kurz, Yu. Litvinov, I. Martel, C. Nociforo, W. Ott, M. Pfützner, C. Rodríguez-Tajes, E. Roeckl, M. Stanoiu, H. Weick, P.J. Woods
2008Ne01	PRLTA	100,	022501	S.L. Nelson, K.E. Gregorich, I. Dragojević, M.A. Garcia, J.M. Gates, R. Sudowe, H. Nitsche
2008Ne08	PRVCA	78,	024606	S.L. Nelson, C.M. Folden III, K.E. Gregorich, I. Dragojević, Ch. E. Düllmann, R. Eichler, M.A. Garcia, J.M. Gates, R. Sudowe, H. Nitsche
2008Os02	NIMBE	266,	4394	A. Osa, S.-i. Ichikawa, M. Matsuda, T.K. Sato, S.-C. Jeong
2008Pa33	PRVCA	78,	041307	D. Pauwels, O. Ivanov, N. Bree, J. Büscher, T.E. Cocolios, J. Gentens, M. Huyse, A. Korgul, Yu. Kudryavtsev, R. Raabe, M. Sawicka, I. Stefanescu, J. Van de Walle, P. Van den Bergh, P. Van Duppen, W.B. Walters
2008Qi03	RAACA	96,	455	Z. Qin, W. Brüchle, D. Ackermann, K. Eberhardt, F.P. Heßberger, E. Jäger, J.V. Kratz, P. Kuusiniemi, D. Liebe, G. Münzenberg, D. Nayak, Yu. N. Novikov, M. Schädel, B. Schausten, E. Schimpf, A. Semchenkov, B. Sulignano, P. Thörle, X.L. Wu and PrvCom from 2002Sh. C
2008Ra09	PYLBB	662,	111	S. Rahaman, V.-V. Elomaa, T. Eronen, J. Hakala, A. Jokinen, J. Julin, A. Kankainen, A. Saastamoinen, J. Suhonen, C. Weber, J. Äystö
2008Re16	PRLTA	100,	093002	M. Redshaw, J. McDaniel, E.G. Myers
2008Ri05	PRVCA	78,	034304	S.V. Rigby, D.M. Cullen, P.J.R. Mason, D.T. Scholes, C. Scholey, P. Rakhila, S. Eeckhaudt, T. Grahn, P. Greenlees, P.M. Jones, R. Julin, S. Juutinen, H. Kettunen, M. Leino, A.-P. Leppänen, P. Nieminen, M. Nyman, J. Pakarinen, J. Uusitalo
2008Ro21	PRVCA	78,	034308	A.P. Robinson, T.L. Khoo, I. Ahmad, S.K. Tandel, F.G. Kondev, T. Nakatsukasa, D. Seweryniak, M. Asai, B.B. Back, M.P. Carpenter, P. Chowdhury, C.N. Davids, S. Eeckhaudt, J.P. Greene, P.T. Greenlees, S. Gros, A. Heinz, R.-D. Herzberg, R.V.F. Janssens, G.D. Jones, T. Lauritsen, C.J. Lister, D. Peterson, J. Qian, U.S. Tandel, X. Wang, S. Zhu
2008Ru09	PRVCA	78,	021301	D. Rudolph, R. Hoischen, M. Hellström, S. Pietri, Zs. Podolyák, P.H. Regan, A.B. Garnsworthy, S.J. Steer, F. Becker, P. Bednarczyk, L. Cáceres, P. Doornenbal, J. Gerl, M. Górska, J. Grebosz, I. Kojouharov, N. Kurz, W. Prokopowicz, H. Schaffner, H.J. Wollersheim, L.-L. Andersson, L. Atanasova, D.L. Balabanski, M.A. Bentley, A. Blazhev, C. Brandau, J.R. Brown, C. Fahlander, E.K. Johansson, A. Jungclaus, S.M. Lenzi
2008Ry03	PRLTA	101,	012501	V.L. Ryjkov, M. Brodeur, T. Brunner, M. Smith, R. Ringle, A. Lapierre, F. Ames, P. Bricault, M. Domsbky, P. Delheij, D. Lunney, M.R. Pearson, J. Dilling
2008Sm03	PRLTA	101,	202501	M. Smith, M. Brodeur, T. Brunner, S. Ettenauer, A. Lapierre, R. Ringle, V.L. Ryjkov, F. Ames, P. Bricault, G.W.F. Drake, P. Delheij, D. Lunney, F. Sarazin, J. Dilling

2008Sm.A	Th.-Vancouver			M.J. Smith
2008So20	PRVAA	78,	012514	A. Solders, I. Bergström, Sz. Nagy, M. Suhonen, R. Schuch
2008Su14	EPJAA	36,	243	G. Suliman, D. Bucurescu, R. Hertenberg, H.-F. Wirth, T. Faestermann, R. Krücken, T. Behrens, V. Bildstein, K. Eppinger, C. Hinke, M. Mahgoub, P. Meierbeck, M. Reithner, S. Schwertel, N. Chauvin
2008Su19	NUPAB	812,	1	B. Sun, R. Knöbel, Yu. A. Litvinov, H. Geissel, J. Meng, K. Beckert, F. Bosch, D. Boutin, C. Brandau, L. Chen, I.J. Cullen, C. Dimopoulou, B. Fabian, M. Hausmann, C. Kozhuharov, S.A. Litvinov, M. Mazzocco, F. Montes, G. Münzenberg, A. Musumarra, S. Nakajima, C. Nociforo, F. Nolden, T. Ohtsubo, A. Ozawa, Z. Patyk, W.R. Plaß, C. Scheidenberger, M. Steck, T. Suzuki, P.M. Walker, H. Weick, N. Winckler, M. Winkler, T. Yamaguchi
2008Tr04	PRVCA	77,	034310	V. Tripathi, S.L. Tabor, P. Bender, C.R. Hoffman, S. Lee, K. Pepper, M. Perry, P.F. Mantica, J.M. Cook, J. Pereira, J.S. Pinter, J.B. Stoker, D. Weisshaar, Y. Utsuno, T. Otsuka
2008We02	NUPAB	803,	1	C. Weber, G. Audi, D. Beck, K. Blaum, G. Bollen, F. Herfurth, A. Kellerbauer, H.-J. Kluge, D. Lunney, S. Schwarz
2008We10	PRVCA	78,	054310	C. Weber, V.-V. Elomaa, R. Ferrer, C. Fröhlich, D. Ackermann, J. Äystö, G. Audi, L. Batist, K. Blaum, M. Block, A. Chaudhuri, M. Dworschak, S. Eliseev, T. Eronen, U. Hager, J. Hakala, F. Herfurth, F.P. Heßberger, S. Hofmann, A. Jokinen, A. Kankainen, H.-J. Kluge, K. Langanke, A. Martín, G. Martínez-Pinedo, M. Mazzocco, I.D. Moore, J.B. Neumayr, Yu. N. Novikov, H. Penttilä, W.R. Plaß, A.V. Popov, S. Rahaman, T. Rauscher, C. Rauth, J. Rissanen, D. Rodríguez, A. Saastamoinen, C. Scheidenberger, L. Schweikhard, D.M. Seliverstov, T. Sonoda, F.-K. Thielemann, P.G. Thirolf, G.K. Vorobjev
2009				
2009Ak03	PYLBB	679,	191	Yu. Aksyutina, H.T. Johansson, T. Aumann, K. Boretzky, M.J.G. Borge, A. Chatillon, L.V. Chulkov, D. Cortina-Gil, U. Datta Pramanik, H. Emling, C. Forssén, H.O.U. Fynbo, H. Geissel, G. Ickert, B. Jonson, R. Kulesa, C. Langer, M. Lantz, T. LeBleis, A.O. Lindahl, K. Mahata, M. Meister, G. Münzenberg, T. Nilsson, G. Nyman, R. Palit, S. Paschalis, W. Prokopowicz, R. Reifarth, A. Richter, K. Riisager, G. Schrieder, H. Simon, K. Summerer, O. Tengblad, H. Weick, M.V. Zhukov
2009A129	PRVCA	80,	061302	N. Al-Dahan, Zs. Podolyák, P.H. Regan, M. Górska, H. Grawe, K.H. Maier, J. Gerl, S.B. Pietri, H.J. Wollersheim, N. Alkhomashi, A.Y. Deo, A.M.D. Bacelar, G. Farrelly, S.J. Steer, A.M. Bruce, P. Boutachkov, C. Domingo-Pardo, A. Algora, J. Benlliure, A. Bracco, E. Calore, E. Casarejos, I.J. Cullen, P. Detistov, Zs. Dombrádi, M. Doncel, F. Farinon, W. Gelletly, H. Geissel, N. Goel, J. Grebosz, R. Hoischen, I. Kojouharov, N. Kurz, S. Lalkovski, S. Leoni, F. Molina, D. Montanari, A.I. Morales, A. Musumarra, D.R. Napoli, R. Nicolini, C. Nociforo, A. Prochazka, W. Prokopowicz, B. Rubio, D. Rudolph, H. Schaffner, P. Strmen, I. Szarka, T. Swan, J.S. Thomas, J.J. Valiente-Dobón, S. Verma, P.M. Walker, H. Weick
2009A130	PRVCA	80,	064308	N. Alkhomashi, P.H. Regan, Zs. Podolyák, S. Pietri, A.B. Garnsworthy, S.J. Steer, J. Benlliure, E. Casarejos, R.F. Casten, J. Gerl, H.J. Wollersheim, J. Grebosz, G. Farrelly, M. Górska, I. Kojouharov, H. Schaffner, A. Algora, G. Benzoni, A. Blazhev, P. Boutachkov, A.M. Bruce, A.M. Denis Bacelar, I.J. Cullen, L. Cáceres, P. Doornenbal, M.E. Estevez, Y. Fujita, W. Gelletly, R. Hoischen, R. Kumar, N. Kurz, S. Lalkovski, Z. Liu, C. Mihai, F. Molina, A.I. Morales, D. Múcher, W. Prokopowicz, B. Rubio, Y. Shi, A. Tamii, S. Tashenov, J.J. Valiente-Dobón, P.M. Walker, P.J. Woods, F.R. Xu
2009An11	PRVCA	79,	064320	A.N. Andreyev, S. Antalic, D. Ackermann, L. Bianco, S. Franchoo, S. Heinz, F.P. Heßberger, S. Hofmann, M. Huyse, I. Kojouharov, B. Kindler, B. Lommel, R. Mann, K. Nishio, R.D. Page, J.J. Ressler, P. Sapple, B. Streicher, S. Saro, B. Sulignano, J. Thomson, P. Van Duppen, M. Venhart

2009An14	PRVCA	80,	024302	A.N. Andreyev, S. Antalic, D. Ackermann, T.E. Cocolios, V.F. Comas, J. El-seviers, S. Franchoo, S. Heinz, J.A. Heredia, F.P. Heßberger, S. Hofmann, M. Huyse, J. Khuyagbaatar, I. Kojouharov, B. Kindler, B. Lommel, R. Mann, R.D. Page, S. Rinta-Antila, P.J. Sapple, Š. Šáro, P. Van Duppen, M. Venhart, H.V. Watkins
2009An17	PRVCA	80,	044334	A.N. Andreyev, S. Antalic, D. Ackermann, T.E. Cocolios, V.F. Comas, J. El-seviers, S. Franchoo, S. Heinz, J.A. Heredia, F.P. Hessberger, S. Hofmann, M. Huyse, J. Khuyagbaatar, I. Kojouharov, B. Kindler, B. Lommel, R. Mann, R.D. Page, S. Rinta-Antila, P.J. Sapple, S. Saro, P. Van Duppen, M. Venhart, H.V. Watkins
2009An20	PRVCA	80,	054322	A.N. Andreyev, S. Antalic, D. Ackermann, T.E. Cocolios, V.F. Comas, J. El-seviers, S. Franchoo, S. Heinz, J.A. Heredia, F.P. Heßberger, S. Hofmann, M. Huyse, J. Khuyagbaatar, I. Kojouharov, B. Kindler, B. Lommel, R. Mann, R.D. Page, S. Rinta-Antilla, P.J. Sapple, S. Saro, P. Van Duppen, M. Venhart, H.V. Watkins
2009Ba04	PRVCA	79,	017302	F.C. Barker
2009Ba52	PRVCA	80,	054318	J.C. Batchelder, J.L. Wood, P.E. Garrett, K.L. Green, K.P. Rykaczewski, J.-C. Bilheux, C.R. Bingham, H.K. Carter, D. Fong, R. Grzywacz, J.H. Hamilton, D.J. Hartley, J.K. Hwang, W. Krolas, W.D. Kulp, Y. Larochelle, A. Piechaczek, A.V. Ramayya, E.H. Spejewski, D.W. Stracener, M.N. Tantawy, J.A. Winger, E.F. Zganjar
2009Bo.A	PrvCom	GAu	Aug	C. Borgmann
2009Br09	PRVCA	80,	035805	M. Breitenfeldt, G. Audi, D. Beck, K. Blaum, S. George, F. Herfurth, A. Herlert, A. Kellerbauer, H.-J. Kluge, M. Kowalska, D. Lunney, S. Naimi, D. Neidherr, H. Schatz, S. Schwarz, L. Schweikhard
2009Br10	PRVCA	80,	044318	M. Brodeur, T. Brunner, C. Champagne, S. Etterbauer, M. Smith, A. Lapierre, R. Ringle, V.L. Ryjkov, G. Audi, P. Delheij, D. Lunney, J. Dilling
2009Br.A	PrvCom	GAu	Jun	M. Brodeur
2009Bu.A	PrvCom	GAu	Mar	D. Bucurescu
2009Ce04	PRLTA	103,	152502	J. Cerny, D.M. Moltz, D.W. Lee, K. Peräjärvi, B.R. Barquest, L.E. Grossman, W. Jeong, C.C. Jewett
2009Ch08	PRLTA	102,	122503	L. Chen, Yu. A. Litvinov, W.R. Plaß, K. Beckert, P. Beller, F. Bosch, D. Boutin, L. Caceres, R.B. Cakirli, J.J. Carroll, R.F. Casten, R.S. Chakravarthy, D.M. Cullen, I.J. Cullen, B. Franzke, H. Geissel, J. Gerl, M. Górska, G.A. Jones, A. Kishada, R. Knöbel, C. Kozhuharov, S.A. Litvinov, Z. Liu, S. Mandal, F. Montes, G. Münzenberg, F. Nolden, T. Ohtsubo, Z. Patyk, Zs. Podolyák, R. Propri, S. Rigby, N. Saito, T. Saito, C. Scheidenberger, M. Shindo, M. Steck, P. Ugorowski, P.M. Walker, S. Williams, H. Weick, M. Winkler, H.-J. Wollersheim, T. Yamaguchi
2009Ch09	PYLBB	674,	23	F.C. Charlwood, K. Baczynska, J. Billowes, P. Campbell, B. Cheal, T. Eronen, D.H. Forest, A. Jokinen, T. Kessler, I.D. Moore, H. Penttilä, R. Powis, M. Ruffer, A. Saastamoinen, G. Tungate, J. Äystö
2009Cr02	PRVCA	79,	054320	H.L. Crawford, P.F. Mantica, J.S. Berryman, R. Broda, B. Fornal, C.R. Hoffman, N. Hoteling, R.V.F. Janssens, S.M. Lenzi, J. Pereira, J.B. Stoker, S.L. Tabor, W.B. Walters, X. Wang, S. Zhu
2009Cr03	APOBB	40,	481	H.L. Crawford, R.V.F. Janssens, P.F. Mantica, J.S. Berryman, R. Broda, M.P. Carpenter, B. Fornal, G.F. Grinyer, N. Hoteling, B. Kay, T. Lauritsen, K. Minamisono, I. Stefanescu, J.B. Stoker, W.B. Walters, S. Zhu
2009Cu02	PRVCA	80,	024303	D.M. Cullen, P.J.R. Mason, S.V. Rigby, C. Scholey, S. Eeckhaudt, T. Grahn, P.T. Greenlees, U. Jakobsson, P.M. Jones, R. Julin, S. Juutinen, S. Ketelhut, A.M. Kishada, M. Leino, A.-P. Leppanen, K. Mäntyniemi, P. Nieminen, M. Nyman, J. Pakarinen, P. Peura, P. Rahkila, J. Sarén, J. Sorri, J. Uusitalo, B.J. Varley, M. Venhart
2009Da03	NUPAB	818,	264	J.V. Dawson, C. Reeve, J.R. Wilson, K. Zuber, M. Junker, C. Gössling, T. Köttig, D. Münstermann, S. Rajek, O. Schulz
2009Dr02	PRVCA	79,	011602	I. Dragojević, K.E. Gregorich, Ch. E. Düllmann, J. Dvorak, P.A. Ellison, J.M. Gates, S.L. Nelson, L. Stavsetra, H. Nitsche
2009Dr04	PRVCA	79,	054313	G.D. Dracoulis, P.M. Davidson, G.J. Lane, A.P. Byrne, T. Kibédi, P. Nieminen, H. Watanabe, A.N. Wilson

2009Dr06	PRVCA	79,	061303	G.D. Dracoulis, G.J. Lane, F.G. Kondev, H. Watanabe, D. Seweryniak, S. Zhu, M.P. Carpenter, C.J. Chiara, R.V.F. Janssens, T. Lauritsen, C.J. Lister, E.A. McCutchan, I. Stefanescu
2009Dr08	EPJAA	40,	127	G.D. Dracoulis, P.M. Davidson, G.J. Lane, A.P. Byrne, T. Kibédi, P. Nieminen, A.N. Wilson, H. Watanabe
2009Dr12	PRVCA	80,	054320	G.D. Dracoulis, G.J. Lane, A.P. Byrne, P.M. Davidson, T. Kibédi, P.H. Nieminen, H. Watanabe, A.N. Wilson, H.L. Liu, F.R. Xu
2009E107	PRLTA	102,	252501	V.-V. Elomaa, G.K. Vorobjev, A. Kankainen, L. Batist, S. Eliseev, T. Eronen, J. Hakala, A. Jokinen, I.D. Moore, Yu. N. Novikov, H. Penttilä, A. Popov, S. Rahaman, J. Rissanen, A. Saastamoinen, H. Schatz, D.M. Seliverstov, C. Weber, J. Äystö
2009E108	EPJAA	40,	1	V.-V. Elomaa, T. Eronen, U. Hager, J. Hakala, A. Jokinen, A. Kankainen, I.D. Moore, S. Rahaman, J. Rissanen, V. Rubchenya, C. Weber, J. Äystö
2009Er02	PRVCA	79,	032802	T. Eronen, V.-V. Elomaa, U. Hager, J. Hakala, A. Jokinen, A. Kankainen, T. Kessler, I.D. Moore, S. Rahaman, J. Rissanen, C. Weber, J. Äystö
2009Er07	PRLTA	103,	252501	T. Eronen, V.-V. Elomaa, J. Hakala, J.C. Hardy, A. Jokinen, I.D. Moore, M. Reponen, J. Rissanen, A. Saastamoinen, C. Weber, J. Äystö
2009Fa15	EPJAA	42,	339	T. Faestermann, R. Hertenberg, H.-F. Wirth, R. Krücken, M. Mahgoub, P. Maier-Komor
2009Fa.A	PrvCom	GAu	Mar	T. Faestermann
2009Fo02	PRVCA	79,	027602	C.M. Folden III, I. Dragojevic, Ch. E. Düllmann, R. Eichler, M.A. Garcia, J.M. Gates, S.L. Nelson, R. Sudowe, K.E. Gregorich, D.C. Hoffman, H. Nitsche
2009Fo05	PRVCA	79,	064318	C.M. Folden III, A.S. Nettleton, A.M. Amthor, T.N. Ginter, M. Hausmann, T. Kubo, W. Loveland, S.L. Manikonda, D.J. Morrissey, T. Nakao, M. Portillo, B.M. Sherrill, G.A. Souliotis, B.F. Strong, H. Takeda, O.B. Tarasov
2009Fu05	EPJAA	39,	49	T. Fukuchi, T. Hori, T. Masue, K. Tajiri, A. Sato, T. Furukawa, A. Odahara, T. Shimoda, Y. Wakabayashi, Y. Gono, T. Suzuki, M. Ukai, T. Wakui, A. Yamazaki, Y. Miyashita, N. Sato, M. Tateoka, M. Ohguma, T. Shinozuka, T. Koike, K. Shirotori, Y. Miura, S. Kinoshita, Y. Ma, Y.Y. Fu, H. Tamura
2009Ga05	PRLTA	102,	092501	L. Gaudefroy, J.M. Daugas, M. Hass, S. Grevy, Ch. Stodel, J.C. Thomas, L. Perrot, M. Girod, B. Rosse, J.C. Angélique, D.L. Balabanski, E. Fiori, C. Force, G. Georgiev, D. Kameda, V. Kumar, R.L. Lozeva, I. Matea, V. Meot, P. Morel, B.S. Nara Singh, F. Nowacki, G. Simpson
2009Ga24	NUPAB	826,	1	C. Gaulard, C. Bachelet, G. Audi, C. Guénaut, D. Lunney, M. de Saint Simon, M. Sewtz, C. Thibault
2009Ga40	PRVCA	80,	064303	A.B. Garnsworthy, P.H. Regan, S. Pietri, Y. Sun, F.R. Xu, D. Rudolph, M. Górska, L. Cáceres, Zs. Podolyák, S.J. Steer, R. Hoischen, A. Heinz, F. Becker, P. Bednarczyk, P. Doornenbal, H. Geissel, J. Gerl, H. Grawe, J. Grebosz, A. Kelic, I. Kojouharov, N. Kurz, F. Montes, W. Prokopwicz, T. Saito, H. Schaffner, S. Tachenov, E. Werner-Malento, H.J. Wollersheim, G. Benzoni, B. Blank, C. Brandau, A.M. Bruce, F. Camera, W.N. Catford, I.J. Cullen, Zs. Dombrádi, E. Estevez, W. Gelletly, G. Ilie, J. Jolie, G.A. Jones, A. Jungclaus, M. Kmiecik, F.G. Kondev, T. Kurtukian-Nieto, S. Lalkovski, Z. Liu, A. Maj, S. Myalski, M. Pfützner, S. Schwertel, T. Shizuma, A.J. Simons, P.M. Walker, O. Wieland
2009Go16	PRVCA	79,	064314	M.B. Gomez Hornillos, D. O'Donnell, J. Simpson, D.T. Joss, L. Bianco, B. Cedervall, T. Grahn, P.T. Greenlees, B. Hadinia, P. Jones, R. Julin, S. Juutinen, S. Ketelhut, M. Labiche, M. Leino, M. Nyman, R.D. Page, E.S. Paul, M. Petri, P. Peura, P. Rakhila, P. Ruotsalainen, M. Sandzelius, P.J. Sapple, J. Saren, C. Scholey, J. Sorri, J. Thomson, J. Uusitalo
2009Go29	PRVCA	80,	045501	J.R. Goodwin, V.V. Golovko, V.E. Iacob, J.C. Hardy

2009Go40	PYLBB	672,	313	M. Górska, L. Cáceres, H. Grawe, M. Pfützner, A. Jungclaus, S. Pietri, E. Werner-Malento, Z. Podolyák, P.H. Regan, D. Rudolph, P. Detistov, S. Lalkovski, V. Modamio, J. Walker, T. Beck, P. Bednarczyk, P. Doornenbal, H. Geissel, J. Gerl, J. Grebosz, R. Hoischen, I. Kojouharov, N. Kurz, W. Prokopowicz, H. Schaffner, H. Weick, H.-J. Wollersheim, K. Andgren, J. Benlliure, G. Benzoni, A.M. Bruce, E. Casarejos, B. Cederwall, F.C.L. Crespi, B. Hadinia, M. Hellstrom, G. Ilie, A. Khaplanov, M. Kmiecik, R. Kumar, A. Maj, S. Mandal, F. Montes, S. Myalski, G.S. Simpson, S.J. Steer, S. Tashenov, O. Wieland, Zs. Dombrádi, P. Reiter, D. Sohler
2009Gu11	PRVCA	79,	054317	L. Gu, S.J. Zhu, J.H. Hamilton, A.V. Ramayya, J.K. Hwang, S.H. Liu, J.G. Wang, Y.X. Luo, J.O. Rasmussen, I.Y. Lee, X.L. Che, H.B. Ding, K. Li, Q. Xu, Y.Y. Yang, W.C. Ma
2009Gu17	PPNUE	40,	558	Yu. B. Gurov, S.V. Lapushkin, B.A. Chernyshev, V.G. Sandukovsky
2009Gy01	NUPAB	828,	1	Gy. Gyürky, G. Rastrepina, Z. Elekes, J. Farkas, Zs. Fülöp, G.G. Kiss, E. Somorjai, T. Szücs
2009Ha42	PRVCA	80,	064310	B. Hadinia, B. Cederwall, R.D. Page, M. Sandzelius, C. Scholey, K. Andgren, T. Bäck, E. Ganioglu, M.B. Gómez Hornillos, T. Grahn, P.T. Greenlees, E. Ideguchi, U. Jakobsson, A. Johnson, P.M. Jones, R. Julin, J. Juutinen, S. Ketelhut, A. Khaplanov, M. Leino, M. Niikura, M. Nyman, I. Özgür, E.S. Paul, P. Peura, P. Rakhila, J. Sarén, J. Sorri, J. Uusitalo, R. Wyss
2009Ha.B	NIMAE	606,	484	H. Hayashi, M. Shibata, I. Miyazaki, O. Suematsu, Y. Kojima, K. Kawade, A. Taniguchi
2009He20	EPJAA	41,	145	F.P. Heßberger, S. Hofmann, B. Streicher, B. Sulignano, S. Antalic, D. Ackermann, S. Heinz, B. Kindler, I. Kojouharov, P. Kuusiniemi, M. Leino, B. Lommel, R. Mann, A.G. Popeko, Š. Šáro, J. Uusitalo, A.V. Yeremin
2009He23	EPJAA	42,	333	R.-D. Herzberg, S. Moon, S. Eeckhaudt, P.T. Greenlees, P.A. Butler, T. Page, A.V. Afanasjev, N. Amzal, J.E. Bastin, F. Becker, M. Bender, B. Bruyneel, J.F.C. Cocks, I.G. Darby, O. Dorvaux, K. Eskola, J. Gerl, T. Grahn, C. Gray-Jones, N.J. Hammond, K. Hauschild, P.-H. Heenen, K. Helariutta, A. Herzberg, F. Hessberger, M. Houry, A. Hurstel, R.D. Humphreys, G.D. Jones, P.M. Jones, R. Julin, S. Juutinen, H. Kankaanpää, H. Kettunen, T.L. Khoo, W. Korten, P. Kuusiniemi, Y. LeCoz, M. Leino, A.-P. Leppänen, C.J. Lister, R. Lucas, M. Muikku, P. Nieminen, M. Nyman, R.D. Page, T. Page, J. Pakarinen, A. Pritchard, P. Rakhila, P. Reiter, M. Sandzelius, J. Saren, Ch. Schlegel, C. Scholey, Ch. Theisen, W.H. Trzaska, J. Uusitalo, A. Wiens, H.J. Wollersheim
2009In01	PRVCA	79,	034313	T.T. Inamura, H. Haba
2009Je05	PRVCA	80,	054303	D.G. Jenkins
2009Ka30	PRVCA	80,	045809	L.W. Kastens, S.B. Cahn, A. Manzur, D.N. McKinsey
2009Ke.A	PrvCom	GAu	Nov	J. Ketelaer
2009Ki14	PRVCA	80,	034315	H. Kikunaga, Y. Kasamatsu, H. Haba, T. Mitsugashira, M. Hara, K. Takamiya, T. Ohtsuki, A. Yokoyama, T. Nakanishi, A. Shinohara
2009Ko15	ARISE	67,	1702	K. Kossert, G. Jörg, O. Nähle, C. Lierse v Gostomski
2009Ko19	PRVCA	80,	014304	F.G. Kondev, G.D. Dracoulis, G.J. Lane, I. Ahmad, A.P. Byrne, M.P. Carpenter, P. Chowdhury, R.V.F. Janssens, T. Kibédi, T. Lauritsen, C.J. Lister, D. Seweryniak, S.K. Tandel, S. Zhu
2009Ko35	EPJAA	42,	351	M. Kowalska, S. Naimi, J. Agramunt, A. Algora, G. Audi, D. Beck, B. Blank, K. Blaum, Ch. Böhm, M. Breitenfeldt, E. Estevez, L.M. Fraile, S. George, F. Herfurth, A. Herlert, A. Kellerbauer, D. Lunney, E. Minaya-Ramirez, D. Neidherr, B. Olaizola, K. Riisager, M. Rosenbusch, B. Rubio, S. Schwarz, L. Schweikhard, U. Warring
2009Ku19	PRVCA	80,	035502	T. Kurtukian Nieto, J. Souin, T. Eronen, L. Audirac, J. Äystö, B. Blank, V.-V. Elomaa, J. Giovinazzo, U. Hager, J. Hakala, A. Jokinen, A. Kankainen, P. Karvonen, T. Kessler, I.D. Moore, H. Penttilä, S. Rahaman, M. Reponen, S. Rinta-Antila, J. Rissanen, A. Saastamoinen, T. Sonoda, C. Weber
2009Ku28	NUPAB	827,	587c	T. Kurtukian-Nieto, J. Benlliure, K.-H. Schmidt, L. Audouin, F. Becker, B. Blank, I.N. Borzov, E. Casarejos, M. Fernández-Ordóñez, J. Giovinazzo, D. Henzlova, B. Jurado, K. Langanke, G. Martínez-Pinedo, J. Pereira, F. Rejmund, O. Yordanov

2009Kw02	PRVCA	80,	051302	A.A. Kwiatkowski, B.R. Barquest, G. Bollen, C.M. Campbell, D.L. Lincoln, D.J. Morrissey, G.K. Pang, A.M. Prinke, J. Savory, S. Schwarz, C.M. Folden III, D. Melconian, S.K.L. Sjue, M. Block
2009La17	PRVCA	80,	024321	G.J. Lane, G.D. Dracoulis, A.P. Byrne, R.O. Hughes, H. Watanabe, F.G. Kondev, C.J. Chiara, M.P. Carpenter, R.V.F. Janssens, T. Lauritsen, C.J. Lister, E.A. McCutchan, D. Seweryniak, S. Zhu, P. Chowdhury, I. Stefanescu
2009Le02	PYLBB	672,	6	J.-L. Lecouey, N.A. Orr, F.M. Marqués, N.L. Achouri, J.-C. Angélique, B.A. Brown, F. Carstou, W.N. Catford, N.M. Clarke, M. Freer, B.R. Fulton, S. Grévy, F. Hanappe, K.L. Jones, M. Labiche, R.C. Lemmon, A. Ninane, E. Sauvan, K.M. Spohr, L. Stuttgé
2009Le03	PRVCA	79,	014318	A.I. Levon, G. Graw, Y. Eisermann, R. Hertenberger, J. Jolie, N. Yu. Shirikova, A.E. Stuchbery, A.V. Sushkov, P.G. Thirolf, H.-F. Wirth, N.V. Zamfir
2009Le26	PRVCA	80,	044308	M. Lebois, D. Verney, F. Ibrahim, S. Essabaa, F. Azaiez, M.C. Mhamed, E. Cottereau, P.V. Cuong, M. Ferraton, K. Flanagan, S. Franchoo, D. Guillemaud-Mueller, F. Hammache, C. Lau, F. Le Blanc, J.-F. Le Du, J. Libert, B. Mouginot, C. Petrache, B. Roussiere, L. Sagui, N. de Sereville, I. Stefan, B. Tastet
2009Le.A	PrvCom	GAu	May	A.I. Levon
2009Mo12	JUPSA	78,	064201	K. Morita, K. Morimoto, D. Kaji, H. Haba, K. Ozeki, Y. Kudou, N. Sato, T. Sumita, A. Yoneda, T. Ichikawa, Y. Fujimori, S. Goto, E. Ideguchi, Y. Kasamatsu, K. Katori, Y. Komori, H. Koura, H. Kudo, K. Ooe, A. Ozawa, F. Tokanai, K. Tsukada, T. Yamaguchi, A. Yoshida
2009Mo23	PRLTA	103,	122502	B.J. Mount, M. Redshaw, E.G. Myers
2009Mu17	EPJAA	42,	421	I. Mukha, For the S271 Collaboration
2009Na.A	PrvCom	GAu	Nov	S. Naimi
2009Ne03	PRLTA	102,	112501	D. Neidherr, G. Audi, D. Beck, K. Blaum, Ch. Böhm, M. Breitenfeldt, R.B. Cakirli, R.F. Casten, S. George, F. Herfurth, A. Herlert, A. Kellerbauer, M. Kowalska, D. Lunney, E. Minaya-Ramirez, S. Naimi, E. Noah, L. Penescu, M. Rosenbusch, S. Schwarz, L. Schweikhard, T. Stora
2009Ne11	PRVCA	80,	044323	D. Neidherr, R.B. Cakirli, G. Audi, D. Beck, K. Blaum, Ch. Böhm, M. Breitenfeldt, R.F. Casten, S. George, F. Herfurth, A. Herlert, A. Kellerbauer, M. Kowalska, D. Lunney, E. Minaya-Ramirez, S. Naimi, M. Rosenbusch, S. Schwarz, L. Schweikhard
2009Od01	PRVCA	79,	051304	D. O'Donnell, J. Simpson, C. Scholey, T. Back, P.T. Greenlees, U. Jakobsson, P. Jones, D.T. Joss, D.S. Judson, R. Julin, S. Juutinen, S. Ketelhut, M. Labiche, M. Leino, M. Nyman, R.D. Page, P. Peura, P. Rähkila, P. Ruotsalainen, M. Sandelius, P.J. Sappale, J. Saren, J. Thomson, J. Uusitalo, H.V. Watkins
2009Pa16	PRVCA	79,	044309	D. Pauwels, O. Ivanov, N. Bree, J. Buscher, T.E. Cocolios, M. Huyse, Yu. Kudryavtsev, R. Raabe, M. Sawicka, J. Van de Walle, P. Van Duppen, A. Korgul, I. Stefanescu, A.A. Hecht, N. Hoteling, A. Wöhr, W.B. Walters, R. Broda, B. Fornal, W. Krolas, T. Pawlat, J. Wrzesinski, M.P. Carpenter, R.V.F. Janssens, T. Lauritsen, D. Seweryniak, S. Zhu, J.R. Stone, X. Wang
2009Pa25	PRVCA	79,	064323	S. Pascu, Gh. Cata-Danil, D. Bucurescu, N. Marginean, N.V. Zamfir, G. Graw, A. Gollwitzer, D. Hofer, B.D. Valnion
2009Pa35	PRVCA	80,	034307	N. Patronis, H. De Witte, M. Gorska, M. Huyse, K. Kruglov, D. Pauwels, K. Van de Vel, P. Van Duppen, J. Van Roosbroeck, J.-C. Thomas, S. Franchoo, J. Cederkall, V.N. Fedoseyev, H. Fynbo, U. Georg, O. Jonsson, U. Köster, T. Matterna, L. Mathieu, O. Serot, L. Weissman, W.F. Mueller, V.I. Mishin, D. Fedorov
2009Pe06	PRVCA	79,	035806	J. Pereira, S. Hennrich, A. Aprahamian, O. Arndt, A. Becerril, T. Elliot, A. Estrade, D. Galaviz, R. Kessler, K.-L. Kratz, G. Lorusso, P.F. Mantica, M. Matos, P. Möller, F. Montes, B. Pfeiffer, H. Schatz, F. Schertz, L. Schnorrenberger, E. Smith, A. Stolz, M. Quinn, W.B. Walters, A. Wöhr
2009Pe31	EPJAA	42,	379	J. Perkowski, J. Andrzejewski, J. Srebrny, A.M. Bruce, Ch. Droste, E. Grodner, M. Kisielinski, A. Korman, M. Kowalczyk, J. Kownacki, A. Król, J. Marganec, J. Mierzejewski, T. Morek, K. Sobczak, W.H. Trzaska, M. Zielińska

2009Po01	PYLBB	672,	116	Zs. Podolyák, G.F. Farrelly, P.H. Regan, A.B. Garnsworthy, S.J. Steer, M. Gorska, J. Benlliure, E. Casarejos, S. Pietri, J. Gerl, H.J. Wollersheim, R. Kumar, F. Molina, A. Algora, N. Alkhomashi, G. Benzoni, A. Blazhev, P. Boutachkov, A.M. Bruce, L. Caceres, I.J. Cullen, A.M.D. Bacelar, P. Doornenbal, M.E. Estevez, Y. Fujita, W. Gelletly, H. Geissel, H. Grawe, J. Grebosz, R. Hoischen, I. Kojouharov, S. Lalkovski, Z. Liu, K.H. Maier, C. Mihai, D. Mucher, B. Rubio, H. Schaffner, A. Tamii, S. Tashenov, J.J. Valiente-Dobon, P.M. Walker, P.J. Woods
2009Po02	PRVCA	79,	031305	Zs. Podolyák, S.J. Steer, S. Pietri, F.R. Xu, H.L. Liu, P.H. Regan, D. Rudolph, A.B. Garnsworthy, R. Hoischen, M. Gorska, J. Gerl, H.J. Wollersheim, T. Kurtukian-Nieto, G. Benzoni, T. Shizuma, F. Becker, P. Bednarczyk, L. Caceres, P. Doornenbal, H. Geissel, J. Grebosz, A. Kelic, I. Kojouharov, N. Kurz, F. Montes, W. Prokopowicz, T. Saito, H. Schaffner, S. Tashenov, A. Heinz, M. Pfitzner, A. Jungclaus, D.L. Balabanski, C. Brandau, A.M. Bruce, W.N. Catford, I.J. Cullen, Zs. Dombradi, E. Estevez, W. Gelletly, G. Ilie, J. Jolie, G.A. Jones, M. Kmiecik, F.G. Kondev, R. Krucken, S. Lalkovski, Z. Liu, A. Maj, S. Myalski, S. Schwertel, P.M. Walker, E. Werner-Malento, O. Wieland
2009Qi04	PRVCA	79,	064319	J. Qian, A. Heinz, T.L. Khoo, R.V.F. Janssens, D. Peterson, D. Seweryniak, I. Ahmad, M. Asai, B.B. Back, M.P. Carpenter, A.B. Garnsworthy, J.P. Greene, A.A. Hecht, C.L. Jiang, F.G. Kondev, T. Lauritsen, C.J. Lister, A. Robinson, G. Savard, R. Scott, R. Vondrasek, X. Wang, R. Winkler, S. Zhu
2009Ra11	PRLTA	103,	042501	S. Rahaman, V.-V. Elomaa, T. Eronen, J. Hakala, A. Jokinen, A. Kankainen, J. Rissanen, J. Suhonen, C. Weber, J. Äystö
2009Ra33	PRVCA	80,	054307	R. Raabe, J. Buscher, J. Ponsaers, F. Aksouh, M. Huyse, O. Ivanov, S.R. Leshner, I. Mukha, D. Pauwels, M. Sawicka, D. Smirnov, I. Stefanescu, J. Van de Walle, P. Van Duppen, C. Angulo, J. Cabrera, N. de Sereville, I. Martel, A.M. Sanchez-Benitez, C. Aa. Diget
2009Re03	PRVAA	79,	012506	M. Redshaw, B.J. Mount, E.G. Myers
2009Re07	PRLTA	102,	212502	M. Redshaw, B.J. Mount, E.G. Myers, F.T. Avignone III
2009Re15	PRVAA	79,	012507	M. Redshaw, B.J. Mount, E.G. Myers
2009Ri03	PYLBB	675,	170	R. Ringle, M. Brodeur, T. Brunner, S. Ettenauer, M. Smith, A. Lapierre, V.L. Ryjkov, P. Delheij, G.W.F. Drake, J. Lassen, D. Lunney, J. Dilling
2009Ri12	PRVCA	80,	064321	R. Ringle, C. Bachelet, M. Block, G. Bollen, M. Facina, C.M. Folden III, C. Guénaut, A.A. Kwiatkowski, D.J. Morrissey, G.K. Pang, A.M. Prinke, J. Savory, P. Schury, S. Schwarz, C.S. Sumithrarachchi
2009Ru08	PRLTA	103,	072502	G. Rugel, T. Faestermann, K. Knie, G. Korschinek, M. Poutivtsev, D. Schumann, N. Kivel, I. Günther-Leopold, R. Weinreich, M. Wohlmuther
2009Sa09	EPJAA	39,	33	J. Sauvage, J. Genevey, B. Roussi�re, S. Franchoo, A.N. Andreyev, N. Barr�, J.-F. Clavelin, H. De Witte, D.V. Fedorov, V.N. Fedoseyev, L.M. Fraile, X. Grave, G. Huber, M. Huyse, H.B. Jeppesen, U. K�ster, P. Kunz, S.R. Leshner, B.A. Marsh, I. Mukha, J. Oms, M. Seliverstov, I. Stefanescu, K. Van de Vel, J. Van de Walle, P. Van Duppen, Yu. M. Volkov
2009Sa12	PRLTA	102,	132501	J. Savory, P. Schury, C. Bachelet, M. Block, G. Bollen, M. Facina, C.M. Folden III, C. Gu�naut, E. Kwan, A.A. Kwiatkowski, D.J. Morrissey, G.K. Pang, A. Prinke, R. Ringle, H. Schatz, S. Schwarz, C.S. Sumithrarachchi
2009Sa27	PRVCA	79,	064315	M. Sandzelius, E. Ganioglu, B. Cederwall, B. Hadinia, K. Andgren, T. Back, T. Grahn, P. Greenlees, U. Jakobsson, A. Johnson, P.M. Jones, R. Julin, S. Juutinen, S. Ketelhut, A. Khaplanov, M. Leino, M. Nyman, P. Peura, P. R�hkil�, J. Saren, C. Scholey, J. Uusitalo, R. Wyss
2009Sa38	PRVCA	80,	044330	A. Saastamoinen, T. Eronen, A. Jokinen, V.-V. Elomaa, J. Hakala, A. Kankainen, I.D. Moore, S. Rahaman, J. Rissanen, C. Weber, J. �yst�, L. Trache
2009Sc19	PRVCA	80,	025501	N.D. Scielzo, S. Caldwell, G. Savard, J.A. Clark, C.M. Deibel, J. Fallis, S. Gulick, D. Lascar, A.F. Levand, G. Li, J. Mintz, E.B. Norman, K.S. Sharma, M. Sternberg, T. Sun, J. Van Schelt
2009Se13	EPJAA	41,	315	M.D. Seliverstov, A.N. Andreyev, N. Barre, A.E. Barzakh, S. Dean, H. De Witte, D.V. Fedorov, V.N. Fedoseyev, L.M. Fraile, S. Franchoo, J. Genevey, G. Huber, M. Huyse, U. Koster, P. Kunz, S.R. Leshner, B.A. Marsh, I. Mukha, B. Roussi�re, J. Sauvage, I. Stefanescu, K. Van de Vel, P. Van Duppen, Yu. M. Volkov
2009Sh17	EPJAA	39,	263	T. Shizuma, T. Ishii, H. Makii, T. Hayakawa, M. Matsuda

2009Si21	PRVCA	80,	024304	G.S. Simpson, W. Urban, J. Genevey, R. Orlandi, J.A. Pinston, A. Scherillo, A.G. Smith, J.F. Smith, I. Ahmad, J.P. Greene
2009Si35	PRVCA	80,	064608	E.C. Simpson, J.A. Tostevin, Zs. Podolyák, P.H. Regan, S.J. Steer
2009St04	PRVCA	79,	015803	J.B. Stoker, P.F. Mantica, D. Bazin, A. Becerril, J.S. Berryman, H.L. Crawford, A. Estrade, C.J. Guess, G.W. Hitt, G. Lorusso, M. Matos, K. Minamisono, F. Montes, J. Pereira, G. Perdikakis, H. Schatz, K. Smith, R.G.T. Zegers
2009St16	IMPEE	18,	1002	S.J. Steer, Zs. Podolyák, S. Pietri, M. Górska, G.F. Farrelly, P.H. Regan, D. Rudolph, A.B. Garnsworthy, R. Hoischen, J. Gerl, H.J. Wollersheim, H. Grawe, K.H. Maier, F. Becker, P. Bednarczyk, L. Cáceres, P. Doornenbal, H. Geissel, J. Grebosz, A. Kelic, I. Kojouharov, N. Kurz, F. Montes, W. Prokopowicz, T. Saito, H. Schaffner, S. Tashenov, A. Heinz, T. Kurtukianieto, G. Benzoni, M. Pfützner, A. Jungclaus, D.L. Balabanski, C. Brandau, A. Brown, A.M. Bruce, W.N. Catford, I.J. Cullen, Zs. Dombrádi, M.E. Estevez, W. Gelletly, G. Ilie, J. Jolie, G.A. Jones, M. Kmiecik, F.G. Kondev, R. Krücken, S. Lalkovski, Z. Liu, A. Maj, S. Myalski, S. Schwertel, T. Shizuma, P.M. Walker, E. Werner-Malento, O. Wieland
2009St21	PRLTA	103,	132502	L. Stavsetra, K.E. Gregorich, J. Dvorak, P.A. Ellison, I. Dragojević, M.A. Garcia, H. Nitsche
2009St28	EPJAA	42,	407	I. Stefanescu, W.B. Walters, P.F. Mantica, B.A. Brown, A.D. Davies, A. Estrade, P.T. Hosmer, N. Hoteling, S.N. Liddick, W.D.M. Rae, T.J. Mertzimekis, F. Montes, A.C. Morton, W.F. Mueller, M. Ouellette, E. Pellegrini, P. Santi, D. Seweryniak, H. Schatz, J. Shergur, A. Stolz, J.R. Stone, B.E. Tomlin
2009Su14	PRLTA	103,	152503	D. Suzuki, H. Iwasaki, D. Beaumel, L. Nalpas, E. Pollacco, M. Assie, H. Baba, Y. Blumenfeld, N. De Sereville, A. Drouart, S. Franchoo, A. Gillibert, J. Guillot, F. Hammache, N. Keeley, V. Lapoux, F. Marechal, S. Michimasa, X. Mougeot, I. Mukha, H. Okamura, H. Otsu, A. Ramus, P. Roussel-Chomaz, H. Sakurai, J.-A. Scarpaci, O. Sorlin, I. Stefan, M. Takechi
2009Ta24	PRVCA	80,	034609	O.B. Tarasov, M. Portillo, A.M. Amthor, T. Baumann, D. Bazin, A. Gade, T.N. Ginter, M. Hausmann, N. Inabe, T. Kubo, D.J. Morrissey, A. Nettleton, J. Pereira, B.M. Sherrill, A. Stolz, M. Thoennessen
2009Ur04	PRVCA	80,	037301	W. Urban, J.A. Pinston, G.S. Simpson, A.G. Smith, J.F. Smith, T. Rząca-Urban, I. Ahmad
2009Wa02	PRVCA	79,	024306	H. Watanabe, G.J. Lane, G.D. Dracoulis, T. Kibédi, A.P. Byrne, P. Nieminen, R.O. Hughes, F.G. Kondev, M.P. Carpenter, R.V.F. Janssens, T. Lauritsen, D. Seweryniak, S. Zhu, P. Chowdhury, C.-B. Moon
2009Wa06	PRVCA	79,	044321	P.M. Walker, R.J. Wood, G.D. Dracoulis, T. Kibédi, R.A. Bark, A.M. Bruce, A.P. Byrne, P.M. Davidson, H.M. El-Masri, G.J. Lane, C. Moon, J.N. Orce, F.M. Prados Estevez, C. Wheldon, A.N. Wilson
2009Wa11	PRVCA	79,	064311	H. Watanabe, G.J. Lane, G.D. Dracoulis, A.P. Byrne, P. Nieminen, F.G. Kondev, K. Ogawa, M.P. Carpenter, R.V.F. Janssens, T. Lauritsen, D. Seweryniak, S. Zhu, P. Chowdhury
2009Wa24	EPJAA	42,	163	H. Watanabe, G.J. Lane, G.D. Dracoulis, A.P. Byrne, P. Nieminen, F.G. Kondev, K. Ogawa, M.P. Carpenter, R.V.F. Janssens, T. Lauritsen, D. Seweryniak, S. Zhu, P. Chowdhury
2009Wi03	PRLTA	102,	142502	J.A. Winger, S.V. Ilyushkin, K.P. Rykaczewski, C.J. Gross, J.C. Batchelder, C. Goodin, R. Grzywacz, J.H. Hamilton, A. Korgul, W. Krolas, S.N. Liddick, C. Mazzocchi, S. Padgett, A. Piechaczek, M.M. Rajabali, D. Shapira, E.F. Zganjar, I.N. Borzov
2009Wi09	PYLBB	679,	36	N. Winckler, H. Geissel, Yu. A. Litvinov, K. Beckert, F. Bosch, D. Boutin, C. Brandau, L. Chen, C. Dimopoulou, H.G. Essel, B. Fabian, T. Faestermann, A. Fagner, E. Haettner, S. Hess, P. Kienle, R. Knöbel, C. Kozuharov, S.A. Litvinov, M. Mazzocco, F. Montes, G. Münzenberg, C. Nociforo, F. Nolden, Z. Patyk, W.R. Plass, A. Prochazka, R. Reda, R. Reuschl, C. Scheidenberger, M. Steck, T. Stohlker, S. Yu. Torilov, M. Trassinelli, B. Sun, H. Weick, M. Winkler
2009Wi10	PRLTA	103,	122501	J.S.E. Wieslander, J. Suhonen, T. Eronen, M. Hult, V.-V. Elomaa, A. Jokinen, G. Marissens, M. Misiąszek, M.T. Mustonen, S. Rahaman, C. Weber, J. Äystö

2010Ac.A	AnRpt GSI			D. Ackermann et al
2010A124	PRVCA	82,	041602	H. Alvarez-Pol, J. Benlliure, E. Casarejos, L. Audouin, D. Cortina-Gil, T. Enqvist, B. Fernandez-Dominguez, A.R. Junghans, B. Jurado, P. Napolitani, J. Pereira, F. Rejmund, K.-H. Schmidt, O. Yordanov
2010An01	JPGPE	37,	035102	A.N. Andreyev, S. Antalic, D. Ackermann, T.E. Cocolios, V.F. Comas, J. Elseviers, S. Franchoo, S. Heinz, J.A. Heredia, F.P. Heßberger, S. Hofmann, M. Huyse, J. Khuyagbaatar, I. Kojouharov, B. Kindler, B. Lommel, R. Mann, R.D. Page, S. Rinta-Antila, P.J. Sapple, Š. Šáro, P. Van Duppen, M. Venhart, H.V. Watkins
2010An02	PRVCA	81,	011901	N.G. Antoniou, F.K. Diakonou, A.S. Kapoyannis
2010An08	EPJAA	43,	35	S. Antalic, F.P. Heßberger, S. Hofmann, D. Ackermann, S. Heinz, B. Kindler, I. Kojouharov, P. Kuusiniemi, M. Leino, B. Lommel, R. Mann, Š. Šáro
2010As.A	AnRpt JAEA		21	M. Asai, K. Tsukada, N. Sato, T.K. Sato, A. Toyoshima, T. Ishii, Y. Nagame (JAEA-Review 2010-056)
2010Ba43	PRVCA	82,	045501	G.C. Ball, G. Boisvert, P. Bricault, R. Churchman, M. Domsbys, T. Lindner, J.A. Macdonald, E. Vandervoort, S. Bishop, J.M. D'Auria, J.C. Hardy, V.E. Jacob, J.R. Leslie, H.-B. Mak
2010Ba48	NUPAB	847,	121	M. Balodis, I. Tomandl, V. Bondarenko, L. Simonova, T. Krasta, J. Bērziņš
2010Be16	PRVCA	81,	064325	J.S. Berryman, R.M. Clark, K.E. Gregorich, J.M. Allmond, D.L. Bleuel, M. Cromaz, I. Dragojević, J. Dvorak, P.A. Ellison, P. Fallon, M.A. Garcia, S. Gros, I.Y. Lee, A.O. Macchiavelli, H. Nitsche, S. Paschalis, M. Petri, J. Qian, M.A. Stoyer, M. Wiedeking
2010Bi03	PYLBB	690,	15	L. Bianco, R.D. Page, I.G. Darby, D.T. Joss, J. Simpson, J.S. Al-Khalili, A.J. Cannon, B. Cederwall, S. Eeckhaudt, S. Ertürk, B. Gall, M.B. Gómez Hornillos, T. Grahn, P.T. Greenlees, B. Hadinia, K. Heyde, U. Jakobsson, P.M. Jones, R. Julin, S. Juutinen, S. Ketelhut, M. Labiche, M. Leino, A.-P. Leppänen, M. Nyman, D. O'Donnell, E.S. Paul, M. Petri, P. Peura, A. Puurunen, P. Rahkila, P. Ruotsalainen, M. Sandzelius, P.J. Sapple, J. Sarén, C. Scholey, N.A. Smirnova, A.N. Steer, P.D. Stevenson, E.B. Suckling, J. Thomson, J. Uusitalo, M. Venhart
2010BI09	EPJAA	44,	363	B. Blank, C. Borcea, G. Canchel, C.-E. Demonchy, F. de Oliveira Santos, C. Dossat, J. Giovino, S. Grevy, L. Hay, P. Hellmuth, S. Leblanc, I. Matea, J.-L. Pedroza, L. Perrot, J. Pibernat, A. Rebi, L. Serani, J.C. Thomas
2010Bo.A	PrvCom	WgM	Sep	C. Boehm
2010Br02	PRVCA	81,	034313	M. Breitenfeldt, Ch. Borgmann, G. Audi, S. Baruah, D. Beck, K. Blaum, Ch. Böhm, R.B. Cakirli, R.F. Casten, P. Delahaye, M. Dworschak, S. George, F. Herfurth, A. Herlert, A. Kellerbauer, M. Kowalska, D. Lunney, E. Minaya-Ramirez, S. Naimi, D. Neidherr, M. Rosenbusch, R. Savreux, S. Schwarz, L. Schweikhard, C. Yazidjian
2010Ch19	PYLBB	691,	234	L. Chen, W.R. Plaß, H. Geissel, R. Knöbel, C. Kozuharov, Yu. A. Litvinov, Z. Patyk, C. Scheidenberger, K. Siegień-Iwaniuk, B. Sun, H. Weick, K. Beckert, P. Beller, F. Bosch, D. Boutin, L. Caceres, J.J. Carroll, D.M. Cullen, I.J. Cullen, B. Franzke, J. Gerl, M. Górska, G.A. Jones, A. Kishada, J. Kurcewicz, S.A. Litvinov, Z. Liu, S. Mandal, F. Montes, G. Müntenberg, F. Nolden, T. Ohtsubo, Zs. Podolyák, R. Propri, S. Rigby, N. Saito, T. Saito, M. Shindo, M. Steck, P. Ugorowski, P.M. Walker, S. Williams, M. Winkler, H.-J. Wollersheim, T. Yamaguchi
2010CI01	PYLBB	690,	19	R.M. Clark, K.E. Gregorich, J.S. Berryman, M.N. Ali, J.M. Allmond, C.W. Beausang, M. Cromaz, M.A. Deleplanque, I. Dragojevic, J. Dvorak, P.A. Ellison, P. Fallon, M.A. Garcia, J.M. Gates, S. Gros, H.B. Jeppesen, D. Kaji, I.Y. Lee, A.O. Macchiavelli, K. Morimoto, H. Nitsche, S. Paschalis, M. Petri, L. Stavsetra, F.S. Stephens, H. Watanabe, M. Wiedeking
2010Co13	JPGPE	37,	125130	T.E. Cocolios, A.N. Andreyev, S. Antalic, A. Barzakh, B. Bastin, J. Büscher, I.G. Darby, W. Dexters, D.V. Fedorov, V.N. Fedosseev, K.T. Flanagan, S. Franchoo, G. Huber, M. Huyse, M. Keupers, U. Köster, Yu. Kudryavtsev, E. Mane, B.A. Marsh, P. Molkanov, R.D. Page, M.D. Seliverstov, A.M. Sjoedin, I. Stefan, J. Van de Walle, P. Van Duppen, M. Venhart, S. Zemlyanov

2010Cr02	PRVCA	82,	014311	H.L. Crawford, R.V.F. Janssens, P.F. Mantica, J.S. Berryman, R. Broda, M.P. Carpenter, N. Cieplicka, B. Fornal, G.F. Grinyer, N. Hoteling, B.P. Kay, T. Lauritsen, K. Minamisono, I. Stefanescu, J.B. Stoker, W.B. Walters, S. Zhu
2010Da06	PRVCA	81,	034304	J.M. Daugas, T. Faul, H. Grawe, M. Pfützner, R. Grzywacz, M. Lewitowicz, N.L. Achouri, J.C. Angélique, D. Baiborodin, R. Béntida, R. Béraud, C. Borcea, C.R. Bingham, W.N. Catford, A. Emsallem, G. de France, K.L. Grzywacz, R.C. Lemmon, M.J. Lopez Jimenez, F. de Oliveira Santos, P.H. Regan, K. Rykaczewski, J.E. Sauvestre, M. Sawicka, M. Stanoiu
2010Da17	PRLTA	105,	162502	I.G. Darby, R.K. Grzywacz, J.C. Batchelder, C.R. Bingham, L. Cartegni, C.J. Gross, M. Hjorth-Jensen, D.T. Joss, S.N. Liddick, W. Nazarewicz, S. Padgett, R.D. Page, T. Papenbrock, M.M. Rajabali, J. Rotureau, K.P. Rykaczewski
2010De04	PRVCA	81,	024322	A.Y. Deo, Zs. Podolyák, P.M. Walker, A. Algora, B. Rubio, J. Agramunt, L.M. Fraile, N. Al-Dahan, N. Alkhomashi, J.A. Briz, E. Estevez, G. Farrelly, W. Gelletly, A. Herlert, U. Köster, A. Maira, S. Singla
2010Dr02	PRVCA	81,	054313	G.D. Dracoulis, G.J. Lane, F.G. Kondev, H. Watanabe, D. Seweryniak, S. Zhu, M.P. Carpenter, C.J. Chiara, R.V.F. Janssens, T. Lauritsen, C.J. Lister, E.A. McCutchan, I. Stefanescu
2010Dr05	PRVCA	82,	034317	G.D. Dracoulis, G.J. Lane, R.O. Hughes, F.G. Kondev, H. Watanabe, D. Seweryniak, S. Zhu, M.P. Carpenter, C.J. Chiara, R.V.F. Janssens, T. Lauritsen, C.J. Lister, E.A. McCutchan, I. Stefanescu, P. Chowdhury
2010Du06	PRLTA	104,	252701	Ch. E. Düllmann, M. Schädel, A. Yakushev, A. Türler, K. Eberhardt, J.V. Kratz, D. Ackermann, L.-L. Andersson, M. Block, W. Brühlle, J. Dvorak, H.G. Es-sel, P.A. Ellison, J. Even, J.M. Gates, A. Gorshkov, R. Graeger, K.E. Gregorich, W. Hartmann, R.-D. Herzberg, F.P. Heßberger, D. Hild, A. Hübner, E. Jäger, J. Khuyagbaatar, B. Kindler, J. Krier, N. Kurz, S. Lahiri, D. Liebe, B. Lommel, M. Maiti, H. Nitsche, J.P. Omtvedt, E. Parr, D. Rudolph, J. Runke, B. Schausten, E. Schimpf, A. Semchenkov, J. Steiner, P. Thörle-Pospiech, J. Uusitalo, M. Wegrzecki, N. Wiehl
2010Dw01	PRVCA	81,	064312	M. Dworschak, M. Block, D. Ackermann, G. Audi, K. Blaum, C. Droese, S. Eliseev, T. Fleckenstein, E. Haettner, F. Herfurth, F.P. Heßberger, S. Hofmann, J. Ketelaer, J. Ketter, H.-J. Kluge, G. Marx, M. Mazzocco, Yu. N. Novikov, W.R. Plaß, A. Popeko, S. Rahaman, D. Rodríguez, C. Scheidenberger, L. Schweikhard, P.G. Thirolf, G.K. Vorobyev, M. Wang, C. Weber
2010EI06	PRLTA	105,	182701	P.A. Ellison, K.E. Gregorich, J.S. Berryman, D.L. Bleuel, R.M. Clark, I. Dragojević, J. Dvorak, P. Fallon, C. Fineman-Sotomayor, J.M. Gates, O.R. Gothe, I.Y. Lee, W.D. Loveland, J.P. McLaughlin, S. Paschalis, M. Petri, J. Qian, L. Stavsetra, M. Wiedeking, H. Nitsche
2010EI11	PYLBB	693,	426	S. Eliseev, Ch. Böhm, D. Beck, K. Blaum, M. Breitenfeldt, V.N. Fedosseev, S. George, F. Herfurth, A. Herlert, H.-J. Kluge, M. Kowalska, D. Lunney, S. Naimi, D. Neidherr, Yu. N. Novikov, M. Rosenbusch, L. Schweikhard, S. Schwarz, M. Seliverstov, K. Zuber
2010Et01	PRVCA	81,	024314	S. Ettenauer, M. Brodeur, T. Brunner, A.T. Gallant, A. Lapierre, R. Ringle, M.R. Pearson, P. Delheij, J. Lassen, D. Lunney, J. Dilling
2010Fe01	PRVCA	81,	044318	R. Ferrer, M. Block, C. Bachelet, B.R. Barquest, G. Bollen, C.M. Campbell, M. Facina, C.M. Folden III, C.M. Folden, C. Guénaut, A.A. Kwiatkowski, D.L. Lincoln, D.J. Morrissey, G.K. Pang, A.M. Prinke, R. Ringle, J. Savory, P. Schury, S. Schwarz
2010FI01	PRVCA	82,	027309	X. Flechard, E. Lienard, O. Naviliat-Cuncic, D. Rodriguez, M.A.G. Alvarez, G. Ban, B. Carniol, D. Etasse, J.M. Fontbonne, A.M. Lallena, J. Praena
2010Ga04	ARISE	68,	1561	E. García-Torano, V. Peyrés Medina, M. Roteta Ibarra
2010Go16	PYLBB	692,	307	V.Z. Goldberg, B.T. Roeder, G.V. Rogachev, G.G. Chubarian, E.D. Johnson, C. Fu, A.A. Alharbi, M.L. Avila, A. Banu, M. McCleskey, J.P. Mitchell, E. Simmons, G. Tabacaru, L. Trache, R.E. Tribble
2010Gr04	PRVCA	81,	061601	R. Graeger, D. Ackermann, M. Chelnokov, V. Chepigin, Ch. E. Düllmann, J. Dvorak, J. Even, A. Gorshkov, F.P. Heßberger, D. Hild, A. Hübner, E. Jäger, J. Khuyagbaatar, B. Kindler, J.V. Kratz, J. Krier, A. Kuznetsov, B. Lommel, K. Nishio, H. Nitsche, J.P. Omtvedt, O. Petrushkin, D. Rudolph, J. Runke, F. Samadani, M. Schädel, B. Schausten, A. Türler, A. Yakushev, Q. Zhi

2010Ha04	PRVCA	81,	021302	C.C. Hall, E.M. Lunderberg, P.A. DeYoung, T. Baumann, D. Bazin, G. Blanchon, A. Bonaccorso, B.A. Brown, J. Brown, G. Christian, D.H. Denby, J. Finck, N. Frank, A. Gade, J. Hinnefeld, C.R. Hoffman, B. Luther, S. Mosby, W.A. Peters, A. Spyrou, M. Thoennessen
2010Ha.A	NIMAE	613,	79	H. Hayashi et al
2010He10	EPJAA	43,	55	F.P. Heßberger, S. Antalic, B. Sulignano, D. Ackermann, S. Heinz, S. Hofmann, B. Kindler, J. Khuyagbaatar, I. Kojouharov, P. Kuusiniemi, M. Leino, B. Lommel, R. Mann, K. Nishio, A.G. Popeko, Š. Šáro, B. Streicher, J. Uusitalo, M. Venhart, A.V. Yeremin
2010He11	EPJAA	43,	175	F.P. Heßberger, S. Antalic, D. Ackermann, S. Heinz, S. Hofmann, J. Khuyagbaatar, B. Kindler, I. Kojouharov, B. Lommel, R. Mann
2010He25	EPJAA	46,	337	J.A. Heredia, A.N. Andreyev, S. Antalic, S. Hofmann, D. Ackermann, V.F. Comas, S. Heinz, F.P. Heßberger, B. Kindler, J. Khuyagbaatar, B. Lommel, R. Mann
2010Ho12	PRVCA	82,	025806	P. Hosmer, H. Schatz, A. Aprahamian, O. Arndt, R.R.C. Clement, A. Estrade, K. Farouqi, K.-L. Kratz, S.N. Liddick, A.F. Lisetskiy, P.F. Mantica, P. Möller, W.F. Mueller, F. Montes, A.C. Morton, M. Ouellette, E. Pellegrini, J. Pereira, B. Pfeiffer, P. Reeder, P. Santi, M. Steiner, A. Stolz, B.E. Tomlin, W.B. Walters, A. Woehr
2010II01	PYLBB	687,	305	G. Ilie, G. Neyens, G.S. Simpson, J. Jolie, A. Blazhev, H. Grawe, R.L. Lozeva, N. Vermeulen, L. Atanasova, D.L. Balabanski, F. Becker, P. Bednarczyk, C. Brandau, L. Caceres, S.K. Chamoli, J.M. Daugas, P. Doornenbal, J. Gerl, M. Górska, J. Grebosz, M. Hass, M. Ionescu-Bujor, A. Jungclaus, M. Kmiecik, I. Kojouharov, N. Kurz, A. Maj, S. Mallion, O. Perru, M. Pfützner, Zs. Podolyák, W. Prokopowicz, M. De Rydt, T.R. Saito, H. Schaffner, K. Turzó, J. Walker, E. Werner-Malento, H.J. Wollersheim
2010Ja05	PRVCA	82,	044302	U. Jakobsson, J. Uusitalo, S. Juutinen, M. Leino, P. Nieminen, K. Andgren, B. Cederwall, P.T. Greenlees, B. Hadinia, P. Jones, R. Julin, S. Ketelhut, A. Khaplanov, M. Nyman, P. Peura, P. Rahkila, P. Ruotsalainen, M. Sandzelius, J. Sarén, C. Scholey, J. Sorri
2010Jo06	NUPAB	842,	15	H.T. Johansson, Yu. Aksyutina, T. Aumann, K. Boretzky, M.J.G. Borge, A. Chatillon, L.V. Chulkov, D. Cortina-Gil, U. Datta Pramanik, H. Emling, C. Forssén, H.O.U. Fynbo, H. Geissel, G. Ickert, B. Jonson, R. Kulesa, C. Langer, M. Lantz, T. LeBleis, K. Mahata, M. Meister, G. Münzenberg, T. Nilsson, G. Nyman, R. Palit, S. Paschalis, W. Prokopowicz, R. Reifarth, A. Richter, K. Riisager, G. Schrieder, H. Simon, K. Sümmerer, O. Tengblad, H. Weick, M.V. Zhukov
2010Jo07	NUPAB	847,	66	H.T. Johansson, Yu. Aksyutina, T. Aumann, K. Boretzky, M.J.G. Borge, A. Chatillon, L.V. Chulkov, D. Cortina-Gil, U. Datta Pramanik, H. Emling, C. Forssén, H.O.U. Fynbo, H. Geissel, G. Ickert, B. Jonson, R. Kulesa, C. Langer, M. Lantz, T. LeBleis, K. Mahata, M. Meister, G. Münzenberg, T. Nilsson, G. Nyman, R. Palit, S. Paschalis, W. Prokopowicz, R. Reifarth, A. Richter, K. Riisager, G. Schrieder, N.B. Shulgina, H. Simon, K. Sümmerer, O. Tengblad, H. Weick, M.V. Zhukov
2010Ka26	PRVCA	82,	034311	A. Kankainen, V.-V. Elomaa, T. Eronen, D. Gorelov, J. Hakala, A. Jokinen, T. Kessler, V.S. Kolhinen, I.D. Moore, S. Rahaman, M. Reponen, J. Rissanen, A. Saastamoinen, C. Weber, J. Äystö
2010Ka29	NUPAB	842,	1	D. Kanjilal, S. Bhattacharya, A. Goswami, R. Kshetri, R. Raut, S. Saha, R.K. Bhowmik, J. Gehlot, S. Muralithar, R.P. Singh, G. Jnaneswari, G. Mukherjee, B. Mukherjee
2010Ka30	PRVCA	82,	052501	A. Kankainen, T. Eronen, D. Gorelov, J. Hakala, A. Jokinen, V.S. Kolhinen, M. Reponen, J. Rissanen, A. Saastamoinen, V. Sonnenschein, J. Äystö
2010Ke09	EPJDD	58,	47	J. Ketelaer, T. Beyer, K. Blaum, M. Block, K. Eberhardt, F. Herfurth, C. Smorra, Sz. Nagy
2010Kh06	EPJAA	46,	59	J. Khuyagbaatar, F.P. Heßberger, S. Hofmann, D. Ackermann, V.S. Comas, S. Heinz, J.A. Heredia, B. Kindler, I. Kojouharov, B. Lommel, R. Mann, K. Nishio, A. Yakushev
2010Ko15	PYLBB	684,	17	V.S. Kolhinen, V.-V. Elomaa, T. Eronen, J. Hakala, A. Jokinen, M. Kortelainen, J. Suhonen, J. Äystö

2010Ko17	PYLBB	690,	245	Y. Kondo, T. Nakamura, Y. Satou, T. Matsumoto, N. Aoi, N. Endo, N. Fukuda, T. Gomi, Y. Hashimoto, M. Ishihara, S. Kawai, M. Kitayama, T. Kobayashi, Y. Matsuda, N. Matsui, T. Motobayashi, T. Nakabayashi, T. Okumura, H.J. Ong, T.K. Onishi, K. Ogata, H. Otsu, H. Sakurai, S. Shimoura, M. Shinohara, T. Sugimoto, S. Takeuchi, M. Tamaki, Y. Togano, Y. Yanagisawa
2010Ko28	PRVCA	82,	022501	V.S. Kolhinen, T. Eronen, D. Gorelov, J. Hakala, A. Jokinen, A. Kankainen, I.D. Moore, J. Rissanen, A. Saastamoinen, J. Suhonen, J. Äystö
2010Ku02	APOBB	41,	525	J. Kurcewicz, F. Bosch, H. Geissel, Yu. A. Litvinov, N. Winckler, K. Beckert, P. Beller, D. Boutin, C. Brandau, L. Chen, C. Dimopoulou, H.G. Essel, B. Fabian, T. Faestermann, A. Fragner, B. Franzke, E. Haettner, M. Hausmann, S. Hess, P. Kienle, R. Knöbel, C. Kozhuharov, S.A. Litvinov, L. Maier, M. Mazzocco, F. Montes, A. Musumarra, C. Nociforo, F. Nolden, Z. Patyk, W.R. Plass, A. Prochazka, R. Reda, R. Reuschl, C. Scheidenberger, M. Steck, T. Stohlker, B. Sun, K. Takahashi, S. Torilov, M. Trassinelli, H. Weick, M. Winkler
2010Kw02	PRVCA	81,	058501	A.A. Kwiatkowski, B.R. Barquest, G. Bollen, C.M. Campbell, R. Ferrer, A.E. Gehring, D.L. Lincoln, D.J. Morrissey, G.K. Pang, J. Savory, S. Schwarz
2010La16	PRVCA	82,	051304	G.J. Lane, G.D. Dracoulis, F.G. Kondev, R.O. Hughes, H. Watanabe, A.P. Byrne, M.P. Carpenter, C.J. Chiara, P. Chowdhury, R.V.F. Janssens, T. Lauritsen, C.J. Lister, E.A. McCutchan, D. Seweryniak, I. Stefanescu, S. Zhu
2010La.A	PrvCom	GAu	Mar	Alain Lapierre
2010Li13	PRVCA	81,	045803	W.H. Lippincott, S.B. Cahn, D. Gastler, L.W. Kastens, E. Kearns, D.N. McKinsey, J.A. Nikkel
2010Lo14	ARISE	68,	1454	M. Loidl, M. Rodrigues, B. Censier, S. Kowalski, X. Mougeot, P. Cassette, T. Branger, D. Lacour
2010Ma08	PRVCA	81,	024302	P.J.R. Mason, D.M. Cullen, C. Scholey, P.T. Greenlees, U. Jakobsson, P.M. Jones, R. Julin, S. Juutinen, S. Ketelhut, M. Leino, M. Nyman, P. Peura, A. Puurunen, P. Rahkila, P. Ruotsalainen, J. Sorri, J. Saren, J. Uusitalo, F.R. Xu
2010Ma20	PRVCA	81,	047301	F. Ma, X.H. Zhou, Y. Zheng, S.W. Xu, Y.X. Xie, L. Chen, X.G. Lei, Y.X. Guo, Y.H. Zhang, Z.K. Li, Y.H. Qiang, S. Guo, H.X. Wang, H.B. Zhou, B. Ding, G.S. Li, N.T. Zhang
2010Ma27	CPLLE	27,	062104	F. Ma, X.H. Zhou, Y. Zheng, S.W. Xu, Y.X. Xie, L. Chen, Y.H. Zhang, Z.K. Li, Y.H. Qiang, X.G. Lei, Y.X. Guo, S. Guo, B. Ding, H.X. Wang, G.S. Li, H.B. Zhou
2010Ma37	CPCHC	34,	1082	F. Ma, X.H. Zhou, Y. Zheng, S.W. Xu, Y.X. Xie, L. Chen, X.G. Lei, Y.X. Guo, Y.H. Zhang, Z.K. Li, S. Guo, B. Ding, H.B. Zhou, G.S. Li, H.X. Wang
2010Mc04	PRVCA	82,	024603	P.M. McCowan, R.C. Barber
2010Mi.A	PrvCom	WgM	Sep	E. Minaya
2010Mo03	PRVCA	81,	032501	B.J. Mount, M. Redshaw, E.G. Myers
2010Mo09	PRVCA	81,	054304	V. Modamio, A. Jungclaus, A. Algora, D. Bazzacco, D. Escrig, L.M. Fraile, S. Lenzi, N. Marginean, T. Martinez, D.R. Napoli, R. Schwengner, C.A. Ur
2010Mo29	PRVAA	81,	064501	B.J. Mount, H.S.P. Müller, M. Redshaw, E.G. Myers
2010Mo30	PRVAA	82,	042513	B.J. Mount, M. Redshaw, E.G. Myers
2010Mu12	PRVCA	82,	054315	I. Mukha, K. Sümmerer, L. Acosta, M.A.G. Alvarez, E. Casarejos, A. Chatillon, D. Cortina-Gil, I.A. Egorova, J.M. Espino, A. Fomichev, J.E. García-Ramos, H. Geissel, J. Gómez-Camacho, L. Grigorenko, J. Hofmann, O. Kiselev, A. Korshennikov, N. Kurz, Yu. A. Litvinov, E. Litvinova, I. Martel, C. Nociforo, W. Ott, M. Pfützner, C. Rodríguez-Tajes, E. Roeckl, M. Stanoiu, N.K. Timofeyuk, H. Weick, P.J. Woods
2010Mu13	PRVCA	82,	054316	G. Mukherjee, P. Chowdhury, F.G. Kondev, P.M. Walker, G.D. Dracoulis, R. D'Alarcao, I. Shestakova, K. Abu Saleem, I. Ahmad, M.P. Carpenter, A. Heinz, R.V.F. Janssens, T.L. Khoo, T. Lauritsen, C.J. Lister, D. Seweryniak, I. Wiedenhoever, D.M. Cullen, C. Wheldon, D.L. Balabanski, M. Danchev, T.M. Goon, D.J. Hartley, L.L. Riedinger, O. Zeidan, M.A. Riley, R.A. Kaye, G. Sletten
2010Na13	PRLTA	105,	032502	S. Naimi, G. Audi, D. Beck, K. Blaum, Ch. Böhm, Ch. Borgmann, M. Breitenfeldt, S. George, F. Herfurth, A. Herlert, M. Kowalska, S. Kreim, D. Lunney, D. Neidherr, M. Rosenbusch, S. Schwarz, L. Schweikhard, K. Zuber

- 2010Na17 PRVCA 82, 034323 F. Naqvi, M. Górska, L. Cáceres, A. Jungclaus, M. Pfützner, H. Grawe, F. Nowacki, K. Sieja, S. Pietri, E. Werner-Malento, P.H. Regan, D. Rudolf, Z. Podolyák, J. Jolie, K. Andgren, T. Beck, P. Bednarczyk, J. Benlliure, G. Benzoni, A.M. Bruce, E. Casarejos, B. Cederwall, F.C.L. Crespi, P. Detistov, Zs. Dombrádi, P. Doornenbal, H. Geissel, J. Gerl, J. Grebosz, B. Hadinia, M. Hellström, R. Hoischen, G. Ilie, A. Khaplanov, I. Kojouharov, M. Kmiecik, N. Kurz, S. Lalkovski, A. Maj, S. Mandal, V. Modamio, F. Montes, S. Myalski, W. Prokopowicz, P. Reiter, H. Schaffner, G. Simpson, D. Soehler, S.J. Steer, S. Tashenov, J. Walker, O. Wieland, H.J. Wollersheim
- 2010Ni10 PRVCA 81, 064606 E. Yu. Nikolskii, A.A. Korshennikov, H. Otsu, H. Suzuki, K. Yoneda, H. Baba, K. Yamada, Y. Kondo, N. Aoi, A.S. Denikin, M.S. Golovkov, A.S. Fomichev, S.A. Krupko, M. Kurokawa, E.A. Kuzmin, I. Martel, W. Mittig, T. Motobayashi, T. Nakamura, M. Niikura, S. Nishimura, A.A. Ogloblin, P. Roussel-Chomaz, A. Sanchez-Benitez, Y. Satou, S.I. Sidorchuk, T. Suda, S. Takeuchi, K. Tanaka, G.M. Ter-Akopian, Y. Togano, M. Yamaguchi
- 2010Ni14 PRVCA 82, 024611 K. Nishio, S. Hofmann, F.P. Heßberger, D. Ackermann, S. Antalic, Y. Aritomo, V.F. Comas, Ch. E. Düllmann, A. Gorshkov, R. Graeger, K. Hagino, S. Heinz, J.A. Heredia, K. Hirose, H. Ikezoe, J. Khuyagbaatar, B. Kindler, I. Kojouharov, B. Lommel, R. Mann, S. Mitsuoka, Y. Nagame, I. Nishinaka, T. Ohtsuki, A.G. Popeko, S. Saro, M. Schädel, A. Türler, Y. Watanabe, A. Yakushev, A.V. Yeremin
- 2010Og01 PRLTA 104, 142502 Yu. Ts. Oganessian, F. Sh. Abdullin, P.D. Bailey, D.E. Benker, M.E. Bennett, S.N. Dmitriev, J.G. Ezold, J.H. Hamilton, R.A. Henderson, M.G. Itkis, Yu. V. Lobanov, A.N. Mezentsev, K.J. Moody, S.L. Nelson, A.N. Polyakov, C.E. Porter, A.V. Ramayya, F.D. Riley, J.B. Roberto, M.A. Ryabinin, K.P. Rykaczewski, R.N. Sagaidak, D.A. Shaughnessy, I.V. Shirokovsky, M.A. Stoyer, V.G. Subbotin, R. Sudowe, A.M. Sukhov, Yu. S. Tsyganov, V.K. Utyonkov, A.A. Voinov, G.K. Vostokin, P.A. Wilk
- 2010Oh02 JUPSA 79, 073201 T. Ohnishi, T. Kubo, K. Kusaka, A. Yoshida, K. Yoshida, M. Ohtake, N. Fukuda, H. Takeda, D. Kameda, K. Tanaka, N. Inabe, Y. Yanagisawa, Y. Gono, H. Watanabe, H. Otsu, H. Baba, T. Ichihara, Y. Yamaguchi, M. Takechi, S. Nishimura, H. Ueno, A. Yoshimi, H. Sakurai, T. Motobayashi, T. Nakao, Y. Mizoi, M. Matsushita, K. Ieki, N. Kobayashi, K. Tanaka, Y. Kawada, N. Tanaka, S. Deguchi, Y. Satou, Y. Kondo, T. Nakamura, K. Yoshinaga, C. Ishii, H. Yoshii, Y. Miyashita, N. Uematsu, Y. Shiraki, T. Sumikama, J. Chiba, E. Ideguchi, A. Saito, T. Yamaguchi, I. Hachiuma, T. Suzuki, T. Moriguchi, A. Ozawa, T. Ohtsubo, M.A. Famiano, H. Geissel, A.S. Nettleton, O.B. Tarasov, D.P. Bazin, B.M. Sherrill, S.L. Manikonda, J.A. Nolen
- 2010Ra12 PRVCA 82, 011303 P. Rahkila, D.G. Jenkins, J. Pakarinen, C. Gray-Jones, P.T. Greenlees, U. Jakobsson, P. Jones, R. Julin, S. Juutinen, S. Ketelhut, H. Koivisto, M. Leino, P. Nieminen, M. Nyman, P. Papadakis, S. Paschalis, M. Petri, P. Peura, O.J. Roberts, T. Ropponen, P. Ruotsalainen, J. Saren, C. Scholey, J. Sorri, A.G. Tuff, J. Uusitalo, R. Wadsworth, M. Bender, P.-H. Heenen
- 2010Re01 PRVCA 81, 014301 J.J. Ressler, J.A. Caggiano, C.J. Francy, P.N. Peplowski, J.M. Allmond, C.W. Beausang, L.A. Bernstein, D.L. Bleuel, J.T. Burke, P. Fallon, A.A. Hecht, D.V. Jordan, S.R. Leshner, M.A. McMahan, T.S. Palmer, L. Phair, N.D. Scielzo, P.G. Swearingen, G.A. Warren, M. Wiedeking
- 2010Re07 PRLTA 105, 172501 M.W. Reed, I.J. Cullen, P.M. Walker, Yu. A. Litvinov, K. Blaum, F. Bosch, C. Brandau, J.J. Carroll, D.M. Cullen, A.Y. Deo, B. Detwiller, C. Dimopoulou, G.D. Dracoulis, F. Farinon, H. Geissel, E. Haettner, M. Heil, R.S. Kempley, R. Knöbel, C. Kozhuharov, J. Kurcewicz, N. Kuzminchuk, S. Litvinov, Z. Liu, R. Mao, C. Nociforo, F. Nolden, W.R. Plass, A. Prochazka, C. Scheidenberger, M. Steck, Th. Stöhlker, B. Sun, T.P.D. Swan, G. Trees, H. Weick, N. Winckler, M. Winkler, P.J. Woods, T. Yamaguchi
- 2010Ru07 EPJAA 44, 31 C. Rusu, D. Bucurescu, N. Marginean, M. Ionescu-Bujor, A. Iordachescu, G. Cata-Danil, I. Cata-Danil, D. Deleanu, D. Filipescu, D. Ghita, T. Glodariu, M. Ivascu, C. Mihai, R. Marginean, S. Pascu, T. Sava, L. Stroe, G. Suliman, N.V. Zamfir

2010Sc02	PRVCA	81,	014306	C. Scholey, K. Andgren, L. Bianco, B. Cederwall, I.G. Darby, S. Eeckhaudt, S. Ertürk, M.B. Gomez Hornillos, T. Grahn, P.T. Greenlees, B. Hadinia, E. Ideguchi, P. Jones, D.T. Joss, R. Julin, S. Juutinen, S. Ketelhut, M. Leino, A.-P. Leppänen, P. Nieminen, M. Niikura, M. Nyman, D. O'Donnell, R.D. Page, J. Pakarinen, P. Rahkila, J. Sarén, M. Sandzelius, J. Simpson, J. Sorri, J. Thomson, J. Uusitalo, M. Venhart
2010Se16	PRVCA	82,	067301	G.W. Severin, L.D. Knutson, P.A. Voytas, E.A. George
2010Si03	PRVCA	81,	024313	G.S. Simpson, W. Urban, J.A. Pinston, J.C. Angelique, I. Deloncle, H.R. Faust, J. Genevey, U. Köster, T. Materna, R. Orlandi, A. Scherillo, A.G. Smith, J.F. Smith, T. Rzaca-Urban, I. Ahmad, J.P. Greene
2010Sp02	PYLBB	683,	129	A. Spyrou, T. Baumann, D. Bazin, G. Blanchon, A. Bonaccorso, E. Breitbach, J. Brown, G. Christian, A. DeLine, P.A. DeYoung, J.E. Finck, N. Frank, S. Mosby, W.A. Peters, A. Russel, A. Schiller, M.J. Strongman, M. Thoennessen
2010St14	EPJAA	45,	275	B. Streicher, F.P. Heßberger, S. Antalic, S. Hofmann, D. Ackermann, S. Heinz, B. Kindler, J. Khuyagbaatar, I. Kojouharov, P. Kuusiniemi, M. Leino, B. Lommel, R. Mann, Š. Šáro, B. Sulignano, J. Uusitalo, M. Venhart
2010St.A	AnRpt GSI		151	K. Straub et al
2010Ta04	PRLTA	104,	062701	K. Tanaka, T. Yamaguchi, T. Suzuki, T. Ohtsubo, M. Fukuda, D. Nishimura, M. Takechi, K. Ogata, A. Ozawa, T. Izumikawa, T. Aiba, N. Aoi, H. Baba, Y. Hashizume, K. Inafuku, N. Iwasa, K. Kobayashi, M. Komuro, Y. Kondo, T. Kubo, M. Kurokawa, T. Matsuyama, S. Michimasa, T. Motobayashi, T. Nakabayashi, S. Nakajima, T. Nakamura, H. Sakurai, R. Shinoda, M. Shinohara, H. Suzuki, E. Takeshita, S. Takeuchi, Y. Togano, K. Yamada, T. Yasuno, M. Yoshitake
2010Vi07	PRVCA	82,	064311	P. Vingerhoets, K.T. Flanagan, M. Avgoulea, J. Billowes, M.L. Bissell, K. Blaum, B.A. Brown, B. Cheal, M. De Rydt, D.H. Forest, Ch. Geppert, M. Honma, M. Kowalska, J. Krämer, A. Krieger, E. Mané, R. Neugart, G. Neyens, W. Nörtershäuser, T. Otsuka, M. Schug, H.H. Stroke, G. Tungate, D.T. Yordanov
2010Wa42	PRVCA	82,	064317	F. Wauters, B. Verstichel, M. Breitenfeldt, V. De Leebeeck, V. Yu. Kozlov, I. Kraev, S. Roccia, G. Soti, M. Tandecki, E. Traykov, S. Van Gorp, D. Zakoucky, N. Severijns
2010Wi03	PRVCA	81,	044303	J.A. Winger, K.P. Rykaczewski, C.J. Gross, R. Grzywacz, J.C. Batchelder, C. Goodin, J.H. Hamilton, S.V. Ilyushkin, A. Korgul, W. Królas, S.N. Liddick, C. Mazzocchi, S. Padgett, A. Piechaczek, M.M. Rajabali, D. Shapira, E.F. Zganjar, J. Dobaczewski
2010Wr01	PRVCA	81,	055503	C. Wrede, J.A. Clark, C.M. Deibel, T. Faestermann, R. Hertenberger, A. Parikh, H.-F. Wirth, S. Bishop, A.A. Chen, K. Eppinger, A. García, R. Krücken, O. Lepyoshkina, G. Rugel, K. Setoodehnia and PrvCom WgM April 2011
2010Xu12	EPJAA	46,	55	S.W. Xu, Y.X. Xie, F. Ma, X.H. Zhou, Z.K. Li, Y. Zheng, L. Chen, X.G. Lei, Y.H. Zhang, H.L. Lui, F.R. Xu
				2011
2011Ac.A	AnRpt GSI		208	D. Ackermann, F.P. Heßberger, S. Antalic, M. Block, H.-G. Burkhard, V.F. Comas, P. Greenlees, S. Heinz, S. Hofmann, S. Ketelhut, J. Khuyagbaatar, B. Kindler, I. Kojouharov, M. Mazzocco, M. Leino, B. Lommel, R. Mann, J. Maurer, A.G. Popeko, J. Sorri, J. Uusitalo, A.V. Yeremin
2011An13	EPJAA	47,	62	S. Antalic, F.P. Heßberger, D. Ackermann, S. Heinz, S. Hofmann, Z. Kalaninova, B. Kindler, J. Khuyagbaatar, I. Kojouharov, P. Kuusiniemi, M. Leino, B. Lommel, R. Mann, K. Nishio, Š. Šáro, B. Streicher, B. Sulignano, M. Venhart
2011Ar18	PRVCA	84,	061307	O. Arndt, K.-L. Kratz, W.B. Walters, K. Farouqi, U. Köster, V. Fedosseev, S. Henrich, C.J. Jost, A. Wöhr, A.A. Hecht, B. Pfeiffer, J. Shergur, N. Hoteling
2011As03	PRVCA	83,	014315	M. Asai, K. Tsukada, H. Haba, Y. Ishii, T. Ichikawa, A. Toyoshima, T. Ishii, Y. Nagame, I. Nishinaka, Y. Kojima, K. Sueki
2011As08	PRLTA	107,	102502	P. Ascher, L. Audirac, N. Adimi, B. Blank, C. Borcea, B.A. Brown, I. Companis, F. Delalee, C.E. Demonchy, F. de Oliveira Santos, J. Giovinazzo, S. Grevy, L.V. Grigorenko, T. Kurtukian-Nieto, S. Leblanc, J.-L. Pedroza, L. Perrot, J. Pibernat, L. Serani, P.C. Srivastava, J.-C. Thomas

2011As.A	AnRpt RIKEN 44	-22	M. Asai, H. Haba, N. Sato, Y. Kasamatsu, D. Kaji, K. Morimoto, K. Morita
2011Ba14	PRVCA	83, 045503	A.S. Barabash, Ph. Hubert, Ch. Marquet, A. Nachab, S.I. Kononov, F. Perrot, F. Piquemal, V. Umatov
2011Be02	JPGPE	38, 015103	P. Belli, R. Bernabei, F. Cappella, R. Cerulli, F.A. Danevich, A. d'Angelo, A. Di Marco, A. Incicchitti, F. Nozzoli, V.I. Tretyak
2011Be34	PRVCA	84, 041303	A.D. Becerril, G. Lorusso, A.M. Amthor, T. Baumann, D. Bazin, J.S. Berryman, B.A. Brown, H.L. Crawford, A. Estrade, A. Gade, T. Ginter, C.J. Guess, M. Hausmann, G.W. Hitt, P.F. Mantica, M. Matos, R. Meharchand, K. Minamisono, F. Montes, G. Perdikakis, J. Pereira, M. Portillo, H. Schatz, K. Smith, J. Stoker, A. Stolz, R.G.T. Zegers
2011Be53	PACHA	83, 397	M. Berglund, M.E. Wieser
2011Bo09	NUPAB	856, 1	V. Bondarenko, I. Tomandl, J. Honzatko, H.-F. Wirth, T. von Egidy
2011Bo23	PRVCA	84, 044311	P. Boutachkov, M. Górska, H. Grawe, A. Blazhev, N. Braun, T.S. Brock, Z. Liu, B.S. Nara Singh, R. Wadsworth, S. Pietri, C. Domingo-Pardo, I. Kojouharov, L. Cáceres, T. Engert, F. Farinon, J. Gerl, N. Goel, J. Grbosz, R. Hoischen, N. Kurz, C. Nociforo, A. Prochazka, H. Schaffner, S.J. Steer, H. Weick, H.-J. Wollersheim, T. Faestermann, Zs. Podolyák, D. Rudolph, A. Atac, L. Bettermann, K. Eppinger, F. Finke, K. Geibel, A. Gottardo, C. Hinke, G. Ilie, H. Iwasaki, J. Jolie, R. Krücken, E. Merchán, J. Nyberg, M. Pfützner, P.H. Regan, P. Reiter, S. Rinta-Antila, C. Scholl, P.-A. Söderström, N. Warr, P.J. Woods, F. Nowacki, K. Sieja
2011Br01	PRVCA	82, 061309	T.S. Brock, for the RISING Collaboration
2011Br12	PRVCA	84, 014330	R. Broda, K.H. Maier, B. Fornal, J. Wrzesiński, B. Szpak, M.P. Carpenter, R.V.F. Janssens, W. Królas, T. Pawlat, S. Zhu
2011Ch16	CPLEE	28, 042101	F-Q. Chen, X.-R. Zhou
2011Ch32	PRVCA	84, 014320	R.J. Charity, J.M. Elson, J. Manfredi, R. Shane, L.G. Sobotka, B.A. Brown, Z. Chajecski, D. Coupland, H. Iwasaki, M. Kilburn, J. Lee, W.G. Lynch, A. Sanetullaev, M.B. Tsang, J. Winkelbauer, M. Youngs, S.T. Marley, D.V. Shetty, A.H. Wuosmaa, T.K. Ghosh, M.E. Howard
2011Ch.A	PrvCom	FGK	P. Chowdhury
2011Cu01	PRVCA	83, 014316	D.M. Cullen, P.J.R. Mason, C. Scholey, S. Eeckhaudt, T. Grahn, P.T. Greenlees, U. Jakobsson, P.M. Jones, R. Julin, S. Juutinen, S. Ketelhut, A.M. Kishada, M. Leino, A.-P. Leppänen, K. Mäntyniemi, P. Nieminen, M. Nyman, J. Pakarinen, P. Peura, M.G. Procter, P. Rahkila, S.V. Rigby, J. Sarén, J. Sorri, J. Uusitalo, B.J. Varley, M. Venhart
2011Da01	PYLBB	695, 78	I.G. Darby, R.D. Page, D.T. Joss, J. Simpson, L. Bianco, R.J. Cooper, S. Eeckhaudt, S. Ertürk, B. Gall, T. Grahn, P.T. Greenlees, B. Hadinia, P.M. Jones, D.S. Judson, R. Julin, S. Juutinen, S. Ketelhut, M. Leino, A.-P. Leppänen, M. Nyman, P. Rahkila, J. Saren, C. Scholey, A.N. Steer, J. Uusitalo, M. Venhart
2011Da08	PRVCA	83, 054312	J.M. Daugas, I. Matea, J.-P. Delaroche, M. Pfützner, M. Sawicka, F. Becker, G. Belier, C.R. Bingham, R. Borcea, E. Bouchez, A. Buta, E. Dragulescu, G. Georgiev, J. Giovanazzo, M. Girod, H. Grawe, R. Grzywacz, F. Hammache, F. Ibrahim, M. Lewitowicz, J. Libert, P. Mayet, V. Meot, F. Negoita, F. de Oliveira Santos, O. Perru, O. Roig, K. Rykaczewski, M.G. Saint-Laurent, J.E. Sauvestre, O. Sorlin, M. Stanoiu, I. Stefan, Ch. Stodel, Ch. Theisen, D. Verney, J. Zylicz
2011Da12	PRVCA	83, 064320	I.G. Darby, R.D. Page, D.T. Joss, L. Bianco, T. Grahn, D.S. Judson, J. Simpson, S. Eeckhaudt, P.T. Greenlees, P.M. Jones, R. Julin, S. Juutinen, S. Ketelhut, M. Leino, A.-P. Leppänen, M. Nyman, P. Rahkila, J. Sarén, C. Scholey, A.N. Steer, J. Uusitalo, M. Venhart, S. Ertürk, B. Gall, B. Hadinia
2011EI02	PRLTA	106, 052504	S. Eliseev, C. Roux, K. Blaum, M. Block, C. Droese, F. Herfurth, H.-J. Kluge, M.I. Krivoruchenko, Yu. N. Novikov, E. Minaya-Ramirez, L. Schweikhard, V.M. Shabaev, F. Simkovic, I.I. Tupitsyn, K. Zuber, N.A. Zubova
2011EI04	PRVCA	83, 038501	S. Eliseev, D. Nesterenko, K. Blaum, M. Block, C. Droese, F. Herfurth, E. Minaya-Ramirez, Yu. N. Novikov, L. Schweikhard, K. Zuber
2011EI05	PRVCA	84, 012501	S. Eliseev, M. Goncharov, K. Blaum, M. Block, C. Droese, F. Herfurth, E. Minaya-Ramirez, Yu. N. Novikov, L. Schweikhard, V.M. Shabaev, I.I. Tupitsyn, K. Zuber, N.A. Zubova

2011EI08	PRLTA	107,	152501	S. Eliseev, C. Roux, K. Blaum, M. Block, C. Droese, F. Herfurth, M. Kretzschmar, M.I. Krivoruchenko, E. Minaya-Ramirez, Yu. N. Novikov, L. Schweikhard, V.M. Shabaev, F. Simkovic, I.I. Tupitsyn, K. Zuber, N.A. Zubova
2011Er02	PRVCA	83,	055501	T. Eronen, D. Gorelov, J. Hakala, J.C. Hardy, A. Jokinen, A. Kankainen, V.S. Kolhinen, I.D. Moore, H. Penttilä, M. Reponen, J. Rissanen, A. Saastamoinen, J. Äystö two errata Phys. Rev. C 83(2011)069901 and Phys. Rev. C 84(2011)059905
2011Es03	PRVCA	84,	034304	M.E. Estevez Aguado, A. Algora, B. Rubio, J. Bernabeu, E. Nacher, J.L. Tain, A. Gadea, J. Agramunt, K. Burkard, W. Huller, J. Doring, R. Kirchner, I. Mukha, C. Plettner, E. Roeckl, H. Grawe, R. Collatz, M. Hellstrom, D. Cano-Ott, M. Karny, Z. Janas, M. Gierlik, A. Plochocki, K. Rykaczewski, L. Batist, F. Moroz, V. Wittman, A. Blazhev, J.J. Valiente, C. Espinoza
2011Es06	PRLTA	107,	172503	A. Estradé, M. Matoš, H. Schatz, A.M. Amthor, D. Bazin, M. Beard, A. Becerril, E.F. Brown, R. Cyburt, T. Elliot, A. Gade, D. Galaviz, S. George, S.S. Gupta, W.R. Hix, R. Lau, G. Lorusso, P. Möller, J. Pereira, M. Portillo, A.M. Rogers, D. Shapira, E. Smith, A. Stolz, M. Wallace, M. Wiescher
2011Fa10	PRVCA	84,	045807	J. Fallis, J.A. Clark, K.S. Sharma, G. Savard, F. Buchinger, S. Caldwell, A. Chaudhuri, J.E. Crawford, C.M. Deibel, S. Gulick, A.A. Hecht, D. Lascar, J.K.P. Lee, A.F. Levand, G. Li, B.F. Lundgren, A. Parikh, S. Russell, M. Scholtevan de Vorst, N.D. Scielzo, R.E. Segel, H. Sharma, S. Sinha, M.G. Sternberg, T. Sun, I. Tanihata, J. Van Schelt, J.C. Wang, Y. Wang, C. Wrede, Z. Zhou
2011Fo15	PRVCA	84,	054310	N. Fotiades, M. Devlin, R.O. Nelson, J.A. Cizewski, R. Krucken, R.M. Clark, P. Fallon, I.Y. Lee, A.O. Macchiavelli, W. Younes
2011Ga19	PRVCA	83,	054618	J.M. Gates, Ch. E. Düllmann, M. Schädel, A. Yakushev, A. Türler, K. Eberhardt, J.V. Kratz, D. Ackermann, L.-L. Andersson, M. Block, W. Bröchle, J. Dvorak, H.G. Essel, P.A. Ellison, J. Even, U. Forsberg, J. Gellanki, A. Gorshkov, R. Graeger, K.E. Gregorich, W. Hartmann, R.-D. Herzberg, F.P. Heßberger, D. Hild, A. Hübner, E. Jäger, J. Khuyagbaatar, B. Kindler, J. Krier, N. Kurz, S. Lahiri, D. Liebe, B. Lommel, M. Maiti, H. Nitsche, J.P. Omtvedt, E. Parr, D. Rudolph, J. Runke, H. Schaffner, B. Schausten, E. Schimpf, A. Semchenkov, J. Steiner, P. Thörle-Pospiech, J. Uusitalo, M. Wegrzecki, N. Wiehl
2011Go23	PRVCA	84,	028501	M. Goncharov, K. Blaum, M. Block, C. Droese, S. Eliseev, F. Herfurth, E. Minaya Ramirez, Yu. N. Novikov, L. Schweikhard, K. Zuber
2011Gr01	JPGPE	38,	015101	P. Granholm, T. Lönnroth, J. Suhonen, J. Bergman, K.-M. Källman, J.-O. Lill, M. Norrby, E. Ydrefors, P. Tikkanen
2011Ha08	PRLTA	106,	122501	E. Haettner, D. Ackermann, G. Audi, K. Blaum, M. Block, S. Eliseev, T. Fleckenstein, F. Herfurth, F.P. Heßberger, S. Hofmann, J. Ketelaer, J. Ketter, H.-J. Kluge, G. Marx, M. Mazzocco, Yu. N. Novikov, W.R. Plaß, S. Rahaman, T. Rauscher, D. Rodríguez, H. Schatz, C. Scheidenberger, L. Schweikhard, B. Sun, P.G. Thirolf, G. Vorobjev, M. Wang, C. Weber
2011Ha13	PRVCA	83,	034602	H. Haba, D. Kaji, H. Kikunaga, Y. Kudou, K. Morimoto, K. Morita, K. Ozeki, T. Sumita, A. Yoneda, Y. Kasamatsu, Y. Komori, K. Ooe, A. Shinohara
2011Ha48	EPJAA	47,	129	J. Hakala, R. Rodríguez-Guzmán, V.-V. Elomaa, T. Eronen, A. Jokinen, V.S. Kolhinen, I.D. Moore, H. Penttilä, M. Reponen, J. Rissanen, A. Saastamoinen, J. Äystö
2011He10	EPJAA	47,	75	F. Herfurth, G. Audi, D. Beck, K. Blaum, G. Bollen, P. Delahaye, M. Dworschak, S. George, C. Guénaut, A. Kellerbauer, D. Lunney, M. Mukherjee, S. Rahaman, S. Schwarz, L. Schweikhard, C. Weber, C. Yazidjian
2011Hi.A	P-Leuven		200	C. Hinke
2011Ho02	JPGPE	38,	035104	R. Hoischen, D. Rudolph, H.L. Ma, P. Montuenga, M. Hellström, S. Pietri, Zs. Podolyák, P.H. Regan, A.B. Garnsworthy, S.J. Steer, F. Becker, P. Bednarczyk, L. Cáceres, P. Doornenbal, J. Gerl, M. Górska, J. Grebosz, I. Kojouharov, N. Kurz, W. Prokopowicz, H. Schaffner, H.J. Wollersheim, L.-L. Andersson, L. Atanasova, D.L. Balabanski, M.A. Bentley, A. Blazhev, C. Brandau, J.R. Brown, C. Fahlander, E.K. Johansson, A. Jungclaus
2011Ke03	PRVCA	84,	014311	J. Ketelaer, G. Audi, T. Beyer, K. Blaum, M. Block, R.B. Cakirli, R.F. Casten, C. Droese, M. Dworschak, K. Eberhardt, M. Eibach, F. Herfurth, E. Minaya-Ramirez, Sz. Nagy, D. Neidherr, W. Nörtershäuser, C. Smorra, M. Wang

2011Ko01	ARISE	69,	500	K. Kossert, O. Nahle, P.E. Warwick, H. Wershofen, I.W. Croudace
2011Ko03	PYLBB	697,	116	V.S. Kolhinen, T. Eronen, D. Gorelov, J. Hakala, A. Jokinen, A. Kankainen, J. Rissanen, J. Suhonen, J. Äystö
2011Ko36	PRVCA	84,	034320	U. Köster, N.J. Stone, K.T. Flanagan, J. Rikowska Stone, V.N. Fedosseev, K.L. Kratz, B.A. Marsh, T. Materna, L. Mathieu, P.L. Molkanov, M.D. Seliverstov, O. Serot, A.M. Sjödin, Yu. M. Volkov
2011Ko.A	PrvCom	GAu	May	F.G. Kondev
2011Ko.B	PrvCom	GAu	Nov	F.G. Kondev
2011Kr.A	PrvCom	GAu	May	S. Kreim preliminary
2011Ku16	PRVCA	84,	044304	J. Kurpeta, W. Urban, A. Płochocki, J. Rissanen, J.A. Pinston, V.-V. Elomaa, T. Eronen, J. Hakala, A. Jokinen, A. Kankainen, P. Karvonon, I.D. Moore, H. Penttilä, A. Saastamoinen, C. Weber, J. Äystö
2011Li28	PYLBB	702,	24	Z. Liu, D. Seweryniak, P.J. Woods, C.N. Davids, M.P. Carpenter, T. Davinson, R.V.F. Janssens, R.D. Page, A.P. Robinson, J. Shergur, S. Sinha, X.D. Tang, F.R. Xu, S. Zhu
2011Li50	PRVCA	84,	061305	S.N. Liddick, S. Suchyta, B. Abromeit, A. Ayres, A. Bey, C.R. Bingham, M. Bolla, M.P. Carpenter, L. Cartegni, C.J. Chiara, H.L. Crawford, I.G. Darby, R. Grzywacz, G. Gurdal, S. Ilyushkin, N. Larson, M. Madurga, E.A. McCutchan, D. Miller, S. Padgett, S.V. Paulauskas, J. Pereira, M.M. Rajabali, K. Rykaczewski, S. Vinnikova, W.B. Walters, S. Zhu
2011Lo01	PYLBB	694,	316	R.L. Lozeva, D.L. Balabanski, G. Georgiev, J.-M. Daugas, S. Péru, G. Audi, S. Cabaret, T. Faul, M. Ferraton, E. Fiori, C. Gaulard, F. Ibrahim, P. Morel, L. Risehari, D. Verney, D.T. Yordanov
2011Lo06	NUPAB	852,	15	A. Lopez-Martens, T. Wiborg-Hagen, K. Hauschild, M.L. Chelnokov, V.I. Chepigin, D. Curien, O. Dorvaux, G. Drafta, B. Gall, A. Görgen, M. Guttormsen, A.V. Isaev, I.N. Izosimov, A.P. Kabachenko, D.E. Katrsev, T. Kutsarova, A.N. Kuznetsov, A.C. Larsen, O.N. Malyshev, A. Minkova, S. Mullins, H.T. Nyhus, D. Pantelica, J. Piot, A.G. Popeko, S. Saro, N. Scintee, S. Siem, N.U.H. Syed, E.A. Sokol, A.I. Svirikhin, A.V. Yeregin
2011Lo09	PYLBB	699,	141	G. Lorusso, A. Becerril, A. Amthor, T. Baumann, D. Bazin, J.S. Berryman, B.A. Brown, R.H. Cyburt, H.L. Crawford, A. Estrade, A. Gade, T. Ginter, C.J. Guess, M. Hausmann, G.W. Hitt, P.F. Mantica, M. Matos, R. Meharchand, K. Minamisono, F. Montes, G. Perdikakis, J. Pereira, M. Portillo, H. Schatz, K. Smith, J. Stoker, A. Stolz, R.G.T. Zegers
2011Lo.A	PrvCom	GAu	dec	A. Lopez-Martens
2011Ma45	PRVCA	84,	024303	E. Mané, B. Cheal, J. Billowes, M.L. Bissell, K. Blaum, F.C. Charwood, K.T. Flanagan, D.H. Forest, Ch. Geppert, M. Kowalska, A. Krieger, J. Krämer, I.D. Moore, R. Neugart, G. Neyens, W. Nörtershäuser, M.M. Rajabali, R. Sánchez, M. Schug, H.H. Stroke, P. Vingerhoets, D.T. Yordanov, M. Žáková
2011Mo27	KPSJA	59,	1525	C.-B. Moon, G.D. Dracoulis, R.A. Bark, A.P. Byrne, P.A. Davidson, T. Kibédi, G.J. Lane, A.N. Wilson
2011Na34	PRLTA	107,	172502	B.S. Nara Singh, Z. Liu, R. Wadsworth, H. Grawe, T.S. Brock, P. Boutachkov, N. Braun, A. Blazhev, M. Górska, S. Pietri, D. Rudolph, C. Domingo-Pardo, S.J. Steer, A. Atac, L. Bettermann, L. Cáceres, K. Eppinger, T. Engert, T. Faestermann, F. Farinon, F. Finke, K. Geibel, J. Gerl, R. Gernhäuser, N. Goel, A. Gottardo, J. Grebosz, C. Hinke, R. Hoischen, G. Ilie, H. Iwasaki, J. Jolie, A. Kaskas, I. Kojouharov, R. Krücken, N. Kurz, E. Méchan, C. Nociforo, J. Nyberg, M. Pfützner, A. Prochazka, Zs. Podolyák, P.H. Regan, P. Reiter, S. Rinta-Antila, C. Scholl, H. Schaffner, P.-A. Söderström, N. Warr, H. Weick, H.-J. Wollersheim, P.J. Woods, F. Nowacki, K. Sieja
2011Ni01	PRLTA	106,	052502	S. Nishimura, Z. Li, H. Watanabe, K. Yoshinaga, T. Sumikama, T. Tachibana, K. Yamaguchi, M. Kurata-Nishimura, G. Lorusso, Y. Miyashita, A. Odahara, H. Baba, J.S. Berryman, N. Blasi, A. Bracco, F. Camera, J. Chiba, P. Doornenbal, S. Go, T. Hashimoto, S. Hayakawa, C. Hinke, E. Ideguchi, T. Isobe, Y. Ito, D.G. Jenkins, Y. Kawada, N. Kobayashi, Y. Kondo, R. Krücken, S. Kubono, T. Nakano, H.J. Ong, S. Ota, Zs. Podolyák, H. Sakurai, H. Scheit, K. Steiger, D. Steppenbeck, K. Sugimoto, S. Takano, A. Takashima, K. Tajiri, T. Teranishi, Y. Wakabayashi, P.M. Walker, O. Wieland, H. Yamaguchi

2011Og04	PRVCA	83,	054315	Yu. Ts. Oganessian, F. Sh. Abdullin, P.D. Bailey, D.E. Benker, M.E. Bennett, S.N. Dmitriev, J.G. Ezold, J.H. Hamilton, R.A. Henderson, M.G. Itkis, Yu. V. Lobanov, A.N. Mezentsev, K.J. Moody, S.L. Nelson, A.N. Polyakov, C.E. Porter, A.V. Ramayya, F.D. Riley, J.B. Roberto, M.A. Ryabinin, K.P. Rykaczewski, R.N. Sagaidak, D.A. Shaughnessy, I.V. Shirokovsky, M.A. Stoyer, V.G. Subbotin, R. Sudowe, A.M. Sukhov, R. Taylor, Yu. S. Tsyganov, V.K. Utyonkov, A.A. Voinov, G.K. Vostokin, P.A. Wilk
2011Pa38	PRVCA	84,	065502	H.I. Park, J.C. Hardy, V.E. Jacob, A. Banu, L. Chen, V.V. Golovko, J. Goodwin, V. Horvat, N. Nica, E. Simmons, L. Trache, R.E. Tribble
2011Pa.A	P-Leuven		158	D. Pauwels, D. Radulov, I.G. Darby, H. De Witte, J. Diriken, D.V. Fedorov, V.N. Fedosseev, L.M. Fraile, M. Huyse, U. Köster, B.A. Marsh, L.-A. Popescu, M.D. Seliverstov, A.M. Sjoedin, P. Van den Bergh, J. Van de Walle, P. Van Duppen, M. Venhart, W.B. Walters, K. Wimmer
2011Pe29	PRVCA	84,	054311	A.B. Pérez-Cerdán, B. Rubio, W. Gelletly, A. Algora, J. Agramunt, K. Burkard, W. Hüller, E. Nácher, P. Sarriguren, L. Caballero, F. Molina, L.M. Fraile, E. Reillo, M.J.G. Borge, Ph. Dessagne, A. Jungclaus, M.-D. Salsac
2011Pi05	PRVCA	83,	044328	S. Pietri, A. Jungclaus, M. Górska, H. Grawe, M. Pfützner, L. Cáceres, P. Detistov, S. Lalkovski, V. Modamio, Z. Podolyák, P.H. Regan, D. Rudolph, J. Walker, E. Werner-Malento, P. Bednarczyk, P. Doornenbal, H. Geissel, J. Gerl, J. Gregosz, I. Kojouharov, N. Kurz, W. Prokopowicz, H. Schaffner, H.J. Wollersheim, K. Andgren, J. Benlliure, G. Benzoni, A.M. Bruce, E. Casarejos, B. Cederwall, F.C.L. Crespi, B. Hadinia, M. Hellström, R. Hoischen, G. Ilie, A. Khaplanov, M. Kmiecik, R. Kumar, A. Maj, S. Mandal, F. Montes, S. Myalski, G. Simpson, S.J. Steer, S. Tashenov, O. Wieland
2011Po01	PRVCA	83,	014306	M. Pomorski, K. Miernik, W. Dominik, Z. Janas, M. Pfützner, C.R. Bingham, H. Czyrkowski, M. Cwiok, I.G. Darby, R. Dabrowski, T. Ginter, R. Grzywacz, M. Karny, A. Korgul, W. Kuśmierz, S.N. Liddick, M. Rajabali, K. Rykaczewski, A. Stolz
2011Po07	ARISE	69,	1267	S. Pommé, J. Paepen, T. Altzitzoglou, R. Van Ammel, E. Yeltepe
2011Po09	PRVCA	83,	061306	M. Pomorski, M. Pfützner, W. Dominik, R. Grzywacz, T. Baumann, J.S. Berryman, H. Czyrkowski, R. Dabrowski, T. Ginter, J. Johnson, G. Kamiński, A. Kuźniak, N. Larson, S.N. Liddick, M. Madurga, C. Mazzocchi, S. Mi-anowski, K. Miernik, D. Miller, S. Paulauskas, J. Pereira, K.P. Rykaczewski, A. Stolz, S. Suchyta
2011Pr02	PRVCA	83,	034311	M.G. Procter, D.M. Cullen, C. Scholey, P.T. Greenlees, J. Hirvonen, U. Jakobsson, P. Jones, R. Julin, S. Juutinen, S. Ketelhut, M. Leino, N.M. Lumley, P.J.R. Mason, P. Nieminen, M. Nyman, P. Peura, P. Rakhila, J.-M. Regis, P. Ruot-salainen, J. Sarén, Y. Shi, J. Sorri, S. Stolze, J. Uusitalo, F.R. Xu
2011Ra24	PYLBB	703,	412	S. Rahaman, V.-V. Elomaa, T. Eronen, J. Hakala, A. Jokinen, A. Kankainen, J. Rissanen, J. Suhonen, C. Weber, J. Äystö
2011Ri01	PRVCA	83,	011301	J. Rissanen, J. Kurpeta, V.-V. Elomaa, T. Eronen, J. Hakala, A. Jokinen, I.D. Moore, P. Karvonen, A. Plochocki, L. Próchniak, H. Penttilä, S. Rahaman, M. Reponen, A. Saastamoinen, J. Szerypo, W. Urban, C. Weber, J. Äystö
2011Ri07	EPJAA	47,	97	J. Rissanen, J. Kurpeta, A. Plochocki, V.-V. Elomaa, T. Eronen, J. Hakala, A. Jokinen, A. Kankainen, P. Karvonen, I.D. Moore, H. Penttilä, S. Rahaman, A. Saastamoinen, W. Urban, C. Weber, J. Aysto
2011Ro18	PRLTA	106,	252503	A.M. Rogers, M.A. Famiano, W.G. Lynch, M.S. Wallace, F. Amorini, D. Bazin, R.J. Charity, F. Delaunay, R.T. de Souza, J. Elson, A. Gade, D. Galaviz, M.-J. van Goethem, S. Hudan, J. Lee, S. Lobastov, S. Lukyanov, M. Matoš, M. Mocko, H. Schatz, D. Shapira, L.G. Sobotka, M.B. Tsang, G. Verde
2011Ro47	PRVCA	84,	051306	A.M. Rogers, J. Giovinazzo, C.J. Lister, B. Blank, G. Cachel, J.A. Clark, G. de France, S. Grevy, S. Gros, E.A. McCutchan, F. de Oliveira Santos, G. Savard, D. Seweryniak, I. Stefan, J.-C. Thomas
2011Ru.A	P-Leuven		367	M. Rudigier, A. Blazhev, J. Jolie, J.M. Regis, N. Warr, C. Fransen, T. Materna, U. Köster, G. Simpson, M. Hackstein, M. Pfeiffer, T. Thomas
2011Sa41	JUPSA	80,	094201	N. Sato, H. Haba, T. Ichikawa, D. Kaji, Y. Kudou, K. Morimoto, K. Morita, K. Ozeki, T. Sumita, A. Yoneda, E. Ideguchi, H. Koura, A. Ozawa, T. Shinozuka, T. Yamaguchi, A. Yoshida

2011Sa59	PRVCA	84,	054303	P.J. Sapple, R.D. Page, D.T. Joss, L. Bianco, T. Grahn, J. Pakarinen, J. Thomson, J. Simpson, D. O'Donnell, S. Ertürk, P.T. Greenlees, U. Jakobsson, P.M. Jones, R. Julin, S. Juutinen, S. Ketelhut, M. Leino, M. Nyman, P. Peura, A. Puurunen, P. Rahkila, P. Ruotsalainen, J. Saren, C. Scholey, J. Uusitalo
2011Si32	JPCSD	267,	012031	G.S. Simpson, A. Scherillo, J. Genevey, R. Orlandi, J.A. Pinston, I.S. Tsekhanovich, N. Warr, A. Covello, A. Gargano
2011So11	EPJAA	47,	40	J. Souin, T. Eronen, P. Ascher, L. Audirac, J. Äystö, B. Blank, V.-V. Elomaa, J. Giovinazzo, J. Hakala, A. Jokinen, V.S. Kolhinen, P. Karvonen, I.D. Moore, S. Rahaman, J. Rissanen, A. Saastamoinen, J.C. Thomas
2011St21	PRVCA	84,	044313	S.J. Steer, Zs. Podolyák, S. Pietri, M. Górská, H. Grawe, K.H. Maier, P.H. Regan, D. Rudolph, A.B. Garnsworthy, R. Hoischen, J. Gerl, H.J. Wollersheim, F. Becker, P. Bednarczyk, L. Cáceres, P. Doornenbal, H. Geissel, J. Grebosz, A. Kelic, I. Kojouharov, N. Kurz, F. Montes, W. Prokopwicz, T. Saito, H. Schaffner, S. Tashenov, A. Heinz, M. Pfützner, T. Kurtukian-Nieto, G. Benzoni, A. Jungclaus, D.L. Balabanski, M. Bowry, C. Brandau, A. Brown, A.M. Bruce, W.N. Catford, I.J. Cullen, Zs. Dombrádi, M.E. Estevez, W. Gelletly, G. Ilie, J. Jolie, G.A. Jones, M. Kmiecik, F.G. Kondev, R. Krücken, S. Lalkowski, Z. Liu, A. Maj, S. Myalski, S. Schwertel, T. Shizuma, P.M. Walker, E. Werner-Malento, O. Wieland
2011Su11	PRLTA	106,	202501	T. Sumikama, K. Yoshinaga, H. Watanabe, S. Nishimura, Y. Miyashita, K. Yamaguchi, K. Sugimoto, J. Chiba, Z. Li, H. Baba, J.S. Berryman, N. Blasi, A. Bracco, F. Camera, P. Doornenbal, S. Go, T. Hashimoto, S. Hayakawa, C. Hinke, E. Ideguchi, T. Isobe, Y. Ito, D.G. Jenkins, Y. Kawada, N. Kobayashi, Y. Kondo, R. Krucken, S. Kubono, G. Lorusso, T. Nakano, M. Kurata-Nishimura, A. Odahara, H.J. Ong, S. Ota, Zs. Podolyák, H. Sakurai, H. Scheit, K. Steiger, D. Steppenbeck, S. Takano, A. Takashima, K. Tajiri, T. Teranishi, Y. Wakabayashi, P.M. Walker, O. Wieland, H. Yamaguchi
2011Sw02	PRVCA	83,	034322	T.P.D. Swan, P.M. Walker, Zs. Podolyák, M.W. Reed, G.D. Dracoulis, G.J. Lane, T. Kibédi, M.L. Smith
2011Sz01	PRVCA	83,	064315	B. Szpak, K.H. Maier, A.S. Smolkowska, B. Fornal, R. Broda, M.P. Carpenter, N. Cieplicka, R.V.F. Janssens, W. Królas, T. Pawlat, J. Wrzesinski, S. Zhu
2011Ti10	PRVCA	84,	044302	J. Timar, K. Starosta, I. Kuti, D. Sohler, D.B. Fossan, T. Koike, E.S. Paul, A.J. Boston, H.J. Chantler, M. Descovich, R.M. Clark, M. Cromaz, P. Fallon, I.Y. Lee, A.O. Macchiavelli, C.J. Chiara, R. Wadsworth, A.A. Hecht, D. Almedhed, S. Frauendorf
2011To04	PRVCA	83,	044326	I. Tomandl, J. Honzatko, T. von Egidy, H.-F. Wirth, T. Faestermann, V. Yu. Ponomarev, S. Pasic, R. Hertenberger, Y. Eisermann, G. Graw
2011To.A	PrvCom	GAu	Aug	I. Towner, S. Effenauer
2011Tu02	PRLTA	106,	112501	X.L. Tu, H.S. Xu, M. Wang, Y.H. Zhang, Yu. A. Litvinov, Y. Sun, H. Schatz, X.H. Zhou, Y.J. Yuan, J.W. Xia, G. Audi, K. Blaum, C.M. Du, P. Geng, Z.G. Hu, W.X. Huang, S.L. Jin, L.X. Liu, Y. Liu, X. Ma, R.S. Mao, B. Mei, P. Shuai, Z.Y. Sun, H. Suzuki, S.W. Tang, J.S. Wang, S.T. Wang, G.Q. Xiao, X. Xu, T. Yamaguchi, Y. Yamaguchi, X.L. Yan, J.C. Yang, R.P. Ye, Y.D. Zang, H.W. Zhao, T.C. Zhao, X.Y. Zhang, W.L. Zhan
2011Tu09	NIMAE	654,	213	X.L. Tu, M. Wang, Yu. A. Litvinov, Y.H. Zhang, H.S. Xu, Z.Y. Sun, G. Audi, K. Blaum, C.M. Du, W.X. Huang, Z.G. Hu, P. Geng, S.L. Jin, L.X. Liu, Y. Liu, B. Mei, R.S. Mao, X.W. Ma, H. Suzuki, P. Shuai, Y. Sun, S.W. Tang, J.S. Wang, S.T. Wang, G.Q. Xiao, X. Xu, J.W. Xia, J.C. Yang, R.P. Ye, T. Yamaguchi, X.L. Yan, Y.J. Yuan, Y. Yamaguchi, Y.D. Zang, H.W. Zhao, T.C. Zhao, X.Y. Zhang, X.H. Zhou, W.L. Zhan
2011Va02	ARISE	69,	785	R. Van Ammel, S. Pomme, J. Paepen, G. Sibbens
2011Ve01	PYLBB	695,	82	M. Venhart, A.N. Andreyev, J.L. Wood, S. Antalic, L. Bianco, P.T. Greenlees, U. Jakobsson, P. Jones, R. Julin, S. Juutinen, S. Ketelhut, M. Leino, M. Nyman, R.D. Page, P. Peura, P. Rahkila, J. Sarén, C. Scholey, J. Sorri, J. Thomson, J. Uusitalo
2011Ve.A	PrvCom	FGK	Jan	Martin Venhart

2011Wa03	PYLBB	696,	186	H. Watanabe, T. Sumikama, S. Nishimura, K. Yoshinaga, Z. Li, Y. Miyashita, K. Yamaguchi, H. Baba, J.S. Berryman, N. Blasi, A. Bracco, F. Camera, J. Chiba, P. Doornenbal, S. Go, T. Hashimoto, S. Hayakawa, C. Hinke, E. Ideguchi, T. Isobe, Y. Ito, D.G. Jenkins, Y. Kawada, N. Kobayashi, Y. Kondo, R. Krucken, S. Kubono, G. Lorusso, T. Nakano, M. Kurata-Nishimura, A. Odahara, H.J. Ong, S. Ota, Zs. Podolyák, H. Sakurai, H. Scheit, Y. Shi, K. Steiger, D. Steppenbeck, K. Sugimoto, K. Tajiri, S. Takano, A. Takashima, T. Teranishi, Y. Wakabayashi, P.M. Walker, O. Wieland, F.R. Xu, H. Yamaguchi
2011Wi09	PRVCA	84,	014329	K. Wimmer, U. Köster, P. Hoff, Th. Kröll, R. Krücken, R. Lutter, H. Mach, Th. Morgan, S. Sarkar, M. Saha Sarkar, W. Schwerdtfeger, P.C. Srivastava, P.G. Thirolf, P. Van Isacker
2011Ya25	PYLBB	697,	90	M.T. Yamashita, R.S. Marques de Carvalho, T. Frederico, L. Tomio
2012				
2012A105	PRVCA	85,	034301	N. Al-Dahan, P.H. Regan, Zs. Podolyák, P.M. Walker, N. Alkhamashi, G.D. Dracoulis, G. Farrelly, J. Benlliure, S.B. Pietri, R.F. Casten, P.D. Stevenson, W. Gelletly, S.J. Steer, A.B. Garnsworthy, E. Casarejos, J. Gerl, H.J. Wollersheim, J. Grebosz, M. Górska, I. Kojouharov, H. Schaffner, A. Algora, G. Benzoni, A. Blazhev, P. Boutachkov, A.M. Bruce, I.J. Cullen, A.M.D. Bacelar, A.Y. Deo, M.E. Estevez, Y. Fujita, R. Hoischen, R. Kumar, S. Lalkovski, Z. Liu, P.J. Mason, C. Mihai, F. Molina, D. Múcher, B. Rubio, A. Tamii, S. Tashenov, J.J. Valiente-Dobón, P.J. Woods and Pub. Note PRVCA 85, 039904
2012An08	ARISE	70,	1985	E. Andreotti, M. Hult, G. Marissens, R. Gonzalez de Orduna, P. Vermaercke
2012Ar05	ZETF	95,	224	S.S. Arzumanov, L.N. Bondarenko, V.I. Morozov, Yu. N. Panin and S.M. Chernyavsky
2012As05	PRVCA	85,	054316	A. Astier, M.-G. Porquet, Ch. Theisen, D. Verney, I. Deloncle, M. Houry, R. Lucas, F. Azaiez, G. Barreau, D. Curien, O. Dorvaux, G. Duchene, B.J.P. Gall, N. Redon, M. Rousseau, O. Stézowski
2012As06	PRVCA	85,	064316	A. Astier, M.-G. Porquet, Ts. Venkova, D. Verney, Ch. Theisen, G. Duchêne, F. Azaiez, G. Barreau, D. Curien, I. Deloncle, O. Dorvaux, B.J.P. Gall, M. Houry, R. Lucas, N. Redon, M. Rousseau, O. Stézowski
2012At01	EPJAA	48,	22	D.R. Atanasov, N. Winckler, D. Balabanski, L. Batist, F. Bosch, D. Boutin, C. Brandau, C. Dimopoulou, H.G. Essel, T. Faestermann, H. Geissel, I. Hachi-uma, S. Hess, T. Izumikawa, P. Kienle, R. Knöbel, C. Kozhuharov, J. Kurcewicz, N. Kuzminchuk, S.A. Litvinov, Yu. A. Litvinov, R.S. Mao, R. Märtin, M. Mazzocco, G. Münzenberg, K. Namihira, F. Nolden, T. Ohtsubo, Z. Patyk, R. Reuschl, M.S. Sanjari, C. Scheidenberger, D. Shubina, U. Spillmann, M. Steck, Th. Stöhlker, B. Sun, T. Suzuki, M. Trassinelli, I.I. Tupitsyn, H. Weick, M. Winkler, D.F.A. Winters, T. Yamaguchi
2012Au03	PRLTA	109,	032505	M. Auger, for the EXO Collaboration
2012Au08	EPJAA	48,	179	L. Audirac, P. Ascher, B. Blank, C. Borcea, B.A. Brown, G. Canchel, C.E. Demonchy, F. de Oliveira Santos, C. Dossat, J. Giovinozzo, S. Grévy, L. Hay, J. Huikari, S. Leblanc, I. Matea, J.-L. Pedroza, L. Perrot, J. Pibernat, L. Serani, C. Stodel, J.-C. Thomas
2012Ba58	PRVCA	86,	064311	J.C. Batchelder, N.T. Brewer, R.E. Goans, R. Grzywacz, B.O. Griffith, C. Jost, A. Korgul, S.H. Liu, S.V. Paulauskas, E.H. Spejewski, D.W. Stracener
2012Be04	ARISE	70,	1849	M.-M. Bé, P. Cassette, M.C. Lépy, M.-N. Amiot, K. Kossert, O.J. Nähle, O. Ott, C. Wanke, P. Dryak, G. Ratel, M. Sahagia, A. Luca, A. Antohe, L. Johansson, J. Keightley, A. Pearce
2012Be14	PRVCA	85,	044610	P. Belli, R. Bernabei, R.S. Boiko, V.B. Brudanin, F. Cappella, V. Caracciolo, R. Cerulli, D.M. Chernyak, F.A. Danevich, S. d'Angelo, E.N. Galashov, A. Incicchitti, V.V. Kobychiev, M. Laubenstein, V.M. Mokina, D.V. Poda, R.B. Podviyanuk, O.G. Polischuk, V.N. Shlegel, Yu. G. Stenin, J. Suhonen, V.I. Tretyak, Ya. V. Vasiliev

2012Be28	PYLBB	715,	293	G. Benzoni, A.I. Morales, J.J. Valiente-Dobón, A. Gottardo, A. Bracco, F. Cam-era, F.C.L. Crespi, A.M. Corsi, S. Leoni, B. Million, R. Nicolini, O. Wieland, A. Gadea, S. Lunardi, P. Boutachkov, A.M. Bruce, M. Górski, J. Grebosz, S. Pietri, Zs. Podolyák, M. Pfützner, P.H. Regan, H. Weick, J. Alcántara Núñez, A. Algora, N. Al-Dahan, G. de Angelis, Y. Ayyad, N. Alkhomashi, P.R.P. Alle-gro, D. Bazzacco, J. Benlliure, M. Bowry, M. Bunce, E. Casarejos, M.L. Cortes, A.M.D. Bacelar, A.Y. Deo, C. Domingo-Pardo, M. Doncel, Zs. Dombradi, T. En-gert, K. Eppinger, G.F. Farrelly, F. Farinon, E. Farnea, H. Geissel, J. Gerl, N. Goel, E. Gregor, T. Habermann, R. Hoischen, R. Janik, S. Klupp, I. Ko-jouharov, N. Kurz, S. Mandal, R. Menegazzo, D. Mengoni, D.R. Napoli, F. Naqvi, C. Nociforo, A. Prochazka, W. Prokopowicz, F. Recchia, R.V. Ribas, M.W. Reed, D. Rudolph, E. Sahin, H. Schaffner, A. Sharma, B. Sitar, D. Siwal, K. Steiger, P. Strmen, T.P.D. Swan, I. Szarka, C.A. Ur, P.M. Walker, H.-J. Woller-sheim
2012Bi.A	P-Argonne			J. Billowes
2012Bo.A	PrvCom	May	Lunney	Ch. Borgmann
2012Br03	PRLTA	108,	052504	M. Brodeur, T. Brunner, C. Champagne, S. Ettenauer, M.J. Smith, A. Lapierre, R. Ringle, V.L. Ryjkov, S. Bacca, P. Delheij, G.W.F. Drake, D. Lunney, A. Schwenk, J. Dilling
2012Ca03	PRVCA	85,	014312	L. Cartegni, C. Mazzocchi, R. Grzywacz, I.G. Darby, S.N. Liddick, K.P. Rykaczewski, J.C. Batchelder, L. Bianco, C.R. Bingham, E. Freeman, C. Goodin, C.J. Gross, A. Guglielmetti, D.T. Joss, S.H. Liu, M. Mazzocco, S. Padgett, R.D. Page, M.M. Rajabali, M. Romoli, P.J. Sapple, J. Thomson, H.V. Watkins
2012Ca05	PYLBB	707,	46	Z.X. Cao, Y.L. Ye, J. Xiao, L.H. Lv, D.X. Jiang, T. Zheng, H. Hua, Z.H. Li, X.Q. Li, Y.C. Ge, J.L. Lou, R. Qiao, Q.T. Li, H.B. You, R.J. Chen, D.Y. Pang, H. Sakurai, H. Otsu, M. Nishimura, S. Sakaguchi, H. Baba, Y. Togano, K. Yoneda, C. Li, S. Wang, H. Wang, K.A. Li, T. Nakamura, Y. Nakayama, Y. Kondo, S. Deguchi, Y. Satou, K. Tshoo
2012Ch02	PRLTA	108,	032501	G. Christian, N. Frank, S. Ash, T. Baumann, D. Bazin, J. Brown, P.A. DeYoung, J.E. Finck, A. Gade, G.F. Grinyer, A. Grovom, J.D. Hinnefeld, E.M. Lunderberg, B. Luther, M. Mosby, S. Mosby, T. Nagi, G.F. Peaslee, W.F. Rogers, J.K. Smith, J. Snyder, A. Spyrou, M.J. Strongman, M. Thoennessen, M. Warren, D. Weis-shaar, A. Wersal
2012Ch16	PRLTA	108,	162501	R. Chevrier, J.M. Daugas, L. Gaudefroy, Y. Ichikawa, H. Ueno, M. Hass, H. Haas, S. Cottenier, N. Aoi, K. Asahi, D.L. Balabanski, N. Fukuda, T. Fu-rukawa, G. Georgiev, H. Hayashi, H. Iijima, N. Inabe, T. Inoue, M. Ishihara, Y. Ishii, D. Kameda, T. Kubo, T. Nanao, G. Neyens, T. Ohnishi, M.M. Rajabali, K. Suzuki, H. Takeda, M. Tsuchiya, N. Vermeulen, H. Watanabe, A. Yoshimi
2012Ch19	NUPAB	882,	71	L. Chen, W.R. Plass, H. Geissel, R. Knöbel, C. Kozhuharov, Yu. A. Litvinov, Z. Patyk, C. Scheidenberger, K. Siegien-Iwaniuk, B. Sun, H. Weick, K. Beckert, P. Beller, F. Bosch, D. Boutin, L. Caceres, J.J. Carroll, D.M. Cullen, I.J. Cullen, B. Franzke, J. Gerl, M. Gorska, G.A. Jones, A. Kishada, J. Kurcewicz, S.A. Litvinov, Z. Liu, S. Mandal, F. Montes, G. Munzenberg, F. Nolden, T. Oht-subo, Zs. Podolyák, R. Propri, S. Rigby, N. Saito, T. Saito, M. Shindo, M. Steck, P.M. Walker, S. Williams, M. Winkler, H.-J. Wollersheim, T. Yamaguchi
2012Ch30	ARISE	70,	1871	V.P. Chechev
2012Ch40	PRVCA	86,	041307	R.J. Charity, L.G. Sobotka, K. Hagino, D. Bazin, M.A. Famiano, A. Gade, S. Hu-dan, S.A. Komarov, Jenny Lee, S.P. Lobastov, S.M. Lukyanov, W.G. Lynch, C. Metelko, M. Mocko, A.M. Rogers, H. Sagawa, A. Sanetullaev, M.B. Tsang, M.S. Wallace, M.J. van Goethem, A.H. Wuosmaa
2012Ch51	JPCSD	381,	012071	B. Cheal, J. Billowes, M.L. Bissell, K. Blaum, F.C. Charlwood, K.T. Flana-gan, D.H. Forest, Ch. Geppert, M. Kowalska, K. Kreim, A. Krieger, J. Krämer, K.M. Lynch, E. Mané, I.D. Moore, R. Neugart, G. Neyens, W. Nörthershäuser, J. Papuga, T.J. Procter, M.M. Rajabali, H.H. Stroke, P. Vingerhoets, D.T. Yor-danov, M. Žáková
2012Ch.A	PrvCom	May	Lunney	Ankur Chaudhuri
2012Da04	PRVCA	85,	064301	A.Y. Dauenhauer, K.S. Krane
2012Da06	ARISE	70,	1924	C.J. da Silva, A. Iwahara, D.S. Moreira, J.U. Delgado, R.S. Gomes

2012Da16	EPJAA	48,	157	F.A. Danevich, E. Andreotti, M. Hult, G. Marissens, V.I. Tretyak, A. Yuksel
2012Da17	EPJAA	48,	867	L.S. Danu, P.K. Joshi, D.C. Biswas, S. Mukhopadhyay, A. Goswami, P.N. Prashanth, L.A. Kinage, R.K. Choudhury, B. Singh
2012Dr01	NUPAB	875,	1	C. Droese, K. Blaum, M. Block, S. Eliseev, F. Herfurth, E. Minaya-Ramirez, Yu. N. Novikov, L. Schweikhard, V.M. Shabaev, I.I. Tupitsyn, S. Wycech, K. Zuber, N.A. Zubova
2012Dr02	PYLBB	709,	59	G.D. Dracoulis, G.J. Lane, A.P. Byrne, H. Watanabe, R.O. Hughes, N. Palalani, F.G. Kondev, M. Carpenter, R.V.F. Janssens, T. Lauritsen, C.J. Lister, D. Seweryniak, S. Zhu, P. Chowdhury, Y. Shi, F.R. Xu
2012Dr.A	PrvCom	FGK		G.D. Dracoulis
2012Fa07	ARISE	70,	2328	Fang Kaihong, Wang Dawei, Yang Shaobo, Zhao Jiangtao, Peng Haibo, Wang Qiang, Wang Tieshan
2012Fi01	PRLTA	108,	062502	D. Fink, J. Barea, D. Beck, K. Blaum, Ch. Bohm, Ch. Borgmann, M. Breitenfeldt, F. Herfurth, A. Herlert, J. Kotila, M. Kowalska, S. Kreim, D. Lunney, S. Naimi, M. Rosenbusch, S. Schwarz, L. Schweikhard, F. Simkovic, J. Stanja, K. Zuber and PrvCom WgM March 2012
2012FI05	JPGPE	39,	125101	K.T. Flanagan, J. Billowes, P. Campbell, B. Cheal, G.D. Dracoulis, D.H. Forest, M.D. Gardner, J. Huikari, A. Jokinen, B.A. Marsh, R. Moore, A. Nieminen, H. Penttilä, H.L. Thayer, G. Tungate, J. Äystö
2012Fo04	PRVCA	85,	027303	H.T. Fortune, R. Sherr
2012Fo09	NIMAE	687,	1	C.M. Folden III, M.C. Alfonso, D.A. Mayorov, K.R. Lawrence, A.A. Alharbi, E. Berdugo, P.J. Cammarata, A.C. Raphelt, B.T. Roeder, T.A. Werke
2012Ga15	PRVCA	85,	044311	A.T. Gallant, M. Brodeur, T. Brunner, U. Chowdhury, S. Ettenauer, V.V. Simon, E. Mané, M.C. Simon, C. Andreoiu, P. Delheij, G. Gwinner, M.R. Pearson, R. Ringle, J. Dilling
2012Ga17	PRVCA	85,	045504	A. Gando, Y. Gando, H. Hanakago, H. Ikeda, K. Inoue, R. Kato, M. Koga, S. Matsuda, T. Mitsui, T. Nakada, K. Nakamura, A. Obata, A. Oki, Y. Ono, I. Shimizu, J. Shirai, A. Suzuki, Y. Takemoto, K. Tamae, K. Ueshima, H. Watanabe, B.D. Xu, S. Yamada, H. Yoshida, A. Kozlov, S. Yoshida, T.I. Banks, J.A. Detwiler, S.J. Freedman, B.K. Fujikawa, K. Han, T. O'Donnell, B.E. Berger, Y. Efremenko, H.J. Karwowski, D.M. Markoff, W. Tornow, S. Enomoto, M.P. Decowski (KamLAND-Zen Collaboration)
2012Ga29	PRLTA	109,	032506	A.T. Gallant, J.C. Bale, T. Brunner, U. Chowdhury, S. Ettenauer, A. Lennarz, D. Robertson, V.V. Simon, A. Chaudhuri, J.D. Holt, A.A. Kwiatkowski, E. Mané, J. Menéndez, B.E. Schultz, M.C. Simon, C. Andreoiu, P. Delheij, M.R. Pearson, H. Savajols, A. Schwenk, J. Dilling
2012Ga45	PRLTA	109,	202503	L. Gaudefroy, W. Mittig, N.A. Orr, S. Varet, M. Chartier, P. Roussel-Chomaz, J.P. Ebran, B. Fernández-Domínguez, G. Frémont, P. Gangnant, A. Gillibert, S. Grévy, J.F. Libin, V.A. Maslov, S. Paschalis, B. Pietras, Yu.-E. Penionzhkevich, C. Spitaels, A.C.C. Villari
2012Go19	PRLTA	109,	162502	A. Gottardo, J.J. Valiente-Dobón, G. Benzoni, R. Nicolini, A. Gadea, S. Lunardi, P. Boutachkov, A.M. Bruce, M. Górska, J. Grebosz, S. Pietri, Zs. Podolyák, M. Pfützner, P.H. Regan, H. Weick, J. Alcántara Núñez, A. Algora, N. Al-Dahan, G. de Angelis, Y. Ayyad, N. Alkhomashi, P.R.P. Allegro, D. Bazzacco, J. Benlliure, M. Bowry, A. Bracco, M. Bunce, F. Camera, E. Casarejos, M.L. Cortes, F.C.L. Crespi, A. Corsi, A.M.D. Bacelar, A.Y. Deo, C. Domingo-Pardo, M. Doncel, Zs. Dombradi, T. Engert, K. Eppinger, G.F. Farrelly, F. Farinon, E. Farnea, H. Geissel, J. Gerl, N. Goel, E. Gregor, T. Habermann, R. Hoischen, R. Janik, S. Klupp, I. Kojouharov, N. Kurz, S.M. Lenzi, S. Leoni, Mandal, R. Menegazzo, D. Mengoni, B. Million, A.I. Morales, D.R. Napoli, F. Naqvi, C. Nociforo, A. Prochazka, W. Prokopowicz, F. Recchia, R.V. Ribas, M.W. Reed, D. Rudolph, E. Sahin, H. Schaffner, A. Sharma, B. Sitar, D. Siwal, K. Steiger, P. Strmen, T.P.D. Swan, I. Szarka, C.A. Ur, P.M. Walker, O. Wieland, H.-J. Wollersheim, F. Nowacki, E. Maglione, A.P. Zuker
2012Gu14	PRVCA	86,	014323	S. Guo, Y.H. Zhang, X.H. Zhou, M.L. Liu, Y.X. Guo, Y.H. Qiang, Y.D. Fang, X.G. Lei, F. Ma, M. Oshima, Y. Toh, M. Koizumi, A. Osa, A. Kimura, Y. Hatsukawa, M. Sugawara, H. Kusakari
2012Gy01	ARISE	70,	278	Gy. Gyurky, J. Farkas, Z. Halasz, T. Szucs

2012Ha05	PRVCA	85,	024611	H. Haba, D. Kaji, Y. Kudou, K. Morimoto, K. Morita, K. Ozeki, R. Sakai, T. Sumita, A. Yoneda, Y. Kasamatsu, Y. Komori, A. Shinohara, H. Kikunaga, H. Kudo, K. Nishio, K. Ooe, N. Sato, K. Tsukada
2012Ha25	PRLTA	109,	032501	J. Hakala, J. Dobaczewski, D. Gorelov, T. Eronen, A. Jokinen, A. Kankainen, V.S. Kolhinen, M. Kortelainen, I.D. Moore, H. Penttilä, S. Rinta-Antila, J. Rissanen, A. Saastamoinen, V. Sonnenschein, J. Äystö
2012He09	EPJAA	48,	75	F.P. Heßberger, S. Antalic, D. Ackermann, Z. Kalaninova, S. Heinz, S. Hofmann, B. Streicher, B. Kindler, I. Kojouharov, P. Kuusiniemi, M. Leino, B. Lommel, R. Mann, K. Nishio, Š. Šáro, B. Sulignano, M. Venhart
2012He11	PRVCA	86,	014605	G.Z. He, S. Jiang, Z.Y. Zhou, M. He, W.Z. Tian, J.L. Zhang, L.J. Diao, H. Li
2012Hi07	NATUA	486,	342	C.B. Hinke, M. Böhmer, P. Boutachkov, T. Faestermann, H. Geissel, J. Gerl, R. Gernhäuser, M. Górská, A. Gottardo, H. Grawe, J.L. Grębosz, R. Krücken, N. Kurz, Z. Liu, L. Maier, F. Nowacki, S. Pietri, Zs. Podolyák, K. Sieja, K. Steiger, K. Straub, H. Weick, H.-J. Wollersheim, P.J. Woods, N. Al-Dahan, N. Alkhomashi, A. Ataç, A. Blazhev, N.F. Braun, I.T. Çeliković, T. Davinson, I. Dillmann, C. Domingo-Pardo, P.C. Doornenbal, G. de France, G.F. Farrelly, F. Farinon, N. Goel, T.C. Habermann, R. Hoischen, R. Janik, M. Karny, A. Kaşkaş, I.M. Kojouharov, Th. Kröll, Y. Litvinov, S. Myalski, F. Nebel, S. Nishimura, C. Nociforo, J. Nyberg, A.R. Parikh, A. Procházka, P.H. Regan, C. Rigollet, H. Schaffner, C. Scheidenberger, S. Schwertel, P.-A. Söderström, S.J. Steer, A. Stolz, P. Strmeň
2012Ho12	EPJAA	48,	62	S. Hofmann, S. Heinz, R. Mann, J. Maurer, J. Khuyagbaatar, D. Ackermann, S. Antalic, W. Barth, M. Block, H.G. Burkhard, V.F. Comas, L. Dahl, K. Eberhardt, J. Gostic, R.A. Henderson, J.A. Heredia, F.P. Heßberger, J.M. Kennelly, B. Kindler, I. Kojouharov, J.V. Kratz, R. Lang, M. Leino, B. Lommel, K.J. Moody, G. Münzenberg, S.L. Nelson, K. Nishio, A.G. Popeko, J. Runke, Š. Šáro, D.A. Shaughnessy, M.A. Stoyer, P. Thörle-Pospiech, K. Tinschert, N. Trautmann, J. Uusitalo, P.A. Wilk, A.V. Yeremin
2012Hu10	PRVCA	86,	054314	R.O. Hughes, G.J. Lane, G.D. Dracoulis, A.P. Byrne, P.H. Nieminen, H. Watanabe, M.P. Carpenter, P. Chowdhury, R.V.F. Janssens, F.G. Kondev, T. Lauritsen, D. Seweryniak, S. Zhu
2012Ja01	PRVCA	85,	014309	U. Jakobsson, J. Uusitalo, S. Juutinen, M. Leino, T. Enqvist, P.T. Greenlees, K. Hauschild, P. Jones, R. Julin, S. Ketelhut, P. Kuusiniemi, M. Nyman, P. Peura, P. Rahkila, P. Ruotsalainen, J. Sarén, C. Scholey, J. Sorri
2012Ja11	PRVCA	86,	011304	M.F. Jager, R.J. Charity, J.M. Elson, J. Manfredi, H. Mohammad, L.G. Sobotka, M. McCleskey, R.G. Pizzone, B.T. Roeder, A. Spiridon, E. Simmons, L. Trache, M. Kurokawa
2012Ka12	EPJAA	48,	49	A. Kankainen, Yu. N. Novikov, M. Oinonen, L. Batist, V.-V. Elomaa, T. Eronen, J. Hakala, A. Jokinen, P. Karvonen, M. Reponen, J. Rissanen, A. Saastamoinen, G. Vorobjev, C. Weber, J. Äystö
2012Ka13	EPJAA	48,	47	A. Kankainen, V.S. Kolhinen, V.-V. Elomaa, T. Eronen, J. Hakala, A. Jokinen, A. Saastamoinen, J. Äystö
2012Ka36	PRVCA	86,	054319	D. Kameda, T. Kubo, T. Ohnishi, K. Kusaka, A. Yoshida, K. Yoshida, M. Ohtake, N. Fukuda, H. Takeda, K. Tanaka, N. Inabe, Y. Yanagisawa, Y. Gono, H. Watanabe, H. Otsu, H. Baba, T. Ichihara, Y. Yamaguchi, M. Takechi, S. Nishimura, H. Ueno, A. Yoshimi, H. Sakurai, T. Motobayashi, T. Nakao, Y. Mizoi, M. Matsushita, K. Ieki, N. Kobayashi, K. Tanaka, Y. Kawada, N. Tanaka, S. Deguchi, Y. Satou, Y. Kondo, T. Nakamura, K. Yoshinaga, C. Ishii, H. Yoshii, Y. Miyashita, N. Uematsu, Y. Shiraki, T. Sumikama, J. Chiba, E. Ideguchi, A. Saito, T. Yamaguchi, I. Hachiuma, T. Suzuki, T. Moriguchi, A. Ozawa, T. Ohtsubo, M.A. Famiano, H. Geissel, A.S. Nettleton, O.B. Tarasov, D. Bazin, B.M. Sherrill, S.L. Manikonda, J.A. Nolen
2012Ke01	NUPAB	880,	88	J.H. Kelley, E. Kwan, J.E. Purcell, C.G. Sheu, H.R. Weller
2012Ki16	SCIEA	335,	1614	N. Kinoshita, M. Paul, Y. Kashiv, P. Collon, C.M. Deibel, B. DiGiovine, J.P. Greene, D.J. Henderson, C.L. Jiang, S.T. Marley, T. Nakanishi, R.C. Pardo, K.E. Rehm, D. Robertson, R. Scott, C. Schmitt, X.D. Tang, R. Vondrasek, A. Yokoyama
2012Kn01	PRLTA	108,	122502	A. Knecht, R. Hong, D.W. Zumwalt, B.G. Delbridge, A. García, P. Müller, H.E. Swanson, I.S. Towner, S. Utsuno, W. Williams, C. Wrede

2012Ko24	ARISE	70,	2215	K. Kossert, O.J. Nöhle, O. Ott, R. Dersch
2012Ko29	PRVCA	86,	024307	A. Korgul, K.P. Rykaczewski, J.A. Winger, S.V. Ilyushkin, C.J. Gross, J.C. Batchelder, C.R. Bingham, I.N. Borzov, C. Goodin, R. Grzywacz, J.H. Hamilton, W. Królas, S.N. Liddick, C. Mazzocchi, C. Nelson, F. Nowacki, S. Padgett, A. Piechaczek, M.M. Rajabali, D. Shapira, K. Sieja, E.F. Zganjar
2012Ko43	PRLTA	109,	232501	Z. Kohley, J. Snyder, T. Baumann, G. Christian, P.A. DeYoung, J.E. Finck, R.A. Haring-Kaye, M. Jones, E. Lunderberg, B. Luther, S. Mosby, A. Simon, J.K. Smith, A. Spyrou, S.L. Stephenson, M. Thoennessen
2012Kr05	PRVCA	85,	044319	K.S. Krane
2012Kr07	ARISE	70,	1649	K.S. Krane
2012Ku06	PRVCA	85,	027302	J. Kurpeta, W. Urban, T. Materna, H. Faust, U. Köster, J. Rissanen, T. Rzaca-Urban, C. Mazzocchi, A.G. Smith, J.F. Smith, J.P. Greene, I. Ahmad
2012Ku26	PYLBB	717,	371	J. Kurcewicz, F. Farinon, H. Geissel, S. Pietri, C. Nociforo, A. Prochazka, H. Weick, J.S. Winfield, A. Estradé, P.R.P. Allegro, A. Bail, G. Bélier, J. Benlliure, G. Benzoni, M. Bunce, M. Bowry, R. Caballero-Folch, I. Dillmann, A. Evdokimov, J. Gerl, A. Gottardo, E. Gregor, R. Janik, A. Kelić-Heil, R. Knöbel, T. Kubo, Yu. A. Litvinov, E. Merchan, I. Mukha, F. Naqvi, M. Pfützner, M. Pomorski, Zs. Podolyák, P.H. Regan, B. Riese, M.V. Ricciardi, C. Scheidenberger, B. Sitar, P. Spiller, J. Stadlmann, P. Strmen, B. Sun, I. Szarka, J. Taieb, S. Terashima, J.J. Valiente-Dobon, M. Winkler, Ph. Woods
2012Ku28	PRVCA	86,	044306	J. Kurpeta, W. Urban, A. Plochocki, J. Rissanen, J.A. Pinston, V.-V. Elomaa, T. Eronen, J. Hakala, A. Jokinen, A. Kankainen, I.D. Moore, H. Penttilä, A. Saastamoinen, C. Weber, J. Äystö
2012La05	PRVCA	85,	024317	A. Lapierre, M. Brodeur, T. Brunner, S. Ettenauer, P. Finlay, A.T. Gallant, V.V. Simon, P. Delheij, D. Lunney, R. Ringle, H. Savajols, J. Dilling
2012La.A	P-Argonne			G.J. Lane
2012Li02	PRVCA	85,	014328	S.N. Liddick, B. Abromeit, A. Ayres, A. Bey, C.R. Bingham, M. Bolla, L. Cartegni, H.L. Crawford, I.G. Darby, R. Grzywacz, S. Ilyushkin, N. Larson, M. Madurga, D. Miller, S. Padgett, S. Paulauskas, M.M. Rajabali, K. Rykaczewski, S. Suchyta
2012Lo08	PRVCA	86,	014313	G. Lorusso, A. Becerril, A. Amthor, T. Baumann, D. Bazin, J.S. Berryman, B.A. Brown, R.H. Cyburt, H.L. Crawford, A. Estrade, A. Gade, T. Ginter, C.J. Guess, M. Hausmann, G.W. Hitt, P.F. Mantica, M. Matos, R. Meharchand, K. Minamisono, F. Montes, G. Perdikakis, J. Pereira, M. Portillo, H. Schatz, K. Smith, J. Stoker, A. Stolz, R.G.T. Zegers
2012Lu07	PRLTA	108,	142503	E. Lunderberg, P.A. DeYoung, Z. Kohley, H. Attanayake, T. Baumann, D. Bazin, G. Christian, D. Divaratne, S.M. Grimes, A. Haagsma, J.E. Finck, N. Frank, B. Luther, S. Mosby, T. Nagi, G.F. Peaslee, A. Schiller, J. Snyder, A. Spyrou, M.J. Strongman, M. Thoennessen
2012Lu14	ARISE	70,	1876	A. Luca, M. Sahagia, A. Antohe
2012Ma03	APOBB	43,	247	T. Malkiewicz, G.S. Simpson, W. Urban, J. Genevey, J.A. Pinston, I. Ahmad, J.P. Greene, U. Koster, T. Materna, M. Ramdhane, T. Rzaca-Urban, A.G. Smith, G. Thiamova
2012Ma30	ARISE	70,	2270	M. Marouli, S. Pommé, J. Paepen, R. Van Ammel, V. Jobbágy, A. Dirican, G. Suliman, H. Stroh, C. Apostolidis, K. Abbas, A. Morgenstern
2012Ma37	PRLTA	109,	112501	M. Madurga, R. Surman, I.N. Borzov, R. Grzywacz, K.P. Rykaczewski, C.J. Gross, D. Miller, D.W. Stracener, J.C. Batchelder, N.T. Brewer, L. Cartegni, J.H. Hamilton, J.K. Hwang, S.H. Liu, S.V. Ilyushkin, C. Jost, M. Karny, A. Korgul, W. Królas, A. Kuźniak, C. Mazzocchi, A.J. Mendez II, K. Miernik, W. Padgett, S.V. Paulauskas, A.V. Ramayya, J.A. Winger, M. Wolińska-Cichocka, E.F. Zganjar
2012Me04	EPJAA	48,	20	G. Meierhofer, P. Grabmayr, L. Canella, P. Kudejova, J. Jolie, N. Warr
2012Mo25	JUPSA	81,	103201	K. Morita, K. Morimoto, D. Kaji, H. Haba, K. Ozeki, Y. Kudou, T. Sumita, Y. Wakabayashi, A. Yoneda, K. Tanaka, S. Yamaki, R. Sakai, T. Akiyama, S.-i. Goto, H. Hasebe, M. Huang, T. Huang, E. Ideguchi, Y. Kasamatsu, K. Katori, Y. Kariya, H. Kikunaga, H. Koura, H. Kudo, A. Mashiko, K. Mayama, S.-ic. Mit-suoka, T. Moriya, M. Murakami, H. Murayama, S. Namai, A. Ozawa, N. Sato, K. Sueki, M. Takeyama, F. Tokanai, T. Yamaguchi, A. Yoshida

2012Mo.A	PrvCom		Moon	C.B. Moon, G.D. Dracoulis, R.A. Bark, A.P. Byrne, P.A. Davidson, T. Kibédi, G.J. Lane, A.N. Wilson
2012Mu05	PRVCA	85,	044325	I. Mukha, L. Grigorenko, L. Acosta, M.A.G. Alvarez, E. Casarejos, A. Chatillon, D. Cortina-Gil, J.M. Espino, A. Fomichev, J.E. García-Ramos, H. Geissel, J. Gómez-Camacho, J. Hofmann, O. Kiselev, A. Korshennikov, N. Kurz, Yu. A. Litvinov, I. Martel, C. Nociforo, W. Ott, M. Pfützner, C. Rodríguez-Tajes, E. Roeckl, C. Scheidenberger, M. Stanoiu, K. Sümmerer, H. Weick, P.J. Woods
2012Na15	PRVCA	86,	014325	S. Naimi, G. Audi, D. Beck, K. Blaum, Ch. Böhm, Ch. Borgmann, M. Breitenfeldt, S. George, F. Herfurth, A. Herlert, A. Kellerbauer, M. Kowalska, D. Lunney, E. Minaya Ramirez, D. Neidherr, M. Rosenbusch, L. Schweikhard, R.N. Wolf, K. Zuber
2012Ne05	ARISE	70,	1990	Y. Nedjadi, C. Bailat, Y. Caffari, P. Froidevaux, C. Wastiel, N. Kivel, I. Guenther-Leopold, G. Triscone, F. Jaquenod, F. Bochud
2012No08	PHSTT	150,	014028	C. Nociforo, F. Farinon, A. Musumarra, F. Bosch, D. Boutin, A. Del Zoppo, P. Figuera, M. Fisichella, H. Geissel, R. Knöbel, I. Kojouharov, C. Kozhuharov, T. Kuboki, J. Kurcewicz, Yu. A. Litvinov, M. Mazzocco, Y. Motizuki, F. Nolden, T. Ohstubo, Y. Ohkuma, Z. Patyk, M.G. Pellegriti, S. Pietri, Z. Podolyák, A. Prochazka, M.S. Sanjari, C. Scheidenberger, V. Scuderi, B. Sun, T. Suzuki, D. Torresi, H. Weick, J.S. Winfield, N. Winckler, M. Winkler, H.J. Wollersheim, T. Yamaguchi
2012Od01	PRVCA	85,	054315	D. O'Donnell, R.D. Page, C. Scholey, L. Bianco, L. Capponi, R.J. Carroll, I.G. Darby, L. Donosa, M. Drummond, F. Ertugral, T. Grahn, P.T. Greenlees, K. Hauschild, A. Herzan, U. Jakobsson, P. Jones, D.T. Joss, R. Julin, S. Juutinen, S. Ketelhut, M. Labiche, M. Leino, A. Lopez-Martens, K. Mulholland, P. Nieminen, P. Peura, P. Rahkila, S. Rinta-Antila, P. Ruotsalainen, M. Sandzelius, J. Saren, B. Saygi, J. Simpson, J. Sorri, A. Thornthwaite, J. Uusitalo
2012Og02	PRLTA	108,	022502	Yu. Ts. Oganessian, F. Sh. Abdullin, S.N. Dmitriev, J.M. Gostic, J.H. Hamilton, R.A. Henderson, M.G. Itkis, K.J. Moody, A.N. Polyakov, A.V. Ramayya, J.B. Roberto, K.P. Rykaczewski, R.N. Sagaidak, D.A. Shaughnessy, I.V. Shirokovsky, M.A. Stoyer, V.G. Subbotin, A.M. Sukhov, Yu. S. Tsyganov, V.K. Utyonkov, A.A. Voinov, G.K. Vostokin
2012Og06	PRLTA	109,	162501	Yu. Ts. Oganessian, F. Sh. Abdullin, C. Alexander, J. Binder, R.A. Boll, S.N. Dmitriev, J. Ezold, K. Felker, J.M. Gostic, R.K. Grzywacz, J.H. Hamilton, R.A. Henderson, M.G. Itkis, K. Miernik, D. Miller, K.J. Moody, A.N. Polyakov, A.V. Ramayya, J.B. Roberto, M.A. Ryabinin, K.P. Rykaczewski, R.N. Sagaidak, D.A. Shaughnessy, I.V. Shirokovsky, M.V. Shumeiko, M.A. Stoyer, N.J. Stoyer, V.G. Subbotin, A.M. Sukhov, Yu. S. Tsyganov, V.K. Utyonkov, A.A. Voinov, G.K. Vostokin
2012Os04	JUPSA	81,	084201	M. Oshima, T. Kin, S. Nakamura, M. Honma, F. Minato, T. Hayakawa, K.Y. Hara, A. Kimura, M. Koizumi, H. Harada, J. Goto, Y. Murakami
2012Pa07	PRVCA	85,	035501	H.I. Park, J.C. Hardy, V.E. Iacob, L. Chen, J. Goodwin, N. Nica, E. Simmons, L. Trache, R.E. Tribble
2012Po03	APOBB	43,	267	M. Pomorski, M. Pfützner, W. Dominik, R. Grzywacz, T. Baumann, J. Berryman, H. Czyrkowski, R. Dabrowski, T. Ginter, L. Grigorenko, J. Johnson, G. Kamiński, A. Kuźniak, N. Larson, S.N. Liddick, M. Madurga, C. Mazzocchi, S. Mianowski, K. Miernik, D. Miller, S. Palauskas, J. Pereira, K.P. Rykaczewski, A. Stolz, S. Suchyta
2012Po12	ARISE	70,	1900	S. Pommé, T. Altzitzoglou, R. Van Ammel, G. Suliman, M. Marouli, V. Jobbagy, J. Paepen, H. Stroh, C. Apostolidis, K. Abbas, A. Morgenstern
2012Po13	ARISE	70,	1913	S. Pommé, G. Suliman, M. Marouli, R. Van Ammel, V. Jobbagy, J. Paepen, H. Stroh, C. Apostolidis, K. Abbas, A. Morgenstern
2012Po14	ARISE	70,	2608	S. Pomme, M. Marouli, G. Suliman, H. Dikmen, R. Van Ammel, V. Jobbagy, A. Dirican, H. Stroh, J. Paepen, F. Bruchertseifer, C. Apostolidis, A. Morgenstern
2012Pr11	PRVCA	86	034329	T.J. Procter, J. Billowes, M.L. Bissell, K. Blaum, F.C. Charlwood, B. Cheal, K.T. Flanagan, D.H. Forest, S. Fritzsche, Ch. Geppert, H. Heylen, M. Kowalska, K. Kreim, A. Krieger, J. Krämer, K.M. Lynch, E. Mané, I.D. Moore, R. Neugart, G. Neyens, W. Nörtershäuser, J. Papuga, M.M. Rajabali, H.H. Stroke, P. Vingerhoets, D.T. Yordanov, M. Žáková

2012Qu01	PRVCA	85,	035807	M. Quinn, A. Aprahamian, J. Pereira, R. Surman, O. Arndt, T. Baumann, A. Becerril, T. Elliot, A. Estrade, D. Galaviz, T. Ginter, M. Hausmann, S. Hennrich, R. Kessler, K.-L. Kratz, G. Lorusso, P.F. Mantica, M. Matos, F. Montes, B. Pfeiffer, M. Portillo, H. Schatz, F. Schertz, L. Schnorrenberger, E. Smith, A. Stolz, W.B. Walters, A. Wöhr
2012Ra10	PRVCA	85,	034326	M.M. Rajabali, R. Grzywacz, S.N. Liddick, C. Mazzocchi, J.C. Batchelder, T. Baumann, C.R. Bingham, I.G. Darby, T.N. Ginter, S.V. Ilyushkin, M. Karny, W. Królas, P.F. Mantica, K. Miernik, M. Pfützner, K.P. Rykaczewski, D. Weisshaar, J.A. Winger
2012Ra34	PRVAA	86,	050502	R. Rana, M. Höcker, E.G. Myers
2012Re05	PRVCA	85,	035802	R. Reifarh, S. Dababneh, M. Heil, F. Kappeler, R. Plag, K. Sonnabend, E. Uberseder
2012Re17	PRVCA	86,	041306	M. Redshaw, G. Bollen, M. Brodeur, S. Bustabad, D.L. Lincoln, S.J. Novario, R. Ringle, S. Schwarz
2012Re19	PRVCA	86,	054321	M.W. Reed, P.M. Walker, I.J. Cullen, Yu. A. Litvinov, D. Shubina, G.D. Dracoulis, K. Blaum, F. Bosch, C. Brandau, J.J. Carroll, D.M. Cullen, A.Y. Deo, B. Detwiler, C. Dimopoulou, G.X. Dong, F. Farinon, H. Geissel, E. Haettner, M. Heil, R.S. Kempley, R. Knöbel, C. Kozhuharov, J. Kurcewicz, N. Kuzminchuk, S. Litvinov, Z. Liu, R. Mao, C. Nociforo, F. Nolden, W.R. Plaß, Zs. Podolyák, A. Prochazka, C. Scheidenberger, M. Steck, Th. Stöhlker, B. Sun, T.P.D. Swan, G. Trees, H. Weick, N. Winckler, M. Winkler, P.J. Woods, F.R. Xu, T. Yamaguchi
2012Re.A	PrvCom	GAu	May	M. Reed
2012Re.B	PrvCom	FGK	Jun	P.H. Regan
2012Ri08	PRVCA	86,	047301	L.A. Riley, P. Adrich, N. Ahsan, T.R. Baugher, D. Bazin, B.A. Brown, J.M. Cook, P.D. Cottle, C. Aa. Diget, A. Gade, T. Glasmacher, K.E. Hosier, K.W. Kemper, A. Ratkiewicz, K.P. Siwek, J.A. Tostevin, A. Volya, D. Weisshaar
2012Ro25	PRLTA	109,	092503	F. Rotaru, F. Negoita, S. Grévy, J. Mrazek, S. Lukyanov, F. Nowacki, A. Poves, O. Sorlin, C. Borcea, R. Borcea, A. Buta, L. Cáceres, S. Calinescu, R. Chevrier, Zs. Dombrádi, J.M. Daugas, D. Lebhertz, Y. Penionzhkevich, C. Petrone, D. Sohler, M. Stanoiu, J.C. Thomas
2012Sc.A	PrvCom	GAu	May	S. Schwarz
2012Si07	PRLTA	108,	202502	S.I. Sidorchuk, A.A. Bezbakh, V. Chudoba, I.A. Egorova, A.S. Fomichev, M.S. Golovkov, A.V. Gorshkov, V.A. Gorshkov, L.V. Grigorenko, P. Jalšovková, G. Kaminski, S.A. Krupko, E.A. Kuzmin, E. Yu. Nikolskii, Yu. Ts. Oganessian, Yu. L. Parfenova, P.G. Sharov, R.S. Slepnev, S.V. Stepantsov, G.M. Ter-Akopian, R. Wolski, A.A. Yukhimchuk, S.V. Filchagin, A.A. Kirdyashkin, I.P. Maksimkin, O.P. Vikhlyantsev
2012Si10	PRVCA	85,	064308	V.V. Simon, T. Brunner, U. Chowdhury, B. Eberhardt, S. Ettenauer, A.T. Gallant, E. Mane, M.C. Simon, P. Delheij, M.R. Pearson, G. Audi, G. Gwinner, D. Lunney, H. Schatz, J. Dilling
2012Sm01	PRVCA	85,	027601	C. Smorra, T. Beyer, K. Blaum, M. Block, Ch. E. Düllmann, K. Eberhardt, M. Eibach, S. Eliseev, Sz. Nagy, W. Nörtershäuser, D. Renisch
2012Sm07	PRVCA	86,	044604	C. Smorra, T.R. Rodríguez, T. Beyer, K. Blaum, M. Block, Ch. E. Düllmann, K. Eberhardt, M. Eibach, S. Eliseev, K. Langanke, G. Martínez-Pinedo, Sz. Nagy, W. Nörtershäuser, D. Renisch, V.M. Shabaev, I.I. Tupitsyn, N.A. Zubova
2012So10	JPGPE	39,	095107	P.C. Sood, R. Gowrishankar, K. Vijay Sai
2012Sp02	PRLTA	108,	102501	A. Spyrou, Z. Kohley, T. Baumann, D. Bazin, B.A. Brown, G. Christian, P.A. DeYoung, J.E. Finck, N. Frank, E. Lunderberg, S. Mosby, W.A. Peters, A. Schiller, J.K. Smith, J. Snyder, M.J. Strongman, M. Thoennessen, A. Volya
2012St.A	P-Argonne			M.A. Stoyer
2012Su11	ARISE	70,	1907	G. Suliman, S. Pommé, M. Marouli, R. Van Ammel, V. Jobbágy, J. Paepen, H. Stroh, C. Apostolidis, K. Abbas, A. Morgenstern
2012Sv02	EPJAA	48,	121	A.I. Svirikhin, A.V. Andreev, V.N. Dushin, M.L. Chelnokov, V.I. Chepigin, M. Gupta, A.V. Isaev, I.N. Izosimov, D.E. Katrasev, A.N. Kuznetsov, O.N. Malyshev, S. Mullins, A.G. Popeko, E.A. Sokol, A.V. Yerebin
2012Sw01	PRVCA	85,	024313	T.P.D. Swan, P.M. Walker, Zs. Podolyák, M.W. Reed, G.D. Dracoulis, G.J. Lane, T. Kibédi, M.L. Smith

2012Sw02	PRVCA	86,	044307	T.P.D. Swan, P.M. Walker, Zs. Podolyák, M.W. Reed, G.D. Dracoulis, G.J. Lane, T. Kibédi, M.L. Smith
2012Ta18	PRVCA	86,	044310	M.J. Taylor, G.A. Alharshan, D.M. Cullen, M.G. Procter, N.M. Lumley, T. Grahn, P.T. Greenlees, K. Hauschild, A. Herzan, U. Jakobsson, P. Jones, R. Julin, S. Juutinen, S. Ketelhut, M. Leino, A. Lopez-Martens, P. Nieminen, J. Partanen, P. Peura, P. Rahkila, S. Rinta-Antila, P. Ruotsalainen, M. Sandzelius, J. Sarén, C. Scholey, J. Sorri, S. Stolze, J. Uusitalo, F.R. Xu, Z.J. Bai
2012Ta.A	P-New-Dehli		157	S.K. Tandel
2012Th13	PRVCA	86,	064315	A. Thornthwaite, D. O'Donnell, R.D. Page, D.T. Joss, C. Scholey, L. Bianco, L. Capponi, R.J. Carroll, I.G. Darby, L. Donosa, M.C. Drummond, F. Ertuğral, T. Grahn, P.T. Greenlees, K. Hauschild, A. Herzan, U. Jakobsson, P. Jones, R. Julin, S. Juutinen, S. Ketelhut, M. Labiche, M. Leino, A. Lopez-Martens, K. Mullholland, P. Nieminen, P. Peura, P. Rahkila, S. Rinta-Antila, P. Ruotsalainen, M. Sandzelius, J. Sarén, B. Saygi, J. Simpson, J. Sorri, J. Uusitalo
2012Tr06	PRLTA	109,	042301	S. Triambak, P. Finlay, C.S. Sumithrarachchi, G. Hackman, G.C. Ball, P.E. Garrett, C.E. Svensson, D.S. Cross, A.B. Garnsworthy, R. Kshetri, J.N. Orce, M.R. Pearson, E.R. Tardiff, H. Al-Falou, R.A.E. Austin, R. Churchman, M.K. Djongolov, R. D'Entremont, C. Kierans, L. Milovanovic, S. O'Hagan, S. Reeve, S.K.L. Sjue, S.J. Williams
2012Va02	PRVCA	85,	045805	J. Van Schelt, D. Lascar, G. Savard, J.A. Clark, S. Caldwell, A. Chaudhuri, J. Fallis, J.P. Greene, A.F. Levand, G. Li, K.S. Sharma, M.G. Sternberg, T. Sun, B.J. Zabransky
2012Ve04	EPJAA	48,	101	M. Venhart, A.N. Andreyev, S. Antalic, L. Bianco, P.T. Greenlees, U. Jakobsson, P. Jones, D.T. Joss, R. Julin, S. Juutinen, S. Ketelhut, M. Leino, M. Nyman, R.D. Page, P. Peura, P. Rahkila, J. Sarén, C. Scholey, J. Sorri, J. Thomson, J. Uusitalo
2012Vi10	NATUA	488,	357	R. Vincent, S. Klyatskaya, M. Ruben, W. Wernsdorfer, F. Balestro
2012Wa10	PRVCA	85,	034329	P.T. Wady, J.F. Smith, E.S. Paul, B. Hadinia, C.J. Chiara, M.P. Carpenter, C.N. Davids, A.N. Deacon, S.J. Freeman, A.N. Grint, R.V.F. Janssens, B.P. Kay, T. Lauritsen, C.J. Lister, B.M. McGuirk, M. Petri, A.P. Robinson, D. Seweryniak, D. Steppenbeck, S. Zhu
2012Wa21	ARISE	70,	1927	S.-l. Wang, T. Bai, Q. Li, Z.-y. Chen, Q.-l. Shi, X.-s. Li, X.-l. Zhang, F. Xie, Y.-f. Chang
2012We08	JPCSD	337,	012018	L. Weissman, U. Bergmann, J. Cederkall, L. Fraile, S. Franchoo, H.O.U. Fynbo, T. Fritioff, U. Koster, O. Arnd, I. Dillman, O. Hallmann, K.-L. Kratz, B. Pfeiffer, A. Wöhr, L. Gaudefroy, O. Sorlin
2012Zh04	CPLLE	29,	012502	Z.Y. Zhang, Z.G. Gan, L. Ma, M.H. Huang, T.H. Huang, X.L. Wu, G.B. Jia, G.S. Li, L. Yu, Z.Z. Ren, S.G. Zhou, Y.H. Zhang, X.H. Zhou, H.S. Xu, H.Q. Zhang, G.Q. Xiao, W.L. Zhang
2012Zh34	PRLTA	109,	102501	Y.H. Zhang, H.S. Xu, Yu. A. Litvinov, X.L. Tu, X.L. Yan, S. Typel, K. Blaum, M. Wang, X.H. Zhou, Y. Sun, B.A. Brown, Y.J. Yuan, J.W. Xia, J.C. Yang, G. Audi, X.C. Chen, G.B. Jia, Z.G. Hu, X.W. Ma, R.S. Mao, B. Mei, P. Shuai, Z.Y. Sun, S.T. Wang, G.Q. Xiao, X. Xu, T. Yamaguchi, Y. Yamaguchi, Y.D. Zang, H.W. Zhao, T.C. Zhao, W. Zhang, W.L. Zhan
2013				
2013Ag11	PRLTA	111,	122503	M. Agostini, for the GERDA Collaboration
2013Ah03	PRVCA	87,	054328	I. Ahmad, J.P. Greene, F.G. Kondev, S. Zhu, M.P. Carpenter, R.V.F. Janssens, R.A. Boll, J.G. Ezold, S.M. Van Cleve, E. Browne
2013Al14	PRVCA	88,	034301	T. Al Kalanee, J. Gibelin, P. Roussel-Chomaz, N. Keeley, D. Beaumel, Y. Blumenfeld, B. Fernández-Domínguez, C. Force, L. Gaudefroy, A. Gillibert, J. Guillot, H. Iwasaki, S. Krupko, V. Lapoux, W. Mittig, X. Mougeot, L. Nalpas, E. Pollacco, K. Rusek, T. Roger, H. Savajols, N. de Séréville, S. Sidorchuk, D. Suzuki, I. Strojek, N.A. Orr
2013An03	PRVCA	87,	014317	A.N. Andreyev, S. Antalic, D. Ackermann, L. Bianco, S. Franchoo, S. Heinz, F.P. Heßberger, S. Hofmann, M. Huyse, Z. Kalaninová, I. Kojouharov, B. Kindler, B. Lommel, R. Mann, K. Nishio, R.D. Page, J.J. Ressler, B. Streicher, S. Saro, B. Sulignano, P. Van Duppen

2013An10	PRVCA	87,	054311	A.N. Andreyev, V. Liberati, S. Antalic, D. Ackermann, A. Barzakh, N. Bree, T.E. Cocolios, J. Diriken, J. Elseviers, D. Fedorov, V.N. Fedosseev, D. Fink, S. Franchoo, S. Heinz, F.P. Hessberger, S. Hofmann, M. Huyse, O. Ivanov, J. Khuyagbaatar, B. Kindler, U. Koster, J.F.W. Lane, B. Lommel, R. Mann, B. Marsh, P. Molkanov, K. Nishio, R.D. Page, N. Patronis, D. Pauwels, D. Radulov, S. Saro, M. Seliverstov, M. Sjodin, I. Tsekhanovich, P. Van den Bergh, P. Van Duppen, M. Venhart, M. Veselsky
2013An13	PRLTA	110,	242502	A.N. Andreyev, M. Huyse, P. Van Duppen, C. Qi, R.J. Liotta, S. Antalic, D. Ackermann, S. Franchoo, F.P. Heßberger, S. Hofmann, I. Kojouharov, B. Kindler, P. Kuusiniemi, S.R. Leshar, B. Lommel, R. Mann, K. Nishio, R.D. Page, B. Streicher, Š. Šáro, B. Sulignano, D. Wiseman, R.A. Wyss
2013As01	PRVCA	87,	014309	A. Astier, M.-G. Porquet
2013As02	PRVCA	87,	014332	M. Asai, K. Tsukada, M. Sakama, H. Haba, T. Ichikawa, Y. Ishii, A. Toyoshima, T. Ishii, I. Nishinaka, Y. Nagame, Y. Kasamatsu, M. Shibata, Y. Kojima, H. Hayashi
2013Ba29	PYLBB	723,	302	A.M.D. Bacelar, A.M. Bruce, Zs. Podolyák, N. Al-Dahan, M. Górská, S. Lalkowski, S. Pietri, M.V. Ricciardi, A. Algora, N. Alkhomashi, J. Benlliure, P. Boutachkov, A. Bracco, E. Calore, E. Casarejos, I.J. Cullen, A.Y. Deo, P. Dettistov, Zs. Dombradi, C. Domingo-Pardo, M. Doncel, F. Farinon, G.F. Farrelly, H. Geissel, W. Gelletly, J. Gerl, N. Goel, J. Grebosz, R. Hoischen, I. Kojouharov, N. Kurz, S. Leoni, F. Molina, D. Montanari, A.I. Morales, A. Musumarra, D.R. Napoli, R. Nicolini, C. Nociforo, A. Prochazka, W. Prokopowicz, P.H. Regan, B. Rubio, D. Rudolph, K.-H. Schmidt, H. Schaffner, S.J. Steer, K. Steiger, P. Strmen, T.P.D. Swan, I. Szarka, J.J. Valiente-Dobón, S. Verma, P.M. Walker, H. Weick, H.J. Wollersheim
2013Ba41	PRVCA	88,	024315	A.E. Barzakh, L. Kh. Batist, D.V. Fedorov, V.S. Ivanov, K.A. Mezilev, P.L. Molkanov, F.V. Moroz, S. Yu. Orlov, V.N. Pantelev, Yu. M. Volkov
2013Be07	EPJAA	49,	24	P. Belli, R. Bernabei, F. Cappella, R. Cerulli, F.A. Danevich, S. d'Angelo, A. Di Marco, A. Incicchitti, G.P. Kovtun, N.G. Kovtun, M. Laubenstein, D.V. Poda, O.G. Polischuk, A.P. Shcherban, V.I. Tretyak
2013Be09	PRVCA	87,	034607	P. Belli, R. Bernabei, F. Cappella, R. Cerulli, F.A. Danevich, S. d'Angelo, A. Incicchitti, G.P. Kovtun, N.G. Kovtun, M. Laubenstein, D.V. Poda, O.G. Polischuk, A.P. Shcherban, D.A. Solopikhin, J. Suhonen, V.I. Tretyak
2013Be16	EPJAA	49,	50	J.W. Beeman, F. Bellini, L. Cardani, N. Casali, S. Di Domizio, E. Fiorini, L. Gironi, S.S. Nagorny, S. Nisi, F. Orio, L. Pattavina, G. Pessina, G. Piperno, S. Pirro, E. Previtali, C. Rusconi, C. Tomei, M. Vignati
2013Be31	EPJAA	49,	92	G. Bellini, for the Borexino Collaboration
2013Bu12	PRVCA	88,	022501	S. Bustabad, G. Bollen, M. Brodeur, D.L. Lincoln, S.J. Novario, M. Redshaw, R. Ringle, S. Schwarz, A.A. Valverde
2013Bu17	PRVCA	88,	035502	S. Bustabad, G. Bollen, M. Brodeur, D.L. Lincoln, S.J. Novario, M. Redshaw, R. Ringle, S. Schwarz
2013Ca18	PRVCA	88,	034313	C. Caesar, for the R3B Collaboration
2013Ch12	PRLTA	110,	122502	L. Chen, P.M. Walker, H. Geissel, Yu. A. Litvinov, K. Beckert, P. Beller, F. Bosch, D. Boutin, L. Caceres, J.J. Carroll, D.M. Cullen, I.J. Cullen, B. Franzke, J. Gerl, M. Górská, G.A. Jones, A. Kishada, R. Knöbel, C. Kozhuharov, J. Kurcewicz, S.A. Litvinov, Z. Liu, S. Mandal, F. Montes, G. Münzenberg, F. Nolden, T. Ohtsubo, Z. Patyk, W.R. Plaß, Zs. Podolyák, S. Rigby, N. Saito, T. Saito, C. Scheidenberger, E.C. Simpson, M. Shindo, M. Steck, B. Sun, S.J. Williams, H. Weick, M. Winkler, H.-J. Wollersheim, T. Yamaguchi
2013Ch49	PRVCA	88,	054317	A. Chaudhuri, C. Andreoiu, T. Brunner, U. Chowdhury, S. Effenauer, A.T. Galant, G. Gwinner, A.A. Kwiatkowski, A. Lennarz, D. Lunney, T.D. Macdonald, B.E. Schultz, M.C. Simon, V.V. Simon, J. Dilling
2013Da16	PYLBB	726,	665	H.M. David, P.J. Woods, G. Lotay, D. Seweryniak, M. Albers, M. Alcorta, M.P. Carpenter, C.J. Chiara, T. Davinson, D.T. Doherty, C.R. Hoffman, R.V.F. Janssens, T. Lauritsen, A.M. Rogers, S. Zhu

2013De20	PRVCA	87,	067303	H. De Witte, S. Eeckhaudt, A.N. Andreyev, I.N. Borzov, J. Cederkäll, A. De Smet, D.V. Fedorov, V.N. Fedoseyev, S. Franchoo, M. Górska, H. Grawe, G. Huber, M. Huyse, Z. Janas, U. Köster, W. Kurcewicz, J. Kurpeta, A. Płochocki, K. Van de Vel, P. Van Duppen, L. Weissman
2013Dr01	PRVCA	87,	014326	G.D. Dracoulis, G.J. Lane, H. Watanabe, R.O. Hughes, N. Palalani, F.G. Kondev, M.P. Carpenter, R.V.F. Janssens, T. Lauritsen, C.J. Lister, D. Seweryniak, S. Zhu, P. Chowdhury, W.Y. Liang, Y. Shi, F.R. Xu
2013Dr04	EPJAA	49,	13	C. Droese, D. Ackermann, L.-L. Andersson, K. Blaum, M. Block, M. Dworschak, M. Eibach, S. Eliseev, U. Forsberg, E. Haettner, F. Herfurth, F.P. Heßberger, S. Hofmann, J. Ketelaer, G. Marx, E. Minaya Ramirez, D. Nesterenko, Yu. N. Novikov, W.R. Plaß, D. Rodríguez, D. Rudolph, C. Scheidenberger, L. Schweikhard, S. Stolze, P.G. Thirolf, C. Weber
2013Dr05	PYLBB	720,	330	G.D. Dracoulis, G.J. Lane, A.P. Byrne, H. Watanabe, R.O. Hughes, F.G. Kondev, M. Carpenter, R.V.F. Janssens, T. Lauritsen, C.J. Lister, D. Seweryniak, S. Zhu, P. Chowdhury, Y. Shi, F.R. Xu
2013Dr06	PRVCA	87,	054309	M.C. Drummond, D.T. Joss, R.D. Page, J. Simpson, D. O'Donnell, K. Andgren, L. Bianco, B. Cederwall, I.G. Darby, S. Eeckhaudt, M.B. Gomez-Hormillos, T. Grahn, P.T. Greenlees, B. Hadinia, P.M. Jones, R. Julin, S. Juutinen, S. Ketelhut, A.-P. Leppänen, M. Leino, M. Nyman, J. Pakarinen, P. Rakhila, M. Sandzelius, P.J. Sapple, J. Sarén, B. Saygi, C. Scholey, J. Sorri, J. Thomson, J. Uusitalo, M. Venhart
2013EI01	PRLTA	110,	082501	S. Eliseev, K. Blaum, M. Block, C. Droese, M. Goncharov, E. Minaya Ramirez, D.A. Nesterenko, Yu. N. Novikov, L. Schweikhard
2013Fi08	PRVCA	88,	011303	M. Fisichella, A. Musumarra, F. Farinon, C. Nociforo, A. Del oppo, P. Figuera, M. La Cognata, M.G. Pellegriti, V. Scuderi, D. Torresi, E. Strano
2013Fi09	PRLTA	111,	212501	K.T. Flanagan, K.M. Lynch, J. Billowes, M.L. Bissell, I. Budincevic, T.E. Cocolios, R.P. de Groote, S. De Schepper, V.N. Fedosseev, S. Franchoo, R.F. Garcia Ruiz, H. Heylen, B.A. Marsh, G. Neyens, T.J. Procter, R.E. Rossel, S. Rothe, I. Strashnov, H.H. Stroke, K.D.A. Wendt
2013Fr13	PYLBB	722,	233	D. Frekers, M.C. Simon, C. Andreoiu, J.C. Bale, M. Brodeur, T. Brunner, A. Chaudhuri, U. Chowdhury, J.R.C. López-Urrutia, P. Delheij, H. Ejiri, S. Ettenauer, A.T. Gallant, V. Gavrinn, A. Grossheim, M.N. Harakeh, F. Jang, A.A. Kwiatkowski, J. Lassen, A. Lennarz, M. Luichtl, T. Ma, T.D. Macdonald, E. Mané, D. Robertson, B.E. Schultz, V.V. Simon, A. Teigelhöfer, J. Dilling
2013Ga07	PRLTA	110,	062502	A. Gando, for the KamLAND-Zen Collaboration
2013Go10	PYLBB	725,	292	A. Gottardo, J.J. Valiente-Dobón, G. Benzoni, A. Gadea, S. Lunardi, P. Boutachkov, A.M. Bruce, M. Górska, J. Grebosz, S. Pietri, Zs. Podolyák, M. Pfützner, P.H. Regan, H. Weick, J. Alcántara Núñez, A. Algora, N. Al-Dahan, G. de Angelis, Y. Ayyad, N. Alkhomashi, P.R.P. Allegro, D. Bazzacco, J. Benlliure, M. Bowry, A. Bracco, M. Bunce, F. Camera, E. Casarejos, M.L. Cortes, F.C.L. Crespi, A. Corsi, A.M.D. Bacelar, A.Y. Deo, C. Domingo-Pardo, M. Doncel, Zs. Dombradi, T. Engert, K. Eppinger, G.F. Farrelly, F. Farinon, E. Farnea, H. Geissel, J. Gerl, N. Goel, E. Gregor, T. Habermann, R. Hoischen, R. Janik, P.R. John, S. Klupp, I. Kojouharov, N. Kurz, S.M. Lenzi, S. Leoni, S. Mandal, R. Menegazzo, D. Mengoni, B. Million, V. Modamio, A.I. Morales, D.R. Napoli, F. Naqvi, R. Nicolini, C. Nociforo, A. Prochazka, W. Prokopowicz, F. Recchia, R.V. Ribas, M.W. Reed, D. Rudolph, E. Sahin, H. Schaffner, A. Sharma, B. Sitar, D. Siwal, K. Steiger, P. Strmen, T.P.D. Swan, I. Szarka, C.A. Ur, P.M. Walker, O. Wieland, H.-J. Wollersheim
2013Gr03	PRVCA	87,	045502	G.F. Grinyer, G.C. Ball, H. Bouzomita, S. Ettenauer, P. Finlay, A.B. Garnsworthy, P.E. Garrett, K.L. Green, G. Hackman, J.R. Leslie, C.J. Pearson, E.T. Rand, C.S. Sumithrarachchi, C.E. Svensson, J.C. Thomas, S. Triambak, S.J. Williams
2013Ho22	PRVAA	88,	052502	M. Höcker, R. Rana, E.G. Myers
2013It01	PRVCA	88,	011306	Y. Ito, P. Schury, M. Wada, S. Naimi, T. Sonoda, H. Mita, F. Arai, A. Takamine, K. Okada, A. Ozawa, H. Wollnik
2013Ja06	PRVCA	87,	054320	U. Jakobsson, S. Juutinen, J. Uusitalo, M. Leino, K. Auranen, T. Enqvist, P.T. Greenlees, K. Hauschild, P. Jones, R. Julin, S. Ketelhut, P. Kuusiniemi, M. Nyman, P. Peura, P. Rakhila, P. Ruotsalainen, J. Sarén, C. Scholey, J. Sorri

2013Ka08	PRVCA	87,	024307	A. Kankainen, J. Hakala, T. Eronen, D. Gorelov, A. Jokinen, V.S. Kolhinen, I.D. Moore, H. Penttilä, S. Rinta-Antila, J. Rissanen, A. Saastamoinen, V. Sonnenschein, J. Äystö
2013Ka16	PRVCA	87,	044335	Z. Kalaninová, A.N. Andreyev, S. Antalic, F.P. Heßberger, D. Ackermann, B. Andel, M.C. Drummond, S. Hofmann, M. Huyse, B. Kindler, J.F.W. Lane, V. Liberati, B. Lommel, R.D. Page, E. Rapisarda, K. Sandhu, Š. Šáro, A. Thornthwaite, P. Van Duppen
2013Ko03	PRVCA	87,	011304	Z. Kohley, E. Lunderberg, P.A. DeYoung, A. Volya, T. Baumann, D. Bazin, G. Christian, N.L. Cooper, N. Frank, A. Gade, C. Hall, J. Hinnefeld, B. Luther, S. Mosby, W.A. Peters, J.K. Smith, J. Snyder, A. Spyrou, M. Thoennessen
2013Ko10	PRLTA	110,	152501	Z. Kohley, T. Baumann, D. Bazin, G. Christian, P.A. DeYoung, J.E. Finck, N. Frank, M. Jones, E. Lunderberg, B. Luther, S. Mosby, T. Nagi, J.K. Smith, J. Snyder, A. Spyrou, M. Thoennessen
2013Ko20	ARISE	81,	140	K. Kossert, G. Jörg, C. Lierse v. Gostomski
2013Ko31	PRVCA	88,	044330	A. Korgul, K.P. Rykaczewski, R. Grzywacz, H. Sliwinska, J.C. Batchelder, C. Bingham, I.N. Borzov, N. Brewer, L. Cartegni, A. Fijalkowska, C.J. Gross, J.H. Hamilton, C. Jost, M. Karny, W. Królas, S. Liu, C. Mazzocchi, M. Madurga, A.J. Mendez II, K. Miernik, D. Miller, S. Padgett, S. Paulauskas, D. Shapira, D. Stracener, K. Sieja, J.A. Winger, M. Wolinska-Cichocka, E.F. Zganjar
2013Kr15	NIMBE	317,	492	S. Kreim, D. Atanasov, D. Beck, K. Blaum, Ch. Böhm, Ch. Borgmann, M. Breitenfeldt, T.E. Cocolios, D. Fink, S. George, A. Herlert, A. Kellerbauer, U. Köster, M. Kowalska, D. Lunney, V. Manea, E. Minaya Ramirez, S. Naimi, D. Neidherr, T. Nicol, R.E. Rossel, M. Rosenbusch, L. Schweikhard, J. Stanja, F. Wienholtz, R.N. Wolf, K. Zuber
2013La02	PRVCA	87,	014318	J.F.W. Lane, A.N. Andreyev, S. Antalic, D. Ackermann, J. Gerl, F.P. Heßberger, S. Hofmann, M. Huyse, H. Kettunen, A. Kleinböhl, B. Kindler, I. Kojouharov, M. Leino, B. Lommel, G. Münzenberg, K. Nishio, R.D. Page, Š. Šáro, H. Schaffner, M.J. Taylor, P. Van Duppen
2013La11	PRVCA	87,	034308	S. Lalkowski, A.M. Bruce, A. Jungclaus, M. Górka, M. Pfützner, L. Cáceres, F. Naqvi, S. Pietri, Zs. Podolyák, G.S. Simpson, K. Andgren, P. Bednarczyk, T. Beck, J. Benlliure, G. Benzoni, E. Casarejos, B. Cederwall, F.C.L. Crespi, J.J. Cuenca-García, I.J. Cullen, A.M.D. Bacelar, P. Detistov, P. Doornenbal, G.F. Farrelly, A.B. Garnsworthy, H. Geissel, W. Gelletly, J. Gerl, J. Grebosz, B. Hadinia, M. Hellström, C. Hinke, R. Hoischen, G. Ilie, G. Jaworski, J. Jolie, A. Khaplanov, S. Kisyov, M. Kmiecik, I. Kojouharov, R. Kumar, N. Kurz, A. Maj, S. Mandal, V. Modamio, F. Montes, S. Myalski, M. Palacz, W. Prokopowicz, P. Reiter, P.H. Regan, D. Rudolph, H. Schaffner, D. Sohler, S.J. Steer, S. Tashenov, J. Walker, P.M. Walker, H. Weick, E. Werner-Malento, O. Wieland, H.J. Wollersheim, M. Zhekova
2013La23	PRVCA	88,	015501	A.T. Laffoley, C.E. Svensson, C. Andreoiu, R.A.E. Austin, G.C. Ball, B. Blank, H. Bouzomita, D.S. Cross, A. Diaz Varela, R. Dunlop, P. Finlay, A.B. Garnsworthy, P.E. Garrett, J. Giovinazzo, G.F. Grinyer, G. Hackman, B. Hadinia, D.S. Jamieson, S. Ketelhut, K.G. Leach, J.R. Leslie, E. Tardiff, J.C. Thomas, C. Unsworth
2013Le10	PRVCA	87,	034312	B. Lehnert, K. Zuber, E. Andreotti, M. Hult
2013Li01	PRLTA	110,	012501	D.L. Lincoln, J.D. Holt, G. Bollen, M. Brodeur, S. Bustabad, J. Engel, S.J. Novario, M. Redshaw, R. Ringle, S. Schwarz
2013Li49	PRVCA	88,	044322	V. Liberati, A.N. Andreyev, S. Antalic, A. Barzakh, T.E. Cocolios, J. Elseviers, D. Fedorov, V.N. Fedoseev, M. Huyse, D.T. Joss, Z. Kalaninová, U. Köster, J.F.W. Lane, B. Marsh, D. Mengoni, P. Molkanov, K. Nishio, R.D. Page, N. Patronis, D. Pauwels, D. Radulov, M. Seliverstov, M. Sjödin, I. Tsekhanovich, P. Van den Bergh, P. Van Duppen, M. Venhart, M. Veselsky
2013Ma13	ARISE	74,	123	M. Marouli, G. Suliman, S. Pommé, R. Van Ammel, V. Jobbágy, H. Stroh, H. Dikmen, J. Paepen, A. Dirican, F. Bruchertseifer, C. Apostolidis, A. Morgenstern
2013Ma15	NDSBA	114,	397	A. MacDonald, B. Karamy, K. Setoodehnia, B. Singh

2013Ma22	PRVCA	87,	034315	C. Mazzocchi, K.P. Rykaczewski, A. Korgul, R. Grzywacz, P. Baczyk, C. Bingham, N.T. Brewer, C.J. Gross, C. Jost, M. Karny, M. Madurga, A.J. Mendez II, K. Miernik, D. Miller, S. Padgett, S.V. Paulauskas, D.W. Stracener, M. Wolińska-Cichocka, I.N. Borzov
2013Ma81	PRVCA	88,	054322	V. Manea, D. Atanasov, D. Beck, K. Blaum, C. Borgmann, R.B. Cakirli, T. Eronen, S. George, F. Herfurth, A. Herlert, M. Kowalska, S. Kreim, Yu. A. Litvinov, D. Lunney, D. Neidherr, M. Rosenbusch, L. Schweikhard, F. Wienholtz, R.N. Wolf, K. Zuber
2013Ma87	PRVCA	88,	064320	C. Mazzocchi, R. Surman, R. Grzywacz, J.C. Batchelder, C.R. Bingham, D. Fong, J.H. Hamilton, J.K. Hwang, M. Karny, W. Królas, S.N. Liddick, P.F. Mantica, A.C. Morton, W.F. Mueller, K.P. Rykaczewski, M. Steiner, A. Stolz, J.A. Winger, I.N. Borzov
2013Ma.A	PrvCom	Apr	Lunney	Vladimir Manea
2013Mi13	PRVCA	88,	014309	K. Miernik, K.P. Rykaczewski, R. Grzywacz, C.J. Gross, D.W. Stracener, J.C. Batchelder, N.T. Brewer, L. Cartegni, A. Fijalkowska, J.H. Hamilton, J.K. Hwang, S.V. Ilyushkin, C. Jost, M. Karny, A. Korgul, W. Królas, S.H. Liu, M. Madurga, C. Mazzocchi, A.J. Mendez II, D. Miller, S.W. Padgett, S.V. Paulauskas, A.V. Ramayya, R. Surman, J.A. Winger, M. Wolinska-Cichocka, E.F. Zganjar
2013Mi19	PRLTA	111,	132502	K. Miernik, K.P. Rykaczewski, C.J. Gross, R. Grzywacz, M. Madurga, D. Miller, J.C. Batchelder, I.N. Borzov, N.T. Brewer, C. Jost, A. Korgul, C. Mazzocchi, A.J. Mendez II, Y. Liu, S.V. Paulauskas, D.W. Stracener, J.A. Winger, M. Wolinska-Cichocka, E.F. Zganjar
2013Mo12	NUPAB	909,	69	S. Mosby, N.S. Badger, T. Baumann, D. Bazin, M. Bennett, J. Brown, G. Christian, P.A. DeYoung, J.E. Finck, M. Gardner, J.D. Hinnefeld, E.A. Hook, E.M. Lunderberg, B. Luther, D.A. Meyer, M. Mosby, G.F. Peaslee, W.F. Rogers, J.K. Smith, J. Snyder, A. Spyrou, M.J. Strongman, M. Thoennessen
2013Mo20	PRVCA	88,	014319	A.I. Morales, J. Benlliure, M. Górska, H. Grawe, S. Verma, P.H. Regan, Zs. Podolyák, S. Pietri, R. Kumar, E. Casarejos, A. Algora, N. Alkhomashi, H. Álvarez-Pol, G. Benzoni, A. Blazhev, P. Boutachkov, A.M. Bruce, L.S. Cáceres, I.J. Cullen, A.M.D. Bacelar, P. Doornenbal, M.E. Estévez Aguado, G. Farrelly, Y. Fujita, A.B. Garnsworthy, W. Gelletly, J. Gerl, J. Grebosz, R. Hoischen, I. Kojouharov, N. Kurz, S. Lalkovski, Z. Liu, C. Mihai, F. Molina, D. Mücher, W. Prokopowicz, B. Rubio, H. Schaffner, S.J. Steer, A. Tamii, S. Tashenov, J.J. Valiente-Dobón, P.M. Walker, H.J. Wollersheim, P.J. Woods
2013Mu08	PRVCA	88,	024618	M. Murakami, S. Goto, H. Murayama, T. Kojima, H. Kudo, D. Kaji, K. Morimoto, H. Haba, Y. Kudou, T. Sumita, R. Sakai, A. Yoneda, K. Morita, Y. Kasamatsu, H. Kikunaga, T.K. Sato
2013Ny01	PRVCA	88,	054320	M. Nyman, S. Juutinen, I. Darby, S. Eeckhaudt, T. Grahn, P.T. Greenlees, U. Jakobsson, P. Jones, R. Julin, S. Ketelhut, H. Kettunen, M. Leino, P. Nieminen, P. Peura, P. Rahkila, J. Sarén, C. Scholey, J. Sorri, J. Uusitalo, T. Enqvist
2013Og01	PRVCA	87,	014302	Yu. Ts. Oganessian, F. Sh. Abdullin, S.N. Dmitriev, J.M. Gostic, J.H. Hamilton, R.A. Henderson, M.G. Itkis, K.J. Moody, A.N. Polyakov, A.V. Ramayya, J.B. Roberto, K.P. Rykaczewski, R.N. Sagaidak, D.A. Shaughnessy, I.V. Shirokovsky, M.A. Stoyer, N.J. Stoyer, V.G. Subbotin, A.M. Sukhov, Yu. S. Tsyganov, V.K. Utyonkov, A.A. Voinov, G.K. Vostokin
2013Og03	PRVCA	87,	034605	Yu. Ts. Oganessian, V.K. Utyonkov, F. Sh. Abdullin, S.N. Dmitriev, R. Graeger, R.A. Henderson, M.G. Itkis, Yu. V. Lobanov, A.N. Mezentsev, K.J. Moody, S.L. Nelson, A.N. Polyakov, M.A. Ryabinin, R.N. Sagaidak, D.A. Shaughnessy, I.V. Shirokovsky, M.A. Stoyer, N.J. Stoyer, V.G. Subbotin, K. Subbotin, A.M. Sukhov, Yu. S. Tsyganov, A. Türler, A.A. Voinov, G.K. Vostokin, P.A. Wilk, A. Yakushev
2013Og04	PRVCA	87,	054621	Yu. Ts. Oganessian, F. Sh. Abdullin, C. Alexander, J. Binder, R.A. Boll, S.N. Dmitriev, J. Ezold, K. Felker, J.M. Gostic, R.K. Grzywacz, J.H. Hamilton, R.A. Henderson, M.G. Itkis, K. Miernik, D. Miller, K.J. Moody, A.N. Polyakov, A.V. Ramayya, J.B. Roberto, M.A. Ryabinin, K.P. Rykaczewski, R.N. Sagaidak, D.A. Shaughnessy, I.V. Shirokovsky, M.V. Shumeiko, M.A. Stoyer, N.J. Stoyer, V.G. Subbotin, A.M. Sukhov, Yu. S. Tsyganov, V.K. Utyonkov, A.A. Voinov, G.K. Vostokin

2013OI06	PRVCA	88,	044306	B. Olaizola, L.M. Fraile, H. Mach, A. Aprahamian, J.A. Briz, J. Cal-González, D. Ghita, U. Köster, W. Kurcewicz, S.R. Leshner, D. Pauwels, E. Picado, A. Poves, D. Radulov, G.S. Simpson, J.M. Udías
2013Pr01	PRVCA	87,	014308	M.G. Procter, D.M. Cullen, M.J. Taylor, J. Pakarinen, K. Auranen, T. Bäck, T. Braunroth, B. Cederwall, A. Dewald, T. Grahn, P.T. Greenlees, U. Jakobsson, R. Julin, S. Juutinen, A. Herzán, J. Konki, M. Leino, R. Liotta, J. Partanen, P. Peura, P. Rakhila, P. Ruotsalainen, M. Sandelius, J. Sarén, C. Scholey, J. Sorri, S. Stolze, J. Uusitalo, C. Qi
2013Ra17	PRVCA	88,	014307	D. Radulov, C.J. Chiara, I.G. Darby, H. De Witte, J. Diriken, D.V. Fedorov, V.N. Fedosseev, L.M. Fraile, M. Huyse, U. Köster, B.A. Marsh, D. Pauwels, L. Popescu, M.D. Seliverstov, A.M. Sjödin, P. Van den Bergh, P. Van Duppen, M. Venhart, W.B. Walters, K. Wimmer
2013Re18	PRVCA	88,	041302	F. Recchia, C.J. Chiara, R.V.F. Janssens, D. Weisshaar, A. Gade, W.B. Walters, M. Albers, M. Alcorta, V.M. Bader, T. Baugher, D. Bazin, J.S. Berryman, P.F. Bertone, B.A. Brown, C.M. Campbell, M.P. Carpenter, J. Chen, H.L. Crawford, H.M. David, D.T. Doherty, C.R. Hoffman, F.G. Kondev, A. Korichi, C. Langer, N. Larson, T. Lauritsen, S.N. Liddick, E. Lunderberg, A.O. Macchiavelli, S. Noji, C. Prokop, A.M. Rogers, D. Seweryniak, S.R. Stroberg, S. Suchyta, S. Williams, K. Wimmer, S. Zhu
2013Ri07	PRVCA	88,	044313	J. Rissanen, R.M. Clark, K.E. Gregorich, J.M. Gates, C.M. Campbell, H.L. Crawford, M. Cromaz, N.E. Esker, P. Fallon, U. Forsberg, O. Gothe, I.-Y. Lee, H.L. Liu, A.O. Machiavelli, P. Mudder, H. Nitsche, G. Pang, A. Rice, D. Rudolph, M.A. Stoyer, A. Wiens, F.R. Xu
2013Ro.A	PrvCom	GAu	May	Marco Rosenbusch
2013Ru07	PRVCA	87,	064317	M. Rudigier, G.S. Simpson, J.M. Daugas, A. Blazhev, C. Fransen, G. Gey, M. Hackstein, J. Jolie, U. Köster, T. Malkiewicz, T. Materna, M. Pfeiffer, M. Ramdhane, J.-M. Régis, W. Rother, T. Thomas, N. Warr, D. Wilmsen, J. Le Bloas, N. Pillet
2013Ru10	PRVCA	88,	024320	P. Ruotsalainen, C. Scholey, R. Julin, K. Hauschild, K. Kaneko, B.S. Nara Singh, R. Wadsworth, D.G. Jenkins, T.S. Brock, P.T. Greenlees, J. Henderson, U. Jakobsson, P. Jones, S. Juutinen, S. Ketelhut, M. Leino, N.M. Lumley, P.J.R. Mason, P. Nieminen, M. Nyman, I. Paterson, P. Peura, M.G. Procter, P. Rakhila, J. Sarén, J. Sorri, J. Uusitalo
2013Ru11	PRLTA	111,	112502	D. Rudolph, U. Forsberg, P. Golubev, L.G. Sarmiento, A. Yakushev, L.-L. Andersson, A. Di Nitto, Ch. E. Düllmann, J.M. Gates, K.E. Gregorich, C.J. Gross, F.P. Heßberger, R.-D. Herzberg, J. Khuyagbaatar, J.V. Kratz, K. Rykaczewski, M. Schädel, S. øAberg, D. Ackermann, M. Block, H. Brand, B.G. Carlsson, D. Cox, X. Derkx, K. Eberhardt, J. Even, C. Fahlander, J. Gerl, E. Jäger, B. Kindler, J. Krier, I. Kojouharov, N. Kurz, B. Lommel, A. Mistry, C. Mokry, H. Nitsche, J.P. Omtvedt, P. Papadakis, I. Ragnarsson, J. Runke, H. Schaffner, B. Schausten, P. Thörle-Pospiech, T. Torres, T. Traut, N. Trautmann, A. Türler, A. Ward, D.E. Ward, N. Wiehl
2013Rz01	PRVCA	87,	031305	T. Rzaca-Urban, W. Urban, A.G. Smith, I. Ahmad, A. Syntfeld-Kazuch
2013Sa43	EPJAA	49,	109	J. Sauvage, B. Roussiére, J. Genevey, S. Franchoo, A.N. Andreyev, N. Barré, A. Ben Braham, C. Bourgeois, J.-F. Clavelin, H. De Witte, D.V. Fedorov, V.N. Fedoseyev, L.M. Fraile, X. Grave, G. Huber, M. Huyse, P. Kilcher, U. Köster, P. Kunz, S.R. Leshner, B.A. Marsh, I. Mukha, J. Oms, M.G. Porquet, M. Seliverstov, I. Stefanescu, K. Van de Vel, P. Van Duppen, YU.M. Volkov, A. Wojtasiewicz
2013Sa65	PRVCA	88,	064611	P. Salvador-Castineira, T. Brys, R. Eykens, F.-J. Hamsch, A. Moens, S. Oberstedt, G. Sibbens, D. Vanleeuw, M. Vidali, C. Pretel
2013Se03	PYLBB	719,	362	M.D. Seliverstov, T.E. Cocolios, W. Dexters, A.N. Andreyev, S. Antalic, A.E. Barzakh, B. Bastin, J. Büscher, I.G. Darby, D.V. Fedorov, V.N. Fedoseyev, K.T. Flanagan, S. Franchoo, S. Fritzsche, G. Huber, M. Huyse, M. Keupers, U. Köster, Yu. Kudryavtsev, B.A. Marsh, P.L. Molkanov, R.D. Page, A.M. Sjödin, I. Stefan, J. Van de Walle, P. Van Duppen, M. Venhart, S.G. Zemlyanoy

2013Sh30	PRVCA	88,	024310	D. Shubina, R.B. Cakirli, Yu. A. Litvinov, K. Blaum, C. Brandau, F. Bosch, J.J. Carroll, R.F. Casten, D.M. Cullen, I.J. Cullen, A.Y. Deo, B. Detwiler, C. Dimopoulou, F. Farinon, H. Geissel, E. Haettner, M. Heil, R.S. Kempley, C. Kozhuharov, R. Knöbel, J. Kurcewicz, N. Kuzminchuk, S.A. Litvinov, Z. Liu, R. Mao, C. Nociforo, F. Nolden, Z. Patyk, W.R. Plass, A. Prochazka, M.W. Reed, M.S. Sanjari, C. Scheidenberger, M. Steck, Th. Stöhlker, B. Sun, T.P.D. Swan, G. Trees, P.M. Walker, H. Weick, N. Winckler, M. Winkler, P.J. Woods, T. Yamaguchi, C. Zhou
2013Sn02	PRVCA	88,	031303	J. Snyder, T. Baumann, G. Christian, R.A. Haring-Kaye, P.A. DeYoung, Z. Kohley, B. Luther, M. Mosby, S. Mosby, A. Simon, J.K. Smith, A. Spyrou, S. Stephenson, M. Thoennessen
2013St25	PRVCA	88,	054304	J. Stanja, Ch. Borgmann, J. Agramunt, A. Algora, D. Beck, K. Blaum, Ch. Böhm, M. Breitenfeldt, T.E. Cocolios, L.M. Fraile, F. Herfurth, A. Herlert, M. Kowalska, S. Kreim, D. Lunney, V. Manea, E. Minaya Ramirez, S. Naimi, D. Neidherr, M. Rosenbusch, L. Schweikhard, G. Simpson, F. Wienholtz, R.N. Wolf, K. Zuber
2013Su04	JUPSA	82,	024202	T. Sumita, K. Morimoto, D. Kaji, H. Haba, K. Ozeki, R. Sakai, A. Yoneda, A. Yoshida, H. Hasebe, K. Katori, N. Sato, Y. Wakabayashi, S.-i. Mitsuoka, S.-i. Goto, M. Murakami, Y. Kariya, F. Tokanai, K. Mayama, M. Takeyama, T. Moriya, E. Ideguchi, T. Yamaguchi, H. Kikunaga, J. Chiba, K. Morita
2013Su07	PRVCA	87,	024312	J. Su, W.P. Liu, N.C. Shu, S.Q. Yan, Z.H. Li, B. Guo, W.Z. Huang, S. Zeng, E.T. Li, S.J. Jin, X. Liu, Y.B. Wang, G. Lian, Y.J. Li, Y.S. Chen, X.X. Bai, J.S. Wang, Y.Y. Yang, R.F. Chen, S.W. Xu, J. Hu, S.Z. Chen, S.B. Ma, J.L. Han, P. Ma, Q. Hu, J.B. Ma, X.G. Cao, S.L. Jin, Z. Bai, K. Yang, F.D. Shi, W. Zhang, Z. Chen, L.X. Liu, Q.Y. Lin, X.S. Yan, X.H. Zhang, F. Fu, J.J. He, X.Q. Li, C. He, M.S. Smith
2013Su13	ARISE	77,	32	G. Suliman, S. Pommé, M. Marouli, R. Van Ammel, H. Stroh, V. Jobbágy, J. Paepen, A. Dirican, F. Bruchertseifer, C. Apostolidis, A. Morgenstern
2013Su23	NIMBE	317,	756	H. Suzuki, T. Kubo, N. Fukuda, N. Inabe, D. Kameda, H. Takeda, K. Yoshida, K. Kusaka, Y. Yanagisawa, M. Ohtake, H. Sato, Y. Shimizu, H. Baba, M. Kurokawa, T. Ohnishi, K. Tanaka, O.B. Tarasov, D. Bazin, D.J. Morrissey, B.M. Sherrill, K. Ieki, D. Murai, N. Iwasa, A. Chiba, Y. Ohkoda, E. Ideguchi, S. Go, R. Yokoyama, T. Fujii, D. Nishimura, H. Nishibata, S. Momota, M. Lewitowicz, G. DeFrance, I. Celikovic, K. Steiger
2013Tr09	PRLTA	111,	262501	V. Tripathi, S.L. Tabor, A. Volya, S.N. Liddick, P.C. Bender, N. Larson, C. Prokop, S. Suchyta, P.-L. Tai, J.M. VonMoss
2013Uj01	PRLTA	110,	032501	P. Ujjic, F. de Oliveira Santos, M. Lewitowicz, N.L. Achouri, M. Assié, B. Bastin, C. Borcea, R. Borcea, A. Buta, A. Coc, G. de France, O. Kamalou, J. Kiener, A. Lepailleur, V. Meot, A. Pautrat, M.G. Saint Laurent, O. Sorlin, M. Stanoiu, V. Tatischeff
2013Uu01	PRVCA	87,	064304	J. Uusitalo, J. Sarén, S. Juutinen, M. Leino, S. Eeckhaudt, T. Grahn, P.T. Greenlees, U. Jakobsson, P. Jones, R. Julin, S. Ketelhut, A.-P. Leppänen, M. Nyman, J. Pakarinen, P. Rahkila, C. Scholey, A. Semchenkov, J. Sorri, A. Steer, M. Venhart
2013Va10	PRVCA	87,	064303	A. Vancraeyenest, C.M. Petrache, D. Guinet, P.T. Greenlees, U. Jakobsson, R. Julin, S. Juutinen, S. Ketelhut, M. Leino, M. Nyman, P. Peura, P. Rahkila, P. Ruotsalainen, J. Saren, C. Scholey, J. Sorri, J. Uusitalo, P. Jones, C. Ducoin, P. Loutesse, C. Mancuso, N. Redon, O. Stezowski, P. Désesquelles, R. Leguillon, A. Korichi, T. Zerrouki, D. Curien, A. Takashima
2013Va12	PRLTA	111,	061102	J. Van Schelt, D. Lascar, G. Savard, J.A. Clark, P.F. Bertone, S. Caldwell, A. Chaudhuri, A.F. Levand, G. Li, G.E. Morgan, R. Orford, R.E. Segel, K.S. Sharma, M.G. Sternberg
2013Ve03	PRVCA	87,	054307	D. Verney, B. Tastet, K. Kolos, F. Le Blanc, F. Ibrahim, M.C. Mhamed, E. Cottereau, P.V. Cuong, F. Didierjean, G. Duchêne, S. Essabaa, M. Ferraton, S. Franchoo, L.H. Khiem, C. Lau, J.-F. Le Du, I. Matea, B. Mouginot, M. Niikura, B. Roussière, I. Stefan, D. Testov, J.-C. Thomas
2013Vo10	PRLTA	111,	122501	A. Voss, M.R. Pearson, J. Billowes, F. Buchinger, B. Cheal, J.E. Crawford, A.A. Kwiatkowski, C.D.P. Levy, O. Shelbaya

2013Wi06	NATUA	498,	346	F. Wienholtz, D. Beck, K. Blaum, Ch. Borgmann, M. Breitenfeldt, R.B. Cakirli, S. George, F. Herfurth, J.D. Holt, M. Kowalska, S. Kreim, D. Lunney, V. Manea, J. Menendez, D. Neidherr, M. Rosenbusch, L. Schweikhard, A. Schwenk, J. Simonis, J. Stanja, K. Zuber
2013Wo05	IJMPD	349,	123	R.N. Wolf, F. Wienholtz, D. Atanasov, D. Beck, K. Blaum, Ch. Borgmann, F. Herfurth, M. Kowalska, S. Kreim, Yu. A. Litvinov, D. Lunney, V. Manea, D. Neidherr, M. Rosenbusch, L. Schweikhard, J. Stanja, K. Zuber and Prv-Com GAu January 2015
2013Wo06	PRLTA	110,	041101	R.N. Wolf, D. Beck, K. Blaum, Ch. Böhm, Ch. Borgmann, M. Breitenfeldt, N. Chamel, S. Goriely, F. Herfurth, M. Kowalska, S. Kreim, D. Lunney, V. Manea, E. Minaya Ramirez, S. Naimi, D. Neidherr, M. Rosenbusch, L. Schweikhard, J. Stanja, F. Wienholtz, K. Zuber
2013Wr01	PRVCA	87,	031303	C. Wrede, S.K.L. Sjue, A. García, H.E. Swanson, I. Ahmad, A. Algora, V.-V. Elomaa, T. Eronen, J. Hakala, A. Jokinen, V.S. Kolhinen, I.D. Moore, H. Penttilä, M. Reponen, J. Rissanen, A. Saastamoinen, J. Äystö
2013Ya03	APJLA	766,	8	X.L. Yan, H.S. Xu, Yu. A. Litvinov, Y.H. Zhang, H. Schatz, X.L. Tu, K. Blaum, X.H. Zhou, B.H. Sun, J.J. He, Y. Sun, M. Wang, Y.J. Yuan, J.W. Xia, J.C. Yang, G. Audi, G.B. Jia, Z.G. Hu, X.W. Ma, R.S. Mao, B. Mei, P. Shuai, Z.Y. Sun, S.T. Wang, G.Q. Xiao, X. XU, T. Yamaguchi, Y. Yamaguchi, Y.D. Zang, H.W. Zhao, T.C. Zhao, W. Zhang, W.L. Zhan
2013Yo02	PRLTA	110,	192501	D.T. Yordanov, D.L. Balabanski, J. Bieroń, M.L. Bissell, K. Blaum, I. Budincevic, S. Fritzsche, N. Frömmgen, G. Georgiev, Ch. Geppert, M. Hammen, M. Kowalska, K. Kreim, A. Krieger, R. Neugart, W. Nörtershäuser, J. Papuga, S. Schmidt
2013Yu07	PRLTA	111,	222501	A.T. Yue, M.S. Dewey, D.M. Gilliam, G.L. Greene, A.B. Laptev, J.S. Nico, W.M. Snow, F.E. Wietfeldt
				2014
2014Ai03	PRVCA	89,	015502	J.B. Albert, and The EXO Collaboration
2014An10	PRVCA	90,	044312	A.N. Andreyev, S. Antalic, D. Ackermann, T.E. Cocolios, J. Elseviers, S. Franchoo, S. Heinz, F.P. Heßberger, S. Hofmann, M. Huyse, J. Khuyagbaatar, B. Kindler, B. Lommel, R. Mann, R.D. Page, P. Van Duppen, M. Venhart
2014Ar08	NUPAB	925,	25	R. Arnold, and The NEMO-3 Collaboration
2014As02	PRVCA	89,	034310	A. Astier, T. Konstantinopoulos, M.-G. Porquet, M. Houry, R. Lucas, Ch. Theisen
2014Au03	PRVCA	90,	024310	K. Auranen, J. Uusitalo, S. Juutinen, U. Jakobsson, T. Grahn, P.T. Greenlees, K. Hauschild, A. Herzan, R. Julin, J. Konki, M. Leino, J. Pakarinen, J. Partanen, P. Peura, P. Rahkila, P. Ruotsalainen, M. Sandzelius, J. Sarén, C. Scholey, J. Sorri, S. Stolze
2014Ba18	PRVCA	89,	054321	J.C. Batchelder, N.T. Brewer, C.J. Gross, R. Grzywacz, J.H. Hamilton, M. Karny, A. Fijalkowska, S.H. Liu, K. Miernik, S.W. Padgett, S.V. Paulauskas, K.P. Rykaczewski, A.V. Ramayya, D.W. Stracener, M. Wolinska-Cichocka
2014Bo26	PRVCA	90,	044307	Ch. Böhm, Ch. Borgmann, G. Audi, D. Beck, K. Blaum, M. Breitenfeldt, R.B. Cakirli, T.E. Cocolios, S. Eliseev, S. George, F. Herfurth, A. Herlert, M. Kowalska, S. Kreim, D. Lunney, V. Manea, E. Minaya Ramirez, S. Naimi, D. Neidherr, M. Rosenbusch, L. Schweikhard, J. Stanja, M. Wang, R.N. Wolf, K. Zuber
2014Br06	PRLTA	112,	212301	L.J. Broussard, H.O. Back, M.S. Boswell, A.S. Crowell, P. Dendooven, G.S. Giri, C.R. Howell, M.F. Kidd, K. Jungmann, W.L. Kruithof, A. Mol, C.J.G. Onderwater, R.W. Pattie, Jr., P.D. Shidling, M. Sohani, D.J. van der Hoek, A. Rogachevskiy, E. Traykov, O.O. Versolato, L. Willmann, H.W. Wilschut, A.R. Young
2014Br15	PRVCA	90,	027304	K.W. Brown, W.W. Buhro, R.J. Charity, J.M. Elson, W. Reviol, L.G. Sobotka, Z. Chajecski, W.G. Lynch, J. Manfredi, R. Shane, R.H. Showalter, M.B. Tsang, D. Weisshaar, J.R. Winkelbauer, S. Bedoor, A.H. Wuosmaa

2014Br19	PRLTA	113,	232501	K.W. Brown, R.J. Charity, L.G. Sobotka, Z. Chajecski, L.V. Grigorenko, I.A. Egorova, Yu. L. Parfenova, M.V. Zhukov, S. Bedoor, W.W. Buhro, J.M. Elson, W.G. Lynch, J. Manfredi, D.G. McNeel, W. Reviol, R. Shane, R.H. Showalter, M.B. Tsang, J.R. Winkelbauer, A.H. Wuosmaa
2014Bu06	PRVCA	90,	014317	I. Budincevic, J. Billowes, M.L. Bissell, T.E. Cocolios, R.P. de Groote, S. De Schepper, V.N. Fedosseev, K.T. Flanagan, S. Franchoo, R.F. Garcia Ruiz, H. Heylen, K.M. Lynch, B.A. Marsh, G. Neyens, T.J. Procter, R.E. Rossel, S. Rothe, I. Strashnov, H.H. Stroke, K.D.A. Wendt
2014Ca03	PRLTA	112,	092501	R.J. Carroll, R.D. Page, D.T. Joss, J. Uusitalo, I.G. Darby, K. Andgren, B. Cederwall, S. Eeckhaudt, T. Grahn, C. Gray-Jones, P.T. Greenlees, B. Hadinia, P.M. Jones, R. Julin, S. Juutinen, M. Leino, A.-P. Leppänen, M. Nyman, D. O'Donnell, J. Pakarinen, P. Rakhila, M. Sandzelius, J. Sarén, C. Scholey, D. Seweryniak, J. Simpson
2014Ca13	JPGPE	40,	075101	N. Casali, S.S. Nagorny, F. Orio, L. Pattavina, J.W. Beeman, F. Bellini, L. Cardani, I. Dafinei, S. Di Domizio, M.L. Di Vacri, L. Gironi, M.B. Kosmyna, B.P. Nazarenko, S. Nisi, G. Pessina, G. Piperno, S. Pirro, C. Rusconi, A.N. Shekhovtsov, C. Tomei, M. Vignati
2014Ca46	JPGPE	41,	075204	L. Cardani, L. Gironi, N. Ferreiro Iachellini, L. Pattavina, J.W. Beeman, F. Bellini, N. Casali, O. Cremonesi, I. Dafinei, S. Di Domizio, F. Ferroni, E. Galashov, C. Gotti, S. Nagorny, F. Orio, G. Pessina, G. Piperno, S. Pirro, E. Previtali, C. Rusconi, C. Tomei, M. Vignati
2014Ch47	PRVCA	90,	044302	J. Chen, I. Ahmad, J.P. Greene, F.G. Kondev
2014Cr02	PRVCA	89,	041303	H.L. Crawford, P. Fallon, A.O. Macchiavelli, R.M. Clark, B.A. Brown, J.A. Tostevin, D. Bazin, N. Aoi, P. Doornenbal, M. Matsushita, H. Scheit, D. Steppenbeck, S. Takeuchi, H. Baba, C.M. Campbell, M. Cromaz, E. Ideguchi, N. Kobayashi, Y. Kondo, G. Lee, I.Y. Lee, J. Lee, K. Li, S. Michimasa, T. Motobayashi, T. Nakamura, S. Ota, S. Paschalis, M. Petri, T. Sako, H. Sakurai, S. Shimoura, M. Takechi, Y. Togano, H. Wang, K. Yoneda
2014De41	PYLBB	738,	453	M. Del Santo, Z. Meisel, D. Bazin, A. Becerril, B.A. Brown, H. Crawford, R. Cyburt, S. George, G.F. Grinyer, G. Lorusso, P.F. Mantica, F. Montes, J. Pereira, H. Schatz, K. Smith, M. Wiescher
2014Di08	PYLBB	736,	533	J. Diriken, N. Patronis, A.N. Andreyev, S. Antalic, V. Bildstein, A. Blazhev, I.G. Darby, H. De Witte, J. Eberth, J. Elseviers, V.N. Fedosseev, F. Flavigny, Ch. Fransen, G. Georgiev, R. Gernhauser, H. Hess, M. Huyse, J. Jolie, Th. Kröll, R. Krücken, R. Lutter, B.A. Marsh, T. Mertzimekis, D. Muecher, F. Nowacki, R. Orlandi, A. Pakou, R. Raabe, G. Randisi, P. Reiter, T. Roger, M. Seidlitz, M. Seliverstov, K. Sieja, C. Sotty, H. Tornqvist, J. Van De Walle, P. Van Duppen, D. Voulot, N. Warr, F. Wenander, K. Wimmer
2014Dr02	PRVCA	89,	064309	M.C. Drummond, D. O'Donnell, R.D. Page, D.T. Joss, L. Capponi, D.M. Cox, I.G. Darby, L. Donosa, F. Filmer, T. Grahn, P.T. Greenlees, K. Hauschild, A. Herzan, U. Jakobsson, P.M. Jones, R. Julin, S. Juutinen, S. Ketelhut, M. Leino, A. Lopez-Martens, A.K. Mistry, P. Nieminen, P. Peura, P. Rakhila, S. Rinta-Antila, P. Ruotsalainen, M. Sandzelius, J. Sarén, B. Saygi, C. Scholey, J. Simpson, J. Sorri, A. Thornthwaite, J. Uusitalo
2014Ei01	PRVCA	89,	064318	M. Eibach, T. Beyer, K. Blaum, M. Block, Ch. E. Düllmann, K. Eberhardt, J. Grund, Sz. Nagy, H. Nitsche, W. Nörtershäuser, D. Renisch, K.P. Rykaczewski, F. Schneider, C. Smorra, J. Vieten, M. Wang, K. Wendt
2014Fe01	PYLBB	728,	191	R. Ferrer, N. Bree, T.E. Cocolios, I.G. Darby, H. De Witte, W. Dexters, J. Diriken, J. Elseviers, S. Franchoo, M. Huyse, N. Kesteloot, Yu. Kudryavtsev, D. Pauwels, D. Radulov, T. Roger, H. Savajols, P. Van Duppen, M. Venhart
2014Fi01	PRVCA	89,	014617	R.B. Firestone, Zs. Revay, T. Belgya
2014Ga09	ARISE	87,	122	E. Garcia-Torano, V. Peyres Medina, E. Romero, M. Roteta
2014Ga20	PRLTA	113,	082501	A.T. Gallant, M. Brodeur, C. Andreoiu, A. Bader, A. Chaudhuri, U. Chowdhury, A. Grossheim, R. Klawitter, A.A. Kwiatkowski, K.G. Leach, A. Lennarz, T.D. Macdonald, B.E. Schultz, J. Lassen, H. Heggen, S. Raeder, A. Teigelhöfer, B.A. Brown, A. Magilligan, J.D. Holt, J. Menéndez, J. Simonis, A. Schwenk, J. Dilling

2014Ha04	PRVCA	89,	024618	H. Haba, M. Huang, D. Kaji, J. Kanaya, Y. Kudou, K. Morimoto, K. Morita, M. Murakami, K. Ozeki, R. Sakai, T. Sumita, Y. Wakabayashi, A. Yoneda, Y. Kasamatsu, Y. Kikutani, Y. Komori, K. Nakamura, A. Shinohara, H. Kikunaga, H. Kudo, K. Nishio, A. Toyoshima, K. Tsukada
2014Ha38	NIMAE	747,	41	H. Hayashi, M. Shibata, M. Asai, A. Osa, T.K. Sato, M. Koizumi, A. Kimura, M. Oshima
2014Hu02	PRVCA	89,	014606	A.M. Hurst, R.B. Firestone, B.W. Sleaford, N.C. Summers, Zs. Révay, L. Szentmiklósi, M.S. Basunia, T. Belgya, J.E. Escher, M. Krticka
2014Hu07	ARISE	87,	112	M. Hult, T. Vidmar, U. Rosengard, G. Marissens, G. Lutter, N. Sahin
2014Io01	PRVCA	90,	014323	M. Ionescu-Bujor, A. Iordachescu, N. Marginean, R. Lica, D. Bucurescu, F. Brandolini, D. Deleanu, D. Filipescu, I. Gheorghe, D. Ghita, T. Glodariu, R. Marginean, N.H. Medina, C. Mihai, A. Negret, L. Stroe, C.A. Ur
2014Ka22	PRVCA	89,	051302	A. Kankainen, T. Eronen, D. Gorelov, J. Hakala, A. Jokinen, V.S. Kolhinen, M. Reponen, J. Rissanen, A. Saastamoinen, V. Sonnenschein, J. Äystö
2014Ka23	PRVCA	89,	054312	Z. Kalaninová, S. Antalic, A.N. Andreyev, F.P. Heßberger, D. Ackermann, B. Andel, L. Bianco, S. Hofmann, M. Huyse, B. Kindler, B. Lommel, R. Mann, R.D. Page, P.J. Sapple, J. Thomson, P. Van Duppen, M. Venhart
2014Kh04	PRLTA	112,	172501	J. Khuyagbaatar, A. Yakushev, C.E. Düllmann, D. Ackermann, L.-L. Andersson, M. Asai, M. Block, R.A. Boll, H. Brand, D.M. Cox, M. Dasgupta, X. Derkx, A. Di Nitto, K. Eberhardt, J. Even, M. Evers, C. Fahlander, U. Forsberg, J.M. Gates, N. Gharibyan, P. Golubev, K.E. Gregorich, J.H. Hamilton, W. Hartmann, R.-D. Herzberg, F.P. Heßberger, D.J. Hinde, J. Hoffmann, R. Hollinger, A. Hübner, E. Jäger, B. Kindler, J.V. Kratz, J. Krier, N. Kurz, M. Laatiaoui, S. Lahiri, R. Lang, B. Lommel, M. Maiti, K. Miernik, S. Minami, A. Mistry, C. Mokry, H. Nitsche, J.P. Omtvedt, G.K. Pang, P. Papadakis, D. Renisch, J. Roberto, D. Rudolph, J. Runke, K.P. Rykaczewski, L.G. Sarmiento, M. Schädel, B. Schausten, A. Semchenkov, D.A. Shaughnessy, P. Steinegger, J. Steiner, E.E. Tereshatov, P. Thörle-Pospiech, K. Tinschert, T. Torres De Heidenreich, N. Trautmann, A. Türler, J. Uusitalo, D.E. Ward, M. Wegrzecki, N. Wiehl, S.M. Van Cleve, V. Yakusheva
2014Ko14	PRLTA	112,	242501	N. Kobayashi, T. Nakamura, Y. Kondo, J.A. Tostevin, Y. Utsuno, N. Aoi, H. Baba, R. Barthelemy, M.A. Famiano, N. Fukuda, N. Inabe, M. Ishihara, R. Kanungo, S. Kim, T. Kubo, G.S. Lee, H.S. Lee, M. Matsushita, T. Motobayashi, T. Ohnishi, N.A. Orr, H. Otsu, T. Otsuka, T. Sako, H. Sakurai, Y. Satou, T. Sumikama, H. Takeda, S. Takeuchi, R. Tanaka, Y. Togano, K. Yoneda
2014Ko17	PRVCA	89,	064315	G.T. Koldste, B. Blank, M.J.G. Borge, J.A. Briz, M. Carmona-Gallardo, L.M. Fraile, H.O.U. Fynbo, J. Giovinazzo, B.D. Grann, J.G. Johansen, A. Jokinen, B. Jonson, T. Kurturkian-Nieto, J.H. Kusk, T. Nilsson, A. Perea, V. Pseudo, E. Picado, K. Riisager, A. Saastamoinen, O. Tengblad, J.-C. Thomas, J. Van de Walle
2014Kr04	PYLBB	731,	97	K. Kreim, M.L. Bissell, J. Papuga, K. Blaum, M. De Rydt, R.F. Garcia Ruiz, S. Goriely, H. Heylen, M. Kowalska, R. Neugart, G. Neyens, W. Nortershauser, M.M. Rajabali, R. Sanchez Alarcon, H.H. Stroke, D.T. Yordanov
2014Kr09	PRVCA	90,	024301	S. Kreim, D. Beck, K. Blaum, Ch. Borgmann, M. Breitenfeldt, T.E. Cocolios, A. Gottberg, F. Herfurth, M. Kowalska, Yu. A. Litvinov, D. Lunney, V. Manea, T.M. Mendonca, S. Naimi, D. Neidherr, M. Rosenbusch, L. Schweikhard, Th. Stora, F. Wienholtz, R.N. Wolf, K. Zuber and PrvCom GAu February 2015
2014Ku23	EPJAA	50,	135	T. Kurturkian-Nieto, J. Benlliure, K.-H. Schmidt, L. Audouin, F. Becker, B. Blank, I.N. Borzov, E. Casarejos, F. Farget, M. Fernández-Ordóñez, J. Giovinazzo, D. Henzlova, B. Jurado, K. Langanke, G. Martínez-Pinedo, J. Pereira, O. Yordanov
2014Kw04	PRVCA	89,	045502	A.A. Kwiatkowski, T. Brunner, J.D. Holt, A. Chaudhuri, U. Chowdhury, M. Eibach, J. Engel, A.T. Gallant, A. Grossheim, M. Horoi, A. Lennarz, T.D. Macdonald, M.R. Pearson, B.E. Schultz, M.C. Simon, R.A. Senkov, V.V. Simon, K. Zuber, J. Dilling
2014Lo10	EPJAA	50,	132	A. Lopez-Martens, K. Hauschild, K. Rezyunkina, O. Dorvaux, B. Gall, F. Déchery, H. Faure, A.V. Yeremin, M.L. Chelnokov, V.I. Chepiggin, A.V. Isaev, I.N. Izosimov, D.E. Katrasev, A.N. Kuznetsov, A.A. Kuznetsova, O.N. Malyshev, A.G. Popeko, E.A. Sokol, A.I. Svirikhin, J. Piot, J. Rubert

- | | | | | |
|----------|-------|------|--------|--|
| 2014Lu07 | PRVCA | 89, | 044326 | Y.X. Luo, J.O. Rasmussen, J.H. Hamilton, A.V. Ramayya, E. Wang, Y.X. Liu, C.F. Jiao, W.Y. Liang, F.R. Xu, Y. Sun, S. Frauendorf, J.K. Hwang, S.H. Liu, S.J. Zhu, N.T. Brewer, I.Y. Lee, G.M. Ter-Akopian, Yu. Oganessian, R. Donangelo, W.C. Ma |
| 2014Ly01 | PRXHA | 4, | 011055 | K.M. Lynch, J. Billowes, M.L. Bissell, I. Budincevic, T.E. Cocolios, R.P. De Groote, S. De Schepper, V.N. Fedosseev, K.T. Flanagan, S. Franchoo, R.F. Garcia Ruiz, H. Heylen, B.A. Marsh, G. Neyens, T.J. Procter, R.E. Rossel, S. Rothe, I. Strashnov, H.H. Stroke, K.D.A. Wendt |
| 2014Ma21 | PRVCA | 89, | 044318 | T.D. Macdonald, B.E. Schultz, J.C. Bale, A. Chaudhuri, U. Chowdhury, D. Frekers, A.T. Gallant, A. Grossheim, A.A. Kwiatkowski, A. Lennarz, M.C. Simon, V.V. Simon, J. Dilling |
| 2014Mi12 | NDSBA | 120, | 56 | K. Miernik, C.J. Gross, R. Grzywacz, M. Madurga, A.J. Mendez II, K.P. Rykaczewski, D.W. Stracener, E.F. Zganjar |
| 2014Mi16 | PRVCA | 90, | 034311 | K. Miernik, K.P. Rykaczewski, C.J. Gross, R. Grzywacz, M. Madurga, D. Miller, J.C. Batchelder, N.T. Brewer, C.U. Jost, K. Kolos, A. Korgul, C. Mazzocchi, A.J. Mendez II, Y. Liu, S.V. Paulauskas, D.W. Stracener, J.A. Winger, M. Wolinska-Cichocka, E.F. Zganjar |
| 2014Mo02 | PRVCA | 89, | 014324 | A.I. Morales, G. Benzoni, A. Gottardo, J.J. Valiente-Dobón, N. Blasi, A. Bracco, F. Camera, F.C.L. Crespi, A. Corsi, S. Leoni, B. Million, R. Nicolini, O. Wieland, A. Gadea, S. Lunardi, M. Górska, P.H. Regan, Zs. Podolyák, M. Pfützner, S. Pietri, P. Boutachkov, H. Weick, J. Grebosz, A.M. Bruce, J. Alcántara Núñez, A. Algora, N. Al-Dahan, Y. Ayyad, N. Alkhomashi, P.R.P. Allegro, D. Bazzacco, J. Benlliure, M. Bowry, M. Bunce, E. Casarejos, M.L. Cortes, A.M.D. Bacelar, A.Y. Deo, G. de Angelis, C. Domingo-Pardo, M. Doncel, Zs. Dombradi, T. Engert, K. Eppinger, G.F. Farrelly, F. Farinon, E. Farnea, H. Geissel, J. Gerl, N. Goel, E. Gregor, T. Habermann, R. Hoischen, R. Janik, S. Klupp, I. Kojouharov, N. Kurz, S. Mandal, R. Menegazzo, D. Mengoni, D.R. Napoli, F. Naqvi, C. Nociforo, A. Prochazka, W. Prokopowicz, F. Recchia, R.V. Ribas, M.W. Reed, D. Rudolph, E. Sahin, H. Schaffner, A. Sharma, B. Sitar, D. Siwal, K. Steiger, P. Strmen, T.P.D. Swan, I. Szarka, C.A. Ur, P.M. Walker, H.-J. Wollersheim |
| 2014Mo15 | PRLTA | 113, | 022702 | A.I. Morales, J. Benlliure, T. Kurtukián-Nieto, K.-H. Schmidt, S. Verma, P.H. Regan, Z. Podolyák, M. Górska, S. Pietri, R. Kumar, E. Casarejos, N. Al-Dahan, A. Algora, N. Alkhomashi, H. Álvarez-Pol, G. Benzoni, A. Blazhev, P. Boutachkov, A.M. Bruce, L.S. Cáceres, I.J. Cullen, A.M.D. Bacelar, P. Doornenbal, M.E. Estévez Aguado, G. Farrelly, Y. Fujita, A.B. Garnsworthy, W. Gelletly, J. Gerl, J. Grebosz, R. Hoischen, I. Kojouharov, N. Kurz, S. Lalkowski, Z. Liu, C. Mihai, F. Molina, D. Mücher, B. Rubio, H. Shaffner, S.J. Steer, A. Tamii, S. Tashenov, J.J. Valiente-Dobón, P.M. Walker, H.J. Wollersheim, P.J. Woods |
| 2014Na10 | PRLTA | 112, | 142501 | T. Nakamura, N. Kobayashi, Y. Kondo, Y. Satou, J.A. Tostevin, Y. Utsuno, N. Aoi, H. Baba, N. Fukuda, J. Gibelin, N. Inabe, M. Ishihara, D. Kameda, T. Kubo, T. Motobayashi, T. Ohnishi, N.A. Orr, H. Otsu, T. Otsuka, H. Sakurai, T. Sumikama, H. Takeda, E. Takeshita, M. Takechi, S. Takeuchi, Y. Togano, K. Yoneda |
| 2014Ne15 | PRVCA | 90, | 042501 | D.A. Nesterenko, S. Eliseev, K. Blaum, M. Block, S. Chenmarev, A. Dörr, C. Droese, P.E. Filianin, M. Goncharov, E. Minaya Ramirez, Yu. N. Novikov, L. Schweikhard, V.V. Simon |
| 2014Or04 | PRLTA | 112, | 222501 | S.E.A. Orrigo, B. Rubio, Y. Fujita, B. Blank, W. Gelletly, J. Agramunt, A. Algora, P. Ascher, B. Bilgier, L. Cáceres, R.B. Cakirli, H. Fujita, E. Ganioglu, M. Gerbaux, J. Giovannazzo, S. Grévy, O. Kamalou, H.C. Kozzer, L. Kucuk, T. Kurtukian-Nieto, F. Molina, L. Popescu, A.M. Rogers, G. Susoy, C. Stodel, T. Suzuki, A. Tamii, J.C. Thomas |
| 2014Pa45 | PRVCA | 90, | 034321 | J. Papuga, M.L. Bissell, K. Kreim, C. Barbieri, K. Blaum, M. De Rydt, T. Duguet, R.F. Garcia Ruiz, H. Heylen, M. Kowalska, R. Neugart, G. Neyens, W. Nörtershäuser, M.M. Rajabali, R. Sánchez, N. Smirnova, V. Somà, D.T. Yordanov |

2014Pe02	PRVCA	89,	024316	P. Peura, C. Scholey, D.T. Joss, S. Juutinen, R. Julin, T. Bäck, B. Cederwall, P.T. Greenlees, U. Jakobsson, P. Jones, D.S. Judson, S. Ketelhut, M. Labiche, M. Leino, M. Nyman, D. O'Donnell, R.D. Page, P. Rahkila, P. Ruotsalainen, M. Sandzelius, P.J. Sapple, J. Sarén, J. Simpson, J. Thomson, J. Uusitalo, H.V. Watkins
2014Po02	ARISE	87,	315	S. Pommé, E. García-Torano, M. Marouli, M.T. Crespo, V. Jobbagy, R. Van Ammel, J. Paepen, H. Stroh
2014Po05	PRVCA	90,	014311	M. Pomorski, M. Pfützner, W. Dominik, R. Grzywacz, A. Stolz, T. Baumann, J.S. Berryman, H. Czyrkowski, R. Dabrowski, A. Fijalkowska, T. Ginter, J. Johnson, G. Kaminski, N. Larson, S.N. Liddick, M. Madurga, C. Mazzocchi, S. Mi-anowski, K. Miernik, D. Miller, S. Paulauskas, J. Pereira, K.P. Rykaczewski, S. Suchyta
2014Ra07	PRVCA	89,	034320	G. Randisi, A. Leprince, H. Al Falou, N.A. Orr, F.M. Marqués, N.L. Achouri, J.-C. Angélique, N. Ashwood, B. Bastin, T. Bloxham, B.A. Brown, W.N. Catford, N. Curtis, F. Delaunay, M. Freer, E. de Góes Brennand, P. Haigh, F. Hanappe, C. Harlin, B. Laurent, J.-L. Lecouey, A. Ninane, N. Patterson, D. Price, L. Stuttgé, J.S. Thomas
2014Ra20	JPGPE	41,	115104	M.M. Rajabali, R. Grzywacz, S.N. Liddick, C. Mazzocchi, J.C. Batchelder, T. Baumann, C.R. Bingham, I.G. Darby, T.N. Ginter, S.V. Ilyushkin, M. Karny, W. Królas, P.F. Mantica, K. Miernik, M. Pfützner, K.P. Rykaczewski, D. Weisshaar, J.A. Winger
2014Ra.1	JLTPA to be pd			P.C.-O. Ranitzsch, C. Hassel, M. Wegner, S. Kempf, A. Fleischmann, C. Enss, L. Gastaldo, A. Herlert, K. Johnston and arXiv 1409.0071v1
2014Ri01	PYLBB	732,	305	K. Riisager, O. Forstner, M.J.G. Borge, J.A. Briz, M. Carmona-Gallardo, L.M. Fraile, H.O.U. Fynbo, T. Giles, A. Gottberg, A. Heinz, J.G. Johansen, B. Jonson, J. Kurcewicz, M.V. Lund, T. Nilsson, G. Nyman, E. Rapisarda, P. Steier, O. Tengblad, R. Thies, S.R. Winkler
2014Sa46	PYLBB	736,	137	A. Sanetullaev, M.B. Tsang, W.G. Lynch, Jenny Lee, D. Bazin, K.P. Chan, D. Coupland, V. Henzl, D. Henzlova, M. Kilburn, A.M. Rogers, Z.Y. Sun, M. Youngs, R.J. Charity, L.G. Sobotka, M. Famiano, S. Hudan, D. Shapira, W.A. Peters, C. Barbieri, M. Hjorth-Jensen, M. Horoi, T. Otsuka, T. Suzuki, Y. Utsuno
2014Sc09	PRVCA	90,	012501	B.E. Schultz, M. Brodeur, C. Andreoiu, A. Bader, A. Chaudhuri, U. Chowdhury, A.T. Gallant, A. Grossheim, R. Klawitter, A.A. Kwiatkowski, K.G. Leach, A. Lennarz, T.D. Macdonald, J. Lassen, H. Heggen, S. Raeder, A. Teigelhöfer, J. Dilling
2014Se12	PRVCA	89,	057302	G.W. Severin, L.D. Knutson, P.A. Voytas, E.A. George
2014Sh14	PYLBB	735,	327	P. Shuai, H.S. Xu, X.L. Tu, Y.H. Zhang, B.H. Sun, M. Wang, Yu. A. Litvinov, K. Blaum, X.H. Zhou, J.J. He, Y. Sun, K. Kaneko, Y.J. Yuan, J.W. Xia, J.C. Yang, G. Audi, X.L. Yan, X.C. Chen, G.B. Jia, Z.G. Hu, X.W. Ma, R.S. Mao, B. Mei, Z.Y. Sun, S.T. Wang, G.Q. Xiao, X. Xu, T. Yamaguchi, Y. Yamaguchi, Y.D. Zang, H.W. Zhao, T.C. Zhao, W. Zhang, W.L. Zhan
2014Sh25	PRVCA	90,	032501	P.D. Shidling, D. Melconian, S. Behling, B. Fenker, J.C. Hardy, V.E. Jacob, E. McCleskey, M. McCleskey, M. Mehlman, H.I. Park, B.T. Roeder
2014Si.A	PrvCom	GAu	Jul	B. Singh
2014So17	JPGPE	41,	125103	S. Sodaye, R. Tripathi, K. Sudarshan, S.K. Sharma, P.K. Pujari, R. Palit, S. Mukhopadhyay
2014Su07	PRVCA	89,	034317	S. Suchyta, S.N. Liddick, C.J. Chiara, W.B. Walters, M.P. Carpenter, H.L. Crawford, G.F. Grinyer, G. Gürdal, A. Klose, E.A. McCutchan, J. Pereira, S. Zhu
2014Ta29	PYLBB	738,	223	J. Taprogge, A. Jungclaus, H. Grawe, S. Nishimura, Z.Y. Xu, P. Doornenbal, G. Lorusso, E. Nácher, G.S. Simpson, P.-A. Söderström, T. Sumikama, H. Baba, F. Browne, N. Fukuda, R. Gernhäuser, G. Gey, N. Inabe, T. Isobe, H.S. Jung, D. Kameda, G.D. Kim, Y.-K. Kim, I. Kojouharov, T. Kubo, N. Kurz, Y.K. Kwon, Z. Li, H. Sakurai, H. Schaffner, K. Steiger, H. Suzuki, H. Takeda, Zs. Vajta, H. Watanabe, J. Wu, A. Yagi, K. Yoshinaga, G. Benzoni, S. Bönig, K.Y. Chae, L. Coraggio, A. Covello, J.-M. Daugas, F. Drouet, A. Gadea, A. Gargano, S. Ilieva, F.G. Kondev, T. Kröll, G.J. Lane, A. Montaner-Pizá, K. Moschner, D. Mücher, F. Naqvi, M. Niikura, H. Nishibata, A. Odahara, R. Orlandi, Z. Patel, Zs. Podolyák, A. Wendt

2014Ta.A	JPCSD	533,	012043	J. Taprogge, A. Jungclaus, G. Simpson
2014Un01	ARISE	87,	92	M.P. Unterweger, R. Fitzgerald
2014Va04	PRVCA	89,	064310	Z. Varga, A. Nicholl, K. Mayer
2014Wa09	PRLTA	112,	132502	F. Wamers, J. Marganec, F. Aksouh, Yu. Aksyutina, H. Alvarez-Pol, T. Aumann, S. Beceiro Novo, K. Boretzky, M.J.G. Borge, M. Chartier, A. Chatillon, L.V. Chulkov, D. Cortina-Gil, H. Emling, O. Ershova, L.M. Fraile, H.O.U. Fynbo, D. Galaviz, H. Geissel, M. Heil, D.H.H. Hoffmann, H.T. Johansson, B. Jonson, C. Karagiannis, O.A. Kiselev, J.V. Kratz, R. Kulesa, N. Kurz, C. Langer, M. Lantz, T. Le Bleis, R. Lemmon, Yu. A. Litvinov, K. Mahata, C. Muntz, T. Nilsson, C. Nociforo, G. Nyman, W. Ott, V. Panin, S. Paschalis, A. Perea, R. Plag, R. Reifarh, A. Richter, C. Rodriguez-Tajes, D. Rossi, K. Rissager, D. Savran, G. Schrieder, H. Simon, J. Stroth, K. Summerer, O. Tengblad, H. Weick, C. Wimmer, M.V. Zhukov
2014Xu07	PRLTA	113,	032505	Z.Y. Xu, S. Nishimura, G. Lorusso, F. Browne, P. Doornenbal, G. Gey, H.-S. Jung, Z. Li, M. Niikura, P.-A. Söderström, T. Sumikama, J. Taprogge, Zs. Vajta, H. Watanabe, J. Wu, A. Yagi, K. Yoshinaga, H. Baba, S. Franchoo, T. Isobe, P.R. John, I. Kojouharov, S. Kubono, N. Kurz, I. Matea, K. Matsui, D. Mengoni, P. Morfouace, D.R. Napoli, F. Naqvi, H. Nishibata, A. Odahara, E. Sahin, H. Sakurai, H. Schaffner, I.G. Stefan, D. Suzuki, R. Taniuchi, V. Werner
2014Ya19	JPGPE	41,	105104	H. Yang, L. Ma, Z. Zhang, L. Yu, G. Jia, M. Huang, Z. Gan, T. Huang, G. Li, X. Wu, Y. Fang, Z. Wang, B. Gao, W. Hua
2014Ya.A	PrvCom	Hwj	Jul	XinLiang Yan
2014Zh03	PRVCA	89,	014308	Z.Y. Zhang, Z.G. Gan, L. Ma, L. Yu, H.B. Yang, T.H. Huang, G.S. Li, Y.L. Tian, Y.S. Wang, X.X. Xu, X.L. Wu, M.H. Huang, C. Luo, Z.Z. Ren, S.G. Zhou, X.H. Zhou, H.S. Xu, G.Q. Xiao
2015				
2015Ah03	PRVCA	91,	044310	I. Ahmad, J.P. Greene, F.G. Kondev, S. Zhu
2015Ah04	PRVCA	92,	024313	I. Ahmad, R.R. Chasman, J.P. Greene, F.G. Kondev, S. Zhu
2015Ak02	PRVCA	91,	031301	A. Akber, M.W. Reed, P.M. Walker, Yu. A. Litvinov, G.J. Lane, T. Kibédi, K. Blaum, F. Bosch, C. Brandau, J.J. Carroll, D.M. Cullen, I.J. Cullen, A.Y. Deo, B. Detwiler, C. Dimopoulou, G.D. Dracoulis, F. Farinon, H. Geissel, E. Haettner, M. Heil, R.S. Kempley, R. Knöbel, C. Kozhuharov, J. Kurcewicz, N. Kuzminchuk, S. Litvinov, Z. Liu, R. Mao, C. Nociforo, F. Nolden, W.R. Plaß, Zs. Podolyák, A. Prochazka, C. Scheidenberger, D. Shubina, M. Steck, Th. Stöhlker, B. Sun, T.P.D. Swan, G. Trees, H. Weick, N. Winckler, M. Winkler, P.J. Woods, T. Yamaguchi
2015Al20	PRLTA	115,	102502	K. Alfonso, for the CUORE Collaboration
2015An05	EPJAA	51,	41	S. Antalic, F.P. Heßberger, D. Ackermann, S. Heinz, S. Hofmann, B. Kindler, J. Khuyagbaatar, B. Lommel, R. Mann
2015Ar07	PYLBB	745,	79	S. Arzumanov, L. Bondarenko, S. Chernyavsky, P. Geltenbort, V. Morozov, V.V. Nesvizhevsky, Yu. Panin, A. Strepetov
2015At03	PRLTA	115,	232501	D. Atanasov, P. Ascher, K. Blaum, R.B. Cakirli, T.E. Cocolios, S. George, S. Goriely, F. Herfurth, H.-T. Janka, O. Just, M. Kowalska, S. Kreim, D. Kisler, Y.A. Litvinov, D. Lunney, V. Manea, D. Neidherr, M. Rosenbusch, L. Schweikhard, A. Welker, F. Wienholtz, R.N. Wolf, K. Zuber
2015At.A	PrvCom	GAu	Apr	D. Atanasov
2015Au01	PRVCA	91,	024324	K. Auranen, J. Uusitalo, S. Juutinen, U. Jakobsson, T. Grahn, P.T. Greenlees, K. Hauschild, A. Herzán, R. Julin, J. Konki, M. Leino, J. Pakarinen, J. Partanen, P. Peura, P. Rahkila, P. Ruotsalainen, M. Sandzelius, J. Sarén, C. Scholey, J. Sorri, S. Stolze
2015Ba11	NUPAB	935,	52	A.S. Barabash
2015Ba49	PYLBB	750,	176	C. Babcock, H. Heylen, J. Billowes, M.L. Bissell, K. Blaum, P. Campbell, B. Cheal, R.F. Garcia Ruiz, C. Geppert, W. Gins, M. Kowalska, K. Kreim, S.M. Lenzi, I.D. Moore, R. Neugart, G. Neyens, W. Nörtershäuser, J. Papuga, D.T. Yordanov
2015Be07	PYLBB	743,	526	E. Bellotti, C. Broggin, G. Di Carlo, M. Laubenstein, R. Menegazzo
2015Be13	ARISE	102,	74	D.E. Bergeron, R. Fitzgerald

2015Be32	PYLBB	751,	107	G. Benzoni, A.I. Morales, H. Watanabe, S. Nishimura, L. Coraggio, N. Itaco, A. Gargano, F. Browne, R. Daido, P. Doornenbal, Y. Fang, G. Lorusso, Z. Patel, S. Rice, L. Sinclair, P.-A. Söderström, T. Sumikama, J. Wu, Z.Y. Xu, R. Yokoyama, H. Baba, R. Avigo, F.L. Bello Garrote, N. Blasi, A. Bracco, F. Camera, S. Ceruti, F.C.L. Crespi, G. de Angelis, M.-C. Delattre, Zs. Dombradi, A. Gottardo, T. Isobe, I. Kuti, K. Matsui, B. Melon, D. Mengoni, T. Miyazaki, V. Modamio-Hoybjor, S. Momiyama, D.R. Napoli, M. Niikura, R. Orlandi, H. Sakurai, E. Sahin, D. Sohler, R. Taniuchi, J. Taprogge, Zs. Vajta, J.J. Valiente-Dobón, O. Wieland, M. Yalcinkaya
2015BI02	EPJAA	51,	8	B. Blank, J.-C. Thomas, P. Ascher, L. Audirac, A. Bacquias, L. Cáceres, G. Canchel, L. Daudin, F. de Oliveira Santos, F. Didierjean, M. Gerbaux, J. Giovannazzo, S. Grévy, T. Kurtukian Nieto, I. Matea, F. Munoz, M. Roche, L. Serani, N. Smirnova, J. Souin
2015Ca09	PRVCA	92,	014327	L. Cáceres, A. Lepaillieur, O. Sorlin, M. Stanoiu, D. Sohler, Zs. Dombrádi, S.K. Bogner, B.A. Brown, H. Hergert, J.D. Holt, A. Schwenk, F. Azaiez, B. Bastin, C. Borcea, R. Borcea, C. Bourgeois, Z. Elekes, Zs. Fülöp, S. Grévy, L. Gaudefroy, G.F. Grinyer, D. Guillemaud-Mueller, F. Ibrahim, A. Kerek, A. Krasznahorkay, M. Lewitowicz, S.M. Lukyanov, J. Mrázek, F. Negoita, F. de Oliveira, Yu.-E. Penionzhkevich, Zs. Podolyák, M.G. Porquet, F. Rotaru, P. Roussel-Chomaz, M.G. Saint-Laurent, H. Savajols, G. Sletten, J.C. Thomas, J. Timár, C. Timis, Zs. Vajta
2015Ch56	PRVCA	92,	044308	R. Chapman, A. Hodsdon, M. Bouhelal, F. Haas, X. Liang, F. Azaiez, Z.M. Wang, B.R. Behera, M. Burns, E. Caurier, L. Corradi, D. Curien, A.N. Deacon, Zs. Dombrádi, E. Farnea, E. Fioretto, A. Gadea, F. Ibrahim, A. Jungclaus, K. Keyes, V. Kumar, S. Lunardi, N. Marginean, G. Montagnoli, D.R. Napoli, F. Nowacki, J. Ollier, D. O'Donnell, A. Papenberg, G. Pollarolo, M.-D. Salsac, F. Scarlassara, J.F. Smith, K.M. Spohr, M. Stanoiu, A.M. Stefanini, S. Szilner, M. Trotta, D. Verney
2015Ch57	PRVCA	92,	044330	J. Chen, F.G. Kondev, I. Ahmad, M.P. Carpenter, J.P. Greene, R.V.F. Janssens, S. Zhu, D. Ehst, V. Makarashvili, D. Rotsch, N.A. Smith
2015Ch58	PRVCA	92,	045803	U. Chowdhury, K.G. Leach, C. Andreoiu, A. Bader, M. Brodeur, A. Chaudhuri, A.T. Gallant, A. Grossheim, G. Gwinner, R. Klawitter, A.A. Kwiatkowski, A. Lennarz, T.D. Macdonald, J. Pearkes, B.E. Schultz, J. Dilling
2015Ci06	PRVCA	92,	014622	A.A. Ciemny, W. Dominik, T. Ginter, R. Grzywacz, Z. Janas, M. Kuich, C. Mazzocchi, M. Pfützner, M. Pomorski, F. Zarzynski, D. Bazin, T. Baumann, A. Bezbakh, B.P. Crider, M. Cwiok, S. Go, G. Kaminski, K. Kolos, A. Korgul, E. Kwan, S. Liddick, K. Miernik, S.V. Paulauskas, J. Pereira, K. Rykaczewski, C. Sumithrarachchi, Y. Xiao
2015Co02	ARISE	99,	46	S.M. Collins, A.K. Pearce, K.M. Ferreira, A.J. Fenwick, P.H. Regan, J.D. Keightley
2015Cz01	PRVCA	92,	014328	M. Czerwinski, T. Rzaca-Urban, W. Urban, P. Baczyk, K. Sieja, B.M. Nyakó, J. Timár, I. Kuti, T.G. Tornyi, L. Atanasova, A. Blanc, M. Jentschel, P. Mutti, U. Köster, T. Soldner, G. de France, G.S. Simpson, C.A. Ur
2015Da12	PRLTA	115,	132502	H.M. David, J. Chen, D. Seweryniak, F.G. Kondev, J.M. Gates, K.E. Gregorich, I. Ahmad, M. Albers, M. Alcorta, B.B. Back, B. Baartman, P.F. Bertone, L.A. Bernstein, C.M. Campbell, M.P. Carpenter, C.J. Chiara, R.M. Clark, M. Cromaz, D.T. Doherty, G.D. Dracoulis, N.E. Esker, P. Fallon, O.R. Gothe, J.P. Greene, P.T. Greenlees, D.J. Hartley, K. Hauschild, C.R. Hoffman, S.S. Hota, R.V.F. Janssens, T.L. Khoo, J. Konki, J.T. Kwarsick, T. Lauritsen, A.O. Macchiavelli, P.R. Mudder, C. Nair, Y. Qiu, J. Rissanen, A.M. Rogers, P. Ruotsalainen, G. Savard, S. Stolze, A. Wiens, S. Zhu
2015De22	PYLBB	748,	199	H.M. Devaraja, S. Heinz, O. Beliuskina, V. Comas, S. Hofmann, C. Hornung, G. Münzenberg, K. Nishio, D. Ackermann, Y.K. Gambhir, M. Gupta, R.A. Henderson, F.P. Heßberger, J. Khuyagbaatar, B. Kindler, B. Lommel, K.J. Moody, J. Maurer, R. Mann, A.G. Popeko, D.A. Shaughnessy, M.A. Stoyer, A.V. Yeremin

2015Di03	PYLBB	744,	137	T. Dickel, W.R. Plaß, S. Ayet San Andres, J. Ebert, H. Geissel, E. Haettner, C. Hornung, I. Miskun, S. Pietri, S. Purushothaman, M.P. Reiter, A.-K. Rink, C. Scheidenberger, H. Weick, P. Dendooven, M. Diwisch, F. Greiner, F. Heiße, R. Knöbel, W. Lippert, I.D. Moore, I. Pohjalainen, A. Prochazka, M. Ranjan, M. Takechi, J.S. Winfield, X. Xu
2015Do01	ARISE	96,	83	S.F. Dorsett, K.S. Krane
2015Ei01	PRVCA	92,	045502	M. Eibach, G. Bollen, M. Brodeur, K. Cooper, K. Gulyuz, C. Izzo, D.J. Morrissey, M. Redshaw, R. Ringle, R. Sandler, S. Schwarz, C.S. Sumithrachchi, A.A. Valverde, A.C.C. Villari
2015Ei03	PRLTA	115,	062501	S. Eliseev, K. Blaum, M. Block, S. Chenmarev, H. Dorrer, Ch. E. Düllmann, C. Enss, P.E. Filianin, L. Gastaldo, M. Goncharov, U. Köster, F. Lautenschläger, Yu. N. Novikov, A. Rischka, R.X. Schüssler, L. Schweikhard, A. Türler
2015Et01	PRVCA	91,	064317	A. Étilé, D. Verney, N.N. Arsenyev, J. Bettane, I.N. Borzov, M.C. Mhamed, P.V. Cuong, C. Delafosse, F. Didierjean, C. Gaulard, N. Van Giai, A. Goasduff, F. Ibrahim, K. Kolos, C. Lau, M. Niikura, S. Roccia, A.P. Severyukhin, D. Testov, S. Tusseau-Nenez, V.V. Voronov
2015Fi07	PRXHA	5,	011018	D.A. Fink, T.E. Cocolios, A.N. Andreyev, S. Antalic, A.E. Barzakh, B. Bastin, D.V. Fedorov, V.N. Fedosseev, K.T. Flanagan, L. Ghys, A. Gottberg, M. Huyse, N. Imai, T. Kron, N. Lecean, K.M. Lynch, B.A. Marsh, D. Pauwels, E. Rapisarda, S.D. Richter, R.E. Rossel, S. Rothe, M.D. Seliverstov, A.M. Sjödin, C. Van Beveren, P. Van Duppen, K.D.A. Wendt
2015Fi01	PRVCA	91,	034310	F. Flavigny, D. Pauwels, D. Radulov, I.J. Darby, H. De Witte, J. Diriken, D.V. Fedorov, V.N. Fedosseev, L.M. Fraile, M. Huyse, V.S. Ivanov, U. Köster, B.A. Marsh, T. Otsuka, L. Popescu, R. Raabe, M.D. Seliverstov, N. Shimizu, A.M. Sjödin, Y. Tsunoda, P. Van den Bergh, P. Van Duppen, J. Van de Walle, M. Venhart, W.B. Walters, K. Wimmer
2015Ga24	PRVCA	92,	021301	J.M. Gates, K.E. Gregorich, O.R. Gothe, E.C. Uribe, G.K. Pang, D.L. Bleuel, M. Block, R.M. Clark, C.M. Campbell, H.L. Crawford, M. Cromaz, A. Di Nitto, Ch. E. Düllmann, N.E. Esker, C. Fahlander, P. Fallon, R.M. Farjadi, U. Forsberg, J. Khuyagbaatar, W. Loveland, A.O. Macchiavelli, E.M. May, P.R. Mudder, D.T. Olive, A.C. Rice, J. Rissanen, D. Rudolph, L.G. Sarmiento, J.A. Shusterman, M.A. Stoyer, A. Wiens, A. Yakushev, H. Nitsche
2015Ga38	EPJAA	51,	136	L.P. Gaffney, J. Van de Walle, B. Bastin, V. Bildstein, A. Blazhev, N. Bree, J. Cederkäll, I. Darby, H. De Witte, D. DiJulio, J. Diriken, V.N. Fedosseev, Ch. Fransen, R. Gernhäuser, A. Gustafsson, H. Hess, M. Huyse, N. Kesteloot, Th. Kröll, R. Lutter, B.A. Marsh, P. Reiter, M. Seidlitz, P. Van Duppen, D. Voulot, N. Warr, F. Wenander, K. Wimmer, K. Wrzosek-Lipska
2015GI03	PRVCA	92,	042501	B.E. Glassman, D. Pérez-Loureiro, C. Wrede, J. Allen, D.W. Bardayan, M.B. Bennett, B.A. Brown, K.A. Chipps, M. Febraro, C. Fry, M.R. Hall, O. Hall, S.N. Liddick, P. O'Malley, W. Ong, S.D. Pain, S.B. Schwartz, P. Shidling, H. Sims, P. Thompson, H. Zhang
2015Gr05	PRVCA	91,	032501	J. Grinyer, G.F. Grinyer, M. Babo, H. Bouzomita, P. Chauveau, P. Delahaye, M. Dubois, R. Frigot, P. Jardin, C. Leboucher, L. Maunoury, C. Seiffert, J.C. Thomas, E. Traykov
2015Gr14	PRVCA	92,	045503	J. Grinyer, G.F. Grinyer, M. Babo, H. Bouzomita, P. Chauveau, P. Delahaye, M. Dubois, R. Frigot, P. Jardin, C. Leboucher, L. Maunoury, C. Seiffert, J.C. Thomas, E. Traykov
2015Gu09	PRVCA	91,	055501	K. Gulyuz, J. Ariche, G. Bollen, S. Bustabad, M. Eibach, C. Izzo, S.J. Novario, M. Redshaw, R. Ringle, R. Sandler, S. Schwarz, A.A. Valverde
2015He27	PRVCA	92,	044310	A. Herzán, S. Juutinen, K. Auranen, T. Grahn, P.T. Greenlees, K. Hauschild, U. Jakobsson, P. Jones, R. Julin, S. Ketelhut, M. Leino, A. Lopez-Martens, P. Nieminen, M. Nyman, P. Peura, P. Rahkila, S. Rinta-Antila, P. Ruotsalainen, M. Sandzelius, J. Sarén, C. Scholey, J. Sorri, J. Uusitalo
2015He28	PRVCA	92,	044311	H. Heylen, C. Babcock, J. Billowes, M.L. Bissell, K. Blaum, P. Campbell, B. Cheal, R.F. Garcia Ruiz, Ch. Geppert, W. Gins, M. Kowalska, K. Kreim, S.M. Lenzi, I.D. Moore, R. Neugart, G. Neyens, W. Nörtershäuser, J. Papuga, D.T. Yordanov

2015Hu02	PRVCA	91,	024322	P. Humby, A. Simon, C.W. Beausang, T.J. Ross, R.O. Hughes, J.T. Burke, R.J. Casperon, J. Koglin, S. Ota, J.M. Allmond, M. McCleskey, E. McCleskey, A. Saastamoinen, R. Chyzh, M. Dag, K. Gell, T. Tarlow, G. Vyas
2015Hu07	PRVCA	92,	034615	A.M. Hurst, R.B. Firestone, L. Szentmiklósi, B.W. Sleaford, M.S. Basunia, T. Belgya, J.E. Escher, M. Krticka, Zs. Révay, N.C. Summers
2015Je02	NIMAE	795,	268	M. Jeskovský, D. Frekers, A. Kováčik, P.P. Povinec, P. Puppe, J. Staníček, I. Sýkora, F. Simkovic, J.H. Thies
2015Ka24	PRVCA	92,	014321	Z. Kalaninová, S. Antalic, F.P. Heßberger, D. Ackermann, B. Andel, B. Kindler, M. Laatiaoui, B. Lommel, J. Maurer
2015KaZX	JUPSC	6,	030106	D. Kaji, K. Morimoto, Y. Wakabayashi, M. Takeyama, M. Asai
2015Kh09	PRLTA	115,	242502	J. Khuyagbaatar, A. Yakushev, Ch. E. Düllmann, D. Ackermann, L.-L. Andersson, M. Block, H. Brand, D.M. Cox, J. Even, U. Forsberg, P. Golubev, W. Hartmann, R.-D. Herzberg, F.P. Heßberger, J. Hoffmann, A. Hübner, E. Jäger, J. Jeppsson, b. Kindler, J.V. Kratz, J. Krier, N. Kurz, B. Lommel, M. Maiti, S. Minami, A.K. Mistry, C.M. Mrosek, I. Pysmenetska, D. Rudolph, L.G. Sarmiento, H. Schaffner, M. Schädel, B. Schausten, J. Steiner, T. Torres De Heidenreich, J. Uusitalo, M. Wegrzecki, N. Wiehl, V. Yakusheva
2015Ko06	ARISE	95,	143	K. Kossert, K. Bokeloh, R. Dersch, O. Nahle
2015Ko09	ARISE	99,	59	K. Kossert
2015Ko19	PRVCA	92,	054318	A. Korgul, K.P. Rykaczewski, R. Grzywacz, C.R. Bingham, N.T. Brewer, A.A. Ciemny, C.J. Gross, C. Jost, M. Karny, M. Madurga, C. Mazzocchi, A.J. Mendez II, K. Miernik, D. Miller, S. Padgett, S.V. Paulauskas, D.W. Stracener, M. Wolinska-Cichocka
2015Ko23	JUPSA	84,	054201	Y. Kojima, K. Kosuga, Y. Shima, A. Taniguchi, H. Hayashi, M. Shibata and Prv-Com SNa March 2016
2015Kr02	ARISE	97,	12	K.S. Krane
2015La19	PRVCA	92,	025502	A.T. Laffoley, C.E. Svensson, C. Andreoiu, G.C. Ball, P.C. Bender, H. Bidaman, V. Bildstein, B. Blank, D.S. Cross, G. Deng, A. Diaz Varela, M.R. Dunlop, R. Dunlop, A.B. Garnsworthy, P.E. Garrett, J. Giovinazzo, G.F. Grinyer, J. Grinyer, G. Hackman, B. Hadinia, D.S. Jamieson, B. Jigmeddorj, D. Kisliuk, K.G. Leach, J.R. Leslie, A.D. MacLean, D. Miller, B. Mills, M. Moukaddam, A.J. Radich, M.M. Rajabali, E.T. Rand, J.C. Thomas, J. Turko, C. Unsworth, P. Voss
2015Li20	PRVCA	91,	064309	A.A. Lis, C. Mazzocchi, W. Dominik, Z. Janas, M. Pfützner, M. Pomorski, L. Acosta, S. Baraeva, E. Casarejos, J. Duéñas-Díaz, V. Dunin, J.M. Espino, A. Estrade, F. Farinon, A. Fomichev, H. Geissel, A. Gorshkov, G. Kaminski, O. Kiselev, R. Knöbel, S. Krupko, M. Kuich, Yu. A. Litvinov, G. Marquinez-Durán, I. Martel, I. Mukha, C. Nociforo, A.K. Ordúz, S. Pietri, A. Prochazka, A.M. Sánchez-Benítez, H. Simon, B. Sitar, R. Slepnev, M. Stanoiu, P. Strmen, I. Szarka, M. Takechi, Y. Tanaka, H. Weick, J.S. Winfield
2015Li24	PRVCA	92,	014326	H.J. Li, B. Cederwall, T. Bäck, C. Qi, M. Doncel, U. Jakobsson, K. Auranen, S. Böniq, M.C. Drummond, T. Grahn, P. Greenlees, A. Herzán, R. Julin, S. Juutinen, J. Konki, T. Kröll, M. Leino, C. McPeake, D. O'Donnell, R.D. Page, J. Pakarinen, J. Partanen, P. Peura, P. Rahkila, P. Ruotsalainen, M. Sandzelius, J. Sarén, B. Saygi, C. Scholey, J. Sorri, S. Stolze, M.J. Taylor, A. Thornthwaite, J. Uusitalo, Z.G. Xiao
2015Li33	PRVCA	92,	024319	S.N. Liddick, W.B. Walters, C.J. Chiara, R.V.F. Janssens, B. Abromeit, A. Ayres, A. Bey, C.R. Bingham, M.P. Carpenter, L. Cartegni, J. Chen, H.L. Crawford, I.G. Darby, R. Grzywacz, J. Harker, C.R. Hoffman, S. Ilyushkin, F.G. Kondev, N. Larson, M. Madurga, D. Miller, S. Padgett, S.V. Paulauskas, M.M. Rajabali, K. Rykaczewski, D. Seweryniak, S. Suchyta, S. Zhu

2015Lo04	PRLTA	114,	192501	G. Lorusso, S. Nishimura, Z.Y. Xu, A. Jungclaus, Y. Shimizu, G.S. Simpson, P.-A. Söderström, H. Watanabe, F. Browne, P. Doornenbal, G. Gey, H.S. Jung, B. Meyer, T. Sumikama, J. Taprogge, Zs. Vajta, J. Wu, H. Baba, G. Benzoni, K.Y. Chae, F.C.L. Crespi, N. Fukuda, R. Gernhäuser, N. Inabe, T. Isobe, T. Kajino, D. Kameda, G.D. Kim, Y.-K. Kim, I. Kojouharov, F.G. Kondev, T. Kubo, N. Kurz, Y.K. Kwon, G.J. Lane, Z. Li, A. Montaner-Pizá, K. Moschner, F. Naqvi, M. Niikura, H. Nishibata, A. Odahara, R. Orlandi, Z. Patel, Zs. Podolyák, H. Sakurai, H. Schaffner, P. Schury, S. Shibagaki, K. Steiger, H. Suzuki, H. Takeda, A. Wendt, A. Yagi, K. Yoshinaga
2015Lo08	PRVCA	92,	024304	R. Lozeva, A. Odahara, C.-B. Moon, S. Nishimura, P. Doornenbal, H. Naïdja, F. Nowacki, P.-A. Söderström, T. Sumikama, G. Lorusso, J. Wu, Z.Y. Xu, H. Baba, F. Browne, R. Daido, J.-M. Daugas, F. Didierjean, Y. Fang, T. Isobe, I. Kojouharov, N. Kurz, Z. Patel, S. Rice, H. Sakurai, H. Schaffner, L. Sinclair, H. Watanabe, A. Yagi, R. Yokoyama, T. Kubo, N. Inabe, H. Suzuki, N. Fukuda, D. Kameda, H. Takeda, D.S. Ahn, D. Murai, F.L. Bello Garrote, E. Ideguchi, T. Ishigaki, H.S. Jung, T. Komatsubara, Y.K. Kwon, S. Morimoto, M. Niikura, H. Nishibata, I. Nishizuka, T. Shimoda, K. Tshoo
2015Lu13	PYLBB	750,	356	M.V. Lund, M.J.G. Borge, J.A. Briz, J. Cederkäll, H.O.U. Fynbo, J.H. Jensen, B. Jonson, K.L. Laursen, T. Nilsson, A. Perea, V. Pesudo, K. Riisager, O. Tengblad
2015Ma30	PRVCA	91,	045504	S. Malbrunot-Ettenauer, T. Brunner, U. Chowdhury, A.T. Gallant, V.V. Simon, M. Brodeur, A. Chaudhuri, E. Mané, M.C. Simon, C. Andreoiu, G. Audi, J.R.C. López-Urrutia, P. Delheij, G. Gwinner, A. Lapierre, D. Lunney, M.R. Pearson, R. Ringle, J. Ullrich, J. Dilling
2015Ma37	PRVCA	91,	051302	L. Ma, Z.Y. Zhang, Z.G. Gan, H.B. Yang, L. Yu, J. Jiang, J.G. Wang, Y.L. Tian, Y.S. Wang, S. Guo, B. Ding, Z.Z. Ren, S.G. Zhou, X.H. Zhou, H.S. Xu, G.Q. Xiao
2015Ma54	PRVCA	92,	041302	A. Matta, D. Beaumel, H. Otsu, V. Lapoux, N.K. Timofeyuk, N. Aoi, M. Assié, H. Baba, S. Boissinot, R.J. Chen, F. Delaunay, N. de Sereville, S. Franchoo, P. Gangnant, J. Gibelin, F. Hammache, Ch. Houarner, N. Imai, N. Kobayashi, T. Kubo, Y. Kondo, Y. Kawada, L.H. Khiem, M. Kurata-Nishimura, E.A. Kuzmin, J. Lee, J.F. Libin, T. Motobayashi, T. Nakamura, L. Nalpas, E. Yu. Nikolskii, A. Obertelli, E.C. Pollacco, E. Rindel, Ph. Rosier, F. Saillant, T. Sako, H. Sakurai, A.M. Sánchez-Benitez, J.-A. Scarpaci, I. Stefan, D. Suzuki, K. Takahashi, M. Takechi, S. Takeuchi, H. Wang, R. Wolski, K. Yoneda
2015Ma60	PRVCA	92,	054304	D.A. Matterns, N. Fotiades, J.J. Carroll, C.J. Chiara, J.W. McClory, T. Kawano, R.O. Nelson, M. Devlin
2015Ma61	PRVCA	92,	054317	C. Mazzocchi, K.P. Rykaczewski, R. Grzywacz, P. Baczyk, C.R. Bingham, N.T. Brewer, C.J. Gross, C. Jost, M. Karny, A. Korgul, M. Madurga, A.J. Mendez II, K. Miernik, D. Miller, S. Padgett, S.V. Paulauskas, A.A. Sonzogni, D.W. Stracener, M. Wolinska-Cichocka
2015Ma.A	PrvCom	GAu	Jan	V. Manea
2015Me01	PRLTA	114,	022501	Z. Meisel, S. George, S. Ahn, J. Browne, D. Bazin, B.A. Brown, J.F. Carpino, H. Chung, R.H. Cyburt, A. Estradé, M. Famiano, A. Gade, C. Langer, M. Matos, W. Mittig, F. Montes, D.J. Morrissey, J. Pereira, H. Schatz, J. Schatz, M. Scott, D. Shapira, K. Smith, J. Stevens, W. Tan, O. Tarasov, S. Towers, K. Wimmer, J.R. Winkelbauer, J. Yurkon, R.G.T. Zegers
2015Me08	PRLTA	115,	162501	Z. Meisel, S. George, S. Ahn, D. Bazin, B.A. Brown, J. Browne, J.F. Carpino, H. Chung, A.L. Cole, R.H. Cyburt, A. Estradé, M. Famiano, A. Gade, C. Langer, M. Matos, W. Mittig, F. Montes, D.J. Morrissey, J. Pereira, H. Schatz, J. Schatz, M. Scott, D. Shapira, K. Smith, J. Stevens, W. Tan, O. Tarasov, S. Towers, K. Wimmer, J.R. Winkelbauer, J. Yurkon, R.G.T. Zegers
2015Me.A	Th.-Michigan			Z. Meisel

2015Mo01	PRVCA	91,	014301	F. Molina, B. Rubio, Y. Fujita, W. Gelletly, J. Agramunt, A. Algora, J. Benlliure, P. Boutachkov, L. Cáceres, R.B. Cakirli, E. Casarejos, C. Domingo-Pardo, P. Doornenbal, A. Gadea, E. Ganioglu, M. Gascón, H. Geissel, J. Gerl, M. Górska, J. Grebosz, R. Hoischen, R. Kumar, N. Kurz, I. Kojouharov, L. Amon Susam, H. Matsubara, A.I. Morales, Y. Oktem, D. Pauwels, D. Pérez-Loureiro, S. Pietri, Zs. Podolyák, W. Prokopowicz, D. Rudolph, H. Schaffner, S.J. Steer, J.L. Tain, A. Tamii, S. Tashenov, J.J. Valiente-Dobón, S. Verma, H.-J. Wollersheim
2015Mo20	EULEE	111,	52001	A.I. Morales, G. Benzoni, N. Al-Dahan, S. Vergani, Zs. Podolyák, P.H. Regan, T.P.D. Swan, J.J. Valiente-Dobón, A. Bracco, P. Boutachkov, F.C.L. Crespi, J. Gerl, M. Górska, S. Pietri, P.M. Walker, H.-J. Wollersheim
2015Mo.A	PrvCom	Hwj	Nov	M. Mougeot
2015Mu13	PRLTA	115,	202501	I. Mukha, L.V. Grigorenko, X. Xu, L. Acosta, E. Casarejos, A.A. Ciemny, W. Dominik, J. Duènas-Díaz, V. Dunin, J.M. Espino, A. Estradè, F. Farinon, A. Fomichev, H. Geissel, T.A. Golubkova, A. Gorshkov, Z. Janas, G. Kaminski, O. Kiselev, R. Knöbel, S. Krupko, M. Kuich, Yu. A. Litvinov, G. Marquez-Durán, I. Martel, C. Mazzocchi, C. Nociforo, A.K. Ordúz, M. Pfützner, S. Pietri, M. Pomorski, A. Prochazka, S. Rymzhanova, A.M. Sánchez-Benítez, C. Scheidenberger, P. Sharov, H. Simon, B. Sitar, R. Slepnev, M. Stanoiu, P. Strmen, I. Szarka, M. Takechi, Y.K. Tanaka, H. Weick, M. Winkler, J.S. Winfield, M.V. Zhukov
2015My03	PRLTA	114,	013003	E.G. Myers, A. Wagner, H. Kracke, B.A. Wesson
2015NiZZ	JUPSC	6,	030062	I. Nishizuka, T. Sumikama, F. Browne, A.M. Bruce, S. Nishimura, P. Doornenbal, G. Lorusso, Z. Patel, S. Rice, L. Sinclair, P.-A. Söderström, H. Watanabe, J. Wu, Z.Y. Xu, A. Yagi, H. Baba, N. Chiga, R. Carrol, R. Daido, F. Didierjean, Y. Fang, N. Fukuda, G. Gey, E. Ideguchi, N. Inabe, T. Isobe, D. Kameda, I. Kojouharov, N. Kurz, T. Kubo, S. Lalkovski, Z. Li, R. Lozeva, H. Nishibata, A. Odahara, Zs. Podolyák, P.H. Regan, O.J. Roberts, H. Sakurai, H. Schaffner, G.S. Simpson, H. Suzuki, H. Takeda, M. Tanaka, J. Taprogge, V. Werner, O. Wieland
2015Pf01	PRVCA	92,	014316	M. Pfützner, W. Dominik, Z. Janas, C. Mazzocchi, M. Pomorski, A.A. Bezbakh, M.J.G. Borge, K. Chrapkiewicz, V. Chudoba, R. Frederickx, G. Kaminski, M. Kowalska, S. Krupko, M. Kuich, J. Kurcewicz, A.A. Lis, M.V. Lund, K. Miernik, J. Perkowski, R. Raabe, G. Randisi, K. Riisager, S. Sambhi, O. Tengblad, F. Wenander
2015Ro10	PRLTA	114,	202501	M. Rosenbusch, P. Ascher, D. Atanasov, C. Barbieri, D. Beck, K. Blaum, Ch. Borgmann, M. Breitenfeldt, R.B. Cakirli, A. Cipollone, S. George, F. Herfurth, M. Kowalska, S. Kreim, D. Lunney, V. Manea, P. Navrátil, D. Neidherr, L. Schweikhard, V. Somà, J. Stanja, F. Wienholtz, R.N. Wolf, K. Zuber
2015Ro20	EPJAA	51,	153	T. Roy, G. Mukherjee, N. Madhavan, T.K. Rana, S. Bhattacharya, Md. A. Asgar, I. Bala, K. Basu, S.S. Bhattacharjee, C. Bhattacharya, S. Bhattacharya, S. Bhattacharyya, J. Gehlot, S.S. Ghugre, R.K. Gurjar, A. Jhingan, R. Kumar, S. Muralithar, S. Nath, H. Pai, R. Palit, R. Raut, R.P. Singh, A.K. Sinha, T. Varughese
2015Sc13	EPJAA	51,	89	F. Schneider, T. Beyer, K. Blaum, M. Block, S. Chenmarev, H. Dorrer, Ch. E. Düllmann, K. Eberhardt, M. Eibach, S. Eliseev, J. Grund, U. Köster, Sz. Nagy, Yu. N. Novikov, D. Renisch, A. Türler, K. Wendt
2015Sh16	PRVCA	91,	047304	Y.P. Shen, W.P. Liu, J. Su, N.T. Zhang, L. Jing, Z.H. Li, Y.B. Wang, B. Guo, S.Q. Yan, Y.J. Li, S. Zeng, G. Lian, X.C. Du, L. Gan, X.X. Bai, J.S. Wang, Y.H. Zhang, X.H. Zhou, X.D. Tang, J.J. He, Y.Y. Yang, S.L. Jin, P. Ma, J.B. Ma, M.R. Huang, Z. Bai, Y.J. Zhou, W.H. Ma, J. Hu, S.W. Xu, S.B. Ma, S.Z. Chen, L.Y. Zhang, B. Ding, Z.H. Li
2015So23	PRVCA	92,	051305	P.-A. Söderström, S. Nishimura, Z.Y. Xu, K. Sieja, V. Werner, P. Doornenbal, G. Lorusso, F. Browne, G. Gey, H.S. Jung, T. Sumikama, J. Taprogge, Zs. Vajta, H. Watanabe, J. Wu, H. Baba, Zs. Dombradi, S. Franchoo, T. Isobe, P.R. John, Y.-K. Kim, I. Kojouharov, N. Kurz, Y.K. Kwon, Z. Li, I. Matea, K. Matsui, G. Martínez-Pinedo, D. Mengoni, P. Morfouace, D.R. Napoli, M. Niihara, H. Nishibata, A. Odahara, K. Ogawa, N. Pietralla, E. Sahin, H. Sakurai, H. Schaffner, D. Sohler, I.G. Stefan, D. Suzuki, R. Taniuchi, A. Yagi, K. Yoshinaga

2015St14	EPJAA	51,	117	K. Steiger, S. Nishimura, Z. Li, R. Gernhäuser, Y. Utsuno, R. Chen, T. Faestermann, C. Hinke, R. Krücken, M. Kurata-Nishimura, G. Lorusso, Y. Miyashita, N. Shimizu, K. Sugimoto, T. Sumikama, H. Watanabe, K. Yoshinaga
2015Ta12	PRVCA	91,	044322	M.J. Taylor, D.M. Cullen, M.G. Procter, A.J. Smith, A. McFarlane, V. Twist, G.A. Alharshan, L.S. Ferreira, E. Maglione, K. Auranen, T. Grahn, P.T. Greenlees, K. Hauschild, A. Herzan, U. Jakobsson, R. Julin, S. Juutinen, S. Ketelhut, J. Konki, M. Leino, A. Lopez-Martens, J. Pakarinen, J. Partanen, P. Peura, P. Rahkila, S. Rinta-Antila, P. Ruotsalainen, M. Sandzelius, J. Saren, C. Scholey, J. Sorri, S. Stolze, J. Uusitalo, M. Doncel
2015Ta13	PRVCA	91,	054324	J. Taprogge, A. Jungclaus, H. Grawe, S. Nishimura, P. Doornenbal, G. Lorusso, G.S. Simpson, P.-A. Söderström, T. Sumikama, Z.Y. Xu, H. Baba, F. Browne, N. Fukuda, R. Gernhäuser, G. Gey, N. Inabe, T. Isobe, H.S. Jung, D. Kameda, G.D. Kim, Y.-K. Kim, I. Kojouharov, T. Kubo, N. Kurz, Y.K. Kwon, Z. Li, H. Sakurai, H. Schaffner, K. Steiger, H. Suzuki, H. Takeda, Zs. Vajta, H. Watanabe, J. Wu, A. Yagi, K. Yoshinaga, G. Benzoni, S. Böni, K.Y. Chae, L. Coraggio, A. Covello, J.-M. Daugas, F. Drouet, A. Gadea, A. Gargano, S. Ilieva, F.G. Kondev, T. Kröll, G.J. Lane, A. Montaner-Pizá, K. Moschner, D. Muecher, F. Naqvi, M. Niikura, H. Nishibata, A. Odahara, R. Orlandi, Z. Patel, Zs. Podolyák, A. Wendt
2015Ut02	PRVCA	92,	034609	V.K. Utyonkov, N.T. Brewer, Yu. Ts. Oganessian, K.P. Rykaczewski, F. Sh. Abdullin, S.N. Dmitriev, R.K. Grzywacz, M.G. Itkis, K. Miernik, A.N. Polyakov, J.B. Roberto, R.N. Sagaidak, I.V. Shirokovsky, M.V. Shumeiko, Yu. S. Tsyganov, A.A. Voinov, V.G. Subbotin, A.M. Sukhov, A.V. Sabelnikov, G.K. Vostokin, J.H. Hamilton, M.A. Stoyer, S.Y. Strauss
2015Va05	PRVCA	91,	037301	A.A. Valverde, G. Bollen, K. Cooper, M. Eibach, K. Gulyuz, C. Izzo, D.J. Morrissey, R. Ringle, R. Sandler, S. Schwarz, C.S. Sumithrarachchi, A.C.C. Villari
2015Va08	PRLTA	114,	232502	A.A. Valverde, G. Bollen, M. Brodeur, R.A. Bryce, K. Cooper, M. Eibach, K. Gulyuz, C. Izzo, D.J. Morrissey, M. Redshaw, R. Ringle, R. Sandler, S. Schwarz, C.S. Sumithrarachchi, A.C.C. Villari
2015Va10	PRVCA	92,	014325	C. Van Beveren, A.N. Andreyev, A.E. Barzakh, T.E. Cocolios, D. Fedorov, V.N. Fedosseev, R. Ferrer, M. Huyse, U. Köster, J. Lane, V. Liberati, K.M. Lynch, B.A. Marsh, T.J. Procter, D. Radulov, E. Rapisarda, K. Sandhu, M.D. Seliverstov, P. Van Duppen, M. Venhart, M. Veselsky
2015Vo05	PRVCA	91,	044307	A. Voss, F. Buchinger, B. Cheal, J.E. Crawford, J. Dilling, M. Kortelainen, A.A. Kwiatkowski, A. Leary, C.D.P. Levy, F. Mooshammer, M.L. Ojeda, M.R. Pearson, T.J. Procter, W. Al Tamimi
2015Wa06	PRLTA	114,	041101	A. Wallner, M. Bichler, K. Buczak, R. Dressler, L.K. Fifield, D. Schumann, J.H. Sterba, S.G. Tims, G. Wallner, W. Kutschera
2015Wa28	PRVCA	92,	034317	E.H. Wang, A. Lemasson, J.H. Hamilton, A.V. Ramayya, J.K. Hwang, J.M. Eldridge, A. Navin, M. Rejmund, S. Bhattacharyya, S.H. Liu, N.T. Brewer, Y.X. Luo, J.O. Rasmussen, H.L. Liu, H. Zhou, Y.X. Liu, H.J. Li, Y. Sun, F.R. Xu, S.J. Zhu, G.M. Ter-Akopian, Yu. Ts. Oganessian, M. Caamano, E. Clément, O. Delaune, F. Farget, G. de France, B. Jacquot
2015Wi02	NIMAE	769,	65	K. Wimmer, D. Barofsky, D. Bazin, L.M. Fraile, J. Lloyd, J.R. Tompkins, S.J. Williams
2015Wi.A	PrvCom	GAu	Jan	F. Wienholtz
2015Wr02	PRVCA	92,	044327	J. Wrzesinski, G.J. Lane, K.H. Maier, R.V.F. Janssens, G.D. Dracoulis, R. Broda, A.P. Byrne, M.P. Carpenter, R.M. Clark, M. Cromaz, B. Fornal, T. Lauritsen, A.O. Macchiavelli, M. Rejmund, B. Szpak, K. Vetter, S. Zhu
2015Xu14	CPCHC	39,	104001	X. Xu, M. Wang, Y.-H. Zhang, H.-S. Xu, P. Shuai, X.-L. Tu, Y.A. Litvinov, X.-H. Zhou, B.-H. Sun, Y.-J. Yuan, J.-W. Xia, J.-C. Yang, K. Blaum, R.-J. Chen, X.-C. Chen, C.-Y. Fu, Z. Ge, Z.-G. Hu, W.-J. Huang, D.-W. Liu, Y.-H. Lam, X.-W. Ma, R.-S. Mao, T. Uesaka, G.-Q. Xiao, Y.-M. Xing, T. Yamaguchi, Y. Yamaguchi, Q. Zeng, X.-L. Yan, H.-W. Zhao, T.-C. Zhao, W. Zhang, W.-L. Zhan
2015Ya13	EPJAA	51,	88	H.B. Yang, Z.Y. Zhang, J.G. Wang, Z.G. Gan, L. Ma, L. Yu, J. Jiang, Y.L. Tian, B. Ding, S. Guo, Y.S. Wang, T.H. Huang, M.D. Sun, K.L. Wang, S.G. Zhou, Z.Z. Ren, X.H. Zhou, H.S. Xu, G.Q. Xiao

2015YaZW	JUPSC	6,	030019	A. Yagi, A. Odahara, R. Daido, Y. Fang, H. Nishibata, R. Lozeva, C.-B. Moon, S. Nishimura, P. Doornenbal, G. Lorusso, P.-A. Söderström, T. Sumikama, H. Watanabe, T. Isobe, H. Baba, H. Sakurai, F. Browne, Z. Patel, S. Rice, L. Sinclair, J. Wu, Z.Y. Xu, R. Yokoyama, T. Kubo, N. Inabe, H. Suzuki, N. Fukuda, D. Kameda, H. Takeda, D.S. Ahn, D. Murai, F.L. Bello Garrote, J.M. Daugas, F. Didierjean, E. Ideguchi, T. Ishigaki, H.S. Jung, T. Komatsubara, Y.K. Kwon, C.S. Lee, P.S. Lee, S. Morimoto, M. Niikura, I. Nishizuka, T. Shimoda, K. Tshoo
2015YoZX	JUPSC	6,	030021	R. Yokoyama, E. Ideguchi, G. Simpson, M. Tanaka, S. Nishimura, P. Doornenbal, P.-A. Söderström, G. Lorusso, Z. Xu, J. Wu, T. Sumikama, N. Aoi, H. Baba, F. Bello, F. Browne, R. Daido, Y. Fang, N. Fukuda, G. Gey, S. Go, N. Inabe, T. Isobe, D. Kameda, K. Kobayashi, M. Kobayashi, T. Komatsubara, T. Kubo, I. Kuti, Z. Li, M. Matsushita, S. Michimasa, C.-B. Moon, H. Nishibata, I. Nishizuka, A. Odahara, Z. Patel, S. Rice, E. Sahin, L. Sinclair, H. Suzuki, H. Takeda, J. Taprogge, Z. Vajta, H. Watanabe, A. Yagi
2015Za13	MTRGA	52,	280	S.L. Zafonte, R.S. Van Dyck Jr
2015ZaZY	JPCSD	630,	012011	G.S. Zahn, F.A. Genezini
2016				
2016Ab03	PYLBB	759,	64	K. Abe, for the XMASS Collaboration
2016Ag03	NIMAE	807,	69	J. Agramunt, J.L. Tain, M.B. Gómez Hornillos, A.R. Garcia, F. Albiol, A. Algora, R. Caballero-Folch, F. Calvino, D. Cano-Ott, G. Cortés, C. Domingo-Pardo, T. Eronen, W. Gelletly, D. Gorelov, V. Gorlychev, H. Hakala, A. Jokinen, M.D. Jordan, A. Kankainen, V. Kolhinen, L. Kucuk, T. Martinez, P.J.R. Mason, I. Moore, H. Penttilä, Zs. Podolyák, C. Pretel, M. Reponen, A. Riego, J. Rissanen, B. Rubio, A. Saastamoinen, A. Tarifeno-Saldivia, E. Valencia
2016Ai01	ARISE	110,	59	P.M. Aitken-Smith, S.M. Collins
2016Al03	PRLTA	116,	072501	M. Alanssari, D. Frekers, T. Eronen, L. Canete, J. Dilling, M. Haaranen, J. Hakala, M. Holl, M. Jeskovský, A. Jokinen, A. Kankainen, J. Koponen, A.J. Mayer, I.D. Moore, D.A. Nesterenko, I. Pohjalainen, P. Povinec, J. Reinikainen, S. Rinta-Antila, P.C. Srivastava, J. Suhonen, R.I. Thompson, A. Voss, M.E. Wieser
2016Al10	PRVCA	93,	044325	M.F. Alshudifat, R. Grzywacz, M. Madurga, C.J. Gross, K.P. Rykaczewski, J.C. Batchelder, C. Bingham, I.N. Borzov, N.T. Brewer, L. Cartegni, A. Fijalkowska, J.H. Hamilton, J.K. Hwang, S.V. Ilyushkin, C. Jost, M. Karny, A. Korgul, W. Krolas, S.H. Liu, C. Mazzocchi, A.J. Mendez, K. Miernik, D. Miller, S.W. Padgett, S.V. Paulauskas, A.V. Ramayya, D.W. Stracener, R. Surman, J.A. Winger, M. Wolinska-Cichocka, E.F. Zganjar
2016As01	NUPAB	946,	171	K. Asakura, A. Gando, Y. Gando, T. Hachiya, S. Hayashida, H. Ikeda, K. Inoue, K. Ishidoshiro, T. Ishikawa, S. Ishio, M. Koga, S. Matsuda, T. Mitsui, D. Motoki, K. Nakamura, S. Obara, M. Otani, T. Oura, I. Shimizu, Y. Shirahata, J. Shirai, A. Suzuki, H. Tachibana, K. Tamae, K. Ueshima, H. Watanabe, B.D. Xu, H. Yoshida, A. Kozlov, Y. Takemoto, S. Yoshida, K. Fushimi, T.I. Banks, B.E. Berger, B.K. Fujikawa, T. O'Donnell, L.A. Winslow, Y. Efremenko, H.J. Karwowski, D.M. Markoff, W. Tornow, J.A. Detwiler, S. Enomoto, M.P. Decowski
2016Be11	PRVCA	93,	045502	P. Belli, R. Bernabei, V.B. Brudanin, F. Cappella, V. Caracciolo, R. Cerulli, D.M. Chernyak, F.A. Danevich, S. d'Angelo, A. Di Marco, A. Incicchitti, M. Laubenstein, V.M. Mokina, D.V. Poda, O.G. Polischuk, V.I. Tretyak, I.A. Tupitsyna
2016Br01	PRVCA	93,	025503	M. Brodeur, C. Nicoloff, T. Ahn, J. Allen, D.W. Bardayan, F.D. Becchetti, Y.K. Gupta, M.R. Hall, O. Hall, J. Hu, J.M. Kelly, J.J. Kolata, J. Long, P. O'Malley, B.E. Schultz

2016Ca15	PRVCA	93,	034307	R.J. Carroll, R.D. Page, D.T. Joss, D. O'Donnell, J. Uusitalo, I.G. Darby, K. Andgren, K. Auranen, S. Bonig, B. Cederwall, M. Doncel, M.C. Drummond, S. Eeckhaudt, T. Grahn, C. Gray-Jones, P.T. Greenlees, B. Hadinia, A. Herzan, U. Jakobsson, P.M. Jones, R. Julin, S. Juutinen, J. Konki, T. Kroll, M. Leino, A.-P. Leppanen, C. McPeake, M. Nyman, J. Pakarinen, J. Partanen, P. Peura, P. Rahkila, J. Revill, P. Ruotsalainen, M. Sandzelius, J. Saren, B. Saygi, C. Scholey, D. Seweryniak, J. Simpson, J. Sorri, S. Stolze, M.J. Taylor, A. Thornthwaite
2016Ca22	EPJAA	52,	124	L. Canete, A. Kankainen, T. Eronen, D. Gorelov, J. Hakala, A. Jokinen, V.S. Kolehinen, J. Koponen, I.D. Moore, J. Reinikainen, S. Rinta-Antila
2016Ca25	PRLTA	117,	012501	R. Caballero-Folch, C. Domingo-Pardo, J. Agramunt, A. Algora, F. Ameil, A. Arcones, Y. Ayyad, J. Benlliure, I.N. Borzov, M. Bowry, F. Calvino, D. Cano-Ott, G. Cortes, T. Davinson, I. Dillmann, A. Estrade, A. Evdokimov, T. Faestermann, F. Farinon, D. Galaviz, A.R. Garcia, H. Geissel, W. Gellely, R. Gernhauser, M.B. Gomez Hornillos, C. Guerrero, M. Heil, C. Hinke, R. Knöbel, I. Kojouharov, J. Kurcewicz, N. Kurz, Yu. A. Litvinov, L. Maier, J. Marganec, T. Marketin, M. Marta, T. Martinez, G. Martinez-Pinedo, F. Montes, I. Mukha, D.R. Napoli, C. Nociforo, C. Paradela, S. Pietri, Zs. Podolyák, A. Prochazka, S. Rice, A. Riego, B. Rubio, H. Schaffner, Ch. Scheidenberger, K. Smith, E. Sokol, K. Steiger, B. Sun, J.L. Tain, M. Takechi, D. Testov, H. Weick, E. Wilson, J.S. Winfield, R. Wood, P. Woods, A. Yeremin
2016Ca33	PRVCA	94,	024314	L. Capponi, J.F. Smith, P. Ruotsalainen, C. Scholey, P. Rahkila, K. Auranen, L. Bianco, A.J. Boston, H.C. Boston, D.M. Cullen, X. Derkx, M.C. Drummond, T. Grahn, P.T. Greenlees, L. Grocutt, B. Hadinia, U. Jakobsson, D.T. Joss, R. Julin, S. Juutinen, M. Labiche, M. Leino, K.G. Leach, C. McPeake, K.F. Mulholland, P. Nieminen, D. O'Donnell, E.S. Paul, P. Peura, M. Sandzelius, J. Saren, B. Saygi, J. Sorri, S. Stolze, A. Thornthwaite, M.J. Taylor, J. Uusitalo
2016Ca.1	JLTPA	184,	952	N. Casali, A. Dubovik, S. Nagorny, S. Nisi, F. Orio, L. Pattavina, S. Pirro, K. Schöffner, I. Tupitsyna, A. Yakubovskaya
2016Ce02	PRLTA	116,	162501	I. Celikovic, M. Lewitowicz, R. Gernhäuser, R. Krücken, S. Nishimura, H. Sakurai, D.S. Ahn, H. Baba, B. Blank, A. Blazhev, P. Boutachkov, F. Browne, G. de France, P. Doornenbal, T. Faestermann, Y. Fang, N. Fukuda, J. Giovinazzo, N. Goel, M. Górska, S. Ilieva, N. Inabe, T. Isobe, A. Jungclaus, D. Kameda, Y.-K. Kim, Y.K. Kwon, I. Kojouharov, T. Kubo, N. Kurz, G. Lorusso, D. Lubos, K. Moschner, D. Murai, I. Nishizuka, J. Park, Z. Patel, M. Rajabali, S. Rice, H. Schaffner, Y. Shimizu, L. Sinclair, P.-A. Söderström, K. Steiger, T. Sumikama, H. Suzuki, H. Takeda, Z. Wang, H. Watanabe, J. Wu, Z. Xu
2016Ch11	PRVCA	93,	034610	P.A. Chodash, J.T. Burke, E.B. Norman, S.C. Wilks, R.J. Casperson, S.E. Fisher, K.S. Holliday, J.R. Jeffries, M.A. Wakeling
2016Co01	ARISE	108,	143	S.M. Collins, A.V. Harms, P.H. Regan
2016De15	PYLBB	758,	26	F. de Grancey, A. Mercenne, F. de Oliveira Santos, T. Davinson, O. Sorlin, J.C. Angeique, M. Assie, E. Berthoumieux, R. Borcea, A. Buta, I. Celikovic, V. Chudoba, J.M. Daugas, G. Dumitru, M. Fadil, S. Grevy, J. Kiener, A. Lefebvre-Schuhl, N. Michel, J. Mrazek, F. Negoita, J. Okolowicz, D. Pantelica, M.G. Pellegriti, L. Perrot, M. Ploszajczak, G. Randisi, I. Ray, O. Roig, F. Rotaru, M.G. Saint Laurent, N. Smirnova, M. Stanoiu, I. Stefan, C. Stodel, K. Subotic
2016De.A	Th.-Bordeaux			A. de Roubin, updates provisional values given in 2015Ma. A
2016Du10	PRLTA	116,	172501	M.R. Dunlop, C.E. Svensson, G.C. Ball, G.F. Grinyer, J.R. Leslie, C. Andreoiu, R.A.E. Austin, T. Ballast, P.C. Bender, V. Bildstein, A. Diaz Varela, R. Dunlop, A.B. Garnsworthy, P.E. Garrett, G. Hackman, B. Hadinia, D.S. Jamieson, A.T. Laffoley, A.D. MacLean, D.M. Miller, W.J. Mills, J. Park, A.J. Radich, M.M. Rajabali, E.T. Rand, C. Unsworth, A. Valencik, Z.M. Wang, E.F. Zganjar

2016Du13	PRVCA	93,	062801	R. Dunlop, V. Bildstein, I. Dillmann, A. Jungclaus, C.E. Svensson, C. Andreoiu, G.C. Ball, N. Bernier, H. Bidaman, P. Boubel, C. Burbadge, R. Caballero-Folch, M.R. Dunlop, L.J. Evitts, F. Garcia, A.B. Garnsworthy, P.E. Garrett, G. Hackman, S. Hallam, J. Henderson, S. Ilyushkin, D. Kisliuk, R. Krucken, J. Lassen, R. Li, E. MacConnachie, A.D. MacLean, E. McGee, M. Moukaddam, B. Olaizola, E. Padilla-Rodal, J. Park, O. Paetkau, C.M. Petrache, J.L. Pore, A.J. Radich, P. Ruotsalainen, J. Smallcombe, J.K. Smith, S.L. Tabor, A. Teigelhofer, J. Turko, T. Zidar
2016Dz01	ARISE	109,	345	T. Dziel, A. Listkowska, Z. Tyminski
2016Ei01	PRVCA	94,	015502	M. Eibach, G. Bollen, K. Gulyuz, C. Izzo, M. Redshaw, R. Ringle, R. Sandler, A.A. Valverde
2016Fe04	ARISE	109,	151	A.J. Fenwick, K.M. Ferreira, S.M. Collins
2016Fi07	PYLBB	758,	407	P. Filianin, S. Schmidt, K. Blaum, M. Block, S. Eliseev, F. Giacoppo, M. Goncharov, F. Lautenschlaeger, Yu. Novikov, K. Takahashi
2016Fo16	PYLBB	760,	293	U. Forsberg, D. Rudolph, C. Fahlander, P. Golubev, L.G. Sarmiento, S. Aberg, M. Block, Ch. E. Düllmann, F.P. Hessberger, J.V. Kratz, A. Yakushev
2016Ga24	ARISE	109,	314	E. García-Torano, V. Peyrés, M. Roteta, A.I. Sánchez-Cabezudo, E. Romero, A. Martínez Ortega
2016Ga.1	PRVCA to be pd			A.T. Gallant et al
2016Gu02	PRLTA	116,	012501	K. Gulyuz, G. Bollen, M. Brodeur, R.A. Bryce, K. Cooper, M. Eibach, C. Izzo, E. Kwan, K. Manukyan, D.J. Morrissey, O. Naviliat-Cuncic, M. Redshaw, R. Ringle, R. Sandler, S. Schwarz, C.S. Sumithrachchi, A.A. Valverde, A.C.C. Villari
2016Gu.A	PrvCom	FGK	Sep	L.A. Gurgi et al.
2016Ha.A	PrvCom	FGK	Aug	D.J. Hartley
2016Ho13	PRVCA	94,	021303	S.S. Hota, S.K. Tandel, P. Chowdhury, I. Ahmad, M.P. Carpenter, C.J. Chiara, J.P. Greene, C.R. Hoffman, E.G. Jackson, R.V.F. Janssens, B.P. Kay, T.L. Khoo, F.G. Kondev, S. Lakshmi, S. Lalkovski, T. Lauritsen, C.J. Lister, E.A. McCutchan, K. Moran, D. Peterson, U. Shirwadkar, D. Seweryniak, I. Stefanescu, Y. Toh, S. Zhu
2016Ho.A	Th-Heidelberg			M.J. Höcker
2016Hu.A	B-Bruges			W.J. Huang
2016Is03	PRVCA	93,	014303	L.W. Iskra, R. Broda, R.V.F. Janssens, C.J. Chiara, M.P. Carpenter, B. Fornal, N. Hoteling, F.G. Kondev, W. Krolas, T. Lauritsen, T. Pawlat, D. Seweryniak, I. Stefanescu, W.B. Walters, J. Wrzesinski, S. Zhu
2016Ju.A	PrvCom	FGK	Sep	A. Jungclaus et al.
2016Ka13	JUPSA	85,	015002	D. Kaji, K. Morimoto, H. Haba, E. Ideguchi, H. Koura, K. Morita
2016Ka15	PRVCA	93,	041304	A. Kankainen, L. Canete, T. Eronen, J. Hakala, A. Jokinen, J. Koponen, I.D. Moore, D. Nesterenko, J. Reinikainen, S. Rinta-Antila, A. Voss, J. Aysto
2016Kl04	PRVCA	93,	045807	R. Klawitter, A. Bader, M. Brodeur, U. Chowdhury, A. Chaudhuri, J. Fallis, A.T. Gallant, A. Grossheim, A.A. Kwiatkowski, D. Lascar, K.G. Leach, A. Lennarz, T.D. Macdonald, J. Parkes, S. Seeraji, M.C. Simon, V.V. Simon, B.E. Schultz, J. Dilling
2016Kn02	PYLBB	754,	288	R. Knöbel, M. Diwisch, F. Bosch, D. Boutin, L. Chen, C. Dimopoulou, A. Dolinskii, B. Franczak, B. Franzke, H. Geissel, M. Hausmann, C. Kozhuharov, J. Kurcewicz, S.A. Litvinov, G. Martinez-Pinedo, M. Matos, M. Mazzocco, G. Münzenberg, S. Nakajima, C. Nociforo, F. Nolden, T. Ohtsubo, A. Ozawa, Z. Patyk, W.R. Plaß, C. Scheidenberger, J. Stadlmann, M. Steck, B. Sun, T. Suzuki, P.M. Walker, H. Weick, M.-R. Wu, M. Winkler, T. Yamaguchi
2016Kn03	EPJAA	52,	138	R. Knöbel, M. Diwisch, H. Geissel, Yu. A. Litvinov, Z. Patyk, W.R. Plaß, C. Scheidenberger, B. Sun, H. Weick, F. Bosch, D. Boutin, L. Chen, C. Dimopoulou, A. Dolinskii, B. Franczak, B. Franzke, M. Hausmann, C. Kozhuharov, J. Kurcewicz, S.A. Litvinov, M. Matos, M. Mazzocco, G. Münzenberg, S. Nakajima, C. Nociforo, F. Nolden, T. Ohtsubo, A. Ozawa, J. Stadlmann, M. Steck, T. Suzuki, P.M. Walker, M. Winkler, T. Yamaguchi

2016Ko05	PRVCA	93,	014613	N. Kobayashi, T. Nakamura, Y. Kondo, J.A. Tostevin, N. Aoi, H. Baba, R. Barthelemy, M.A. Famiano, N. Fukuda, N. Inabe, M. Ishihara, R. Kanungo, S. Kim, T. Kubo, G.S. Lee, H.S. Lee, M. Matsushita, T. Motobayashi, T. Ohnishi, N.A. Orr, H. Otsu, T. Sako, H. Sakurai, Y. Satou, T. Sumikama, H. Takeda, S. Takeuchi, R. Tanaka, Y. Togano, K. Yoneda
2016Ko11	PRLTA	116,	102503	Y. Kondo, T. Nakamura, R. Tanaka, R. Minakata, S. Ogoshi, N.A. Orr, N.L. Achouri, T. Aumann, H. Baba, F. Delaunay, P. Doornenbal, N. Fukuda, J. Gibelin, J.W. Hwang, N. Inabe, T. Isobe, D. Kameda, D. Kanno, S. Kim, N. Kobayashi, T. Kobayashi, T. Kubo, S. Leblond, J. Lee, F.M. Marqués, T. Motobayashi, D. Murai, T. Murakami, K. Muto, T. Nakashima, N. Nakatsuka, A. Navin, S. Nishi, H. Otsu, H. Sato, Y. Satou, Y. Shimizu, H. Suzuki, K. Takahashi, H. Takeda, S. Takeuchi, Y. Togano, A.G. Tuff, M. Vandebrouck, K. Yoneda
2016Ko24	PRVCA	93,	064324	A. Korgul, K.P. Rykaczewski, R.K. Grzywacz, C.R. Bingham, N.T. Brewer, C.J. Gross, A.A. Ciemny, C. Jost, M. Karny, M. Madurga, C. Mazzocchi, A.J. Mendez, K. Miernik, D. Miller, S. Padgett, S.V. Paulauskas, M. Piersa, D.W. Stracener, M. Stryczyk, M. Wolinska-Cichocka, E.F. Zganjar
2016Ko.A	P-Adelaide		Sept	F.G. Kondev
2016Ko.B	PrvCom	FGK	Oct	F.G. Kondev
2016Kw.A	PrvCom	GAu	Apr	A.A. Kwiatkowski
2016La.A	PrvCom	Hwj	Aug	D. Lascar
2016Li01	NIMAE	808,		L.L. Liu, X.L. Huang, M.X. Kang, G.C. Chen, J.M. Wang, L.Y. Jiang
2016Lo01	PRVCA	93,	014316	R. Lozeva, H. Naïdja, F. Nowacki, J. Dudek, A. Odahara, C.-B. Moon, S. Nishimura, P. Doornenbal, J.-M. Daugas, P.-A. Söderström, T. Sumikama, G. Lorusso, J. Wu, Z.Y. Xu, H. Baba, F. Browne, R. Daido, Y. Fang, T. Isobe, I. Kojouharov, N. Kurz, Z. Patel, S. Rice, H. Sakurai, H. Schaffner, L. Sinclair, H. Watanabe, A. Yagi, R. Yokoyama, T. Kubo, N. Inabe, H. Suzuki, N. Fukuda, D. Kameda, H. Takeda, D.S. Ahn, D. Murai, F.L. Bello Garrote, F. Didierjean, E. Ideguchi, T. Ishigaki, H.S. Jung, T. Komatsubara, Y.K. Kwon, P. Lee, C.S. Lee, S. Morimoto, M. Niikura, H. Nishibata, I. Nishizuka
2016Ly01	PRVCA	93,	014319	K.M. Lynch, T.E. Cocolios, J. Billowes, M.L. Bissell, I. Budincevic, T. Day Goodacre, R.P. de Groote, G.J. Farooq-Smith, V.N. Fedosseev, K.T. Flanagan, S. Franchoo, R.F. Garcia Ruiz, H. Heylen, R. Li, B.A. Marsh, G. Neyens, R.E. Rossel, S. Rothe, H.H. Stroke, K.D.A. Wendt, S.G. Wilkins, X. Yang
2016Ma05	PRVCA	93,	014310	C.M. MacDonald, R.J. Cornett, C.R.J. Charles, X.L. Zhao, W.E. Kieser
2016Ma50	PRLTA	117,	092502	M. Madurga, S.V. Paulauskas, R. Grzywacz, D. Miller, D.W. Bardayan, J.C. Batchelder, N.T. Brewer, J.A. Cizewski, A. Fijalkowska, C.J. Gross, M.E. Howard, S.V. Ilyushkin, B. Manning, M. Matos, A.J. Mendez, II, K. Miernik, S.W. Padgett, W.A. Peters, B.C. Rasco, A. Ratkiewicz, K.P. Rykaczewski, D.W. Stracener, E.H. Wang, M. Wolinska-Cichocka, E.F. Zganjar
2016Ma.1	PRVCA to be pd			V. Manea et al
2016Ma.A	PrvCom	GAu	Feb	M. MacCormick
2016Me07	PRVCA	93,	035805	Z. Meisel, S. George, S. Ahn, D. Bazin, B.A. Brown, J. Browne, J.F. Carpino, H. Chung, R.H. Cyburt, A. Estradé, M. Famiano, A. Gade, C. Langer, M. Matos, W. Mittig, F. Montes, D.J. Morrissey, J. Pereira, H. Schatz, J. Schatz, M. Scott, D. Shapira, K. Sieja, K. Smith, J. Stevens, W. Tan, O. Tarasov, S. Towers, K. Wimmer, J.R. Winkelbauer, J. Yurkon, R.G.T. Zegers
2016Mo07	PRVCA	93,	034328	A.I. Morales, G. Benzoni, H. Watanabe, S. Nishimura, F. Browne, R. Daido, P. Doornenbal, Y. Fang, G. Lorusso, Z. Patel, S. Rice, L. Sinclair, P.-A. Soderstrom, T. Sumikama, J. Wu, Z.Y. Xu, A. Yagi, R. Yokoyama, H. Baba, R. Avigo, F.L. Bello Garrote, N. Blasi, A. Bracco, F. Camera, S. Ceruti, F.C.L. Crespi, G. de Angelis, M.-C. Delattre, Zs. Dombradi, A. Gottardo, T. Isobe, I. Kojouharov, N. Kurz, I. Kuti, K. Matsui, B. Melon, D. Mengoni, T. Miyazaki, V. Modamio-Hoyborg, S. Momiyama, D.R. Napoli, M. Niikura, R. Orlandi, H. Sakurai, E. Sahin, D. Sohler, H. Shaffner, R. Taniuchi, J. Taprogge, Zs. Vajta, J.J. Valiente-Dobon, O. Wieland, M. Yalcinkaya

2016Na02	PRVCA	93,	014308	E. Nacher, B. Rubio, A. Algora, D. Cano-Ott, J.L. Tain, A. Gadea, J. Agramunt, M. Gierlik, M. Karny, Z. Janas, E. Roeckl, A. Blazhev, R. Collatz, J. Doring, M. Hellstrom, Z. Hu, R. Kirchner, I. Mukha, C. Plettner, M. Shibata, K. Rykaczewski, L. Batist, F. Moroz, V. Wittmann, J.J. Valiente-Dobon
2016Or03	PRVCA	93,	044336	S.E.A. Orrigo, B. Rubio, Y. Fujita, W. Gelletly, J. Agramunt, A. Algora, P. Ascher, B. Bilgier, B. Blank, L. Caceres, R.B. Cakirli, E. Ganioglu, M. Gerbaux, J. Giovinazzo, S. Grevy, O. Kamalou, H.C. Kozler, L. Kucuk, T. Kurtukian-Nieto, F. Molina, L. Popescu, A.M. Rogers, G. Susoy, C. Stodel, T. Suzuki, A. Tamii, J.C. Thomas
2016Or08	PRVCA	94,	044315	S.E.A. Orrigo, B. Rubio, W. Gelletly, B. Blank, Y. Fujita, J. Giovinazzo, J. Agramunt, A. Algora, P. Ascher, B. Bilgier, L. Caceres, R.B. Cakirli, G. de France, E. Ganioglu, M. Gerbaux, S. Grevy, O. Kamalou, H.C. Kozler, L. Kucuk, T. Kurtukian-Nieto, F. Molina, L. Popescu, A.M. Rogers, G. Susoy, C. Stodel, T. Suzuki, A. Tamii, J.C. Thomas
2016Pa01	PYLBB	753,	182	Z. Patel, Zs. Podolyák, P.M. Walker, P.H. Regan, P.-A. Söderström, H. Watanabe, E. Ideguchi, G.S. Simpson, S. Nishimura, F. Browne, P. Doornenbal, G. Lorusso, S. Rice, L. Sinclair, T. Sumikama, J. Wu, Z.Y. Xu, N. Aoi, H. Baba, F.L. Bello Garrote, G. Benzoni, R. Daido, Zs. Dombrádi, Y. Fang, N. Fukuda, G. Gey, S. Go, A. Gottardo, N. Inabe, T. Isobe, D. Kameda, K. Kobayashi, M. Kobayashi, T. Komatsubara, I. Kojouharov, T. Kubo, N. Kurz, I. Kuti, Z. Li, H.L. Liu, M. Matsushita, S. Michimasa, C.-B. Moon, H. Nishibata, I. Nishizuka, A. Odahara, E. Sahin, H. Sakurai, H. Schaffner, H. Suzuki, H. Takeda, M. Tanaka, J. Taprogge, Zs. Vajta, F.R. Xu, A. Yagi, R. Yokoyama
2016Pe14	PRVCA	94,	024319	C. Petrone, J.M. Daugas, G.S. Simpson, M. Stanoiu, C. Plaisir, T. Faul, C. Borcea, R. Borcea, L. Caceres, S. Calinescu, R. Chevrier, L. Gaudefroy, G. Georgiev, G. Gey, O. Kamalou, F. Negoita, F. Rotaru, O. Sorlin, J.C. Thomas
2016Qu01	ARISE	109,	172	F.G.A. Quarati, P. Dorenbos, X. Mougeot
2016Re01	PYLBB	752,	296	J. Refsgaard, O.S. Kirsebom, E.A. Dijck, H.O.U. Fynbo, M.V. Lund, M.N. Portela, R. Raabe, G. Randisi, F. Renzi, S. Sambhi, A. Sytema, L. Willmann, H.W. Wilschut
2016Re02	PYLBB	752,	311	M.W. Reed, G.J. Lane, G.D. Dracoulis, F.G. Kondev, M.P. Carpenter, P. Chowdhury, S.S. Hota, R.O. Hughes, R.V.F. Janssens, T. Lauritsen, C.J. Lister, N. Palalani, D. Seweryniak, H. Watanabe, S. Zhu, W.G. Jiang, F.R. Xu
2016Re14	PRVCA	94,	024619	F. Renzi, R. Raabe, G. Randisi, D. Smirnov, C. Angulo, J. Cabrera, E. Casarejos, Th. Keutgen, A. Ninane, J.L. Charvet, A. Gillibert, V. Lapoux, L. Nalpas, A. Obertelli, F. Skaza, J.L. Sida, N.A. Orr, S.I. Sidorchuk, R. Wolski, M.J.G. Borge, D. Escrig
2016Sc.A	PrvCom	SNa	Feb	P. Schury et al very preliminary
2016So.A	PrvCom	FGK	Apr	P.-A. Söderström et al
2016Su10	PYLBB	756,	323	J. Su, W.P. Liu, N.T. Zhang, Y.P. Shen, Y.H. Lam, N.A. Smirnova, M. MacCormick, J.S. Wang, L. Jing, Z.H. Li, Y.B. Wang, B. Guo, S.Q. Yan, Y.J. Li, S. Zeng, G. Lian, X.C. Du, L. Gan, X.X. Bai, Z.C. Gao, Y.H. Zhang, X.H. Zhou, X.D. Tang, J.J. He, Y.Y. Yang, S.L. Jin, P. Ma, J.B. Ma, M.R. Huang, Z. Bai, Y.J. Zhou, W.H. Ma, J. Hu, S.W. Xu, S.B. Ma, S.Z. Chen, L.Y. Zhang, B. Ding, Z.H. Li, G. Audi
2016Ub01	PYLBB	754,	323	E. Uberseder, G.V. Rogachev, V.Z. Goldberg, E. Koshchiy, B.T. Roeder, M. Alcorta, G. Chubarian, B. Davids, C. Fu, J. Hooker, H. Jayatissa, D. Melconian, R.E. Tribble
2016Ur03	PRVCA	94,	011302	W. Urban, U. Koster, M. Jentschel, P. Mutti, B. Markisch, T. Rzaca-Urban, Ch. Bernards, Ch. Fransen, J. Jolie, T. Thomas, G.S. Simpson
2016Va01	JPGPE	43,	025102	C. Van Beveren, A.N. Andreyev, A.E. Barzakh, T.E. Cocolios, R.P. de Groote, D. Fedorov, V.N. Fedosseev, R. Ferrer, L. Ghys, M. Huyse, U. Köster, J. Lane, V. Liberati, K.M. Lynch, B.A. Marsh, P.L. Molkanov, T.J. Procter, E. Rapisarda, K. Sandhu, M.D. Seliverstov, P. Van Duppen, M. Venhart, M. Veselský
2016Wa16	PRVCA	93,	054301	Z.M. Wang, A.B. Garnsworthy, C. Andreoiu, G.C. Ball, P.C. Bender, V. Bildstein, D.S. Cross, G. Demand, R. Dunlop, L.J. Evit ts, P.E. Garrett, G. Hackman, B. Hadinia, S. Ketelhut, R. Krucken, K.G. Leach, A.T. Laffoley, D. Miller, M. Moukaddam, J. Pore, A.J. Radich, M.M. Rajabali, C.E. Svensson, A. Tan, E. Tardiff, C. Unsworth, A. Voss, P. Voss

2016Wa19	PYLBB	760,	641	H. Watanabe, G.X. Zhang, K. Yoshida, P.M. Walker, J.J. Liu, J. Wu, P.H. Regan, P.-A. Soderstrom, H. Kanaoka, Z. Korkulu, P.S. Lee, S. Nishimura, A. Yagi, D.S. Ahn, T. Alharbi, H. Baba, F. Browne, A.M. Bruce, R.J. Carroll, K.Y. Chae, Zs. Dombradi, P. Doornenbal, A. Estrade, N. Fukuda, C. Griffin, E. Ideguchi, N. Inabe, T. Isobe, S. Kanaya, I. Kojouharov, F.G. Kondev, T. Kubo, S. Kubono, N. Kurz, I. Kuti, S. Lalkovski, G.J. Lane, C.S. Lee, E.J. Lee, G. Lorusso, G. Lotay, C.-B. Moon, I. Nishizuka, C.R. Nita, A. Odahara, Z. Patel, V.H. Phong, Zs. Podolyak, O.J. Roberts, H. Sakurai, H. Schaffner, C.M. Shand, Y. Shimizu, T. Sumikama, H. Suzuki, H. Takeda, S. Terashima, Zs. Vajta, J.J. Valiente-Dobon, Z.Y. Xu
2016We07	NATUA	533,	47	L. v. d. Wense, B. Seiferle, M. Laatiaoui, J.B. Neumayr, H.-J. Maier, H.-F. Wirth, C. Mokry, J. Runke, Kl. Eberhardt, C.E. Dullmann, N.G. Trautmann, P.G. Thirolf
2016We.A	PrvCom	HWJ	Nov	A. Welker et al
2016Wu.A	PrvCom	FGK	Sep	J. Wu et al
2016Xi.A	PrvCom	WgM	Jul	Y.M. Xing
2016Xu10	PRLTA	117,	182503	X. Xu, P. Zhang, P. Shuai, R.J. Chen, X.L. Yan, Y.H. Zhang, M. Wang, Yu. A. Litvinov, H.S. Xu, T. Bao, X.C. Chen, H. Chen, C.Y. Fu, S. Kubono, Y.H. Lam, D.W. Liu, R.S. Mao, X.W. Ma, M.Z. Sun, X.L. Tu, Y.M. Xing, J.C. Yang, Y.J. Yuan, Q. Zeng, X. Zhou, X.H. Zhou, W.L. Zhan, S. Litvinov, K. Blaum, G. Audi, T. Uesaka, Y. Yamaguchi, T. Yamaguchi, A. Ozawa, B.H. Sun, Y. Sun, A.C. Dai, F.R. Xu
2016Ya.A	PrvCom	SNa	Apr	A. Yagi updates 2015Ya.1
2016Zh.A	PrvCom	WgM	May	P. Zhang et al
				2017
2017Ma.A	PrvCom	GAu	Feb	V. Manea, updates provisional values given in 2015Ma. A
2017Mo.A	PrvCom	GAu	Feb	M. Mougeot, updates provisional values given in 2015Ma. A
