

# CHANCE<sup>®</sup>



## Encyclopedia of Grounding | for de-energized construction & maintenance

[www.hubbellpowersystems.com](http://www.hubbellpowersystems.com)



## About the Author –

### Clayton C. King

Graduate of the University of Missouri - Columbia in 1965 with a degree in Electrical Engineering. He became a registered Professional Engineer in the state of Missouri in 1974.

His employment experience included managing the research laboratory of the A. B. Chance Company (Hubbell Power Systems), Centralia, MO from 1971 through 2001. Additionally, he was the Chief Engineer for Personal Protective Grounding and Electronics Measurement products from 1990 - 2001.

His special fields of interest include the high current testing of personal protective grounding equipment and test instrumentation. He began researching and lecturing on the theory of protective

grounding in the mid - 1970s. During his career at A.B. Chance Company, he evaluated many grounding products, both as components and in a variety of actual line use situations. He has presented 85 lectures, participated in 4 technical panels, written 11 technical papers and two books on the subject of personal protective grounding. The lectures span small group instructional classes through such large presentations as the American Safety Council. Presentations were to utilities, standards organizations and union groups.

He currently chairs the grounding standards committees of American Society of Testing and Materials (ASTM) and the Institute of Electrical and Electronic Engineers (IEEE) that revise and maintain the current status of protective grounding documents in the United States. He is the U.S. representative to the International Electrotechnical Commission (IEC) for grounding and other worker safety equipment. At present, he also is active as a consulting engineer in utility related matters.



® [www.hubbellpowersystems.com](http://www.hubbellpowersystems.com)  
E-mail: [hpsliterature@hubbell.com](mailto:hpsliterature@hubbell.com)  
Phone: 573-682-5521 Fax: 573-682-8714  
210 North Allen  
Centralia, MO 65240, USA

©Copyright 2018 Hubbell Incorporated



# CHANCE<sup>®</sup> Encyclopedia of Grounding

## Table of Contents

<b>Section 1</b>	<b>History of Personal Protective Grounding</b> Purpose and Scope Definitions Historical Aspects of Protective Grounding
<b>Section 2</b>	<b>Effects of Current on the Human Body</b> How Determined Body Resistance Values Current Level vs. Bodily Damage
<b>Section 3</b>	<b>Requirements</b> of Utilities by Regulating Agencies
<b>Section 4</b>	<b>Standards</b> ASTM, IEEE, IEC
<b>Section 5</b>	<b>Electrical Principles</b> Ohm's Law Series Circuits Parallel Circuits Combination Series / Parallel Circuits
<b>Section 6</b>	<b>Hazards</b> Accidental Re-energization Induced Currents and Voltages Step Potential Touch Potential
<b>Section 7</b>	<b>Theory of Personal Protective Grounding</b> Creating Equipotential Zones Use of Neutrals and Static Wires Earth as a Return Path Effect of Multiple Grounded Locations
<b>Section 8</b>	<b>Personal Protective Equipment</b> Clamps Cable Ferrules Assemblies
<b>Section 9</b>	<b>Basic Protection Methods</b> Double Point Single Jumper Single Point
<b>Section 10</b>	<b>General Installation Procedures</b>
<b>Section 11</b>	<b>Applications and Considerations</b> Equipotential at the Worksite Remote Worksite, Limited Distance Bracket at Worksite Ground Support Workers Around Trucks or Equipment Underground Substations
<b>Section 12</b>	<b>Relevant Instruments and Meters from Catalog Section 2450</b>
<b>Section 13</b>	<b>Grounding Equipment Catalog Section 3000</b>
<b>Appendix A</b>	<b>Bibliography</b>
<b>Appendix B</b>	<b>Asymmetrical Current Discussion</b>



## History of Personal Protective Grounding

### Section 1

**CHANCE**<sup>®</sup>

[www.hubbellpowersystems.com](http://www.hubbellpowersystems.com)  
E-mail: [hpsliterature@hps.hubbell.com](mailto:hpsliterature@hps.hubbell.com)



Phone: 573-682-5521

Fax: 573-682-8714

210 North Allen

Centralia, MO 65240, USA

©Copyright 2018 Hubbell Incorporated

# History of Personal Protective Grounding

Worker protection has always been an important activity. Worker safety has become a more important issue than ever before and has received increased attention in recent years. As the country has grown so have the electrical needs of the population: More people, more businesses and factories, all using more power. Electric power lines have been upgraded and new ones constructed to supply the increasing demand for electric power. Today we are seeing higher voltage lines, with higher levels of both rated and fault current.

This growth has increased the difficulty in providing a safe worksite. In many cases the “old” methods are not only inappropriate but are also unsafe. One of the “old timers” at a mid-west rural utility related that they used to cut a “fat green weed” to ground the line. Thankfully, the days of grounding with “fat green weeds” and grounding chains are long gone. Back then, the probability that a worker happened to be in contact at the very instant that the line accidentally became re-energized was very small. In most cases the absence of injuries was more the result of the worker lacking contact at that moment than the protection scheme in use at the time.

Now it is important to be aware of fault current levels, available protective equipment, techniques for establishing safe working areas and the condition of the equipment to be used. New and more appropriate methods of personal protective grounding to meet today’s needs are reviewed in this publication.

The growth of the utility industry has been accompanied by an increase in the number of accidents and injuries. This has resulted in an increased awareness for the need of improved safe working conditions within the industry and also from governmental regulating agencies. At the federal level rules by the Occupational Safety and Health Admin-

istration (OSHA) were published in January 1994. CFR 29 1910.269 Subpart R<sup>[7]</sup> regulates a broad scope of utility activities. It puts forth requirements relating to operation and maintenance of generation, transformation, transmission and distribution of lines and equipment and of tree trimming activities. Other rulings by OSHA address other utility related topics. Very little is being left to chance. These rules carry the weight of law and violators may face severe penalties and monetary fines. Some states have adopted their own version of the OSHA regulations. This is allowed if the state version is at least as stringent as the federal regulations.

## **Worker protection is the focus of the decade.**

This publication intends to assist utility personnel at many levels to understand and apply techniques for workers to use during maintenance after a line has been de-energized and taken out of service. Each section has been written with a particular reader in mind. The sections are arranged in a sequential manner, and each stands alone on the information it provides. This allows a reader with more experience to skip over the more basic sections that are provided for the lineworker new to the industry.

Earlier literature referred to this topic as “grounding” or “jumping.” However, confusion existed with these terms. For example, there are “hot jumpers” used to maintain an energized electrical connection that remain energized during their use. Did grounding mean a connection to earth or could it be a connection to neutral? The terminology was officially changed to personal protective grounding in our national standards in an attempt to eliminate this confusion. A generation of linemen will probably pass before the new terminology is commonly used.

Looking back through the years, a variety of protection schemes followed the use of grounding chains. Early methods involved connecting a separate jumper from each conductor to a separate earth connection <sup>(13,14)</sup>. This is diagrammed in Figures 1-1.a and 1-1.b. The worker is represented in the following figures by the symbol of resistance, designated as  $R_M$ . As you can see, this resulted in the worker being placed in series between a possibly energized conductor and ground as a separate or fourth path for current flow to earth if the structure was conductive, e.g., steel tower.

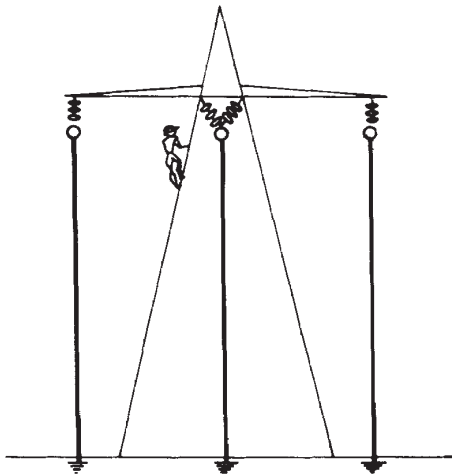

Fig. 1-1.a

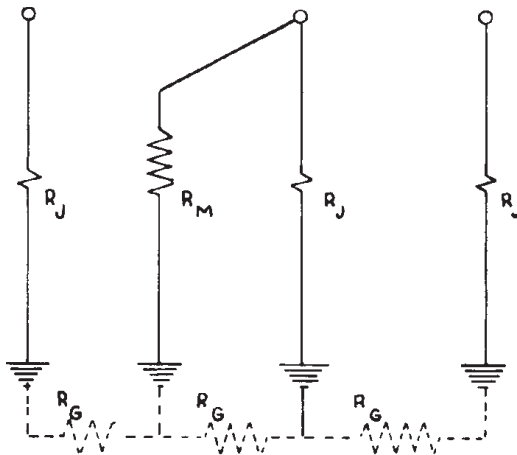

Fig. 1-1.b

**Separate Jumpers To Separate Earth Connections**

A later modification to this method brought the three connections to a single Earth connection point <sup>[13,14]</sup>. It was believed to improve worker safety. However, this modification still left the worker as a separate current return path to the power source through the earth if working on a conductive structure. This is diagrammed in Figures 1-2.a and 1-2.b.

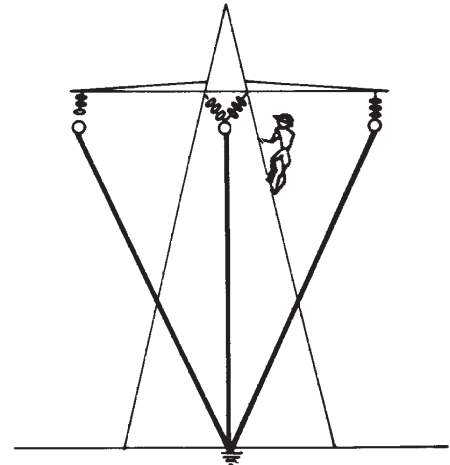

Fig. 1-2.a

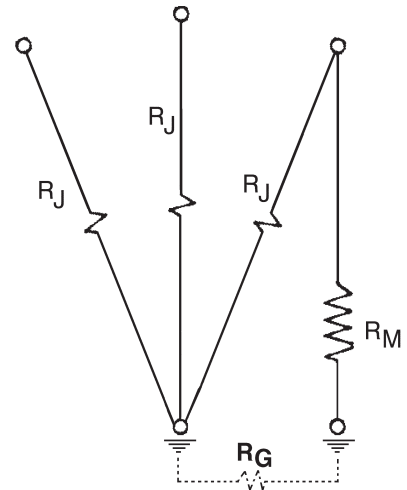

Fig. 1-2.b

**Separate Jumpers To Common Earth Connection**



Another modification used shortened jumpers between phases and a single jumper to a single Earth connection <sup>[13]</sup>, as diagramed in Figures 1-3a and 1-3b. This was another attempt to improve worker protection that did not change the basic circuitry. The worker remains a separate current return path.

All of these schemes protected the system by indicating a fault, but left the worker in a situation that could prove fatal. As can be seen in the diagrams and the associated schematics, substantial voltage can be developed across the worker. This was not a satisfactory solution.

What if the structure is wood? If a pole down

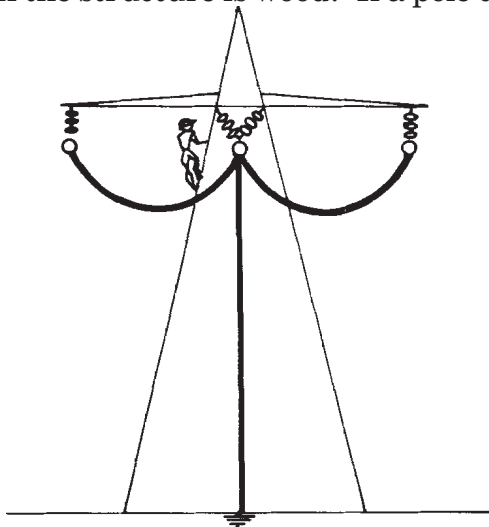

Fig. 1-3.a

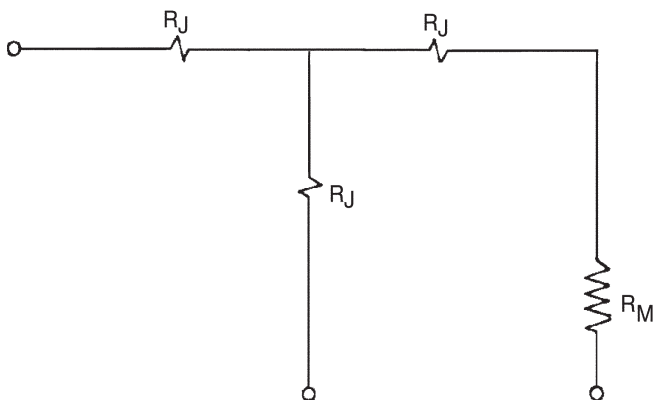

Fig. 1-3.b

**Phase to Phase to Single Earth Connection**

wire is present and the worker is near or touching it, the separate current path remains. If there is no pole down wire, the pole may have a resistance high enough to keep the body current flow to a low level but not necessarily to a safe level. Each pole is different. Pole resistance depends upon the amount of moisture sealed in the wood during the pressure treating, the surface contaminants, and the amount of water present on the surface and the type of wood.

Some companies had adopted a policy of placing a full set of grounds on the pole at the worksite and also on each pole on both sides of the worksite. This offered protection but required three full sets of protective grounds. This increased both the cost and the difficulty of the work for the lineman. In 1955 Bonneville Power Administration engineers theorized that a set of grounds on the center worksite pole was adequate, if properly sized and installed. Testing indicated that this was correct. A paper<sup>(17)</sup> of this work was authored by E. J. Harrington and T.M.C. Martin in 1954. This was the beginning of the “worksite” grounding movement, but was basically ignored for many years. The low probability of a worker being in contact during the extremely short period the line was re-energized was probably a major factor in the low number of accidents. The prevailing philosophy was that the old methods had kept the number of accidents low before, so why change? Unfortunately, this philosophy exists in some areas today.

Additional protection schemes have been devised. “Bracket grounding” became the most accepted and commonly used one. Its use and faults are discussed in detail in a later section of this publication. Temporary protective grounds today offer protection to workers during maintenance on lines believed to be de-energized that are actually energized through induction or that later become energized accidentally. However, they must be installed in a correct manner, which is the focus of this publication.



## Effects of Current on the Human Body

### Section 2

**CHANCE**<sup>®</sup>

[www.hubbellpowersystems.com](http://www.hubbellpowersystems.com)  
E-mail: [hpsliterature@hps.hubbell.com](mailto:hpsliterature@hps.hubbell.com)



Phone: 573-682-5521

Fax: 573-682-8714

210 North Allen

Centralia, MO 65240, USA

©Copyright 2018 Hubbell Incorporated

# Effects of Current on the Human Body

Charles Dalziel<sup>[18,19]</sup> did much of the early research on the human body's reaction to current in the late 1940s and early 1950s. He used volunteers in his experiments and found that the body reacts to different levels of electrical current in different ways. For the safety of the volunteers, this research was conducted only at low levels of current, with medical personnel present. Later, additional research was carried out to determine the correctness of extrapolating Dalziel's findings to higher current levels.

By monitoring the voltage applied, the resulting current flow, and the reaction of the volunteers, a great deal of information was developed. Calculations were made to develop a value of resistance for the "average" human body. Voltages during some of the experiments were measured at 21 volts hand to hand and 10 volts from one hand to the feet. Calculations of resistance using the measured values yielded 2,330 ohms hand-to-hand and 1,130 ohms hand-to-feet. This early low voltage research established an average safe let-go current for an "average" man as 16 milliamperes. It was also determined that the human body responds to current in an exponential manner. That is, the body responds to an increasing current as the time shortens in a similar manner as it responds to a decreasing current and lengthening duration. This time current relationship is shown in Figure 2-1.

Dalziel's research culminated in Equation 1, which follows<sup>[15]</sup>. It relates current amplitude and duration of flow through the heart to the threshold of ventricular fibrillation. Statistical studies have shown that 99.5% of all persons can withstand the passage of a current magnitude (I) for the duration indicated (t) in this equation without going into ventricular fibrillation. The value k is an empirical constant, statistically determined, related to the

electric shock energy tolerated by a certain percentage of the population studied.

$$I = k/\sqrt{t} \quad (\text{Eq. 1})$$

Where I = Current in milliamperes  
K= function of shock energy  
=  $k_{50}$  is 116 for a 50 kg (110 lb.) body wt.  
=  $k_{70}$  is 157 for a 70 kg (155 lb.) body wt.  
t = time in seconds

Using this formula, it can be determined that on average a 110 lb. lineworker should withstand 67 milliamps for 3 seconds before going into heart fibrillation and a 155 lb. worker would withstand 91 milliamps. Or the same workers would be susceptible to heart fibrillation after a 670 Amp. and 906 Amp. shock respectively after only 0.03 seconds, or about 2 cycles of 60 Hz. current flow through the chest cavity. However, at these current levels other injuries may occur, such as burns if arcing is present. Values presented in tables are commonly rounded to even values of current for ease of presentation and remembering.

Dalziel's research also formed the basis of the chart<sup>[18,19]</sup> that is used throughout the industry today. The chart presents several levels of current and the average body's response. The table for 60 Hz. is presented in Table 2-1.

Effect	Men	Women
No sensation on the hand	0.4	0.3
Slight Tingling (Perception Threshold)	1.1	0.7
Shock, not painful & muscle control not lost	1.8	1.2
Painful Shock, painful but muscle control not lost	9.0	6.0
Painful Shock (Let Go Threshold)	16.0	10.5
Painful & Severe Shock, muscles contract, breathing difficult	23.0	15.0
Possible Ventricular Fibrillation		
From short shocks (0.03 Sec.)	1,000	1,000
From longer shocks (3.0 Sec.)	100	100
Ventricular Fibrillation, Certain Death	Must occur during susceptible phase of heart cycle to be lethal.	
From short shocks (0.03 Sec.)	2,750	2,750
From short shocks (3.0 Sec.)	275	275

All values are milliampere RMS at 60 Hz.

**Reaction to Various Currents By the "Average" Body  
Table 2-1**

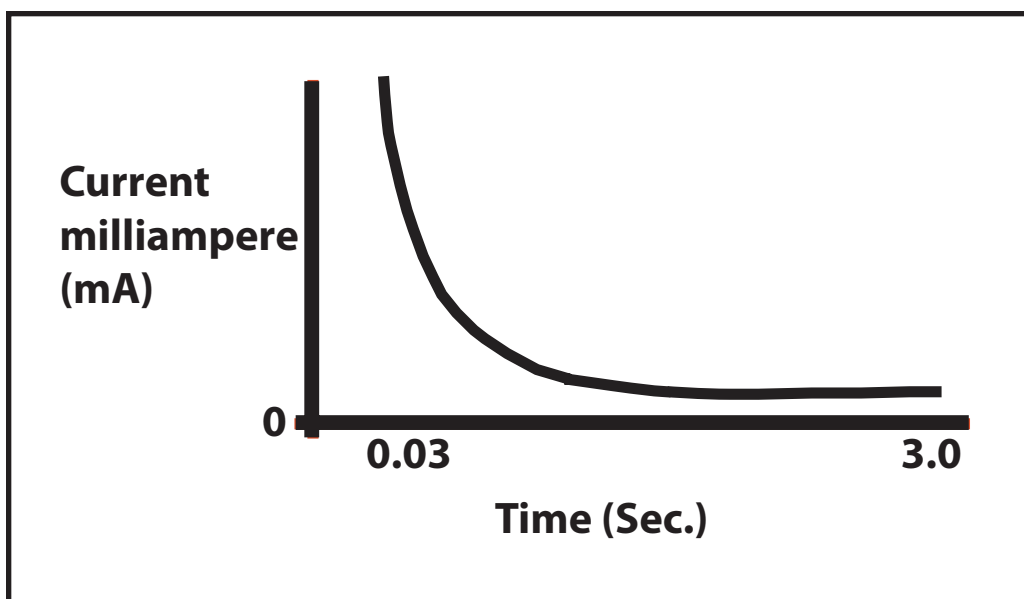

Fig. 2-1



The published literature typically presents resistance values between extremities. Values are typically given from hand to hand, a hand to both feet or from one foot to the other foot. Literature typically presents the body resistance as either 500 Ohms or 1,000 Ohms<sup>[1]</sup>. Neither is truly representative of a specific, individual worker. Many other factors have an affect upon the total lineworker resistance, such as: Are gloves being worn? What are they made of? Are boots with insulating or conducting soles being worn? How callused are the worker's hands? The actual resistance of an working individual may vary from the 500 Ohms value to a few thousand Ohms.

Most literature of today assumes a body resistance of 1,000 Ohms but more and more utilities are using a 500 Ohm value to err on the side of safety. While this is an approximate value, it allows calculations and comparisons between safety equipment offerings to be made. Resistance may be added to include the wearing of protective leather gloves or shoes. The use of an alternate body resistance beyond those defined in standards, to meet individual utility requirements, is left up to the user.

If re-closing is not disabled, a second shock may occur soon after the first. If it occurs in

less than 0.5 sec. from the beginning of the first, the combined durations of the two should be considered as one<sup>[1]</sup>. The short interval without current does not provide sufficient time for the person to recover from the first shock before receiving the second.

It is agreed that the most serious current path involves the chest cavity. That of hand-to-foot may be less dangerous but still may be fatal. Keep in mind that while a shock may be painful but not fatal, it may cause a related accident. A shock reaction may cause a loss of balance, a fall or the dropping of equipment.

For voltages at or above 1,000 Volts (1 kV) and currents above 5 amperes, the body resistance decreases because the outer skin is often punctured and the current travels in the moist inner tissue, which has much lower resistance. Burns of the body's internal organs can result from this type of current passage.

The protection methods discussed later are designed to ensure the body voltage is maintained below a selected safe level. It must be reduced from the high current level that results in burns or serious injury to a level below that of heart fibrillation.

### **Notable Currents Are:**

Perception Level (the least amount of current detectable by the ungloved hand) = 1.1 milliampere\*

Painful Shock, painful but muscle control not lost = 9 milliampere\*

Painful Shock (Let Go Threshold) = 16 milliampere\*

Possible Ventricular Fibrillation:

With a duration of 0.030 Sec. > 1,000 milliampere\*

With a duration of 3.000 Sec. > 100 milliampere\*

\*These are average levels for men, empirically developed from Charles Dalziel's<sup>[18,19]</sup> research.

- **Training**
- **Equipment**
- **Liability**

## Requirements

### Section 3

**CHANCE**<sup>®</sup>

[www.hubbellpowersystems.com](http://www.hubbellpowersystems.com)  
E-mail: [hpsliterature@hps.hubbell.com](mailto:hpsliterature@hps.hubbell.com)



Phone: 573-682-5521

Fax: 573-682-8714

210 North Allen

Centralia, MO 65240, USA

©Copyright 2018 Hubbell Incorporated

# Utility Requirements

Developing a safe worksite by maintaining the current through the body at a safe level now becomes the task of all involved. First and foremost, utility management and the Safety Department must determine what they consider to be the maximum safe level of current flow allowable through the worker. Or, stated another way, the maximum allowable voltage that can be considered safe that can be developed across the worker must be specified. At the time of this writing, there was no standard or widely accepted maximum allowable body current. A value of 50 V is commonly used, but is not a requirement. This upper limit of exposure is a key consideration in selecting the size of protective equipment. Each worksite and each situation may be different, with each utility accepting a different margin of safety.

To develop a safe worksite requires the cooperation of several departments within the utility. The Engineering Department must supply an approximate level of fault current expected at an individual worksite or within an assigned working region. Engineering must also provide the maximum time that a fault current may flow at the identified sites. The Operations Department must develop appropriate work and equipment maintenance methods. The Purchasing Department, in cooperation with the Standards Group, must acquire appropriate safety equipment for issue and use by the workers. The Safety Department must coordinate all of these activities. Methods of evaluating and accomplishing a safe worksite are discussed later in this document.

**Training:** Utilities must use workers who possess the necessary skills to safely perform their jobs. Linemen have different skill levels. Typically, an electrical worker's employer or the union formally defines each skill level. The levels typically consist of apprentice through journeyman. Formal plus on-the-job training and tailgate conferences expand the training and skill of apprentices and remind experienced linemen of approved safe work methods.

Many utilities have prepared internal publications to outline work rules and practices, approved for use by their utility. Others may not have a formal set of rules in place, relying rather on experienced linemen and the tailgate conference, now required by OSHA 29 before beginning work each day.

According to OSHA regulations, a worker's training must be reviewed annually <sup>[7]</sup> and be documented. Additional training must be provided if the review finds it to be needed. Additional information on the topic of training can be found in the next section on regulating agencies.

Worker safety is now everybody's job. With OSHA regulations now in place, penalties for accidents can be severe and may affect a broad range of personnel throughout the utility if a lack of training is determined to be the cause.

**Equipment:** The utility must provide adequate equipment for the worker to perform the task in a safe, yet efficient manner. Depending upon its size, a utility typically has a person or department making equipment-purchasing decisions. Many utilities rely on national consensus standards to define equipment requirements. Some utilities have safety departments working in conjunction with those responsible for purchasing. They may have their own set of performance specifications drawn from several standards to meet their individual needs.

Adequate equipment to perform safe de-energized line maintenance includes voltage detectors, personal protective grounding assemblies made up with clamps, ferrules and cable with strengths and ratings to meet the safety needs of the worker. Choices and examples of suitable equipment are presented later. Maintenance of this equipment is an implied requirement (see the Equipment topic in the next section on regulating agencies).



**Standards**  
**Section 4**

**CHANCE**<sup>®</sup>

[www.hubbellpowersystems.com](http://www.hubbellpowersystems.com)  
E-mail: [hpsliterature@hps.hubbell.com](mailto:hpsliterature@hps.hubbell.com)



Phone: 573-682-5521    Fax: 573-682-8714    210 North Allen    Centralia, MO 65240, USA

©Copyright 2018 Hubbell Incorporated



# Industry Standards

Standards are used widely in the utility industry. They cover a wide range of topics. For instance, performance specifications for products or components used<sup>[6]</sup>, line construction methods and overhead line maintenance<sup>[2]</sup>. Other documents are presented as guides or general methods of equipment use without specifying a particular work method, but allow the utility the freedom to adapt them to individual situations. Consensus standards developed by agreement among an array of users, manufacturers, utility representatives and experienced consultants are widely accepted and used. Some utilities have developed standards for their own use, patterned after consensus standards, but modified to meet their own particular needs.

In the United States, compliance with standards is voluntary in most instances, other than governmental regulations such as OSHA requirements. The manufacturer of personal protective grounding equipment may choose which standard its products meet and accordingly market them. However, the manufacturer may be required to meet all that applies due to the variations and requirements within its customer base.

The main authoring groups of voluntary standards in the United States addressing utility needs are:

- American National Standards Institute (ANSI)
- The Institute of Electrical and Electronic Engineers (IEEE)
- American Society of Testing and Materials (ASTM)
- National Electrical Manufacturers Association (NEMA).

While other countries also may have their own national standards, the International Electrotechnical Commission (IEC) is the primary source of internationally accepted standards. IEC standards are also consensus standards, developed by knowledgeable representatives from each member country including the U.S. During recent years, the influence of IEC standards has increased, even in the U.S., as a result of treaties such as NAFTA.

All consensus standards developed are published and widely distributed. They are available for a fee from the sponsoring organization. They are continually reviewed and updated as industry needs and technology change.

OSHA and National Electric Code standards are not voluntary. However, even these take input from consensus standards groups sponsored by various standards organizations because of the broad range of experience and knowledge of the representatives who develop them. Official governmental regulations normally are open to public comment prior to the issuing of rulings which are then printed in the Federal Register.

The Reference section of this publication contains a partial list of standards that control the manufacture, selection and use of protective grounding equipment. References to these standards will be made throughout this publication.

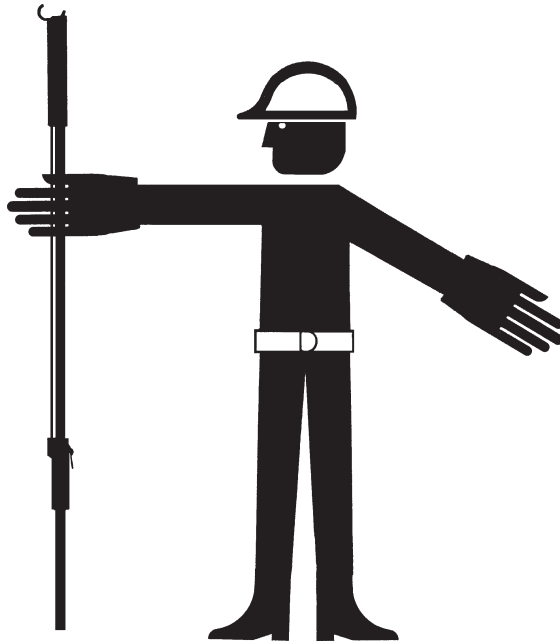

## Electrical Principles

### Section 5

**CHANCE**<sup>®</sup>

[www.hubbellpowersystems.com](http://www.hubbellpowersystems.com)  
E-mail: [hpsliterature@hps.hubbell.com](mailto:hpsliterature@hps.hubbell.com)



Phone: 573-682-5521

Fax: 573-682-8714

210 North Allen

Centralia, MO 65240, USA

©Copyright 2018 Hubbell Incorporated

# Electrical Principles

The Electrical Principles section of this publication has been included for those who do not have a strong background in electrical principles or circuit theory. It is a very basic presentation. Those with prior knowledge may wish to skip over this and proceed to the next section.

## Ohms Law

The simple use of Ohm's Law is all that is really needed to understand the theory of protective grounding. The study could be made more complex by considering the inductance associated with alternating current, but because many of the values are based on assumptions the additional complexity is not believed to be necessary for this basic presentation.

One of the first laws learned when studying electricity is Ohm's Law. It gives a fundamental relationship to three electrical quantities. These are voltage, current and resistance. If any two of them are known, the third can be calculated. Using basic algebra, the relationship can be rearranged into three forms depending upon which quantity is the unknown.

$$V = I \times R \quad \text{or} \quad I = V / R \quad \text{or} \quad R = V / I \quad (\text{Eq. 2})$$

Where: V = voltage, in Volts  
I = Current, in Amperes  
R = Resistance, in Ohms

A related quantity is power. Power is the product of multiplying the voltage times the current.

$$P = V \times I \quad (\text{Eq. 3})$$

Where: P = power, in watts

Equation 3 can be rearranged into other useful forms by substituting the appropriate form of Equation 2 for either the V or the I in Equation 3. The resulting modifications are:

$$P = I^2 \times R \quad \text{or} \quad P = E^2 / R \quad (\text{Eq. 4})$$

Electrical circuits are connected in series configurations, or parallel configurations or a combination of both. Ohm's Law can be applied to all three variations as follows.

## Series Circuits

The simplest circuit is the series circuit consisting of a voltage source, a connected load and the interconnecting wiring. To illustrate a series circuit, consider the following example. The source is a 110 Volts AC (VAC) wall outlet. The load is a single lamp and the wiring is the cord between the lamp and the wall outlet. When the lamp is plugged in and turned on, current flows from one terminal of the outlet through one of the wires to the lamp, through the bulb and back to the outlet through the other wire. The circuit is shown in Fig. 5-1. In completed circuits, if the voltage and resistance are known, the current can be calculated using Equations 2, 3 or 4.

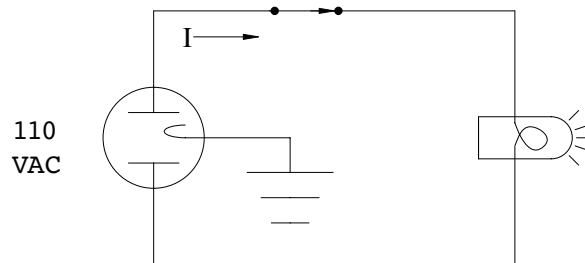

Simple Series Lamp Circuit  
Fig. 5-1

Every current carrying part of a circuit has some resistance. Current flowing through any resistance creates a voltage drop spread over the resistive component. If all of the small and large voltage drops are added together, they equal that of the source voltage, or the wall outlet in this case. In the example, the resistance of the connecting wire is sufficiently small compared to that of the bulb, so it could be ignored (but this is not always the case).

In our example, let us assume the outlet voltage is 110 VAC and the lamp has a 100 W bulb. By substituting these values in Equations 2 and 3, the current and resistance can be determined.

$$P = I \times V \text{ or } 100 \text{ W} = I \times 110 \text{ VAC}$$

Solving for current (I) we get:

$$I = 100 \text{ Watts} / 110 \text{ Volts or } 0.91 \text{ Ampere}$$

And resistance

$$R = (110 \text{ VAC})^2 / 100 \text{ Watts} = 121 \text{ Ohms}$$

When a second lamp is connected in series with the first, the resistance of the load as seen from the wall outlet has changed. Therefore, the current changes. This is shown in Figure 5-2. The source voltage remains constant at 110 VAC. We would expect two lamps of equal size to present twice the load (or resistance) to the source. Equation 2 tells us that if we double the resistance, the current will be half the previous value for a constant voltage.

$$I = V / R \text{ or } I = V / 2R \text{ now, which is } 110 \text{ VAC} / 242 \text{ Ohms}$$

$$I = 0.454 \text{ Amp.}$$

As expected, the current is now half the previous value. Remember, the source voltage remained 110VAC but consider what happens at the load. Because the bulbs are the same

size, the voltage divides equally across each. Remember that the sum of the voltage drops around a circuit must equal the source. We expect each bulb to have only 55 VAC across it and the individual brightness of each to be diminished.

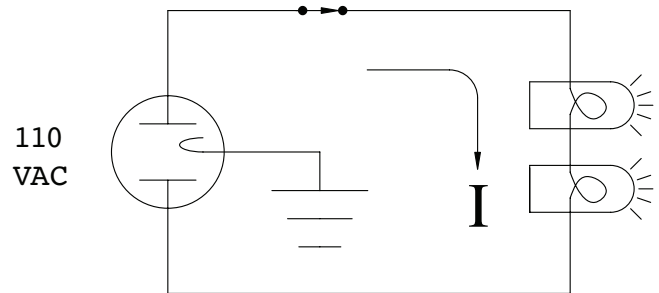

**Two Lamps in Series**  
Fig. 5-2

For simplicity, our examples use light bulbs as loads. However, the same principle applies to other loads. Substitute for the bulbs any other circuit component that has resistance. This can include a length of conductor, a transformer, motor or a combination of loads. The circuit current and voltage drops will adjust themselves based upon the resistance values of each of the components in the circuit. Figure 5-3 shows the same circuit with the lamps replaced by the electrical symbol for resistance.

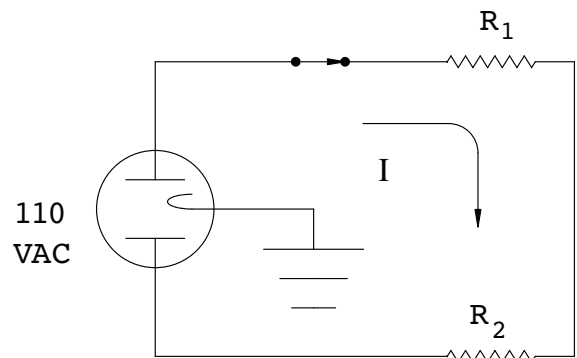

**Series Circuit Using Common Symbols**  
Fig. 5-3



This brings us to a key point. If the resistances are not equal, the voltage drop across each component also will not be equal. The voltage on each component will be a fraction of the total applied voltage. The fraction is determined by the percentage of the component's resistance compared to the total resistance in the circuit.

Again referring to Equation 2, if the voltage applied to the series circuit and all component resistances are known, any component's voltage drop can be calculated by determining its fraction of the total resistance times the applied voltage. With the component's voltage and resistance now known, the components current can be determined which is also the circuit current in a series circuit. Or, if the available current and the resistance of a component is known, calculations can be made for the voltage drop across that component. Applications of these calculations are shown in later sections.

A circuit with unequal resistances is shown in Figure 5-4. Two resistances are in series, a 100-Ohm and a 200-Ohm, and they are connected to a 110-volt source.

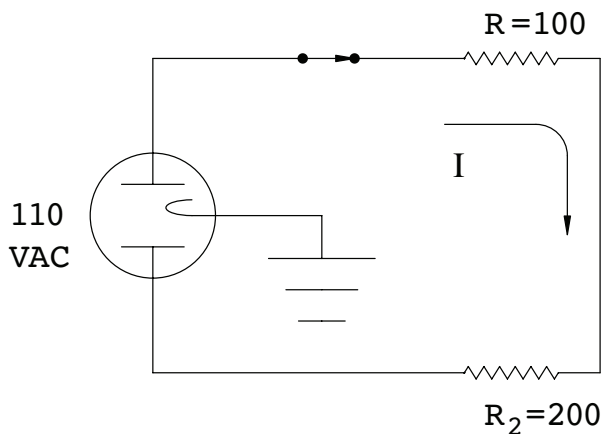

Series Circuit with Unequal Resistances  
Fig. 5-4

Each resistor's voltage drop is calculated using Equation 2 as follows:

$$R_{\text{total}} = 100 \text{ Ohm} + 200 \text{ Ohm} = 300 \text{ Ohm}$$

$$I_{\text{total}} = 110 \text{ Volt} / 300 \text{ Ohms} = 0.367 \text{ amp.}$$

Calculated individually:

Voltage drop across the 100 Ohm:

$$= I \times R = 0.367 \text{ amp.} \times 100 \text{ Ohm} \\ = 36.7 \text{ Volts}$$

And

Voltage drop across the 200 Ohm:

$$= 0.367 \text{ amp} \times 200 \text{ Ohm} = 73.3 \text{ Volts}$$

Or voltage calculated as a percentage of the total:

Voltage across the 100 Ohm:

$$= (100 \text{ Ohm} / 300 \text{ Ohm}) \times 110 \text{ Volts} \\ = 36.7 \text{ Volts}$$

And

Voltage across the 200 Ohm:

$$= (200 \text{ Ohm} / 300 \text{ Ohm}) \times 110 \text{ Volts} \\ = 73.3 \text{ Volts}$$

In either calculation, the voltages add up to equal the 110-Volt source voltage.

### Parallel Circuits

Not all circuits are connected in series as described in the previous section. Another basic configuration is the parallel circuit. Consider our two 100 W lamps from before, but now connected in parallel as shown in Fig. 5-5. The wall outlet remains 110 VAC. In this case each lamp passes the full 0.91 amp of current as before, because the voltage across it is the full 110 VAC. The wall outlet is now supplying a total of 1.82 amp, because each lamp draws the full current. **The sum of the branch currents must equal that supplied.**

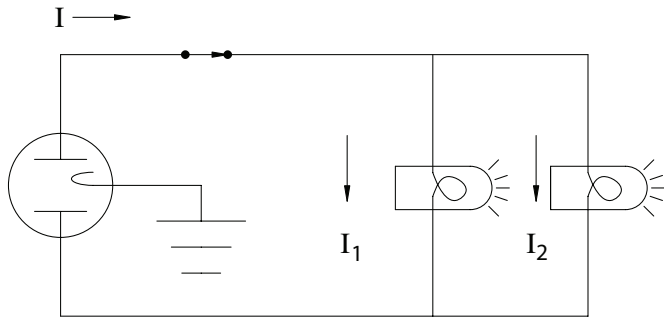

Parallel Circuit  
Fig. 5-5

In this case, again the lamps have equal resistance and the current divides equally between the two paths. If there are unequal resistances, the current divides in inverse proportion to their resistances. That is, the lower the resistance of the path, the more current goes through that path. **This is the foundation principle of personal protective grounding, placing a very low resistance jumper in parallel with a much higher resistance worker.** Figure 5-6 shows the parallel circuit with the lamps replaced by the electrical symbol for resistance. Equation 5 shows the calculations for this circuit.

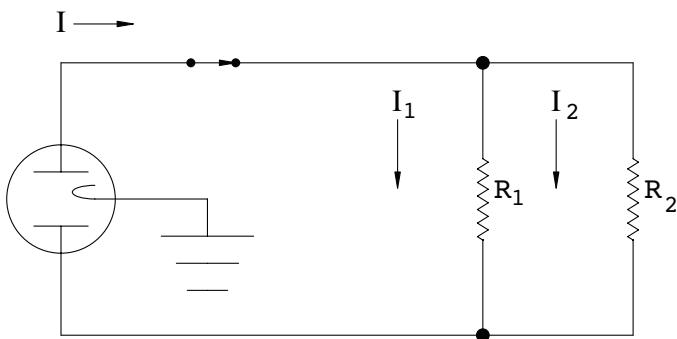

Parallel Circuit  
Fig. 5-6

For example:

$$I_1 = \frac{R_2}{(R_1 + R_2)} \times I_{TOTAL} \quad \text{Eq. 5}$$

(Remember, current divides in inverse proportion to the total resistance)

If  $R_1$  represents a line worker and  $R_2$  the personal protective jumper, the equation becomes:

$$I_{MAN} = \frac{(R_{JUMPER})}{(R_{MAN} + R_{JUMPER})} \times I_{AVAILABLE} \quad \text{Eq. 5a}$$

Resistances in parallel circuits can be reduced to a single, equivalent value for use in calculations. This is done by:

$$\frac{1}{R_{TOTAL}} = \frac{1}{R_1} + \frac{1}{R_2} + \frac{1}{R_3} + \dots + \frac{1}{R_{LAST}} \quad \text{Eq. 6a}$$

A simplified form of Equation 6a when dealing with only two resistances is found by algebraically rearranging the equation. Remember  $R_1$  and/or  $R_2$  could be the sum of a series of resistances.

$$R_{TOTAL} = (R_1 \times R_2) / (R_1 + R_2) \quad \text{Eq. 6b}$$

A key point in parallel circuits is that some current will flow through every possible path. The current magnitude in each path will depend upon the resistance of each path. The only means of completely eliminating current flow is to eliminate the path.

In any circuit a voltage drop is developed only if current flows through the resistive element. And, the larger the resistance, the larger the voltage drop, as shown in Fig. 5-7.

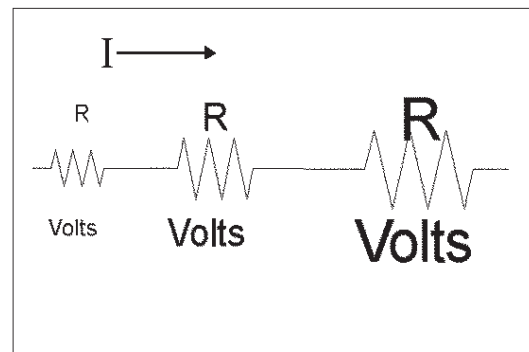

Fig. 5-7

## Combination Series/Parallel Circuits

The real world is filled with circuits. Few are as simple as the pure series or parallel ones described above. Most are combinations of series and parallel connections. The typical worksite is an example of this. Consider a de-energized single-phase source connected to the conductor feeding the worksite (series). A worker is standing on a wood pole above a cluster bar in contact with the conductor with a jumper bypassing him (parallel). The cluster bar is connected both to the Earth and to the return neutral (parallel). Perhaps, also, it is connected to an overhead static line (additional parallel). The cluster bar is also bonded to the pole, and per the OSHA acceptable methods of grounding for employers that do not perform an engineering determination found in 1910.269 Appendix C, should also be in conductive contact with a metal spike or nail that penetrates the wood at least as far as the climber's gaffs.

As complicated as this appears, it can be reduced to a simple equivalent circuit for ease of analysis. To do so requires the determination of the resistances of the conductor, neutral, safety jumpers and the possible static wire. A realistic estimation can be used, because the normal loads on the line will not be disconnected and they will affect the final value. An exact determination is beyond the scope of this presentation. Assumptions about the worker (typically 1,000 Ohms) and earth resistances and source and return paths can be made. Each parallel portion can be reduced to an equivalent resistance using Equations 5 or 6. Total circuit resistance can be found by adding all the series resistances plus the parallel equivalents. If the source voltage is known, it allows calculation of the fault current available at a worksite. While this is a valid technique, it is included primarily to illustrate the process used. The engineering department of the utility should be consulted for a more accurate value.

It then becomes necessary to analyze only the connections at the worksite. As an aid to analysis, Table 5-1 presents the DC resistance of several common conductors in Ohms per 1,000 ft. If it becomes necessary to include a return path through the Earth, a value of resistance must be assigned to that path.

The ratings used for cable are specified in ASTM B8 and are presented in Table 5-1.

AWG Size	Resistance (Ohms/1,000 ft.)
#2	0.1563
1/0	0.0983
2/0	0.0779
3/0	0.0620
4/0	0.0490

**Copper Wire Resistances**  
**Table 5-1**

Note: There may be minor resistance changes depending upon the winding and bundling of the small strands that make up the cable, i.e. concentric stranded, bundled, rope lay, etc. They should not affect the use of these values.

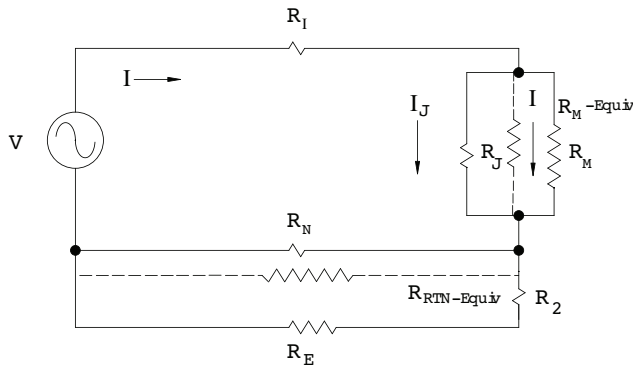

**Series/Parallel Circuit  
Fig. 5-8**

Figure 5-8 illustrates this scenario. As an example of the calculations involved, all the mentioned components have been included. Assume the source may achieve 12 kV, even momentarily.

- V = Source voltage = 12,000 volts
- R<sub>1</sub> = 5 miles of 2/0 Cu conductor = 2.10 Ohms
- R<sub>2</sub> = 25 ft. of 2/0 Cu jumper, cluster bar to Earth = 0.002 Ohm
- R<sub>M</sub> = Assumed man resistance = 1,000 Ohms
- R<sub>N</sub> = 5 miles of 2/0 Cu neutral = 2.10 Ohms
- R<sub>J</sub> = Personal Protective Jumper; 10 ft. of 2/0 Cu = 0.0008 Ohm
- R<sub>E</sub> = Earth Return resistance = 25 Ohms

First determine the total current drawn from the source. Find the equivalent resistances of each of the parallel portions. Then add all or the resistances in series together. Now knowing both the source voltage and the circuit resistances, Equation 2 can be used to determine the source current. So:

The man/jumper equivalent resistance is:

$$\begin{aligned} 1/R_{M-EQUIV} &= 1/R_M + 1/R_J \\ &= 1/1000 + 1/0.0008 \\ &= .001 + 1250 \\ &= 1250.001 \end{aligned}$$

So

$$R_{M-EQUIV} = 0.0008 \text{ Ohm}$$

The neutral/Earth return equivalent resistance is:

$$\begin{aligned} 1/R_{RTN-EQUIV} &= 1/R_N + 1/(R_2 + R_E) \\ &= 1/2.10 + 1/(25 + 0.002) \end{aligned}$$

$$\text{and } R_{RTN-EQUIV} = 1.937 \text{ Ohms}$$

The total circuit equivalent resistance is:

$$R = R_1 + R_{M-EQUIV} + R_{RTN-EQUIV} = 2.10 + 0.0008 + 1.937 = 4.038 \text{ Ohms}$$

The current from the source:

$$\begin{aligned} I_{SOURCE} &= V/R = 12,000 / 4.038 \\ &= 2,972 \text{ Amp} \end{aligned}$$

The current through each of the circuit parts can now be determined.

The current through the man:

$$\begin{aligned} I_{MAN} &= I_{SOURCE} \times (R_J / (R_M + R_J)) = 2,972 \times \\ &= [0.0008 / (1000 + 0.0008)] \\ &= 0.0024 \text{ Amp} = 2.4 \text{ milliamp} \end{aligned}$$

The current through the jumper:

$$\begin{aligned} I_J &= I_{SOURCE} \times (R_M / (R_M + R_J)) = 2,972 \\ &= [1000 / (1000 + 0.0008)] \\ &= 2,971.998 \text{ Amp} \\ \text{or } I_J &= 2972 - 0.0024 = 2,971.998 \text{ Amp} \end{aligned}$$

The current returning through the neutral:

$$\begin{aligned} I_N &= I_{SOURCE} \times [(R_2 + R_E) / (R_2 + R_E + R_N)] \\ &= 2,972 \times [(0.002 + 25) / (0.002 + 25 + 2.10)] = 2,742 \text{ Amp} \end{aligned}$$

and that through the earth:

$$\begin{aligned} I_E &= I_{SOURCE} \times (R_N / (R_2 + R_E + R_N)) \\ &= 2,972 \times [2.10 / (0.002 + 25 + 2.10)] \\ &= 230 \text{ Amp} \end{aligned}$$

As can be seen from this example, much less current flows through the Earth when a neutral return is included in the protective circuit because the neutral represents a much lower resistance path.

This is an example of a very basic analysis of a circuit from a source to the worksite. Included are the connecting conductors, neutral, protective jumper, Earth and the worker. However, adequate protection for the worker at the worksite can be determined without using this much detail.

It is sufficient to consider just the parallel portion of the circuit shown in Fig. 5-8 representing the worker and the protective jumper. The Engineering Department can provide the maximum fault current in the work area. This reduces the calculations required to determining the maximum resistance allowed for the jumper to maintain the voltage across, or current through the worker below the predetermined levels. Equation 5a can be rearranged to determine the maximum resistance.

$$R_{\text{JUMPER}} = \left( \frac{I_{\text{WORKER}}}{(I_{\text{FAULT}} - I_{\text{MAN ALLOWED}})} \right) \times R_{\text{MAN}}$$

Or Equation 2 can be used by assuming the full fault current passes through the jumper and knowing the maximum worker voltage allowed. This is sufficiently accurate because the magnitude of a fault current dwarfs the allowed body current. Any error is then on the side of safety. Equation 2 then becomes:

$$R_{\text{JUMPER}} = V_{\text{WORKER}} / I_{\text{FAULT}}$$

This is the approach used in Section 9, Basic Protection Methods.



# Hazards

## Section 6

**CHANCE**<sup>®</sup>

[www.hubbellpowersystems.com](http://www.hubbellpowersystems.com)  
E-mail: [hpsliterature@hps.hubbell.com](mailto:hpsliterature@hps.hubbell.com)



Phone: 573-682-5521

Fax: 573-682-8714

210 North Allen

Centralia, MO 65240, USA

©Copyright 2018 Hubbell Incorporated



# Hazards to Address

The primary hazard to protect against is that of a line being energized from induction or becoming accidentally re-energized after it has been de-energized for maintenance. Possible re-energization sources can include incorrect closing of switches or circuit breakers or energized over build lines falling into or contacting the de-energized ones. Other sources that may also re-energize a circuit are back-feed or induced voltage from electric or magnetic fields or both from nearby energized lines. A static charge can be induced from atmospheric conditions such as wind or lightning.

## Induced Voltages and Currents <sup>[21]</sup>

### Magnetic Induction:

A single, low resistance personal protective jumper placed close to and in parallel with the worker can provide protection for the worker. However, multiple jumpers may be required to satisfy other maintenance or safety aspects. If this is the case, the additional jumpers act to form one or more complete circuits. This allows an induced current to flow in the de-energized line caused by the magnetic field

of an adjacent energized line. Think of the parallel energized and de-energized lines as an air core transformer with a 1:1 turn ratio. The energized line represents the transformer primary and the de-energized represents the secondary. Current will flow in a path consisting of the conductor, jumpers, Earth or neutral located between the jumpers.

The current amplitude depends upon the separation of the energized and de-energized lines and the resistances of the path. If the line ends are open, a voltage will be present at the ends. This is a common occurrence when lines share common corridors for long distances.

Removal of a grounding jumper may then create a hazard. It would interrupt current flow. Voltage immediately would be induced across the gap created if the jumper is removed (breaking the circuit) resulting in an arc.

Successful removal of personal protective grounding equipment depends upon the current and voltage magnitudes present. In some cases, special equipment may be necessary to interrupt the current and quench the arc without causing a flashover to an adjacent grounded point.

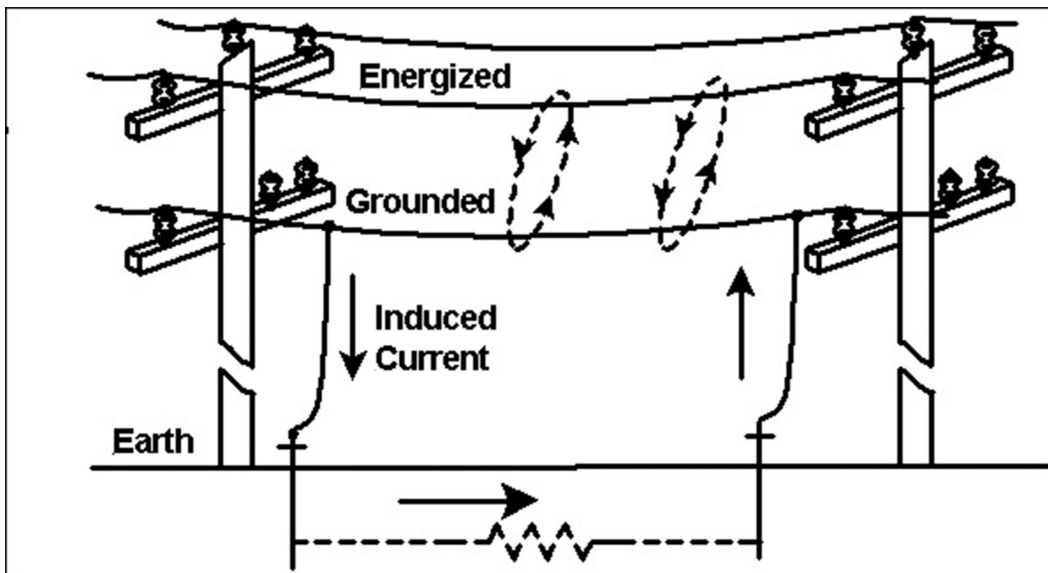

Fig. 6-1

### Capacitive Induction:

Electric field induction (capacitive coupling) from adjacent energized lines can induce high voltages on isolated, de-energized lines. A single grounding jumper on the conductor is sufficient to bleed this charge off to the Earth. The jumper may carry a continuous current as high as 100 milliamperes per mile of parallel line. However, the higher current amplitude resulting from the magnetic induction into a closed loop will not be present, because with a single ground jumper there is no loop.

### Step Potential<sup>[1,4,12]</sup>

A step potential hazard is defined as the voltage across a ground support worker who steps across or otherwise bridges an energized path of Earth. The transfer of the rise in line voltage during a fault to Earth is by way of a jumper or other direct connection. This raises the Earth's point of contact to approximately the same voltage as the line itself during the fault.

The Earth itself has resistance<sup>[20]</sup>. Remember, current flowing through a resistive element creates a voltage drop. As with any voltage drop, it is spread over the resistance itself. Consider the Earth as a string of resistors all connected in series. Each resistor in the series will develop a voltage because of the current flowing through it. This is the voltage drop bridged by the worker who steps across it.

As the distance from the point of contact increases, voltage at that remote Earth point decreases. Tests indicate that the voltage drops to approximately half of the Earth's point of contact voltage in the first 3 feet, at least at distribution voltages levels. It drops to half of that voltage again in the next 3 feet until it can (for all practical purposes) be considered zero.

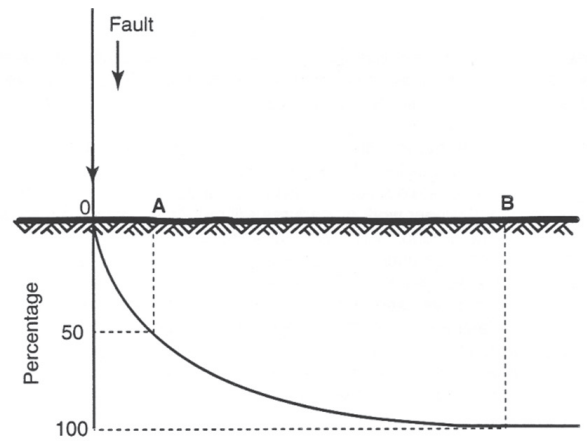

**NOTE:** The distance from the fault to points A and B depend on fault magnitude and soil resistivity.

**Fig. 6-2**

This is a hazard for ground personnel. It is a real danger for workers leaving a truck that may have become energized through accidental contact with an energized conductor and maintenance workers around underground distribution equipment. **Protection methods include insulation, isolation or development of an equipotential zone.**

### Touch Potential<sup>[1,4,12]</sup>

The worker has still another hazard to contend with: Touch Potential. This is the voltage resulting from touching a conductive element that is connected to a remote energized component. The voltage is called transferred potential and it rises to the same value as the contact that becomes energized. It could be thought of as standing on a remote Earth spot while holding a long wire that becomes energized on its far end. Touch voltage between the remote site and the voltage where the worker stands can be quite different. Refer to Fig. 6.2. The voltage is developed across the ground worker's body. Methods of protection remain the same: **Isolate, insulate or develop an equipotential zone.**

# Slip-Resistant (Black) EQUI-MAT® Personal Protective Ground Grid

## Features & Applications

- Complies with OSHA 1910.269 for equipotential requirements near vehicles, underground gear, overhead switches and in substations
- Meets ASTM F2715 Standard

### Portable, lightweight, high performance

- An easy way to help establish an equipotential zone for a lineworker
- For standing on during various energized and de-energized work practices
- Properly applied, it accomplishes compliance with Occupational Safety and Health Administration (OSHA) 1910.269:
  - o "Equipotential Zone. Temporary protective grounds SHALL be placed at such locations and arranged in such a manner as to prevent each employee from being exposed to hazardous differences in electrical potential."
- Can be taken anywhere needed, is simple to use, maintain and store
- Consists of a high-ampacity tinned-copper-braid cable sewn in a grid pattern onto a vinyl/polyester fabric
- Cable terminals permit connecting mat's grid in series with an electrical ground and subject system component or vehicle
- Simply rinsing with water comprises all the care the mat requires
- Mat may be folded and stored in a tool bag to help keep it clean and protected
- Complete instructions are included with each unit

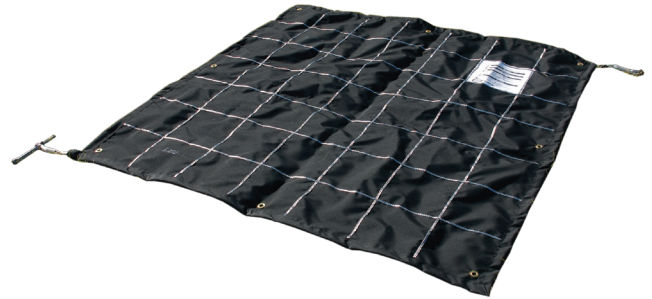

### Slip-Resistant material

- For rain, snow and ice conditions
- Napped surface offers superior footing
- For dry conditions, consider the Standard (Orange) EQUI-MAT® Personal Protective Ground Grid, available in the same sizes and kits

... continued on the next page ...

## Slip-Resistant EQUI-MAT® Personal Protective Ground Grid Each Unit includes Ground Grid, Long Ball Stud and illustrated instructions

Catalog No.	Size	Weight
<i>Single 1/4" Perimeter Braid</i>		
PSC6003345	58" x 58"	8 lb. / 3.6 kg.
PSC6003346	58" x 120"	13 lb. / 5.9 kg.
PSC6003347	120" x 120"	20 lb. / 9.1 kg.



## Pre-Packaged Slip-Resistant EQUI-MAT® Kits Each Kit includes Ground Grid (size below with Long Ball Stud and illustrated instructions) plus Ground Set T6002841 and Storage Bag C4170147

Kit Catalog No.	EQUI-MAT® Personal Protective Ground Grid Size	Weight per Kit
PSC6003348	58" x 58"	19 lb. / 8.6 kg.
PSC6003349	58" x 120"	27 lb. / 12.2 kg.
PSC6003350	120" x 120"	30 lb. / 13.6 kg.



**Long Ball Stud T6002364**  
included with each Basic EQUI-MAT® Personal Protective Ground Grid (Catalog page 3013)

**Ground Set T6002841 included with Kits only**  
Consists of 6 ft. long #2 cable with ferrules applied, Ball Socket clamp (C6002100) and C-Type clamp (T6000465)



**Storage Bag C4170147**  
included with Kits only  
Catalog pages 2512-13



# Slip-Resistant (Black) EQUI-MAT® Personal Protective Ground Grid

## Features & Applications

- Complies with OSHA 1910.269 for equipotential requirements near vehicles, underground gear, overhead switches and in substations

### Padmounted Transformers and Switches

- Complies with OSHA 1910.269
- Protects workers operating and maintaining pad-mounted transformers and switchgear
- Proper use of EQUI-MAT Personal Protective Ground Grid in these applications creates an equipotential zone
- This is the same as a cluster bar (chain binder) does in overhead grounding practices

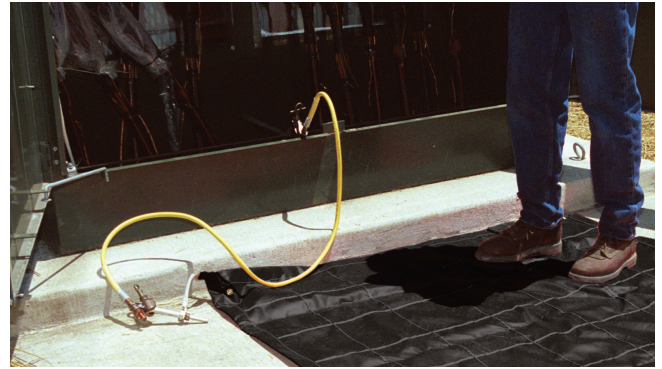

### Mechanical Equipment (Vehicles, etc.) Grounding

- Provides compliance with OSHA 1910.269
- Protects workers around mechanical equipment which could become energized, such as utility vehicles and portable generators
- For proper application, EQUI-MAT Personal Protective Ground Grids are attached to the vehicle (for example) at locations where workers could contact the vehicle
- This extends the equipotential area around the vehicle

### Overhead Distribution and Transmission Switches

- EQUI-MAT Personal Protective Ground Grid can help eliminate step and touch potential
- Connect it to the handle of an overhead switch and stand on it when opening or closing the switch

### Line Apparatus Work

- Similar uses for installing, maintaining or operating regulators, reclosers, capacitor banks

### Suspect Substation Grids

- If station ground mat integrity is questionable, apply the EQUI-MAT Personal Protective Ground Grid
- Connected in series, the conductive grids become one
- For larger area, place lug connector tabs of two adjacent mats on the supplied bolt or threaded shank of a ball stud and secure with supplied washer and nut

### Simple to join multiples for larger areas

- Cascading (or joining together) two or more mats is easy
- Connecting tab and hardware furnished with each mat

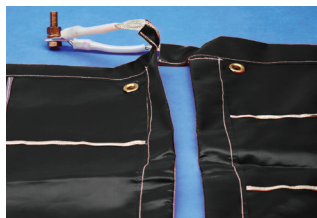

(Left) To join mats, conductive grids simply connect at tabs with bolt, washer and nut included with each mat. Tabs have shrink tube for stress relief. (Right) Ball stud can join mats and connect to ground set clamps.

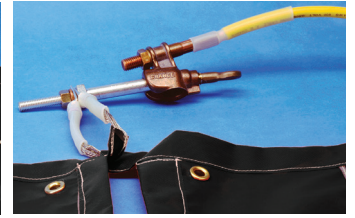

Long ball stud accepts various grounding clamps as shown below and at right: Ball/Socket, C Type and Duckbill.

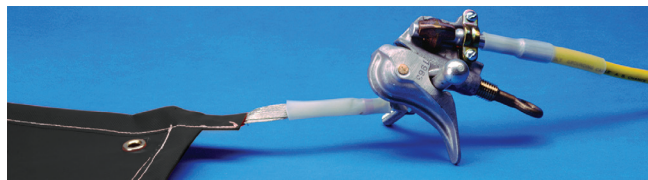



# Theory of Personal Protective Grounding

## Section 7

**CHANCE**<sup>®</sup>

[www.hubbellpowersystems.com](http://www.hubbellpowersystems.com)  
E-mail: [hpsliterature@hps.hubbell.com](mailto:hpsliterature@hps.hubbell.com)



Phone: 573-682-5521

Fax: 573-682-8714

210 North Allen

Centralia, MO 65240, USA

©Copyright 2018 Hubbell Incorporated



# Theory of Personal Protective Grounding

## Isolate/Insulate

The only method of providing absolute protection to a worker is to completely eliminate any current path through the body. There are two ways of doing this.

The first is to isolate the worker so that contact with an energized part cannot be made. While effective, this also eliminates the ability to work, so this often is not a viable method.

The second method uses suitably rated insulation to eliminate the body as a current path. This is the principle used when doing energized distribution voltage maintenance using rubber gloves. The gloves provide the insulation to eliminate the body as a current path. An alternate means is to completely cover all energized components with an insulating device to prevent any worker contact. While insulating products are available, they cannot be used in many of the maintenance tasks encountered by a lineman working aloft or by the ground man in support. Present insulating products are limited to distribution voltage applications.

## Equipotential Protection

A practical and more universal method is to provide a means of keeping the body extremities at the same or nearly the same voltage. If the difference in voltage across the body can be eliminated, the flow of current is eliminated, remembering Equation 2 ( $I = V / R$ ). Without a difference in voltage there is no current flow. This is a theoretical solution that cannot be fully achieved in practice. If current flows through anything with resistance, a voltage drop will be developed. However, the principle of maintaining a sufficiently low level of voltage across the body is the basis for the development of an “equipotential zone.” The term is slightly

misleading as the contact points are not at equal voltage values as the name implies. The points are held to a preselected voltage difference by knowing the available current and calculating the maximum resistance of the connecting grounding cables.

This “equipotential zone” limits voltage across the body to a suitably low value to provide the required measure of safety. Again referring to Equation 2 ( $I = V / R$ ), by estimating the body resistance and keeping the voltage below the safe level selected by the employer, the desired measure of safety can be achieved. The reduction in body voltage is achieved by limiting the maximum voltage that can be developed across the parallel circuit composed of both the body and the jumper. Information on the personal protective jumper is a known quantity. The jumper also will carry the largest amount of current compared to the body and can be used to develop the needed parallel voltage level. Again, it is the responsibility of each employer to specify a level of acceptable body voltage. At present, there are no standards that specify a value to be used.

**The key to a successful equipotential zone protection method is to place the worker in a parallel path with a conductor of sufficiently low resistance such that the rise in voltage is held at or below the selected level. The maximum jumper voltage is shown by Equation 2 ( $V = I X R$ ). Shunting the fault current around the body, through the low resistance path, is the first key. Remember that some current will flow in every possible path, but it divides in inverse proportion to the path’s resistance. The use of a low resistance jumper is the major factor. The second key factor is to have the line protection equipment provide fast fault removal.**



The use of the system neutral provides a low resistance path for the return of a fault current if it occurs. This does two things: It maximizes the fault current and tends to lower the voltage at the worksite. The maximum fault current ensures the fastest clearing possible of the fault by the system's protective equipment, such as circuit breaker, reclosers, fuses, etc. The reduction in voltage occurs because the neutral conductor resistance is of a similar magnitude as the source conductor. The source and neutral conductors form a series circuit of two resistances, and a division of voltage results. Figure 7-1 illustrates this. The voltage at the worksite is reduced to that represented by the neutral resistance as a fraction of the total series circuit resistance (see Section 5 for a discussion of series resistances).

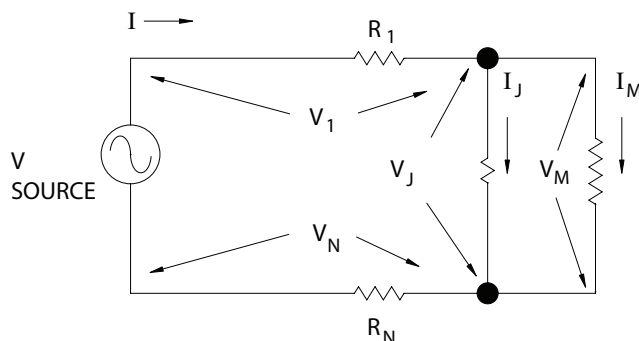

**Voltage Division Using the Neutral**  
**Fig. 7-1**

$V_1$  is about equal to  $V_N$  if they are about the same length and conductor size. The voltage of the conductor and neutral connections at the worksite will be about equal voltage because of the small voltage drop of the jumper, which we will discount.

$$V_1 = V_N = V_{SOURCE} \times [R_N / (R_1 + R_N)]$$

but  $R_1 = R_N$

so

$$V_1 = V_{SOURCE} \times [R_N / (R_N + R_N)] \text{ or}$$

$$V_1 = V_{SOURCE} \times [R_N / 2R_N] \text{ or}$$

$$V_1 = V_{SOURCE} / 2$$

and

$$I_J = I_{SOURCE}$$

$$V_J = V_{SOURCE} - (V_1 + V_N)$$

[a very small difference]

$$\text{or } V_J = V_M$$

The connection to overhead static or shield wires are of questionable benefit for use as a low resistance path for the return of fault current and should be evaluated before use. Many are not continuous to the power source, therefore, cannot be considered a full current return path. Most are steel conductor, which has a much higher resistance than a conductor designed to efficiently carry current. The higher resistance may become hot enough to fuse, depending upon the current level, resulting in its loss as a return path for protection if used alone.

They may be used as a secondary current return path in addition to a primary return path as a means of increasing the margin of safety by providing multiple paths to and through the Earth. If the static or shield wire is included as part of the "work area" it should be electrically connected to the personal protective grounds at the worksite to extend the equipotential work zone.

The use of the Earth alone represents a usable current return path for personal protective grounding. It has higher resistance than a conductor designed to carry current. This will lower the fault current because its resistance is greater than the conductive neutral, but possibly not to such a level that the system protective equipment would fail to recognize the fault. However, the resistance of the Earth varies widely. In areas of dry, sandy soil conditions the resistance may approach several hundred ohms. In a moist soil it may be in the low to mid teens. At the Hubbell Power Systems research laboratory, Centralia, MO, the Earth resistance approaches 18 Ohms.

If the neutral is broken or fuses during a fault and it was the only return path to the source, worker protection could be lost. A current return path through the Earth could be used as a back-up path for the system neutral. The use of multiple jumpers and return paths is encouraged. Because this presentation is about accidents and avoiding accidents, a "belt and suspenders" approach may be prudent.



## Personal Protective Equipment Section 8

**CHANCE<sup>®</sup>**

www.hubbellpowersystems.com  
E-mail: hpsliterature@hps.hubbell.com



Phone: 573-682-5521

Fax: 573-682-8714

210 North Allen

Centralia, MO 65240, USA

©Copyright 2018 Hubbell Incorporated

# Personal Protective Equipment

CHANCE (Hubbell Power Systems) offers a wide variety of personal protective grounding equipment. Most clamps and assemblies are tested and rated per ASTM F855 and/or IEC 61230. Some items are designed for special applications and are not covered by a standard. Where appropriate, catalog literature indicates conformance to an ASTM grade or IEC rating.

In the past, protective-grounding equipment was considered to be only a chain thrown over the line and grounded. Later it became a piece of cable with a clamp on each end. While that is basically true, the selection and correct use has added more complexity. Early versions of the governing standard specified current levels that ensured the cable would not fuse during operation. There was no mention of the voltage drop across the man during the time current was flowing. This remains true today. Because this is such a key factor in protecting workers, it has been addressed more completely in other sections.

Personal protective grounding assemblies consist of clamps, ferrules and interconnecting cable. Each component should be selected to complement the others to achieve the desired level of protection. For example, clamps and ferrules must carry the same or higher current rating than the cable that they are used with in an assembly. The selection of personal protective grounding equipment rating and style is the choice of the user, important criteria being its electrical and mechanical ratings.

Equipment must be sized to provide the necessary worker protection if called upon to do so. It must be capable of carrying the full fault current with its degree of asymmetry and duration, and survive the resulting mechanical forces and heat. As available fault current levels increase, the demands on the equipment increases, not proportionally, but as the square of the current. That is, if the current doubles, the mechanical force quadruples and the cable heating increases. Additionally, high levels of asymmetry significantly increase the mechanical forces.

## Clamps

CHANCE grounding clamps come in a variety of styles, sizes and ratings. Included are C-type clamps in Figure 8-1, also Snap-On (Duckbill-type) in Figure 8-2 and Flat-Face in Figure 8-3, All-Angle in Figure 8-4, and Ball-and-Socket styles in Figure 8-5. Clamps are designed for mounting with insulated hot sticks and some by hand. Others are permanently mounted onto the end of insulated sticks. A complete line of accessories such as pole mount cluster bars, fully assembled grounding sets, underground distribution transformer and switch grounding items, cutout clamps and sets for substation use complement the CHANCE line of clamps.

Each clamp has specific applications for which it was designed. C-type clamps are typically used on round bus or stranded conductor; the Flat-Face clamp is used on flat bus or tower legs or braces; the All-Angle clamp is a popular style where different conductor approach directions are required.

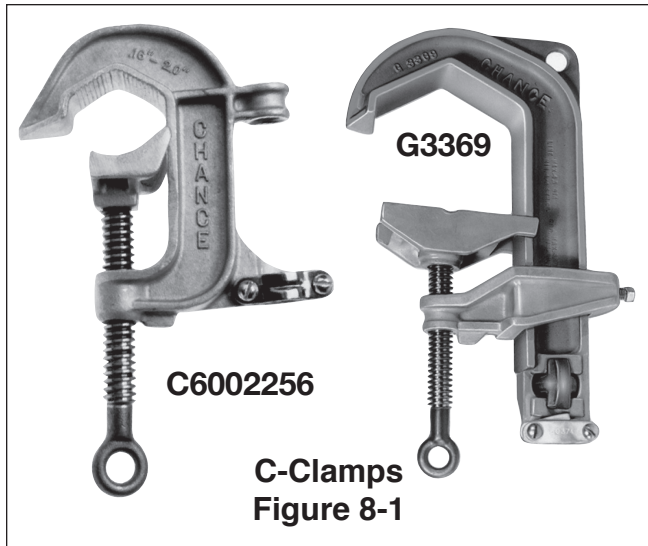

**C-Clamps  
Figure 8-1**

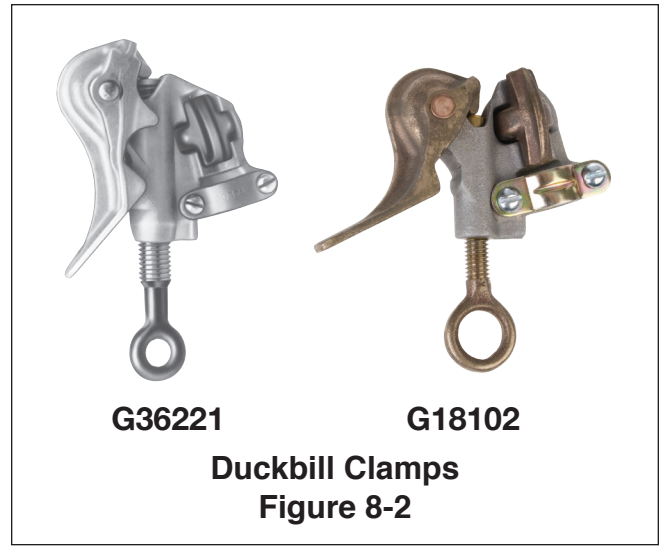

**Duckbill Clamps  
Figure 8-2**

A unique development by Chance was the Ball-and-Socket set. This consists of an electrical grade copper rod, threaded on one end and with a spherical ball machined on the other. The mating clamp has an opening shaped like a keyhole. The larger opening accepts the ball and the smaller opening captures the rod. Because the clamp is free to move on the ball, it minimizes stress on the cable by allowing the cable to hang in a normal position. Then, tightening the eyescrew captures the ball. A rubber cover may be used to protect the ball stud when it is not in use.



**Flat-Face Clamps  
Figure 8-3**

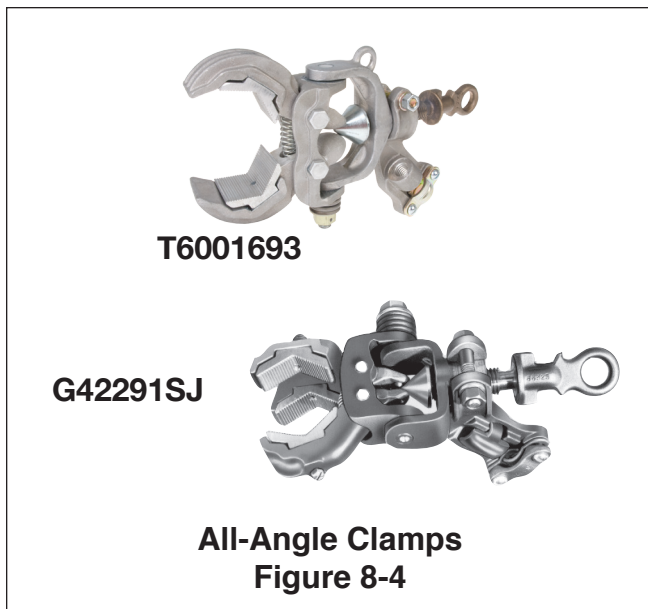

**All-Angle Clamps  
Figure 8-4**

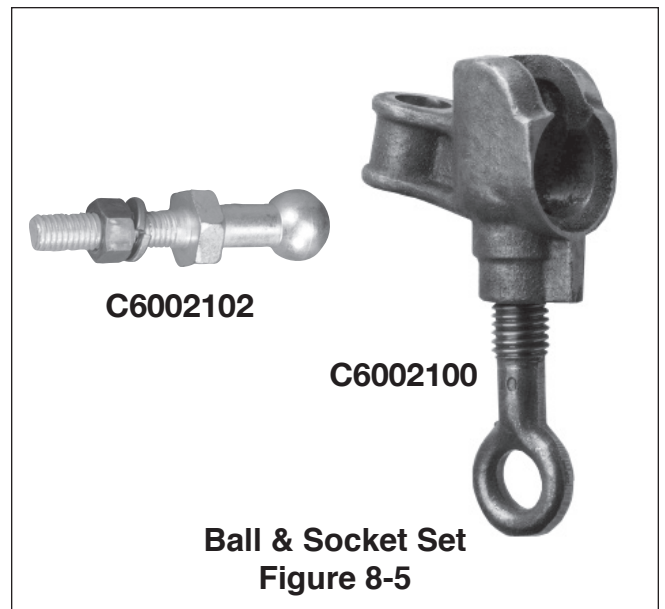

**Ball & Socket Set  
Figure 8-5**

Each clamp is rated for a maximum and minimum conductor size. This provides the customers with a broad selection of equipment to specify for use by their line crews.

A variety of other clamps for special uses are available. The All-Angle Clamp provides flexibility over a wide range of cable and bus sizes and provides easy positioning with its pivoting body. The Cutout Ground Clamp provides a unique ground position while also providing a physical barrier that prevents accidental closure of the cutout fuse tube as long as the

clamp is installed in the lower hinge of the cutout. The Cable Spiker Clamp was designed to ensure the complete de-energization of underground distribution cables with jacket over concentric neutral. It determines the absence of cable voltage when working mid-span before or after removing and parking end span elbows for maintenance activity.

Underground distribution ground sets are available for a wide variety of applications with URD transformers and deadfront switchgear. Chance grounding elbows are available with a fault duty rating of 10,000 amps for 10 cycles.

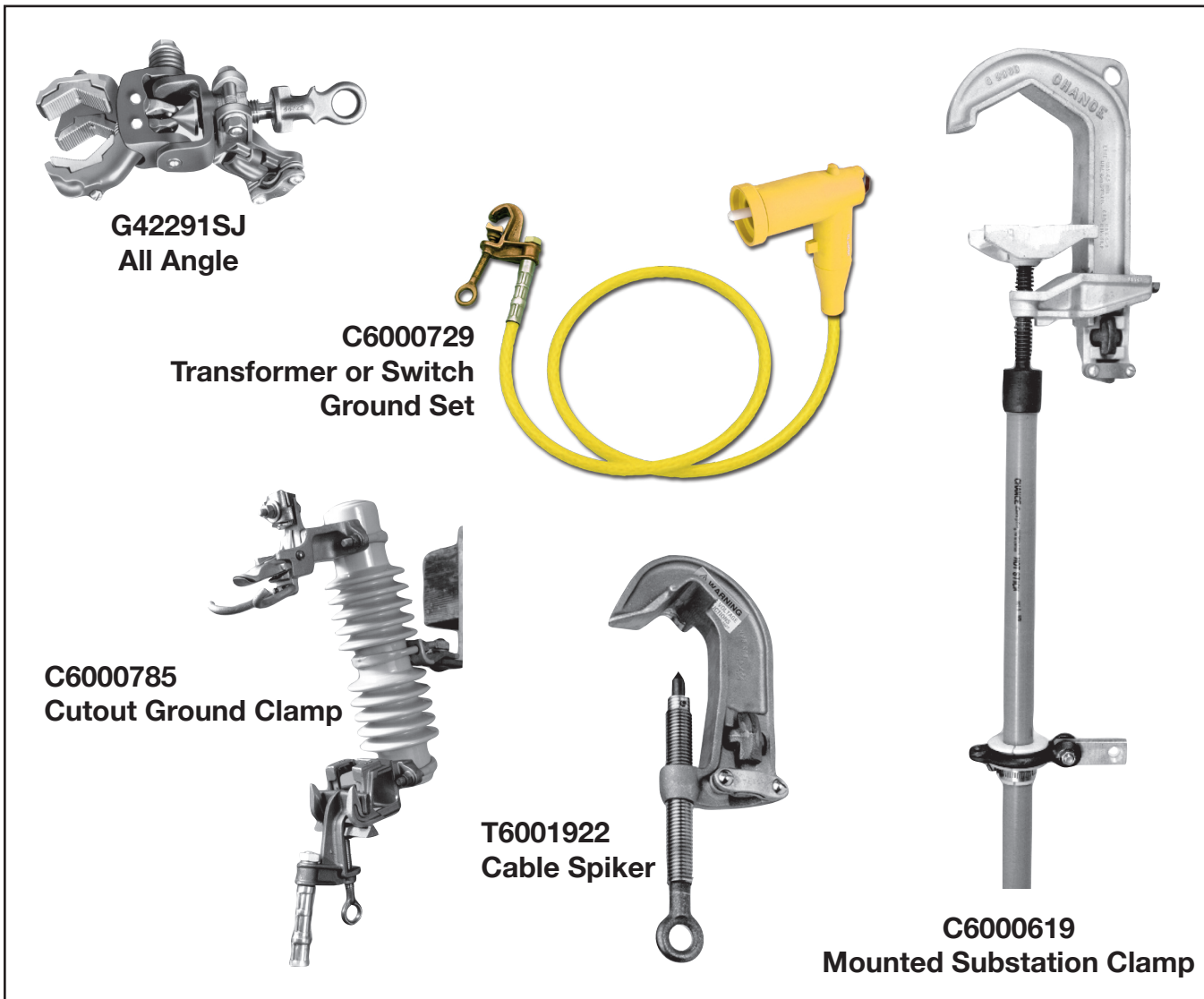

**Special Purpose Clamps**  
**Figure 8-6**



**ASTM<sup>[6]</sup> ratings of clamps, ferrules and assemblies are shown in Table 8-1.**

**Table 8-1 Protective Ground Cable, Ferrule, Clamp and Assembly Ratings for Symmetrical Current**

Grade	Grounding Clamp Torque Strength, min				Short Circuit Properties <sup>A</sup>							Continuous Current Rating, A RMS, 60 Hz
	Yield <sup>B</sup>		Ultimate		Withstand Rating, Symmetrical kA RMS, 60 Hz			Ultimate Rating Capacity <sup>CD</sup> , Symmetrical kA RMS, 60 Hz				
	lbf-in	n-m	lbf-in	n-m	15 cycles (250 ms)	30 cycles (500 ms)	Copper Cable Size	15 cycles (250 ms)	30 cycles (500 ms)	60 cycles (1 s)	Maximum Copper Test Cable Size	
1	280	32	330	37	14	10	#2	18	13	9	2/0	200
2	280	32	330	37	21	15	1/0	29	21	14	4/0	250
3	280	32	330	37	27	20	2/0	37	26	18	4/0	300
4	330	37	400	45	34	25	3/0	47	33	23	250 kcmil	350
5	330	37	400	45	43	30	4/0	59	42	29	250 kcmil	400
6	330	37	400	45	54	39	250 kcmil or 2 2/0	70	49	35	350 kcmil	450
7	330	37	400	45	74	54	350 kcmil or 2 4/0	98	69	48	550 kcmil	550

<sup>A</sup> Withstand and ultimate short circuit properties are based on performance with surges not exceeding 20% asymmetry factor.

<sup>B</sup> Yield shall mean no permanent deformation such that the clamp cannot be reused throughout its entire range of application.

<sup>C</sup> Ultimate rating represents a symmetrical current which the assembly or individual components shall carry for the specified time.

<sup>D</sup> Ultimate values are based upon application of Onderdonk's equation to 98% of nominal circular mil area allowed by Specifications B172 and B173.

**Table 8-2 Ultimate Assembly Rating for High X/R Ratio Applications**

High Asymmetrical Test Requirements					
Grade	Size	Rating Rated Current (kA)	X/R = 30 1st Cycle Current Peak (kA) x2.69	Last Cycle Current Peak (kA)	Test Duration (cycles)
1H	No. 2	15	41	23	15
2H	1/0	25	65	37	15
3H	2/0	31	84	46	15
4H	3/0	39	105	58	15
5H	4/0	47	126	70	15
6H	250 MCM	55	148	82	15
7H	350 MCM	68	183	101	15

Note 1 - The above current values are based on electromechanical test values.

Note 2 - Assemblies that have been subjected to these shall not be re-used.

Note 3 - For use with currents exceeding 20% asymmetry factor.

Note 4 - See X4.72 in ASTM F855 for additional information.

Note 5 - Alternate testing circuits are available for laboratories that cannot achieve the above requirements. See ASTM F855 Appendix X4 for details.

## Cable

Over the years, many cable tests have been conducted and a great deal is known about its electrical and mechanical properties. Cable manufacturing processes are well established and when consistent provide a reliable interconnection.

The ultimate ratings shown in Table 8-1 were originally calculated from an equation developed by Onderdonk<sup>[6]</sup>. They are based upon the time a known current with an asymmetry factor less than 20% can flow causing the cable to melt and separate, much like a fuse, thereby interrupting the flow of current. The withstand rating is approximately 70% to 75% of the ultimate rating. It was included in the ASTM F855 standard to emphasize the need to include a margin of safety when developing a personal protective ground system.

The values shown in Table 8-2 are based upon reduced values taken from EPRI Project RP2446 Computer Program RTGC, "A Desktop Computer Program for Calculating Rating of Temporary Grounding Cables" using an X/R ratio of 30.



## Ferrules

A crimp ferrule should be used to interface the cable to the clamp. While it is possible to strip the cable insulation and insert it into the compression terminal of a clamp, this results in significant risk of equipment failure and should not be done. While copper strands are new and shiny, tests show that such an assembly functions at the rated current. However, as time passes, individual strands exposed through the clamp compression fitting become corroded and start to break. Resistance between the exposed strands can increase substantially when this happens. Passing a high level of fault current through this increased resistance generates a substantial amount of heating. Test results have demonstrated the separation of cable and clamp due to this heating. In some cases, heat was so intense that the pressure terminal actually melted and burned away from the clamp body. This results in a complete loss of worker protection.

Ferrule size must match the conductor size. Ferrules are made both with and without a shroud. See Figure 8-7. The shroud slips over the insulation and is crimped. By covering the cable insulation, it provides protection against the entry of dirt and some contaminants. Ferrules often are used with a short length of clear heat shrink material placed over the cable jacket and the base of the ferrule. This also helps to prevent the entry of moisture and other contaminants and provide stress relief.

Ferrules are available in aluminum, copper, and tin plated copper and are normally specified by the preference of the end-user. A properly crimped ferrule reduces the entry of contaminants and provides a strong, durable, and low resistance connection between the cable and clamp. There are sufficient variations of clamp, ferrule and conductor sizes

and styles to meet every need for personal protective grounding. Many applications and the accompanying theory are presented in later sections.

## Voltage Detectors

Verification that a line is de-energized before attaching personal protective grounds are applied is a critical starting point. From this came the slogan “If it’s not grounded, it’s not dead.” There are several devices available to make this determination. Some involve temporary direct contact with the line to make the measurement. Non-contact models are positioned near the line and held long enough to make the reading. They make their measurements based upon the flow of capacitive leakage current between the line and the Earth or nearby grounded objects. Other devices operate similar to normal voltmeters. That is, they have two leads that can make contact with the line and a ground point to read the voltage present. Procedures for using these devices is explained further in General Installation Procedures, Section 10.

Chance offers Multi-Range Voltage Detectors (MRVD) in several measurement ranges, covering from 1 kV to 600 kV. They are available with either analog or digital meters. They are designed for mounting on an insulated universal pole of sufficient length to maintain a safe working distance for the worker. A metal probe is brought into contact with the line to take the reading. If the line is energized from a substation source, the reading is that of the system voltage. If the line being measured is opened and floating an induced voltage substantially lower or higher than the system, voltage may be present if that line shares poles or a corridor with other lines that are energized. A capacitive induced voltage falls to near zero as soon as the first grounded jumper is installed. This device is easy to read and does not require some interpretation by the user, but with the guidelines supplied is easily learned and becomes a very useful tool. Adapters are available to use with underground distribution system equipment such as transformers, switches, elbows, etc.

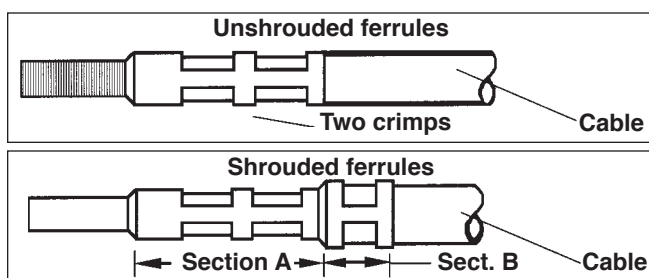
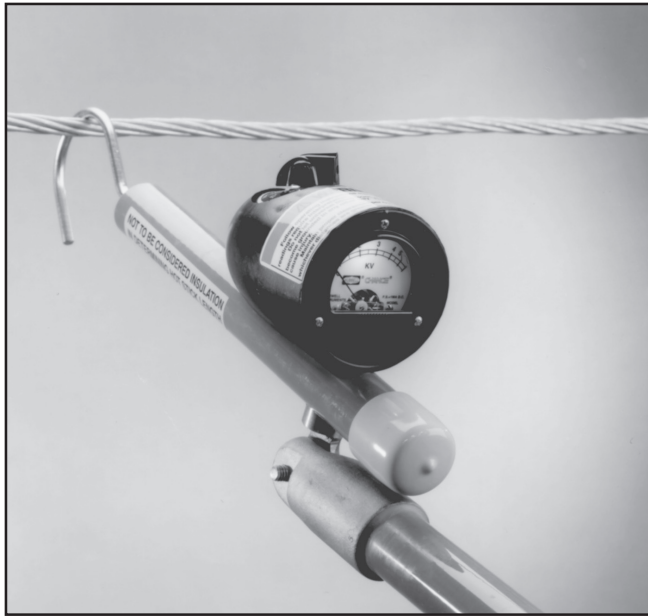

Figure 8-7



**Multi-Range Voltage Detector (Analog)  
Figure 8-8**

Chance also offers the Full Range Auto Ranging Voltage Indicator (ARVI) in ranges from 600 volts to 500 kV. This is a direct-contact device that is mounted on an insulated universal pole of sufficient length to maintain a safe working distance for the worker. An audible alarm sounds if the voltage exceeds the system voltage. These are also available with adapters for use on underground distribution system components.

Another offering from Chance is the Phasing Tester, available in wired and wireless versions. While this tool was designed for establishing the phase rotation of energized lines, it can be used to determine a de-energized line's status. It is basically a two-probe voltmeter for high voltage applications. Each probe is insulated and of sufficient length to maintain a safe working distance for the worker. One probe is placed in contact with the line to be measured and the other to a ground or zero potential contact point. The measured voltage will again be either the system or some induced voltage as described earlier.



**Auto Ranging Voltage Indicator  
Figure 8-9**



**Phasing Tester  
Figure 8-10**



**Wireless Phasing Set**

## Ground Rods

A connection to the Earth by means of a driven ground rod consists of more than the metallic rod alone. In addition to the rod, it includes a series of concentric earthen shells around the rod. Current flowing into the rod is radiated in all directions through the entire surface area, creating a current density measured in amperes per square inch. It enters the thin earthen shell surrounding the rod. The surface area of this shell is larger than the rod. The total entering current now passes into the next earthen shell, which has still a larger surface area. The level of amperes per square inch is further reduced. The current continues entering and leaving additional shells, each with successively larger surface areas, illustrated in Figure 8-11. The resistance increases with each incremental increase in distance, but in smaller and smaller amounts because of the increasing surface area until a full hemi-sphere is achieved. Resistance ( $R$ ) of any path is a function of the length ( $L$ ) and cross section ( $A$ ) of the current path, and of the resistivity ( $\rho$ ) of the path.

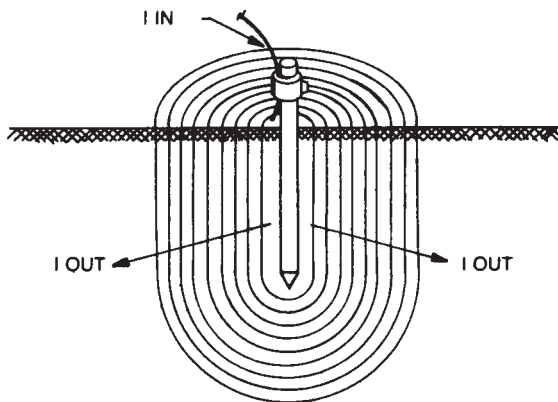

**Ground Rod and Associated Earthen Shells**  
Figure 8-11

Within the shell, the surface area increases faster than the distance from the rod. This results in a decrease in the exiting current's level of amperes per square inch faster than the increase in distance. This is an exponential decrease and is shown in Figure 8-12.

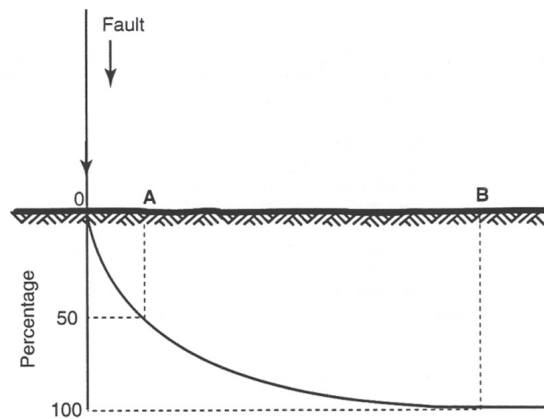

**NOTE:** The distance from the fault to points A and B depend on fault magnitude and soil resistivity.

**Decrease in Current with Distance from the Earth Contact Point**  
Figure 8-12

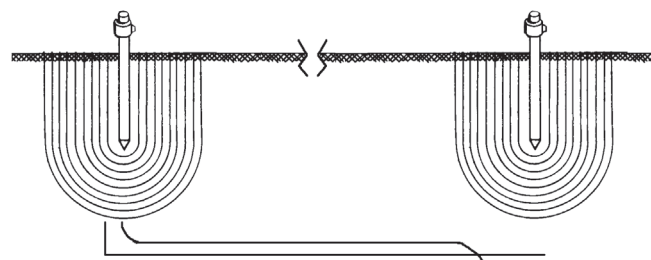

**Resistance Approaches Constant Value**  
Figure 8-13

The implication of the discussion of earthen shells and that of resistance is that as the distance becomes greater, the resistance should also substantially increase. However, the increase in distance is offset by an increase in cross section, as the current spreads throughout the earthen path. So, the result is a non-linear change in the region of the shells. Beyond the boundary of the shell (or between two remote shells shown in Fig. 8-13) the resistance tends to approach a constant value.

If the soil resistivity were constant, the resistance of the path over the entire length might be considered constant. However, soil resistivity varies substantially with its make up. Some of the causes of variations are types of soil, presence and amount of moisture, sand or rock.

The effective shell diameter equals twice that of the depth of the rod. Multiple rods used to make parallel connection paths to Earth tend to lose their parallel current carrying effectiveness if the shells substantially overlap.

# Maintenance of Personal Protective Equipment

29 CFR 1910.269 (n)(4)(i)<sup>[7]</sup> states that it is the utility's responsibility to provide "protective grounding equipment" that "shall be capable of conducting the maximum fault current that could flow (underlined by the author for emphasis) at the point of grounding for the time necessary to clear the fault..." Further, 29 CFR 1910.269 (n)(4)(iii) states "Protective grounds shall have an impedance low enough so that they do not delay the operation of protective devices in case of accidental energizing of the lines or equipment." These two statements imply a responsibility upon the employer.

While not specified, these two statements imply a responsibility to ensure equipment is maintained for use in a safe and usable state. In the past, little attention was paid to the condition of personal protective jumpers. They often were coiled loosely and thrown into the back of a line truck by the workers whose very lives depended upon them. This type of oversight must be corrected.

Maintenance involves manual and visual inspection and electrical testing. Electrical tests are used to determine the condition of the clamp, ferrule and cable-to-ferrule interface. Convenient electrical tests have not been fully developed that will identify broken strands in the cable away from the crimp ferrules, unless a very large number of the strands are broken and not in contact with each other. Most electrical tests make resistance measurements using various levels of test current for short periods of time. If some strands are broken but still in contact with each other, held together by the outer jacket in the cable position, test current can still flow through both the broken and unbroken strands. The change in total resistance over the length of the cable due to small strand breakage usually cannot be seen.

Test currents using the maximum continuous rating of the cable for a long-term test may heat the area of the broken strands. The resulting heating may or may not be manually detected, again depending upon the amount of breakage. Infrared thermographs or thermocouples may improve the reading, but their use exceeds the definition of a convenient field test. This test may take several hours to complete. A careful manual inspection of the cable, feeling for the breaks, is the most reliable method of cable evaluation known at this time.

It may not be practical to make micro-ohm resistance measurements on aluminum clamps using a low voltage source. A coating of aluminum oxide covers bare aluminum surfaces. The coating is described in thickness of molecules, rather than inches. Aluminum oxide is an insulator for very low voltages, but it takes only a few volts to break down this layer and allow current to flow. The breakdown voltage can be as low as 5 to 10 Volts. Levels below 1 Volt may give an incorrect resistance reading.

Chance offers a microprocessor-controlled tester for personal protective grounding sets, the Chance C4033220 Tester for Protective Grounding Sets. The measurement made is the resistance from clamp jaw surface to clamp jaw surface. The resistance value measured should be compared with table 2 in ASTM F2249 to determine pass/fail.

The Chance Ground Set Tester C4033220 provides a 10V DC test voltage. This DC voltage level can easily break down any aluminum oxide to give a reliable reading on all personal protective ground sets.



There are other ground set testers on the market today that use an AC source for testing. These test sets may not apply a test voltage to the jumper high enough to break down any aluminum oxide on ferrules, which could potentially give an incorrect reading. Possible errors are also noted in ASTM F2249-03, section 7.5.4 Note 3 and Note 4:

*Note 3 - AC testing measurements of grounding jumper assemblies are susceptible to errors and inconsistent results due to induction in the cable if the cable is not laid out per the test method instructions.*

*Note 4 - AC testing measurements of grounding jumper assemblies are susceptible to errors if metal is laid across the cable or the cable is laid across a metal object, even if the metal object is buried, such as a reinforcing bar embedded in a concrete floor.*

Other benefits of using the Chance Ground Set Tester include:

- Probing capability allows the user to locate high resistance areas within the ground set.
- Inductance of the cable or “coiling” the cable will not affect the readings.
- Grounding elbows can be tested without disassembling.
- DC voltage is easy to work with in the repair/test facility.

To ensure proper test procedures and methods are applied when testing temporary grounding jumpers, refer to ASTM F2249-03 and the manufacturer’s instructions for proper use of the ground set tester.



**Chance Ground Set Tester**

ASTM F855 requires the resistance of a clamp to be equal to or less than the same length of the largest cable that the clamp will accommodate. The resistance of a new clamp and crimp ferrule to cable value can be in the range of 100 micro-ohms. When tested after use and extended atmospheric exposure, this value may substantially increase. Electrical testers can locate high resistance problems in the area of the clamp and ferrule on the jumper. A typical reading might be 500 micro-ohms for the clamp plus some resistance value for the length of the cable. The increase in resistances is typically the result of dirty or corroded clamp joints, loose inserts in the jaws or badly corroded cable in the ferrule crimp joint. The reading will vary with the size of the cable and type of clamp.

For example a typical test using a tester with the capability to make measurements in the micro-ohm range may be as follows. First, connect the grounding assembly to the tester and make an end-to-end reading through the clamp, ferrules and the interconnecting cable. If an unexpectedly high reading is obtained, use the probe feature to isolate the high resistance area. Using the probes, make measurements from the connection post to the clamp body. This measures the connection to the jaws. Then measure from the clamp body to the ferrule. This measures the connection between these two parts. Then measure from the ferrule to a spot on the cable 1 foot from the ferrule exit. This measures the hidden crimp joint and cable corrosion inside the ferrule. Repeat this procedure on both clamp ends.

A high resistance reading from any of these indicates a need for maintenance. Disassemble the ferrule from the clamp. Clean the clamp jaws and ferrule connection and use a wire brush to remove any corrosion. If the high reading is from the ferrule to cable connection, cut off the ferrule and crimp on a new one. The problem could be that the crimp was loosening, the cable strands were corroding or strand breakage at the ferrule edge.

If the above test does not show a high resistance, the reading will be originating from the cable itself. Make a careful manual inspection, as this is the most reliable means of evaluating the interconnecting cable at this time. Feel for broken strands, corrosion lumps under the jacket or flattened spots that may have been run over by a vehicle. If any of these are found, replace the cable.

Most ground sets can be returned to a usable condition by performing this type of inspection and maintenance on a periodic basis. Remember, the provision to supply suitable equipment is an OSHA requirement.



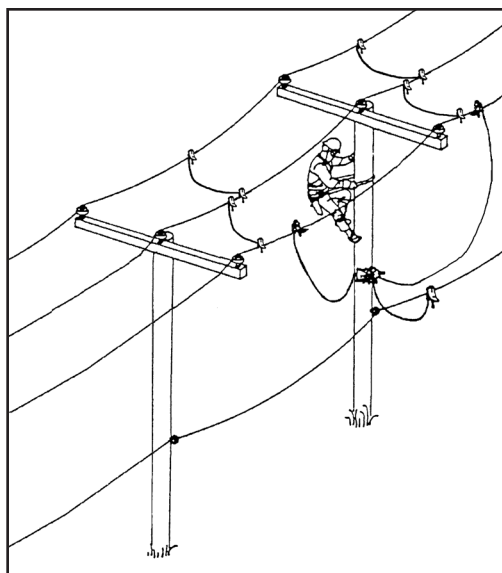
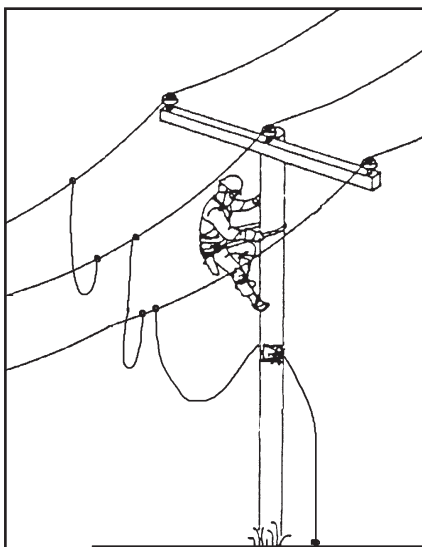

## Basic Protection Methods

### Section 9

**CHANCE**<sup>®</sup>

www.hubbellpowersystems.com  
E-mail: hpsliterature@hps.hubbell.com



Phone: 573-682-5521

Fax: 573-682-8714

210 North Allen

Centralia, MO 65240, USA

©Copyright 2019 Hubbell Incorporated

# Personal Protective Jumpering Methods

Methods using isolation and insulation are not always adaptable at elevated worksites so other methods were developed. Worksite, bracket, worksite bracket and combined grounding are used today. “Equipotential” or “Single Point” and the older “Bracket Grounding” scheme were the most common and are discussed in this section. Today, “Equipotential” or “Single Point” (as it is sometimes called) is the recommended method, used wherever it can be applied.

It must be remembered that many variables enter into the evaluation of a suitable protective grounding method. Some of the key variables typically unknown to the worker at a worksite are the source impedance, the neutral ground resistance or soil resistivity and the resistance of a wooden pole. Some of the variables that are known or can be estimated are available fault current, the distance from the source, the presence of a neutral, the size of conductor or neutral, the presence of a pole down wire and the pole spacing between down wires.

A term used frequently in this section is potential rise. It is the rise in voltage in the vicinity of the worksite and is a function of the resistance values of the various circuit elements included. These combine to create an almost infinite number of worksite scenarios. However, an understanding of the basic principles, estimates of the unknowns and common sense will allow the development of a method that is suitable for multiple locations. For example, if a neutral is present the voltage rise during a single phase (the worst case) fault may reach 50% or more of the line voltage.

- $V_L$  = Voltage drop along source conductor
- $V_N$  = Voltage drop along neutral
- $V_L = V_N$  if size and length are equal
- $V_J$  = Voltage drop of personal protective jumper  $\approx 0$  (near 0)

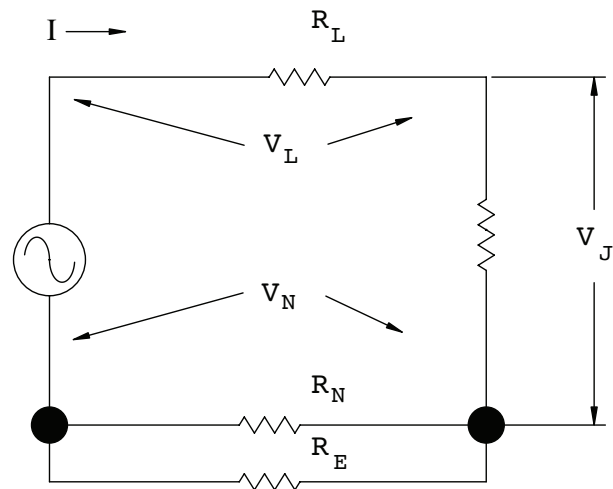

**Protective Circuit with Neutral Included**  
**Figure 9-1**

The actual value will depend very little upon the earth return resistance value since it is in parallel with the low resistance neutral. Review the discussion related to Figure 5-7 for the explanation. If the neutral conductor size is less than that of the source conductor, the worksite voltage will be greater than 50% of the source because the voltage division is a function of the neutrals resistance fraction of the total circuit resistance. Again, see Section 5 for this discussion.

To ensure maximum safety is achieved, voltage must be reduced to a level below that of the onset of heart fibrillation, as discussed in Section 2, the section on medical theory. It is not enough to reduce the body voltage from a high level, which causes injury or serious burns to a level that may result in heart fibrillation, which is often fatal.

## Worksite or Single-Point or Equipotential Grounding

**The key to a successful equipotential protection method is to place the worker in a parallel path with a conductor of sufficiently low resistance to shunt the dangerous levels of current around the body and limiting the maximum voltage across the worker to an acceptable level. Remember that some current will flow in every possible path, but**

**it divides in inverse proportion to the path's resistance. The use of a low resistance jumper is the major factor. The second key factor is to have the line protective equipment provide fast fault removal.**

This method is commonly referred to as "Single-Point", "worksite" or "Equipotential Grounding." The OSHA 29 CFR 1910.269 document requires grounding wherever it can be used. It uses multiple jumpers at the worksite to offer both worker protection and fast operation by the system protective equipment.

The term "Equipotential" technically means equal potential, or objects that are at the same voltage (or equal potential). Potential is another name for voltage. As used in personal protective grounding, it refers to the voltage developed across a worker during the time of fault current flow. The voltage cannot be exactly the same because current flow through anything with resistance creates a voltage drop (refer to Equation 2 in Section 1). The drop can be very small compared to the typical utility line voltage. The voltage across the worker will be the same as that of the jumper because it forms a parallel circuit with the worker. The maximum voltage on the worker then becomes a function of the fault current through the personal protective jumper. This is an application of one form of Equation 2 ( $V_{MAN} = R_{JUMPER} \times I_{JUMPER}$ ).  $I_{JUMPER} = I_{FAULT}$  for all practical purposes because of the extremely low jumper resistance. This voltage must be limited to the maximum selected safe value.

This method requires additional protective grounding jumpers, beyond the minimum one in parallel as described in the previous paragraphs. All phases, the neutral and an Earth connection would be bonded together at the worksite. The low resistance ground set in parallel with the worker provides the worker protection. The bonding of the phases to the neutral and Earth ensure the maximum speed in fault clearance. This meets the two requirements of a safe worksite: a low resistance parallel path to the worker and the shortest time energized as possible. The multiple connection of neutral and Earth represent a dual return path to ensure a fast clearance. This could be a critical feature if an

undersized neutral is present and has insufficient current-carrying capability to avoid fusing during the fault current flow. The worksite potential rise remains a function of the Earth return resistance and conductor and neutral resistances. In many cases, the maximum level achieved will be around 50% of the line voltage at the time the line becomes accidentally re-energized.

The actual connections recommended for a wooden structure are:

- Attach a cluster bar to the pole ensuring that it is making conductive contact with a metal spike or nail that penetrates the wood at least as far as the climber's gaffs (OSHA 1910.269 Appendix C)
- A ground set from an Earth connection point to a cluster bar mounted below the worker's feet
- A ground set from the cluster bar to the neutral
- A ground set from the cluster bar to the nearest phase conductor
- A ground set from the nearest phase conductor to the next phase conductor
- Finally, a ground set to the last phase conductor

A ground set may be used to connect to a static wire overhead. The static wire normally should not be used as the only return path. It often is steel wire, which has a higher resistance. It does not always provide a continuous return path to the source because it may be intentionally broken at periodic lengths. But, it may provide a connection to multiple Earth return paths to help divide any fault current present.

It is the resistance of the protective ground set(s) that is in parallel with the worker that must be kept below the maximum calculated value because this is the jumper providing protection to the worker. Its resistance must be based upon the utility's selected maximum body current and/or voltage. This can be achieved by selecting an appropriate conductor size and length, keeping in mind that resistance increases with length and decreases as the cross sectional area increases. The remaining ground sets must be sized to

ensure they do not fuse during the flow of fault current. These ground sets are to maximize the fault current so the system protective devices operate as quickly as possible.

An example will be used to illustrate the procedure for calculating this maximum resistance value. The values used in the example were selected only for the example. First, we request the available fault current and maximum breaker operation time at the site from the engineering department. Next, the company safety department provides the maximum allowed voltage across the worker, the current through the worker, or both.

Assume: Maximum worksite available fault current = 12,000 amp.

The maximum breaker interrupt time is 20 cycles (0.333 sec.)

The accepted level of safety:

Voltage across the worker,

$$V_{\text{WORKER, MAX}} = 100 \text{ volts OR}$$

Current through the worker,

$$I_{\text{WORKER, MAX}} = 1/3 \text{ the heart fibrillation level}$$

The average workers weight = 155 lb.

Average man resistance = 1,000 Ohms

$$I_{\text{FIBRILLATION}} = I = k/\sqrt{t}$$

where k = 157 for 155 lbs.

and t = .333 seconds

$$I_{\text{FIBRILLATION}} = 272 \text{ milliamperere}$$

$$I_{\text{WORKER, MAX}} = 1/3 \times I_{\text{FIBRILLATION}} = 1/3 \times 272 = 91 \text{ milliamperere}$$

$$I_{\text{MAN}} = \frac{(R_{\text{JUMPER}})}{(R_{\text{MAN}} + R_{\text{JUMPER}})} \times I_{\text{AVAILABLE}}$$

Rearranging this equation to solve for  $R_{\text{JUMPER}}$ :

$$R_{\text{JUMPER}} = R_{\text{MAN}} \times [I_{\text{MAN}} / (I_{\text{FAULT}} - I_{\text{MAN}})]$$

$$R_{\text{JUMPER}} = 1,000 \text{ Ohms} \times [0.091 \text{ amp} / (12,000 \text{ amp} - 0.091 \text{ amp})] = 0.0076 \text{ ohm or } 7.6 \text{ milliohm}$$

Therefore:

$$V_{\text{MAN}} = I_{\text{JUMPER}} \times R_{\text{JUMPER}} = (12,000 \text{ amp} - .091 \text{ amp}) \times .0076 \text{ ohm} = 91.2 \text{ volts}$$

Which meets the requirement.

This will meet the two specified requirements. Now it is necessary to select the components for each jumper assembly.

Note that this is the maximum resistance permitted for the complete assembled jumper(s) in parallel with the worker. As the worker reaches from one phase to another, the number of jumpers in parallel with the body may change, depending upon the installation. The maximum number that can be in parallel must be considered. On a 3-phase system, the worker may place his body in parallel with up to three series jumpers without thoughtful placement, see Figures 9-2 and 9-3.

The cable is chosen from Table 8-1. The available 12,000 amp for 20 cycles exceeds the AWG #2 rating so AWG 1/0 is selected. Wiring tables for copper AWG 1/0 grounding cables show it has 0.098 milliohm/ft. Assume each cable/ferrule/clamp combination resistance is 0.5 milliohm. This provides three 10 ft. jumpers equal to 1.98 milliohm each or 5.94 milliohm total.

By careful placement of jumpers at the worksite, we ensure the worker never has more than two series ground sets in parallel with his body. This will meet the safety specifications.

Corrosion on the line may add sufficient resistance at the connection points in the parallel path to exceed the selected safe level of body current selected by the workers utility.

If it is necessary to use longer jumpers, a larger cable size should be considered as a means of maintaining the needed low resistance.



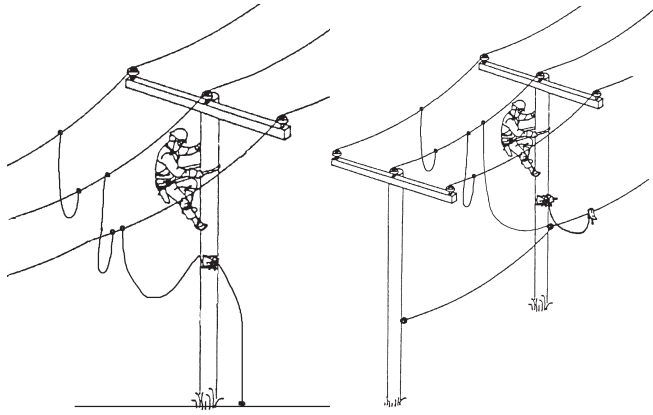

**Parallel with up to Three Series Jumpers**  
**Figure 9-2**

**Parallel with up to Two Series Jumpers**  
**Figure 9-3**

The resistance of the protective ground set making the Earth and neutral connections should be sized to prevent fusing under the available fault current. They increase the worksite safety by providing a return path, but are not in parallel with the worker, so their voltage drop does not add to the voltage across the worker.

### Paralleling Grounds

Any ground assembly not paralleled must be fully rated for the total available fault current. In some instances, it may be necessary to parallel grounds to adequately carry the available fault current. This is also used as a convenience for the workers when the size of the equipment becomes so large or heavy that it is difficult to install. To obtain equal current flow through each paralleled set, the sets should be identical to ensure the resistance of each path is equal. The clamps should be installed as close together as possible. Because higher fault currents are expected, cables should be tied to the structure to minimize whipping or mechanical damage to the clamps. When using this method and tying the cables together, each paralleled ground set must have its current carrying capability de-rated by 10%. Do not wind the cables around the structure as this increases the coupling between the cables and the structure and increases any induced current or voltage in the structure.

For example:

Assume the available fault current is 40,000 Amperes and it can be expected to flow for 15 cycles. The available personal protective jumpers are formed from ASTM Grade 5 clamps and AWG 2/0 cable. Each set carries an individual rating of 27,000 Amperes for 15 cycles.

The choices are to increase the cable size to AWG 4/0 cable or to parallel two sets. Reference to Table 8-1 (Section 8) shows the withstand rating of AWG 4/0 cable is 43,000 Amperes for 15 cycles. For parallel cables, the de-rated current withstand carrying capability of the original 2/0 set is 24,300 Amperes each. Paralleling two sets gives a current carrying capacity of 48,600 Amperes. This meets the current carrying requirement and the installation may be more acceptable. Keep in mind that there is no protection until the parallel set is fully installed because the current exceeds the rating of a single set during installation.

### Double-Point or Bracket Grounding

For many years it was a common practice to place the protective equipment on structures on either side of the worksite, one toward the source, the other toward the load. It is called “working between grounds” and considered to be quite safe. An often-heard comment was that if the current comes from the right, the current will return through the ground sets on the right. If the current comes from the left, the current will return through the ground sets on the left. This is inaccurate. Some current will flow through every possible path. In one form, the two sets of ground were placed on separate structures on either side of the worker. A thoughtful evaluation of this method shows that this is not always safe. In some cases, it is the most hazardous.

First consider a 3-phase line with 3-phase jumpers connected between the phase conductors and the neutral, or earth. Several variables will affect this protective scheme. Among them will be the relative balance between the phases, the requirement for the

fault to be a 3-phase fault for the worker to be safe, and the location of the worksite with respect to the center of the bracketing jumpers.

The fault current resulting from a 3-phase fault on a balanced system flows back to the source on the source conductors. Only the current resulting from the unbalance of the system flows through the jumper connection to the neutral or earth. But the worker has no way of knowing how well the system is balanced, and typically it is not well balanced.

Next consider a single phase fault, which is more common than a 3-phase fault. Commonly the two bracket sets are placed on adjacent or even more remote structures on either side of the worksite. If a de-energized line becomes accidentally re-energized, the conductor voltage rises to the voltage level that the system can support before the fault sensing equipment operates and clears the voltage from the line. The protective ground sets have very low resistances, so the elevated line voltage is transferred from the ground set connection point to the neutral and/or Earth connection point at the nearby structures. The tower bases at the ground connection then rise to equal nearly that of the voltage on the line. But with the worksite between the installed protective ground sets, without a connection between the conductor and earth, there is no elevation of voltage of the Earth or tower base below the worksite. The voltage level of the Earth or tower base will remain near zero. If the structure is conductive (steel) or a pole down wire on a wood pole is present and near the worker, the potential near the feet stays near zero. If the worker is in contact with the conductor at the time the line becomes energized, the full-elevated voltage of the line may be across the body. Remember, the larger the value of resistance, the larger the voltage drop developed across the resistance. Review Figure 5.7 and the associated text if necessary. In this portion of the series circuit, the worker resistance (assumed to be 1,000 Ohms) is by far the largest in most cases. Assuming an Earth resistance of 25 Ohms means nearly the full voltage drop is across the worker by the fraction of  $V_{\text{source}} \times [1000 /$

$(1000+25)]$ .

Figure 9-4 illustrates this scenario. This situation can cause injury or death at utility voltage levels because there is no direct low resistance path shunting the current around the worker's body. The worker becomes a path from the line through his body then through the Earth return path.

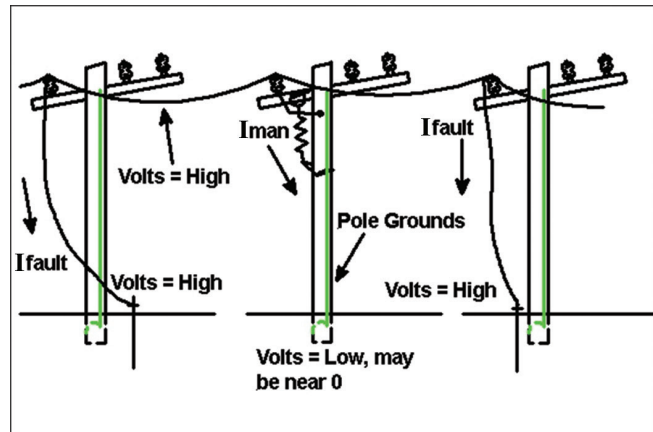

**Bracket Grounding, Adjacent Structures**  
**Figure 9-4**

If the worker is on a wood pole that has no pole down wire, the pole and worker become part of the series circuit between the conductor and the Earth. The fraction of voltage across the worker then depends upon both his resistance and that of the pole. In some cases, this increases worker protection. In others, it may not.

Remember, voltage divides in a circuit in the same proportion as each element's part of the total circuit resistance. What is the resistance of the pole? Values of pole resistance have been measured that range from a few thousand Ohms to several megohms. So a wide variation of voltage on the worker could occur unless other precautions are taken. If on a steel tower, a similar situation occurs. What is the resistance of the tower, how does the voltage divide? Notice the lack of a system neutral in this discussion. That leaves the worker as a direct connection to Earth. Other systems may have a neutral present. Ground sets connected between conductors and the neutral provide a low resistance return path path for the current to its source. This forms a low resistance path in parallel with the higher resistance path through the



Earth. If the worker is still in a separate current return path (for example, when the neutral is mounted on an insulator) the neutral resistance usually is so low that most of the current returns by way of the neutral, reducing the current available through the worker. In some cases, this may provide a measure of protection to the worker, through luck rather than planning.

Often the bracketing jumpers are placed a great distance apart, allowing the worker to relocate the worksite within this span. As the worksite approaches the source, within the span, the worker's body current increases. Conversely, as the worksite transfers toward the remote end of the bracketed span the worker body current is reduced. Moving the worksite toward the source removes some line resistance between the source side bracketing jumper and the worker, allowing body current to increase. When moving in the opposite direction line resistance is added, reducing the worker current. Review the parallel circuit shown in Fig. 5-6. Changing the resistance of either parallel path changes the division of current within the parallel circuit.

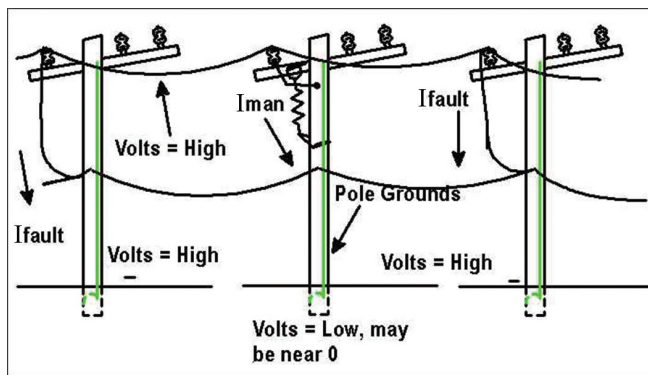
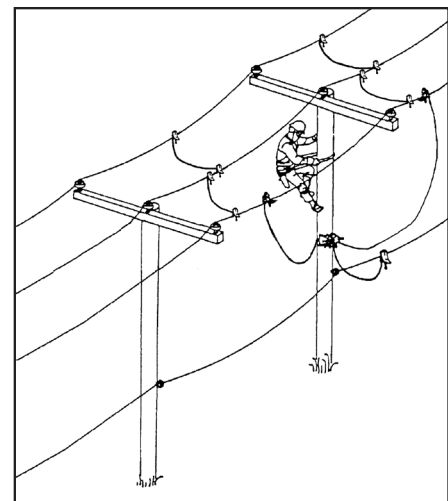

**Figure 9-5**

Here, good judgment by the worker must be exercised to evaluate the site, the variables and conditions present. Because so many situations possible in Bracket Grounding would require a judgment decision by the worker at each site, it is recommended to develop a suitable work method to avoid such field judgments.

Now consider the situation where two personal protective ground sets are both installed on the same structure, one on each side of the worker. This form is an adaptation of both

the Bracket Method mentioned above and the Equipotential Method. In Figure 9-6, conductors have been connected together and to a cluster bar beneath the worker's feet. Protection results from the low resistance ground sets directly in parallel with the worker, not because there is a set on either side. There is a benefit to using this technique. If very large fault currents are available, the jumper cables themselves can be of a smaller size as the current is now divided between the two sets. This may make installation easier and receive more acceptance from the line worker because the equipment is lighter weight. Attention must be paid to the sizing of any single connection in this scheme that must carry the full current. That is, if smaller size cable can be used to bond the phases to a cluster bar on each side of the worker, a single connection to the Earth or to the neutral must be larger to carry the full current.



**Bracket Grounding, Same Structure**  
**Figure 9-6**

Storm damage often requires Bracket Grounding. It is used if a conductor has broken and is on the ground. Then it becomes necessary to ground at the structures on either side of the break. But if the line becomes energized and the worker is standing on the Earth, he is also a return path. In this case, it would be necessary to bond a conductive mat to the two conductor ends for him to stand on while making repairs, to maintain the same voltage from the hands to the feet.

There are other maintenance situations that do not lend themselves to Single-Point (or

equipotential worksite) grounding. In most of those situations Bracket Grounding can be a usable method if thought is given to worker protection in combination with bracketing (see Combination Grounding below).

### Single Bypass Ground Set - Minimum Requirement for Worker Protection

In this configuration, only a single jumper used with a cluster bar would be used. It would connect from the one conductor being maintained to the cluster bar below the worker's feet. The jumper maintains the required low resistance path in parallel with the body. As in all parallel situations, all current available divides between the jumper and the worker if the worker is in contact at the time of current flow.

Whether sufficient current bypasses the body to maintain a safe environment is a function of the equipment and body resistances present. To use this method, some information or estimates must initially be acquired. Needed are the worksite available fault current, the assumed value of worker resistance and required jumper length and the resistance of the remaining path to Earth (pole or tower), because that would be the return path. With these data, calculations can be made for sizing the protective jumper. Equation 7 is a repeat of Equation 5a and can be used to make this calculation.

$$I_{MAN} = I_{AVAILABLE} \times \frac{(R_{JUMPER})}{(R_{MAN} + R_{JUMPER})} \quad \text{Eq. 7}$$

Again using parallel circuit theory, the maximum ground set resistance can be determined which would maintain the body current level below the selected value. Even if there is only a very small current due to high pole and earth resistance in the overall circuit, the percentage division between the paths remains the same as the calculated ratios. Obviously, the higher the current, the lower the protective ground set resistance must be to keep the body current below the safe level.

If the worker is on a wood pole with only one protective ground set in place, the pole

resistance and return Earth path become the current-limiting resistances. The ground set would protect the worker, but the current magnitude may be so low the line protection equipment fails to recognize that a fault has occurred, leaving the line energized for an extended time.

This is an incomplete solution because the system protective equipment may not see that a fault exists, or because the estimates may be completely wrong. Therefore, this is not a recommended method. By expanding upon this method, a usable method can be obtained.

### Combination Grounding

An acceptable form of single bypass ground set method is the use of a Single bypass ground set AND the Bracket Method. The bracket grounds provide the system fault information to the protection equipment. The single bypass ground set, called a personal ground set, connects between the cluster bar and the conductor to be contacted. It provides the low resistance parallel path without requiring the installation of a full set of ground sets at the worksite on all phases, neutrals, etc. This combination method provides a means of worker safety when the worksite moves from pole to pole, within the area between the two ground sets that make up the bracket grounds span.

It is important that the worker not touch any conductor except the one connected to the single bypass ground set. For example, if contact is made to phase B while the ground set is connected to phase A, the current shunt path is now phase B conductor length from the worksite to the bracket set and back to the worksite on phase A, then to the cluster bar. The added resistance of the added conductor lengths may be fatal, depending upon the resistance of the conductors.

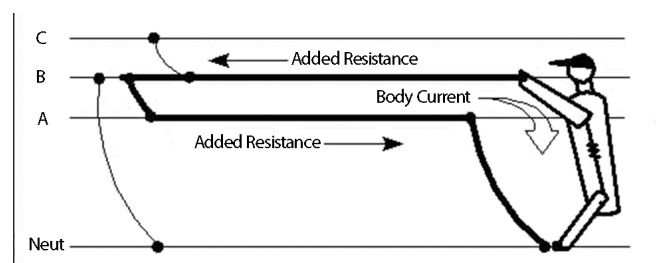

Figure 9-7



## General Installation Procedures

### Section 10

**CHANCE**<sup>®</sup>

www.hubbellpowersystems.com  
E-mail: hpsliterature@hps.hubbell.com



Phone: 573-682-5521

Fax: 573-682-8714

210 North Allen

Centralia, MO 65240, USA

©Copyright 2018 Hubbell Incorporated

# General Installation Procedures for Personal Protective Jumpers

General guidelines only are presented here. A discussion of some of the applications peculiar to specific situations is presented later.

## **1. Verify the line is truly de-energized:** [OSHA 1910.269]

Before applying any protective jumpers, the status of the line must be determined. Several techniques are available. A common field technique is “fuzzing” or “buzzing” the line by holding a wrench mounted on an insulated “hot stick” or the metal head of a Universal Tool near the conductor. The theory is that if the line is energized it will induce a voltage in the wrench or metal head and corona discharges will cause an audible sound.

“Fuzzing” is not a recommended technique. The detection of any audible sound is very subjective and is dependent upon wind conditions, line voltage level, nearby noise levels, etc. It is reported to be more reliable on transmission lines because of their higher voltages, but the use of a detector designed for the purpose increases the level of safety. Chance offers several models of the Multi-Range Voltage Detector and Phasing Tools that can be employed to significantly increase the reliability of this determination. See Section 8 for a discussion of these devices.

Protective equipment can be installed once the line has been de-energized and the absence of voltage has been verified.

## **2. Clean the connections:**

All of the connections should be made to a cleaned surface. Either a wire brush or serrated jaw clamp can be used on distribution voltage level conductors. On high voltage

transmission towers only the wire brush is recommended. Use of the serrated jaw clamp may leave sharp edges on the soft aluminum conductor that could result in increased corona discharge.

For tower connections it may be necessary to clean away paint, rust or corrosion before making the connection. Fault current passing through a layer of paint that separates the clamp from the tower steel will cause it to heat and soften, melt or burn away. A flat face clamp could lose its grip and come off the tower, breaking a connection and possibly losing the protective parallel path. It may be desirable to tie the clamp to the tower steel to prevent it from coming off and to avoid the loss of protection from these hazards. Locate each clamp to maximize worker safety. The added resistance of a corroded connection may increase that of the parallel path as to jeopardize worker safety.

## **3. Order of installation of personal protective jumpers:** [OSHA 1910.269]

Install the personal protective jumpers using an insulated Grip-All clampstick. Begin by connecting a ground end clamp to an appropriate Earth connection. Per the OSHA acceptable methods of grounding for employers that do not perform an engineering determination found in 1910.269 Appendix C, the circuit should be grounded to the best ground available at the worksite as follows:

- Must ground to system neutral if present
- Ground to substation grid in a substation
- Ground to remote ground when lower impedance grounds are not available
- Ground to temporary driven ground if above 3 are absent



It is important that a pole down wire not be used for this connection. The small size of a pole down wire could cause it to fuse and melt during the flow of fault current, resulting in the loss of the connection for the Earth return path.

For wooden poles, the line end clamp should then be installed onto a cluster bar attached around the pole as close as possible below the location of the worker's feet. The cluster bar provides a conductive connection point for use with multiple clamps and a convenient parking location for clamps during installation. The cluster bar also provides the bond to the pole, and per the OSHA acceptable methods of grounding for employers that do not perform an engineering determination found in 1910.269 Appendix C, should also be in conductive contact with a metal spike or nail that penetrates the wood at least as far as the climber's gaffs, bonding it to the potentially more conductive interior of the pole. Additional protective jumpers are then installed from the cluster bar to the neutral and then to each conductor, beginning with the closest one and ending with the farthest one. The worker must remain clear of the conductors during the installation of this safety equipment and not approach within the minimum approach distance.

A cluster bar would typically not be used on a steel transmission tower. The worker's parallel protective jumper would connect from the tower to the conductor, still below the worker's feet. While the tower is itself a connection to the Earth, depending upon the tower's age, the amount of corrosion or paint present may or may not represent a suitable current path. A part of the personal protective jumper assembly should consist of clamps with cable of sufficient length to reach from the elevated worksite to the Earth below and be installed as described above.

Procedures may be altered to fit different working conditions (for example, in substations or working from a bucket truck). More

information is provided in following sections detailing these situations.

Try to minimize the maximum number of jumpers in series that can be in parallel with the worker. There will be three series jumpers in parallel with the worker if hand contact is made to the furthest distant phase (see Figure 9-6 of Section 9). Figure 9-7 reduces the maximum number of parallel jumpers to two by thoughtful placement. This may or may not present a problem, depending upon their total resistances. The process of calculating the maximum resistance with the worker (in Section 9) should be reviewed. If the center phase can be safely connected first, the maximum number of jumpers in parallel with the worker will be reduced to two. If the resistance is still too high, it may be necessary to use a larger cable size to obtain the necessary reduction in resistance.

Each connection should be situated so as not to interfere with the work being done. Finally, minimize the cable slack because shorter cables have lower resistance and reduce possible mechanical whipping action during a fault that could strike and injure a worker. This is especially true as fault currents approach 40,000 to 50,000 Ampere levels.



## Applications and Considerations

### Section 11

**CHANCE**<sup>®</sup>

www.hubbellpowersystems.com  
E-mail: hpsliterature@hps.hubbell.com



Phone: 573-682-5521 Fax: 573-682-8714

210 North Allen

Centralia, MO 65240, USA

©Copyright 2018 Hubbell Incorporated



# Applications and Considerations

The preceding sections reviewed the topic of providing worker protection beginning with some history, various notable current levels, equipment characteristics and ending with a general description of various protection schemes and installation methods.

The following methods present a general approach. They attempt to present some of the benefits and drawbacks of the various practices. They should be considered in conjunction with the work practices of the worker's utility. The discussions that follow represent workers doing maintenance at conductor level (aloft) on either wood or steel structures, a ground support person, truck grounding, substation work, maintenance and protection while doing underground maintenance.

Only special cases of working between grounds formed by Bracket Grounding are included due to the possibility of a misapplication that could lead to a hazardous situation.

## Equipotential or Single-Point Grounding at the Worksite

The Equipotential Method is the recommended method whenever it can be used. It consists of a complete set of ground sets bonding the phases, the structure, the neutral and Earth together to form an equipotential zone for the worker, as discussed in Section 9. The ground sets are placed on the same structure as the required maintenance. Both neutral and Earth connections are used if both are available, the neutral as primary fault current return path and the Earth as a backup path. The connections are made as described in the installation section. The ground sets bonding the phases and neutral to the cluster bar must be of a gauge no smaller than the maximum value calculated in Section 9 and to prevent cable fusing during a fault condition.

On a wood pole, a cluster bar is used as a connection point and to bond the structure to the ground sets. Per the OSHA acceptable methods of grounding for employers that do not perform an engineering determination found in 1910.269 Appendix C, the cluster bar should also be in conductive contact with a metal spike or nail that penetrates the wood at least as far as the climber's gaffs, bonding it to the potentially more conductive interior of the pole. The cable from cluster bar to the Earth must be large enough to avoid fusing, but may be expected to have a higher resistance due to the longer required length.

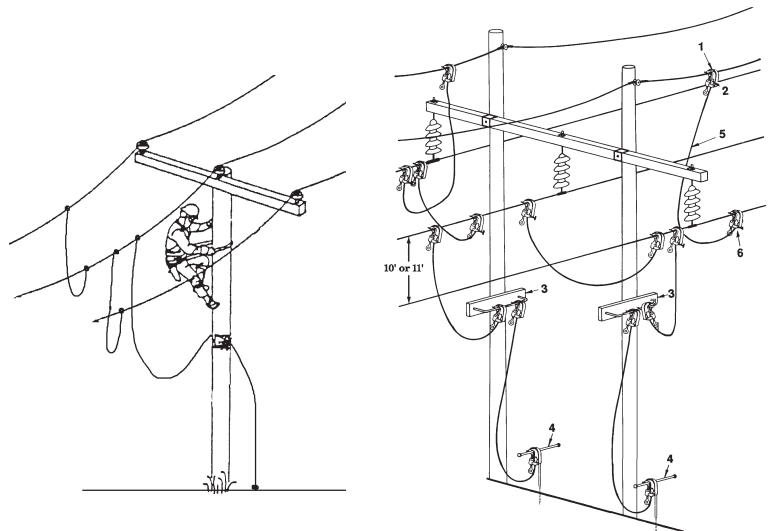

**Equipotential Method on a Wood Pole**  
**Figure 11-1**

**Equipotential Method on an H-Frame Structure**  
**Figure 11-2**

On a steel tower, the cluster bar is typically not used. A cable from each conductor to the tower below the worker's feet is recommended for each conductor that the worker may contact. Ground sets to additional phases may not be required if spacing is so great that the worker cannot reach another phase. Although, there may be other reasons for adding additional ground sets.

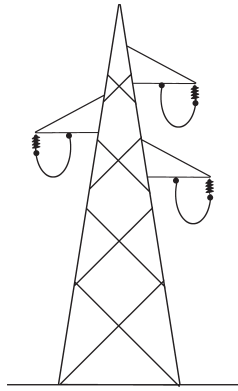

**Equipotential Method on a Steel Tower**  
**Figure 11-3**

This method offers protection for the worker within the equipotential zone. Other workers on the same tower may or may not be affected during a fault. While the tower will experience a rise in voltage, if the workers are not in a path of current flow, their bodies may not bridge a difference of potential. Or, a worker located between the ground set contact point and the Earth may notice an electrical shock depending upon the resistance of the steel, the amount of corrosion of the various joints, the voltage present and the resistance in the series path.

**Worksite Remote from Grounds (Limited Distance)**

In some circumstances, working at a distance from the pole or structure with the full set of installed grounds is required. To provide safety to the worker, working away from the grounds a personal ground set is required, consisting of a cluster bar and single grounding jumper. Note that this method requires the installation of both the full set described as Equipotential (or single-point protection) plus the personal ground set.

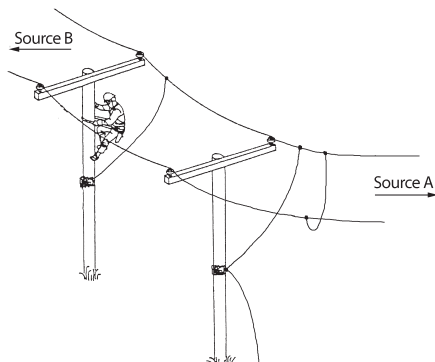

**Personal Jumper, Away From Worksite**  
**Figure 11-4**

On a wood pole, the cluster bar is installed below the worker's feet and the ground set connects the cluster bar to the neutral. In this case, the low resistance path in parallel with the worker is some distance away. The worker's path consists of the length of conductor and neutral wire between the installed personal protective ground set and the worker's remote worksite plus the jumper.

In this case, it is important to know the value of available fault current and the size of the conductor and neutral. Using techniques described earlier, it can be determined if the division of fault current will result in a worker voltage that exceeds the maximum selected level. The direction of the current source must also be considered. The circuit shown in Figure 11-4 illustrates this. A calculation is made for both the jumpers installed between the worker and the source and again for the case of the ground sets installed downstream from the worker and the source. There is a significant difference in the current values through the 1,000-Ohm man in these cases.

- $I_{SOURCE} = 10,000 \text{ Amp.}$
- $R_L = 1 \text{ span conductor or } 300 \text{ ft. of } 2/0 \text{ ACSR} = 0.024 \text{ ohm}$
- $R_N = 1 \text{ span Neutral or } 300 \text{ ft. of } 2/0 \text{ ACSR} = 0.024 \text{ ohm}$
- $R_{J1} = \text{Jumper Resistance} = 0.001 \text{ ohm}$
- $R_{J2} = \text{Jumper Resistance} = 0.001 \text{ ohm}$
- $R_M = \text{Worker Resistance} = 1,000 \text{ ohm}$

Personal protective jumpers between the worksite and Source A:

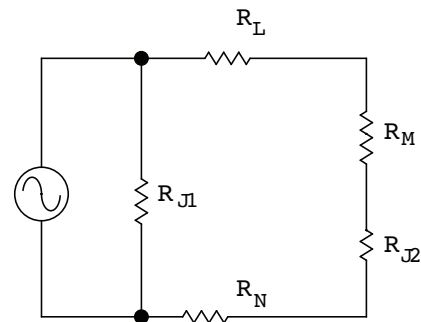

$$\begin{aligned}
 I_M &= I_{SOURCE} \times [R_{J1} / (R_{J1} + R_L + R_M + R_{J2} + R_N)] \\
 &= 10,000 \times [(0.001 / (0.001 + 0.024 \\
 &\quad + 1,000 + 0.001 + 0.024))] \\
 &= 10 \text{ milliamperes} \\
 &\text{or 10 volts impressed across the worker.}
 \end{aligned}$$

Personal protective jumpers opposite from the worksite and Source B: **This is a situation to avoid.**

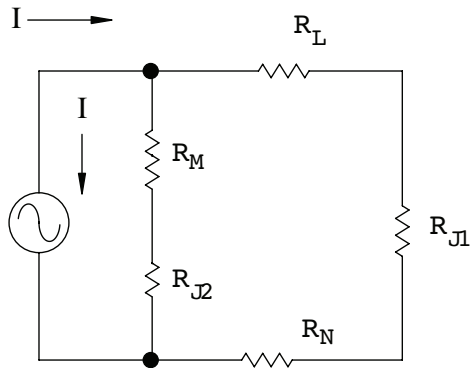

$$\begin{aligned}
 I_M &= I_{SOURCE} \times (R_L + R_{J1} + R_N) / (R_L + R_{J1} \\
 &\quad + R_N + R_M + R_{J2}) \\
 &= 10,000 \times (0.024 + 0.001 + 0.024) / \\
 &\quad (0.024 + 0.001 + 0.024 + 1,000 + .001) \\
 &= 490 \text{ milliamperes}
 \end{aligned}$$

Or 490 volts impressed across the worker.

Utilities vary on the allowable distance from the installed set, that is, the number of allowed spans. The calculation is based upon their available fault current, selected maximum worker voltage, conductor resistance (length and resistance/unit length) and direction to source. This method requires both field judgments by the maintenance workers and the review of the safety and engineering departments of each utility. It will be necessary to adjust both  $R_L$  and  $R_N$  in the above example.

### Modified Worksite Remote from Grounds by Adding a Personal Jumper

In some situations, working away from grounds is required to complete the task. As explained earlier, this can be a hazardous situation. Use of the personal ground mentioned above in the Worksite Remote from Grounds (Limited Distance) section can be modified by adding a protective jumper from the cluster bar to the conductor, as here contact is ex-

pected, in parallel with the worker to provide protection to the worker aloft. Again, the distance from the fully installed set must be considered. In this case, there always will be a full set of protective ground sets present and a low resistance ground set in parallel with the worker, assuring lower current through the worker and rapid removal of the line voltage.

Additional distance away from the full set is achieved by adding the jumper to the personal jumper described earlier. Placing the ground sets from the cluster bar to the neutral and from the cluster bar to the phase being worked ensures the worker always will be in parallel with a low resistance ground set.

Assume the worksite is now five spans from the installed personal protective ground set on the side away from the source.  $R_L$  and  $R_N$  are now  $(5 \times 0.024) = 0.120$  Ohms each.

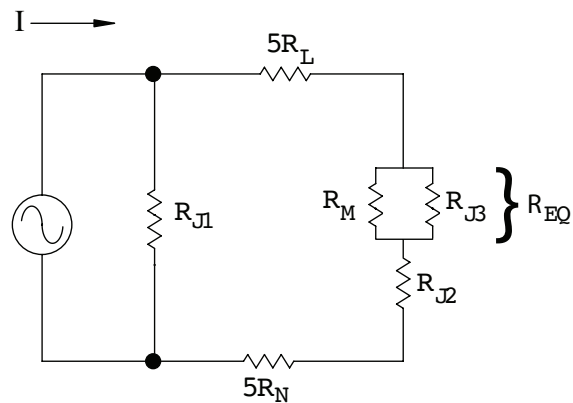

$$R_{EQ} = (R_M \times R_{J3}) / (R_M + R_{J3})$$

$$I_{EQ} = I_{SOURCE} \times [R_{J1} / (R_{J1} + R_L + R_{EQ} + R_{J2} + R_N)] = 41.2 \text{ Amp}$$

$$I_{MAN} = I_{EQ} \times [R_{J3} / (R_{J3} + R_{MAN})] = 41.2 \text{ microamp}$$

Or a body voltage of 41 millivolts

Now assume the worksite is five spans from the installed personal protective ground sets on the side toward the source.  $R_L$  and  $R_N$  remains = 0.120 Ohms each.

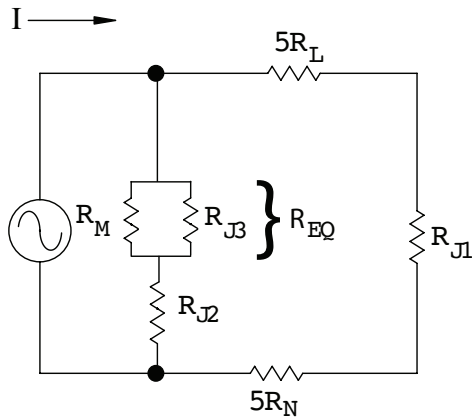

The parallel combination formed by the worker and  $R_{J3}$  remains 0.001 Ohm

$$I_{EQ} = [(R_L + R_{J1} + R_N) / (R_{J2} + R_{EQ} + R_L + R_{J1} + R_N)] = 9,918 \text{ Amp.}$$

Now calculate the current through the worker using Equation 5.

$$I_M \cong 10,000 \times (R_{J3} / (R_{J3} + R_M)) = 10 \text{ milliampere}$$

Or a body voltage of 10 Volts

This is a significant improvement over the 490 Volts previously present when the worksite was only one span removed from the fully installed set of personal protective ground sets.

### Working between Grounds Installed on Remote Structures

An improvement to the previously described worksite with the additional personal jumper can be made that eliminates the problem of the source direction. The installation of a second full grounding assembly, but away from the worksite on the side opposite the initial set eliminates the increase in worker current if the fault comes from the other direction. Figure 11-6 illustrates this configuration. This provides a low resistance current path closer to the source than the worksite regardless of the source direction that activates the protective equipment in the minimum time. The low resistance path placed closely in parallel with the worker provides the worker protection.

### Working between Grounds Installed at the Worksite

Using two sets of personal protective ground sets was also an earlier method of working between grounds. In this case, the worksite is at the conductor level, on a single pole. One ground set is installed on the source side of the worksite, the other on the load side. This method does not present the hazard of Bracket Grounding between ground sets installed on remote structures because the worker is in a close equipotential zone, see Figure 11-7.

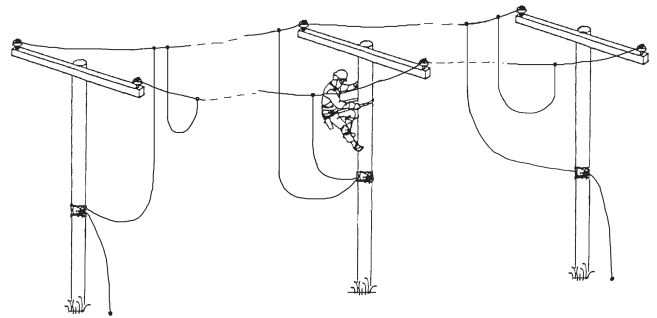

**Bracket Grounding of Multiple Spans with Personal Jumper, at Worksite**  
Figure 11-6

There is benefit to this scheme. Remember that some current will flow through every current path. This means the fault current will divide between the two low resistance ground sets on the contacted phase and the worker. The division of the fault current means less current in any one ground set, allowing smaller sized personal protective jumper sets. This is one method of providing protection for very large values of available fault rather than increasing the size of the cable and clamps to accommodate the larger current.

While this was referred to as “working between grounds,” it is really an example of creating an equipotential zone using parallel jumpers for increased current carrying capability.

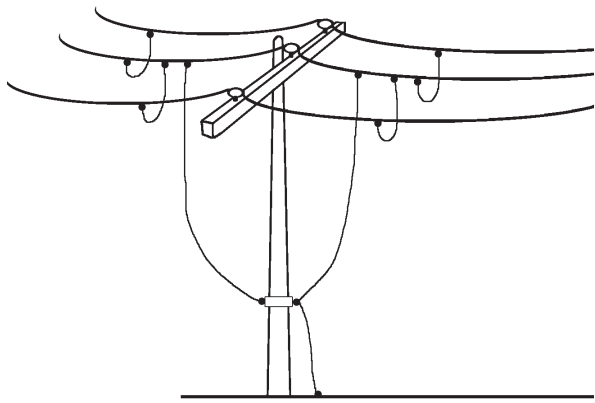

**Bracket Grounding at Single Structure**  
Figure 11-7

### Ground Support Workers

Methods are available to protect the worker aloft. It is more difficult to protect the ground worker from a twofold problem of the step or touch potential hazards. The methods of protection remain the same: Insulate, isolate or use equipotential zoning. Rubber insulating mats or boots could be used. However, the mat would have to be large and maintaining the dielectric integrity of either mats or boots could be difficult. Walking on rough surfaces could partially or completely puncture the insulation, eliminating the protection. Inspection would not be as easily done as for rubber gloves.

Barricading is often used to maintain isolation between the worker and any contact with an energized item. After the pole top worker is set and has the tools and components needed, the work pole could be barricaded. By maintaining a safe work distance from anything that may become energized, the ground worker could avoid injury. Caution must be used whenever necessary to lower the barricade to send up additional tools or line components.

The technique of equipotential zoning could be used. This involves placing a conductive mat or conductive grill under the worker's feet that is bonded to the touch point that may become energized. This method eliminates the step or touch voltage because the conductive mat rises uniformly to nearly the same volt-

age as the voltage to which it is connected. This minimizes the voltage developed on the worker's body using the same low resistance parallel path as discussed earlier.

A hidden hazard of this method is that the maximum step voltage is transferred from the Earth contact point to the edge of the conductive mat. The worker must remain on the mat during a fault condition. If he steps off, he bridges the same 3 feet of voltage drop as discussed earlier. Figure 11-8 illustrates this technique. Therefore, the worker must take proper precautions such as using insulated steps or hopping onto or off the conductive mat.

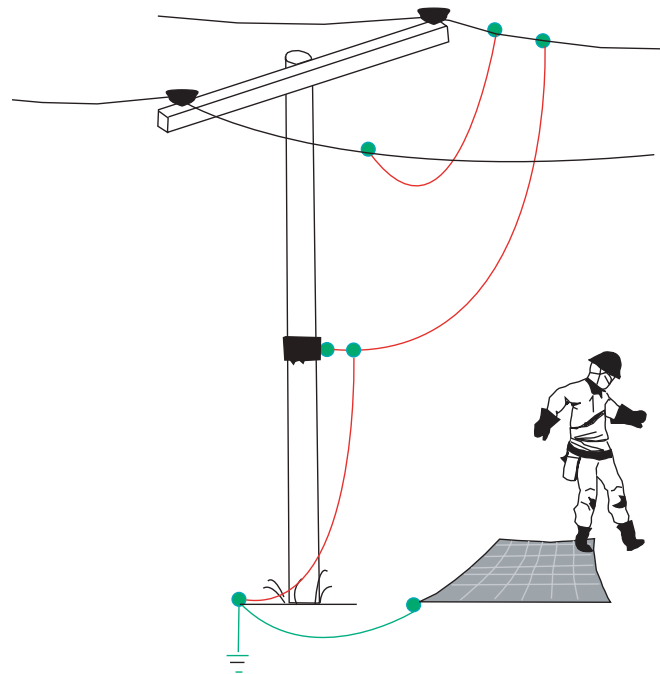

**Step Potential**  
Figure 11-8

As an example of touch potential, overhead switch handles are often connected to grills placed where the operator must stand to operate the switch.

### Working with or around Trucks and Equipment

An equipotential zone of protection is needed when performing maintenance from a bucket. If the boom is metal, the worker will be a primary path to Earth if a conductor becomes accidentally energized while the worker is in contact. Connecting the boom tip to the



conductor provides the low resistance parallel path.

This is not the hazard if the truck has an insulated boom. The boom insulation isolates the worker as a current path to Earth. However, the close spacing of distribution lines and some transmission lines may present a different hazard. The worker may lean into a phase while working on another phase. Or he may come in contact with the pole, crossarm or down wire while working on a phase. Any of these inadvertent contacts may put the worker in danger. By using a full personal protective ground set as described earlier, the worker can remain in parallel with low-resistance ground sets while working.

A major step and touch hazard is presented to ground support personnel working around trucks or other equipment. For example, if the lower elbow of an insulated boom swings into an energized phase, the truck body becomes energized and the ground worker may not be aware of it. There is no path back to the source through the insulated boom. The worker in the bucket probably would also be unaware of the problem. There may be sufficient resistance through the truck parts, tires, outriggers and Earth to hold the current flow to a level below that considered fault current. In this case, the system protection devices (breakers, reclosers, etc.) do not operate. Energizing the truck body is a common scenario of accidents around trucks and other installation equipment.

Consider for a moment that a truck has become energized, the outriggers and tires touching the Earth. Also assume less than fault current flows and the breakers or fuses do not operate. Anyone who walks up to the truck and touches any metal part essentially is touching the line voltage. Remember: For protection, a worker must be insulated, isolated or in parallel with a low resistance path.

Tests have indicated that the voltage across the body of a person standing immediately beside an outrigger is lowered. Because the outrigger is steel, and while there is higher resistance, it is conductive. The outrigger functions as a path of lower resistance, lowering

the voltage across the person by raising the voltage at the Earth contact point to near that of the truck body. This is not to be construed as a safe work area. The resistance of outriggers varies with construction and location (on concrete, on dry wood blocks, on asphalt or bare Earth).

However, if the person makes contact at some

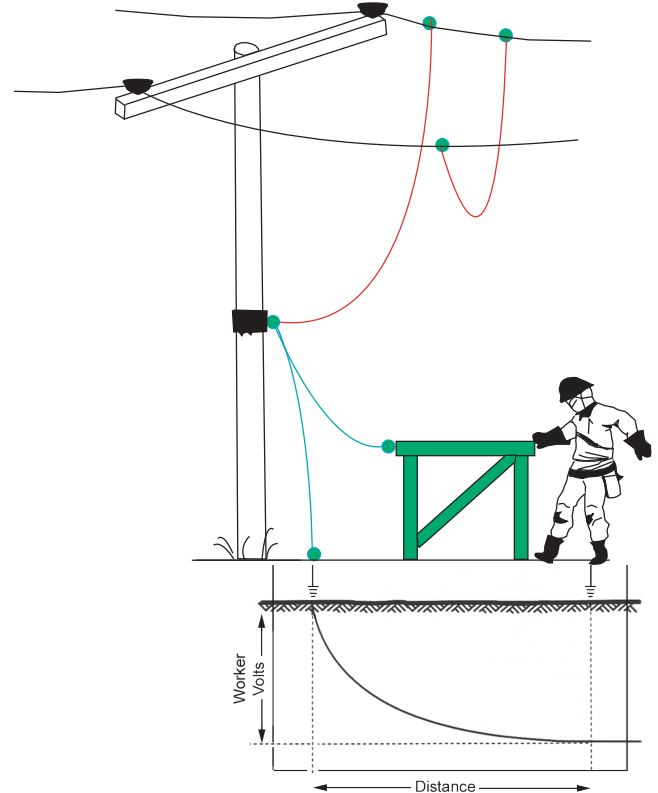

**Touch Potential**  
**Figure 11-9**

other part of the truck, the voltage across the body is increased because of the workers location. Remember that the voltage nearly halves with each 3-foot distance from the energized connection point. If contact is made near the rear of the vehicle, the potential at the Earth surface there is near zero. The full line voltage would then be developed across the person. If the outriggers are placed on dry wood blocks, there may not be a good Earth contact and any contact with the vehicle could be fatal. This is an excellent but deadly example of the “touch potential” hazard, illustrated in Figure 11-9.

Grounding the truck body does not change



anything. It only protects the system. Grounding to a driven rod helps ensure the system will recognize a fault current and the breakers or fuses will operate, but does not offer any protection to the person in contact with the truck while standing on the Earth. The truck already has multiple contact points with the Earth formed by the tires and outriggers. Each of those contacts transfers the voltage from the truck body to the Earth at that point. Adding another contact point only provides a redistribution of the available current into the available paths. Tests have verified these scenarios. See Table 11-1.

additional hazard to be aware of is flash burns from a high current arc that may occur during a fault current flow.

Maintenance on the above-ground equipment typically requires the cables coming up from below grade to be de-energized. This usually means placing both end elbows of the same cable on a grounded parking stand, a feed-thru bushing with a fault-current-rated grounding elbow, or other equivalent method as allowed by the utility work rules. This bonds the center conductors, concentric neutrals and the Earth together at those points. Similar requirements apply to work in vaults.

**Table 11-1**

Truck energized to 7.2 kV (5 tests)		
	Volts across worker	Current thru worker
Ungrounded truck, tires & outriggers only	5,397 to 5,856	5.8 to 6.3 amp.
Grounded truck, driven rod 30 ft. from truck	5,304 to 5,601	5.8 to 6.0 amp.

To ensure protection to persons around a truck, needed tools, the drinking water container, etc. should be removed from the truck before elevating the boom. Then, a system of barricades should be established so the truck cannot be touched during the work. After this, the boom can be elevated and work begun. The barricade should not be removed until the boom has been lowered again into a definite position of non-contact with a phase.

Insulation methods use rubber gloves and insulating mats at connection points, such as switches or transformers. The compactness of the enclosed equipment often makes rubber glove or hot stick work difficult, if not impossible. Because of this difficulty, workers may resist this method. Insulation is not a practical method to use for working on buried cables between connection points. Rubber gloves make cable stripping and splice assembly nearly impossible.

Portable ground mats could be placed and connected around the truck. This develops an equipotential zone for the worker. However, he must remain on the mat during the entire time the boom is elevated and until it is lowered before it is safe to step off.

Isolation is the method of keeping the worker away from any situation that would allow contact with any possible source voltage. The alternative is to totally isolate equipment from any power source. This may not be practical for maintenance of existing installed equipment because every connection must be removed and isolated. This method also is plagued with the difficulty of work problems similar to that of insulation.

## Underground

Protection for workers on underground systems is much more difficult because of the compactness of the equipment, the location of the work and the difficulty defining safe work procedures in this environment. However, the same methods of protection apply: insulation, isolation or equipotential zone. They can be more difficult to implement. In the close confines of enclosed equipment, an

The Equipotential Method is better suited for use at connection points, switches, transformers, etc. Because a worker is standing on the Earth and handling parts that may become energized, a protection zone should be established. It can be established by bonding

a conductive mat to the normally energized part to be contacted (after it is de-energized). Note: The elbow is parked on a grounded parking stand. This connection and the mat under the worker establish the zone. As long as the worker remains on the mat, the voltage developed across the body is limited to the drop across this parallel connection. This is illustrated in Figure 11-10. The size of the mat can be extended to include a second worker or tool placement by bonding additional mats to the first. The mats must remain bonded together during the work and the hand-to-foot resistance of the total path in parallel with the contacting worker must remain low.

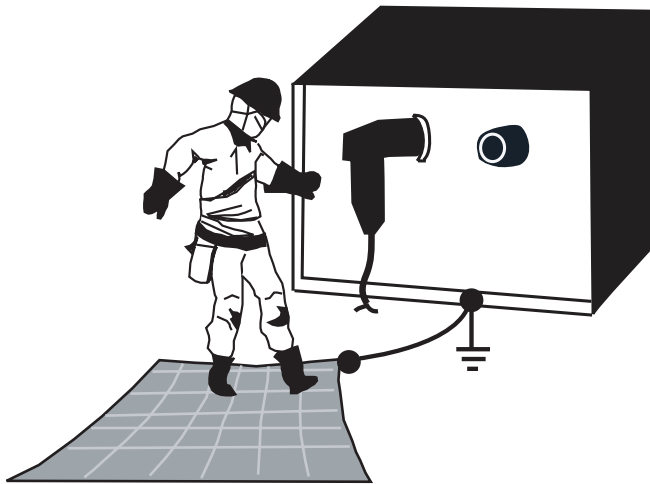

**Use of a Conductive Mat to Develop an Equipotential Zone**  
**Figure 11-10**

The Equipotential Method also is suitable for some tasks that occur between connection points, but is not suitable for others. Adding a switch or transformer between existing switches or transformers requires digging, cutting and the installation of equipment. The cables are first de-energized and then exposed by digging. If the end connections have been grounded on each end, the cable is both isolated and grounded. Line spikers are often used to verify that no voltage remains on the conductor about to be cut. A spiker is similar to a clamp but with a moveable spike mounted on the eyescrew. The spiker is placed around the cable using a Gripall Clampstick or hydraulics to maintain a safe distance and tightened to penetrate and connect the jacket,

concentric neutral and the center conductor. If the conductor is energized, an arc is established to the neutral. This is a crude but effective means of ensuring the correct line has been de-energized.

After this determination, work can begin. Extra care must be exercised during the actual cutting to ensure the cable remains de-energized as there is no protection until the conductor is exposed and bonded. Remote-operated hydraulic cutters often are used for this task. A temporary connection should be made between the concentric neutrals of the two open ends to maintain continuity as it functions as part of a system neutral. A conductive ground mat to work from can then be bonded to the concentric neutral. The two center conductors cannot be included in the bonding until they are exposed. During the stripping, a hazard will exist if the line becomes accidentally energized. When the connections are complete, see Figure 11-11A, the mat develops an equipotential zone for the worker if the cable is accidentally re-energized by a fault from either direction.

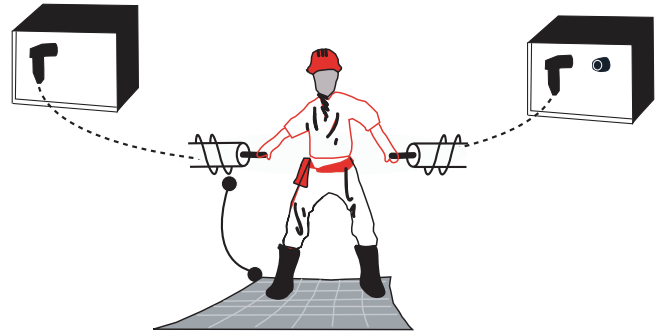

**Figure 11-11A**

NO protection is available to a worker splicing a conductor “mid-span” if it becomes accidentally energized until both URD cable ends are properly parked and protective jumpers are installed. Unfortunately, there is no convenient way to put a clamp on the conductor at the splice location without removing the conductor jacket and insulation. Figure 11-11A does not provide any protection at the worksite if the cable becomes accidentally energized from either end. If such an event occurs, the worker is in the primary current path through the grounded mat.

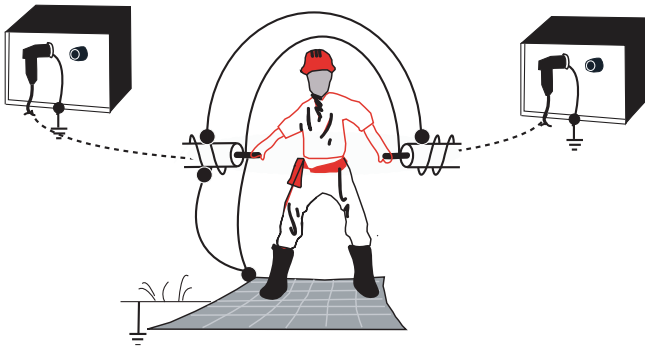

**Figure 11-11B**

Figure 11-11B demonstrates a method of developing an equipotential zone with neither the worker nor the portable ground mat as part of the primary current path. This configuration requires making a grounding connection to the primary conductor on each side of the open point, which requires the removal of the protective jacket and cable insulation in order to make the protective connections. During this initial work, rubber gloves may be required unless it has been determined that there is a complete absence of voltage on the cable and neutral. Proper care also will be required to repair each clamping location during the completion of the installation of a repair or T-splice. Rubber gloves again may be required during this closing phase. With an equipotential work zone in place at the work location, if the conductor becomes accidentally energized before the splice is in place, the voltage of the center conductors, the concentric neutral and the portable mat will all elevate to nearly the same level, offering worker protection.

If jumpers are removed to install a splice, protection will be lost. If an equipotential work zone is not fully made at the location of the splice and the previously grounded conductor becomes accidentally energized after the splice is in place, the grounded ends will experience the fault. If the worker is in contact with the conductor and Earth, there is a potential for electrical shock because he becomes a separate current path. A worker in contact with the Earth, and a bare conductor at the splice location would have a voltage

drop across his body that exceed safe levels. This is why the worker must wear rubber gloves of the appropriate class.

Communication is an important factor to ensure worker safety. The grounded connections at each end of the cable should be properly tagged and not removed until it is absolutely certain the worker is clear from any energized sections of the cable. The cable should be tested to ensure it has been properly spliced before being re-energized.

In any situation where it is not feasible to use a protective jumper to make connections across the open points and to include a temporary ground, the use of a portable ground mat is not recommended. Without the bypass jumpers in place, an equipotential zone cannot be established. The worker must use other protective means.

If the conductor becomes re-energized due to another worker replacing the previously grounded elbow on an energized bushing, and the splice is in place, the opposite grounded end will assure the system will see a fault because the grounded parking stand connects the center conductor to the neutral and earth. The earth resistance will keep the voltage at the connection point at some elevated level until the system fault protection equipment clears the fault. During this time the concentric neutral and the center conductor will have the same voltage. With temporary ground sets connecting the neutrals, and a conductive mat beneath the worker connected to the neutral, the worker is in an equipotential zone of higher resistance, see Figure 11-12.

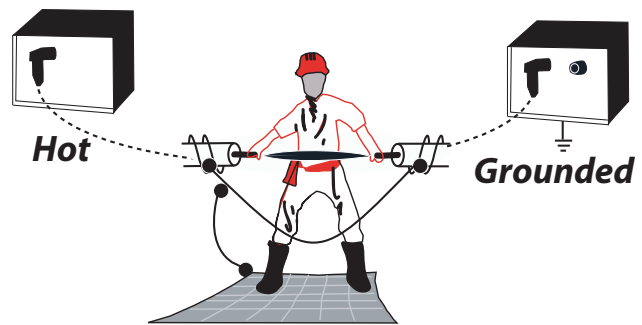

**Figure 11-12**

Without temporary grounds connecting the neutrals across the cut, the work zone safety depends upon the location of the conductive mat's connection during the time the conductor is being separated and prepared. For example, if the mat connection is to only the source side neutral, but an accident causes the line to become energized on the opposite side, there is no protection if worker contact is made. The source center conductor and neutral are both at ground potential by way of the source grounded parking stand and worker contact with the load side places the full fault voltage across the worker. But, if the accident causes the line to become externally energized somehow on the source side, an equipotential zone is present. See Figure 11-13. Rubber gloves are required in these situations until the full equipotential zone is established.

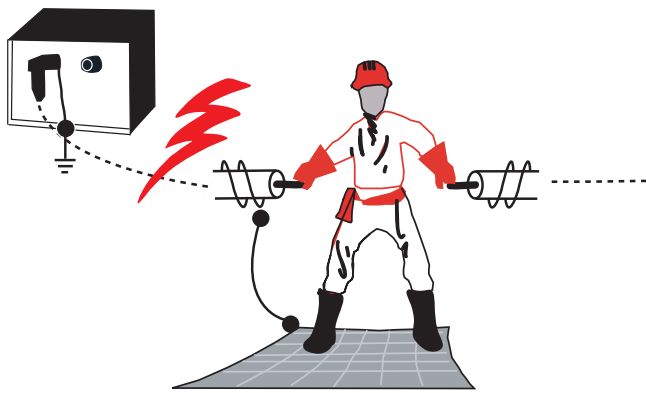

**Figure 11-13**

In all of the previous cases it is assumed that the concentric neutral for which so much depends is present and continuous to the source. This is often difficult to verify in the field as these URD cables are buried and not readily visible. Utilities should regularly review their work procedures on underground systems to identify methods that might be able to improve worker safety. Underground systems remain the most difficult situations for providing worker protection.

## Substations

Use of personal protective grounds inside substations is both easier and, at the same time, more difficult. It is easier because more suitable connections for current return points are available. It is more difficult because available fault currents are likely to be significantly greater, requiring larger and heavier ground sets and clamps. Also, because of the wide variety of installed equipment that require different considerations, equipment connection styles and placement, the underlying grid helps keep step potential at a minimum, but the potential for transfer voltage, or touch potential is increased. Each task must be considered individually and no universal rules can be developed.

Induced voltages and currents are very common in substation work because maintenance is done on one or a few items while the rest of the station remains energized. A grounding set reduces the effect of capacitively coupled voltage but multiple jumpers will allow induced current flow through the loop formed. This is the same phenomenon as that discussed for parallel transmission lines.

The substation normally supplies several circuits. This means the available fault current is greater than at a single remote worksite.

An alternative to the use of increasingly large size jumper equipment is to use multiple sets placed in parallel. Refer to Section 7 (Theory of Personal Protective Grounding) for a discussion of paralleling personal protective jumper equipment. Another means of grounding very large fault currents is the use of grounding switches. These devices are permanently mounted and are left open until the need to maintain a ground connection during main-



tenance arises. They provide a convenient method for grounding a de-energized bus or attached line but they may form an induced current loop. They are widely used in large substations.

Because of the size, length and weight of the protective equipment, assistance with the installation is sometimes required. A tool that is very helpful in lifting a large bus clamp with one or two AWG 4/0 cables attached is the Chance Lift Hook Assembly (Shepherd's Hook). This is a long, insulated handle with a large hook on one end. Near the hook is a rope pulley. The hook is placed over the bus and the rope is connected to the clamp to be landed on the bus. A second worker guides and tightens the clamp using an equally long Gripall Clamp Stick (commonly called a "shotgun" stick). The rope must be clean and dry to be considered insulating.

Other specialty items available for use in substation personal protective jumpering are various lugs, stirrups and studs. These devices are all designed to provide permanent connection points for the protective equipment necessary for working safely. Figure 11-14 illustrates some of these devices.

Special attention must be given when working on equipment installed in substations. For example, transformers have the capability to step low voltages up to lethal levels. Even test equipment connected to the low voltage windings can raise the output to a high voltage. Capacitor banks must be discharged before handling. The terminals must remain shorted to prevent charge from migrating from the dielectric material to the terminals and re-establishing a hazard. Large power cables and their terminations can retain a charge. They should be grounded and remain grounded before handling or cutting.

Personal protective jumpering methods in substations are similar to the methods used at remote worksites. The underlying principle of maintaining a low-resistance path closely in parallel with the worker remains the same. One difference is that a grounding jumper some distance away from the actual worksite can be added to the protection in a substation that has a buried grid. While the multiple connections aid in increasing the overall current carrying capability, it poses other problems. The greater the separation, the larger the loop formed by the jumpers, the worker and the grid. As this loop increases, the voltage across the worker will increase. A hazard if applying or removing the personal jumper by hand.

Remember that at remote towers when jumpers were placed on adjacent structures and there was no connection to the base at the worksite between them, the full voltage was developed across the worker because the Earth potential remained near zero at that point. If a fault in a substation occurs, the entire grid rises to the line voltage and limits both the voltage that can be developed across the worker and the step potential.

The same principles for placement, sizing and paralleling of jumpers apply as at other worksites.



**Specialty Connection Devices**  
**Figure 11-14**



The presence of transformers presents a large inductance on circuits in the substation. This combination presents the special problem of asymmetrical current. A discussion of asymmetrical current and the associated problems is presented below and in Appendix B. The mechanical force associated with an asymmetrical current peak could be significantly greater because the magnetic force increases as the square of the current. That is, twice the current produces four times the force. Additional heating of the conductor from the offset current coupled with the increased force may cause the assemblies to prematurely separate. Table B-1<sup>[6]</sup> (in Appendix B) is used to size equipment for applications where asymmetrical currents are cause of concern.

The issue of asymmetrical current must be considered when selecting personal protective grounding equipment for use in substations. This is a current that begins upon the sudden re-energization of a line previously de-energized for maintenance work. The current at the beginning of flow becomes significantly offset from the zero axis as compared to that of a normal symmetrical current. The cause is the large amount of inductance present from reactors and transformers normally present in substations compared to the small amount of resistance in the buses. The greater the ratio of inductance to resistance, the more pronounced will be the initial offset. The peak current of the first loop may be nearly 2.7 times the normal RMS current value at

an X/R ratio of 30:1. Such an offset waveform is shown in Figure 11-15. Depending upon the X/R ratio, the offset portion decays to a normal symmetrical current some cycles after current initiation.

The mechanical force associated with current flow varies as the square of the current. The resulting mechanical force may be nearly four times the normal level at the 90% asymmetry ratio shown above. Aluminum welded bus grounding connection points may break off from the bus under these forces or the clamps themselves may break, removing any protection provided by the grounds. Additional heating also occurs due to the offset current, further softening the copper and allowing a mechanical failure that occurs prior to rated cable melting. Special equipment should be provided that can withstand these forces yet carry the current.

These conditions have been known for many years, but often did not present a problem. The equipment used performed satisfactorily because the current levels were smaller and the forces were less. It has become more important with the increased demand for electricity and the increased size of substations needed to supply this increased demand in many areas. It is recommended that utilities work with their equipment supplier to ensure the selected grounding items are fully rated for these conditions.

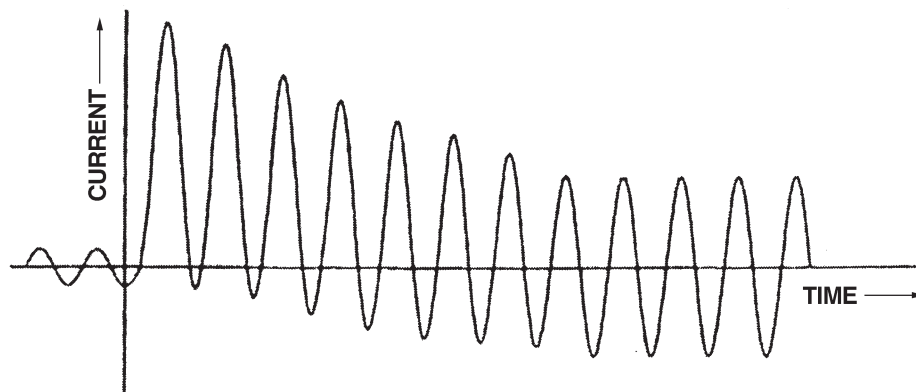
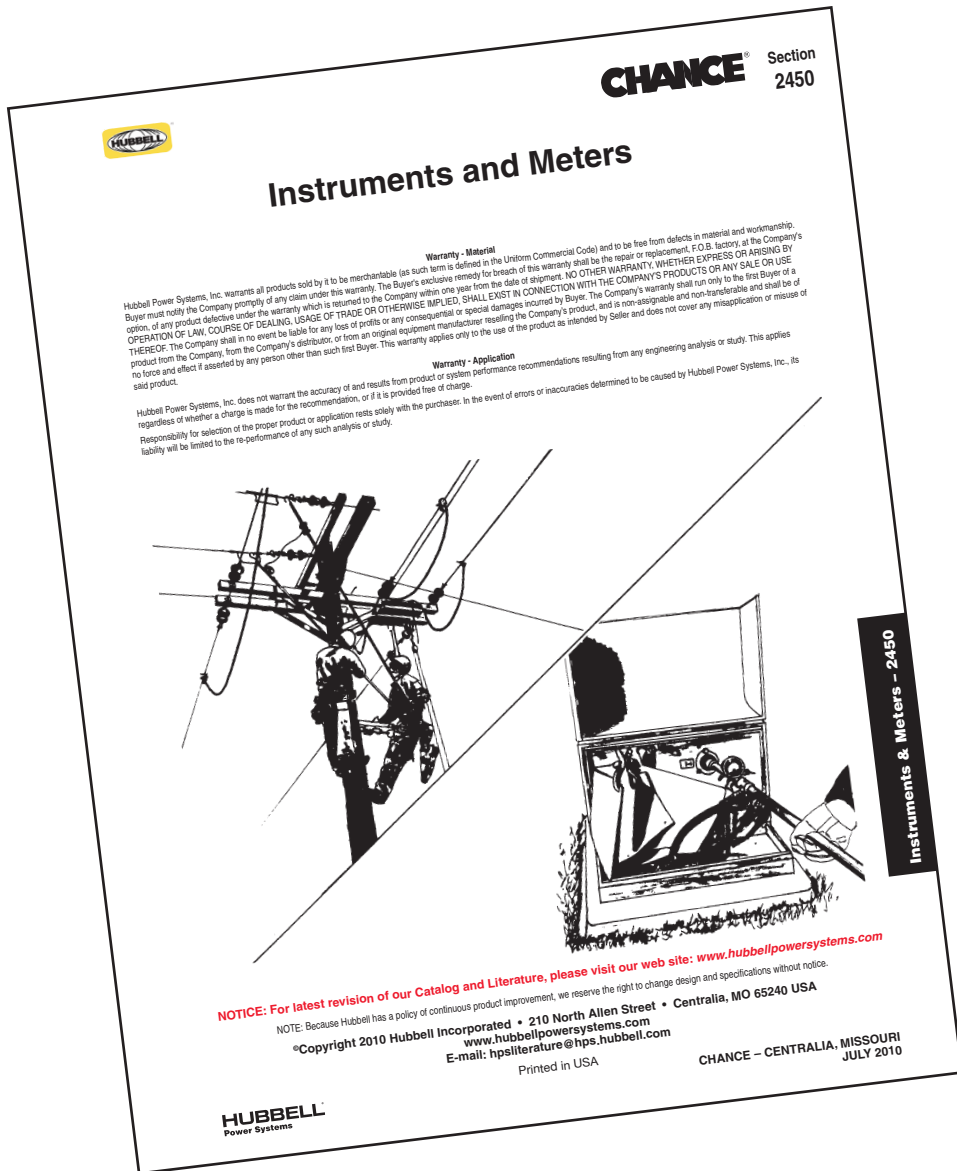

Figure 11-15



# Relevant Instruments and Meters Catalog Pages

## Section 12

**CHANCE**<sup>®</sup>

www.hubbellpowersystems.com  
E-mail: hpsliterature@hps.hubbell.com



Phone: 573-682-5521

Fax: 573-682-8714

210 North Allen

Centralia, MO 65240, USA

©Copyright 2018 Hubbell Incorporated



# Phasing Testers

• for †Distribution Circuits

## Features & Applications

- Determine phase relationships and approximate voltage, line-to-line or line-to-ground
- Feature two fiberglass poles with end fittings threaded for interchangeable probes
- Probe fittings couple with a high-impedance component encased in each pole
- To complete test circuit, a 22 ft. length of insulated flexible cable stores on reel affixed to one pole and connects to voltmeter on other pole
- Simple to operate, tester poles first attach to two 6 ft. Epoxiglas<sup>®</sup> insulating universal handles (included in each kit for proper working clearances)
- Probes can be brought into contact with conductors appropriate for the meter to read phase-to-phase or phase-to-ground voltage

## Single-Range Units

- For convenience on different systems, toggle on dual-range units can switch calibration between two scales on meter face
- Can improve readability for low-end values on Hi scale
- Switched to Lo range, those values deflect needle more to give more finite readings
- To check instrument before and after each use, test-point jack in front of meter accepts plug from Phasing Meter Tester, next page

## Distribution Phasing Testers

### Single-Range Units

Catalog No.	Description	Weight
H1876	†16 kV Tester Kit*	27½ lb./12.4 kg.
H18761	†16 kV Tester Hook Probes, Case and Manual	23 lb./10.4 kg.
T4032261	25 kV Tester Kit*	27½ lb./12.4 kg.
H18767	40 kV Tester, Hook Probes, Case and Manual	23 lb./10.4 kg.

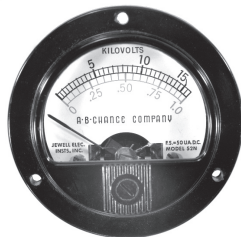

**Dual-Range Meters**  
1 & 16 kV Unit

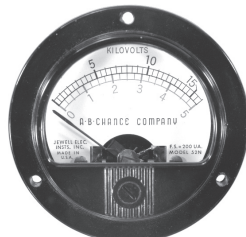

5 & 16 kV Unit

### Dual-Range Units

T4030786	1 & †16 kV Tester Kit*	27½ lb./12.4 kg.
T4032311	5 & †16 kV Tester Kit*	27½ lb./12.4 kg.
T4032398	5 & †16 kV Tester Only	23 lb./10.4 kg.

\*Each kit includes two 6' x 1-1/4" -dia. Epoxiglas<sup>®</sup> universal handles with storage bag, tester, hook probes, case and instruction manual

†To extend any Chance 16 kV Phasing Tester for 48 or 80 kV applications, optional Extension Resistors simply thread on in the field



For URD testing, see Hi-Pot Adapters (page 2458) and Adapters for Elbows and Bushings (page 2467).

### Extension Resistors, as installed



H18765

### Extension Resistors

H18762	Pair of Extension Resistors for up to 80 kV (32" long)	6 lb./2.7 kg.
H18764	Pair of Extension Resistors for up to 48 kV (21" long)	4 lb./1.8 kg.
P6242	Bag for 48 kV Resistors	1 lb./0.45 kg.
P6244	Bag for 80 kV Resistors	1¼ lb./0.56 kg.

### Accessories

H17601	Universal Pole 1¼" x 6' — Two Needed	1¾ lb./0.7 kg.
P6436	Bag for Two Poles	1 lb./0.45 kg.
H18763	Case only for Tester	2 lb./0.9 kg.
H18766P	Pigtail Hook Probe	¼ lb./0.1 kg.
H18766S	Shepherd Hook Probe	¼ lb./0.1 kg.
H18766	Straight Probe	⅛ lb./0.05 kg.
H18765	Angle Probe	⅛ lb./0.05 kg.

Instruments & Meters - 2450

# Distribution Phasing Tester Kit for Overhead and Underground Systems

## Dual Range: 5kV & 16kV Scales

### Features & Applications

- Versatile for popular distribution voltages
- Facilitates testing both underground and overhead systems
- Basic functions include identifying phases and reading line-to-line or line-to-ground voltage
- URD accessories in the Kit also permit cable-fault detection
- Consists of high-impedance components encased in two fiberglass poles with threaded end fittings for overhead probes or URD adapters
- A 22 ft.-long cable connects to voltmeter pole and stores on reel pole



- To detect faults on URD cable, Hi-Pot Adapter converts AC source to DC pulse
- Effective field method quickly tests new, repaired or suspect spans



- To check instrument before and after use, Phasing Meter Tester lead plugs into test-point jack by meter
- Other lead clips onto each probe
- Switch on Meter Tester reverses polarity for thorough field-checking procedure
- Complete instructions included

### Ordering Information

Catalog No.	Description	Weight
T4032557	Phasing Tester Kit with 16kV Hi-Pot Adapter, 2 URD Bushing Adapters, Phasing Meter Tester	31½ lb./14.2 kg.



**Complete Kit includes:**  
 Two 6' x 1-1/4"-dia. Epoxiglas® universal handles with storage bag, tester with instruction manual and two probes (shepherd hook and pigtail hook) in padded carrying case, plus four items below

#### URD Accessories in Kit



One DC Hi-Pot Adapter & Instructions

C4031762

Two Bushing Adapters



T4030857



Phasing Meter Tester (with battery) in Kit

C4030838

H17601 Hotstick P6436 Bag

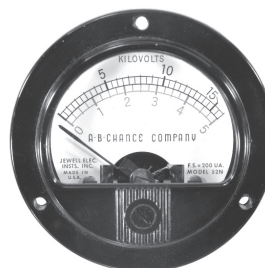

- For convenience on different systems, toggle on meter housing can switch calibration between the two scales on meter face
- Improves readability for low-end values on the Hi (16 kV) scale
- Switched to Lo (5 kV) range, values deflect needle more to give more finite readings



# Digital Phasing Testers



- 16kV and 40kV models, plus 80kV extensions
- For Overhead & Underground

## Display With Backlight, Hold and Sleep Modes

- Large direct-reading display
- Determine phase relationships and approximate voltage, line-to-line or line-to-ground
- Each tester consists of two fiberglass poles with end fittings threaded for interchangeable probes
- Probe fittings couple with high-impedance component encased in each pole
- To complete the test circuit, a 22 ft. length of insulated flexible cable stores on the reel affixed to one pole and connects to electronic display module on other pole
- Simple to operate, tester attaches to two 6 ft. Epoxiglas® insulating universal handles (included in each kit for proper working clearances)
- Probes can be brought into contact with conductors for tester to display phase-to-phase or phase-to-ground voltage
- Pushbutton controls permit easy selection of options for display Backlight and Hold features
- When not in use, the unit's Sleep mode automatically conserves the battery



Large direct display with backlight and hold features

## Hi-Pot & Higher Voltage Test Accessories

- For underground cable hi-pot testing
- 16 kV Kit C4033402 includes a DC Hi-Pot Adapter
- Hi-pot testing cannot be done with the 40 kV unit
- Both the 16 kV and 40 kV Kits include underground bushing and elbow adapters

- For overhead subtransmission systems, Extension Resistors are available as accessories specific to each Digital Phasing Tester





**Basic Units:** 

Each Basic Unit Digital Phasing Tester includes the tester unit with meter and reel poles, a pigtail hook probe, a shepherd hook probe, instruction manual and hard shell padded case.

See next page for Tester Kits.

---

**16kV Digital Phasing Tester Basic Unit**  
Cat. No. C4033369 (14 lb./6.36 kg.)

---

**40kV Digital Phasing Tester Basic Unit**  
Cat. No. C4033370 (14½ lb./6.6 kg.)  
Hi-pot testing cannot be done with the 40kV unit.



Available as accessories, Extension Resistors simply thread onto the Digital Phasing Tester in the field.



# Digital Phasing Testers

• For Overhead & Underground



**Easy Verification Test**

- To check instrument before and after use, Phasing Meter Tester lead plugs into test-point jack by meter
- Other lead clips onto each probe. Switch on Meter Tester
- Tester reverses polarity for thorough, easy field-checking procedure
- Complete instructions are included with each unit

**16kV Digital Phasing Tester Kit**  
Cat. No. C4033402 (22½ lb./10.2 kg.)



**C403-3369 Digital Phasing Tester**

**C4031762 DC Hi-Pot Adapter**

**T4030856 Elbow Adapter**

**Two T4030857 Bushing Adapters**

**Two H17601 6-ft. x 1¼"-dia. Epoxiglas® universal poles in P643-6 Bag**

**C4030838 Phasing Meter Tester**

**40kV Digital Phasing Tester Kit**  
Cat. No. C4033403 (21½ lb./9.7 kg.)  
Hi-pot testing cannot be done with the 40kV unit.



**C4033370 Digital Phasing Tester**

**T4030856 Elbow Adapter**

**Two T4030857 Bushing Adapters**

**Two H17601 6-ft. x 1¼"-dia. Epoxiglas® universal poles in P6436 Bag**

**C4030838 Phasing Meter Tester**

Extension Resistors for 16kV Digital Phasing Tester		
H18762	Pair of Extension Resistors for up to 80 kV (32" long)	6 lb./2.7 kg.
H18764	Pair of Extension Resistors for up to 48 kV (21" long)	4 lb./1.8 kg.
P6242	Bag for 48 kV Resistors	1 lb./0.45 kg.
P6244	Bag for H1876-2 80 kV Resistors	1¼ lb./0.56 kg.

Extension Resistors for 40kV Digital Phasing Tester		
C4033371	Pair of Extension Resistors for up to 80 kV (21" long)	4 lb./1.8 kg.
P6242	Bag for C403-3371 80 kV Resistors	1 lb./0.45 kg.

**NOTICE:** Use ONLY the Extension Resistors specified for each Digital Phasing Tester as listed on this page. Extension Resistors are NOT interchangeable between 16kV and 40kV Digital Phasing Testers.

**Accessories**

H18766S	Shepherd Hook Probe	¼ lb./0.1 kg.
H18766	Straight Probe	⅛ lb./0.05 kg.

# Digital Phasing Testers for Transmission Circuits

• Two models for up to 120 kV or 240 kV

## Features & Applications

- Easily determine phase relationships
- Read approximate voltage (line-to-line or line-to-ground) on transmission circuits
- Feature two high-impedance components encapsulated in fiberglass poles, each with an end fitting threaded for interchangeable hook probes
- 22-ft.-long insulated flexible cable from voltmeter stores on reel on other pole
- Two complete kits offer a choice of voltage ranges for specific system applications
- Each kit includes a pair of 1-1/2"-dia. insulated handles for proper working clearances
- Individual items listed in each kit's bill of materials may be ordered separately by reference numbers given



Large direct display with backlight and hold features

## Ordering Information

Catalog No.	Description	Weight
PSC4033465	<b>10 - 120 kV Phasing Tester Kit:</b>	<b>39 lb./17.7 kg.</b>
	(1) Instruction Manual	
	(1) PSE4033454 Phasing Tester (64" long)	22½ lb.
	(2) C4030459 Handles (96")	10 lb.
	(1) P6218 Bag for Handles (108")	3½ lb.
PSC4033466	<b>40 - 240 kV Phasing Tester Kit:</b>	<b>60 lb./27.2 kg.</b>
	(1) Instruction Manual	
	(1) PSE4033455 Phasing Tester (102" long)	43½ lb.
	(2) C4030459 Handles (96")	10 lb.
	(1) P6218 Bag for Handles (108")	3½ lb.
(1) C4030464 Bag for Tester	3 lb.	



10 - 120 kV Digital Phasing Tester

40 - 240 kV Digital Phasing Tester

**C4030459**  
96" Epoxiglas<sup>®</sup> Handles

Catalog No.	Description	Weight
PSE4033473	Phasing Meter Tester with leads and battery	1 lb./0.45 kg.

## Phasing Meter Tester

for Digital Transmission Phasing Testers above

**PSE4033473**

**Phasing Meter Tester for Digital Transmission Phasing Testers**



## Features & Applications

- Allows line personnel to determine, in the field, the operating condition of Chance instruments above
- Uses each instrument's own meter to display its operating condition
- Tester plugs into jack on instrument
- Meter readings are noted when tester's clip is contacted to each of instrument's two terminals and tester's polarity switch is in both of its positions
- Instrument is in proper working order if all four readings are within two units
- Pulling plug from jack automatically disconnects tester's battery
- 9-volt battery, furnished, usually lasts one year and is easily replaced
- Tester's durable and compact fiberglass housing will withstand abuse of field applications

# Analog Phasing Testers

## Three kits for Transmission Circuits

### Features & Applications

- Determine phase relationships
- Read approximate voltage (line-to-line or line-to-ground) on transmission circuits
- Features high-impedance components encapsulated in fiberglass poles, each with an end fitting threaded for interchangeable hook probes
- 22' long insulated flexible cable from voltmeter stores on reel on other pole
- Three complete kits offer a choice of voltage ranges for specific system applications. Each kit includes a pair of 1-1/4"-dia. insulated handles for proper working clearances
- Individual items listed in each kit's bill of materials may be ordered separately by reference numbers given

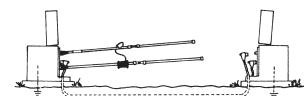

### Ordering Information

Catalog No.	Description	Weight
C4030457	69-120 kV Phasing Tester Kit: (1) Instruction Manual (1) E4030498 Tester (62" long) (2) C4030459 Handles (96") (1) P6218 Bag for Handles (108") (1) C4030460 Bag for Tester	39 lb./17.7 kg.  22½ lb. 10 lb. 3½ lb. 3 lb.
C4030458	69-161 kV Phasing Tester Kit: (1) Instruction Manual (1) E4030499 Tester (75" long) (2) C4030459 Handles (96") (1) P6218 Bag for Handles (108") (1) C4030464 Bag for Tester	44 lb./20 kg.  27½ lb. 10 lb. 3½ lb. 3 lb.
T4032781	69-240 kV Phasing Tester Kit: (1) Instruction Manual (1) E4032780 Tester (98" long) (2) C4030459 Handles (96") (1) P6218 Bag for Handles (108") (1) C4030464 Bag for Tester	60 lb./27.2 kg.  43½ lb. 10 lb. 3½ lb. 3 lb.



**C4030459**  
96" Epoxiglas®  
Handles

Analog  
Transmission  
Phasing Tester

## Phasing Meter Tester

for Phasing Testers\* (page 2452-2455),  
Phase Rotation Testers (page 2459),  
and Energized Insulator Testers (page 2466).

### Features & Applications

- Allows line personnel to determine, in the field, the operating condition of Chance instruments above
- Uses each instrument's own meter to display its operating condition
- Tester plugs into jack on instrument
- Meter readings are noted when tester's clip is contacted to each of instrument's two terminals and tester's polarity switch is in both of its positions
- Instrument is in proper working order if all four readings are within two units
- Pulling plug from jack automatically disconnects tester's battery
- 9-volt battery, furnished, usually lasts one year and is easily replaced
- Tester's durable and compact fiberglass housing will withstand abuse of field applications

Catalog No.	Description	Weight
C4030838	Tool with leads and battery	1 lb./0.45 kg.

\*Phasing Voltmeter Tester is designed for checking distribution-series voltmeters with extensions for 80 kV and below.



**C4030838**



# Digital Phasing Testers

## Two Kits for Transmission Circuits Features & Applications

- With digital readout and hold function
- Otherwise perform same functions as analog testers on page 2457

Catalog No.	Description	Weight
PSC4033465	<b>10 - 120 kV Phasing Tester Kit:</b>	<b>40 lb./18.2 kg.</b>
	(1) Instruction Manual	
	(1) PSE4033454 Phasing Tester (64" long)	22½ lb.
	(2) C4030459 Handles (96")	10 lb.
	(1) P6218 Bag for Handles (108")	3½ lb.
	(1) C4030460 Bag for Tester	3 lb.
PSC4033466	<b>40 - 240 kV Phasing Tester Kit:</b>	<b>61 lb./27.7 kg.</b>
	(1) Instruction Manual	
	(1) PSE4033455 Phasing Tester (102" long)	43½ lb.
	(2) C4030459 Handles (96")	10 lb.
	(1) P6218 Bag for Handles (108")	3½ lb.
	(1) C4030464 Bag for Tester	3 lb.
(1) PSE40333473 Meter Tester	1 lb.	



Large direct display with backlight and hold features



10 - 120 kV Digital Transmission Phasing Tester



40 - 240 kV Digital Transmission Phasing Tester

## Phasing Meter Tester

for Digital Transmission Phasing Testers above

- Exclusively for use with only Digital Phasing Testers above
- Otherwise the functional equivalent of Phasing Meter Tester on page 2457

**PSE4033473**  
Phasing Meter Tester  
for Digital Transmission  
Phasing Testers



## D.C. Hi-Pot URD Test Adapters

### Features & Applications

- Work with Chance Phasing Tool H1876 (page 2452) for metered readout
- For quick, reliable fault detection on underground cables
- Two units are available for phase-to-phase system voltages up to 16 kV or 35 kV
- By converting AC source voltage to a rectified half-wave, these adapters permit testing of cables with a potential level equal to peak source voltage
- Field-effective method proves especially beneficial for:
  - o Testing new cable before initial energizing
  - o Testing repaired cable before re-energizing
  - o Testing suspect cable spans for faults
- Brass male fitting inside larger end threads onto the meter probe of phasing tool

- For testing and subsequent discharging, brass female fitting at smaller end accepts Chance Elbow Adapters or Bushing Adapters for 15 through 35 kV (page 2455)
- Illustrated instruction booklet is included
- Units contain high-voltage rectifiers encapsulated in Chance orange 1-1/4" and 1-1/2" dia. Epoxiglas<sup>®</sup> housings

Hi-Pot Adapters measure only 13" in length for 35 kV unit, and 10" for 16 kV unit, far right.



Catalog No.	Description	Weight, each
C4031762	*16 kV Hi-Pot Adapter	1 lb./0.45 kg.
C4031763	*35 kV Hi-Pot Adapter	1¼ lb./0.57 kg.

\*Maximum phase-to-phase system voltage.

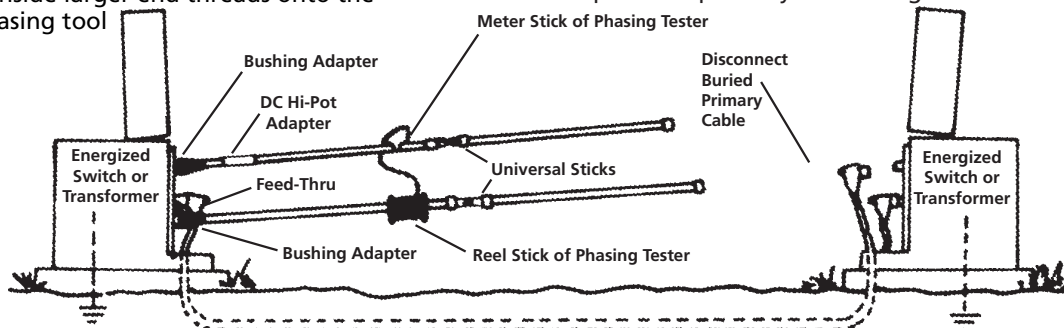

# Phase Rotation Tester

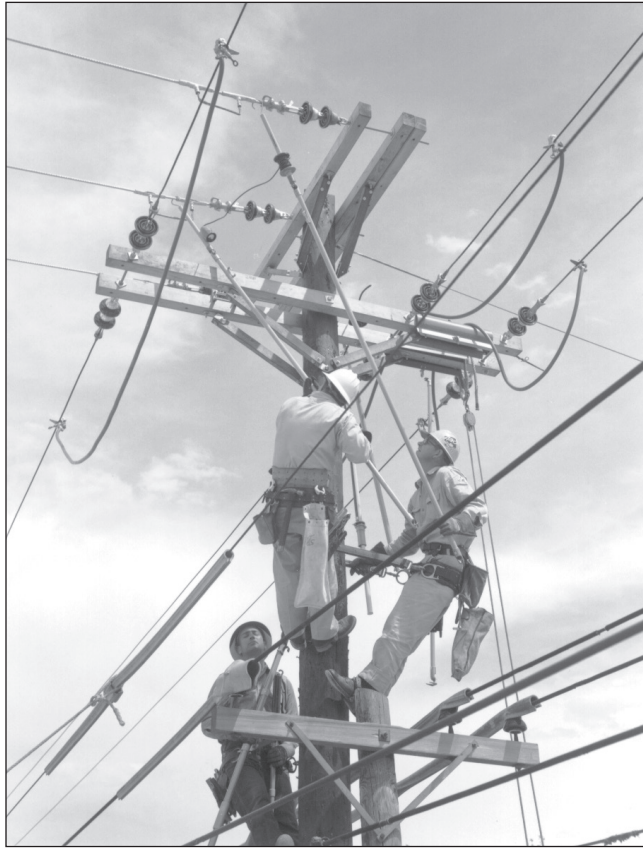

## Features & Applications

- To determine the correct phase-rotation relationship, this portable instrument features construction similar to Phasing Tester H18761, page 2452
- An additional grounding circuit on the Phase Rotation Tester sets it apart for phase rotation testing
- Tester consists of two fiberglass poles with end fittings threaded for interchangeable probes
- Probe fittings couple with a high-impedance component encased in each pole
- 22 ft. length of insulated cable stores on reel affixed to one pole and connects to voltmeter on other pole
- Grounding terminal below the meter permits connection to a known ground for proper operation
- To check instrument before and after each use, a test-point jack in front of meter accepts the plug from Phasing Meter Tester C4030838, shown on page 2457



## Application Range

- Attaches to Epoxiglas® Universal Poles of proper length for voltage being worked
- Meter displays up to 16 kV alone
- Can also read circuits through 80 kV with the thread-on Extension Resistors



Catalog No.	Description	Weight
H1879	Phase Rotation Tester, 16 kV, with Case	23 lb./10.4 kg.
H18762	Pair of Extension Resistors for through 80 kV, Length: 43"	6 lb./2.7 kg.
H18764	Pair of Extension Resistors for through 48 kV, Length: 25"	4 lb./1.8 kg.
H17601	Universal Pole, 1¼" x 6', Two Needed	1¾ lb./0.7 kg.
P6436	Bag for Two Universal Poles	1 lb./0.45 kg.
P6242	Bag for 48 kV Extension Resistors	1 lb./0.45 kg.
P6244	Bag for 80 kV Extension Resistors	1¼ lb./0.56 kg.
H18763	Carrying Case Only for Tester	2 lb./0.9 kg.



# Full Range (600V – 500kV) Auto-Ranging Voltage Indicator (ARVI)

*Complies with OSHA 1910.269 to Test for Absence of Nominal Voltage*  
 • 600V to 500kV • For Overhead and URD Systems

### Bright display lights indicate voltage class

This smart new-generation instrument makes hot-line voltage testing easier than ever. Its state-of-the-art electronics eliminate the need for a selector switch. Its automatic-ranging function quickly displays the approximate phase-to-phase voltage class. It provides an easy, reliable means for the operator to determine if a line is:

- a) De-energized, or
- b) Carrying less than normal system voltage from any source or induced charged from an adjacent live circuit, or
- c) Energized at full system voltage.

Simple to operate, the tester attaches to an Epoxiglas<sup>®</sup> insulating universal hot stick of appropriate length to maintain proper OSHA working clearances. A single pushbutton activates the instrument, then a single light indicates either Power On (by glowing solid) or Low Battery (by blinking). With a good battery condition, the instrument performs a confirming self-test by illuminating each of the 12 indicator lights in series while emitting an alternating audible signal.

Then the probe can be brought into contact with the conductor. It automatically begins detecting at approximately 100V and holds the display of one of these phase-to-phase voltage classes: 600V, 4kV, 15kV, 25kV, 35kV, 69kV, 115kV, 161kV, 230kV, 345kV or 500kV. The audible signal begins as a slow beeping that becomes faster as the reading is increased.

When not in use, the unit's energy-saving Sleep mode automatically conserves the battery.

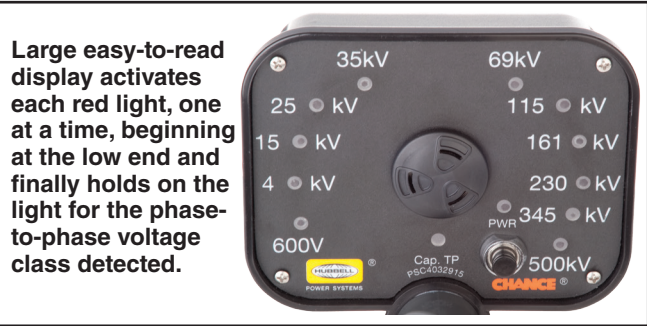

This model adapts to both overhead lines as well as URD circuits with 200 and 600 Amp elbows, including those with and without capacitance test-points. Interchangeable probes and adapters just thread into the ARVI end fitting and test point (T.P.) setting appropriate to each application. Furnished owner's manual illustrates operating details for all models.

... continued on next page ...



## Distribution / Transmission ARVI (Auto-Ranging Voltage Indicator) Cat. No. PSC4032915 (4½ lb./2.0 kg.)

Includes the tester unit, a shepherd hook probe, a straight probe, instruction manual and hard shell padded case.

**Voltage Indicator Tester PSC4033582**  
**MUST BE ORDERED AS A SEPARATE ITEM**  
 Plug-in jack on Full-Range ARVI housing permits line personnel to quickly verify its operable condition with Voltage Indicator Tester (Cat. No. PSC4033582) before and after each use.

Accessories		
H18766S	Shepherd Hook Probe	0.25 lb./0.1 kg.
H18766	Straight Probe	0.13 lb./0.05 kg.
T4030428	15kV only Bushing Adapter	0.5 lb./0.2 kg.
T4030856	15 - 35kV Elbow Adapter	1 lb./0.4 kg.
T4030857	15 - 35kV Bushing Adapter	1.6 lb./0.7 kg.

Instruments & Meters - 2450

# Full Range (600V – 500kV) Auto-Ranging Voltage Indicator (ARVI)

This model is capable of these three test methods:

**URD Voltage Presence Test**  
with Bushing Adapter and your feed-thru device

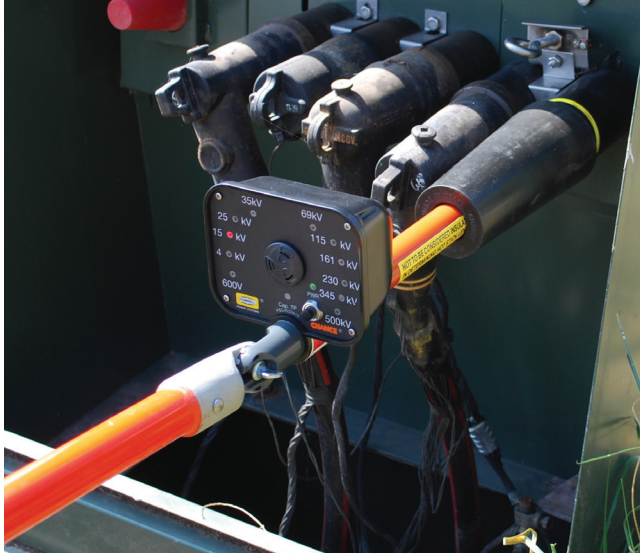

**URD Capacitance Test**  
with Straight Probe on Elbows with Test Points



**Overhead Voltage Presence Test**  
with Shepherd Hook Probe





# Distribution

## Auto-Ranging Voltage Indicator (ARVI)

*Complies with OSHA 1910.269 to Test for Absence of Nominal Voltage*

- 600V to 69kV
- For Overhead & Underground

### Bright Display Lights Indicate Voltage Class

- Makes hot-line voltage testing easier than ever
- State-of-the-art electronics eliminate need for selector switch
- Automatic-ranging function quickly displays approximate line-to-line voltage class
- Provides easy, yet reliable means for operator to determine if a line is:
  - o De-energized, or
  - o Carrying less than normal system voltage from any source or induced charged from an adjacent live circuit, or
  - o Energized at full system voltage
- Simple-to-operate tester attaches to an Epoxiglas<sup>®</sup> insulating universal handle of appropriate length to maintain proper OSHA working clearances
- Single pushbutton activates the instrument, then a single light indicates either Power On (by glowing solid) or Low Battery (by blinking)
- With good battery condition, instrument performs a confirming self-test
- It does this by illuminating each of the six indicator lights in series while emitting an alternating audible signal
- Then the probe can be brought into contact with the conductor
- It automatically begins detecting at approximately 480 Volts and holds display of one of these voltage classes: 600 V, 4 kV, 15 kV, 25 kV, 35 kV or 69 kV phase-to-phase
- Audible signal begins as a slow beeping, becoming faster as final reading is displayed
- When not in use, unit's energy-saving Sleep mode automatically conserves battery

### Overhead & Underground Capabilities

- For overhead testing, a Shepherd Hook probe is included with the Basic ARVI (Auto-Ranging Voltage Indicator)
- For underground testing, Elbow Adapter T4030856 and

Large easy-to-read display activates each red light, one at a time, beginning at the low end and finally holds on the light for the phase-to-phase voltage class detected.



- Bushing Adapter T4030857 are included
- They simply thread onto the ARVI in the field to check for voltage at switch bushings or elbows on cables, using a feed-thru device

**ARVI Auto-Ranging Voltage Indicator**

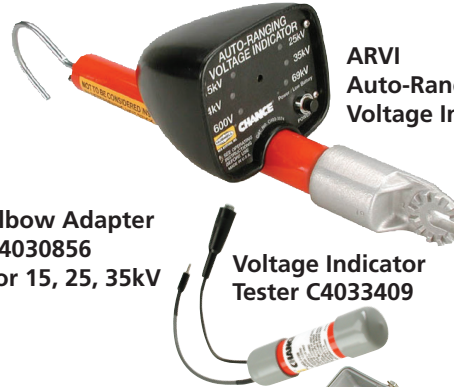

**Elbow Adapter T4030856 for 15, 25, 35kV**

**Voltage Indicator Tester C4033409**

**Bushing Adapter T4030857 for 15, 25, 35kV**



**ARVI Auto-Ranging Voltage Indicator**

**Basic ARVI for Overhead Applications**  
 Catalog No. C4033374 (5½ lb./2.5 kg.)

Includes the tester unit, a shepherd hook probe, instruction manual and hard shell padded case.



**ARVI Kit**

for Overhead and Underground

Catalog No. T4033418 (16¼ lb./7.37 kg.)

Includes the tester unit, shepherd hook probe, elbow adapter, bushing adapter, voltage indicator tester, instruction manual and hard shell padded case.

### Accessories

H187665	Shepherd Hook Probe	¼ lb./0.1 kg.
H187666	Straight Probe	⅛ lb./0.05 kg.

Instruments & Meters - 2450

# Transmission Auto-Ranging Voltage Indicator (ARVI)

**Complies with OSHA 1910.269 to Test for Absence of Nominal Voltage**  
**• 69kV to 500kV • For Overhead Conductors**

## Bright Display Lights Indicate Voltage Class

- Makes hot-line voltage testing easier than ever
- State-of-the-art electronics eliminate need for selector switch
- Automatic-ranging function quickly displays approximate line-to-line voltage class
- Provides easy, yet reliable means for operator to determine if a line is:
  - o De-energized, or
  - o Carrying less than normal system voltage from any source or induced charged from an adjacent live circuit, or
  - o Energized at full system voltage
- Simple-to-operate tester attaches to an Epoxiglas® insulating universal handle of appropriate length to maintain proper OSHA working clearances
- Single pushbutton activates the instrument, then a single light indicates either Power On (by glowing solid) or Low Battery (by blinking)
- With good battery condition, instrument performs a confirming self-test
- It does this by illuminating each of the six indicator lights in series while emitting an alternating audible signal
- Then the probe can be brought into contact with the conductor
- It automatically begins detecting at approximately 69 kV and holds display of one of voltage classes: 69 kV, 115 kV, 161 kV, 230 kV, 345 kV or 500 kV phase-to-phase

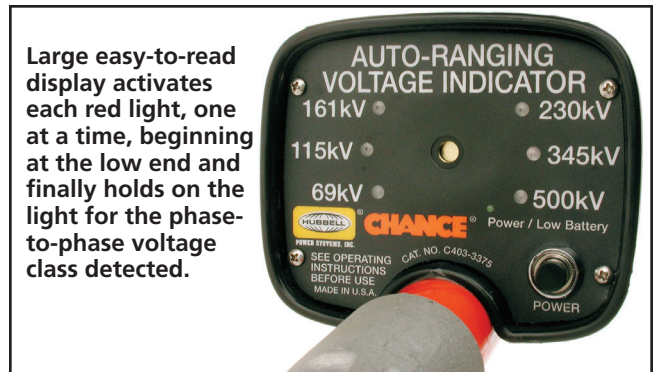

Large easy-to-read display activates each red light, one at a time, beginning at the low end and finally holds on the light for the phase-to-phase voltage class detected.

- Audible signal begins as a slow beeping, becoming faster as final reading is displayed
- When not in use, unit's energy-saving Sleep mode automatically conserves battery



## Transmission ARVI (Auto-Ranging Voltage Indicator) Cat. No. C4033375 (5½ lb./2.5 kg.)

Includes the tester unit, a shepherd hook probe, instruction manual and hard shell padded case.

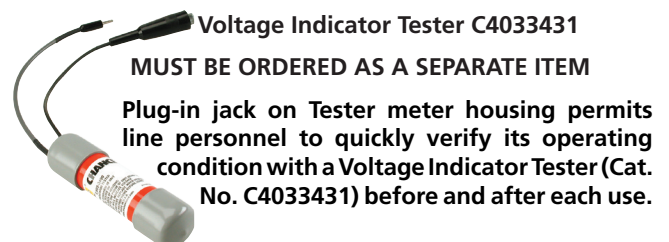

Voltage Indicator Tester C4033431

**MUST BE ORDERED AS A SEPARATE ITEM**

Plug-in jack on Tester meter housing permits line personnel to quickly verify its operating condition with a Voltage Indicator Tester (Cat. No. C4033431) before and after each use.

### Accessories

H187665	Shepherd Hook Probe	¼ lb./0.1 kg.
H18766	Straight Probe	⅛ lb./0.05 kg..



# CHANCE® Multi-Range Voltage Detector



*Lighted-dial model for systems through 40 kV*



Light Switch

Self-test Button ▶



Overhead Voltage-Presence Test with Hook Probe

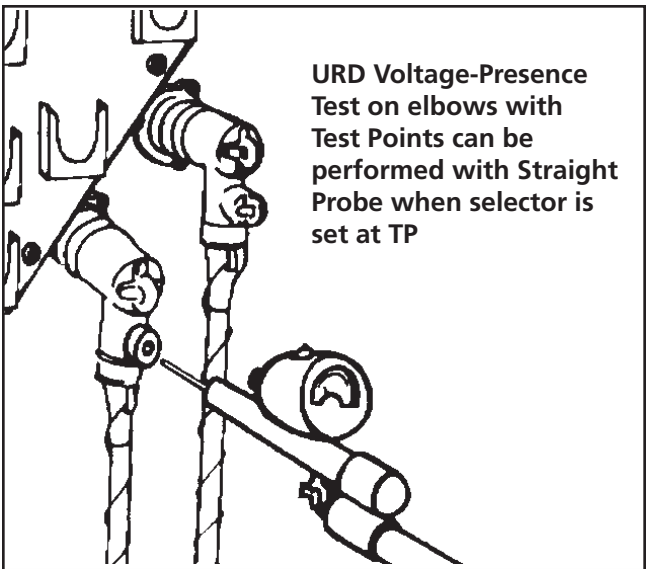

URD Voltage-Presence Test on elbows with Test Points can be performed with Straight Probe when selector is set at TP

**Accessories**

H18766S	Shepherd Hook Probe	¼ lb./0.1 kg.
H18766	Straight Probe	⅛ lb./0.05 kg.

**Easier-To-Read, illuminated Dial**

- The lighted-dial option sets this unit apart from standard features on Multi-Range Voltage Detector (MRVD) C4030979, shown on next page
- A long-life bulb, powered by included internal battery, gives a glow to the meter face so scale is easy to read in most conditions
- To conserve the battery, a special switch locks the light off when not in use
- Spring-loaded toggle must be pulled up to move it over the stop between its on and off positions
- This helps keep switch from being flipped on accidentally while unit is not in use

**Standard Features**

- Confirms a line is de-energized prior to performing maintenance
- A field intensity meter, it is calibrated to read approximate line-to-line voltage when connected to any phase conductor
- Responds to magnitude of field gradient between its end probe and floating electrode (at the universal hotstick-attachment fitting)
- If the universal fitting is close to a ground, another phase or another voltage source, reading should be high
- If it's close to a jumper or equipment of the same phase, the reading should be low
- Gives metered readout capable of distinguishing actual line voltage from static or feedover from an adjacent line
- Numerical readings can be compared with numerical rather than subjective judgments associated with "fuzz sticking" or "glow-detecting"
- Since it is not a voltmeter, no specific accuracy is claimed by the manufacturer or can be assumed by the user

**Operation**

- Must be mounted on proper length hotstick for the voltage class involved
- Complete instructions are furnished with easy, illustrated step-by-step procedures
- Internal circuit and pushbutton permit check before and after each use to confirm operational condition of instrument and battery



**Includes:**

- Straight probe for URD elbows with test points
- Hook probe for overhead uses
- Instructions and storage case

Catalog No.	Scale	Weight
T4033228	1 - 40 kV	5½ lb./2.5 kg.

Instruments & Meters - 2450



# Multi-Range Voltage Detectors for Overhead Systems to 600 kV and URD Elbow Test Points\*



Overhead Voltage-Presence Test can be performed by all models.

Switch on C4030979\* includes Test Point.



C4030979\*

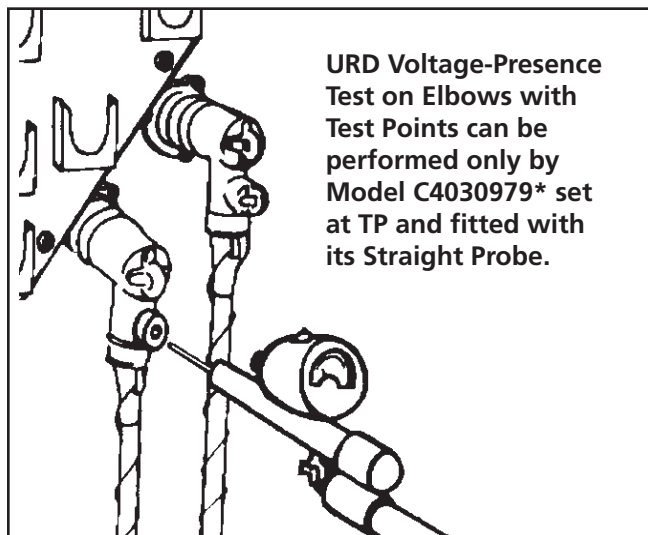

URD Voltage-Presence Test on Elbows with Test Points can be performed only by Model C4030979\* set at TP and fitted with its Straight Probe.

## Design Features

- Confirms a line is de-energized prior to performing maintenance
- A field intensity meter, it is calibrated to read approximate line-to-line voltage when connected to any phase conductor
- Responds to magnitude of field gradient between its end probe and floating electrode (at the universal hotstick-attachment fitting)
- If the universal fitting is close to a ground, another phase or another voltage source, reading should be high
- If it's close to a jumper or equipment of the same phase, the reading should be low
- Gives metered readout capable of distinguishing actual line voltage from static or feedover from an adjacent line
- Numerical readings can be compared with numerical rather than subjective judgments associated with "fuzz sticking" or "glow-detecting"
- Since it is not a voltmeter, no specific accuracy is claimed by the manufacturer or can be assumed by the user

## Operation

- Must be mounted on proper length hotstick for the voltage class involved
- Complete instructions are furnished with easy, illustrated step-by-step procedures
- Internal circuit and pushbutton permit check before and after each use to confirm operational condition of instrument and battery



C4031029 or C4031140

## Ordering Information

### Distribution and Transmission Multi-Range Voltage Detectors

Catalog No.	Scales	Weight
C4030979*	1 - 40 kV	5½ lb./2.5 kg.
C4031029	16 - 161 kV	5½ lb./2.5 kg.
C4031140	69 - 600 kV	5½ lb./2.5 kg.

\*For testing URD elbows with test points, only model C4030979 on this page includes straight probe and "TP" setting on selector switch (as well as hook probe for overhead uses).

For other URD models and Accessories, see next page.

# Multi-Range Voltage Detectors for Overhead & URD Systems to 40 kV

## Features & Applications

- Test both overhead and underground distribution systems
- For systems in voltage classes from 5 through 40 kV
- Provide easy, yet reliable means for operator to determine if a line is:
  - o De-energized, or
  - o Carrying less than normal system voltage from any source or induced charged from an adjacent live circuit, or
  - o Energized at full system voltage
- Adapt to both overhead lines as well as URD circuits with 200 and 600 Amp loadbreak elbows
- This includes those with and without capacitance test-points
- Interchangeable probes and adapters
- Thread into the MRVD end fitting and the selector switch dials to the voltage range or test point (T.P.) setting appropriate to each application
- Furnished owner's manual illustrates operating details for all models.



**T4032271**  
for Overhead and for URD Loadbreak Elbows

This model is capable of these three tests:

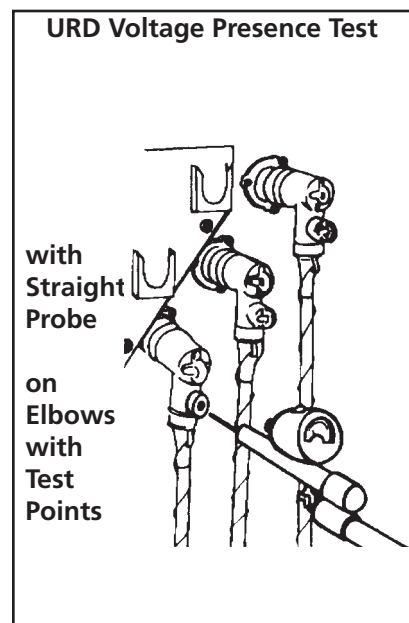
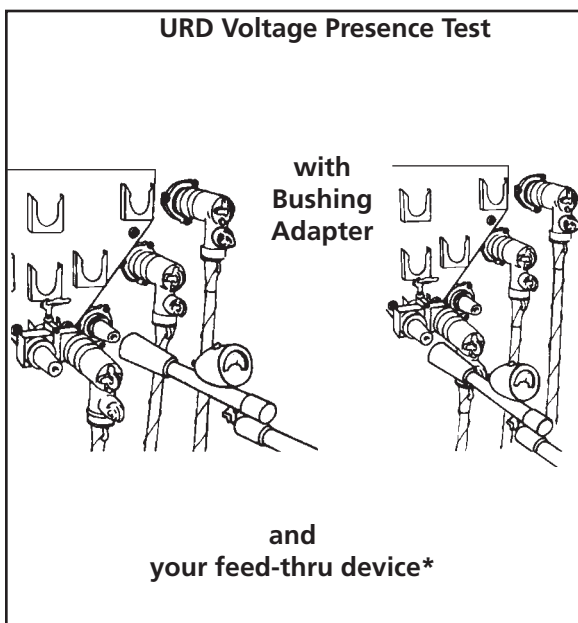

*\*Elbow Adapter also furnished to complete test when not using a feed-thru bushing device.*

### Ordering Information

5-15-25-40 kV Multi-Range Voltage Detector with TP Setting for Test Point on URD Elbows

Catalog No.	Description	Weight
T4032271	MRVD, Hook & Straight Probes, Elbows & Bushing Adapters, Case	6 lb./2.7 kg.

### Accessories

H18766S	Shepherd Hook Probe	¼ lb./0.1 kg.
H18766	Straight Probe	⅛ lb./0.05 kg.



Instruments & Meters - 2450

# Super Tester Voltage Detector

• *Dual Range* • *Audible & Visible Indicators*

## Features & Applications

- Lights blink and alarm sounds when placed in electrostatic field above trigger threshold
- Five flashing red lights alert the operator
- High-pitched tones also signal nearby personnel of present voltage that could be dangerous when applying temporary grounds or performing maintenance
- Can be used to check overhead lines, in substations and around switchgear
- Simply slips over the head of a standard 1-1/4"-diameter disconnect stick
- May be used on a Chance Grip-All clampstick, universal, telescoping or positive-grip hot line stick fitted with a special adapter (see table below)

## Design Features

- Handy three-way switch permits selection of either the 1 - 100 kV or the 100 - 800 kV range for circuit being tested
- Turns off unit to save the battery when not in use
- 9-Volt alkaline battery readily installs by removing two knurl-head screws and sliding off the instrument cover
- Test button checks both the battery and the tester
- Depressing button activates signal circuits, sounding the tone and lighting the alarm lamps if the battery is good and unit operable
- Comes with instructions packed in lined, reinforced case with carrying handle

## Operation

- Turn on tester with selector switch for voltage range required
- Check battery and unit by pushing "Test" button
- If tone volume is not clear or indicator lights are not bright, replace battery and recheck
- Mount tester on proper hot line tool
- For maximum-strength signals, place the tester within following minimum proximity to the circuit being tested

### Phase-to-Phase versus Response Distance

kV	(1 - 100kV Range) Distance - inches	(100 - 800kV Range) Distance - inches
2.0.....	0	
13.8.....	4	
25.0.....	12	
34.5.....	19.....	1
69.....	39.....	3
115.....		7
161.....		10
230.....		20
345.....		26
525.....		44

**WARNING:** Instrument damaged by touching 33kV or higher.

Note: Super Tester will not detect any voltage on cable with metallic sheath or semiconductive coating. Super Tester does not discriminate between induced and line voltage types. Device signals in the presence of either and the operator must determine which type before following utility safety working practices for engaging energized conductors.



## Ordering Information

Catalog No.	Description	Weight
H1990ST	Super Tester, battery, plastic case	4¾ lb./2.1 kg.
M445598 (Catalog Section 2100)	Super Tester Adapter for Grip-All, Universal, Telescoping or Positive-Grip hot line tools	5 oz./0.14 kg.

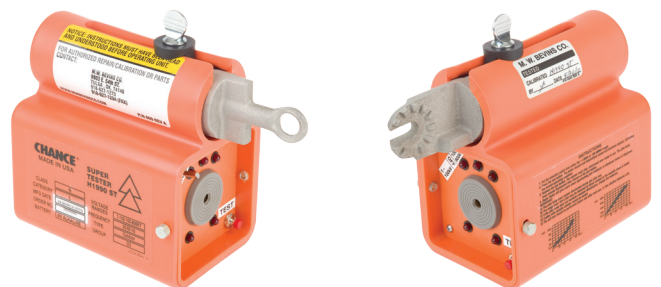

M445598 Adapter fits into Super Tester either way so you can use it on a Grip-All clampstick or on a splined fitting of Universal, Telescoping or Positive-Grip hot line sticks.



# Energized Insulator Testers

## for Distribution and Transmission Systems

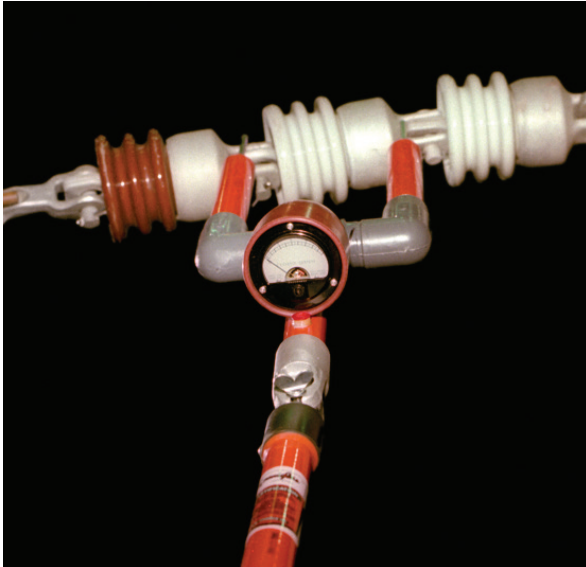

### Operation

- Sensitive voltmeter measures difference in potential across each insulator in a suspect string
- Comparative readings from satisfactory strings in same operating situation quickly indicate the state of every insulator in the string being tested
- Meter places minimal load on the phase as it requires only a small leakage current to make a reading
- Two straight steel probes threaded into the tester forks simply contact the metal fittings on both ends of each insulator at the same time
- Mounted on a 1-1/4"-dia. Epoxiglas<sup>®</sup> pole with a universal fitting
- Before each use the tester should be attached to the proper length hot stick for the system voltage involved
- Distribution model's scale reads up to 11 kV
- Transmission model's scale reads a maximum of 16 kV

### Applications

- Without interrupting service, one of these testers quickly can check the condition of each insulator in a string
- Greatly reduces maintenance costs
- Only insulators identified as damaged require replacements
- No need to change entire strings
- Available in two models
- Testers serve specific applications:
  - Deadend insulators on distribution systems through 35 kV
  - Suspension insulators on 44 kV through 500 kV transmission systems



**Transmission Tester  
C4032299**

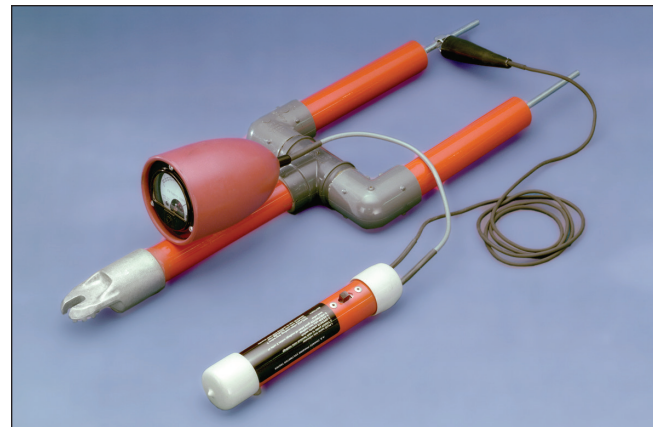

Plug-in jack on Insulator Tester meter housing permits line personnel to quickly verify its operable condition with a Phasing Voltmeter Tester (Cat. No. C4030838) before and after each use.



**Distribution Tester  
C4032298**

### Energized Insulator Testers

(each includes instrument, two straight probes, operating instructions and metal carrying case)

Catalog No.	System Applications	Weight
C4032298	Distribution (thru 35 kV)	4 lb./1.8 kg.
C4032299	Transmission (44 thru 500 kV)	5 lb./2.25 kg.

\*Carrying case weighs additional 10¼ lb. (4.62 kg.)

Instruments & Meters - 2450



## Voltage Tester for Underground Transformers

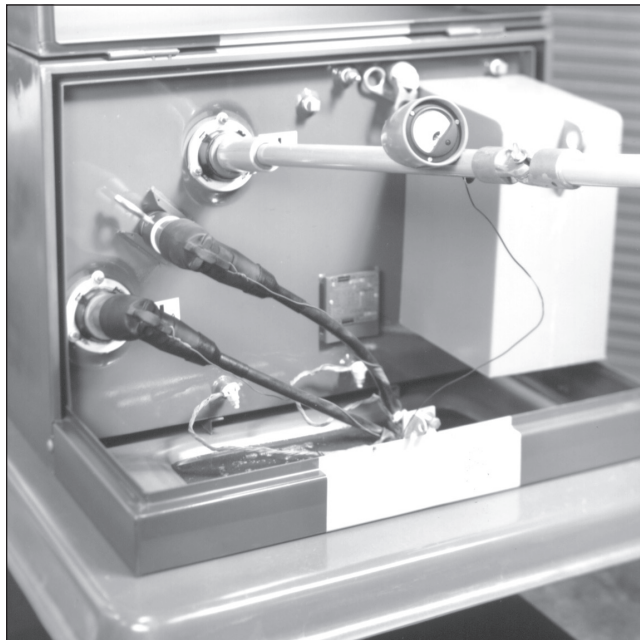

### Features & Applications

- Portable device checks the AC voltages on Underground Distribution circuits through 20 kV
- Determines approximate line-to-ground voltage of the circuits
- Basic instrument, C4031369, reads voltages up to 10 kV on meter
- Resistance units are encapsulated in an epoxy compound to protect against mechanical damage
- Prevents moisture penetration or accumulation around resistors
- No calibration is required – tool is preset at the factory
- Extension resistor is provided for voltages above 10 kV phase-to-ground. This increases voltage range to 20 kV phase-to-ground.
- Do not use more than one extension resistor element per tool
- Ground connection is made to a stud on the stick below the meter housing
- This stud **MUST** be electrically connected to a good ground source
- Before the Voltage Tester is used to test elbows or bushings on dead front URD equipment, proper adapter must be attached to tool
- Elbow must be controlled or restrained with an insulated hot stick while using Voltage Tester to check elbows
- Elbow must be properly parked when bushing is being checked

C4031369  
for 0 - 10 kV



To check tester's condition before and after each use, test-point jack in front of meter accepts plug-in lead of Voltmeter Tester (see page 2453).



C4031367



Units Assembled  
for 20 kV Testing



Elbow  
Adapter  
T4030602

Bushing  
Adapter  
T4030428



Adapters for 15 kV only



Elbow  
Adapter  
T4030856

Bushing  
Adapter  
T4030857



Adapters for 15, 25 and 35 kV only

Catalog No.	Description
C4031367	Complete Voltage Tester for 20 kV Ø-G includes Tester, Extension Resistor, Case and Instruction Booklet
C4031368	1 Extension Resistor
C4031369	Voltage Indicator 10 kV Ø-G with Case and Instruction Booklet
T4030602	Elbow Adapter for 8.3/15 kV only
T4030428	Bushing Adapter for 8.3/15 kV only
T4030856	Elbow Adapter for 15, 25 & 35 kV
T4030857	Bushing Adapter for 15, 25 & 35 kV
C4030838	Tool with Leads and Battery

# Polymer Insulator Tester

## For Transmission Suspension Insulators

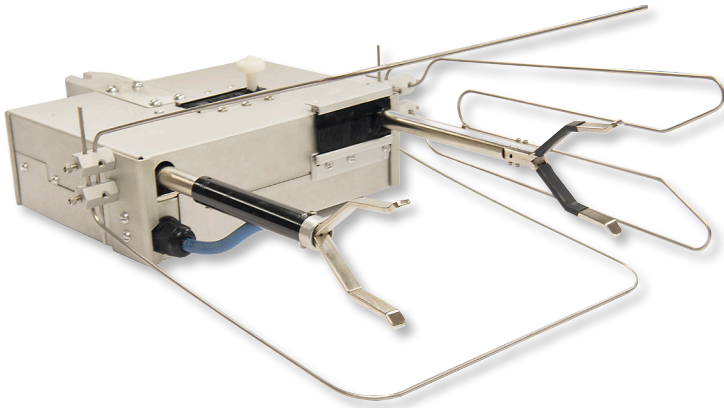

### Operation

- Measures electrical integrity of polymer insulator
- Compares data from known good insulator or from calibration samples provided
- Can be used on energized line or de-energized
- Rechargeable battery
- Self contained power supply. Does not rely on E - field to operate.
- Must be used with appropriate length Epoxiglas<sup>®</sup> pole with universal fitting
- Easy to interpret Go/No Go lights and audible tones
- Data can be viewed and downloaded to Wi-Fi enabled device
- Adjustable probe spacing to fit most suspension insulators
- Rugged carrying case

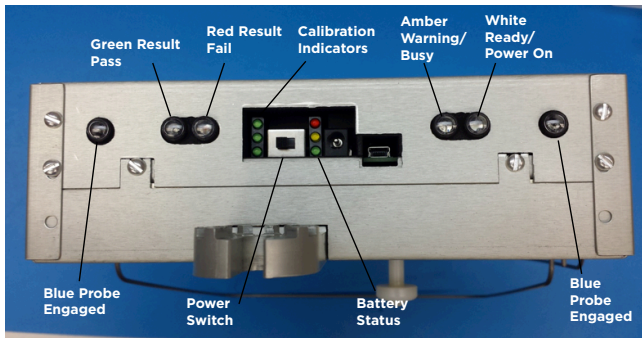

### Applications

- Can be used to collect data on energized line without interrupting service
- Use to test insulators before installation for added security
- Used on transmission suspension insulators 69kV and above up to 1.8" in diameter



Kit includes; Tester, Battery charger, Adapter cables, Calibration samples, Holder and Users Manual

Catalog No.	Application	Weight
PSC403-3679	Transmission Suspension 69kV thru 500kV	4.2 lbs.

# Energized Cable Sensor

## Features & Applications

- Allows lineman to determine whether URD cable is energized or de-energized
- Amplifier is designed to give a meter reading
- This occurs when small AC voltage between the semi-conductive sheath and the concentric neutral of the energized URD cable is applied to test probe
- Amplifier is housed in a rugged thermoplastic case



- Self-test contact point is located on top of amplifier housing
- Check meter operation and battery condition by touching test probe to test point

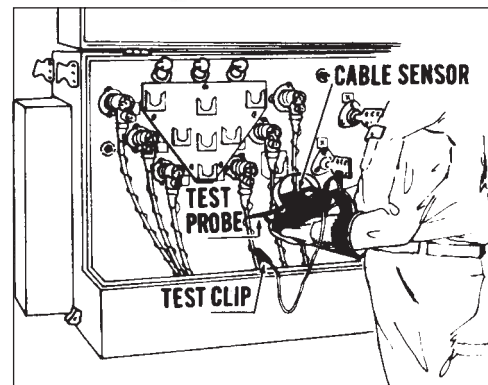

- Sensor checks energized condition on concentric-neutral cable below an elbow without test points (as above)
- At cable mid-span (left), hose clamps bridge all strands of concentric neutral at the test location
- Sensor's neutral lead clips to one of the hose clamps
- Tip on probe lead contacts semi-conductive cable sheath to test voltage

Catalog No.	Description	Weight
C4030803	URD Cable Sensor, two leads, two hose clamps, two 9-volt batteries and instructions	5 lb./2.3 kg.

## Dielectric Compound No. 7

Dielectric Compound No. 7, a silicone base material, is made for use with load break disconnects and other electrical connecting and terminating devices.

Cat. No. C4170287..... 2 oz. Tube





## Protective-Grounding-Set Tester

- Meets ASTM Standard F 2249
- Offers easy, accurate diagnostics

### Self-Contained, Portable Convenience

- Used to check resistance in protective grounding sets
- 120 VAC and 230 VAC models available
- Applies Direct Current across the test specimen
- Seven-minute video, included with each unit, shows how to use tester
- Instruction manual includes procedure details
- All components store in tester's integral carrying case

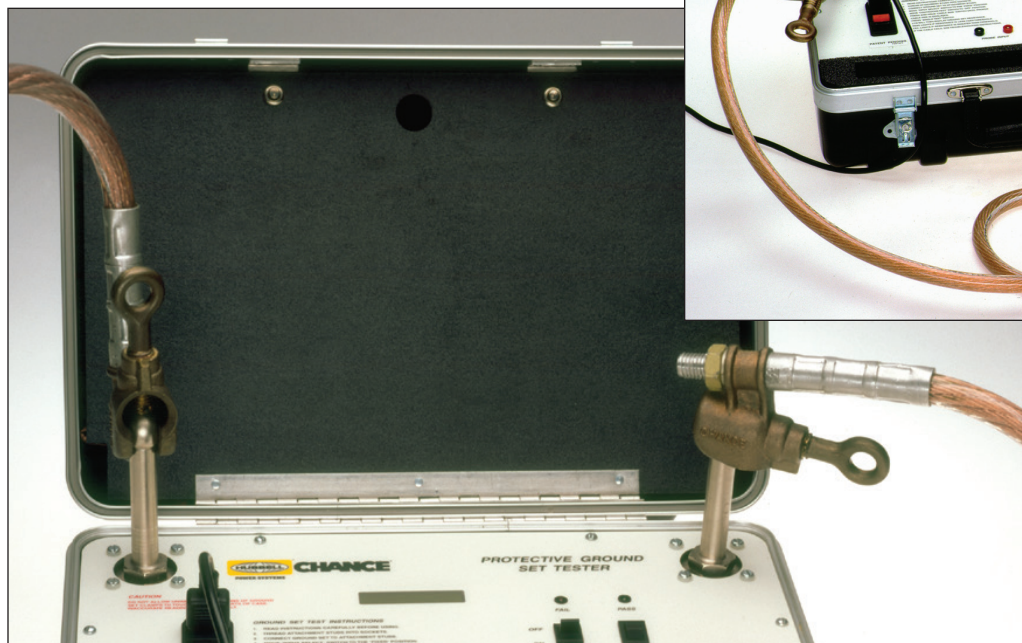

### Simple, One-Button Testing

- Digital display shows the resistance measured in milliohm
- This is compared with a preset threshold for the size grounding cable selected (#2, 1/0, 2/0 or 4/0)
- Green "Pass" or red "Fail" light also indicates test results
- Factory preset at 100 Volts
- User can easily change the Tester's basis for voltage allowed
- Adjusting this limit automatically causes a corresponding shift in resistance thresholds for all grounding cable sizes
- Regardless of the voltage-allowed setting or cable size selected, the Tester displays resistance of each specimen in milliohms
- Resistance displayed with  $\pm 1\%$  accuracy, from 1 micro-ohm to 6.5 ohms
- Utility must establish maximum resistance allowed for protective grounding sets used on each specific area of systems
- How the utility calculates these values depends on several factors outlined in the Tester instructions
- Sample calculations with reference tables and charts are in manual

### Troubleshooting Mode

- If a ground set does not pass initial test, Tester can help isolate problems
- High-resistance source can often be remedied by simple repairs to cable set
- Retesting then can quickly verify the effects of repairs
- For troubleshooting mode, test probes are furnished to plug into the Tester
- A switch activates them instead of ball-stud terminals
- Probes are used to test across each contact interface in ground set
- Results display in milliohms, just as in the first test mode

### Optional Terminals For Special Ground Sets

- Standard ball-stud terminals accept most types of ground clamps, including Chance ball-socket clamps.
- To test special-application grounding sets for underground-distribution transformers or switchgear, two optional adapters shown are available as separate items



# Protective-Grounding-Set Tester (continued)

- For easy, accurate diagnostics
- Meets ASTM Standard F 2249



Optional Straight Stud Terminal T4033159 for testing grounded-parking-stand temporary grounding sets.

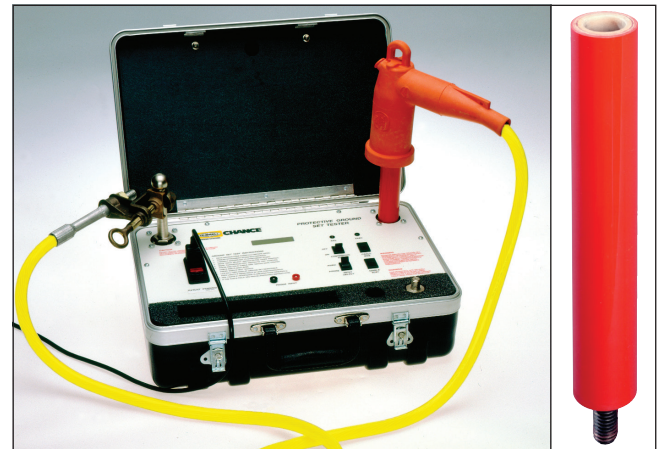

Optional Elbow Adapter C4033449 (15 & 25kV) for testing temporary grounding sets fitted with a grounding elbow. PSC4032947, 35kV, Elbow Adapter.

## Included with each

### Protective-Grounding-Set Tester:

- Self-contained carry case
- 2 ball-stud terminals
- DVD demonstration video
- 2 troubleshooting probes
- Self-test cable

Catalog No.	Description	Weight
C4033220	115/120-Volt Protective Ground-Set Tester	17 lb./7.65 kg.
PSC4033220003	230-Volt Protective Ground-Set Tester	17 lb./7.65 kg.

### Optional Adapters:

T4033159	Straight Stud Terminal for 15 and 25 kV	¾ lb./0.225 kg.
C4033449	Elbow Adapter 15/25kV	1 lb./0.45 kg.
PSC4032947	Elbow Adapter 35kV	1¼ lb./0.6 kg.

Complete Protective Ground-Set Tester  
Catalog No. C4033220.

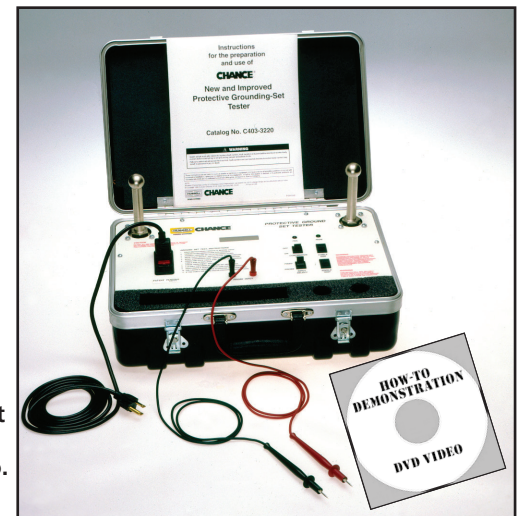

# Chance Teleheight

## Features & Applications

- Quickly and accurately figures pole, tree, or building heights or conductor clearance
- Easy to operate – only take a few minutes to learn
- Diagram shows how it works
- Sight point A and move backward or forward until the bubble centers on the hair line, which is point C
- Measure distance from C to D and add distance BC to find correct height
- Leather case (2-1/4" x 4-1/4") has belt loop

Catalog No.	Description	Weight
CW	Teleheight Complete w/Leather Case	1¼ lb./.6 kg.

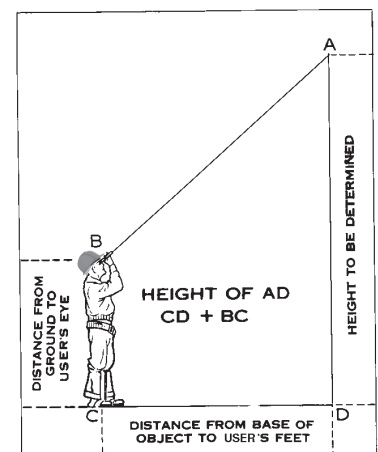

## LoadLocker Ammeter

- Models for Distribution, Transmission and Substation uses
- Hold feature for easy hotstick use

### User-Friendly Electronic-Loop Design

- Electronically closes loop
- No more manipulating a hinged or clamp-type inductive pick-up
- Unique U-shape jaw senses amperage present between tines
- Open-end design for checking component loads not accessible by other hot-line ammeters

### Live-Line-Ready Hotstick Mount

- Standard fitting mounts on your insulated hotsticks
- Fits the same as any other universal tool
- Your hot-line crews can begin using it immediately

... continued on next page ...



Wide  
Jaw



Narrow  
Jaw



# LoadLocker Ammeter

## Simple Pushbutton Operation, Direct-Reading Accuracy

- Push it once to turn on LoadLocker
- Push it a second time and LoadLocker will display the word HOLD
- Will continue to display the next reading it "sees" until you push the button to clear
- This lets you bring it down from the line to eye level to read it
- After five idle minutes, unit will turn itself off
- You can also manually turn it off by keeping the button depressed for five seconds
- Operator's Manual and storage case are included

## Rugged, Application-Specific Design

- Materials and construction are designed for field-condition rigors
- Typical applications include:
  - Identifying load imbalances
  - Verifying accuracy of current transformers
  - Determining load to select properly sized jumpers
  - Measuring load before opening switches

## General Specifications

LCD	3½-digit display of Amps, Hold, Low Battery
Battery	9 volt alkaline (included)
Accuracy	±1% +2 Digits
Frequency	50 or 60 Hertz
Operating Temperature	-30° to 60° C (-22° to 140° F)
Display Range	Automatic Ranging: 0 - 99.9 Amperes, in 0.1-Amp increments. 100 - 1999 Amperes, in 1.0-Amp increments. 2000-5000 Amperes, in 0.1kA Amp increments.
Operators Manual and Case included	

## Ordering Information

### 60 Hertz unit, Case and Operators Manual

Catalog No.	Max. Voltage (Ø-Ø)	Max. Current	Reading Type	Jaw Size	Weight
MEAMP11RW	Up to 69 kV	Up to 2,000 amps	True RMS	3.86"	3.1 lb. / 1.41 kg.
MEAMP21RW	Up to 400kV	Up to 2,000 amps	True RMS	3.86"	3.1 lb. / 1.41 kg.
MEAMP32RN	Up to 500kV	Up to 5,000 amps	True RMS	2.50"	3.1 lb. / 1.41 kg.

### 50 Hertz unit, Case and Operators Manual

MEAMP32RN2	Up to 500kV	Up to 5,000 amps	True RMS	2.50"	3.1 lb. / 1.41 kg.
------------	-------------	------------------	----------	-------	--------------------

## Replacement Case

Catalog No.	Description	Weight
C4002561	Hard Case for LoadLocker Ammeter	2.5 lb. / 1.13 kg.



Narrow Jaw  
with  
Soft Case



Wide Jaw  
with  
Hard Case



# Wet/Dry Hot Stick Tester for easy, portable compliance with industry standards

## New Controls & Meter for All Requirements

- Simple to operate, portable unit
- Makes easy work of testing insulated live-line tools
- Wet and dry modes selected by a toggle switch
- Follows procedures specified by ASTM, IEEE and OSHA
- Graduated meter gives precise readout of each tool's leakage current

## Portable Operating Ease

- For testing any length fiberglass-reinforced plastic (FRP) hot stick up to 3" in dia.
- For spot checks at field jobsites or periodic diagnostics in workshop
- Full-scale test setups for both Wet (75 kV-per-foot) and Dry (100 kV-per-foot)
- Compact, self-contained unit easily carried and operated by one person
- In Setup procedure before each use, a zeroing knob is used to set meter to zero without a tool in the tester
- Furnished Check Bar serves as self-check to ensure tester is functional
- Included video demonstrates "how-to" basics for Setup, Dry and Wet tests
- Owners Manual must be read and understood before operating tester



## Quantitative Test Results

- When placed on tool, displays any increase in leakage current due to hotstick
- Gives immediate indication of stick's true leakage condition, independent of stray currents (through the air, internal to testers, etc.) zeroed out in advance
- Detects leakage currents due to surface contamination, internal moisture and such internal conductive materials as carbon tracks



## Ordering Information

Included with each Tester:

- Check bar
- Owners operating instruction manual
- Demonstration video
- Carrying case

Catalog No.	Wet/Dry Hot Stick Tester	Weight
C4033178	115-volt model	20 lb./9.0 kg.
C4033179	*230-volt model	20 lb./9.0 kg.

\*Power-source cord does not include plug on 230-volt model

Instruments & Meters - 2450





# Ladder Monitor Kit

# CHANCE®

2477

for EHV Microamp Measurement on Barehand Equipment

## Features & Applications

- Used with EHV Barehand maintenance to detect microamp leakage on a ladder
- Meter is connected to ladder and takes readings when ladder is in contact with conductor
- Recommended that readings be taken periodically to ensure optimal working conditions which could be altered by change in atmosphere
- Kit includes:
  - o 200 micro-amp scale microammeter
  - o Three clamps to effect use on a three-rail ladder
  - o Cable with clips and adapter to establish contact
  - o Bracket to ground and hold meter on structure
  - o Two dry cell batteries
  - o Instruction drawings for field assembly
  - o Operating instructions

Catalog No.	Description	Weight
C4020288	Ladder Monitor Kit	7.5 lb./3.4 kg.



## Chance Sentinel Leakage-Current Monitor

- Alerts utility-line workers of overcurrent conditions
- For such aerial devices as insulated ladders and truck booms
- Sounds an alarm if leakage current reaches a pre-set level
- Leakage setting adjusts from 1 to 1,000 microamperes in resolution increments of 0.1 microamp
- Audible warning eliminates need to watch the actual current level, continuously displayed on digital LCD screen
- Alarm sounds immediately upon overcurrent and continues until the condition is corrected
- Instrument panel jack accepts a standard 1/4" two-conductor phone plug to also trigger a truck horn or other external alarm
- Panel test terminal permits a simple continuity check of the monitor leads prior to each operation

Catalog No.	Description	Weight
C4070025	Chance Sentinel Kit	9 lb./4.05 kg.



- Before use, instrument automatically performs a rapid electronic self-test
- Simple operating steps are printed on inside lid panel
- Detailed instruction sheet included
- Kit includes one coaxial cable and battery, two jumpers and three hose clamps for connections to two- or three-rail ladders
- Brackets on box secure to an earth-grounded structure up to 5/8" thick such as a transmission tower

## Truck Boom Leakage-Current Monitor

- Mounts on truck body and hardwires into truck's 12-Volt system, which eliminates battery changeout
- Sounds an alarm if leakage current reaches a pre-set level
- Alerts utility-line workers of overcurrent conditions on truck booms
- Leakage setting adjusts from 1 to 1,000 microamperes in resolution increments of 0.1 microamp
- Audible warning eliminates need to watch the actual current level, continuously displayed on digital LCD screen
- Alarm sounds immediately upon overcurrent and continues until the condition is corrected
- Instrument panel jack accepts a standard 1/4" two-conductor phone plug to also trigger a truck horn or other external alarm
- Panel test terminal permits a simple continuity check of the monitor leads prior to each operation

Catalog No.	Description	Weight
T4070327	Boom Monitor Kit (12 Volt)	14 lb./6.4 kg.

- Before use, instrument automatically performs a rapid electronic self-test
- Simple operating steps are printed on the inside lid panel
- Detailed instruction sheet included



Mounting studs on steel box bond directly to truck body.

Instruments & Meters - 2450

# Proximity Voltage Indicator (PVI)

600V to 500kV - Audible & Visible Indicators

## Features & Applications

- Bright display lights and audible alarm indicate voltage class without need to directly contact the conductor
- The class displayed is the approximate phase to phase voltage class
- Used to determine if power lines are at rated voltage, have induced voltage or are de-energized
- Designed as a non-contact Voltage Indicator
- Must be used with properly selected universal hot stick, even with rubber gloves
- Designed to be held 6 to 18 inches away from conductor being tested for presence of voltage
- Advanced feature allows user to temporarily disable range indications for voltages below the user selected range

## Design Features

- New battery drawer does not require removal of front panel for replacement of batteries
- Requires two AA batteries
- Comes with storage bag designed with snaphook for suspending from belt or in storage
- Lightweight, 1.25lbs versus the 4.75lbs of the Super Tester

## Operation

- To turn on the meter, press the power switch until the audible tone is heard
- Each LED will light up individually from the lowest to highest and then the alarm
- Bring the indicator within 6 to 18 inches of the line to be measured
- Below 480 volts, the indicator may need to be 6 inches or less away from the line
- Once an electrical field is detected, the range indications will increase as you approach the conductor
- As the voltage field intensity increases, the Proximity "SENSE" LED, Range LED and audible alarm will flash and beep faster

## Optional Field Tester

- The proximity voltage indicator can be field tested with the Voltage Indicator Tester PSC4033582



Catalog No.	Application	Weight
PSC4033737	Proximity Voltage Indicator and Bag	1-1/4 lbs.

## Snaphook on each bag

- For suspending from belt or in storage
- Leather reinforced tab is stitched to the back of each bag

Instruments & Meters - 2450

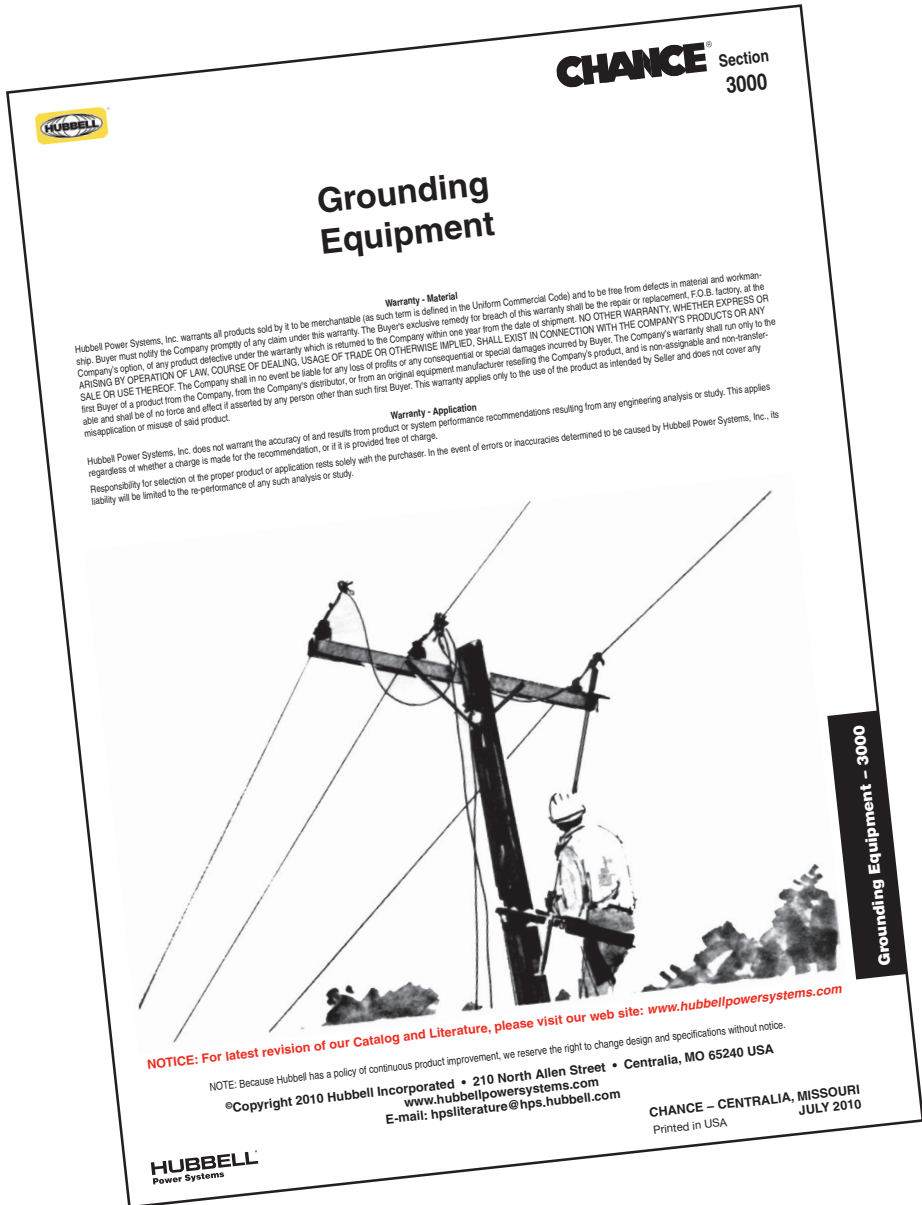

# Grounding Equipment Catalog

## Section 13

**CHANCE**<sup>®</sup>

www.hubbellpowersystems.com  
E-mail: hpsliterature@hps.hubbell.com



Phone: 573-682-5521

Fax: 573-682-8714

210 North Allen

Centralia, MO 65240, USA

©Copyright 2018 Hubbell Incorporated

# Temporary Grounding Equipment

## Safe Working Practices

There are many reasons for temporary grounding to protect personnel working on de-energized circuits, including:

1. Induced voltage from adjacent energized lines
2. Fault-current feedover from adjacent lines
3. Lightning strikes anywhere on the circuit
4. Switching-equipment malfunction or human error
5. Accident-initiated contact with adjacent lines

Since any one of the above could result in re-energizing the circuit, most utilities treat these potential dangers as ever-present and impose strict temporary-grounding work rules. Their crews' experience often voices these watchwords for the wise to heed:

"If you can't see both ends, it's hot" and "If it isn't grounded, it isn't dead."



To indicate energized conditions on overhead lines, (from left) Chance Auto Ranging Voltage Indicator, Digital Voltage Detector and Multi-Range Voltage Detector. At far right, Energized Cable Sensor performs the same function on URD cable with an exposed concentric neutral and elbows without test points. See Catalog Section 2450, "Instruments and Meters," for details and ordering information.

## General Practices

- On de-energized distribution lines, Chance recommends Double-Point grounding
- This grounding is at both structures adjacent to worksite: Connect all three phases via ground set, then connect to ground rod.
- Plus a personal ground at the worksite, from any one phase to a cluster bar well below the worker's feet
- On a system without a neutral, Chance recommends connecting down leads to screw ground rods installed at least 20 feet from all structures and barricaded
- Only for maintenance tasks during which grounds need not be replaced does Chance find acceptable the Single-Point grounding method (at only the worksite: Connect all phases together and grounding plus personal ground, as above)
- Where adequate phase-to-phase clearances permit, Chance accepts the practice of grounding only the phase being worked (in the same manner as personal ground, above)

## Safety Reviews

- Temporary grounding practices should be reviewed on a regular basis
- As part of a total maintenance program, routine reviews should be scheduled apart from sessions to set new practices for system upgrades and additions
- These basics should be included on a review checklist:
  1. Clamp designs specific to each application,
  2. Cable sized for fault-current potential (see table on page 3002) and minimum-slack lengths
  3. How construction affects placement of grounds
  4. Work procedures outlined above
  5. Inspect and test each grounding set

## Chance Grounding-Set Tester

- Ideal for performing function #5 above
- Checks the resistance in a protective ground set
- Can help locate problems often remedied by simple repairs
- How-to video is included with the tester
- See Catalog Section 2450, "Instruments and Meters," for details and ordering information

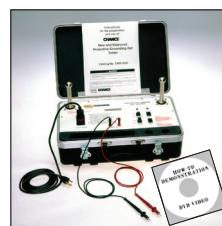





**TABLE 1 Protective Ground Cable, Ferrule, Clamp and Assembly Ratings for Symmetrical Current**

Grade	Grounding Clamp Torque Strength, min				Short Circuit Properties <sup>A</sup>								Continuous Current Rating A RMS, 60 Hz
	Yield <sup>B</sup>		Ultimate		Withstand Rating, Symmetrical kA RMS, 60 Hz			Ultimage Rating Capacity <sup>C,D</sup> , Symmetrical kA RMS, 60 Hz					
	lbf-in.	n-m	lbf-in.	n-m	15 cycles (250 ms)	30 cycles (500 ms)	Copper Cable Size	15 cycles (250 ms)	30 cycles (500 ms)	60 cycles (1 s)	Maximum Copper Test Cable Size		
1	280	32	330	37	14	10	#2	18	13	9	2/0	200	
2	280	32	330	37	21	15	1/0	29	21	14	4/0	250	
3	280	32	330	37	27	20	2/0	37	26	18	4/0	300	
4	330	37	400	45	34	25	3/0	47	33	23	250 kcmil	350	
5	330	37	400	45	43	30	4/0	59	42	29	250 kcmil	400	
6	330	37	400	45	54	39	250 kcmil or 2 2/0	70	49	35	350 kcmil	450	
7	330	37	400	45	74	54	350 kcmil or 2 4/0	98	69	48	550 kcmil	550	

<sup>A</sup> Withstand and ultimate short circuit properties are based on performance with surges not exceeding 20% asymmetry factor (see 9.1 and 12.3.4.2).  
<sup>B</sup> Yield shall mean no permanent deformation such that the clamp cannot be reused throughout its entire range of application.  
<sup>C</sup> Ultimate rating represents a symmetrical current which the assembly or individual components shall carry for the specified time.  
<sup>D</sup> Ultimate values are based upon application of Onderdonk's equation to 98% of nominal circular mil area allowed by Specifications B172 and B173.

**TABLE 2 Ultimate Assembly Rating for High X/R Ratio Applications**

High Asymmetrical Test Requirements X/R = 30 Cycle Current Peak Values (kA) Rating X 2.69					
Grade Size	Rating Rated Current (kA)	1st	15th	Test Duration (cycles)	1 <sup>2</sup> t (Mega amps <sup>2</sup> -s)
1H	15	41	23	15	74
2H	25	68	38	15	208
3H	31	84	46	15	312
4H	39	105	58	15	501
5H	47	127	70	15	728
6H	55	148	82	15	997
7H	68	183	101	15	1523

NOTE 1 – The above current values are based on electromechanical test values.  
 NOTE 2 – Assemblies that have been subjected to these shall not be re-used.  
 NOTE 3 – For use with currents exceeding 20% asymmetry factor.  
 NOTE 4 – See X4.7.2 for additional information.  
 NOTE 5 – Alternate testing circuits are available for laboratories that cannot achieve the above requirements. See Appendix X4 for details.

## Selecting grounding clamps and cable

The Chance grounding line comprises both ready-made sets and separate components for your specific needs. Among the options and criteria to consider:

- Functional fit—Sizes of the clamp types in this section appear in ascending order of maximum-main-line size. By design, many clamps serve a wide size range for their conductor type (cable, bus or tower)
- Adequate capacity—Published ratings for both clamps and cable must withstand maximum-potential system fault-current magnitude and full-time duration. Certified test reports are available on request
- Coordinated connectors—Terminal (either pressure-type or threaded-type) selected for clamps dictates the cable ferrule type (either plain or threaded) to match
- On-site handling—Application clearances and fit (for overhead conductors and ground wires, transmission tower shapes, URD apparatus or substation buswork) affect clamp and cable dimensions

## How to order a Grounding Set

In addition to the specifying criteria above, each part of a grounding set requires certain choices:

1. Clamps
  - ASTM designations for Type, Class and Grade given for clamps shown in this section
2. Ferrules
  - Copper or aluminum
  - Plain or threaded
3. Cable
  - Length required to reach application distances
  - ASTM Type I with black or yellow elastomer jackets for temperatures from -40°F (-40°C) through +194°F (+90°C)
  - ASTM Type III with clear thermoplastic jacket for temperatures from +14°F (-10°C) through +140°F (+60°C) should be used only in well-ventilated areas
4. Support Stud
  - This option recommended on only one clamp to help control lifting the set to the first clamp attachment point
5. Shrink Tubing
  - This translucent option recommended for stress relief and inspection of cable strands between ferrule and jacket.

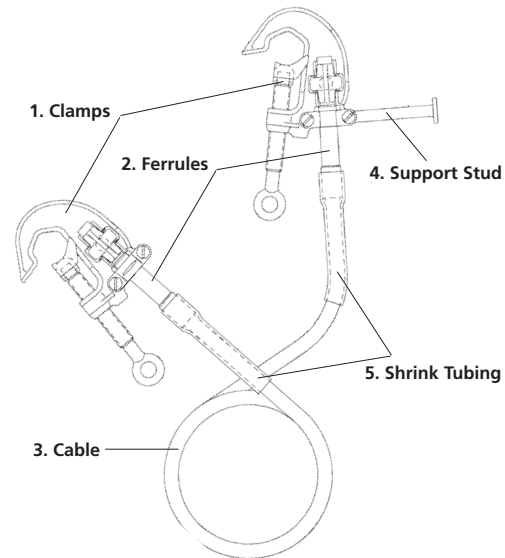

## Installation information

- Several training aids available on request
- Chance videos and technical manuals provide details on proper installation
- Consult your Chance representative for any additional assistance

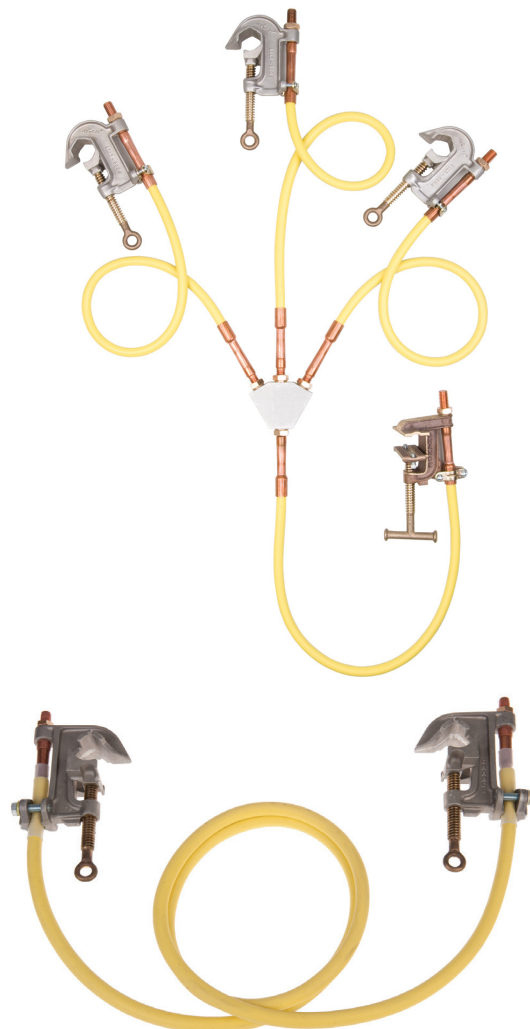
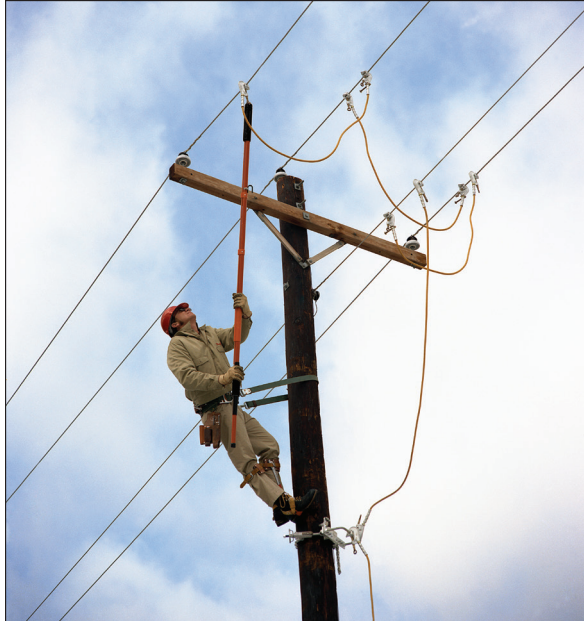

## C-Type Grounding Clamps



**T6000465**  
Bronze body,  
Smooth jaws,  
Bronze eyescrew  
with fine threads,  
Tapped for 5/8-11 UNC threaded ferrule  
or T6000466,  
Drilled for 5/8-11 UNC threaded ferrule



**T6000790**  
Bronze body,  
Smooth jaws,  
Bronze T-handle/eyescrew  
with fine threads,  
Tapped for 5/8-11 UNC  
threaded ferrule



**C6002271**  
Bronze body,  
Smooth jaws,  
Bronze eyescrew  
with fine threads,  
Tapped for 5/8-11 UNC  
threaded ferrule



**C6001959**  
Bronze body,  
Smooth jaws,  
Bronze T-handle/eyescrew  
with fine threads,  
Tapped for 5/8-11 UNC  
threaded ferrule

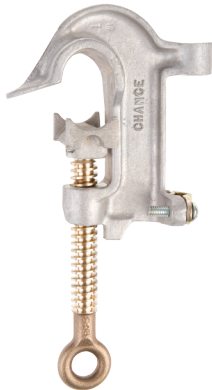

**C6001754**  
Aluminum body,  
Smooth jaws,  
Bronze eyescrew  
with Acme threads,  
Tapped for 5/8-11 UNC  
threaded ferrule

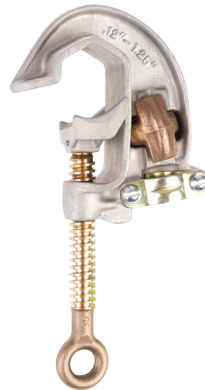

**C6002275**  
Aluminum body,  
Smooth jaws,  
Bronze eyescrew  
with Acme threads,  
Bronze pressure-type  
terminals



**C6002276**  
Aluminum body,  
Serrated jaws,  
Bronze eyescrew  
with Acme threads,  
Bronze pressure-type  
terminals

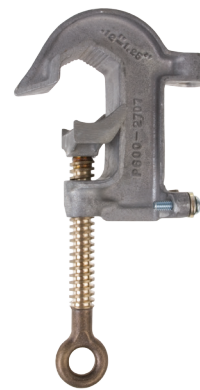

**T6002708**  
Aluminum body,  
Serrated jaws,  
Bronze eyescrew  
with Acme threads,  
Tapped for 5/8-11 UNC  
threaded ferrule



**C6001743**  
Aluminum body,  
Smooth jaws,  
Bronze eyescrew  
with fine threads,  
Tapped for 5/8-11 UNC  
threaded ferrule

Catalog Number	C6001959 T6000465 T6000466 T6000790	C6002271	C6001754	C6002275	C6002276	T6002708	C6001743
<b>ELECTRICAL RATINGS</b>							
Continuous Current (AMPS)	250	400	350	400	400	400	400
Fault Current - 15 Cycles (AMPS)	21,000	43,000	27,000	43,000	43,000	43,000	43,000
Fault Current - 30 Cycles (AMPS)	15,000	30,000	20,000	30,000	30,000	30,000	30,000
<b>MECHANICAL RATINGS</b>							
Recommended Torque (in.-lb.)	200	250	250	250	250	250	250
Main Line Range - Max.	477 kcmil ACSR (0.814")	1033 kcmil ACSR (1.25")	750 kcmil Str. Cu. 636 kcmil ACSR (0.998")	1033 kcmil ACSR (1.25")	1033 kcmil ACSR (1.25")	1033 kcmil ACSR (1.25")	1000 kcmil Cu. 1590 kcmil ACSR (1.50")
Main Line Range - Min.	#6 Sol. Cu. (0.162")	#6 Sol. Cu. (0.162")	#8 Sol. Cu. (0.128")	#8 Sol. Cu. (0.128")	#8 Sol. Cu. (0.128")	#8 Sol. Cu. (0.128")	#6 Sol. Cu. (0.162")
Jumper Range - Max.	1/0 Grd. Cable	4/0 Grd. Cable	2/0 Grd. Cable	4/0 Grd. Cable	4/0 Grd. Cable	4/0 Grd. Cable	4/0 Grd. Cable
Jumper Range - Min.	#2 Grd. Cable	#2 Grd. Cable	#2 Grd. Cable	#2 Grd. Cable	#2 Grd. Cable	#2 Grd. Cable	#2 Grd. Cable
Weight Each	1 1/2 lb./0.7kg.	2 lb./0.9kg.	1 lb./0.5kg.	1 1/4 lb./0.6 kg.	1 1/4 lb./0.6kg.	1 1/4 lb./0.6kg.	1 1/2 lb./0.7kg.
ASTM Designation	Type I Class A Grade 2	Type I Class A Grade 5	Type I Class A Grade 3	Type I Class A Grade 5	Type I Class B Grade 5	Type I Class B Grade 5	Type I Class A Grade 5
IEC Ratings							
Jaws	Smooth	Smooth	Smooth	Smooth	Serrated	Serrated	Smooth
Ferrule	Threaded	Threaded	Threaded	Plain Plug	Plain Plug	Threaded	Threaded

Grounding Equipment - 3000

# C-Type Grounding Clamps



**C6002281**  
Aluminum body,  
Smooth jaws,  
Bronze eyescrew  
with Acme threads  
Bronze pressure-type terminal



**C6002255**  
Aluminum body,  
Smooth jaws,  
Bronze eyescrew  
with Acme threads,  
Tapped for 5/8-11 UNC threaded  
ferrule  
*\*Unshrouded Ferrules Only*



**C6002282**  
Aluminum body,  
Serrated jaws,  
Bronze eyescrew  
with Acme threads  
Bronze pressure-type terminal



**C6002256**  
Aluminum body,  
Serrated jaws,  
Bronze eyescrew  
with Acme threads,  
Tapped for 5/8-11 UNC threaded ferrule  
*\*Unshrouded Ferrules Only*



**C6000386**  
*\*Mounted Clamp*  
Aluminum body,  
Serrated jaws,  
Bronze eyescrew  
with Acme threads,  
Bronze pressure-type terminal

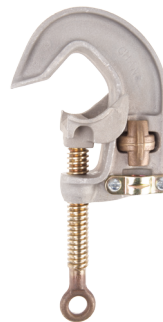

**G36051**  
Aluminum body,  
Smooth jaws,  
Bronze eyescrew  
with Acme threads,  
Bronze pressure-type terminal



**T6003203**  
Aluminum body,  
Smooth jaws,  
Bronze eyescrew  
with Acme threads,  
Tapped for 5/8-11 UNC  
threaded ferrule  
*\*Unshrouded Ferrules  
Only*



**T6000658**  
Aluminum body,  
Smooth jaws,  
Bronze eyescrew  
with Acme threads,  
Drilled for 5/8-11 UNC  
threaded ferrule

Catalog Number	C6002281	C6002255	C6002282	C6002256	*C6000386	G36051	T6003203	T6000658
----------------	----------	----------	----------	----------	-----------	--------	----------	----------

**ELECTRICAL RATINGS**

Continuous Current (amps)	400	400	400	400	400	400	400	400
Fault Current - 15 Cycles (amps)	43,000	43,000	43,000	43,000	43,000	43,000	43,000	43,000
Fault Current - 30 Cycles (amps)	30,000	30,000	30,000	30,000	30,000	30,000	30,000	30,000

**MECHANICAL RATINGS**

Recommended Torque (in.-lb.)	250	250	250	250	250	250	250	250
Main Line Range - Max.	2" O.D. Bus	2" O.D. Bus	2" O.D. Bus	2" O.D. Bus	2" O.D. Bus	2" O.D. Bus	2" O.D. Bus	2" O.D. Bus
Main Line Range - Min.	#6 Sol. Cu. (.162")	#6 Sol. Cu. (.162")	#6 Sol. Cu. (.162")	#6 Sol. Cu. (.162")	#6 Sol. Cu. (.162")	#6 Sol. Cu. (.162")	#6 Sol. Cu. (.162")	#6 Sol. Cu. (.162")
Jumper Range - Max.	4/0 Grd. Cable	4/0 Grd. Cable	4/0 Grd. Cable	4/0 Grd. Cable	4/0 Grd. Cable	4/0 Grd. Cable	4/0 Grd. Cable	4/0 Grd. Cable
Jumper Range - Min.	#2 Grd. Cable	#2 Grd. Cable	#2 Grd. Cable	#2 Grd. Cable	#2 Grd. Cable	#2 Grd. Cable	#2 Grd. Cable	#2 Grd. Cable
Weight Each	2 lb./0.9kg.	1¾ lb./0.8kg.	2 lb./0.9kg.	1¾ lb./0.8kg.	*	1¾ lb./0.8kg.	1¾ lb./0.8kg.	1¾ lb./0.8kg.
ASTM Designation	Type I Class A Grade 5	Type I Class A Grade 5	Type I Class B Grade 5	Type I Class B Grade 5	Type II Class B Grade 5	Type I Class A Grade 5	Type I Class A Grade 5	Type I Class A Grade 5
IEC Ratings		35 kA		35 kA				
Jaws	Smooth	Smooth	Serrated	Serrated	Serrated	Smooth	Smooth	Smooth
Ferrule	Plain Plug	Threaded <i>*Unshrouded Only</i>	Plain Plug	Threaded <i>*Unshrouded Only</i>	Plain Plug	Plain Plug	Threaded	Threaded

\*C6000386 has 1-1/4" x 6' Epoxiglas® Pole and total weight of 3¾ lb. (1.7 kg.).



## C-Type Grounding Clamps

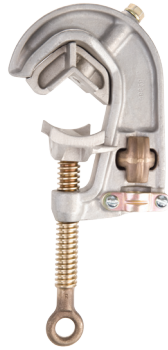

**G33672**  
Aluminum body,  
Smooth jaws,  
Bronze eyescrew  
with Acme threads,  
Bronze pressure-type threads



**C6001733**  
Aluminum body,  
Smooth jaws,  
Bronze eyescrew  
with Acme threads,  
Tapped for 5/8-11 UNC threaded ferrule  
\*Unshrouded Ferrules Only



**C6000375**  
Aluminum body,  
Serrated jaws,  
Bronze eyescrew  
with Acme threads,  
Dual drilled for 5/8-11 UNC threaded ferrule

## Bus-Bar Grounding Clamps:



**G3369**  
Aluminum body,  
Smooth jaws,  
Bronze eyescrew  
with Acme threads,  
Bronze pressure-type terminal



**C6000337**  
Aluminum body,  
Smooth jaws,  
Bronze eyescrew  
with Acme threads,  
Bronze pressure-type terminal



**T6000819**  
Aluminum body,  
Smooth jaws,  
Bronze eyescrew  
with Acme threads,  
Parking stud

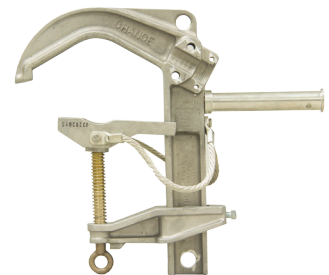

**PSCT6000844001**  
Aluminum body,  
Smooth jaws,  
Bronze eyescrew  
with Acme threads,  
Parking stud

Catalog Number	G33672	C6001733	C6000375	G3369	C6000337	T6000819	PSCT6000844001
<b>ELECTRICAL RATINGS</b>							
Continuous Current (AMPS)	400	400	400	400	400	400	400
Fault Current - 15 Cycles (AMPS)	43,000	43,000	†70,000	43,000	43,000 †60,000	47,000	68,000
Fault Current - 30 Cycles (AMPS)	30,000	30,000	†50,000	30,000	30,000 †60,000		
<b>MECHANICAL RATINGS</b>							
Recommended Torque (in.-lb.)	250	250	300	300	300	300	300
Main Line Range - Max.	2-1/2" O.D. Bus	2-1/2" O.D. Bus	3" O.D. Bus	4" x 4" Square 4.5" O.D. Bus	6-5/8" O.D. Bus	6-5/8" O.D. Bus	6-5/8" O.D. Bus
Main Line Range - Min.	#4 Str. Cu. (0.232")	#4 Str. Cu. (0.232")	0.50" O.D. Bus	4/0 Str. Cu. (0.500")	3-1/2" O.D. Bus	3-1/2" O.D. Bus	3-1/2" O.D. Bus
Jumper Range - Max.	4/0 Grd. Cable	4/0 Grd. Cable	4/0 Grd. Cable	4/0 Grd. Cable	4/0 Grd. Cable	Parking Stud	Parking Stud
Jumper Range - Min.	#2 Grd. Cable	#2 Grd. Cable	#2 Grd. Cable	#2 Grd. Cable	#2 Grd. Cable	Parking Stud	Parking Stud
Weight Each	2-3/8 lb./1.1kg.	2-3/8 lb./1.1kg.	3 lb./1.4kg.	5-1/4 lb./2.4kg.	6 lb./2.7 kg.	5 lb./2.27 kg.	7.8 lb/3.54 kg.
ASTM Designation	Type I Class A Grade 5	Type I Class A Grade 5	Type I Class B Grade 7	Type I Class A Grade 5	Type I Class A Grade 6	Type I Class A Grade 5H	Type I Class A Grade 7H
IEC Rating (15 cycles)	35 kA	35 kA	35 kA				
Jaws	Smooth	Smooth	Serrated	Smooth	Smooth	Smooth	Smooth
Ferrule	Plain Plug	Threaded	Threaded	Plain Plug	Plain Plug	Parking Stud	Parking Stud

†Rating with twin-grounding cables.

## Snap-On (Duckbill-type) Grounding Clamps



**G18102**  
Aluminum body,  
Bronze upper jaw,  
Smooth jaws,  
Bronze eyescrew  
with fine threads,  
Bronze pressure-type terminal



**G36221**  
Aluminum body,  
Smooth jaws,  
Bronze eyescrew  
with fine threads,  
Bronze pressure-type terminal



**HG37061**  
\*Mounted Clamp  
Aluminum body,  
Smooth jaws,  
Bronze eyescrew  
with fine threads,  
Bronze pressure-type terminal

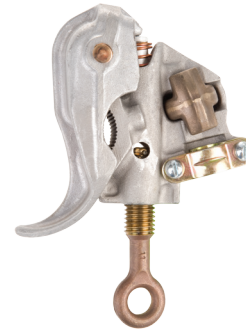

**T6000806**  
Aluminum body,  
Serrated jaws,  
Bronze eyescrew  
with fine threads,  
Bronze pressure-type terminal

Catalog Number	G18102	G36221	*HG37061	T6000806
<b>ELECTRICAL RATINGS</b>				
Continuous Current (AMPS)	300	400	400	400
Fault Current - 15 Cycles (AMPS)	27,000	43,000	34,000	43,000
Fault Current - 30 Cycles (AMPS)	20,000	30,000	25,000	30,000
<b>MECHANICAL RATINGS</b>				
Recommended Torque (in.-lb.)	250	250	300	300
Main Line Range - Max.	250 kcmil Str. Cu. 4/0 ACSR (0.574")	566 kcmil Cu. 900 kcmil ACSR (1.162")	566 kcmil Cu. 900 kcmil ACSR (1.162")	1590 kcmil ACSR (1.625")
Main Line Range - Min.	#6 Sol. Cu. (0.162")	#6 Sol. Cu. (0.162")	#6 Sol. Cu. (0.162")	0.5"
Jumper Range - Max.	2/0 Grd. Cable	4/0 Grd. Cable	4/0 Grd. Cable	4/0 Grd. Cable
Jumper Range - Min.	#2 Grd. Cable	#2 Grd. Cable	#2 Grd. Cable	#2 Grd. Cable
Weight Each	1-1/2 lb./0.6 kg.	1-1/2 lb./0.6 kg.	*	1-3/4 lb./0.8 kg.
ASTM Designation	Type I Class A Grade 3	Type I Class A Grade 5	Type II Class A Grade 4	Type I Class B Grade 5
IEC Rating (15 cycles)		35 kA		
Jaws	Smooth	Smooth	Smooth	Serrated
Ferrule	Plain Plug	Plain Plug	Plain Plug	Plain Plug

\*HG37061 has 1¼" x 6' Epoxiglas<sup>®</sup> Pole and total weight of 3½ lb. (1.6 kg.).

## Snap-On (Duckbill-type) Grounding Clamps



**C6001734**  
Aluminum body,  
Smooth jaws,  
Bronze eyescrew  
with fine threads,  
Tapped for 5/8-11 UNC threaded ferrule



**C6000198**  
\*Mounted Clamp  
Aluminum body,  
Serrated jaws,  
Bronze eyescrew  
with Acme threads,  
Tapped for 5/8-11 UNC threaded ferrule



**C6000197**  
Aluminum body,  
Serrated jaws,  
Bronze eyescrew  
with Acme threads,  
Tapped for 5/8-11 UNC threaded ferrule



**C6001757**  
Aluminum body,  
Smooth jaws,  
Bronze eyescrew  
with fine threads,  
Tapped for 5/8-11 UNC threaded ferrule



**C6000434**  
Aluminum body,  
Serrated jaws,  
Bronze eyescrew  
with fine threads,  
Bronze pressure-type terminal

Catalog Number	C6001734	*C6000198	C6000197	C6001757	C6000434
<b>ELECTRICAL RATINGS</b>					
Continuous Current (AMPS)	400	400	400	400	400
Fault Current - 15 Cycles (AMPS)	43,000	43,000	43,000	43,000	43,000
Fault Current - 30 Cycles (AMPS)	30,000	30,000	30,000	30,000	30,000
<b>MECHANICAL RATINGS</b>					
Recommended Torque (in.-lb.)	250	250	250	250	250
Main Line Range - Max.	566 kcmil Cu. 900 kcmil ACSR (1.162")	950 kcmil Cu. 1510 kcmil ACSR (1.506")	950 kcmil Cu. 1510 kcmil ACSR (1.506")	2.5"	950 kcmil Cu. 1510 kcmil ACSR (1.506")
Main Line Range - Min.	#6 Sol. Cu. (0.162")	#6 Sol. Cu. (0.162")	#6 Sol. Cu. (0.162")	0.75"	#6 Sol. Cu. (0.162")
Jumper Range - Max.	4/0 Grd. Cable	4/0 Grd. Cable	4/0 Grd. Cable	4/0 Grd. Cable	4/0 Grd. Cable
Jumper Range - Min.	#2 Grd. Cable	#2 Grd. Cable	#2 Grd. Cable	#2 Grd. Cable	#2 Grd. Cable
Weight Each	1-1/2 lb./0.7 kg.	*	1-1/2 lb./0.7 kg.	2-1/4 lb./1.0 kg.	1-1/2 lb./0.7 kg.
ASTM Designation	Type I Class A Grade 5	Type II Class B Grade 5	Type I Class B Grade 5	Type I Class A Grade 5	Type I Class B Grade 5
IEC Rating (15 cycles)	35 kA		35 kA		
Jaws	Smooth	Serrated	Serrated	Smooth	Serrated
Ferrule	Threaded	Threaded	Threaded	Threaded	Plan Plug

\*C6000198 has 1 1/4" x 6' Epoxiglas® Pole and total weight of 3 1/2 lb. (1.6 kg.).

## Cluster Grounding Clamps

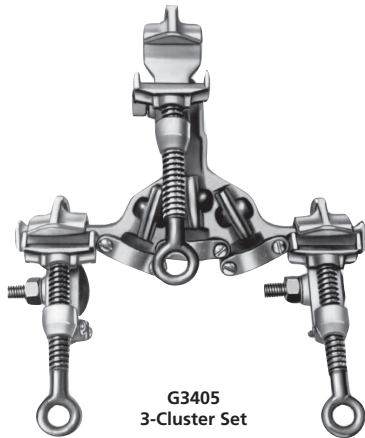

G3405  
3-Cluster Set  
with C-Type Aluminum-body clamps,

Smooth jaws, Bronze eyescrews with Acme threads, and 3-phase Aluminum cluster bar with Bronze Pressure-type terminals

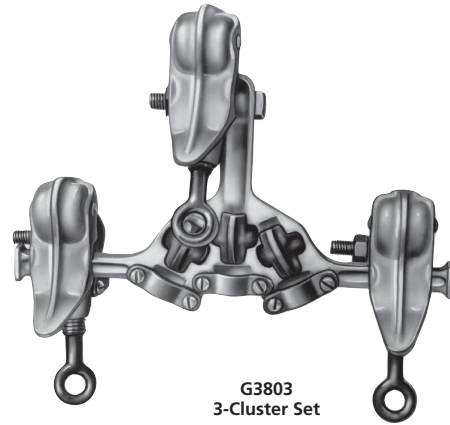

G3803  
3-Cluster Set  
with Snap-On (Duckbill-type) Aluminum-body clamps,

Smooth jaws, Bronze eyescrews with fine threads, and 3-phase Aluminum cluster bar with Bronze Pressure-type terminals

**Important Note:**

Cluster Sets are furnished as shown above. The center clamp is bolted to the cluster bar.

Typical fourth ground clamp  
(not included in 3-Cluster Set,  
must be ordered as separate item)

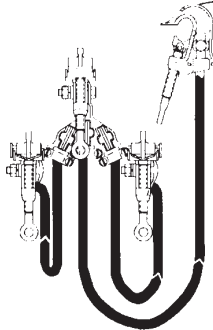

These drawings illustrate how Cluster Sets are to be connected, with grounding cable and a fourth clamp which must be ordered separately.

For cable and ferrules, see page 3018-3019.

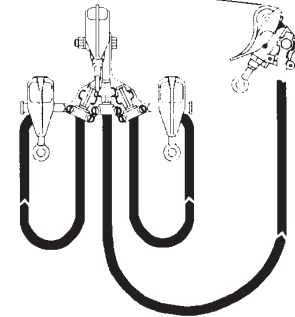

Catalog Number	G3405	G3803
<b>ELECTRICAL RATINGS</b>		
Continuous Current (AMPS)	350	400
Fault Current - 15 Cycles (AMPS)	27,000	34,000
Fault Current - 30 Cycles (AMPS)	20,000	25,000
<b>MECHANICAL RATINGS</b>		
Recommended Torque (in.-lb.)	250	250
Main Line Range - Max.	400 kcmil Str. Cu. 636 kcmil ACSR (.998")	566 kcmil Cu. 900 kcmil ACSR (1.162")
Main Line Range - Min.	#8 Sol. Cu. (0.12")	#6 Sol. Cu. (0.162")
Jumper Range - Max.	2/0 Grd. Cable	4/0 Grd. Cable
Jumper Range - Min.	#2 Grd. Cable	#2 Grd. Cable
Weight Each	4 1/2 lb./2 kg.	6 5/8 lb./3 kg.
ASTM Designation	Type I Class A Grade 3	Type I Class A Grade 4
Jaws	Smooth	Smooth
Ferrule	Plain Plug	Plain Plug



## Tower & Flat-Face Grounding Clamps



**C6002232**  
Bronze body, Serrated jaws,  
Bronze eyescrew with Acme threads,  
Drilled for 5/8-11 UNC threaded ferrule  
or T6003196,  
Tapped for 5/8-11 UNC threaded ferrule  
or PST6003485  
for Fine Thread Eyescrew version

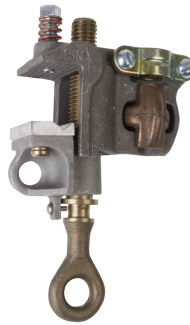

**G33633SJ**  
Aluminum body,  
Serrated jaws,  
Bronze eyescrew  
with fine threads,  
Bronze pressure-type terminal



**C6001735**  
Aluminum body,  
Serrated jaws,  
Bronze eyescrew  
with fine threads,  
Tapped for 5/8-11 UNC threaded ferrule



**C6002231**  
Bronze body, Serrated jaws,  
Bronze T-handle with Acme threads,  
Drilled for 5/8-11 UNC threaded ferrule  
or T6003195,  
Tapped for 5/8-11 UNC threaded ferrule  
or T6003009,  
with Fine Threads T-Handle version

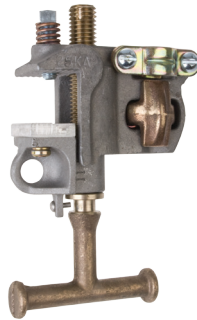

**G33634SJ**  
Aluminum body,  
Serrated jaws,  
Bronze T-handle  
with fine threads,  
Bronze pressure-type terminal

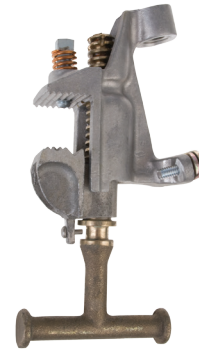

**T6001798**  
Aluminum body,  
Serrated jaws,  
Bronze T-handle  
with Acme threads,  
Tapped for 5/8-11 UNC threaded ferrule

Catalog Number	C6002232	G33633SJ	C6001735	C6002231	G33634SJ	T6001798
<b>ELECTRICAL RATINGS</b>						
Continuous Current (AMPS)	400	400	400	400	400	400
Fault Current - 15 Cycles (AMPS)	43,000	27,000	27,000	43,000	27,000	27,000
Fault Current - 30 Cycles (AMPS)	30,000	20,000	20,000	30,000	20,000	20,000
<b>MECHANICAL RATINGS</b>						
Recommended Torque (in.-lb.)	250	250	250	250	250	250
Main Line Range - Max.	1½" Angles 1½" Flat	1½" Angles 1½" Flat	1½" Angles 1½" Flat	1½" Angles 1½" Flat	1½" Angles 1½" Flat	1½" Angles 1½" Flat
Main Line Range - Min.	1/8"	1/8"	1/8"	1/8"	1/8"	1/8"
Jumper Range - Max.	4/0 Grd. Cable w/Threaded Stud	2/0 Grd. Cable w/Plain Plug	2/0 Grd. Cable w/Threaded Stud	4/0 Grd. Cable w/Threaded Stud	2/0 Grd. Cable w/Plain Plug	2/0 Grd. Cable w/Threaded Stud
Jumper Range - Min.	#2 Grd. Cable w/Threaded Stud	#2 Grd. Cable w/Plain Plug	#2 Grd. Cable w/Threaded Stud	#2 Grd. Cable w/Threaded Stud	#2 Grd. Cable w/Plain Plug	#2 Grd. Cable w/Threaded Stud
Weight Each	2 lb./0.9 kg.	1½ lb./0.7 kg.	1½ lb./0.7 kg.	2 lb./0.9 kg.	1½ lb./0.7 kg.	1½ lb./0.7kg.
ASTM Designation	Type I Class B Grade 5	Type I Class B Grade 3	Type I Class B Grade 3	Type III Class B Grade 5	Type III Class B Grade 3	Type III Class B Grade 3
IEC Rating (15 Cycles)						
Jaws	Serrated	Serrated	Serrated	Serrated	Serrated	Serrated
Ferrule	Threaded	Plain Plug	Threaded	Threaded	Plain Plug	Threaded

**Grounding Equipment - 3000**

## Tower & Flat-Face Grounding Clamps

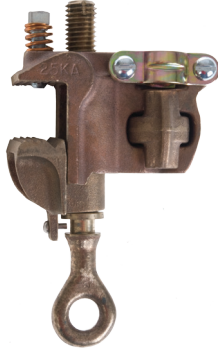

**G33631**  
Bronze body,  
Serrated jaws,  
Bronze eyescrew  
with fine threads,  
Bronze pressure-type terminal

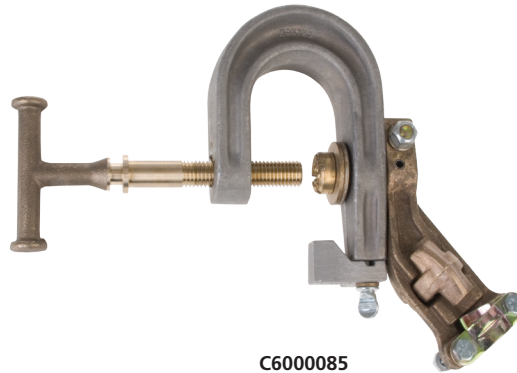

**C600085**  
Aluminum body and retainer,  
Bronze scrubber-type contact pads,  
Bronze T-handle  
with fine threads,  
Bronze pressure-type terminal



**G33632**  
Bronze body,  
Serrated jaws,  
Bronze T-handle  
with fine threads,  
Bronze pressure-type terminal

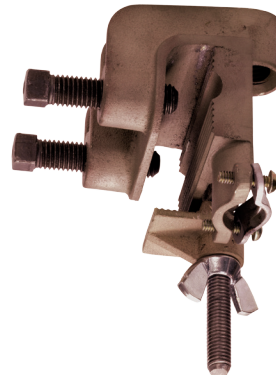

**C6001783**  
Bronze body,  
Serrated jaws and retainers,  
Tapped for 5/8-11 UNC threaded ferrule

Catalog Number	G33631	G33632	C600085	C6001783
<b>ELECTRICAL RATINGS</b>				
Continuous Current (AMPS)	400	400	400	400
Fault Current - 15 Cycles (AMPS)	27,000	27,000	43,000	43,000
Fault Current - 30 Cycles (AMPS)	20,000	20,000	30,000	30,000
<b>MECHANICAL RATINGS</b>				
Recommended Torque (in.-lb.)	250	250	250	300
Main Line Range - Max.	1½" Angles 1½" Flat	1½" Angles 1½" Flat	4" Structural Angles	¾" x 5" Angles or Flats 5/8" Rod
Main Line Range - Min.	1/8"	1/8"	2" Structural Angles	1/8"
Jumper Range - Max.	2/0 Grd. Cable w/Plain Plug	2/0 Grd. Cable w/Plain Plug	4/0 Grd. Cable w/Plain Plug	4/0 Grd. Cable w/Threaded Stud
Jumper Range - Min.	#2 Grd. Cable w/Plain Plug	#2 Grd. Cable w/Plain Plug	#2 Grd. Cable w/Plain Plug	#2 Grd. Cable w/Threaded Stud
Weight Each	2½ lb./1.1 kg.	2½ lb./1.1 kg.	3¾ lb./1.1 kg.	5 lb./2.25 kg.
ASTM Designation	Type I Class B Grade 3	Type III Class B Grade 3	Type III Class B Grade 5H	Type III Class B Grade 5H
IEC Rating (15 cycles)				
Jaws	Serrated	Serrated	Serrated	Serrated
Ferrule	Plain Plug	Plain Plug	Plain Plug	Threaded

# All-Angle Grounding Clamps

## Aluminum Bodies with Serrated Jaws

For installation ease, jaws pivot 75° left or right.

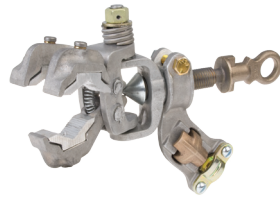

**G422915J**  
\*Pressure Terminal

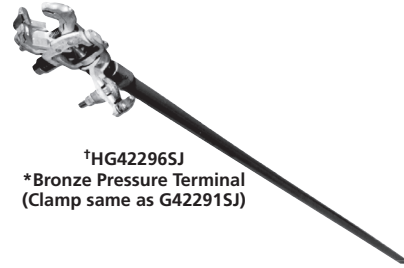

†HG422965J  
\*Bronze Pressure Terminal  
(Clamp same as G422915J)

\* For adapter to convert to threaded terminal, see Page 3019.

Catalog Number	G422915J	†HG422965J
<b>ELECTRICAL RATINGS</b>		
Continuous Current (AMPS)	400	400
Fault Current - 15 Cycles (AMPS)	43,000	43,000
Fault Current - 30 Cycles (AMPS)	30,000	30,000
<b>MECHANICAL RATINGS</b>		
Recommended Torque (in.-lb.)	250	250
Main Line Range - Max.	954 kcmil ACSR (1.196")	954 kcmil ACSR (1.196")
Main Line Range - Min.	#2 Cu. (.258")	#2 Cu. (.258")
Jumper Range - Max.	4/0 Grd. Cable	4/0 Grd. Cable
Jumper Range - Min.	#2 Grd. Cable	#2 Grd. Cable
Weight Each	2 lb./0.9 kg.	4¼ lb./2.0 kg.
ASTM Designation	Type I Class B Grade 5	Type II Class B Grade 5
Ferrule	Plain Plug	Plain Plug

†Mounted Clamps supplied with 1¼" x 6' Epoxiglas® Pole.

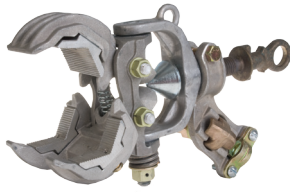

**G422810SJ**  
\*Bronze Pressure Terminal



†HG422816SJ  
\*Bronze Pressure Terminal  
(Clamp same as G4228-10SJ)

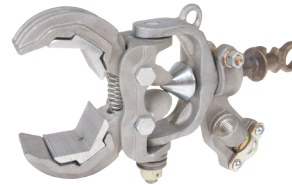

**T6001693**  
Tapped for 5/8-11 UNC threaded ferrule  
(Two single serrated jaws,  
for pothead and bus applications)



**C6001732**  
Tapped for 5/8-11 UNC  
threaded ferrule

\* For adapter to convert to threaded terminal, see Page 3019.

Catalog Number	G422810SJ	†HG422816SJ	T6001693	C6001732
<b>ELECTRICAL RATINGS</b>				
Continuous Current (AMPS)	400	400	400	400
Fault Current - 15 Cycles (AMPS)	43,000	43,000	43,000	43,000
Fault Current - 30 Cycles (AMPS)	30,000	30,000	30,000	30,000
<b>MECHANICAL RATINGS</b>				
Recommended Torque (in.-lb.)	250	250	250	250
Main Line Range - Max.	2.88"	2.88"	2.88"	2.88"
Main Line Range - Min.	#2 Cu. (.258")	#2 Cu. (.258")	#2 Cu. (.258")	#2 Cu. (.258")
Jumper Range - Max.	4/0 Grd. Cable	4/0 Grd. Cable	4/0 Grd. Cable	4/0 Grd. Cable
Jumper Range - Min.	#2 Grd. Cable	#2 Grd. Cable	#2 Grd. Cable	#2 Grd. Cable
Weight Each	3¼ lb./1.5 kg.	5¼ lb./2.4 kg.	3¼ lb./1.5 kg.	3¼ lb./1.5 kg.
ASTM Designation	Type I Class B Grade 5	Type II Class B Grade 5	Type I Class B Grade 5	Type I Class B Grade 5
IEC Rating (15 cycles)				35 kA
Jaws	Serrated	Serrated	Serrated	Serrated
Ferrule	Plain Plug	Plain Plug	Threaded	Threaded

†Mounted Clamps supplied with 1¼" x 6' Epoxiglas® Pole.

# Apparatus Grounding Clamps

## Ball-and-socket design for multiple uses

- For restricted-space applications and as a truck-grounding system, this compact design delivers a high-current rating usually associated with only large clamps
- Applies to a wide range of switching equipment, including:
  - Industrial metalclad gear
  - Substations – indoors and out
  - Distribution – overhead and underground
- For trucks, a \*ball stud permanently mounts on each body
- For three-phase livefront set, see page 3015
- Two clamp styles and three ball-stud lengths adapt to many applications
- Clamp bodies, eyescrews and \*ball-studs are bronze alloy
- Tin-plated ball-studs have nominal 1"-diameter ball and stud to fit NEMA terminal pads
- Lockwasher and nut are silicone bronze
- ASTM Designation of Type I, Class A, Grade 5 for any of these clamps is met if associated grounding-cable sets are fitted with 5/8" copper ferrules as on page 3019
- IEC Rating at 15 cycles of 35 kA for C6002100 and T6002320

**Fault Current Ratings**      43,000 Amps — 15 cycles  
 30,000 Amps — 30 cycles

**Recommended Installing Torques:**  
 Eyescrew 250 inch-pounds      \*Ball Stud 300 inch-pounds

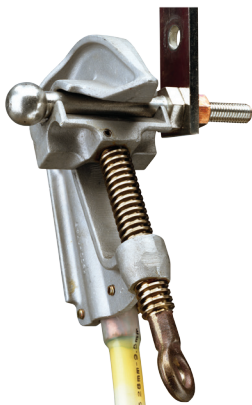

Long stud shank accepts most types of grounding clamps

Socket clamps provide multi-angle attachment of grounds

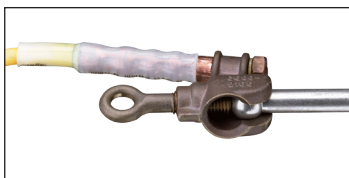

Clamp C6002100 Drilled for 5/8-11 UNC threaded ferrule  
 or  
 Clamp C6002101 Tapped for 5/8-11 UNC threaded ferrule

Clamp T6002320 Tapped for 5/8-11 UNC threaded ferrule for threaded stud ferrule on #2 to 4/0 grounding cable

Clamp C6002300 with pressure terminal for plain-plug ferrule on #2 to 4/0 grounding cable

for threaded stud ferrule on #2 to 4/0 grounding cable      Weight, each clamp on this page: 1 lb. / 0.45 kg.

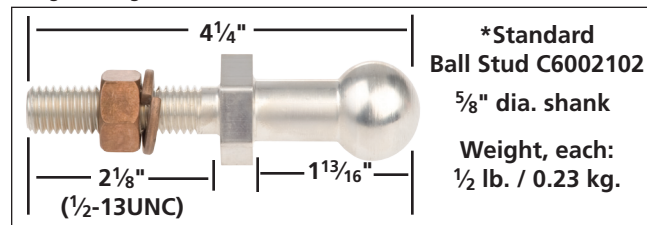

\*Standard Ball Stud C6002102  
 5/8" dia. shank  
 Weight, each: 1/2 lb. / 0.23 kg.

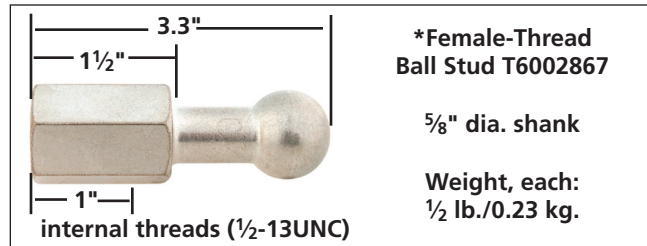

\*Female-Thread Ball Stud T6002867  
 5/8" dia. shank  
 Weight, each: 1/2 lb./0.23 kg.  
 internal threads (1/2-13UNC)

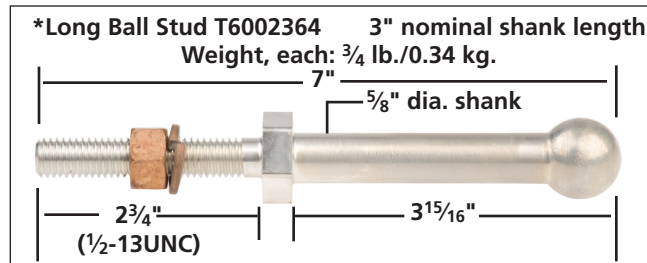

\*Long Ball Stud T6002364      3" nominal shank length  
 Weight, each: 3/4 lb./0.34 kg.

\*Ball-studs do not interchange with system on page 3014.

## Grounding Stud Cover – fits onto 1" ball-studs of Apparatus Grounding Clamps above

### Features & Applications

- Made with same material as Chance line hose
- Nonconductive cover may help prevent flashover on ball studs installed in enclosed switchgear, switchyards or substations
- Cover is not intended for personnel protection and should not be considered as insulative cover-up equipment
- Resilient ozone/corona-resistant thermo-plastic elastomer does not absorb water
- Special formulation resists aging/checking and retains high-visibility orange color
- Snap-fit keeps cover in place



- 5/8"-I.D. loop at top permits hot-line tools to "pop" it on and off
- Chance silicone lubricant C4002320 or C4170287 may ease installation and removal
- Not an insulated Cover

Catalog No.	Description	Weight
C4060416	Grounding Stud Cover	1 oz. (28 g.)



# 5H Ball/Stud Grounding System

Designed and Tested to meet requirements of ASTM F855  
Table 2 – Ultimate Assembly Rating for High X/R Ratio Applications

## Grade 5H Rated

- Rated 47kA with X/R = 30
- First cycle current peak = 126 kA
- Last cycle current peak = 70 kA
- Test duration = 15 cycles

## System components

Ball Stud Clamp which accepts 30 mm Ball Studs (including Long and Short Ball Studs with 5/8-11 UNC threads or Short Ball Stud with 5/8-11 female threads) to meet demands of these higher electromechanical forces. All components must be used with like ground clamps and 4/0 grounding cable to maintain the 5H Rating for grounding in substations.



**Short Ball Stud**  
30 mm Ball  
5/8-11 UNC Threads  
Catalog No. PSC6003491



**Long Ball Stud**  
30 mm Ball  
5/8-11 UNC Threads  
Catalog No. PSC6003492



**Short Ball Stud**  
30 mm Ball  
5/8-11 UNC Female Threads  
Catalog No. PSC6003493



**30 mm Ball Stud Cover**  
Catalog No. PSC4060615  
Not an insulated cover



**Ball Stud Ground Clamp**  
accepts 30 mm Ball Studs  
Grade 5H Rated  
Catalog No. PSC6003494  
Drilled for 5/8-11 UNC  
threaded ferrule



**Ball Stud Ground Clamp**  
accepts 30 mm Ball Studs  
Grade 5H Rated  
Catalog No. PSC6003507  
Tapped for 5/8-11 UNC  
threaded ferrule



**4 Hole NEMA Pad Adapter**  
with permanent short Ball Stud  
Grade 5H Rated  
Catalog No. PSC6003510

Grounding Equipment – 3000

## Three-Way Grounding Clamp for \*ball-stud, conductors, busbars



- Compact design delivers high-current rating associated with large clamps
- For grounding trucks or other equipment, \*ball stud permanently mounts on each body with furnished lockwasher, flat washer and nut
- Removable stud has recessed-hex end fitting for through-mounting versatility
- Clamp body is aluminum
- Acme-threaded eyescrew and \*ball-stud are bronze alloy
- Tin-plated ball-stud has 20mm (0.788") diameter ball, 7/8"-hex fitting and 1-1/2"-long 1/2"-13 threads to fit NEMA terminal pads
- ASTM Designation of Type I, Class A, Grade 5 is met if associated grounding-cable sets are fitted with copper ferrules as on page 3018
- IEC rating at 15 cycles of 35 kA

### Clamp Main Line Range

- Bare Conductors from #8 Sol. Cu. through 636 ACSF
- Flat Busbar through 1/4" x 1-1/4" maximum
- Ball-Stud 20mm (0.788") only

**Fault current ratings:** 43,000 amps — 15 cycles  
30,000 amps — 30 cycles

### Recommended Installing Torques:

**Eyescrew** 250 inch-pounds **\*Ball Stud** 300 inch-pounds

Catalog No.	Description	Weight, each
C6002316	Three-Way Clamp Body only	1½ lb./0.68 kg.
C6002317	*20mm (0.788") diameter Ball Stud with flat washer, lockwasher and nut	¾ lb./0.2 kg.

\*Ball-stud does not interchange with system on page 3013.

### Features & Applications

- By supporting other clamps in three-phase sets, ball studs reduce installation labor
- This can contribute to safety and minimize the number of clamp connections per conductor in an overhead grounding scheme
- \*Ball-studs mount without furnished washers in holes of lower clamp boss
- The tapped holes ship with plastic plugs
- Clamp terminal is tapped for 5/8"-11 UNC threaded-stud ferrules on grounding cable from #2 through 4/0
- Versatile clamp serves such temporary-grounding uses as:
  - o A truck-grounding system
  - o On industrial metalclad switchgear
  - o Substation buswork, indoors and out
  - o Overhead, underground and substation switches
  - o Three-phase ground sets with special, multi-angle \*ball studs

## Penetrator clamps and sets for underground cable

### Features & Applications

- To be used to confirm URD cable is de energized prior to cutting. After Circuit has been grounded at the Pad Mounted Switch, the ground set with the penetrator clamp may be used as a last check to confirm the cable that will be worked on is de energized.
- Cable with jacket over concentric neutral, special clamps help ensure contact with center conductor
- Chisel-point clamp main-line capacity is 1-1/2"
- Spike-point clamp main-line capacity is 2-1/2"
- Screw-type copper-clad ground rod in sets indicated is 24" long for easy handling
- Helix (spiral) and handle are bronze
- Each set includes:
  - o 6-ft. of #2 copper clear-jacket ground cable and ferrules
  - o A penetrator clamp (choice of hardened-steel 1/2"-wide chisel or conical spike)
  - o C-type grounding clamp

Catalog No.	Description	Weight, each
C6001626	Chisel Clamp <b>only</b>	1¾ lb./0.8 kg.
P6001623P	Replacement Chisel Point	2 oz./0.09 kg.
T6002234	Chisel Set <b>with</b> Ground Rod	9¾ lb./4.4 kg.
C6001625	Chisel Set <b>without</b> Ground Rod	4½ lb./2 kg.
T6001922	Spiked Clamp <b>only</b>	1¾ lb./0.8 kg.
P6001969P	Replacement Spike Point	2 oz./0.09 kg.
T6002233	Spiked Set <b>with</b> Ground Rod	8 lb./3.6 kg.

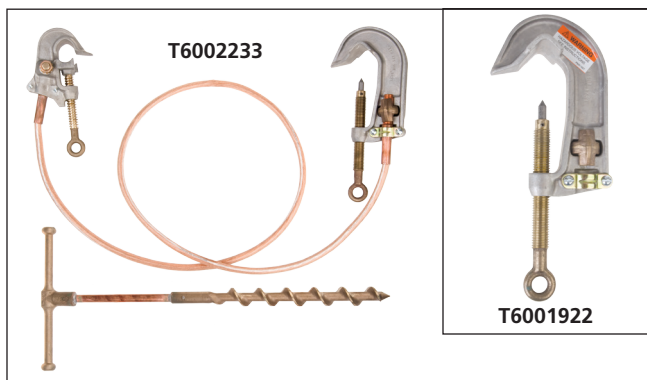

Grounding Equipment – 3000

## Underground Distribution Grounding Sets

### Grounded Parking Bushing Sets for Single- or Three-Phase Switches & Transformers

- Set includes a loadbreak bushing and bronze ground clamp T6000466 connected by a 4' yellow 1/0 cable
- Tin-plated copper connector joins cable to bushing
- Threaded copper ferrule connects the cable to the clamp
- Fault current rating for each set: 10,000 amps for 10 cycles per IEEE 386

Catalog No.	*Application	Weight, each
T6003091	15kV	8 lb. / 3.6 kg.
T6003092	25 & 35kV small interface	9 lb. / 4.09 kg.

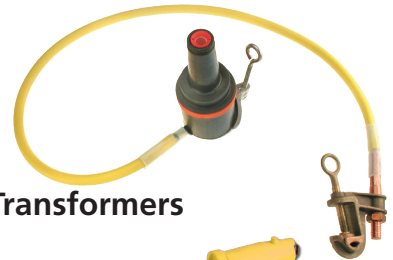

### Grounding Elbow Sets for Single- or Three-Phase Switches & Transformers

- Set includes:
  - Yellow-jacketed elbow for the voltage-class indicated below
  - Six feet of 1/0 copper grounding cable with yellow jacket
  - Bronze ground clamp T6000466
- Fault current rating for each set: 10,000 amps for 10 cycles per IEEE 386

C6000729	15kV set	4 lb./1.80 kg.
T6002131	25 & 35kV small interface set	6 lb./2.7 kg.
C6001927	35 kV large interface set	8 lb./3.63 kg.

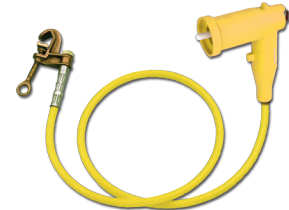

### Three-Phase Grounding Elbow Sets for Switches & Transformers

- Each of these sets consists of:
  - A three-way terminal block assembly
  - Three 6' lengths of 1/0 copper ground cable with yellow jacket
  - A bronze ground clamp T6000466
  - Three yellow elbows
- Fault current rating for each set: 10,000 amps for 10 cycles per IEEE 386

C6003102	15kV set	14.5 lb./6.5 kg.
C6003103	25 & 35kV small interface set	15 lb./6.75 kg.
PSC6003103003	35kV large interface set	16 lb./7.25 kg.



### Replacement Parts: Grounding Elbow ONLY

215GEHSG	15kV - elbow only	1.9 lb./0.88 kg.
225GEHSG	25 & 35kV small interface - elbow only	2.0 lb./0.9 kg.
235GEHSG	35kV large interface - elbow only	4.0 lb./1.8 kg.

### All Copper Connector ONLY

235LUGC6	for 1/0 Grounding Cable	1.8 oz./40 g.
235LUGC7	for 2/0 Grounding Cable	1.8 oz./40 g.

### Elbow Probes ONLY

215LBP	15 kV Probe	5.3 oz./150.3 g.
225LBP	25 kV Probe	7.0 oz./198.4 g.
236LBP	35 kV Probe	1.0 lb./0.45 kg.



### Temporary Grounding Sets for Live-Front Switches and Transformers

C6000758	C-Clamp Set	15 lb./6.8 kg.
----------	-------------	----------------

**Fault current ratings:** 21,000 amps for 15 cycles or 15,000 amps for 30 cycles

C-clamps are Cat. No. T600-0466.

- Each C-Clamp set includes:
  - A three-way aluminum terminal block
  - Four bronze ground clamps
  - Three 6' lengths of 1/0 copper clear-jacket ground cable with threaded-stud ferrules

T6002246	Ball Socket Set	16.5 lb./7.4 kg.
----------	-----------------	------------------

**Fault current ratings:** 27,000 amps for 15 cycles or 20,000 amps for 30 cycles

- Each Ball-Stud set includes:
  - A three-way copper terminal block
  - Four bronze ground clamps
  - Three 6' lengths of 2/0 copper clear-jacket ground cable with threaded-stud ferrules

T6002375	Flat-Face Clamp Set	15.5 lb./7 kg.
----------	---------------------	----------------

**Fault current ratings:** 21,000 amps for 15 cycles or 15,000 amps for 30 cycles

Each set Includes:

- A four-way bronze terminal block
- One 6' and three 4' lengths of 1/0 copper clear-jacket ground cable with shrouded plain-plug copper ferrules
- Three aluminum ground clamps with bronze eyescrews (G33633SJ)
- One with bronze T-handle (G3363-4SJ)

\*For storage bag T6000865, see page 3021.

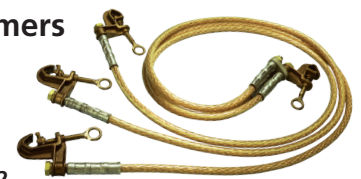

C6000758  
ASTM Type I,  
Class A, Grade 2

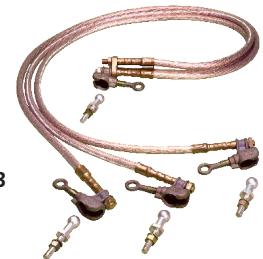

T6002246  
ASTM Type I,  
Class A, Grade 3



T6002375  
ASTM Type III,  
Class B, Grade 2



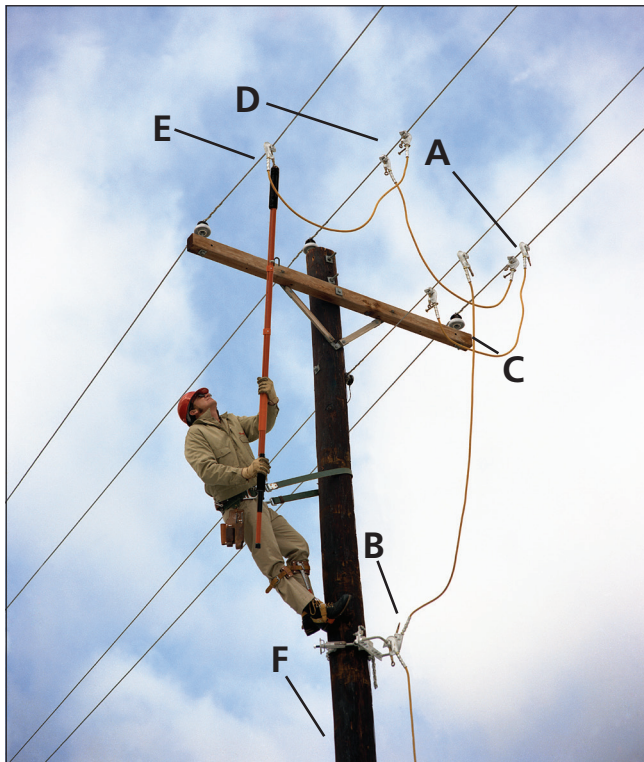

Chance grounding clamps, ferrules and cable meet ASTM F 855.

## Overhead Distribution Grounding Sets with Pressure-Type Terminals

### Features & Applications

- These complete sets of ground clamps, cable and accessories
- All equipment needed for many types of distribution structures in easy-to-use kits Ferrules are factory crimped to the grounding cable
- Each kit comes with C6002276 clamps
- Can be used on conductors ranging from #8 to 1033 kcmil ACSR

These kits were designed for use on the following types of structures:

- 7.2/12.5 kV ..... A1 through C24
- 14.4/24.9 kV ..... VA1 through VC9-3
- 46 kV ..... TP1 through TP5
- 69 kV ..... TS1 through TS3-2

The tables below list the components **completely assembled** in each of the Distribution Grounding Sets.

### #2 Grounding Cable Set\* (44 lb./20 kg.) Catalog No. T6000641 consists of:

Item	Description	Quantity	Information
A	Serrated jaw, "C" Clamp Cat. No. C6002276	10	For Plain Plug ferrules
B	Ground Cluster Support	1	Cat. No. T6001549
C	#2 Copper Ground Cable Cat. No. S6449	60 ft.	3 Cables 6 ft. long 1 Cable 12 ft. long 1 Cable 30 ft. long
D	#2 Plain Plug Ferrules	10	Cat. No. C6002626
E	Clamp Support Stud	3	Cat. No. G3626
F	Screw Ground Rod	1	Cat. No. G3370

### 1/0 Grounding Cable Set\* (58 lb./26 kg.) Catalog No. T6003094 consists of:

Item	Description	Quantity	Information
A	Serrated jaw, "C" Clamp Cat. No. C6002276	10	For Plain Plug ferrules
B	Ground Cluster Support	1	Cat. No. T6001549
C	1/0 Copper Ground Cable Cat. No. S7568	60 ft.	3 Cables 6 ft. long 1 Cable 12 ft. long 1 Cable 30 ft. long
D	1/0 Plain Plug Ferrules	10	Cat. No. C6002627
E	Clamp Support Stud	3	Cat. No. G3626
F	Screw Ground Rod	1	Cat. No. G3370

### 2/0 Grounding Cable Set\* (60 lb./27 kg.) Catalog No. T6003095 consists of:

Item	Description	Quantity	Information
A	Serrated jaw, "C" Clamp Cat. No. C6002276	10	For Plain Plug ferrules
B	Ground Cluster Support	1	Cat. No. T6001549
C	2/0 Copper Ground Cable Cat. No. S6450	60 ft.	3 Cables 6 ft. long 1 Cable 12 ft. long 1 Cable 30 ft. long
D	2/0 Plain Plug Ferrules	10	Cat. No. C6002628
E	Clamp Support Stud	3	Cat. No. G3626
F	Screw Ground Rod	1	Cat. No. G3370

### 4/0 Grounding Cable Set\* (77 lb./35 kg.) Catalog No. T6003096 consists of:

Item	Description	Quantity	Information
A	Serrated jaw, "C" Clamp Cat. No. C6002276	10	For Plain Plug ferrules
B	Ground Cluster Support	1	Cat. No. T6001549
C	4/0 Copper Ground Cable Cat. No. S6451	60 ft.	3 Cables 6 ft. long 1 Cable 12 ft. long 1 Cable 30 ft. long
D	4/0 Plain Plug Ferrules	10	Cat. No. C6002629
E	Clamp Support Stud	3	Cat. No. G3626
F	Screw Ground Rod	1	Cat. No. G3370

\*For storage bag T600-0865, see page 3021.

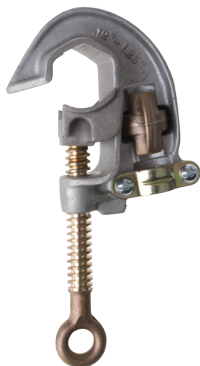

C6002276

Main Line Range

Maximum	1033 kcmil ACSR (1.25")
Minimum	#8 Solid Copper (0.128")



G3626



G3370



T6001549



**Typical C-clamp Set  
Grade 5H per ASTM F855\***

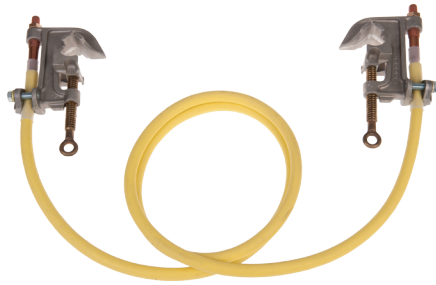

Two T6000658 C clamps  
Two C6002625 shrouded ferrules  
for 4/0 copper cable  
P6001593P shrink tube  
4/0 Copper Cable S6119  
Grade 5H Label

**Typical Duckbill clamp Set  
Grade 5H per ASTM F855\***



Two C6000197 duckbill clamps  
Two C6002625 shrouded ferrules  
for 4/0 copper cable  
P6001593P shrink tube  
4/0 Copper Cable S6119  
Grade 5H Label

**Typical Set with C and Flat-Face clamps  
Grade 5H per ASTM F855\***



One C6001783 flat-face clamp  
One T6000658 C clamp  
Two C6002625 shrouded ferrules  
for 4/0 copper cable  
P6001593P shrink tube  
4/0 Copper Cable S6119  
Grade 5H Label

**Typical Set with C and Tower Flat-Face clamps  
Grade 5H per ASTM F855\***

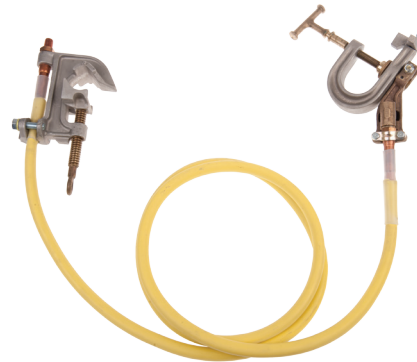

One C6000085 tower flat-face clamp  
One T6000658 C clamp  
Two C6002625 shrouded ferrules  
for 4/0 copper cable  
One C6001584 threaded terminal adapter  
P6001593P shrink tube  
4/0 Copper Cable S6119  
Grade 5H Label

**Typical Bus Bar Set with C clamps  
Grade 5H per ASTM F855\***

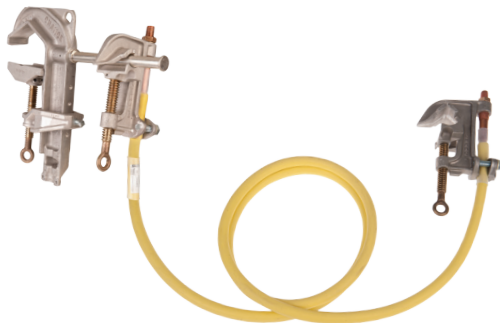

One T6000819 bus bar clamp with stud  
Two T6000658 C clamps  
Two C6002625 shrouded ferrules for 4/0 copper cable  
P6001593P shrink tube  
4/0 Copper Cable S6119  
Grade 5H Label

**Ultimate Assembly Rating for High X/R Ratio Applications**  
\*Excerpted from ASTM Standard F855, Table 2

High Asymmetrical Test Requirements

Grade	Size	Rating Rated Current(kA)	X/R = 30	Last Cycle Current Peak (kA)	Test Duration (cycles)
			1st Cycle Current Peak (kA) X 2.69		
5H	4/0	47	126	70	15

1. The above current values are based on electromechanical test values.
2. Assemblies that have been subjected to these shall not be re-used.
3. For use with currents exceeding 20% asymmetry factor.
4. See X4.7.2 in ASTM Standard F855 for additional information.
5. Alternate testing circuits are available for laboratories that cannot achieve the above requirements.  
See ASTM Standard F855 Appendix X4 for details.

## Cutout Grounding Clamps

### Features & Applications

- Bronze clamp used to ground bottom hinge contact on cutouts used on distribution riser poles or where grounding is required
- Fits these cutouts:
  - Chance F2, F3, and C Cutouts
  - Westinghouse LDX, Southern States B-80
  - Southern States Series 63
  - Joslyn; S&C Type SX
  - McGraw-Edison LMO, and GE Durabute
- Clamp can be installed with or without grounding cable
- Serves as a warning and helps avoid accidental closing of cutout
- Clamp's drilled terminal accepts threaded-stud cable ferrules
- Also accepts threaded L-Stud and T-Stud Terminals (3/4" diameter bronze) for use with conventional ground-clamp cable sets
- Fault Current rating: 20,000 amps for 30 cycles

Catalog No.	Description	Weight, each
C6000785	Cutout Clamp	2.15 lb./0.98 kg.
T6002408	T-Stud Terminal	1.37 lb./0.62 kg.
C6000841	L-Stud Terminal	0.98 lb./0.44 kg.
T6002567	Cutout Clamp with T-Stud Terminal	3.4 lb./1.56 kg.
C6000862	Cutout Clamp with L-Stud Terminal	3.75 lb./1.7 kg.

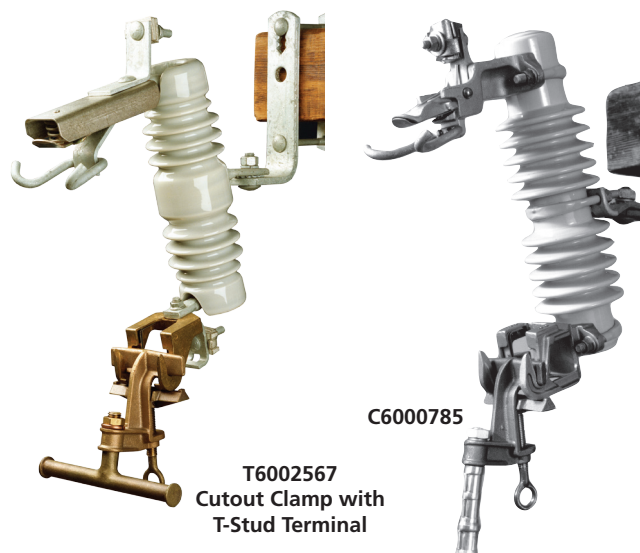

C6000785

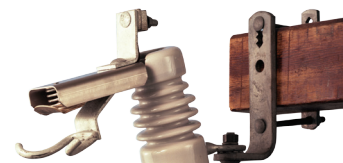
T6002567  
Cutout Clamp with  
T-Stud TerminalT6002408  
T-Stud TerminalC6000862  
Cutout Clamp with  
L-Stud TerminalC6000841  
L-Stud Terminal

## Switch Blade Grounding Clamps

### Features & Applications

- Attaches temporary ground to open switch during de-energized maintenance
- Helps keep ground lead away from energized switch jaw
- Shaped to fit blades of Chance Type M3 Disconnect switches
- Drilled terminal accepts threaded-stud ferrules on grounding cable from #2 through 4/0
- Also accepts threaded L-Stud Terminal (3/4" diameter bronze) for use with conventional ground-clamp cable sets

**ASTM Designation:** Type I, Class A, Grade 5  
**Fault Current ratings:** 30,000 amps for 30 cycles  
 43,000 amps for 15 cycles  
**with L-Stud Terminal:** 20,000 amps for 30 cycles  
**Recommended torque:** 250 inch pounds  
**Main Line Range:** 3/4" x 1/8" flat through 2 1/2" x 1/4" flat

Catalog No.	Description	Weight, each
C6002145	Plain eyescrew Switch Clamp	3 1/2 lb./1.7 kg.
C6002146	T-handle/eyescrew Clamp	3 1/2 lb./1.7 kg.
C6000841	L-Stud Terminal only	1 lb./0.5 kg.

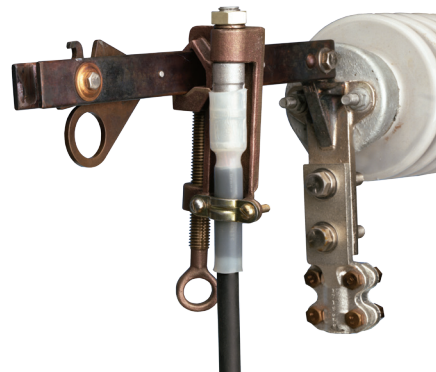
C6002145  
Plain EyescrewC6002146  
T-handle/eyescrew

# Substation Grounding Sets with Pressure-Type Terminals

## Features & Applications

- For grounding substation bus when de-energized for maintenance
- Makes workmen's job safer and easier
- Large capacity bus clamps are available in mounted versions
- Reaches any manageable height
- Increases worker's lifting capabilities
- Plastisol coated, Shepherd Hook Lift Stick, with block and rope assembly
- Reduces capacity clamps on overhead bus
- Two sizes of mounted clamps are available:
  - C6000618 has 6-5/8" bus capacity, utilizing a C6000337 ground clamp mounted on 1-1/4" x 9 ft. Epoxiglas® Pole
  - C6000619 has 4" bus capacity, utilizing a G3369 ground clamp mounted on 1-1/4" x 8'10" Epoxiglas® Pole
- Cables, ferrules and small grounding clamps should be ordered separately

### Accessories

- C6000617 — Lift Hook Assembly, 1 1/4" x 8'8" Epoxiglas® pole, includes block and rope assembly.
- C6000620 — 1 1/4" x 12' Extension Pole (middle section).
- C6000621 — 1 1/4" x 8' Bottom Pole.

Catalog Number	C6000618	C6000619
<b>ELECTRICAL RATINGS</b>		
Continuous Current (AMPS)	400	400
Fault Current - 15 Cycles (AMPS)	43,000	43,000
Fault Current - 30 Cycles (AMPS)	30,000	30,000
<b>MECHANICAL RATINGS</b>		
Recommended Torque (in.-lb.)	250	250
Main Line Range - Max.	6 5/8" Angles	4 1/2" Angles
Main Line Range - Min.	4 1/2" Round Bus	1/0 Str. Copper (0.368")
Jumper Range - Max.	4/0 Grd. Cable w/Plain Plug	4/0 Grd. Cable w/Plain Plug
Jumper Range - Min.	#2 Grd. Cable w/Plain Plug	#2 Grd. Cable w/Plain Plug
Weight Each	10 lb./4.5 kg.	9 1/4 lb./4.2 kg.
ASTM Designation	Type II Class A Grade 5	Type II Class A Grade 5

## Electro-Static Precipitator Grounding Tool Set

### Simple Safety Procedures

- Drains off static charges that remain on collector plates after electrostatic-precipitator pollution-control equipment is de-energized
- When electrical system of precipitator is de-energized:
  - First, secure the tool's grounding clamp to a known ground
  - Next, use insulated handle to bring the Copper hook in contact with the precipitator collector plates
  - Contact hook hangs from collector plates (with the grounding clamp still attached to ground) while service is performed on precipitator
  - When maintenance is completed, use insulated handle to remove contact hook from collector plates
  - Finally, remove the ground clamp before re-energizing the precipitator

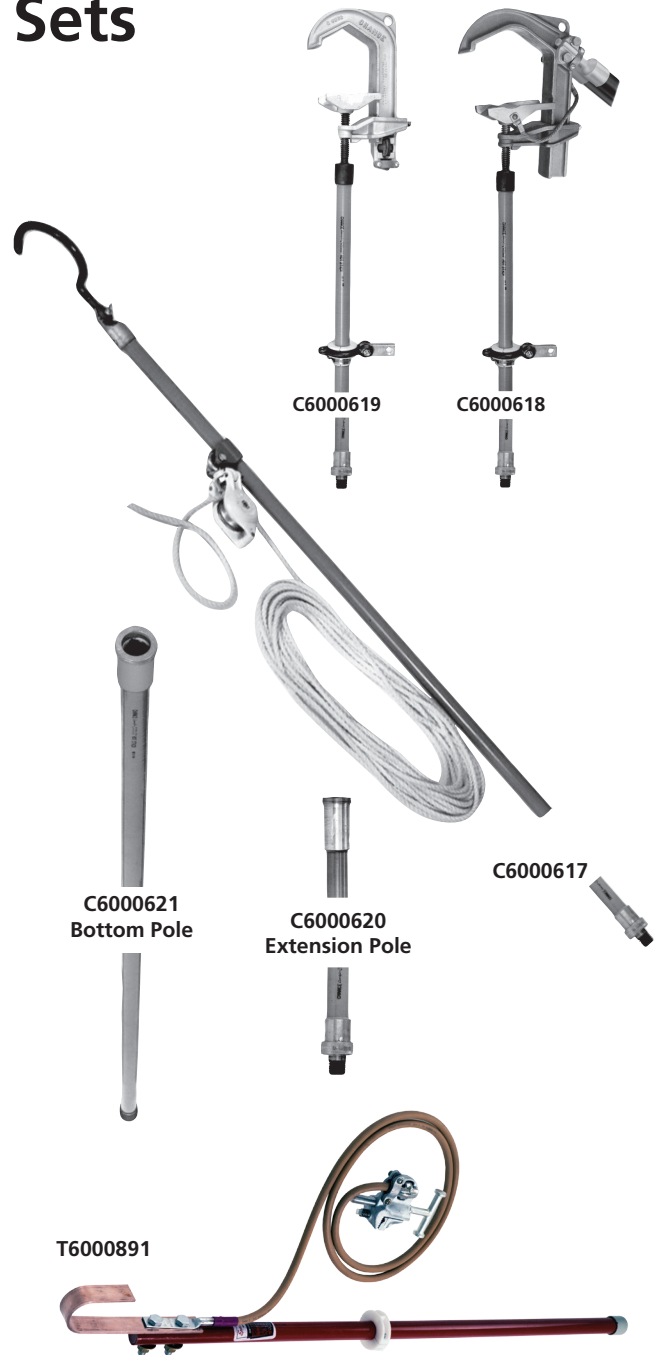

- Epoxiglas® handle (42" x 1-1/4") meets OSHA electrical requirements
- Gives operator sufficient added reach needed to make contacts
- Contact hook of 98%-conductive Copper is double-bolted to handle
- T-handle aluminum grounding clamp with serrated flat-face jaw ensures proper bonding
- Jaws open to 1-1/2" for attachment to grounded structural angles, flats or rods
- Extra-flexible (1638 strands) Copper grounding cable, 7 ft., with clear jacket fitted with copper terminal at each end gives high current-carrying capability

Catalog No.	Description	Weight, each
T6000891	Electrostatic Grounding Set	7 lb./3.2 kg.

# Grounding Ferrules

## Selection Criteria

- Shrouded ferrules overlap onto the grounding cable jacket for stress relief to the terminal. Two crimps secure the ferrule against the bare strands and one crimp applies on the jacket
- Unshrouded ferrules are available with shrink tubing that overlaps the bare cable conductor and jacket for stress relief
- Available either factory-installed in pairs on any cable length specified or as separate individual units, the ferrules install simply with a hydraulic crimping tool. Complete illustrated installation instructions come with the ferrules and include a table for the crimping die sizes to use

See ordering tables for crimping-die sizes applicable.

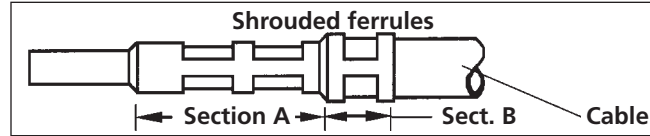
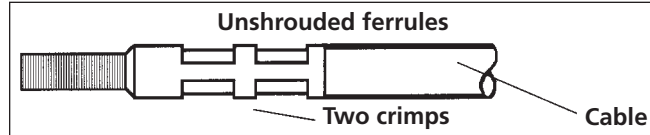

## Copper ferrules

### Plain-plug type for pressure-type grounding-clamp terminals

#### Shrouded plain copper ferrules

1 unit each, not installed Catalog No.	Burndy Die No.† or equivalent		Cable Size, AWG
	Sept. A	Sept. B	
C6002630	U165	U166	#2
C6002631	U165	U168	"1/0"
C6002632	U165	U-L	"2/0"
C6002633	U166	U-L	"4/0"

#### Unshrouded plain copper ferrules

1 unit each, not installed Catalog No.	Burndy Die No.† or equivalent	Cable Size, AWG
C6002614	U165	#2
C6002615	U165	"1/0"
C6002616	U165	"2/0"
C6002617	U166	"4/0"

### Threaded-stud type for tapped or drilled grounding-clamp terminals

#### Shrouded threaded copper ferrules

C6002622	U165	U166	#2
C6002623	U165	U168	"1/0"
C6002624	U165	U-L	"2/0"
C6002625	U166	U-L	"4/0"

#### Unshrouded threaded copper ferrules

C6002606	U165	#2
C6002607	U165	"1/0"
C6002608	U165	"2/0"
C6002609	U166	"4/0"

## Tin-Plated Copper ferrules

### Plain-plug type for pressure-type grounding-clamp terminals

#### Shrouded plain tin-plated copper ferrules

C6003119	U165	U166	#2
C6003120	U165	U168	"1/0"
C6003121	U165	U-L	"2/0"
C6003122	U166	U-L	"4/0"

#### Unshrouded plain tin-plated copper ferrules

C6003111	U165	#2
C6003112	U165	"1/0"
C6003113	U165	"2/0"
C6003114	U166	"4/0"

### Threaded-stud type for tapped or drilled grounding-clamp terminals

#### Shrouded threaded tin-plated copper ferrules

C6003115	U165	U166	#2
C6003116	U165	U168	"1/0"
C6003117	U165	U-L	"2/0"
C6003118	U166	U-L	"4/0"

#### Unshrouded threaded tin-plated copper ferrules

C6003107	U165	#2
C6003108	U165	"1/0"
C6003109	U165	"2/0"
C6003110	U166	"4/0"

†Anderson die-less **VERSA-CRIMP™** compression tools require no dies and are capable of making these crimped connections. If using another crimp tool brand, contact that manufacturer for Burndy die equivalents.

# Copper Grounding Cable

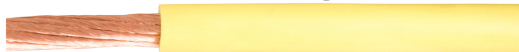

- Extra-flexible for handling ease yet strong and tough for long wear
- Jacketing is smooth, abrasion, weather and oil resistant
- In accordance with applicable ASTM Specifications, marked with AWG size approximately every 4 feet
- Yellow and black jackets are T-prene rubber compound with -20°F recommended low temperature
- Clear jackets (which allow visual inspection of strand conditions) are ultraviolet-inhibited Poly Vinyl Chloride (PVC)
- Recommended low temperature for PVC-jacketed cable is 0°F
- Extra-flexible cables, because of their extra-fine strands
- Require termination ferrules when used with ground clamps

Either aluminum or copper ferrules may be used with copper cable.

Catalog Number	Size AWG	Strands*	Diameter (Inches)	Approx. O.D. (Inches)	Approx. Wt. (lb./1,000 ft.)
----------------	----------	----------	-------------------	-----------------------	-----------------------------

#### Yellow-Jacket Copper Cable

S6116	#2	665	0.32	0.55	280
S6117	"1/0"	1045	0.41	0.66	425
S6118	"2/0"	1330	0.47	0.73	520
S6119	"4/0"	2109	0.59	0.87	760

#### Clear-Jacket Copper Cable

S6449	#2	665	0.344	0.53	289
S7568	"1/0"	1050	0.445	0.63	520
S6450	"2/0"	1323	0.487	0.70	546
S6451	"4/0"	2107	0.616	0.84	841

#### Black-Jacket Copper Cable

S3713	#2	665	0.32	0.55	280
S3715	"1/0"	1045	0.41	0.66	425
S3712	"2/0"	1330	0.47	0.73	510
S3714	"4/0"	2109	0.59	0.87	760

\*Varies with manufacturer.



## Aluminum ferrules

### Plain-plug type for pressure-type grounding-clamp terminals

#### Shrouded plain aluminum ferrules

1 unit each, not installed Catalog No.	Burndy Die No. <sup>†</sup> or equivalent		Cable Size, AWG
	Sect. A	Sect. B	
C6002626	U165	U166	#2
C6002627	U165	U168	1/0
C6002628	U165	U-L	2/0
C6002629	U249	U-L	4/0

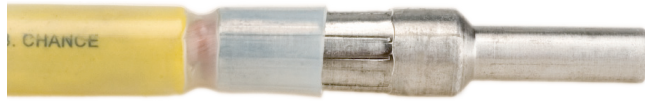

Factory-cripped, above



#### Unshrouded plain aluminum ferrules

1 unit each, not installed Catalog No.	Burndy Die No. <sup>†</sup> or equivalent	Cable Size, AWG
C6002610	U165	#2
C6002611	U165	1/0
C6002612	U165	2/0
C6002613	U249	4/0

<sup>†</sup>Anderson die-less VERSA-CRIMP® compression tools require no dies and are capable of making these crimped connections. If using another crimp tool brand, contact that manufacturer for Burndy die equivalents.

### Threaded-stud type for tapped or drilled grounding-clamp terminals

#### Shrouded threaded aluminum ferrules

1 unit each, not installed Catalog No.	Burndy Die No. <sup>†</sup> or equivalent		Cable Size, AWG
	Sect. A	Sect. B	
C6002618	U165	U166	#2
C6002619	U165	U168	1/0
C6002620	U165	U-L	2/0
C6002621	U249	U-L	4/0



Factory-cripped, above



#### Unshrouded threaded aluminum ferrules

1 unit each, not installed Catalog No.	Burndy Die No. <sup>†</sup> or equivalent	Cable Size, AWG
C6002602	U165	#2
C6002603	U165	1/0
C6002604	U165	2/0
C6002605	U249	4/0

<sup>†</sup>Anderson die-less VERSA-CRIMP® compression tools require no dies and are capable of making these crimped connections. If using another crimp tool brand, contact that manufacturer for Burndy die equivalents.

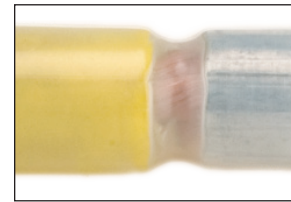

#### Features & Applications

- Visual inspection of cable condition through clear heat-shrink tube determines breakage or corrosion that otherwise requires continuity test
- Factory-assembled units expose 1/2" of cable strands at junction point

#### Shrink tubing for plain ferrules

##### Features & Applications

- Clear heat-shrink tubes limit corrosion
- Excludes moisture
- Stress-relief for cable jacket and ferrule-to-stranding connection

Part No.	Lengths
P6001593P	5"
P6001982P	7"
P6002069P	9"

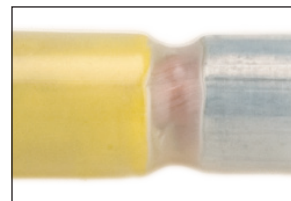

- Visual inspection of cable condition through clear heat-shrink tube allows inspection for breakage or corrosion that otherwise requires continuity test
- Factory-assembled units expose 1/2" of cable strands at junction point

#### Shrink tubing for threaded ferrules

##### Features & Applications

- Clear heat-shrink tubes limit corrosion
- Excludes moisture
- Stress-relief for cable jacket and ferrule-to-stranding connection

Part No.	Lengths
P6001593P	5"
P6001982P	7"
P6002069P	9"

# Conversion Terminals

## Features & Applications

- Threaded-terminal adapters for pressure-type grounding-clamp terminals
- Simply retrofit bolt-on adapters to convert clamps with pressure-type terminals to accept 5/8-11 UNC threaded ferrules

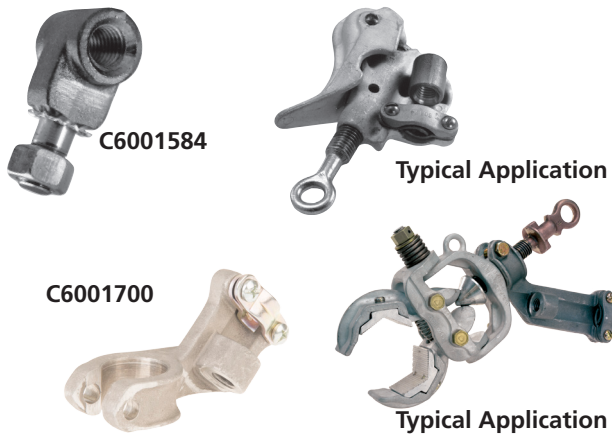

Catalog Number	Clamp Applications
C6001584 "eyebolt" style, includes shakeproof washer and nut	C Type, Snap-On Flat-Face
C6001700 includes steel retainer straps for cable	All-Angle Clamps

## Storage Bag for Temporary Grounding Clamps-and-Cable Sets



## Features & Applications

- Easy-to-see, bright-yellow protective bag
- Made of double vinyl-laminated open-weave nylon cloth
- Lightweight and durable with nylon stitching throughout
- Full-separating closure constructed with heavy-duty snaps
- Heavy webbing handles
- 18" L x 12" W x 15" D

Catalog No.	Description	Weight
T6000865	Grounding Storage Bag	3 lb.

## Support Studs

### Features & Applications

- Can be installed on most Ground Clamps
- Replaces restraining strap immediately below terminal
- Serves as a mechanical parking stand for a second clamp
- Helps prevent "parked" clamp from making contact with conductor or ground
- Particularly beneficial in three-phase grounding applications

Catalog No.	Description	Size of Stud	Weight
G3626	Stud for Rear Mount	7/16" x 2 1/2"	1/2 lb./2 kg.
G3627	Stud for Side Mount	7/16" x 3"	3/4 lb./3 kg.

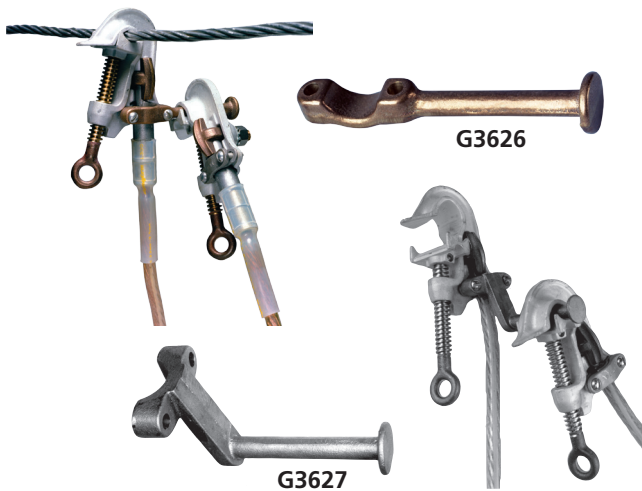

## Dielectric Compound No. 7

Dielectric Compound No. 7, a silicone base material, is made for use with load break disconnects and other electrical connecting and terminating devices.

Cat. No. C4170287..... 2 oz. Tube

Grounding Equipment - 3000

## Cable Splice

for cables with plain-plug ferrules

### Features & Applications

- Use for splicing grounding cable when extensions are required
- Thumb screw makes attachment easy

Splice fits #2 through 4/0 grounding cable with plain ferrules

Catalog No.	Description	Weight
T6000252	Grounding Cable Splice	1½ lb./0.7 kg.

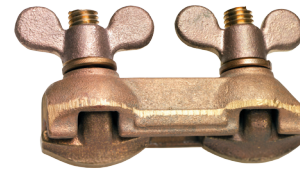

T6000252

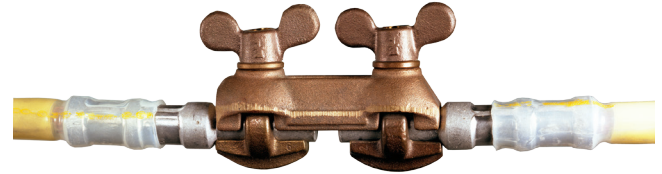

## Terminal Blocks, 4-Way

for cables with plain-plug ferrules and threaded ferrules

### Features & Applications

- Attach ground leads from grounding clamps to a common ground
- Accommodates 4/0 grounding cables

Catalog No.	Description	Weight
G47541	4-Way Terminal Blocks for Plain Plug Ferrules	2 lb./0.9 kg.
T6001964	4-Way Terminal Blocks for Threaded Ferrules	1 lb./0.45 kg.

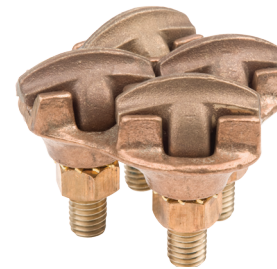

G47541  
for four  
plain plug ferrules



T6001964  
for four 5/8-11 UNC  
threaded ferrules

## Cluster Support, 1-terminal type

### Features & Applications

- Hangs grounding sets on the pole to facilitate lifting clamps—one at a time to the conductors
- Accepts plain ferrules on #2 to 4/0 grounding cable
- Copper bar length is 11"

Catalog No.	Description	Weight
C6000152	Ground Cluster Support	9½ lb./4.3 kg.

\*C6000152A includes lag screw for penetrating pole

\*C6000152AR retrofit kit to add lag screw and braid

C6000152



## Cluster Bars

for wood, steel and concrete poles and tower angles

### Features & Applications

- Compact 5" aluminum-alloy bar (5/8" dia.) accepts C-type or duckbill clamps
- For phase-to-phase grounding technique
- Adjustable wheel binder and 36" chain for pole applications
- Hook style for attachment to tower angles

Catalog No.	Description	Weight
T6001549	Pole-Mount Grounding Cluster Bar	7½ lb./4.09 kg.
T6001737	Tower-Mount Grounding Cluster Bar	9 lb./4.09 kg.

\*T6001549A includes piercing screw for penetrating pole

\*T6001549AR retrofit kit to add piercing screw



T6001549



T6001549  
for poles only



T6001737  
(For tower angles only)



## Storage Reel for Grounding Cable



Cable Size	Reel Capacity
#2	225 ft.
1/0	185 ft.
2/0	145 ft.
4/0	100 ft.

### Features & Applications

- Hole in outer flange for cable to feed through
- Rewind handle has galvanized-pipe extension for temporarily parking clamps
- Portable reel quickly pays-out/takes-up,
- Helps keep ground sets clean and neat, ready for use
- Handles are comfortable, turned aluminum
- Lightweight unit can be carried to remote sites
- Tubular-steel frame can be U-bolted to deck of truck
- Galvanized drum has ribbed flanges to resist flexing and beaded rims to eliminate sharp edges
- Reel is for storage only
- Cable and clamps should be removed completely from reel before use
- Failure to do so could result in a dangerous voltage drop and violent mechanical reactions
- A label on the unit gives this warning

Catalog No.	Description	Weight
C4176086	Portable Cable Reel	18 lb./8 kg.

## Temporary Ground Rod

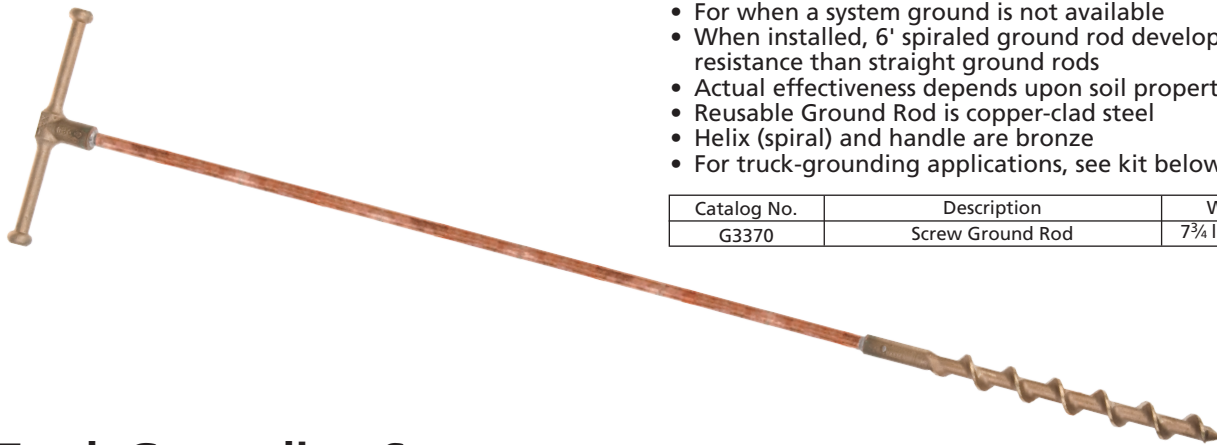

### Features & Applications

- Screw Ground Rod provides a temporary ground
- For when a system ground is not available
- When installed, 6' spiraled ground rod develops less resistance than straight ground rods
- Actual effectiveness depends upon soil properties
- Reusable Ground Rod is copper-clad steel
- Helix (spiral) and handle are bronze
- For truck-grounding applications, see kit below

Catalog No.	Description	Weight
G3370	Screw Ground Rod	7 <sup>3</sup> / <sub>4</sub> lb./3.5 kg.

## Truck Grounding Set



### Features & Applications

- Provides means to drain off capacitance or static charges
- For winch trucks and aerial devices
- Flat -face clamp is for secure attachment to the truck bed at an area cleaned for electrical contact
- C-type clamp is for secure attachment to ground rod
- This grounding method should not be considered adequate protection to personnel against conductor contact
- For truck-grounding with ball/socket-clamp, see page 3103

**Truck Grounding Set**  
**Catalog No. T6001971**  
**(total weight 35 lb./15.75 kg.)**  
**consists of:**

Component	Qty.	Description
Screw Ground Rod	1	Cat. No. G3370, see above
Flat Face Ground Clamp	1	Cat. No. T6001798, see page 3010
C-Type Ground Clamp	1	Cat. No. C6001754, see page 3004
#2 Copper Grounding Cable	50 ft.	Cat. No. S6116, see page 3018
*Shrouded Alum. Ferrules	2	Cat. No. C6002618, see page 3019
Storage Reel	1	Cat. No. C4176086, see above

\*Threaded ferrules are factory-installed on ends of cable.



## Truck Safety Barricade

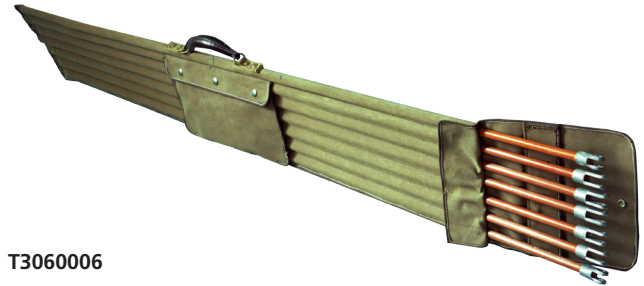

T3060006

Catalog No.	Description	Weight
T3060006	Truck Safety Barricade	21 lb./9.5 kg.

### Features & Applications

- Keeps workers and onlookers away from truck when it is being used in proximity to energized conductors
- Six rods, made of bright orange Epoxirod®, provide a 6-foot air space around the entire perimeter of the truck
- Safety barricade also includes six pieces of 3-inch long steel tubing (to be welded to truck by the customer)
- Tubing holds barricade rods, 150 feet of yellow rope and a canvas storage bag
- Entire kit requires less storage than traffic cones and can be quickly installed and removed at each job site

## Grounding Simulator Kit

### Features & Applications

- Demonstrates principles for temporary grounding practices
- Portable instructional aid provides working model of three-phase system circuit
- Powered by a step-down transformer
- Plugs into a 110-volt 60-cycle household source
- Special light/buzzer unit simulates lineworker in maintenance on de-energized line
- Insulated wires with alligator clip at each end serve as grounding cable and clamp sets (10 included)
- Miniature grounding cluster bar is included for pole mounting

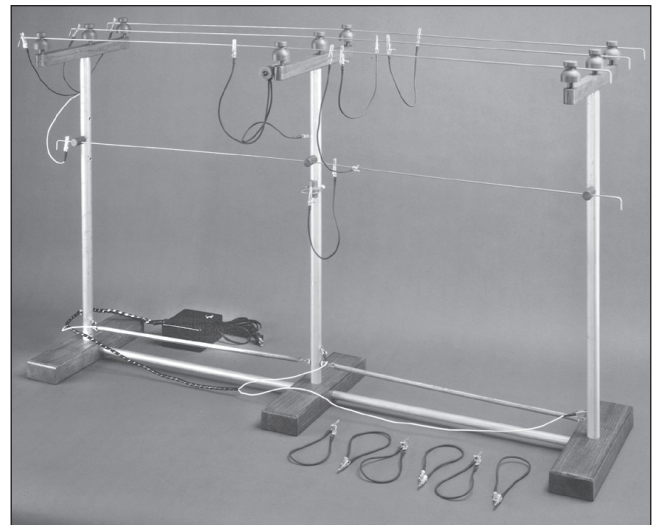
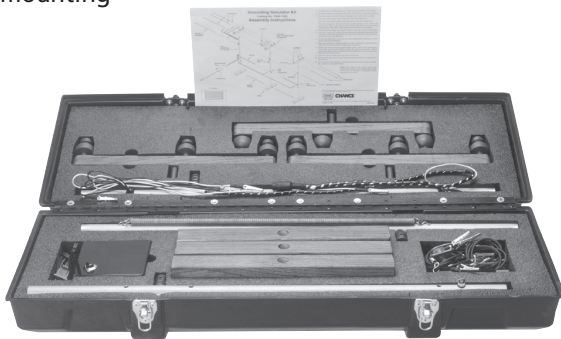

Modular design quickly sets up and takes down for storage in rugged transport case.

### Operation

- To quickly test any proposed configuration, depress transformer foot switch to energize a fault on the system
- If the light glows and the buzzer sounds on the "worker," this indicates the grounding system in place fails to provide protection
- If no such signals occur, the scheme of grounding connections does create a protective zone of equalized potential at the worksite

### Durable & Accurate

- Durable, aluminum pipe poles
- Wood crossarms
- Electrically correct, aluminum poles effect the conductivity which should be assumed for actual poles
- Leads from the poles and neutral connect to ground side on source (transformer)



### Ordering Information

Catalog No.	Description	Weight
C6001950	Grounding Simulator Kit	23 lb. / 10.5 kg.

## Standard (Orange) EQUI-MAT® Personal Protective Ground Grid

### Features & Applications

- Complies with OSHA 1910.269 for equipotential requirements near vehicles, underground gear, overhead switches and in substations
- Meets ASTM F2715 Standard

### Portable, lightweight, high performance

- An easy way to help establish an equipotential zone for a lineworker
- For standing on during various energized and de-energized work practices
- Properly applied, it accomplishes compliance with Occupational Safety and Health Administration (OSHA) 1910.269:
  - o "Equipotential Zone. Temporary protective grounds SHALL be placed at such locations and arranged in such a manner as to prevent each employee from being exposed to hazardous differences in electrical potential."
- Can be taken anywhere needed, is simple to use, maintain and store
- Consists of a high-ampacity tinned-copper-braid cable sewn in a grid pattern onto a vinyl/polyester fabric
- Cable terminals permit connecting mat's grid in series with an electrical ground and subject system component or vehicle
- Simply rinsing with water comprises all the care the mat requires
- Mat may be folded and stored in a tool bag to help keep it clean and protected
- Complete instructions are included with each unit

... continued on the next page ...

### Basic EQUI-MAT® Personal Protective Ground Grid Each Basic Unit includes a Long Ball Stud and illustrated instructions.

Catalog No.	Size	Weight
<i>Single 1/4" Perimeter Braid</i>		
PSC6003080* (Bucket)	24" x 24"	5 lb. / 2.3 kg.
C6002850	58" x 58"	8 lb. / 3.6 kg.
C6002851	58" x 120"	13 lb. / 5.9 kg.
C6002852	120" x 120"	20 lb. / 9.1 kg.

\*For use in bottom of personnel bucket of lift truck.

### Pre-Packaged Kits

Each Pre-Packaged Kit includes Ground Grid (size below with Long Ball Stud and illustrated instructions) plus Ground Set T6002841 and Storage Bag C4170147.

Kit Catalog No.	EQUI-MAT® Personal Protective Ground Grid Size	Weight per Kit
C6002989	58" x 58"	19 lb. / 8.6 kg.
C6002990	58" x 120"	27 lb. / 12.2 kg.
C6002991	120" x 120"	30 lb. / 13.6 kg.

### Accessory Items

 Long Ball Stud T6002364  
included with each Basic EQUI-MAT® Personal Protective Ground Grid (Catalog page 3013)



**Ground Set T6002841 included with Kits only**  
Consists of 6 ft. long #2 cable with ferrules applied, Ball Socket clamp (C6002100) and C-Type clamp (T6000465)



**Storage Bag C4170147 included with Kits only**  
Catalog pages 2512-13





# Standard (Orange) EQUI-MAT®

## Personal Protective Ground Grid

### Features & Applications

- Complies with OSHA 1910.269
- For equipotential requirements near vehicles, underground gear, overhead switches and in substations

### Applications

#### Padmounted Transformers and Switches

- Complies with OSHA 1910.269
- Protects workers operating and maintaining padmounted transformers and switchgear
- Proper use of EQUI-MAT Personal Protective Ground Grid in these applications creates an equipotential zone

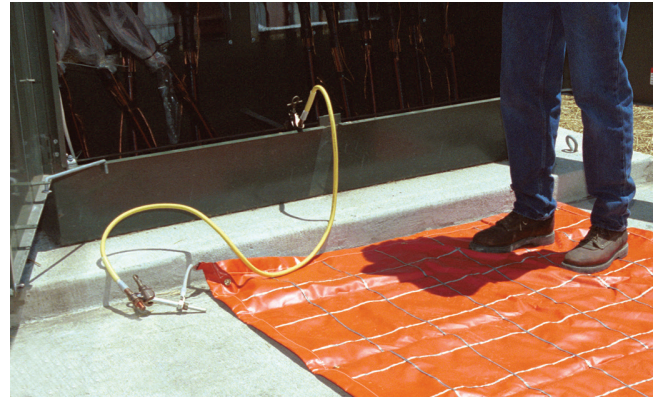

- This is the same as a cluster bar (chain binder) does in overhead grounding practices

#### Bottom of Personnel Bucket on Lift Truck

- Use only 24" x 24" Catalog No. PSC6003080

#### Mechanical Equipment (Vehicles, etc.) Grounding

- Provides compliance with OSHA 1910.269
- Protects workers around mechanical equipment which could become energized, such as utility vehicles and portable generators
- For proper application, EQUI-MAT Personal Protective Ground Grids are attached to the vehicle (for example) at locations where workers could contact the vehicle
- This extends the equipotential area around the vehicle

#### Simple to join multiples for larger areas

- Cascading (or joining together) two or more mats is easy
- Connecting tab and hardware furnished with each mat



(Left) To join mats, conductive grids simply connect at tabs with bolt, washer and nut included with each mat. Tabs have shrink tube for stress relief. (Right) Ball stud can join mats and connect to ground set clamps.

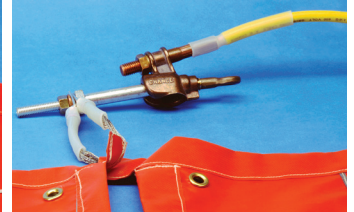

Long ball stud accepts various grounding clamps as shown below and at right: Ball/Socket, C Type and Duckbill.

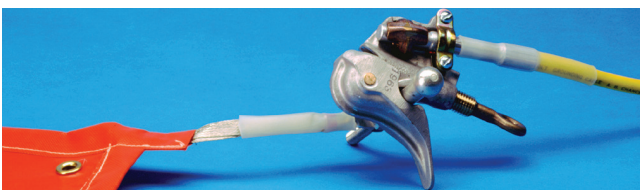

#### Overhead Distribution and Transmission Switches

- EQUI-MAT Personal Protective Ground Grid can help eliminate step and touch potential
- Connect it to the handle of an overhead switch and stand on it when opening or closing the switch

#### Line Apparatus Work

- Similar uses for installing, maintaining or operating regulators, reclosers, capacitor banks

#### Suspect Substation Grids

- If station ground mat integrity is questionable, apply the EQUI-MAT Personal Protective Ground Grid

- Connected in series, the conductive grids become one
- For larger area, place lug connector tabs of two adjacent mats on the supplied bolt or threaded shank of a ball stud and secure with supplied washer and nut

Grounding Equipment – 3000

# Slip-Resistant (Black) EQUI-MAT<sup>®</sup> Personal Protective Ground Grid

## Features & Applications

- Complies with OSHA 1910.269 for equipotential requirements near vehicles, underground gear, overhead switches and in substations
- Meets ASTM F2715 Standard

## Portable, lightweight, high performance

- An easy way to help establish an equipotential zone for a lineworker
- For standing on during various energized and de-energized work practices
- Properly applied, it accomplishes compliance with Occupational Safety and Health Administration (OSHA) 1910.269:
  - o "Equipotential Zone. Temporary protective grounds SHALL be placed at such locations and arranged in such a manner as to prevent each employee from being exposed to hazardous differences in electrical potential."
- Can be taken anywhere needed, is simple to use, maintain and store
- Consists of a high-ampacity tinned-copper-braid cable sewn in a grid pattern onto a vinyl/polyester fabric
- Cable terminals permit connecting mat's grid in series with an electrical ground and subject system component or vehicle
- Simply rinsing with water comprises all the care the mat requires
- Mat may be folded and stored in a tool bag to help keep it clean and protected
- Complete instructions are included with each unit

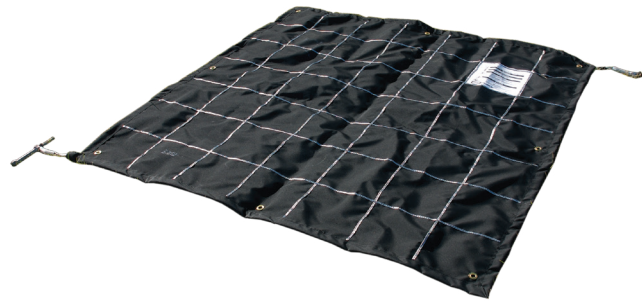

## Slip-Resistant material

- For rain, snow and ice conditions
- Napped surface offers superior footing
- For dry conditions, consider the Standard (Orange) EQUI-MAT<sup>®</sup> Personal Protective Ground Grid, available in the same sizes and kits

... continued on the next page ...

## Slip-Resistant EQUI-MAT<sup>®</sup> Personal Protective Ground Grid Each Unit includes Ground Grid, Long Ball Stud and illustrated instructions

Catalog No.	Size	Weight
<b>Single 1/4" Perimeter Braid</b>		
PSC6003345	58" x 58"	8 lb. / 3.6 kg.
PSC6003346	58" x 120"	13 lb. / 5.9 kg.
PSC6003347	120" x 120"	20 lb. / 9.1 kg.



## Pre-Packaged Slip-Resistant EQUI-MAT<sup>®</sup> Kits Each Kit includes Ground Grid (size below with Long Ball Stud and illustrated instructions) plus Ground Set T6002841 and Storage Bag C4170147

Kit Catalog No.	EQUI-MAT <sup>®</sup> Personal Protective Ground Grid Size	Weight per Kit
PSC6003348	58" x 58"	19 lb. / 8.6 kg.
PSC6003349	58" x 120"	27 lb. / 12.2 kg.
PSC6003350	120" x 120"	30 lb. / 13.6 kg.



## Accessories



**Long Ball Stud T6002364**  
included with each Basic EQUI-MAT<sup>®</sup> Personal Protective Ground Grid (Catalog page 3013)



**Ground Set T6002841** included with Kits only  
Consists of 6 ft. long #2 cable with ferrules applied, Ball Socket clamp (C6002100) and C-Type clamp (T6000465)



**Storage Bag C4170147**  
included with Kits only  
Catalog pages 2512-13



# Slip-Resistant (Black) EQUI-MAT® Personal Protective Ground Grid

## Features & Applications

- Complies with OSHA 1910.269 for equipotential requirements near vehicles, underground gear, overhead switches and in substations
- Padmounted Transformers and Switches**
- Complies with OSHA 1910.269
- Protects workers operating and maintaining pad-mounted transformers and switchgear
- Proper use of EQUI-MAT Personal Protective Ground Grid in these applications creates an equipotential zone
- This is the same as a cluster bar (chain binder) does in overhead grounding practices

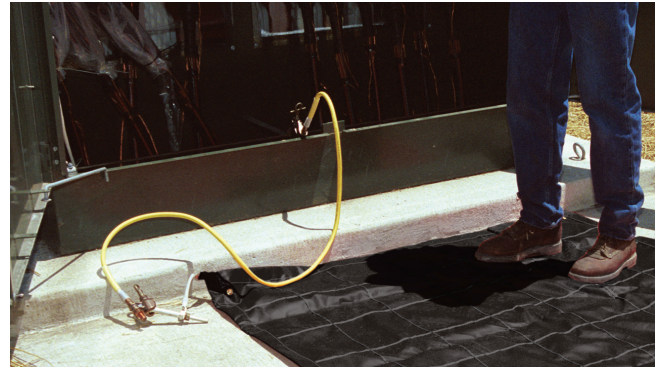

### Mechanical Equipment (Vehicles, etc.) Grounding

- Provides compliance with OSHA 1910.269
- Protects workers around mechanical equipment which could become energized, such as utility vehicles and portable generators
- For proper application, EQUI-MAT Personal Protective Ground Grids are attached to the vehicle (for example) at locations where workers could contact the vehicle
- This extends the equipotential area around the vehicle

### Overhead Distribution and Transmission Switches

- EQUI-MAT Personal Protective Ground Grid can help eliminate step and touch potential
- Connect it to the handle of an overhead switch and stand on it when opening or closing the switch

### Line Apparatus Work

- Similar uses for installing, maintaining or operating regulators, reclosers, capacitor banks

### Suspect Substation Grids

- If station ground mat integrity is questionable, apply the EQUI-MAT Personal Protective Ground Grid
- Connected in series, the conductive grids become one
- For larger area, place lug connector tabs of two adjacent mats on the supplied bolt or threaded shank of a ball stud and secure with supplied washer and nut

### Simple to join multiples for larger areas

- Cascading (or joining together) two or more mats is easy
- Connecting tab and hardware furnished with each mat

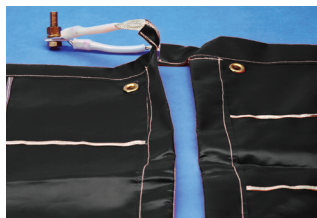

(Left) To join mats, conductive grids simply connect at tabs with bolt, washer and nut included with each mat. Tabs have shrink tube for stress relief. (Right) Ball stud can join mats and connect to ground set clamps.

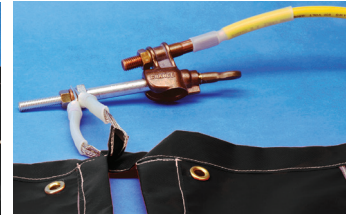

Long ball stud accepts various grounding clamps as shown below and at right: Ball/Socket, C Type and Duckbill.

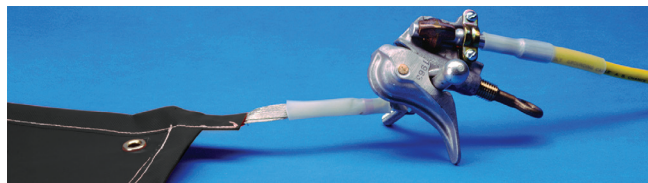

Grounding Equipment – 3000

## Rotating Ground Adapters for Reels

Tested and Meets ASTM F 855 Standard

### Applications

- Provide system protection while conductor is pulled from reels for stringing operations. By design, the system adds conductor grounding but does not replace other grounding practices.
- This includes items such as Equi-Mat<sup>®</sup> personal protective ground grids (Chance Catalog Section 3000)
- System serves as intended path to ground for static discharge and accidental energizing from downed lines, equipment contact, adjacent conductors and lightning

### Installation

- Rotating Ground Adapter slides on reel mandrel and three locking bolts secure it
- Outer collar contact connects to the end of the conductor from inside the reel
- Adapter's inner collar contact connects to a permanent or screw-in ground rod (not included, see Chance Catalog Section 3000)

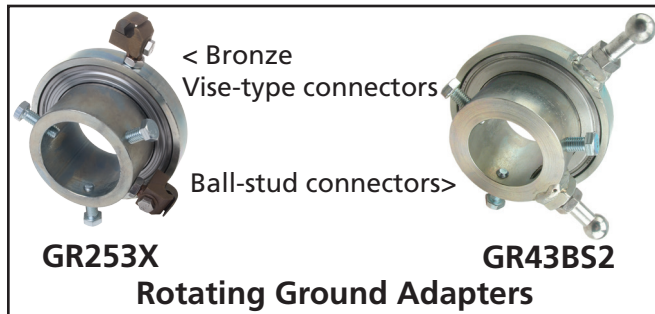

## Rotating Ground Adapters for Reels Ordering Information

Catalog No.	ASTM Grade: Fault Rating	Pipe Dia. Maximum	Connector Type	Connector Range	Weight
<b>Rotating Grounding Adapters</b>					
GR253X	ASTM Grade 1: 14kA @ 15 cycles 10kA @30 cycles	3-3/16"	Bronze Vise Type	3 Sol. to 4/0 Str.	9.8 lb. (4.4 kg.)
GR43BS2	ASTM Grade 5: 43kA @15 cycles 30kA @30 cycles	2-11/16"	Two 1"-diameter Ball Studs	See Ball Stud Clamp in Chance Cat. Section 3000	12.75 lb. (5.8 kg.)
<b>Single Reel Grounding Set</b>					
PST6003438	Grade 3: 27kA @15 cycles 20kA @30 cycles  (Ratings for this set are limited to those for the 2/0 grounding cable.)	2-11/16"	4 ea. C6001754 C-type ground clamps, 2 ea. T6002320 ball stud ground clamps, 1 ea. GR43BS2 rotating ground adapter, 6 ea. Ferrules (aluminum), 6 ea. Shrink tubes, 63 ft. S6118 yellow neoprene 2/0 cable (1 @ 50 ft., 1 @ 10 ft., 1 @ 3 ft.)		53.75 lb. (24.4 kg.)



## Appendix A - Bibliography

- [1] ANSI/IEEE 80–1986; *IEEE Guide For Safety In AC Substation Grounding*
- [2] IEEE 516–2003; *IEEE Guide for Maintenance Methods on Energized Power Lines*
- [3] IEEE 524 – 2003; *IEEE Guide to the Installation of Overhead Transmission Line Conductors*
- [4] IEEE 1048 – 2003; *IEEE Guide for Protective Grounding of Power Lines*
- [5] IEEE 1246 – 2004; *IEEE Guide for Temporary Protective Grounding Systems Used in Substations*
- [6] ASTM F855; *Standard Specifications for Temporary Protective Grounds to Be Used on De-energized Electric Power Lines and Equipment*
- [7] *Electric Power Generation, Transmission, and Distribution; Electrical Protective Equipment; Final Rule*; Department of Labor, Occupational Safety and Health Administration 29 CFR Part 1910
- [8] EPRI EL-5258, Fusing Research on Personal Grounding Cables, Final Report, July 1987
- [9] Protective Jumpering, OSHA Speaks; by Clayton C. King; Tips of the Trade; Tips & News, June 1995; Bulletin 09-9502
- [10] Ground Clamps, critical safety components; by Clayton C. King; A. B. Chance Co. 1995; Bulletin 09-9501
- [11] Grounding; Chance Tips of the Trade; by Clayton C. King; Chance Tips Vol. 51 No. 3, December 1990; bulletin 09-9001
- [12] Why Proper Grounding Is Vital For Worker Safety; by Clayton C. King; Electrical World; November 1990 (available from Hubbell Power Systems as Bulletin 9-9002GE)
- [13] Technical Considerations in Protective Grounding and Jumpering by Clayton C. King; A. B. Chance Co.; Bulletin 09-8001
- [14] *Grounding and Jumpering*; by Franklin D. Myers; A. B. Chance Co. Bulletin No. 9-8002
- [15] *Personnel Protective Grounding in Substations; Made Easy* by Chance Tips, December 1990
- [16] *Omitted from 2008 edition.*
- [17] *Placement of Protective Grounds for Safety of Linemen*, E.J. Harrington and T.M.C. Martin, AIEE Safety committee Paper 54-206, AIEE Transactions Vol. 73, Aug. 1954 p. 950-955
- [18] *Electric Shock Hazard*, Charles Dalziel, IEEE Spectrum Feb. 1972 p. 41-50
- [19] *The Effects of Electric Shock on Man, Safety and Fire Protection Bulletin*, United States Atomic Energy Commission, Office of Health & Safety, Washington D.C. (Reprinted from IRE Transaction on Medical Electronics May 1956)
- [20] *A Modern Approach to Grounding Systems*, ITT Blackburn – Data Folder 7302
- [21] *Personnel Protective Grounding*, Power System Maintenance Manual Chapter 1, Jan. 1990, Western Area Power Administration

# Appendix B - Asymmetrical Current

An asymmetrical current is one that is not initially symmetrical about the zero axis. From a de-energized circuit the initial current peaks may be significantly greater than those of the anticipated RMS steady state peak values. The offset of this current reduces to a symmetrical current in a few cycles. The problem caused by the increased offset of these peaks may result in mechanical breaking of the grounding assembly clamps because the mechanical force increases as the square of the current. That is, if the current peak doubles the mechanical force is momentarily four times as great. An additional problem is the increased heating due to the cumulative offset of the current flowing. This further reduces the melting time of the connecting cable. In earlier editions of the ASTM F855 standard the maximum asymmetry specified was 20%, determined to be a maximum  $X_L/R$  of 1.8, and failure was based upon the melting of the interconnecting cable. Now asymmetry values of 30% to 40% are being addressed with accompanying high  $X_L/R$  ratios. If a line current recorder were connected to a line with high asymmetry the recorded waveshape would appear as shown in Fig. 11-15. It is during this reduction of asymmetry that mechanical breakage may occur.

Current asymmetry has been known for many years. In the past many substation current levels were low enough that mechanical breakage was not seen. As demands for electricity grew substations were enlarged and asymmetry problems began to appear.

Asymmetry is caused by the relationship of circuit inductive reactance ( $X_L$ ) to circuit resistance (R). The problem caused by asymmetry is most troubling in substations because that is where the currents are the largest and where the greatest  $X_L$  to R ratio is found. The  $X_L$  is a major property of coils. Substations are the site of large transformers, C.T.s, P.T.s, neutral reactors, etc., all which have coils and contribute to the  $X_L$ . As the line distance from the sub-station increases

the  $X_L$  decreases, in comparison to resistance and the problem of asymmetry decreases.

The mathematical equation for asymmetry is:

$$I = |V_m/Z| (\sin(\omega t + \theta - \alpha) - e^{-(Rt/L)} \sin(\alpha - \theta)) \\ = I_{II} (\sin(\omega t + \theta - \alpha) - e^{-(\omega R t/X)} \sin(\alpha - \theta))$$

where:

$ V_m $	=	peak voltage available, v
$ Z $	=	circuit impedance, $\Omega$
$I_{II}$	=	peak current available, A
R	=	circuit resistance, $\Omega$
t	=	time from current initiation,
$\omega$	=	$2\pi f$ (radians/s)
f	=	frequency, Hz
$\alpha$	=	voltage angle at current initiation, radians
$\theta$	=	circuit phase angle, radians
L	=	circuit inductance, $X/\omega$ , $\Omega$
X	=	inductive reactance, $X_L$

The equation is divided into two components. The sine function calculates the symmetrical RMS current of the circuit. The exponential function calculates the d.c. offset curve. The combination of sine and exponential values forms the asymmetrical curve. Notice also that as the value of  $X_L/R$  and closing angle ( $\alpha$ ) the resulting wave changes. To achieve the maximum first cycle peak the combination of time (t) and closing angle ( $\alpha$ ) must equal zero (0). Notice that the asymmetrical wave is symmetrical about the decaying d.c. component.

Figure B-1 is an example of a high asymmetry  
continued . . .



waveform. It takes approximately 15 cycles to return to near symmetrical current. If mechanical breakage is going to occur it will probably be within the first 1 to 5 cycles.

Utilities must evaluate their sites and provide protective grounding assemblies that have been tested and rated for use under these conditions, if deemed necessary. The current ASTM F855 standard addresses this and provides testing procedures and required values. Some substations remain sufficiently low in current that mechanical breakage may not be a problem. This is not something easily determined in the field. It must be considered prior to entering a substation site for maintenance.

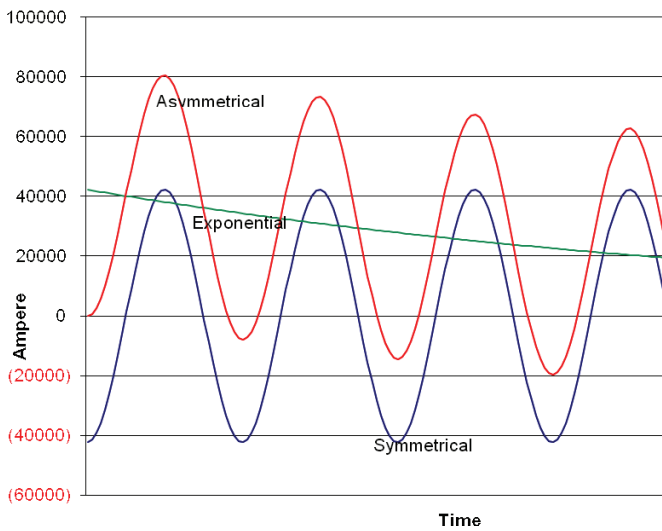

**Asymmetrical Current (30 kA, X/R=30)**  
**Figure B-1**

If the  $X_L$  to R ratio is small the asymmetry decreases to a proper RMS shape in a few cycles. If the ratio is large it may take as many as 20 to 30 cycles to become a symmetrical current. Figure B-2 illustrates the small value of maximum asymmetry allowed in the past. Notice that the waveshape returns to a symmetric shape in approximately 1 cycle.

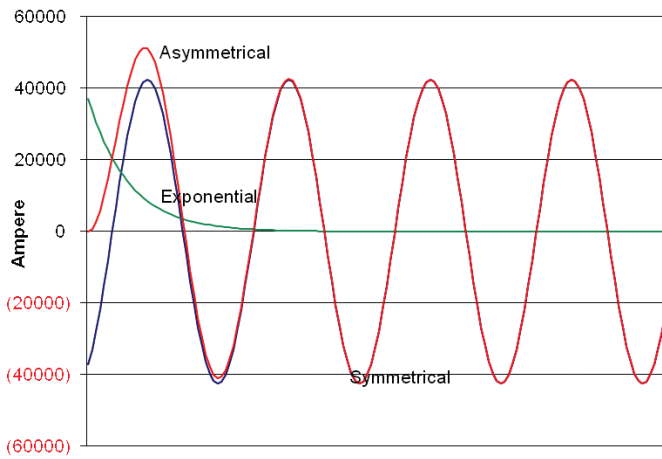

**Asymmetrical Current (30 kA, X/R=1.8)**  
**Figure B-2**

### **About Hubbell Power Systems**

Hubbell Power Systems (HPS) manufactures a wide variety of transmission, distribution, substation, OEM and telecommunications products used by utilities. HPS products are also used in the civil construction, transportation, gas and water industries. Our product line includes construction and switching products, tools, insulators, arresters, pole line hardware, cable accessories, test equipment, transformer bushings and polymer precast enclosures and equipment pads.

Because Hubbell has a policy of continuous product improvement. We reserve the right to change design and specifications without notice.

©Copyright 2008 & 2010 Hubbell Incorporated  
Printed in U.S.A. 01/11RP15M

Bulletin 07-0801 Rev 12/10  
[www.hubbellpowersystems.com](http://www.hubbellpowersystems.com)

