

Chapter 3 • Integral Relations for a Control Volume

3.1 Discuss Newton's second law (the linear momentum relation) in these three forms:

$$\Sigma \mathbf{F} = m\mathbf{a} \quad \Sigma \mathbf{F} = \frac{d}{dt}(m\mathbf{V}) \quad \Sigma \mathbf{F} = \frac{d}{dt} \left(\int_{system} \mathbf{V} \rho \, dv \right)$$

Solution: These questions are just to get the students thinking about the basic laws of mechanics. They are valid and equivalent for constant-mass systems, and we can make use of all of them in certain fluids problems, e.g. the #1 form for small elements, #2 form for rocket propulsion, but the #3 form is control-volume related and thus the most popular in this chapter.

3.2 Consider the angular-momentum relation in the form

$$\Sigma \mathbf{M}_O = \frac{d}{dt} \left[\int_{system} (\mathbf{r} \times \mathbf{V}) \rho \, dv \right]$$

What does \mathbf{r} mean in this relation? Is this relation valid in both solid and fluid mechanics? Is it related to the *linear*-momentum equation (Prob. 3.1)? In what manner?

Solution: These questions are just to get the students thinking about angular momentum versus linear momentum. One might forget that \mathbf{r} is the position vector from the moment-center O to the elements $\rho \, dv$ where momentum is being summed. Perhaps \mathbf{r}_O is a better notation.

3.3 For steady laminar flow through a long tube (see Prob. 1.12), the axial velocity distribution is given by $u = C(R^2 - r^2)$, where R is the tube outer radius and C is a constant. Integrate $u(r)$ to find the total volume flow Q through the tube.

Solution: The area element for this axisymmetric flow is $dA = 2\pi r \, dr$. From Eq. (3.7),

$$Q = \int u \, dA = \int_0^R C(R^2 - r^2) 2\pi r \, dr = \frac{\pi}{2} \mathbf{C} R^4 \quad \text{Ans.}$$

P3.4 A fire hose has a 5-inch inside diameter and is flowing at 600 gal/min. The flow exits through a nozzle contraction at a diameter D_n . For steady flow, what should D_n be, in inches, to create an exit velocity of 25 m/s?

Solution: This is a straightforward one-dimensional steady-flow continuity problem. Some unit conversions are needed:

$$600 \text{ gal/min} = 1.337 \text{ ft}^3/\text{s}; \quad 25 \text{ m/s} = 82.02 \text{ ft/s}; \quad 5 \text{ inches} = 0.4167 \text{ ft}$$

The hose diameter (5 in) would establish a hose average velocity of 9.8 ft/s, but we don't really need this. Go directly to the volume flow:

$$Q = 1.337 \frac{\text{ft}^3}{\text{s}} = A_n V_n = \frac{\pi}{4} D_n^2 (82.02 \frac{\text{ft}}{\text{s}})^2; \quad \text{Solve for } D_n = 0.144 \text{ ft} = \mathbf{1.73 \text{ in}} \quad \text{Ans.}$$

3.5 A theory proposed by S. I. Pai in 1953 gives the following velocity values $u(r)$ for turbulent (high-Reynolds number) airflow in a 4-cm-diameter tube:

$r, \text{ cm}$	0	0.25	0.5	0.75	1.0	1.25	1.5	1.75	2.0
$u, \text{ m/s}$	6.00	5.97	5.88	5.72	5.51	5.23	4.89	4.43	0.00

Comment on these data *vis-a-vis* laminar flow, Prob. 3.3. Estimate, as best you can, the total volume flow Q through the tube, in m^3/s .

Solution: The data can be plotted in the figure below.

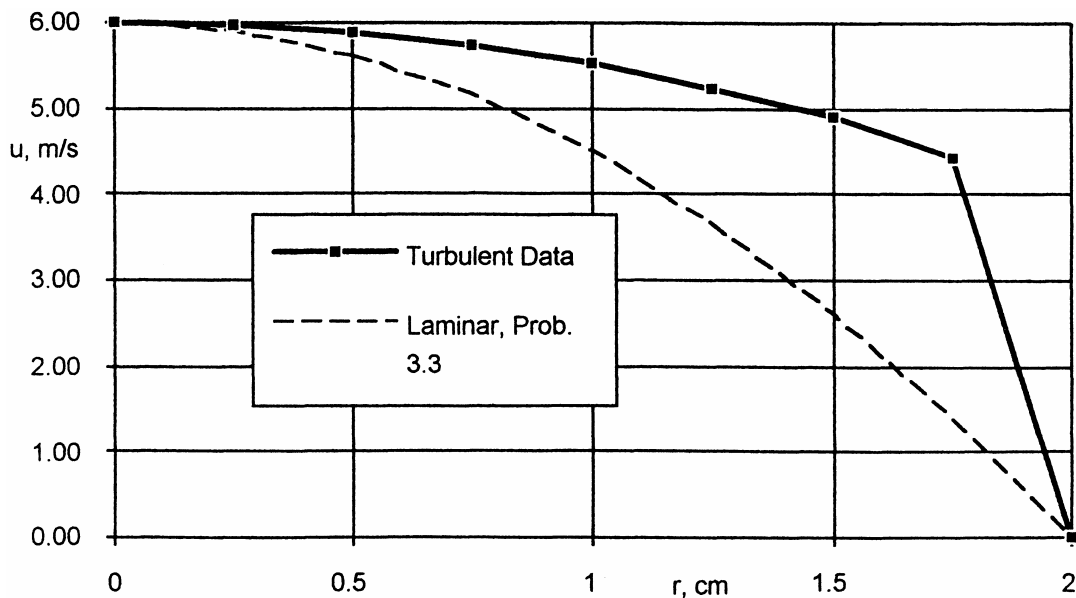

As seen in the figure, the flat (turbulent) velocities do not resemble the parabolic laminar-flow profile of Prob. 3.3. (The discontinuity at $r = 1.75$ cm is an artifact—we need more data for $1.75 < r < 2.0$ cm.) The volume flow, $Q = \int u(2\pi r)dr$, can be estimated by a numerical quadrature formula such as Simpson's rule. Here there are nine data points:

$$Q = 2\pi(r_1u_1 + 4r_2u_2 + 2r_3u_3 + 4r_4u_4 + 2r_5u_5 + 4r_6u_6 + 2r_7u_7 + 4r_8u_8 + r_9u_9) \left(\frac{\Delta r}{3} \right)$$

For the given data, $Q \approx 0.0059 \text{ m}^3/\text{s}$ Ans.

3.6 When a gravity-driven liquid jet issues from a slot in a tank, as in Fig. P3.6, an approximation for the exit velocity distribution is $u \approx \sqrt{2g(h-z)}$, where h is the depth of the jet centerline. Near the slot, the jet is horizontal, two-dimensional, and of thickness $2L$, as shown. Find a general expression for the total volume flow Q issuing from the slot; then take the limit of your result if $L \ll h$.

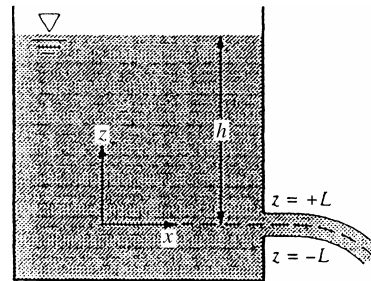

Fig. P3.6

Solution: Let the slot width be b into the paper. Then the volume flow from Eq. (3.7) is

$$Q = \int u dA = \int_{-L}^{+L} [2g(h-z)]^{1/2} b dz = \frac{2b}{3} \sqrt{2g} [(h+L)^{3/2} - (h-L)^{3/2}] \quad \text{Ans.}$$

In the limit of $L \ll h$, this formula reduces to $Q \approx (2Lb)\sqrt{2gh}$ Ans.

P3.7 A spherical tank, of diameter 35 cm, is leaking air through a 5-mm-diameter hole in its side. The air exits the hole at 360 m/s and a density of 2.5 kg/m^3 . Assuming uniform mixing, (a) find a formula for the rate of change of average density in the tank; and (b) calculate a numerical value for $(d\rho/dt)$ in the tank for the given data.

Solution: If the control volume surrounds the tank and cuts through the exit flow,

$$\frac{dm}{dt} \Big|_{\text{system}} = 0 = \frac{d}{dt}(\rho_{\text{tank}} v_{\text{tank}}) + \dot{m}_{\text{out}} = v_{\text{tank}} \frac{d}{dt}(\rho_{\text{tank}}) + (\rho AV)_{\text{out}}$$

$$\text{Solve for } \frac{d}{dt}(\rho_{\text{tank}}) = -\frac{(\rho AV)_{\text{out}}}{v_{\text{tank}}} \quad \text{Ans.(a)}$$

(b) For the given data, we calculate

$$\frac{d\rho_{\text{tank}}}{dt} = - \frac{(2.5 \text{ kg/m}^3)[(\pi/4)(0.005\text{m})^2](360 \text{ m/s})}{(\pi/6)(0.35\text{m})^3} = -0.79 \frac{\text{kg/m}^3}{\text{s}} \quad \text{Ans. (b)}$$

3.8 Three pipes steadily deliver water at 20°C to a large exit pipe in Fig. P3.8. The velocity $V_2 = 5 \text{ m/s}$, and the exit flow rate $Q_4 = 120 \text{ m}^3/\text{h}$. Find (a) V_1 ; (b) V_3 ; and (c) V_4 if it is known that increasing Q_3 by 20% would increase Q_4 by 10%.

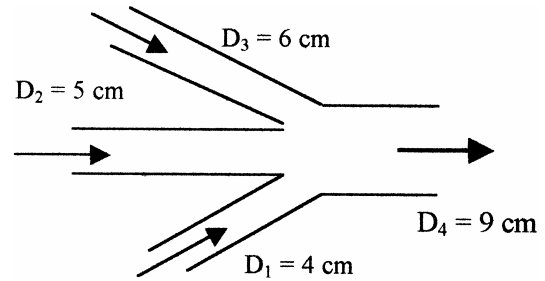

Fig. P3.8

Solution: (a) For steady flow we have $Q_1 + Q_2 + Q_3 = Q_4$, or

$$V_1 A_1 + V_2 A_2 + V_3 A_3 = V_4 A_4 \quad (1)$$

Since $0.2Q_3 = 0.1Q_4$, and $Q_4 = (120 \text{ m}^3/\text{h})(\text{h}/3600 \text{ s}) = 0.0333 \text{ m}^3/\text{s}$,

$$V_3 = \frac{Q_4}{2A_3} = \frac{(0.0333 \text{ m}^3/\text{s})}{\frac{\pi}{2}(0.06^2)} = 5.89 \text{ m/s} \quad \text{Ans. (b)}$$

Substituting into (1),

$$V_1 \left(\frac{\pi}{4} \right) (0.04^2) + (5) \left(\frac{\pi}{4} \right) (0.05^2) + (5.89) \left(\frac{\pi}{4} \right) (0.06^2) = 0.0333 \quad V_1 = 5.45 \text{ m/s} \quad \text{Ans. (a)}$$

From mass conservation, $Q_4 = V_4 A_4$

$$(0.0333 \text{ m}^3/\text{s}) = V_4 (\pi)(0.06^2)/4 \quad V_4 = 5.24 \text{ m/s} \quad \text{Ans. (c)}$$

3.9 A laboratory test tank contains seawater of salinity S and density ρ . Water enters the tank at conditions (S_1, ρ_1, A_1, V_1) and is assumed to mix immediately in the tank. Tank water leaves through an outlet A_2 at velocity V_2 . If salt is a “conservative” property (neither created nor destroyed), use the Reynolds transport theorem to find an expression for the rate of change of salt mass M_{salt} within the tank.

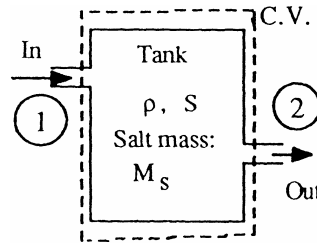

Solution: By definition, salinity $S = \rho_{\text{salt}}/\rho$. Since salt is a “conservative” substance (not consumed or created in this problem), the appropriate control volume relation is

$$\left. \frac{dM_{\text{salt}}}{dt} \right|_{\text{system}} = \frac{d}{dt} \left(\int_{\text{CV}} \rho_s \, dV \right) + S\dot{m}_2 - S_1\dot{m}_1 = 0$$

$$\text{or: } \left. \frac{dM_s}{dt} \right|_{\text{CV}} = S_1\rho_1A_1V_1 - S\rho A_2V_2 \quad \text{Ans.}$$

3.10 Water flowing through an 8-cm-diameter pipe enters a porous section, as in Fig. P3.10, which allows a uniform radial velocity v_w through the wall surfaces for a distance of 1.2 m. If the entrance average velocity V_1 is 12 m/s, find the exit velocity V_2 if (a) $v_w = 15$ cm/s out of the pipe walls; (b) $v_w = 10$ cm/s into the pipe. (c) What value of v_w will make $V_2 = 9$ m/s?

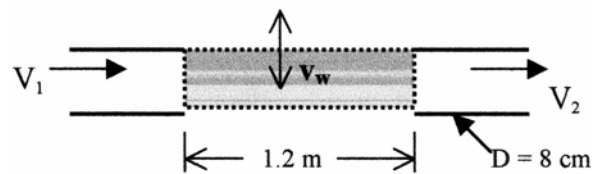

Fig. P3.10

Solution: (a) For a suction velocity of $v_w = 0.15$ m/s, and a cylindrical suction surface area,

$$A_w = 2\pi(0.04)(1.2) = 0.3016 \text{ m}^2$$

$$Q_1 = Q_w + Q_2$$

$$(12)(\pi)(0.08^2)/4 = (0.15)(0.3016) + V_2(\pi)(0.08^2)/4 \quad \mathbf{V_2 = 3 \text{ m/s}} \quad \text{Ans. (a)}$$

(b) For a smaller wall velocity, $v_w = 0.10$ m/s,

$$(12)(\pi)(0.08^2)/4 = (0.10)(0.3016) + V_2(\pi)(0.08^2)/4 \quad \mathbf{V_2 = 6 \text{ m/s} \quad Ans. (b)}$$

(c) Setting the outflow V_2 to 9 m/s, the wall suction velocity is,

$$(12)(\pi)(0.08^2)/4 = (v_w)(0.3016) + (9)(\pi)(0.08^2)/4 \quad \mathbf{v_w = 0.05 \text{ m/s} = 5 \text{ cm/s out}}$$

3.11 A room contains dust at uniform concentration $C = \rho_{\text{dust}}/\rho$. It is to be cleaned by introducing fresh air at an inlet section A_i , V_i and exhausting the room air through an outlet section. Find an expression for the rate of change of dust mass in the room.

Solution: This problem is very similar to Prob. 3.9 on the previous page, except that here $C_i = 0$ (dustfree air). Refer to the figure in Prob. 3.9. The dust mass relation is

$$\left. \frac{dM_{\text{dust}}}{dt} \right|_{\text{system}} = 0 = \frac{d}{dt} \left(\int_{\text{CV}} \rho_{\text{dust}} dV \right) + C_{\text{out}} \dot{m}_{\text{out}} - C_{\text{in}} \dot{m}_{\text{in}},$$

$$\text{or, since } C_{\text{in}} = 0, \text{ we obtain } \left. \frac{dM_{\text{dust}}}{dt} \right|_{\text{CV}} = -C \rho \mathbf{A}_o \mathbf{V}_o \quad \text{Ans.}$$

To complete the analysis, we would need to make an *overall* fluid mass balance.

3.12 The pipe flow in Fig. P3.12 fills a cylindrical tank as shown. At time $t = 0$, the water depth in the tank is 30 cm. Estimate the time required to fill the remainder of the tank.

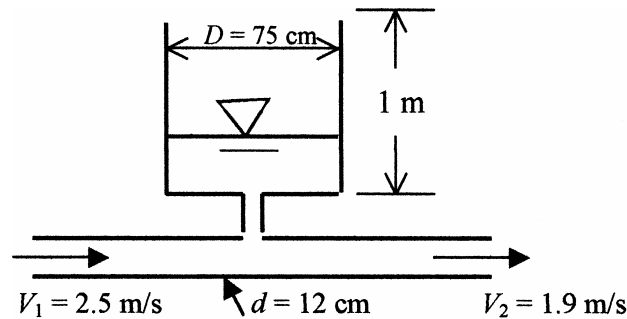

Fig. P3.12

Solution: For a control volume enclosing the tank and the portion of the pipe below the tank,

$$\frac{d}{dt} \left[\int \rho dv \right] + \dot{m}_{\text{out}} - \dot{m}_{\text{in}} = 0$$

$$\rho \pi R^2 \frac{dh}{dt} + (\rho AV)_{\text{out}} - (\rho AV)_{\text{in}} = 0$$

$$\frac{dh}{dt} = \frac{4}{998(\pi)(0.75^2)} \left[998 \left(\frac{\pi}{4} \right) (0.12^2) (2.5 - 1.9) \right] = 0.0153 \text{ m/s},$$

$$\Delta t = 0.7/0.0153 = \mathbf{46 \text{ s}} \quad \text{Ans.}$$

P3.13 The cylindrical container in Fig. P3.13 is 20 cm in diameter and has a conical contraction at the bottom with an exit hole 3 cm in diameter. The tank contains fresh water at standard sea-level conditions. If the water surface is falling at the nearly steady rate $dh/dt \approx -0.072$ m/s, estimate the average velocity V from the bottom exit.

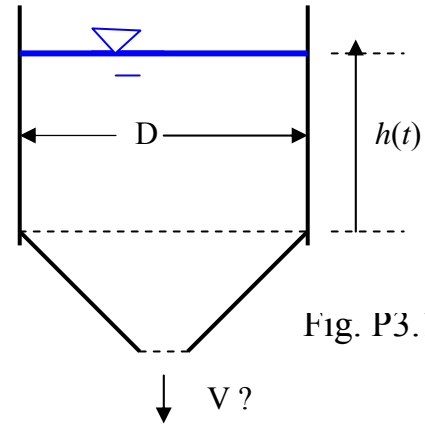

Fig. P3.13

Solution: We could simply note that dh/dt is the same as the water *velocity* at the surface and use $Q_1 = Q_2$, or, more instructive, approach it as a control volume problem. Let the control volume encompass the entire container. Then the mass relation is

$$\frac{dm}{dt} \Big|_{\text{system}} = 0 = \frac{d}{dt} \left(\int_{CV} \rho \, dv \right) + \dot{m}_{\text{out}} = \frac{d}{dt} \left(v_{\text{cone}} + \rho \frac{\pi}{4} D^2 h \right) + \rho \frac{\pi}{4} D_{\text{exit}}^2 V,$$

$$\text{or: } \rho \frac{\pi}{4} D^2 \frac{dh}{dt} + \rho \frac{\pi}{4} D_{\text{exit}}^2 V = 0 \quad \text{Cancel } \rho \frac{\pi}{4}: \quad V = \left(\frac{D}{D_{\text{exit}}} \right)^2 \left(-\frac{dh}{dt} \right)$$

$$\text{Introduce the data: } V = \left(\frac{20 \text{ cm}}{3 \text{ cm}} \right)^2 \left[-(-0.072 \frac{\text{m}}{\text{s}}) \right] = 3.2 \frac{\text{m}}{\text{s}} \quad \text{Ans.}$$

3.14 The open tank in the figure contains water at 20°C. For incompressible flow, (a) derive an analytic expression for dh/dt in terms of (Q_1, Q_2, Q_3) . (b) If h is constant, determine V_2 for the given data if $V_1 = 3$ m/s and $Q_3 = 0.01$ m³/s.

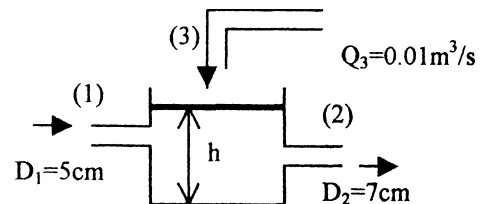

Solution: For a control volume enclosing the tank,

$$\frac{d}{dt} \left(\int_{CV} \rho \, dv \right) + \rho(Q_2 - Q_1 - Q_3) = \rho \frac{\pi d^2}{4} \frac{dh}{dt} + \rho(Q_2 - Q_1 - Q_3),$$

$$\text{solve } \frac{dh}{dt} = \frac{Q_1 + Q_3 - Q_2}{(\pi d^2/4)} \quad \text{Ans. (a)}$$

If h is constant, then

$$Q_2 = Q_1 + Q_3 = 0.01 + \frac{\pi}{4}(0.05)^2(3.0) = 0.0159 = \frac{\pi}{4}(0.07)^2 V_2,$$

solve $V_2 = \mathbf{4.13 \text{ m/s}}$ *Ans. (b)*

3.15 Water flows steadily through the round pipe in the figure. The entrance velocity is V_0 . The exit velocity approximates turbulent flow, $u = u_{\max}(1 - r/R)^{1/7}$. Determine the ratio U_0/u_{\max} for this incompressible flow.

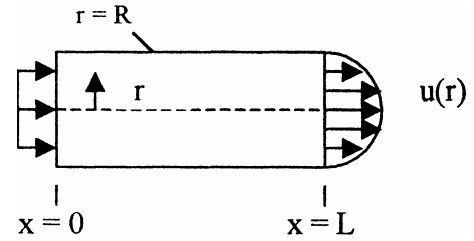

Solution: Inlet and outlet flow must balance:

$$Q_1 = Q_2, \text{ or: } \int_0^R U_0 2\pi r \, dr = \int_0^R u_{\max} \left(1 - \frac{r}{R}\right)^{1/7} 2\pi r \, dr, \text{ or: } U_0 \pi R^2 = u_{\max} \frac{49\pi}{60} R^2$$

Cancel and rearrange for this assumed incompressible pipe flow:

$$\frac{U_0}{u_{\max}} = \frac{49}{60} \text{ Ans.}$$

3.16 An incompressible fluid flows past an impermeable flat plate, as in Fig. P3.16, with a uniform inlet profile $u = U_0$ and a cubic polynomial exit profile

$$u \approx U_0 \left(\frac{3\eta - \eta^3}{2} \right) \text{ where } \eta = \frac{y}{\delta}$$

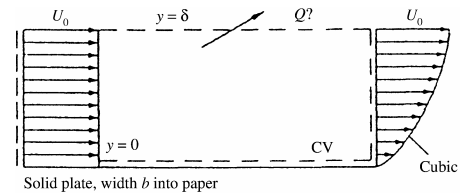

Fig. P3.16

Compute the volume flow Q across the top surface of the control volume.

Solution: For the given control volume and incompressible flow, we obtain

$$\begin{aligned} 0 &= Q_{\text{top}} + Q_{\text{right}} - Q_{\text{left}} = Q + \int_0^{\delta} U_0 \left(\frac{3y}{2\delta} - \frac{y^3}{2\delta^3} \right) b \, dy - \int_0^{\delta} U_0 b \, dy \\ &= Q + \frac{5}{8} U_0 b \delta - U_0 b \delta, \text{ solve for } \mathbf{Q = \frac{3}{8} U_0 b \delta} \text{ Ans.} \end{aligned}$$

3.17 Incompressible steady flow in the inlet between parallel plates in Fig. P3.17 is uniform, $u = U_0 = 8 \text{ cm/s}$, while downstream the flow develops into the parabolic laminar profile $u = az(z_0 - z)$, where a is a constant. If $z_0 = 4 \text{ cm}$ and the fluid is SAE 30 oil at 20°C , what is the value of u_{\max} in cm/s ?

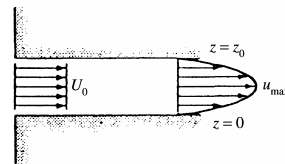

Fig. P3.17

Solution: Let b be the plate width into the paper. Let the control volume enclose the inlet and outlet. The walls are solid, so no flow through the wall. For incompressible flow,

$$0 = Q_{\text{out}} - Q_{\text{in}} = \int_0^{z_0} az(z_0 - z)b \, dz - \int_0^{z_0} U_0 b \, dz = abz_0^3/6 - U_0 bz_0 = 0, \quad \text{or: } a = 6U_0/z_0^2$$

Thus continuity forces the constant a to have a particular value. Meanwhile, a is also related to the maximum velocity, which occurs at the center of the parabolic profile:

$$\text{At } z = z_0/2: \quad u = u_{\text{max}} = a \left(\frac{z_0}{2} \right) \left(z_0 - \frac{z_0}{2} \right) = az_0^2/4 = (6U_0/z_0^2)(z_0^2/4)$$

$$\text{or: } u_{\text{max}} = \frac{3}{2}U_0 = \frac{3}{2}(8 \text{ cm/s}) = \mathbf{12 \frac{\text{cm}}{\text{s}}} \quad \text{Ans.}$$

Note that the result is independent of z_0 or of the particular fluid, which is SAE 30 oil.

3.18 An incompressible fluid flows steadily through the rectangular duct in the figure. The exit velocity profile is given by $u \approx u_{\text{max}}(1 - y^2/b^2)(1 - z^2/h^2)$. (a) Does this profile satisfy the correct boundary conditions for viscous fluid flow? (b) Find an analytical expression for the volume flow Q at the exit. (c) If the inlet flow is 300 ft³/min, estimate u_{max} in m/s.

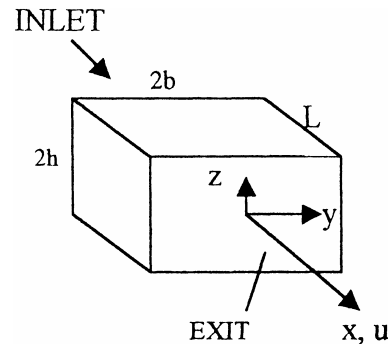

Solution: (a) The fluid should not slip at any of the duct surfaces, which are defined by $y = \pm b$ and $z = \pm h$. From our formula, we see $\mathbf{u} \equiv \mathbf{0}$ at all duct surfaces, OK. Ans. (a)

(b) The exit volume flow Q is defined by the integral of u over the exit plane area:

$$Q = \iint u \, dA = \int_{-h}^{+h} \int_{-b}^{+b} u_{\text{max}} \left(1 - \frac{y^2}{b^2} \right) \left(1 - \frac{z^2}{h^2} \right) dy \, dz = u_{\text{max}} \left(\frac{4b}{3} \right) \left(\frac{4h}{3} \right)$$

$$= \frac{\mathbf{16bhu_{\text{max}}}}{\mathbf{9}} \quad \text{Ans. (b)}$$

(c) Given $Q = 300 \text{ ft}^3/\text{min} = 0.1416 \text{ m}^3/\text{s}$ and $b = h = 10 \text{ cm}$, the maximum exit velocity is

$$Q = 0.1416 \frac{\text{m}^3}{\text{s}} = \frac{16}{9}(0.1 \text{ m})(0.1 \text{ m})u_{\text{max}}, \quad \text{solve for } \mathbf{u_{\text{max}} = 7.96 \text{ m/s}} \quad \text{Ans. (c)}$$

3.19 Water from a storm drain flows over an outfall onto a porous bed which absorbs the water at a uniform vertical velocity of 8 mm/s, as shown in Fig. P3.19. The system is 5 m deep into the paper. Find the length L of bed which will completely absorb the storm water.

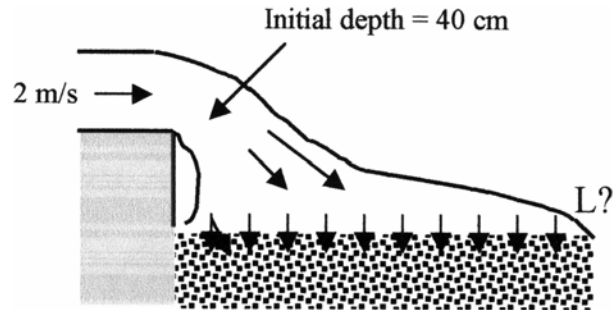

Fig. P3.19

Solution: For the bed to completely absorb the water, the flow rate over the outfall must equal that into the porous bed,

$$Q_1 = Q_{PB}; \quad \text{or} \quad (2 \text{ m/s})(0.2 \text{ m})(5 \text{ m}) = (0.008 \text{ m/s})(5 \text{ m})L \quad \mathbf{L \approx 50 \text{ m}} \quad \text{Ans.}$$

3.20 Oil (SG-0.91) enters the thrust bearing at 250 N/hr and exits radially through the narrow clearance between thrust plates. Compute (a) the outlet volume flow in mL/s, and (b) the average outlet velocity in cm/s.

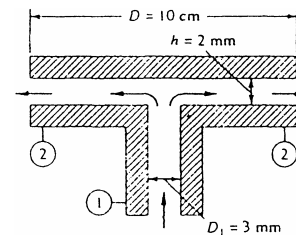

Fig. P3.20

Solution: The specific weight of the oil is $(0.91)(9790) = 8909 \text{ N/m}^3$. Then

$$Q_2 = Q_1 = \frac{250/3600 \text{ N/s}}{8909 \text{ N/m}^3} = 7.8 \times 10^{-6} \frac{\text{m}^3}{\text{s}} = \mathbf{7.8 \frac{\text{mL}}{\text{s}}} \quad \text{Ans. (a)}$$

$$\text{But also} \quad Q_2 = V_2 \pi (0.1 \text{ m})(0.002 \text{ m}) = 7.8 \times 10^{-6}, \quad \text{solve for} \quad V_2 = \mathbf{1.24 \frac{\text{cm}}{\text{s}}} \quad \text{Ans. (b)}$$

P3.21 Modify Prob. 3.13 as follows. Let the plate be $L = 125\delta$ long from inlet to exit. The plate is *porous* and is drawing in fluid from the boundary layer at a uniform suction velocity v_w . (a) Calculate Q across the top if $v_w = 0.002U_o$. (b) Find the ratio v_w/U_o for which Q across the top is zero.

Solution: The situation is now as shown at right. The inlet and outlet flows were calculated in Prob. P3.13. The wall flow is the suction velocity times the wall area:

$$Q_{\text{wall}} = v_w L b = v_w (125\delta) b$$

The total volume flow through the control volume is zero, solve for Q :

$$Q = U_o b \delta - \frac{5}{8} U_o b \delta - 125 v_w b \delta = \frac{3}{8} U_o b \delta - 125 v_w b \delta$$

(a) If $v_w = 0.002U_o$, compute $Q = (1/8)U_o b \delta$ *Ans.(a)*

(b) $Q = 0$ when $v_w = 0.003U_o$. *Ans.(b)*

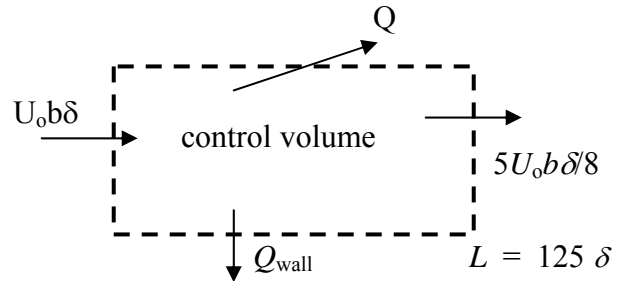

3.22 The converging-diverging nozzle shown in Fig. P3.22 expands and accelerates dry air to supersonic speeds at the exit, where $p_2 = 8$ kPa and $T_2 = 240$ K. At the throat, $p_1 = 284$ kPa, $T_1 = 665$ K, and $V_1 = 517$ m/s. For steady compressible flow of an ideal gas, estimate (a) the mass flow in kg/h, (b) the velocity V_2 , and (c) the Mach number Ma_2 .

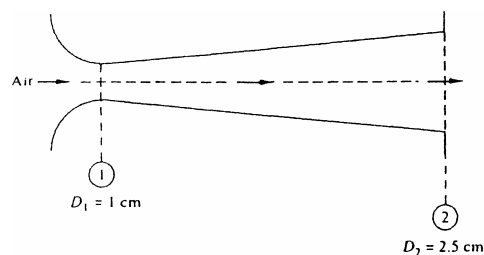

Fig. P3.22

Solution: The mass flow is given by the throat conditions:

$$\dot{m} = \rho_1 A_1 V_1 = \left[\frac{284000}{(287)(665)} \frac{\text{kg}}{\text{m}^3} \right] \frac{\pi}{4} (0.01 \text{ m})^2 \left(517 \frac{\text{m}}{\text{s}} \right) = \mathbf{0.0604} \frac{\text{kg}}{\text{s}} \quad \text{Ans. (a)}$$

For steady flow, this must equal the mass flow at the exit:

$$0.0604 \frac{\text{kg}}{\text{s}} = \rho_2 A_2 V_2 = \left[\frac{8000}{287(240)} \right] \frac{\pi}{4} (0.025)^2 V_2, \quad \text{or} \quad V_2 \approx \mathbf{1060 \frac{m}{s}} \quad \text{Ans. (b)}$$

Recall from Eq. (1.39) that the speed of sound of an ideal gas = $(kRT)^{1/2}$. Then

$$\text{Mach number at exit: } \text{Ma} = V_2/a_2 = \frac{1060}{[1.4(287)(240)]^{1/2}} \approx \mathbf{3.41} \quad \text{Ans. (c)}$$

3.23 The hypodermic needle in the figure contains a liquid (SG = 1.05). If the serum is to be injected steadily at $6 \text{ cm}^3/\text{s}$, how fast should the plunger be advanced (a) if leakage in the plunger clearance is neglected; and (b) if leakage is 10 percent of the needle flow?

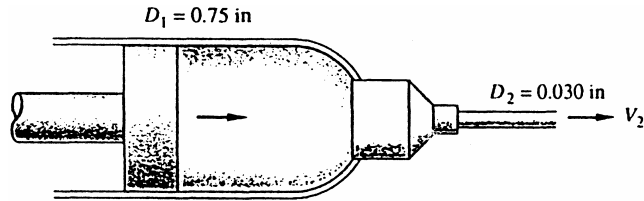

Solution: (a) For incompressible flow, the volume flow is the same at piston and exit:

$$Q = 6 \frac{\text{cm}^3}{\text{s}} = 0.366 \frac{\text{in}^3}{\text{s}} = A_1 V_1 = \frac{\pi}{4} (0.75 \text{ in})^2 V_1, \quad \text{solve } V_{\text{piston}} = \mathbf{0.83 \frac{\text{in}}{\text{s}}} \quad \text{Ans. (a)}$$

(b) If there is 10% leakage, the piston must deliver both needle flow and leakage:

$$A_1 V_1 = Q_{\text{needle}} + Q_{\text{clearance}} = 6 + 0.1(6) = 6.6 \frac{\text{cm}^3}{\text{s}} = 0.403 \frac{\text{in}^3}{\text{s}} = \frac{\pi}{4} (0.75)^2 V_1,$$

$$V_1 = \mathbf{0.91 \frac{\text{in}}{\text{s}}} \quad \text{Ans. (b)}$$

3.24 Water enters the bottom of the cone in the figure at a uniformly increasing average velocity $V = Kt$. If d is very small, derive an analytic formula for the water surface rise $h(t)$, assuming $h = 0$ at $t = 0$.

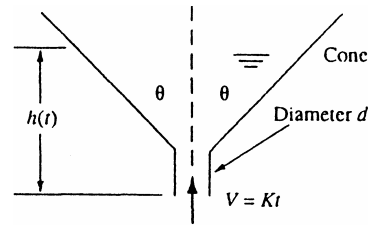

Solution: For a control volume around the cone, the mass relation becomes

$$\frac{d}{dt} \left(\int \rho \, dv \right) - \dot{m}_{\text{in}} = 0 = \frac{d}{dt} \left[\rho \frac{\pi}{3} (h \tan \theta)^2 h \right] - \rho \frac{\pi}{4} d^2 Kt$$

$$\text{Integrate: } \rho \frac{\pi}{3} h^3 \tan^2 \theta = \rho \frac{\pi}{8} d^2 Kt^2$$

$$\text{Solve for } \mathbf{h(t) = \left[\frac{3}{8} Kt^2 d^2 \cot^2 \theta \right]^{1/3}} \quad \text{Ans.}$$

3.25 As will be discussed in Chaps. 7 and 8, the flow of a stream U_0 past a blunt flat plate creates a broad low-velocity wake behind the plate. A simple model is given in Fig. P3.25, with only half of the flow shown due to symmetry. The velocity profile behind the plate is idealized as “dead air” (near-zero velocity) behind the plate, plus a higher

velocity, decaying vertically above the wake according to the variation $u \approx U_0 + \Delta U e^{-z/L}$, where L is the plate height and $z = 0$ is the top of the wake. Find ΔU as a function of stream speed U_0 .

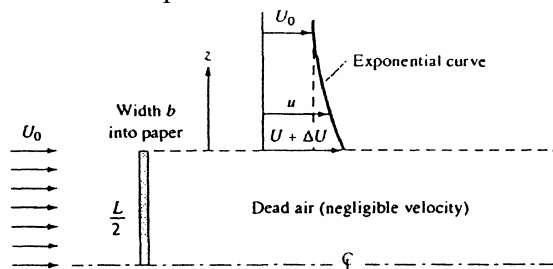

Fig. P3.25

Solution: For a control volume enclosing the upper half of the plate and the section where the exponential profile applies, extending upward to a large distance H such that $\exp(-H/L) \approx 0$, we must have inlet and outlet volume flows the same:

$$Q_{\text{in}} = \int_{-L/2}^{L/2} U_0 dz = Q_{\text{out}} = \int_0^H (U_0 + \Delta U e^{-z/L}) dz, \quad \text{or:} \quad U_0 \left(H + \frac{L}{2} \right) = U_0 H + \Delta U L$$

$$\text{Cancel } U_0 H \text{ and solve for } \Delta U \approx \frac{1}{2} U_0 \quad \text{Ans.}$$

3.26 A thin layer of liquid, draining from an inclined plane, as in the figure, will have a laminar velocity profile $u = U_0(2y/h - y^2/h^2)$, where U_0 is the surface velocity. If the plane has width b into the paper, (a) determine the volume rate of flow of the film. (b) Suppose that $h = 0.5$ in and the flow rate per foot of channel width is 1.25 gal/min. Estimate U_0 in ft/s.

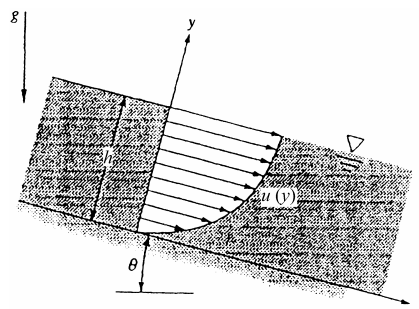

Solution: (a) The total volume flow is computed by integration over the flow area:

$$Q = \int V_n dA = \int_0^h U_0 \left(\frac{2y}{h} - \frac{y^2}{h^2} \right) b dy = \frac{2}{3} U_0 b h \quad \text{Ans. (a)}$$

(b) Evaluate the above expression for the given data:

$$Q = 1.25 \frac{\text{gal}}{\text{min}} = 0.002785 \frac{\text{ft}^3}{\text{s}} = \frac{2}{3} U_0 b h = \frac{2}{3} U_0 (1.0 \text{ ft}) \left(\frac{0.5}{12} \text{ ft} \right),$$

$$\text{solve for } U_0 = \mathbf{0.10} \frac{\text{ft}}{\text{s}} \quad \text{Ans. (b)}$$

P3.27 Consider a highly pressurized air tank at conditions (p_o, ρ_o, T_o) and volume v_o . In Chap. 9 we will learn that, if the tank is allowed to exhaust to the atmosphere through a well-designed converging nozzle of exit area A , the outgoing mass flow rate will be

$$\dot{m} = \frac{\alpha p_o A}{\sqrt{RT_o}}, \quad \text{where } \alpha \approx 0.685 \quad \text{for air}$$

This rate persists as long as p_o is at least twice as large as the atmospheric pressure. Assuming constant T_o and an ideal gas, (a) derive a formula for the change of density $\rho_o(t)$ within the tank. (b) Analyze the time Δt required for the density to decrease by 25%.

Solution: First convert the formula to reflect tank *density* instead of pressure:

$$\dot{m} = \frac{\alpha p_o A}{\sqrt{RT_o}} = \frac{\alpha (\rho_o RT_o) A}{\sqrt{RT_o}} = \alpha \rho_o A \sqrt{RT_o}$$

(a) Now apply a mass balance to a control volume surrounding the tank:

$$\left. \frac{dm}{dt} \right|_{\text{system}} = 0 = \frac{d}{dt}(\rho_o v_o) + \dot{m}_{\text{out}} = v_o \frac{d\rho_o}{dt} + \alpha \rho_o A \sqrt{RT_o}$$

$$\text{Separate variables: } \frac{d\rho_o}{\rho_o} = -\alpha A \sqrt{RT_o} dt$$

$$\text{Integrate from state 1 to state 2: } \frac{\rho_{o2}}{\rho_{o1}} = \exp\left[-\frac{\alpha A \sqrt{RT_o}}{v_o} (t_2 - t_1)\right] \quad \text{Ans.(a)}$$

(b) If the density drops by 25%, then we compute

$$\frac{\alpha A \sqrt{RT_o}}{v_o} (t_2 - t_1) = -\ln(0.75) = 0.288 ; \quad \text{Thus } \Delta t = \frac{0.288 v_o}{\alpha A \sqrt{RT_o}} \quad \text{Ans.(b)}$$

3.28 According to Torricelli's theorem, the velocity of a fluid draining from a hole in a tank is $V \approx (2gh)^{1/2}$, where h is the depth of water above the hole, as in Fig. P3.28. Let the hole have area A_o and the cylindrical tank have bottom area A_b . Derive a formula for the time to drain the tank from an initial depth h_o .

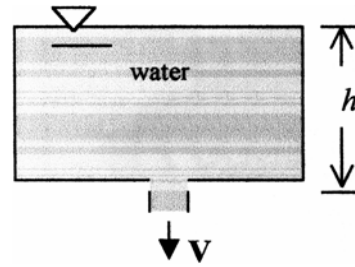

Fig. P3.28

Solution: For a control volume around the tank,

$$\frac{d}{dt} \left[\int \rho \, dv \right] + \dot{m}_{out} = 0$$

$$\rho A_b \frac{dh}{dt} = -\dot{m}_{out} = -\rho A_o \sqrt{2gh}$$

$$\int_{h_o}^0 \frac{dh}{\sqrt{h}} = \int_0^t \frac{A_o \sqrt{2g}}{A_b} dt; \quad t = \frac{A_b}{A_o} \sqrt{\frac{h_o}{2g}} \quad \text{Ans.}$$

3.29 In elementary compressible-flow theory (Chap. 9), compressed air will exhaust from a small hole in a tank at the mass flow rate $\dot{m} \approx C\rho$, where ρ is the air density in the tank and C is a constant. If ρ_0 is the initial density in a tank of volume v , derive a formula for the density change $\rho(t)$ after the hole is opened. Apply your formula to the following case: a spherical tank of diameter 50 cm, with initial pressure 300 kPa and temperature 100°C, and a hole whose initial exhaust rate is 0.01 kg/s. Find the time required for the tank density to drop by 50 percent.

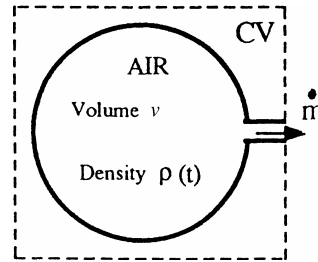

Solution: For a control volume enclosing the tank and the exit jet, we obtain

$$0 = \frac{d}{dt} \left(\int \rho dv \right) + \dot{m}_{\text{out}}, \quad \text{or:} \quad v \frac{d\rho}{dt} = -\dot{m}_{\text{out}} = -C\rho,$$

$$\text{or:} \quad \int_{\rho_0}^{\rho} \frac{d\rho}{\rho} = -\frac{C}{v} \int_0^t dt, \quad \text{or:} \quad \frac{\rho}{\rho_0} \approx \exp \left[-\frac{C}{v} t \right] \quad \text{Ans.}$$

Now apply this formula to the given data. If $p_0 = 300$ kPa and $T_0 = 100^\circ\text{C} = 373^\circ\text{K}$, then $\rho_0 = p/RT = (300,000)/[287(373)] \approx 2.80$ kg/m³. This establishes the constant “C”:

$$\dot{m}_0 = C\rho_0 = 0.01 \frac{\text{kg}}{\text{s}} = C \left(2.80 \frac{\text{kg}}{\text{m}^3} \right), \quad \text{or} \quad C \approx 0.00357 \frac{\text{m}^3}{\text{s}} \quad \text{for this hole.}$$

The tank volume is $v = (\pi/6)D^3 = (\pi/6)(0.5 \text{ m})^3 \approx 0.00654 \text{ m}^3$. Then we require

$$\rho/\rho_0 = 0.5 = \exp \left[-\frac{0.00357}{0.00654} t \right] \quad \text{if } t \approx \mathbf{1.3 \text{ s}} \quad \text{Ans.}$$

P3.30 A steady two-dimensional water jet, 4 cm thick with a weight flow rate of 1960 N/s, strikes an angled barrier as in Fig. P3.30. Pressure and water velocity are constant everywhere. Thirty percent of the jet passes through the slot. The rest splits

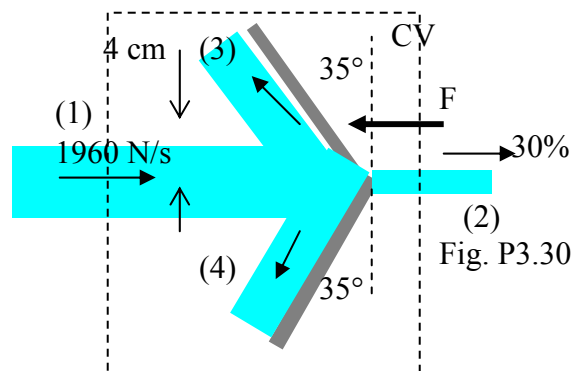

symmetrically along the barrier. Calculate the horizontal force F needed, per unit thickness into the paper, to hold the barrier stationary.

Solution: For water take $\rho = 998 \text{ kg/m}$. The control volume (see figure) cuts through all four jets, which are numbered. The velocity of all jets follows from the weight flow at (1):

$$V_{1,2,3,4} = V_1 = \frac{\dot{w}_1}{\rho g A_1} = \frac{1960 \text{ N/s}}{(9.81 \text{ m/s}^2)(998 \text{ kg/m}^3)(0.04 \text{ m})(1 \text{ m})} = 5.0 \frac{\text{m}}{\text{s}}$$

$$\dot{m}_1 = \frac{\dot{w}_1}{g} = \frac{1960 \text{ N/s} - m}{9.81 \text{ N/s}^2} = 200 \frac{\text{kg}}{\text{s} - m}; \dot{m}_2 = 0.3\dot{m}_1 = 60 \frac{\text{kg}}{\text{s} - m}; \dot{m}_3 = \dot{m}_4 = 70 \frac{\text{kg}}{\text{s} - m}$$

Then the x -momentum relation for this control volume yields

$$\begin{aligned} \Sigma F_x &= -F = \dot{m}_2 u_2 + \dot{m}_3 u_3 + \dot{m}_4 u_4 - \dot{m}_1 u_1 = \\ -F &= (60)(5.0) + (70)(-5.0 \cos 55^\circ) + (70)(-5.0 \cos 55^\circ) - 200(5.0), \text{ or:} \\ F &= 1000 + 201 + 201 - 300 \approx \mathbf{1100 \text{ N}} \text{ per meter of width } \textit{Ans.} \end{aligned}$$

3.31 A bellows may be modeled as a deforming wedge-shaped volume as in Fig. P3.31. The check valve on the left (pleated) end is closed during the stroke. If b is the bellows width into the paper, derive an expression for outlet mass flow \dot{m}_o as a function of stroke $\theta(t)$.

Solution: For a control volume enclosing the bellows and the outlet flow, we obtain

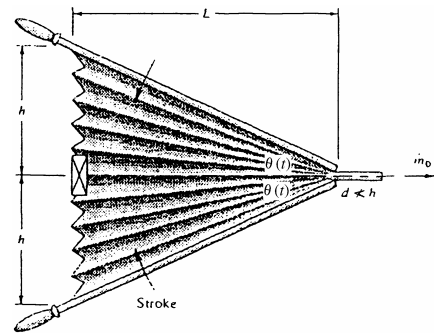
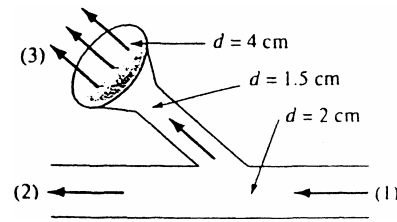

Fig. P3.31

$$\frac{d}{dt}(\rho v) + \dot{m}_{\text{out}} = 0, \quad \text{where } v = bhL = bL^2 \tan \theta$$

$$\text{since } L \text{ is constant, solve for } \dot{m}_o = -\frac{d}{dt}(\rho bL^2 \tan \theta) = -\rho bL^2 \sec^2 \theta \frac{d\theta}{dt} \textit{ Ans.}$$

3.32 Water at 20°C flows through the piping junction in the figure, entering section 1 at 20 gal/min. The average velocity at section 2 is 2.5 m/s. A portion of the flow is diverted through the showerhead, which contains 100 holes of 1-mm diameter. Assuming uniform shower flow, estimate the exit velocity from the showerhead jets.



Solution: A control volume around sections (1, 2, 3) yields

$$Q_1 = Q_2 + Q_3 = 20 \text{ gal/min} = 0.001262 \text{ m}^3/\text{s}.$$

Meanwhile, with $V_2 = 2.5 \text{ m/s}$ known, we can calculate Q_2 and then Q_3 :

$$Q_2 = V_2 A_2 = (2.5 \text{ m}) \frac{\pi}{4} (0.02 \text{ m})^2 = 0.000785 \frac{\text{m}^3}{\text{s}},$$

$$\text{hence } Q_3 = Q_1 - Q_2 = 0.001262 - 0.000785 = 0.000476 \frac{\text{m}^3}{\text{s}}$$

$$\text{Each hole carries } Q_3/100 = 0.00000476 \frac{\text{m}^3}{\text{s}} = \frac{\pi}{4} (0.001)^2 V_{jet},$$

$$\text{solve } V_{jet} = \mathbf{6.06} \frac{\mathbf{m}}{\mathbf{s}} \text{ Ans.}$$

3.33 In some wind tunnels the test section is perforated to suck out fluid and provide a thin viscous boundary layer. The test section wall in Fig. P3.33 contains 1200 holes of 5-mm diameter each per square meter of wall area. The suction velocity through each hole is $V_r = 8 \text{ m/s}$, and the test-section entrance velocity is $V_1 = 35 \text{ m/s}$. Assuming incompressible steady flow of air at 20°C, compute (a) V_0 , (b) V_2 , and (c) V_f , in m/s.

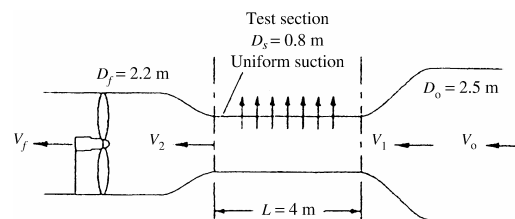

Fig. P3.33

Solution: The test section wall area is $(\pi)(0.8 \text{ m})(4 \text{ m}) = 10.053 \text{ m}^2$, hence the total number of holes is $(1200)(10.053) = 12064$ holes. The total suction flow leaving is

$$Q_{\text{suction}} = NQ_{\text{hole}} = (12064)(\pi/4)(0.005 \text{ m})^2(8 \text{ m/s}) \approx 1.895 \text{ m}^3/\text{s}$$

$$(a) \text{ Find } V_o: Q_o = Q_1 \text{ or } V_o \frac{\pi}{4}(2.5)^2 = (35) \frac{\pi}{4}(0.8)^2,$$

$$\text{solve for } V_o \approx \mathbf{3.58} \frac{\mathbf{m}}{\mathbf{s}} \text{ Ans. (a)}$$

$$(b) Q_2 = Q_1 - Q_{\text{suction}} = (35) \frac{\pi}{4}(0.8)^2 - 1.895 = V_2 \frac{\pi}{4}(0.8)^2,$$

$$\text{or: } V_2 \approx \mathbf{31.2} \frac{\mathbf{m}}{\mathbf{s}} \text{ Ans. (b)}$$

$$(c) \text{ Find } V_f: Q_f = Q_2 \text{ or } V_f \frac{\pi}{4}(2.2)^2 = (31.2) \frac{\pi}{4}(0.8)^2,$$

$$\text{solve for } V_f \approx \mathbf{4.13} \frac{\mathbf{m}}{\mathbf{s}} \text{ Ans. (c)}$$

3.34 A rocket motor is operating steadily, as shown in Fig. P3.34. The products of combustion flowing out the exhaust nozzle approximate a perfect gas with a molecular weight of 28. For the given conditions calculate V_2 in ft/s.

Solution: Exit gas: Molecular weight = 28, thus $R_{\text{gas}} = 49700/28 = 1775 \text{ ft}^2/(\text{s}^2 \cdot ^\circ\text{R})$. Then,

$$\rho_{\text{exit gas}} = \frac{p}{RT} = \frac{15(144) \text{ psf}}{(1775)(1100 + 460)} \approx 0.000780 \text{ slug/ft}^2$$

For mass conservation, the exit mass flow must equal fuel + oxygen entering = 0.6 slug/s:

$$\dot{m}_{\text{exit}} = 0.6 \frac{\text{slug}}{\text{s}} = \rho_e A_e V_e = (0.00078) \frac{\pi}{4} \left(\frac{5.5}{12} \right)^2 V_e, \text{ solve for } V_e \approx \mathbf{4660 \frac{\text{ft}}{\text{s}}} \text{ Ans.}$$

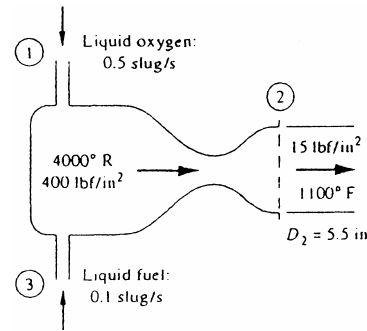

Fig. P3.34

3.35 In contrast to the liquid rocket in Fig. P3.34, the solid-propellant rocket in Fig. P3.35 is self-contained and has no entrance ducts. Using a control-volume analysis for the conditions shown in Fig. P3.35, compute the rate of mass loss of the propellant, assuming that the exit gas has a molecular weight of 28.

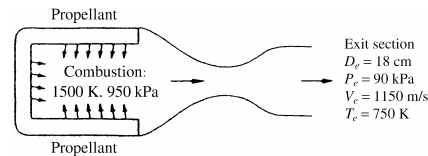

Fig. P3.35

Solution: With $M = 28$, $R = 8313/28 = 297 \text{ m}^2/(\text{s}^2 \cdot \text{K})$, hence the exit gas density is

$$\rho_{\text{exit}} = \frac{p}{RT} = \frac{90,000 \text{ Pa}}{(297)(750 \text{ K})} = 0.404 \text{ kg/m}^3$$

For a control volume enclosing the rocket engine and the outlet flow, we obtain

$$\frac{d}{dt}(m_{\text{CV}}) + \dot{m}_{\text{out}} = 0,$$

$$\text{or: } \frac{d}{dt}(m_{\text{propellant}}) = -\dot{m}_{\text{exit}} = -\rho_e A_e V_e = -(0.404)(\pi/4)(0.18)^2(1150) \approx \mathbf{-11.8 \frac{\text{kg}}{\text{s}}} \text{ Ans.}$$

3.36 The jet pump in Fig. P3.36 injects water at $U_1 = 40$ m/s through a 3-in pipe and entrains a secondary flow of water $U_2 = 3$ m/s in the annular region around the small pipe. The two flows become fully mixed down-stream, where U_3 is approximately constant. For steady incompressible flow, compute U_3 in m/s.

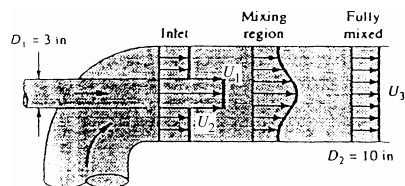

Solution: First modify the units: $D_1 = 3$ in = 0.0762 m, $D_2 = 10$ in = 0.254 m. For incompressible flow, the volume flows at inlet and exit must match:

$$Q_1 + Q_2 = Q_3, \quad \text{or:} \quad \frac{\pi}{4}(0.0762)^2(40) + \frac{\pi}{4}[(0.254)^2 - (0.0762)^2](3) = \frac{\pi}{4}(0.254)^2 U_3$$

Solve for $U_3 \approx 6.33$ m/s *Ans.*

3.37 A solid steel cylinder, 4.5 cm in diameter and 12 cm long, with a mass of 1500 grams, falls concentrically through a 5-cm-diameter vertical container filled with oil (SG = 0.89). Assuming the oil is incompressible, estimate the oil average velocity in the annular clearance between cylinder and container (a) relative to the container; and (b) relative to the cylinder.

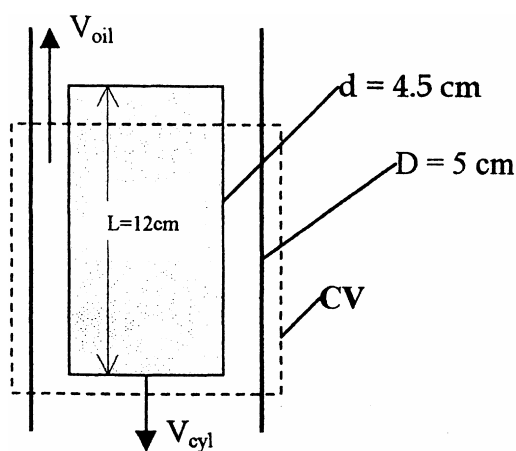

Solution: (a) The *fixed* CV shown is relative to the *container*, thus:

$$Q_{cyl} = Q_{oil}, \quad \text{or:} \quad \frac{\pi}{4}d^2V_{cyl} = \frac{\pi}{4}(D^2 - d^2)V_{oil}, \quad \text{thus} \quad V_{oil} = \frac{d^2}{D^2 - d^2}V_{cyl} \quad \text{Ans. (a)}$$

For the given dimensions ($d = 4.5$ cm and $D = 5.0$ cm), $V_{oil} = 4.26 V_{cylinder}$.

(b) If the CV moves *with* the cylinder we obtain, relative to the cylinder,

$$V_{oil \text{ relative to cylinder}} = V_{part(a)} + V_{cyl} = \frac{D^2}{D^2 - d^2}V_{cyl} \approx 5.26V_{cyl} \quad \text{Ans. (b)}$$

3.38 An incompressible fluid is squeezed between two disks by downward motion V_0 of the upper disk. Assuming 1-dimensional radial outflow, find the velocity $V(r)$.

Solution: Let the CV enclose the disks and have an upper surface moving down at speed V_0 . There is no inflow. Thus

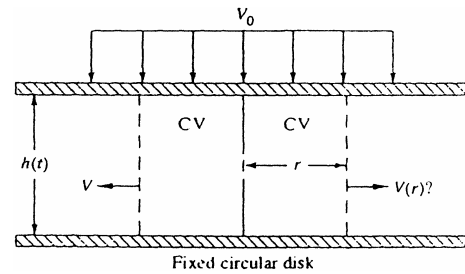

Fig. P3.38

$$\frac{d}{dt} \left(\int_{CV} \rho d\nu \right) + \int_{CS} \rho V_{out} dA = 0 = \frac{d}{dt} (\rho \pi r^2 h) + \rho 2\pi r h V,$$

$$\text{or: } r^2 \frac{dh}{dt} + 2rhV = 0, \quad \text{but } \frac{dh}{dt} = -V_0 \text{ (the disk velocity)}$$

As the disk spacing drops, $h(t) \approx h_0 - V_0 t$, the outlet velocity is $\mathbf{V} = \mathbf{V_0 r} / (2h)$. *Ans.*

3.39 A wedge splits a sheet of 20°C water, as shown in Fig. P3.39. Both wedge and sheet are very long into the paper. If the force required to hold the wedge stationary is $F = 126 \text{ N}$ per meter of depth into the paper, what is the angle θ of the wedge?

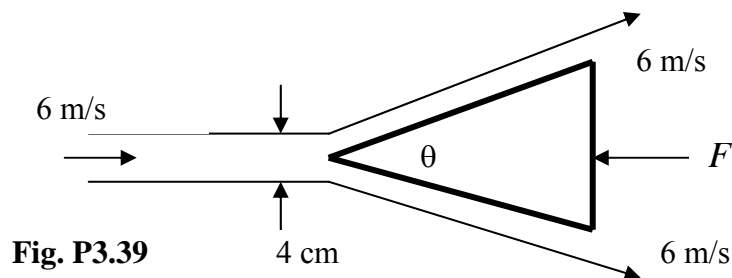

Fig. P3.39

Solution: For water take $\rho = 998 \text{ kg/m}^3$. First compute the mass flow per unit depth:

$$\dot{m}/b = \rho Vh = (998 \text{ kg/m}^3)(6 \text{ m/s})(0.04 \text{ m}) = 239.5 \text{ kg/s-m}$$

The mass flow (and velocity) are the same entering and leaving. Let the control volume surround the wedge. Then the x -momentum integral relation becomes

$$\Sigma F_x = -F = \dot{m}(u_{out} - u_{in}) = \dot{m}(V \cos \frac{\theta}{2} - V) = \dot{m}V(\cos \frac{\theta}{2} - 1)$$

$$\text{or: } -124 \text{ N/m} = (239.5 \text{ kg/s-m})(6 \text{ m/s})(\cos \frac{\theta}{2} - 1)$$

$$\text{Solve } \cos \frac{\theta}{2} = 0.9137, \quad \frac{\theta}{2} = 24^\circ, \quad \theta = \mathbf{48^\circ} \quad \text{Ans.}$$

3.40 The water jet in Fig. P3.40 strikes normal to a fixed plate. Neglect gravity and friction, and compute the force F in newtons required to hold the plate fixed.

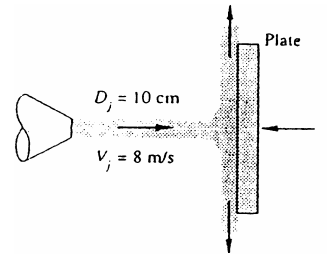

Fig. P3.40

Solution: For a CV enclosing the plate and the impinging jet, we obtain:

$$\begin{aligned} \Sigma F_x = -F &= \dot{m}_{up} u_{up} + \dot{m}_{down} u_{down} - \dot{m}_j u_j \\ &= -\dot{m}_j u_j, \quad \dot{m}_j = \rho A_j V_j \\ \text{Thus } F &= \rho A_j V_j^2 = (998)\pi(0.05)^2(8)^2 \approx \mathbf{500 \text{ N} \leftarrow} \quad \text{Ans.} \end{aligned}$$

3.41 In Fig. P3.41 the vane turns the water jet completely around. Find the maximum jet velocity V_0 for a force F_0 .

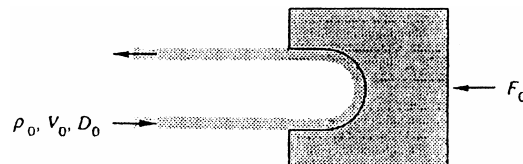

Fig. P3.41

Solution: For a CV enclosing the vane and the inlet and outlet jets,

$$\Sigma F_x = -F_0 = \dot{m}_{out} u_{out} - \dot{m}_{in} u_{in} = \dot{m}_{jet}(-V_0) - \dot{m}_{jet}(+V_0)$$

$$\text{or: } F_0 = 2\rho_0 A_0 V_0^2, \quad \text{solve for } V_0 = \sqrt{\frac{F_0}{2\rho_0(\pi/4)D_0^2}} \quad \text{Ans.}$$

3.42 A liquid of density ρ flows through the sudden contraction in Fig. P3.42 and exits to the atmosphere. Assume uniform conditions (p_1 , V_1 , D_1) at section 1 and (p_2 , V_2 , D_2) at section 2. Find an expression for the force F exerted by the fluid on the contraction.

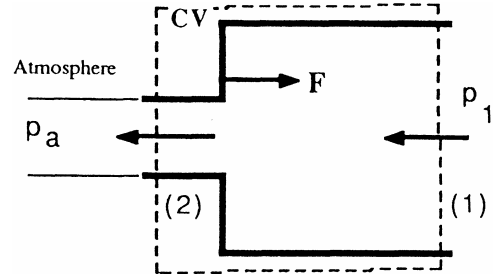

Fig. P3.42

Solution: Since the flow exits directly to the atmosphere, the exit pressure equals atmospheric: $p_2 = p_a$. Let the CV enclose sections 1 and 2, as shown. Use our trick (page 129 of the text) of subtracting p_a everywhere, so that the only non-zero pressure on the CS is at section 1, $p = p_1 - p_a$. Then write the linear momentum relation with x to the right:

$$\sum F_x = F - (p_1 - p_a)A_1 = \dot{m}_2 u_2 - \dot{m}_1 u_1, \quad \text{where } \dot{m}_2 = \dot{m}_1 = \rho_1 A_1 V_1$$

$$\text{But } u_2 = -V_2 \quad \text{and} \quad u_1 = -V_1. \quad \text{Solve for } F_{\text{on fluid}} = (p_1 - p_a)A_1 + \rho_1 A_1 V_1 (-V_2 + V_1)$$

Meanwhile, from continuity, we can relate the two velocities:

$$Q_1 = Q_2, \quad \text{or} \quad (\pi/4)D_1^2 V_1 = (\pi/4)D_2^2 V_2, \quad \text{or: } V_2 = V_1 (D_1^2 / D_2^2)$$

Finally, the force of the fluid on the wall is equal and opposite to $F_{\text{on fluid}}$, to the left:

$$F_{\text{fluid on wall}} = (p_1 - p_a)A_1 - \rho_1 A_1 V_1^2 \left[\left(\frac{D_1^2}{D_2^2} \right) - 1 \right], \quad A_1 = \frac{\pi}{4} D_1^2 \quad \text{Ans.}$$

The pressure term is larger than the momentum term, thus $F > 0$ and acts to the left.

3.43 Water at 20°C flows through a 5-cm-diameter pipe which has a 180° vertical bend, as in Fig. P3.43. The total length of pipe between flanges 1 and 2 is 75 cm. When the weight flow rate is 230 N/s, $p_1 = 165$ kPa, and $p_2 = 134$ kPa. Neglecting pipe weight, determine the total force which the flanges must withstand for this flow.

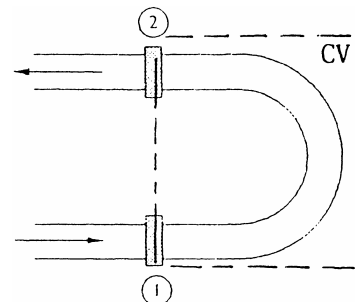

Fig. P3.43

Solution: Let the CV cut through the flanges and surround the pipe bend. The mass flow rate is $(230 \text{ N/s})/(9.81 \text{ m/s}^2) = 23.45 \text{ kg/s}$. The volume flow rate is $Q = 230/9790 = 0.0235 \text{ m}^3/\text{s}$. Then the pipe inlet and exit velocities are the same magnitude:

$$V_1 = V_2 = V = Q/A = \frac{0.0235 \text{ m}^3/\text{s}}{(\pi/4)(0.05 \text{ m})^2} \approx 12.0 \frac{\text{m}}{\text{s}}$$

Subtract p_a everywhere, so only p_1 and p_2 are non-zero. The horizontal force balance is:

$$\begin{aligned} \sum F_x &= F_{x,\text{flange}} + (p_1 - p_a)A_1 + (p_2 - p_a)A_2 = \dot{m}_2 u_2 - \dot{m}_1 u_1 \\ &= F_{x,\text{fl}} + (64000) \frac{\pi}{4} (0.05)^2 + (33000) \frac{\pi}{4} (0.05)^2 = (23.45)(-12.0 - 12.0 \text{ m/s}) \\ \text{or: } F_{x,\text{flange}} &= -126 - 65 - 561 \approx \mathbf{-750 \text{ N}} \quad \text{Ans.} \end{aligned}$$

The total x -directed force on the flanges acts to the left. The vertical force balance is

$$\sum F_y = F_{y,\text{flange}} = W_{\text{pipe}} + W_{\text{fluid}} = 0 + (9790) \frac{\pi}{4} (0.05)^2 (0.75) \approx \mathbf{14 \text{ N}} \quad \text{Ans.}$$

Clearly the fluid weight is pretty small. The largest force is due to the 180° turn.

3.44 Consider uniform flow past a cylinder with a V-shaped wake, as shown. Pressures at (1) and (2) are equal. Let b be the width into the paper. Find a formula for the force F on the cylinder due to the flow. Also compute $CD = F/(\rho U^2 L b)$.

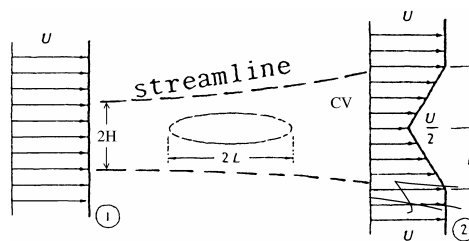

Fig. P3.44

Solution: The proper CV is the entrance (1) and exit (2) plus *streamlines* above and below which hit the top and bottom of the wake, as shown. Then steady-flow continuity yields,

$$0 = \int_2 \rho u \, dA - \int_1 \rho u \, dA = 2 \int_0^L \rho \frac{U}{2} \left(1 + \frac{y}{L}\right) b \, dy - 2\rho U b H,$$

where $2H$ is the inlet height. Solve for $H = 3L/4$.

Now the linear momentum relation is used. Note that the drag force F is to the right (force of the fluid on the body) thus the force F of the body on fluid is to the left. We obtain,

$$\Sigma F_x = 0 = \int_2 u \rho u \, dA - \int_1 u \rho u \, dA = 2 \int_0^L \frac{U}{2} \left(1 + \frac{y}{L}\right) \rho \frac{U}{2} \left(1 + \frac{y}{L}\right) b \, dy - 2H \rho U^2 b = -F_{\text{drag}}$$

$$\text{Use } H = \frac{3L}{4}, \text{ then } F_{\text{drag}} = \frac{3}{2} \rho U^2 L b - \frac{7}{6} \rho U^2 L b \approx \frac{1}{3} \rho U^2 L b \quad \text{Ans.}$$

The dimensionless force, or drag coefficient $F/(\rho U^2 L b)$, equals **CD = 1/3**. *Ans.*

P3.45 A 12-cm-diameter pipe, containing water flowing at 200 N/s, is capped by an orifice plate, as in Fig. P3.45. The exit jet is 25 mm in diameter. The pressure in the pipe at section 1 is 800 kPa-gage. Calculate the force F required to hold the orifice plate.

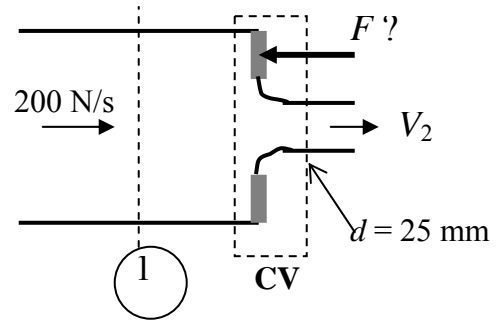

Fig. P3.45

Solution: For water take $\rho = 998 \text{ kg/m}^3$. This is a straightforward x -momentum problem. First evaluate the mass flow and the two velocities:

$$\dot{m} = \frac{\dot{w}}{g} = \frac{200 \text{ N/s}}{9.81 \text{ m/s}^2} = 20.4 \frac{\text{kg}}{\text{s}} ; V_1 = \frac{\dot{m}}{\rho A_1} = \frac{20.4 \text{ kg/s}}{(998 \text{ kg/m}^3)(\pi/4)(0.12 \text{ m})^2} = 1.81 \frac{\text{m}}{\text{s}}$$

$$V_2 = \frac{\dot{m}}{\rho A_2} = \frac{20.4 \text{ kg/s}}{(998 \text{ kg/m}^3)(\pi/4)(0.025 \text{ m})^2} = 41.6 \frac{\text{m}}{\text{s}}$$

Now apply the x -momentum relation for a control volume surrounding the plate:

$$\Sigma F_x = -F + p_{1,\text{gage}} A_1 = \dot{m}(V_2 - V_1) , \text{ or :}$$

$$F = (800000 \text{ Pa}) \frac{\pi}{4} (0.12 \text{ m})^2 - (20.4 \frac{\text{kg}}{\text{s}})(41.6 - 1.81 \frac{\text{m}}{\text{s}}) = 9048 - 812 = \mathbf{8240 \text{ N}} \text{ Ans.}$$

3.46 When a jet strikes an inclined plate, it breaks into two jets of equal velocity V but unequal fluxes αQ at (2) and $(1 - \alpha)Q$ at (3), as shown. Find α , assuming that the tangential force on the plate is zero. Why doesn't the result depend upon the properties of the jet flow?

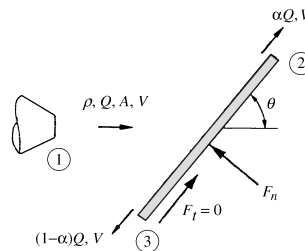

Fig. P3.46

Solution: Let the CV enclose all three jets and the surface of the plate. Analyze the force and momentum balance *tangential* to the plate:

$$\begin{aligned} \sum F_t = F_t = 0 &= \dot{m}_2 V + \dot{m}_3(-V) - \dot{m}_1 V \cos\theta \\ &= \alpha \dot{m} V - (1 - \alpha) \dot{m} V - \dot{m} V \cos\theta = 0, \quad \text{solve for } \alpha = \frac{1}{2}(1 + \cos\theta) \quad \text{Ans.} \end{aligned}$$

The jet mass flow cancels out. Jet (3) has a fractional flow $(1 - \alpha) = (1/2)(1 - \cos\theta)$.

3.47 A liquid jet V_j of diameter D_j strikes a fixed cone and deflects back as a conical sheet at the same velocity. Find the cone angle θ for which the restraining force $F = (3/2)\rho A_j V_j^2$.

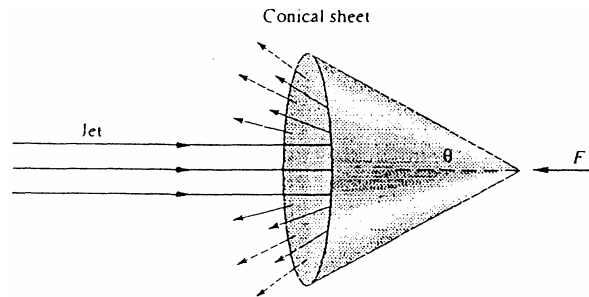

Fig. P3.47

Solution: Let the CV enclose the cone, the jet, and the sheet. Then,

$$\sum F_x = -F = \dot{m}_{\text{out}} u_{\text{out}} - \dot{m}_{\text{in}} u_{\text{in}} = \dot{m}(-V_j \cos\theta) - \dot{m} V_j, \quad \text{where } \dot{m} = \rho A_j V_j$$

$$\text{Solve for } F = \rho A_j V_j^2 (1 + \cos\theta) = \frac{3}{2} \rho A_j V_j^2 \quad \text{if } \cos\theta = \frac{1}{2} \quad \text{or } \theta = 60^\circ \quad \text{Ans.}$$

3.48 The small boat is driven at steady speed V_0 by compressed air issuing from a 3-cm-diameter hole at $V_e = 343$ m/s and $p_e = 1$ atm, $T_e = 30^\circ\text{C}$. Neglect air drag. The hull drag is kV_0^2 , where $k = 19$ N·s²/m². Estimate the boat speed V_0 .

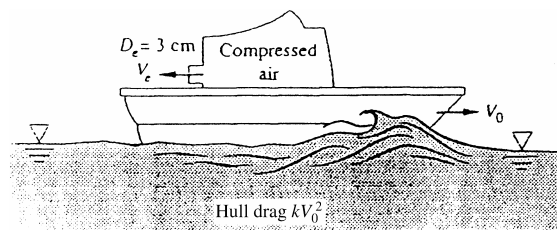

Fig. P3.48

Solution: For a CV enclosing the boat and *moving to the right at boat speed* V_o , the air appears to leave the left side at speed $(V_o + V_e)$. The air density is $\rho_e/RT_e \approx 1.165 \text{ kg/m}^3$. The only mass flow across the CS is the air moving to the left. The force balance is

$$\Sigma F_x = -\text{Drag} = -kV_o^2 = \dot{m}_{\text{out}}u_{\text{out}} = [\rho_e A_e (V_o + V_e)](-V_o - V_e),$$

$$\text{or: } \rho_e A_e (V_o + V_e)^2 = kV_o^2, \quad (1.165)(\pi/4)(0.03)^2 (V_o + 343)^2 = 19V_o^2$$

work out the numbers: $(V_o + 343) = V_o \sqrt{(23060)}$, solve for $V_o = 2.27 \text{ m/s}$ *Ans.*

3.49 The horizontal nozzle in Fig. P3.49 has $D_1 = 12 \text{ in}$, $D_2 = 6 \text{ in}$, with $p_1 = 38 \text{ psia}$ and $V_2 = 56 \text{ ft/s}$. For water at 20°C , find the force provided by the flange bolts to hold the nozzle fixed.

Solution: For an open jet, $p_2 = p_a = 15 \text{ psia}$. Subtract p_a everywhere so the only nonzero pressure is $p_1 = 38 - 15 = 23 \text{ psig}$.

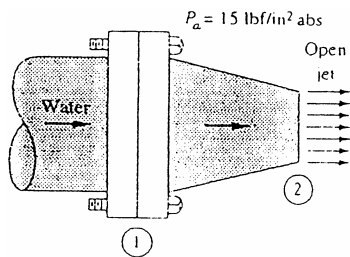

Fig. P3.49

The mass balance yields the inlet velocity:

$$V_1 \frac{\pi}{4} (12)^2 = (56) \frac{\pi}{4} (6)^2, \quad V_1 = 14 \frac{\text{ft}}{\text{s}}$$

The density of water is 1.94 slugs per cubic foot. Then the horizontal force balance is

$$\sum F_x = -F_{\text{bolts}} + (23 \text{ psig}) \frac{\pi}{4} (12 \text{ in})^2 = \dot{m}_2 u_2 - \dot{m}_1 u_1 = \dot{m} (V_2 - V_1)$$

$$\text{Compute } F_{\text{bolts}} = 2601 - (1.94) \frac{\pi}{4} (1 \text{ ft})^2 \left(14 \frac{\text{ft}}{\text{s}} \right) \left(56 - 14 \frac{\text{ft}}{\text{s}} \right) \approx \mathbf{1700 \text{ lbf}} \quad \text{Ans.}$$

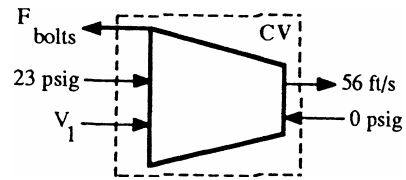

3.50 The jet engine in Fig. P3.50 admits air at 20°C and 1 atm at (1), where $A_1 = 0.5 \text{ m}^2$ and $V_1 = 250 \text{ m/s}$. The fuel-air ratio is 1:30. The air leaves section (2) at 1 atm, $V_2 = 900 \text{ m/s}$, and $A_2 = 0.4 \text{ m}^2$. Compute the test stand support reaction R_x needed.

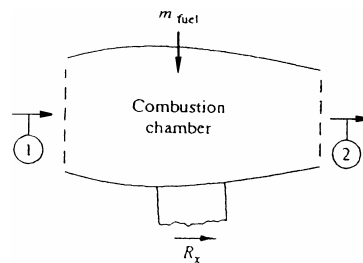

Fig. P3.50

Solution: $\rho_1 = p/RT = 101350/[287(293)] = 1.205 \text{ kg/m}^3$. For a CV enclosing the engine,

$$\dot{m}_1 = \rho_1 A_1 V_1 = (1.205)(0.5)(250) = 151 \text{ kg/s}, \quad \dot{m}_2 = 151 \left(1 + \frac{1}{30} \right) = 156 \text{ kg/s}$$

$$\sum F_x = R_x = \dot{m}_2 u_2 - \dot{m}_1 u_1 - \dot{m}_{\text{fuel}} u_{\text{fuel}} = 156(900) - 151(250) - 0 \approx \mathbf{102,000 \text{ N}} \quad \text{Ans.}$$

3.51 A liquid jet of velocity V_j and area A_j strikes a single 180° bucket on a turbine wheel rotating at angular velocity Ω . Find an expression for the power P delivered. At what Ω is the power a maximum? How does the analysis differ if there are many buckets, so the jet continually strikes at least one?

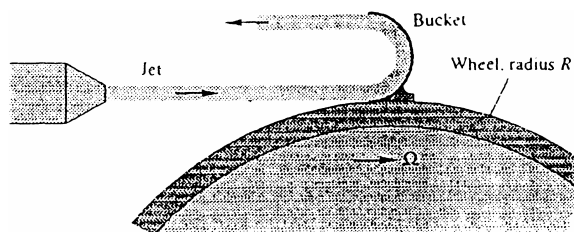
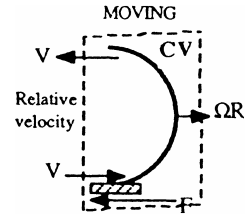

Fig. P3.51

Solution: Let the CV enclose the bucket and jet and let it move to the right at bucket velocity $V = \Omega R$, so that the jet enters the CV at relative speed $(V_j - \Omega R)$. Then,



$$\begin{aligned} \sum F_x &= -F_{\text{bucket}} = \dot{m}u_{\text{out}} - \dot{m}u_{\text{in}} \\ &= \dot{m}[-(V_j - \Omega R)] - \dot{m}[V_j - \Omega R] \end{aligned}$$

$$\text{or: } F_{\text{bucket}} = 2\dot{m}(V_j - \Omega R) = 2\rho A_j(V_j - \Omega R)^2,$$

$$\text{and the power is } P = \Omega R F_{\text{bucket}} = 2\rho A_j \Omega R (V_j - \Omega R)^2 \quad \text{Ans.}$$

Maximum power is found by differentiating this expression:

$$\frac{dP}{d\Omega} = 0 \quad \text{if } \Omega R = \frac{V_j}{3} \quad \text{Ans.} \quad \left(\text{whence } P_{\text{max}} = \frac{8}{27} \rho A_j V_j^3 \right)$$

If there were many buckets, then the *full* jet mass flow would be available for work:

$$\dot{m}_{\text{available}} = \rho A_j V_j, \quad P = 2\rho A_j V_j \Omega R (V_j - \Omega R), \quad P_{\text{max}} = \frac{1}{2} \rho A_j V_j^3 \quad \text{at } \Omega R = \frac{V_j}{2} \quad \text{Ans.}$$

3.52 The vertical gate in a water channel is partially open, as in Fig. P3.52. Assuming no change in water level and a hydrostatic pressure distribution, derive an expression for the streamwise force F_x on one-half of the gate as a function of $(\rho, h, w, \theta, V_1)$. Apply your result to the case of water at 20°C , $V_1 = 0.8 \text{ m/s}$, $h = 2 \text{ m}$, $w = 1.5 \text{ m}$, and $\theta = 50^\circ$.

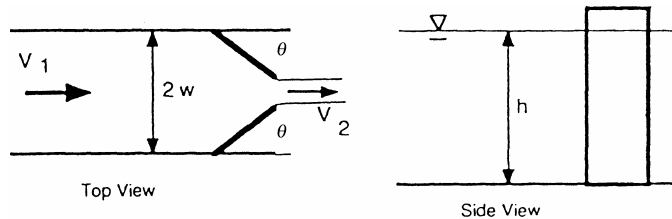

Solution: Let the CV enclose sections (1) and (2), the centerline, and the inside of the gate, as shown. The volume flows are

$$V_1 W h = V_2 B h, \quad \text{or: } V_2 = V_1 \frac{W}{B} = V_1 \frac{1}{1 - \sin \theta}$$

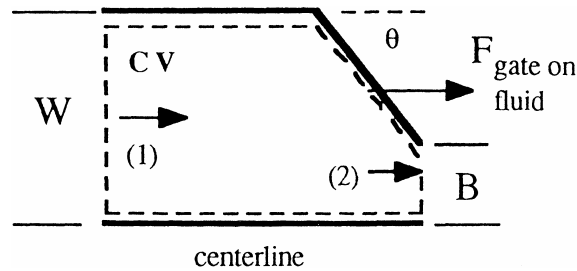

since $B = W - W \sin \theta$. The problem is unrealistically idealized by letting the water depth remain *constant*, whereas actually the depth would decrease at section 2. Thus we have no net hydrostatic pressure force on the CV in this model! The force balance reduces to

$$\sum F_x = F_{\text{gate on fluid}} = \dot{m}V_2 - \dot{m}V_1, \quad \text{where } \dot{m} = \rho WhV_1 \quad \text{and} \quad V_2 = V_1/(1 - \sin \theta)$$

$$\text{Solve for } F_{\text{fluid on gate}} = -\rho WhV_1^2 \left[\frac{1}{(1 - \sin \theta)} - 1 \right] \quad (\text{to the left}) \quad \text{Ans.}$$

This is unrealistic—the pressure force would turn this gate force around to the right. For the particular data given, $W = 1.5 \text{ m}$, $\theta = 50^\circ$, $B = W(1 - \sin \theta) = 0.351 \text{ m}$, $V_1 = 0.8 \text{ m/s}$, thus $V_2 = V_1/(1 - \sin 50^\circ) = 3.42 \text{ m/s}$, $\rho = 998 \text{ kg/m}^3$, $h = 2 \text{ m}$. Thus compute

$$F_{\text{fluid on gate}} = (998)(2)(1.5)(0.8)^2 \left[\frac{1}{1 - \sin 50^\circ} - 1 \right] \approx \mathbf{6300 \text{ N} \leftarrow} \quad \text{Ans.}$$

3.53 Consider incompressible flow in the entrance of a circular tube, as in Fig. P3.53. The inlet flow is uniform, $u_1 = U_0$. The flow at section 2 is developed pipe flow. Find the wall drag force F as a function of (p_1, p_2, ρ, U_0, R) if the flow at section 2 is

(a) Laminar: $u_2 = u_{\text{max}} \left(1 - \frac{r^2}{R^2} \right)$

(b) Turbulent: $u_2 \approx u_{\text{max}} \left(1 - \frac{r}{R} \right)^{1/7}$

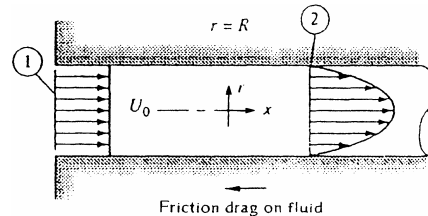

Fig. P3.53

Solution: The CV encloses the inlet and outlet and is just inside the walls of the tube. We don't need to establish a relation between u_{max} and U_0 by integration, because the results for these two profiles are given in the text. Note that $U_0 = u_{\text{av}}$ at section (2). Now use these results as needed for the balance of forces:

$$\sum F_x = (p_1 - p_2)\pi R^2 - F_{\text{drag}} = \int_0^R u_2(\rho u_2 2\pi r dr) - U_0(\rho \pi R^2 U_0) = \rho \pi R^2 U_0^2 (\beta_2 - 1)$$

We simply insert the appropriate momentum-flux factors β from p. 136 of the text:

(a) Laminar: $\mathbf{F}_{\text{drag}} = (\mathbf{p}_1 - \mathbf{p}_2)\pi R^2 - (1/3)\rho\pi R^2 U_0^2$ Ans. (a)

(b) Turbulent, $\beta_2 \approx 1.020$: $\mathbf{F}_{\text{drag}} = (\mathbf{p}_1 - \mathbf{p}_2)\pi R^2 - 0.02\rho\pi R^2 U_0^2$ Ans. (b)

3.54 For the pipe-flow reducing section of Fig. P3.54, $D_1 = 8$ cm, $D_2 = 5$ cm, and $p_2 = 1$ atm. All fluids are at 20°C . If $V_1 = 5$ m/s and the manometer reading is $h = 58$ cm, estimate the total horizontal force resisted by the flange bolts.

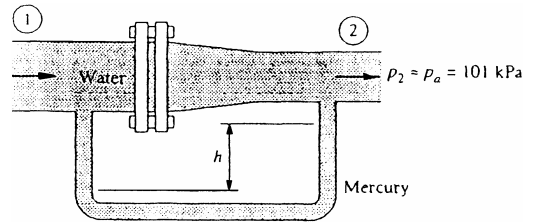

Fig. P3.54

Solution: Let the CV cut through the bolts and through section 2. For the given manometer reading, we may compute the upstream pressure:

$$p_1 - p_2 = (\gamma_{\text{merc}} - \gamma_{\text{water}})h = (132800 - 9790)(0.58 \text{ m}) \approx 71300 \text{ Pa (gage)}$$

Now apply conservation of mass to determine the exit velocity:

$$Q_1 = Q_2, \text{ or } (5 \text{ m/s})(\pi/4)(0.08 \text{ m})^2 = V_2(\pi/4)(0.05)^2, \text{ solve for } V_2 \approx 12.8 \text{ m/s}$$

Finally, write the balance of horizontal forces:

$$\sum F_x = -F_{\text{bolts}} + p_{1,\text{gage}}A_1 = \dot{m}(V_2 - V_1),$$

$$\text{or: } F_{\text{bolts}} = (71300) \frac{\pi}{4} (0.08)^2 - (998) \frac{\pi}{4} (0.08)^2 (5.0)[12.8 - 5.0] \approx \mathbf{163 \text{ N}} \text{ Ans.}$$

3.55 In Fig. P3.55 the jet strikes a vane which moves to the right at constant velocity V_c on a frictionless cart. Compute (a) the force F_x required to restrain the cart and (b) the power P delivered to the cart. Also find the cart velocity for which (c) the force F_x is a maximum and (d) the power P is a maximum.

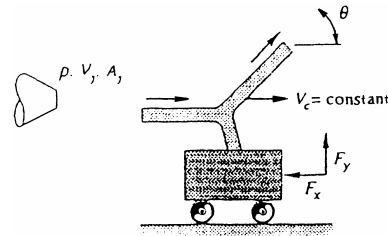

Fig. P3.55

Solution: Let the CV surround the vane and cart and move to the right at cart speed. The jet strikes the vane at *relative* speed $V_j - V_c$. The cart does not accelerate, so the horizontal force balance is

$$\sum F_x = -F_x = [\rho A_j (V_j - V_c)](V_j - V_c) \cos \theta - \rho A_j (V_j - V_c)^2$$

$$\text{or: } F_x = \rho A_j (V_j - V_c)^2 (1 - \cos \theta) \text{ Ans. (a)}$$

The power delivered is $P = V_c F_x = \rho A_j V_c (V_j - V_c)^2 (1 - \cos \theta)$ Ans. (b)

The maximum force occurs when the cart is fixed, or: $V_c = 0$ Ans. (c)

The maximum power occurs when $dP/dV_c = 0$, or: $V_c = V_j/3$ Ans. (d)

3.56 Water at 20°C flows steadily through the box in Fig. P3.56, entering station (1) at 2 m/s. Calculate the (a) horizontal; and (b) vertical forces required to hold the box stationary against the flow momentum.

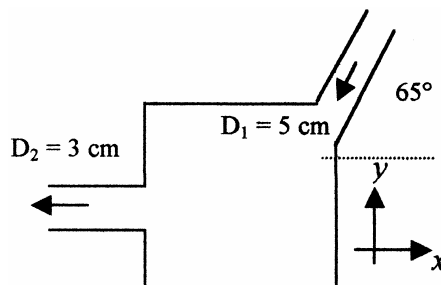

Fig. P3.56

Solution: (a) Summing horizontal forces,

$$\sum F_x = R_x = \dot{m}_{out} u_{out} - \dot{m}_{in} u_{in}$$

$$R_x = (998) \left[\left(\frac{\pi}{4} \right) (0.03^2) (5.56) \right] (-5.56) - (998) \left[\left(\frac{\pi}{4} \right) (0.05^2) (2) \right] (-2)(\cos 65^\circ)$$

$$= -18.46 \text{ N} \quad \text{Ans.}$$

$$R_x = 18.5 \text{ N} \quad \text{to the left}$$

$$\sum F_y = R_y = -\dot{m}_{in} u_{in} = -(998) \left(\frac{\pi}{4} \right) (0.05^2) (2) (-2 \sin 65^\circ) = 7.1 \text{ N} \quad \text{up}$$

3.57 Water flows through the duct in Fig. P3.57, which is 50 cm wide and 1 m deep into the paper. Gate BC completely closes the duct when $\beta = 90^\circ$. Assuming one-dimensional flow, for what angle β will the force of the exit jet on the plate be 3 kN?

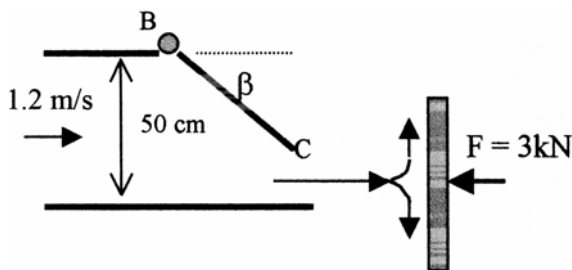

Fig. P3.57

Solution: The steady flow equation applied to the duct, $Q_1 = Q_2$, gives the jet velocity as $V_2 = V_1(1 - \sin \beta)$. Then for a force summation for a control volume around the jet's impingement area,

$$\sum F_x = F = \dot{m}_j V_j = \rho(h_1 - h_1 \sin \beta)(D) \left[\frac{1}{1 - \sin \beta} \right]^2 (V_1^2)$$

$$\beta = \sin^{-1} \left[1 - \frac{\rho h_1 D V_1^2}{F} \right] = \sin^{-1} \left[1 - \frac{(998)(0.5)(1)(1.2)^2}{3000} \right] = 49.5^\circ \quad \text{Ans.}$$

3.58 The water tank in Fig. P3.58 stands on a frictionless cart and feeds a jet of diameter 4 cm and velocity 8 m/s, which is deflected 60° by a vane. Compute the tension in the supporting cable.

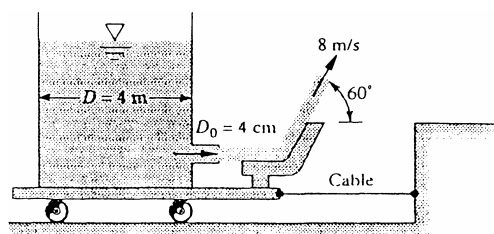

Fig. P3.58

Solution: The CV should surround the tank and wheels and cut through the cable and the exit water jet. Then the horizontal force balance is

$$\sum F_x = T_{\text{cable}} = \dot{m}_{\text{out}} u_{\text{out}} = (\rho A V_j) V_j \cos \theta = 998 \left(\frac{\pi}{4} \right) (0.04)^2 (8)^2 \cos 60^\circ = \mathbf{40 \text{ N}} \quad \text{Ans.}$$

3.59 A pipe flow expands from (1) to (2), causing eddies as shown. Using the given CV and assuming $p = p_1$ on the corner annular ring, show that the downstream pressure is given by, neglecting wall friction,

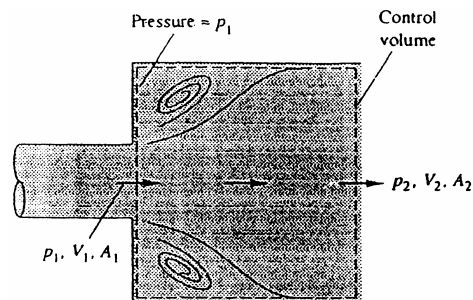

Fig. P3.59

Solution: From mass conservation, $V_1 A_1 = V_2 A_2$. The balance of x-forces gives

$$\sum F_x = p_1 A_1 + p_{\text{wall}} (A_2 - A_1) - p_2 A_2 = \dot{m} (V_2 - V_1), \quad \text{where } \dot{m} = \rho A_1 V_1, \quad V_2 = V_1 A_1 / A_2$$

$$\text{If } p_{\text{wall}} = p_1 \text{ as given, this reduces to } \mathbf{p_2 = p_1 + \rho \frac{A_1}{A_2} V_1^2 \left(1 - \frac{A_1}{A_2} \right)} \quad \text{Ans.}$$

3.60 Water at 20°C flows through the elbow in Fig. P3.60 and exits to the atmosphere. The pipe diameter is $D_1 = 10$ cm, while $D_2 = 3$ cm. At a weight flow rate of 150 N/s, the pressure $p_1 = 2.3$ atm (gage). Neglecting the weight of water and elbow, estimate the force on the flange bolts at section 1.

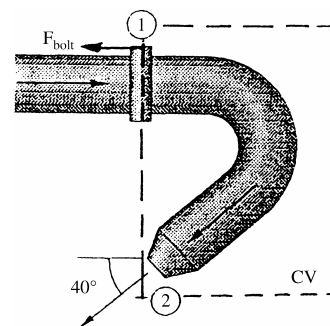

Fig. P3.60

Solution: First, from the weight flow, compute $Q = (150 \text{ N/s})/(9790 \text{ N/m}^3) = 0.0153 \text{ m}^3/\text{s}$. Then the velocities at (1) and (2) follow from the known areas:

$$V_1 = \frac{Q}{A_1} = \frac{0.0153}{(\pi/4)(0.1)^2} = 1.95 \frac{\text{m}}{\text{s}}; \quad V_2 = \frac{Q}{A_2} = \frac{0.0153}{(\pi/4)(0.03)^2} = 21.7 \frac{\text{m}}{\text{s}}$$

The mass flow is $\rho A_1 V_1 = (998)(\pi/4)(0.1)^2(1.95) \approx 15.25 \text{ kg/s}$. Then the balance of forces in the x -direction is:

$$\sum F_x = -F_{\text{bolts}} + p_1 A_1 = \dot{m} u_2 - \dot{m} u_1 = \dot{m}(-V_2 \cos 40^\circ - V_1)$$

$$\text{solve for } F_{\text{bolts}} = (2.3 \times 101350) \frac{\pi}{4} (0.1)^2 + 15.25(21.7 \cos 40^\circ + 1.95) \approx \mathbf{2100 \text{ N}} \quad \text{Ans.}$$

3.61 A 20°C water jet strikes a vane on a tank with frictionless wheels, as shown. The jet turns and falls into the tank without spilling. If $\theta = 30^\circ$, estimate the horizontal force F needed to hold the tank stationary.

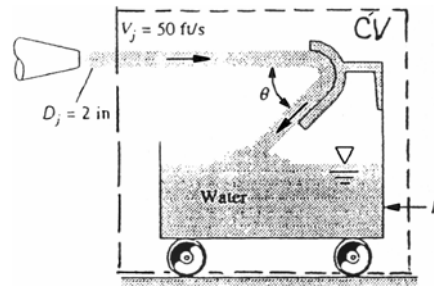

Fig. P3.61

Solution: The CV surrounds the tank and wheels and cuts through the jet, as shown. We have to *assume that the splashing into the tank does not increase the x -momentum of the water in the tank*. Then we can write the CV horizontal force relation:

$$\sum F_x = -F = \frac{d}{dt} \left(\int u \rho dV \right)_{\text{tank}} - \dot{m}_{\text{in}} u_{\text{in}} = 0 - \dot{m} V_{\text{jet}} \quad \text{independent of } \theta$$

$$\text{Thus } F = \rho A_j V_j^2 = \left(1.94 \frac{\text{slug}}{\text{ft}^3} \right) \frac{\pi}{4} \left(\frac{2}{12} \text{ ft} \right)^2 \left(50 \frac{\text{ft}}{\text{s}} \right)^2 \approx \mathbf{106 \text{ lbf}} \quad \text{Ans.}$$

3.62 Water at 20°C exits to the standard sea-level atmosphere through the split nozzle in Fig. P3.62. Duct areas are $A_1 = 0.02 \text{ m}^2$ and $A_2 = A_3 = 0.008 \text{ m}^2$. If $p_1 = 135 \text{ kPa}$ (absolute) and the flow rate is $Q_2 = Q_3 = 275 \text{ m}^3/\text{h}$, compute the force on the flange bolts at section 1.

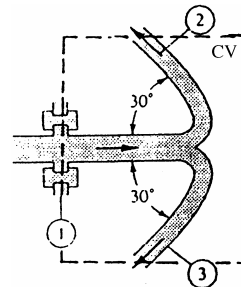

Fig. P3.62

Solution: With the known flow rates, we can compute the various velocities:

$$V_2 = V_3 = \frac{275/3600 \text{ m}^3/\text{s}}{0.008 \text{ m}^2} = 9.55 \frac{\text{m}}{\text{s}}; \quad V_1 = \frac{550/3600}{0.02} = 7.64 \frac{\text{m}}{\text{s}}$$

The CV encloses the split nozzle and cuts through the flange. The balance of forces is

$$\sum F_x = -F_{\text{bolts}} + p_{1,\text{gage}}A_1 = \rho Q_2(-V_2 \cos 30^\circ) + \rho Q_3(-V_3 \cos 30^\circ) - \rho Q_1(+V_1),$$

$$\begin{aligned} \text{or: } F_{\text{bolts}} &= 2(998) \left(\frac{275}{3600} \right) (9.55 \cos 30^\circ) + 998 \left(\frac{550}{3600} \right) (7.64) + (135000 - 101350)(0.02) \\ &= 1261 + 1165 + 673 \approx \mathbf{3100 \text{ N}} \quad \text{Ans.} \end{aligned}$$

P3.63 In Example 3.10, the gate force F is a function of both water depth and velocity. (a) Non-dimensionalize the force by dividing by $(\rho g b h_1^2)$ and plot this force versus $h_2/h_1 \leq 1.0$. (b) The plot involves a second dimensionless parameter involving V_1 . Do you know its name? (c) For what condition h_2/h_1 is the force largest? (d) For small values of V_1 , the force becomes negative (to the right), which is totally unrealistic. Can you explain why?

Solution: The original solution for gate force in Ex. 3.10 was

$$F_{\text{gate}} = \frac{\rho}{2} g b h_1^2 \left[1 - \left(\frac{h_2}{h_1} \right)^2 \right] - \rho h_1 b V_1^2 \left(\frac{h_1}{h_2} - 1 \right)$$

(a) When we divide through by $(\rho g b h_1^2)$, we obtain the dimensionless force relation

$$\frac{F}{\rho g b h_1^2} = \frac{1}{2} \left[1 - \left(\frac{h_2}{h_1} \right)^2 \right] - \left(\frac{V_1^2}{g h_1} \right) \left(\frac{h_1}{h_2} - 1 \right) \quad \text{Ans.(a)}$$

(b) On the right hand side is a new dimensionless group, $[V_1^2/(g h_1)]$, which is called the **Froude number** at section 1. *Ans.(b)*

As an extra requirement of part (a), we can plot the dimensionless force versus $h_2/h_1 \leq 1.0$ for various values of the Froude number $[V_1^2/(g h_1)]$, as follows:

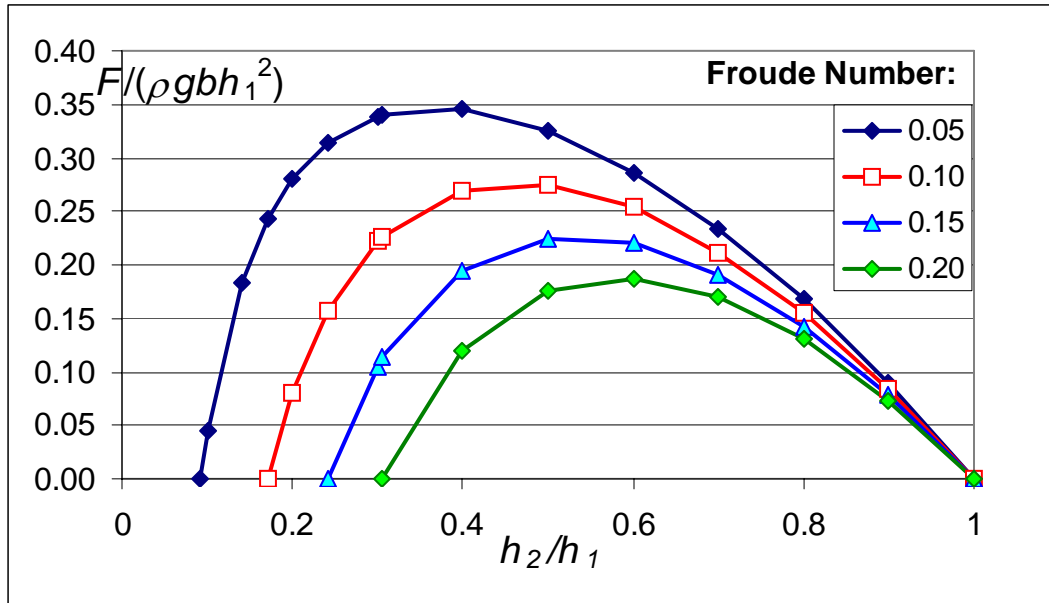

(c) For everything held constant except h_2 , the maximum force is found by differentiation:

$$\frac{dF}{dh_2} = 0 \quad \text{which yields} \quad h_2 = (V_1^2 h_1^2 / g)^{1/3} \quad \text{or} \quad \frac{h_2}{h_1} = \left(\frac{V_1^2}{g h_1}\right)^{1/3} \quad \text{Ans.(c)}$$

(d) We see that, at small h_2/h_1 , the force becomes *negative* and is not plotted. Presently the writer does not know exactly why this happens, but when it does, Fr_2 is very large, > 8 .

3.64 The 6-cm-diameter 20°C water jet in Fig. P3.64 strikes a plate containing a hole of 4-cm diameter. Part of the jet passes through the hole, and part is deflected. Determine the horizontal force required to hold the plate.

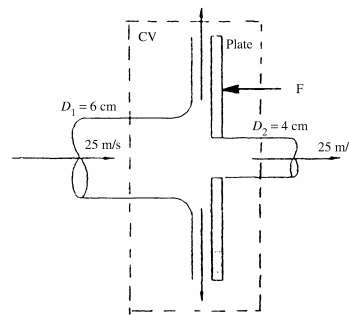

Fig. P3.64

Solution: First determine the incoming flow and the flow through the hole:

$$Q_{\text{in}} = \frac{\pi}{4} (0.06)^2 (25) = 0.0707 \frac{\text{m}^3}{\text{s}}, \quad Q_{\text{hole}} = \frac{\pi}{4} (0.04)^2 (25) = 0.0314 \frac{\text{m}^3}{\text{s}}$$

Then, for a CV enclosing the plate and the two jets, the horizontal force balance is

$$\begin{aligned}\sum F_x &= -F_{\text{plate}} = \dot{m}_{\text{hole}} u_{\text{hole}} + \dot{m}_{\text{upper}} u_{\text{upper}} + \dot{m}_{\text{lower}} u_{\text{lower}} - \dot{m}_{\text{in}} u_{\text{in}} \\ &= (998)(0.0314)(25) + 0 + 0 - (998)(0.0707)(25) \\ &= 784 - 1764, \text{ solve for } \mathbf{F \approx 980 \text{ N (to left) } \textit{ Ans.}}\end{aligned}$$

3.65 The box in Fig. P3.65 has three 0.5-in holes on the right side. The volume flows of 20°C water shown are steady, but the details of the interior are not known. Compute the force, if any, which this water flow causes on the box.

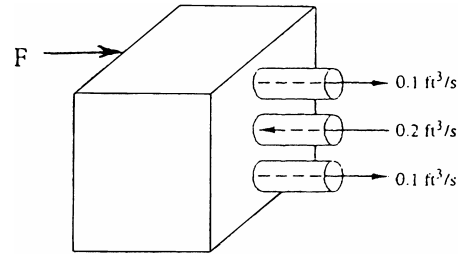

Fig. P3.65

Solution: First we need to compute the velocities through the various holes:

$$V_{\text{top}} = V_{\text{bottom}} = \frac{0.1 \text{ ft}^3/\text{s}}{(\pi/4)(0.5/12)^2} = 73.3 \text{ ft/s}; \quad V_{\text{middle}} = 2V_{\text{top}} = 146.6 \text{ ft/s}$$

Pretty fast, but do-able, I guess. Then make a force balance for a CV enclosing the box:

$$\begin{aligned}\sum F_x = F_{\text{box}} &= -\dot{m}_{\text{in}} u_{\text{in}} + 2\dot{m}_{\text{top}} u_{\text{top}}, \quad \text{where } u_{\text{in}} = -V_{\text{middle}} \quad \text{and} \quad u_{\text{top}} = V_{\text{top}} \\ \text{Solve for } F_{\text{box}} &= (1.94)(0.2)(146.6) + 2(1.94)(0.1)(73.3) \approx \mathbf{85 \text{ lbf} \textit{ Ans.}}\end{aligned}$$

3.66 The tank in Fig. P3.66 weighs 500 N empty and contains 600 L of water at 20°C. Pipes 1 and 2 have $D = 6 \text{ cm}$ and $Q = 300 \text{ m}^3/\text{hr}$. What should the scale reading W be, in newtons?

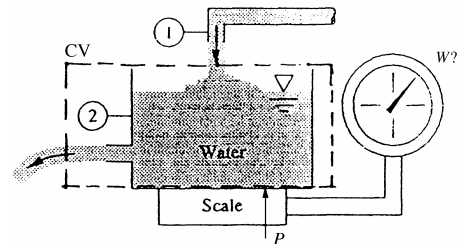

Fig. P3.66

Solution: Let the CV surround the tank, cut through the two jets, and slip just under the tank bottom, as shown. The relevant jet velocities are

$$V_1 = V_2 = \frac{Q}{A} = \frac{(300/3600) \text{ m}^3/\text{s}}{(\pi/4)(0.06 \text{ m})^2} \approx 29.5 \text{ m/s}$$

The scale reads force “P” on the tank bottom. Then the vertical force balance is

$$\sum F_z = P - W_{\text{tank}} - W_{\text{water}} = \dot{m}_2 v_2 - \dot{m}_1 v_1 = \dot{m}[0 - (-V_1)]$$

$$\text{Solve for } \mathbf{P} = 500 + 9790(0.6 \text{ m}^3) + 998 \left(\frac{300}{3600} \right) (29.5) \approx \mathbf{8800 \text{ N}} \quad \text{Ans.}$$

3.67 Gravel is dumped from a hopper, at a rate of 650 N/s, onto a moving belt, as in Fig. P3.67. The gravel then passes off the end of the belt. The drive wheels are 80 cm in diameter and rotate clockwise at 150 r/min. Neglecting system friction and air drag, estimate the power required to drive this belt.

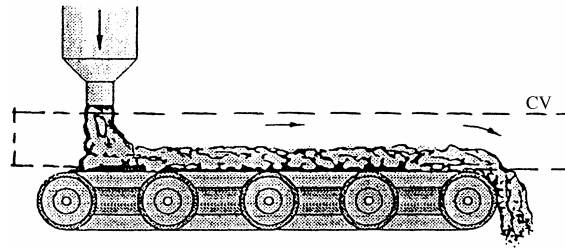

Fig. P3.67

Solution: The CV goes under the gravel on the belt and cuts through the inlet and outlet gravel streams, as shown. The no-slip belt velocity must be

$$V_{\text{belt}} = V_{\text{outlet}} = \Omega R_{\text{wheel}} = \left[150 \frac{\text{rev}}{\text{min}} 2\pi \frac{\text{rad}}{\text{rev}} \frac{1 \text{ min}}{60 \text{ s}} \right] (0.4 \text{ m}) \approx 6.28 \frac{\text{m}}{\text{s}}$$

Then the belt applies tangential force F to the gravel, and the force balance is

$$\sum F_x = F_{\text{on belt}} = \dot{m}_{\text{out}} u_{\text{out}} - \dot{m}_{\text{in}} u_{\text{in}}, \quad \text{but } u_{\text{in}} = 0.$$

$$\text{Then } F_{\text{belt}} = \dot{m} V_{\text{out}} = \left(\frac{650}{9.81} \frac{\text{kg}}{\text{s}} \right) \left(6.28 \frac{\text{m}}{\text{s}} \right) = 416 \text{ N}$$

The power required to drive the belt is $P = FV_{\text{belt}} = (416)(6.28) \approx \mathbf{2600 \text{ W}}$ Ans.

3.68 The rocket in Fig. P3.68 has a supersonic exhaust, and the exit pressure p_e is not necessarily equal to p_a . Show that the force F required to hold this rocket on the test stand is $F = \rho_e A_e V_e^2 + A_e(p_e - p_a)$. Is this force F what we term the *thrust* of the rocket?

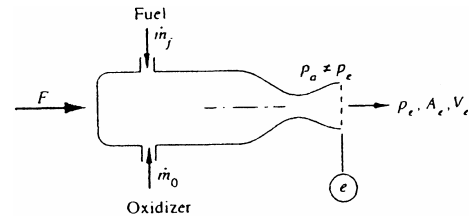

Fig. P3.68

Solution: The appropriate CV surrounds the entire rocket and cuts through the exit jet. Subtract p_a everywhere so only exit pressure $\neq 0$. The horizontal force balance is

$$\sum F_x = F - (p_e - p_a)A_e = \dot{m}_e u_e - \dot{m}_f u_f - \dot{m}_o u_o, \quad \text{but } u_f = u_o = 0, \quad \dot{m}_e = \rho_e A_e V_e$$

$$\text{Thus } \mathbf{F = \rho_e A_e V_e^2 + (p_e - p_a)A_e} \quad (\text{the } \underline{\text{thrust}}) \quad \text{Ans.}$$

3.69 A uniform rectangular plate, 40 cm long and 30 cm deep into the paper, hangs in air from a hinge at its top, 30-cm side. It is struck in its center by a horizontal 3-cm-diameter jet of water moving at 8 m/s. If the gate has a mass of 16 kg, estimate the angle at which the plate will hang from the vertical.

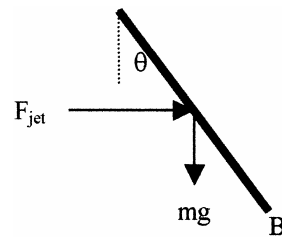

Fig. P3.69

Solution: The plate orientation can be found through force and moment balances,

$$\sum F_x = F_j = -\dot{m}_{\text{in}} u_{\text{in}} = -(998) \left(\frac{\pi}{4} \right) (0.03^2) (8^2) = 45.1 \text{ N}$$

$$\sum M_B = 0 = -(45)(0.02)(\sin \theta) + (16)(9.81)(0.02)(\cos \theta) \quad \theta = \mathbf{16^\circ}$$

3.70 The dredger in Fig. P3.70 is loading sand (SG = 2.6) onto a barge. The sand leaves the dredger pipe at 4 ft/s with a weight flux of 850 lbf/s. Estimate the tension on the mooring line caused by this loading process.

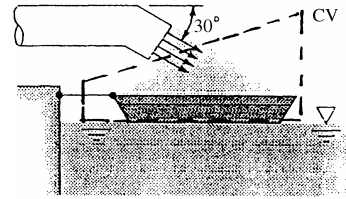

Fig. P3.70

Solution: The CV encloses the boat and cuts through the cable and the sand flow jet. Then,

$$\sum F_x = -T_{\text{cable}} = -\dot{m}_{\text{sand}} u_{\text{sand}} = -\dot{m} V_{\text{sand}} \cos \theta,$$

$$\text{or: } T_{\text{cable}} = \left(\frac{850}{32.2} \frac{\text{slug}}{\text{s}} \right) \left(4 \frac{\text{ft}}{\text{s}} \right) \cos 30^\circ \approx \mathbf{91 \text{ lbf}} \quad \text{Ans.}$$

3.71 Suppose that a deflector is deployed at the exit of the jet engine of Prob. 3.50, as shown in Fig. P3.71. What will the reaction R_x on the test stand be now? Is this reaction sufficient to serve as a braking force during airplane landing?

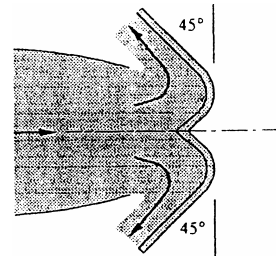

Fig. P3.71

Solution: From Prob. 3.50, recall that the essential data was

$$V_1 = 250 \text{ m/s}, \quad V_2 = 900 \text{ m/s}, \quad \dot{m}_1 = 151 \text{ kg/s}, \quad \dot{m}_2 = 156 \text{ kg/s}$$

The CV should enclose the entire engine and also the deflector, cutting through the support and the 45° exit jets. Assume (unrealistically) that the exit velocity is *still* 900 m/s. Then,

$$\sum F_x = R_x = \dot{m}_{\text{out}} u_{\text{out}} - \dot{m}_{\text{in}} u_{\text{in}}, \quad \text{where } u_{\text{out}} = -V_{\text{out}} \cos 45^\circ \quad \text{and} \quad u_{\text{in}} = V_1$$

$$\text{Then } R_x = -156(900 \cos 45^\circ) - 151(250) = -137,000 \text{ N}$$

The support reaction is to the left and equals 137 kN Ans.

3.72 A thick elliptical cylinder immersed in a water stream creates the idealized wake shown. Upstream and downstream pressures are equal, and $U_0 = 4 \text{ m/s}$, $L = 80 \text{ cm}$. Find the drag force on the cylinder per unit width into the paper. Also compute the dimensionless *drag coefficient* $CD = 2F/(\rho U_0^2 bL)$.

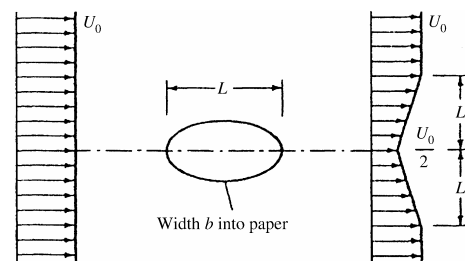

Fig. P3.72

Solution: This is a ‘numerical’ version of the “analytical” body-drag Prob. 3.44. The student still must make a CV analysis similar to Prob. P3.44 of this Manual. The wake is exactly the same shape, so the result from Prob. 3.44 holds here also:

$$F_{\text{drag}} = \frac{1}{3} \rho U_0^2 L b = \frac{1}{3} (998)(4)^2 (0.8)(1.0) \approx \mathbf{4260 \text{ N}} \quad \text{Ans.}$$

The drag coefficient is easily calculated from the above result: $\mathbf{CD = 2/3.} \quad \text{Ans.}$

3.73 A pump in a tank of water directs a jet at 45 ft/s and 200 gal/min against a vane, as shown in the figure. Compute the force F to hold the cart stationary if the jet follows (a) path A; or (b) path B. The tank holds 550 gallons of water at this instant.

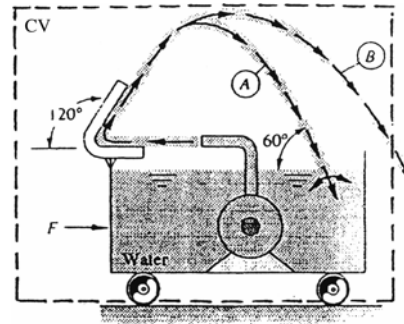

Fig. P3.73

Solution: The CV encloses the tank and passes through jet B.

(a) For jet path **A**, *no momentum flux crosses the CV*, therefore $\mathbf{F = 0} \quad \text{Ans. (a)}$

(b) For jet path **B**, there *is* momentum flux, so the x -momentum relation yields:

$$\sum F_x = F = \dot{m}_{\text{out}} u_{\text{out}} = \dot{m}_{\text{jet}} u_B$$

Now we don't really *know* u_B exactly, but we make the reasonable assumption that the jet trajectory is *frictionless* and maintains its horizontal velocity component, that is, $u_B \approx V_{\text{jet}} \cos 60^\circ$. Thus we can estimate

$$F = \dot{m} u_B = \left(1.94 \frac{\text{slug}}{\text{ft}^3} \right) \left(\frac{200}{448.8} \frac{\text{ft}^3}{\text{s}} \right) (45 \cos 60^\circ) \approx \mathbf{19.5 \text{ lbf}} \quad \text{Ans. (b)}$$

3.74 Water at 20°C flows down a vertical 6-cm-diameter tube at 300 gal/min, as in the figure. The flow then turns horizontally and exits through a 90° radial duct segment 1 cm thick, as shown. If the radial outflow is uniform and steady, estimate the forces (F_x , F_y , F_z) required to support this system against fluid momentum changes.

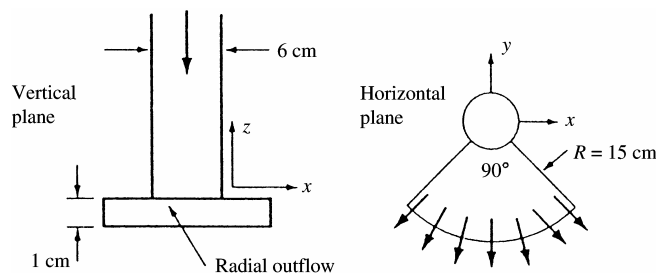

Solution: First convert $300 \text{ gal/min} = 0.01893 \text{ m}^3/\text{s}$, hence the mass flow is $\rho Q = 18.9 \text{ kg/s}$. The vertical-tube velocity (down) is $V_{\text{tube}} = 0.01893/[(\pi/4)(0.06)^2] = -6.69 \text{ k m/s}$. The exit tube area is $(\pi/2)R\Delta h = (\pi/2)(0.15)(0.01) = 0.002356 \text{ m}^2$, hence $V_{\text{exit}} = Q/A_{\text{exit}} = 0.01893/0.002356 = 8.03 \text{ m/s}$. Now estimate the force components:

$$\sum F_x = \mathbf{F}_x = \int u_{\text{out}} d\dot{m}_{\text{out}} = \int_{-45^\circ}^{+45^\circ} -V_{\text{exit}} \sin\theta \rho \Delta h R d\theta \equiv \mathbf{0} \quad \text{Ans. (a)}$$

$$\sum F_y = \mathbf{F}_y = \int v_{\text{out}} d\dot{m}_{\text{out}} - \dot{m}v_{\text{in}} = \int_{-45^\circ}^{+45^\circ} -V_{\text{exit}} \cos\theta \rho \Delta h R d\theta - 0 = -V_{\text{exit}} \rho \Delta h R \sqrt{2}$$

$$\text{or: } \mathbf{F}_y = -(8.03)(998)(0.01)(0.15)\sqrt{2} \approx \mathbf{-17 \text{ N}} \quad \text{Ans. (b)}$$

$$\sum F_z = \mathbf{F}_z = \dot{m}(w_{\text{out}} - w_{\text{in}}) = (18.9 \text{ kg/s})[0 - (-6.69 \text{ m/s})] \approx \mathbf{+126 \text{ N}} \quad \text{Ans. (c)}$$

3.75 A liquid jet of density ρ and area A strikes a block and splits into two jets, as shown in the figure. All three jets have the same velocity V . The upper jet exits at angle θ and area αA , the lower jet turns down at 90° and area $(1 - \alpha)A$. (a) Derive a formula for the forces (F_x, F_y) required to support the block against momentum changes. (b) Show that $F_y = 0$ only if $\alpha \geq 0.5$. (c) Find the values of α and θ for which both F_x and F_y are zero.

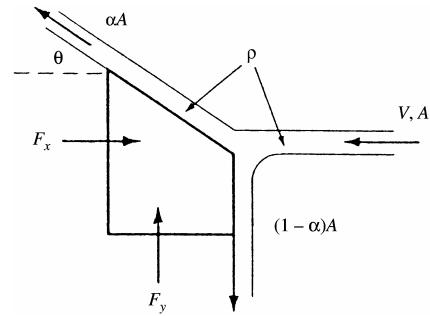

Solution: (a) Set up the x - and y -momentum relations:

$$\sum F_x = F_x = \alpha \dot{m}(-V \cos\theta) - \dot{m}(-V) \quad \text{where } \dot{m} = \rho AV \text{ of the inlet jet}$$

$$\sum F_y = F_y = \alpha \dot{m}V \sin\theta + (1 - \alpha)\dot{m}(-V)$$

Clean this up for the final result:

$$F_x = \dot{m}V(1 - \alpha \cos\theta)$$

$$F_y = \dot{m}V(\alpha \sin\theta + \alpha - 1) \quad \text{Ans. (a)}$$

(b) Examining F_y above, we see that it can be zero only when,

$$\sin\theta = \frac{1 - \alpha}{\alpha}$$

But this makes no sense if $\alpha < 0.5$, hence $\mathbf{F_y = 0}$ only if $\alpha \geq 0.5$. Ans. (b)

(c) Examining F_x , we see that it can be zero only if $\cos\theta = 1/\alpha$, which makes no sense unless $\alpha = 1$, $\theta = 0^\circ$. This situation also makes $F_x = 0$ above ($\sin\theta = 0$). Therefore the only scenario for which both forces are zero is the trivial case for which all the flow goes horizontally across a flat block:

$$F_x = F_y = 0 \quad \text{only if: } \alpha = 1, \theta = 0^\circ \quad \text{Ans. (c)}$$

3.76 A two-dimensional sheet of water, 10 cm thick and moving at 7 m/s, strikes a fixed wall inclined at 20° with respect to the jet direction. Assuming frictionless flow, find (a) the normal force on the wall per meter of depth, and the widths of the sheet deflected (b) upstream, and (c) downstream along the wall.

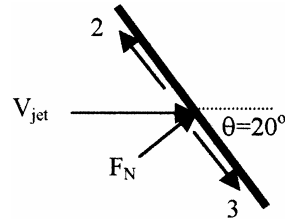

Fig. P3.76

Solution: (a) The force normal to the wall is due to the jet's momentum,

$$\sum F_N = -\dot{m}_{in} u_{in} = -(998)(0.1)(7^2)(\cos 70^\circ) = \mathbf{1670 \text{ N/m}} \quad \text{Ans.}$$

(b) Assuming $V_1 = V_2 = V_3 = V_{jet}$, $V_j A_1 = V_j A_2 + V_j A_3$ where,

$$A_2 = A_1 \sin\theta = (0.1)(1)(\sin 20^\circ) = 0.034 \text{ m} \approx \mathbf{3 \text{ cm}} \quad \text{Ans.}$$

(c) Similarly, $A_3 = A_1 \cos\theta = (0.1)(1)(\cos 20^\circ) = 0.094 \text{ m} \approx \mathbf{9.4 \text{ cm}} \quad \text{Ans.}$

3.77 Water at 20°C flows steadily through a reducing pipe bend, as in Fig. P3.77. Known conditions are $p_1 = 350 \text{ kPa}$, $D_1 = 25 \text{ cm}$, $V_1 = 2.2 \text{ m/s}$, $p_2 = 120 \text{ kPa}$, and $D_2 = 8 \text{ cm}$. Neglecting bend and water weight, estimate the total force which must be resisted by the flange bolts.

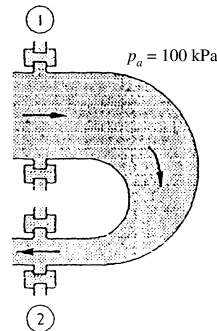

Fig. P3.77

Solution: First establish the mass flow and exit velocity:

$$\dot{m} = \rho_1 A_1 V_1 = 998 \left(\frac{\pi}{4} \right) (0.25)^2 (2.2) = 108 \frac{\text{kg}}{\text{s}} = 998 \left(\frac{\pi}{4} \right) (0.08)^2 V_2, \quad \text{or} \quad V_2 = 21.5 \frac{\text{m}}{\text{s}}$$

The CV surrounds the bend and cuts through the flanges. The force balance is

$$\sum F_x = -F_{\text{bolts}} + p_{1,\text{gage}}A_1 + p_{2,\text{gage}}A_2 = \dot{m}_2u_2 - \dot{m}_1u_1, \quad \text{where } u_2 = -V_2 \quad \text{and} \quad u_1 = V_1$$

$$\begin{aligned} \text{or } F_{\text{bolts}} &= (350000 - 100000) \frac{\pi}{4} (0.25)^2 + (120000 - 100000) \frac{\pi}{4} (0.08)^2 + 108(21.5 + 2.2) \\ &= 12271 + 101 + 2553 \approx \mathbf{14900 \text{ N}} \quad \text{Ans.} \end{aligned}$$

3.78 A fluid jet of diameter D_1 enters a cascade of moving blades at absolute velocity V_1 and angle β_1 , and it leaves at absolute velocity V_2 and angle β_2 , as in Fig. P3.78. The blades move at velocity u . Derive a formula for the power P delivered to the blades as a function of these parameters.

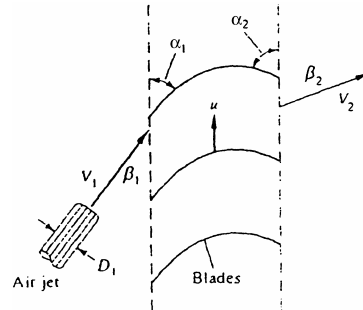
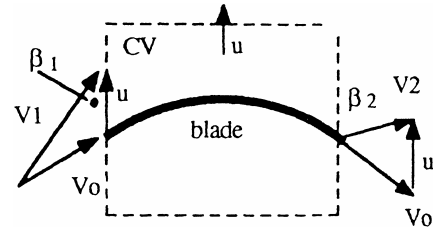

Fig. P3.78

Solution: Let the CV enclose the blades and move upward at speed u , so that the flow appears steady in that frame, as shown at right. The relative velocity V_o may be eliminated by the law of cosines:



$$\begin{aligned} V_o^2 &= V_1^2 + u^2 - 2V_1u \cos \beta_1 \\ &= V_2^2 + u^2 - 2V_2u \cos \beta_2 \end{aligned}$$

solve for $u = \frac{(1/2)(V_1^2 - V_2^2)}{V_1 \cos \beta_1 - V_2 \cos \beta_2}$

Then apply momentum in the direction of blade motion:

$$\sum F_y = F_{\text{vanes}} = \dot{m}_{\text{jet}}(V_{o1y} - V_{o2y}) = \dot{m}(V_1 \cos \beta_1 - V_2 \cos \beta_2), \quad \dot{m} = \rho A_1 V_1$$

The power delivered is $P = Fu$, which causes the parenthesis “ $\cos \beta$ ” terms to cancel:

$$\mathbf{P = Fu = \frac{1}{2} \dot{m}_{\text{jet}} (V_1^2 - V_2^2)} \quad \text{Ans.}$$

3.79 Air at 20°C and 1 atm enters the bottom of an 85° conical flowmeter duct as shown in the figure. It supports a centered conical body by steady annular flow around the cone and exits at the same velocity as it enters. Estimate the weight of the body in newtons.

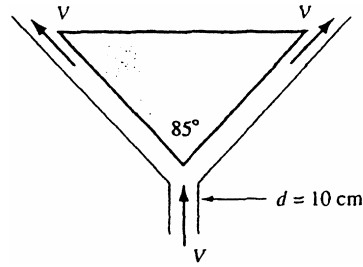

Solution: First estimate the velocity from the known inlet duct size:

$$\rho_{air} = \frac{p}{RT} = \frac{101350}{287(293)} = 1.205 \frac{\text{kg}}{\text{m}^3},$$

$$\text{thus } \dot{m} = 0.3 = \rho AV = (1.205) \frac{\pi}{4} (0.1)^2 V, \quad \text{solve } \mathbf{V = 31.7 \frac{m}{s}}$$

Then set up the vertical momentum equation, the unknown is the body weight:

$$\sum F_z = -W = \dot{m}V \cos 42.5^\circ - \dot{m}V = \dot{m}V(\cos 42.5^\circ - 1)$$

$$\text{Thus } \mathbf{W_{cone} = (0.3)(31.7)(1 - \cos 42.5^\circ) = 2.5 \text{ N} \quad \text{Ans.}}$$

3.80 A river (1) passes over a “drowned” weir as shown, leaving at a new condition (2). Neglect atmospheric pressure and assume hydrostatic pressure at (1) and (2). Derive an expression for the force F exerted by the river on the obstacle. Neglect bottom friction.

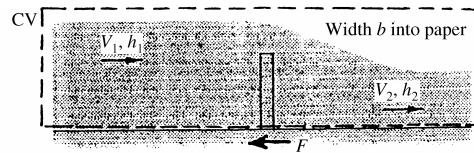

Fig. P3.80

Solution: The CV encloses (1) and (2) and cuts through the gate along the bottom, as shown. The volume flow and horizontal force relations give

$$V_1 b h_1 = V_2 b h_2$$

$$\sum F_x = -F_{\text{weir}} + \frac{1}{2} \rho g h_1 (h_1 b) - \frac{1}{2} \rho g h_2 (h_2 b) = (\rho h_1 b V_1)(V_2 - V_1)$$

Note that, except for the different geometry, the analysis is exactly the same as for the sluice gate in Ex. 3.10. The force result is the same, also:

$$\mathbf{F_{\text{weir}} = \frac{1}{2} \rho g b (h_1^2 - h_2^2) - \rho h_1 b V_1^2 \left(\frac{h_1}{h_2} - 1 \right) \quad \text{Ans.}}$$

3.81 Torricelli's idealization of efflux from a hole in the side of a tank is $V \approx \sqrt{2gh}$, as shown in Fig. P3.81. The tank weighs 150 N when empty and contains water at 20°C. The tank bottom is on very smooth ice (static friction coefficient $\zeta \approx 0.01$). For what water depth h will the tank just begin to move to the right?

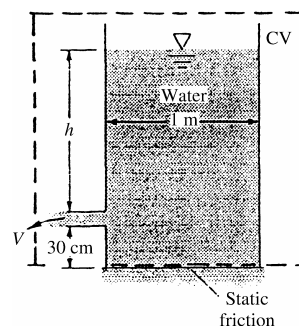

Fig. P3.81

Solution: The hole diameter is 9 cm. The CV encloses the tank as shown. The coefficient of static friction is $\zeta = 0.01$. The x -momentum equation becomes

$$\sum F_x = -\zeta W_{\text{tank}} = \dot{m}_{\text{out}} = -\dot{m} V_{\text{hole}} = -\rho A V^2 = -\rho A (2gh)$$

$$\text{or: } 0.01 \left[(9790) \frac{\pi}{4} (1 \text{ m})^2 (h + 0.3 + 0.09) + 150 \right] = 998 \left(\frac{\pi}{4} \right) (0.09)^2 (2)(9.81)h$$

Solve for $h \approx 0.66 \text{ m}$ Ans.

3.82 The model car in Fig. P3.82 weighs 17 N and is to be accelerated from rest by a 1-cm-diameter water jet moving at 75 m/s. Neglecting air drag and wheel friction, estimate the velocity of the car after it has moved forward 1 m.

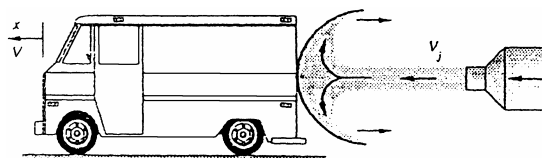

Fig. P3.82

Solution: The CV encloses the car, moves to the left at *accelerating* car speed $V(t)$, and cuts through the inlet and outlet jets, which leave the CS at *relative* velocity $V_j - V$. The force relation is Eq. (3.50):

$$\sum F_x - \int a_{\text{rel}} dm = 0 - m_{\text{car}} a_{\text{car}} = \dot{m}_{\text{out}} u_{\text{out}} - \dot{m}_{\text{in}} u_{\text{in}} = -2\dot{m}_{\text{jet}} (V_j - V),$$

$$\text{or: } m_{\text{car}} \frac{dV}{dt} = 2\rho A_j (V_j - V)^2$$

Except for the factor of “2,” this is identical to the “cart” analysis of Example 3.12 on page 140 of the text. The solution, for $V = 0$ at $t = 0$, is given there:

$$V = \frac{V_j^2 K t}{1 + V_j K t}, \quad \text{where } K = \frac{2\rho A_j}{m_{\text{car}}} = \frac{2(998)(\pi/4)(0.01)^2}{(17/9.81)} = 0.0905 \text{ m}^{-1}$$

$$\text{Thus } V \text{ (in m/s)} = \frac{509t}{1+6.785t} \quad \text{and then compute distance } S = \int_0^t V dt$$

The initial acceleration is 509 m/s^2 , quite large. Assuming the jet can follow the car without dipping, the car reaches $S = 1 \text{ m}$ at $t \approx 0.072 \text{ s}$, where $V \approx 24.6 \text{ m/s}$. *Ans.*

3.83 Gasoline at 20°C is flowing at $V_1 = 12 \text{ m/s}$ in a 5-cm-diameter pipe when it encounters a 1-m length of uniform radial wall suction. After the suction, the velocity has dropped to 10 m/s . If $p_1 = 120 \text{ kPa}$, estimate p_2 if wall friction is neglected.

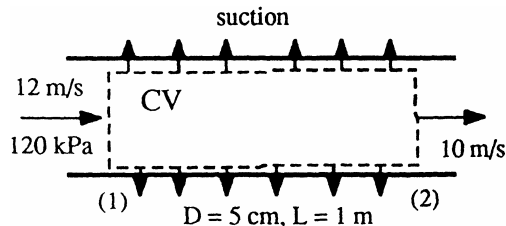

Solution: The CV cuts through sections 1 and 2 and the inside of the walls. We compute the mass flow at each section, taking $\rho \approx 680 \text{ kg/m}^3$ for gasoline:

$$\dot{m}_1 = 680 \left(\frac{\pi}{4} \right) (0.05)^2 (12) = 16.02 \frac{\text{kg}}{\text{s}}; \quad \dot{m}_2 = 680 \left(\frac{\pi}{4} \right) (0.05)^2 (10) = 13.35 \frac{\text{kg}}{\text{s}}$$

The difference, $16.02 - 13.35 = 2.67 \text{ kg/s}$, is sucked through the walls. If wall friction is neglected, the force balance (taking the momentum correction factors $\beta \approx 1.0$) is:

$$\begin{aligned} \sum F_x &= p_1 A_1 - p_2 A_2 = \dot{m}_2 V_2 - \dot{m}_1 V_1 = (120000 - p_2) \frac{\pi}{4} (0.05)^2 \\ &= (13.35)(10) - (16.02)(12), \quad \text{solve for } p_2 \approx \mathbf{150 \text{ kPa}} \quad \text{Ans.} \end{aligned}$$

3.84 Air at 20°C and 1 atm flows in a 25-cm-diameter duct at 15 m/s , as in Fig. P3.84. The exit is choked by a 90° cone, as shown. Estimate the force of the airflow on the cone.

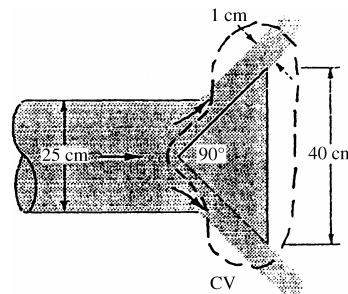

Fig. P3.84

Solution: The CV encloses the cone, as shown. We need to know exit velocity. The exit area is approximated as a ring of diameter 40.7 cm and thickness 1 cm :

$$Q = A_1 V_1 = \frac{\pi}{4} (0.25)^2 (15) = 0.736 \frac{\text{m}^3}{\text{s}} = A_2 V_2 \approx \pi (0.407) (0.01) V_2, \quad \text{or } V_2 \approx 57.6 \frac{\text{m}}{\text{s}}$$

The air density is $\rho = p/RT = (101350)/[287(293)] \approx 1.205 \text{ kg/m}^3$. We are not given any pressures on the cone so we consider momentum only. The force balance is

$$\Sigma F_x = F_{\text{cone}} = \dot{m}(u_{\text{out}} - u_{\text{in}}) = (1.205)(0.736)(57.6 \cos 45^\circ - 15) \approx \mathbf{22.8 \text{ N}} \quad \text{Ans.}$$

The force on the cone is *to the right* because we neglected pressure forces.

3.85 The thin-plate orifice in Fig. P3.85 causes a large pressure drop. For 20°C water flow at 500 gal/min, with pipe $D = 10 \text{ cm}$ and orifice $d = 6 \text{ cm}$, $p_1 - p_2 \approx 145 \text{ kPa}$. If the wall friction is negligible, estimate the force of the water on the orifice plate.

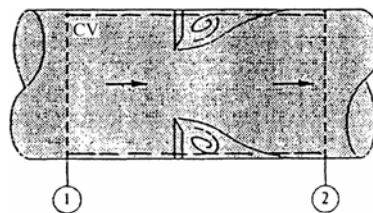

Fig. P3.85

Solution: The CV is inside the pipe walls, cutting through the orifice plate, as shown. At least to one-dimensional approximation, $V_1 = V_2$, so there is no momentum change. The force balance yields the force of the plate on the fluid:

$$\Sigma F_x = -F_{\text{plate on fluid}} + p_1 A_1 - p_2 A_2 - \tau_{\text{wall}} A_{\text{wall}} = \dot{m}(V_2 - V_1) \approx 0$$

$$\text{Since } \tau_{\text{wall}} \approx 0, \text{ we obtain } F_{\text{plate}} = (145000) \frac{\pi}{4} (0.1)^2 \approx \mathbf{1140 \text{ N}} \quad \text{Ans.}$$

The force of the fluid on the plate is opposite to the sketch, or to the right.

3.86 For the water-jet pump of Prob. 3.36, add the following data: $p_1 = p_2 = 25 \text{ lbf/in}^2$, and the distance between sections 1 and 3 is 80 in. If the average wall shear stress between sections 1 and 3 is 7 lbf/ft^2 , estimate the pressure p_3 . Why is it higher than p_1 ?

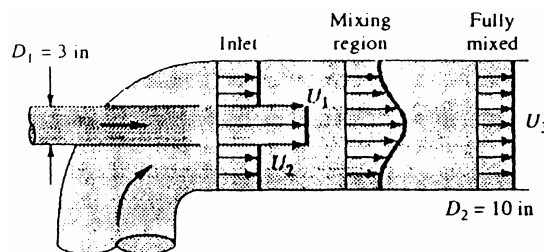

Fig. P3.36

Solution: The CV cuts through sections 1, 2, 3 and along the inside pipe walls. Recall from Prob. 3.36 that mass conservation led to the calculation $V_3 \approx 6.33 \text{ m/s}$. Convert data to SI units: $L = 80 \text{ in} = 2.032 \text{ m}$, $p_1 = p_2 = 25 \text{ psi} = 172.4 \text{ kPa}$, and $\tau_{\text{wall}} = 7 \text{ psf} = 335 \text{ Pa}$. We need mass flows for each of the three sections:

$$\dot{m}_1 = 998 \left(\frac{\pi}{4} \right) (0.0762)^2 (40) \approx 182 \frac{\text{kg}}{\text{s}};$$

$$\dot{m}_2 = 998 \left(\frac{\pi}{4} \right) [(0.254)^2 - (0.0762)^2] (3) \approx 138 \frac{\text{kg}}{\text{s}} \quad \text{and} \quad \dot{m}_3 \approx 182 + 138 \approx 320 \frac{\text{kg}}{\text{s}}$$

Then the horizontal force balance will yield the (high) downstream pressure:

$$\begin{aligned}\sum F_x &= p_1(A_1 + A_2) - p_3A_3 - \tau_{\text{wall}}\pi D_2L = \dot{m}_3V_3 - \dot{m}_2V_2 - \dot{m}_1V_1 \\ &= (172400 - p_3)\frac{\pi}{4}(0.254)^2 - 335\pi(0.254)(2.032) = 320(6.33) - 138(3) - 182(40)\end{aligned}$$

Solve for $p_3 \approx 274000 \text{ Pa}$ Ans.

The pressure is high because the primary inlet kinetic energy at section (1) is converted by viscous mixing to pressure-type energy at the exit.

3.87 Figure P3.87 simulates a *manifold* flow, with fluid removed from a porous wall or perforated section of pipe. Assume incompressible flow with negligible wall friction and small suction $V_w \ll V_1$. If (p_1, V_1, V_w, ρ, D) are known, derive expressions for (a) V_2 and (b) p_2 .

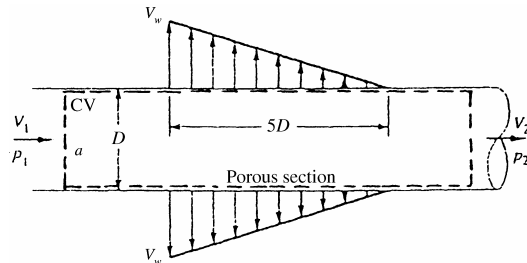

Fig. P3.87

Solution: The CV cuts through sections 1 and 2 and runs along the duct wall, as shown. Assuming incompressible flow, mass conservation gives

$$V_1A_1 = V_2A_2 + \int_0^{5D} V_w \left(1 - \frac{x}{5D}\right) \pi D dx = V_2\frac{\pi}{4}D^2 + 2.5\pi V_w D^2 = V_1\frac{\pi}{4}D^2$$

Assuming $V_w \ll V_1$, solve for $V_2 = V_1 - 10V_w$ Ans. (a)

Then use this result while applying the momentum relation to the same CV:

$$\sum F_x = (p_1 - p_2)\frac{\pi}{4}D^2 - \int \tau_w dA_w = \dot{m}_2u_2 - \dot{m}_1u_1 + \int u_w d\dot{m}_w$$

Since $\tau_w \approx 0$ and $u_w \approx 0$ and the area A_1 cancels out, we obtain the simple result

$$p_2 = p_1 + \rho(V_1^2 - V_2^2) = p_1 + 20\rho V_w(V_1 - 5V_w) \text{ Ans. (b)}$$

3.88 The boat in Fig. P3.88 is jet-propelled by a pump which develops a volume flow rate Q and ejects water out the stern at velocity V_j . If the boat drag force is $F = kV^2$, where k is a constant, develop a formula for the steady forward speed V of the boat.

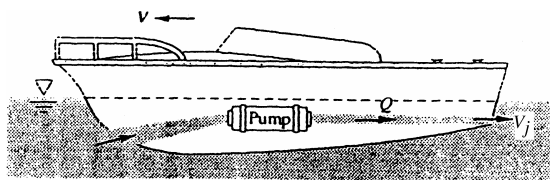

Fig. P3.88

Solution: Let the CV move to the left at boat speed V and enclose the boat and the pump's inlet and exit. Then the momentum relation is

$$\Sigma F_x = kV^2 = \dot{m}_{\text{pump}}(V_j + V - V_{\text{inlet}}) \approx \rho Q(V_j + V) \quad \text{if we assume } V_{\text{inlet}} \ll V_j$$

If, further, $V \ll V_j$, then the approximate solution is: $V \approx (\rho Q V_j / k)^{1/2}$ *Ans.*

If V and V_j are comparable, then we solve a quadratic equation:

$$V \approx \zeta + [\zeta^2 + 2\zeta V_j]^{1/2}, \quad \text{where } \zeta = \frac{\rho Q}{2k} \quad \text{Ans.}$$

3.89 Consider Fig. P3.36 as a general problem for analysis of a mixing ejector pump. If all conditions (p , ρ , V) are known at sections 1 and 2 and if the wall friction is negligible, derive formulas for estimating (a) V_3 and (b) p_3 .

Solution: Use the CV in Prob. 3.86 but use symbols throughout. For volume flow,

$$V_1 \frac{\pi}{4} D_1^2 + V_2 \frac{\pi}{4} (D_2^2 - D_1^2) = V_3 \frac{\pi}{4} D_2^2, \quad \text{or: } V_3 = V_1 \alpha + V_2 (1 - \alpha), \quad \alpha = (D_1/D_2)^2 \quad (\text{A})$$

Now apply x -momentum, assuming (quite reasonably) that $p_1 = p_2$:

$$(p_1 - p_3) \frac{\pi}{4} D_2^2 - \tau_w \pi D_2 L = \rho \frac{\pi}{4} D_2^2 V_3^2 - \rho \frac{\pi}{4} (D_2^2 - D_1^2) V_2^2 - \rho \frac{\pi}{4} D_1^2 V_1^2$$

$$\text{Clean up: } p_3 = p_1 - \frac{4L\tau_w}{D_2} + \rho \left[\alpha V_1^2 + (1 - \alpha) V_2^2 - V_3^2 \right] \quad \text{where } \alpha = \left(\frac{D_1}{D_2} \right)^2 \quad \text{Ans.}$$

You have to insert V_3 into this answer from Eq. (A) above, but the algebra is messy.

3.90 As shown in Fig. P3.90, a liquid column of height h is confined in a vertical tube of cross-sectional area A by a stopper. At $t = 0$ the stopper is suddenly removed, exposing the bottom of the liquid to atmospheric pressure. Using a control-volume analysis of mass and vertical momentum, derive the differential equation for the downward motion $V(t)$ of the liquid. Assume one-dimensional, incompressible, frictionless flow.

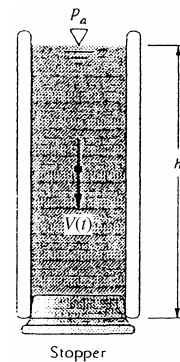

Fig. P3.90

Solution: Let the CV enclose the cylindrical blob of liquid. With density, area, and the blob volume constant, mass conservation requires that $V = V(t)$ only. The CV accelerates downward at blob speed $V(t)$. Vertical (downward) force balance gives

$$\sum F_{\text{down}} - \int a_{\text{rel}} dm = \frac{d}{dt} \left(\int V_{\text{down}} \rho d\nu \right) + \dot{m}_{\text{out}} V_{\text{out}} - \dot{m}_{\text{in}} V_{\text{in}} = 0$$

$$\text{or: } m_{\text{blob}} g + \Delta p A - \tau_w A_w - a m_{\text{blob}} = 0$$

$$\text{Since } \Delta p = 0 \quad \text{and} \quad \tau = 0, \quad \text{we are left with } \mathbf{a}_{\text{blob}} = \frac{d\mathbf{V}}{dt} = \mathbf{g} \quad \text{Ans.}$$

3.91 Extend Prob. 3.90 to include a linear (laminar) average wall shear stress of the form $\tau \approx cV$, where c is a constant. Find $V(t)$, assuming that the wall area remains constant.

Solution: The downward momentum relation from Prob. 3.90 above now becomes

$$0 = m_{\text{blob}} g - \tau_w \pi DL - m_{\text{blob}} \frac{dV}{dt}, \quad \text{or} \quad \frac{dV}{dt} + \zeta V = g, \quad \text{where} \quad \zeta = \frac{c\pi DL}{m_{\text{blob}}}$$

where we have inserted the laminar shear $\tau = cV$. The blob mass equals $\rho(\pi/4)D^2L$. For $V = 0$ at $t = 0$, the solution to this equation is

$$\mathbf{V} = \frac{\mathbf{g}}{\zeta} (1 - e^{-\zeta t}), \quad \text{where} \quad \zeta = \frac{c\pi DL}{m_{\text{blob}}} = \frac{4c}{\rho D} \quad \text{Ans.}$$

3.92 A more involved version of Prob. 3.90 is the elbow-shaped tube in Fig. P3.92, with constant cross-sectional area A and diameter $D \ll h, L$. Assume incompressible flow, neglect friction, and derive a differential equation for dV/dt when the stopper is opened. *Hint:* Combine two control volumes, one for each leg of the tube.

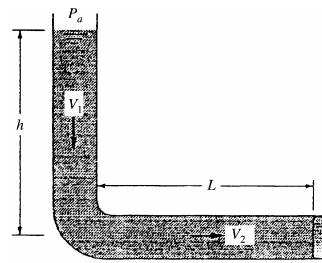
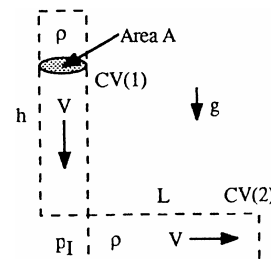

Fig. P3.92



Solution: Use two CV's, one for the vertical blob and one for the horizontal blob, connected as shown by pressure.

From mass conservation, $V_1 = V_2 = V(t)$. For CV's #1 and #2,

$$\sum F_{\text{down}} - \int a_{\text{rel}} dm = \Delta(\dot{m}v) = 0 = (p_{\text{atm}} - p_1)A + \rho gAh - m_1 \frac{dV}{dt} \quad (\text{No. 1})$$

$$\sum F_x - \int a_{\text{rel}} dm = \Delta(\dot{m}u) = 0 = (p_1 - p_{\text{atm}})A + 0 - m_2 \frac{dV}{dt} \quad (\text{No. 2})$$

Add these two together. The pressure terms cancel, and we insert the two blob masses:

$$\rho gAh - (\rho Ah + \rho AL) \frac{dV}{dt} = 0, \quad \text{or:} \quad \frac{dV}{dt} = g \frac{h}{L+h} \quad \text{Ans.}$$

3.93 Extend Prob. 3.92 to include a linear (laminar) average wall shear stress of the form $\tau \approx cV$, where c is a constant. Find $V(t)$, assuming that the wall area remains constant.

Solution: For the same two CV's as in Prob. 3.92 above, we add wall shears:

$$\Delta pA + \rho gAh - (cV)\pi Dh = m_1 \frac{dV}{dt} \quad (\text{No. 1})$$

$$-\Delta pA + 0 - (cV)\pi DL = m_2 \frac{dV}{dt} \quad (\text{No. 2})$$

Add together, divide by (ρA) , $A = \pi D^2/4$, and rearrange into a 1st order linear ODE:

$$\frac{dV}{dt} + \left(\frac{4c}{\rho D} \right) V = \frac{gh}{L+h} \quad \text{subject to} \quad \mathbf{V} = \mathbf{0} \quad \text{at} \quad \mathbf{t} = \mathbf{0}, \quad \mathbf{h} = \mathbf{h}_0 \quad \text{Ans.}$$

The blob length $(L + h)$ could be assumed constant, but $h = h(t)$. We could substitute for $V = -dh/dt$ and rewrite this relation as a 2nd order ODE for $h(t)$, but we will not proceed any further with an analytical *solution* to this differential equation.

3.94 Attempt a numerical solution of Prob. 3.93 for SAE 30 oil at 20°C. Let $h = 20$ cm, $L = 15$ cm, and $D = 4$ mm. Use the laminar shear approximation from Sec. 6.4: $\tau \approx 8\mu V/D$, where μ is the fluid viscosity. Account for the decrease in wall area wetted by the fluid. Solve for the time required to empty (a) the vertical leg and (b) the horizontal leg.

Solution: For SAE 30 oil, $\mu \approx 0.29$ kg/(m·s) and $\rho \approx 917$ kg/m³. For laminar flow as given, $c = 8\mu/D$, so the coefficient $(4c/\rho D) = 4[8(0.29)/0.004]/[917(0.004)] \approx 632$ s⁻¹. [The flow is highly damped.] Then the basic differential equation becomes

$$\frac{dV}{dt} + 632V = \frac{9.81h}{0.15+h}, \quad \text{with} \quad h = 0.2 - \int_0^t V dt \quad \text{and} \quad V(0) = 0$$

We may solve this numerically, e.g., by Runge-Kutta or a spreadsheet or whatever. After h reaches zero, we keep $h = 0$ and should decrease $L = 0.15 - \int V dt$ until $L = 0$. The results are perhaps startling: the highly damped system (lubricating oil in a capillary tube) quickly reaches a ‘terminal’ (near-zero-acceleration) velocity in 16 ms and then slowly moves down until $h \approx 0$, $t \approx 70$ s. The flow stops, and the horizontal leg will not empty.

The computed values of V and h for the author’s solution are as follows:

$t, s:$	0	5	10	15	20	30	40	50	60	70
$V, m/s:$	0	0.008	0.007	0.006	0.005	0.003	0.001	0.000	0.000	0.000
$h, m:$	0.2	0.162	0.121	0.089	0.063	0.028	0.011	0.004	0.001	0.000

P3.95 A cylindrical water tank discharges through a well-rounded orifice to hit a plate, as in Fig. P3.95.

Use the Torricelli formula of Prob. P3.81

to estimate the exit velocity. (a) If, at this instant, the force F required to hold the plate is 40 N, what is the depth h ?

(b) If the tank surface is dropping at the rate of 5 cm every 2 seconds, what is the tank diameter D ?

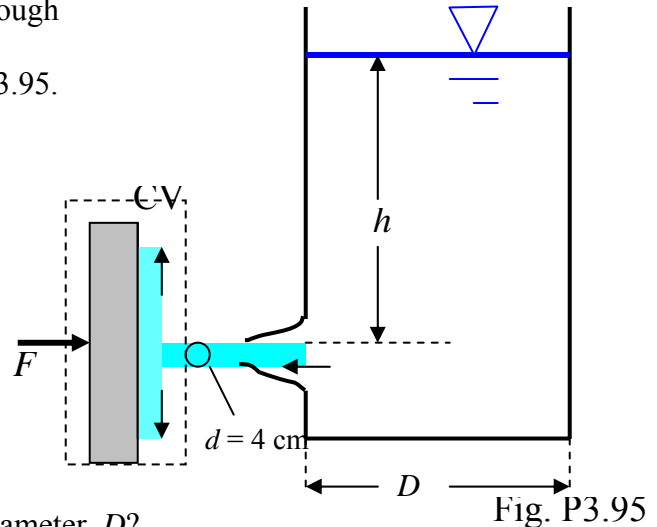

Solution: For water take $\rho = 998 \text{ kg/m}^3$. The control volume surrounds the plate and yields

$$\Sigma F_x = F = -\dot{m}_{in} u_{in} = -\dot{m}_{jet} (-V_{jet}) = \rho A_{jet} V_{jet} (V_{jet}) = \rho \frac{\pi}{4} d^2 V_{jet}^2$$

But Torricelli says $V_{jet}^2 = 2gh$; Thus $h = \frac{F}{\rho(\pi/4)d^2(2g)}$

Given data: $h = \frac{40 \text{ N}}{(998 \text{ kg/m}^3)(\pi/4)(0.04 \text{ m})^2(2)(9.81 \text{ m/s}^2)} = \mathbf{1.63 \text{ m}}$ Ans.(a)

(b) In 2 seconds, h drops from 1.63m to 1.58m, not much change. So, instead of a laborious calculus solution, find $Q_{\text{jet,av}}$ for an average depth $h_{\text{av}} = (1.63+1.58)/2 = 1.605$ m:

$$Q_{\text{av}} = A_{\text{jet}} \sqrt{2gh_{\text{av}}} = \frac{\pi}{4} (0.04\text{m})^2 \sqrt{2(9.81\text{m/s}^2)(1.605\text{m})} \approx 0.00705\text{m}^3/\text{s}$$

$$\text{Equate } Q\Delta t = A_{\text{tank}} \Delta h, \text{ or: } D = \sqrt{\frac{Q\Delta t}{(\pi/4)\Delta h}} = \sqrt{\frac{(0.00705)(2\text{s})}{(\pi/4)(0.05\text{m})}} \approx \mathbf{0.60\text{m}} \text{ Ans.(b)}$$

3.96 Extend Prob. 3.90 to the case of the liquid motion in a frictionless U-tube whose liquid column is displaced a distance Z upward and then released, as in Fig. P3.96. Neglect the short horizontal leg and combine control-volume analyses for the left and right legs to derive a single differential equation for $V(t)$ of the liquid column.

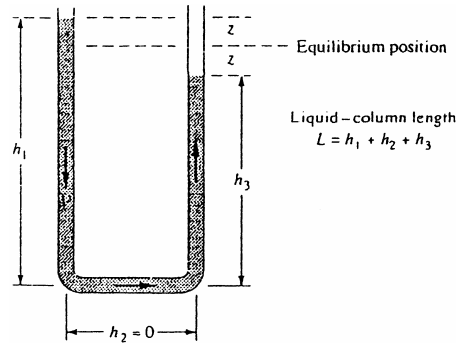
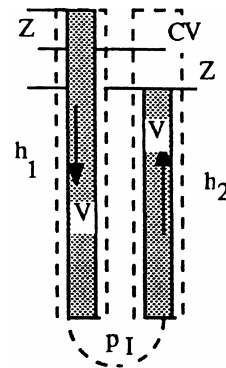

Fig. P3.96



Solution: As in Prob. 3.92, break it up into two moving CV's, one for each leg, as shown. By mass conservation, the velocity $V(t)$ is the same in each leg. Let p_1 be the bottom pressure in the (very short) cross-over leg. Neglect wall shear stress. Now apply vertical momentum to each leg:

$$\begin{aligned} \text{Leg\#1: } \quad & \sum F_{\text{down}} - \int a_{\text{rel}} \, dm \\ & = (p_a - p_1)A + \rho g A h_1 - m_1 \frac{dV}{dt} = 0 \end{aligned}$$

$$\text{Leg\#2: } \quad \sum F_{\text{up}} - \int a_{\text{rel}} \, dm = (p_1 - p_a)A - \rho g A h_2 - m_2 \frac{dV}{dt} = 0$$

Add these together. The pressure terms will cancel. Substitute for the h 's as follows:

$$\rho g A (h_1 - h_2) = \rho g A (2Z) = (m_1 + m_2) \frac{dV}{dt} = \rho A (h_1 + h_2) \frac{dV}{dt} = \rho A L \frac{dV}{dt}$$

$$\text{Since } V = -\frac{dZ}{dt}, \text{ we arrive at, finally, } \frac{d^2 Z}{dt^2} + \frac{2g}{L} Z = 0 \quad \text{Ans.}$$

The solution is a simple harmonic oscillation: $Z = C \cos \left[t \sqrt{(2g/L)} \right] + D \sin \left[t \sqrt{(2g/L)} \right]$.

3.97 Extend Prob. 3.96 to include a linear (laminar) average wall shear stress resistance of the form $\tau \approx 8\mu V/D$, where μ is the fluid viscosity. Find the differential equation for dV/dt and then solve for $V(t)$, assuming an initial displacement $z = z_0$, $V = 0$ at $t = 0$. The result should be a damped oscillation tending toward $z = 0$.

Solution: The derivation now includes wall shear stress on each leg (see Prob. 3.96):

$$\text{Leg\#1: } \quad \sum F_{\text{down}} - \int a_{\text{rel}} \, dm = \Delta p A + \rho g A h_1 - \tau_w \pi D h_1 - m_1 \frac{dV}{dt} = 0$$

$$\text{Leg\#2: } \sum F_{\text{up}} - \int a_{\text{rel}} dm = -\Delta p A - \rho g A h_2 - \tau_w \pi D h_2 - m_2 \frac{dV}{dt} = 0$$

Again add these two together: the pressure terms cancel, and we obtain, if $A = \pi D^2/4$,

$$\frac{d^2 Z}{dt^2} + \frac{4\tau_w}{\rho D} + \frac{2g}{L} Z = 0, \quad \text{where } \tau_w = \frac{8\mu V}{D} \quad \text{Ans.}$$

The shear term is equal to the linear damping term $(32\mu/\rho D^2)(dZ/dt)$. If we assume an initial static displacement $Z = Z_0$, $V = 0$, at $t = 0$, we obtain the damped oscillation

$$Z = Z_0 e^{-t/t^*} \cos(\omega t), \quad \text{where } t^* = \frac{\rho D^2}{16\mu} \quad \text{and } \omega = \sqrt{2g/L} \quad \text{Ans.}$$

3.98 As an extension of Ex. 3.9, let the plate and cart be unrestrained, with frictionless wheels. Derive (a) the equation of motion for cart velocity $V_c(t)$; and (b) the time required for the cart to accelerate to 90% of jet velocity. (c) Compute numerical values for (b) using the data from Ex. 3.9 and a cart mass of 2 kg.

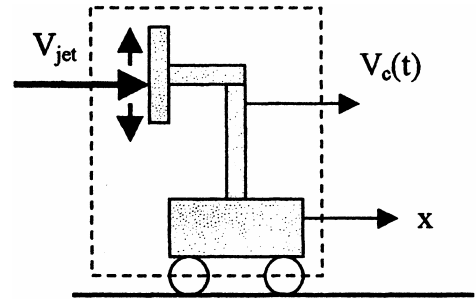

Solution: (a) Use Eq. (3.49) with \mathbf{a}_{rel} equal to the cart acceleration and $\sum F_x = 0$:

$$\sum F_x - \dot{m}_{x,\text{rel}} = \int u \rho V \cdot \mathbf{n} dA = -m_c \frac{dV_c}{dt} = -\rho_j A_j (V_j - V_c)^2 \quad \text{Ans. (a)}$$

The above 1st-order differential equation can be solved by separating the variables:

$$\int_0^{V_c} \frac{dV_c}{(V_j - V_c)^2} = K \int_0^t dt, \quad \text{where } K = \frac{\rho A_j}{m_c}$$

$$\text{Solve for: } \frac{V_c}{V_j} = \frac{V_j K t}{1 + V_j K t} = 0.90 \quad \text{if } t_{90\%} = \frac{9}{K V_j} = \frac{9 m_c}{\rho A_j V_j} \quad \text{Ans. (b)}$$

$$\text{For the Example 3.10 data, } t_{90\%} = \frac{9(2 \text{ kg})}{(1000 \text{ kg/m}^3)(0.0003 \text{ m}^2)(20 \text{ m/s})} \approx 3.0 \text{ s} \quad \text{Ans. (c)}$$

3.99 Let the rocket of Fig. E3.12 start at $z = 0$, with constant exit velocity and exit mass flow, and rise vertically with zero drag. (a) Show that, as long as fuel burning continues, the vertical height $S(t)$ reached is given by

$$S = \frac{V_e M_o}{\dot{m}} [\zeta \ln \zeta - \zeta + 1], \quad \text{where } \zeta = 1 - \frac{\dot{m}t}{M_o}$$

(b) Apply this to the case $V_e = 1500$ m/s and $M_o = 1000$ kg to find the height reached after a burn of 30 seconds, when the final rocket mass is 400 kg.

Solution: (a) Ignoring gravity effects, integrate the equation of the projectile's velocity (from E3.12):

$$S(t) = \int V(t) dt = \int_0^t \left[-V_e \ln \left(1 - \frac{\dot{m}t}{M_o} \right) \right] dt$$

Let $\zeta = 1 - \frac{\dot{m}t}{M_o}$, then $d\zeta = -\frac{\dot{m}}{M_o} dt$ and the integral becomes,

$$S(t) = (-V_e) \left[\frac{-M_o}{\dot{m}} \right] \int_1^\zeta (\zeta \ln \zeta) d\zeta = \left(\frac{V_e M_o}{\dot{m}} \right) [\zeta \ln \zeta - \zeta]_1^\zeta = \left(\frac{V_e M_o}{\dot{m}} \right) [\zeta \ln \zeta - \zeta + 1]$$

(b) Substituting the numerical values given,

$$\dot{m} = \frac{\Delta M}{\Delta t} = \frac{M_f - M_o}{\Delta t} = \frac{1000 \text{ kg} - 400 \text{ kg}}{30 \text{ s}} = 20 \text{ kg/s} \quad \text{and} \quad \zeta = 1 - \frac{(20 \text{ kg/s})(30 \text{ s})}{1000 \text{ kg}} = 0.40$$

$$S(t = 30 \text{ s}) = \frac{(1500 \text{ m/s})(1000 \text{ kg})}{(20 \text{ kg/s})} [0.4 \ln(0.4) - (0.4) + 1] = \mathbf{17,500 \text{ m}} \quad \text{Ans.}$$

3.100 Suppose that the solid-propellant rocket of Prob. 3.35 is built into a missile of diameter 70 cm and length 4 m. The system weighs 1800 N, which includes 700 N of propellant. Neglect air drag. If the missile is fired vertically from rest at sea level, estimate (a) its velocity and height at fuel burnout and (b) the maximum height it will attain.

Solution: The theory of Example 3.12 holds until burnout. Now $M_o = 1800/9.81 = 183.5$ kg, and recall from Prob. 3.35 that $V_e = 1150$ m/s and the exit mass flow is 11.8 kg/s. The fuel mass is $700/9.81 = 71.4$ kg, so burnout will occur at $t_{\text{burnout}} = 71.4/11.8 = 6.05$ s. Then Example 3.12 predicts the velocity at burnout:

$$V_b = -1150 \ln \left(1 - \frac{11.8(6.05)}{183.5} \right) - 9.81(6.05) \approx \mathbf{507 \frac{m}{s}} \quad \text{Ans. (a)}$$

Meanwhile, Prob. 3.99 gives the formula for altitude reached at burnout:

$$S_b = \frac{183.5(1150)}{11.8} [1 + (0.611)\{\ln(0.611) - 1\}] - \frac{1}{2}(9.81)(0.605)^2 \approx \mathbf{1393 \text{ m}} \quad \text{Ans. (a)}$$

where “0.611” = $1 - 11.8(6.05)/183.5$, that is, the mass ratio at burnout. After burnout, with drag neglected, the missile moves as a falling body. Maximum height occurs at

$$\Delta t = \frac{V_o}{g} = \frac{507}{9.81} = 51.7 \text{ s, whence}$$

$$S = S_o + \frac{1}{2}g\Delta t^2 = 1393 + (1/2)(9.81)(51.7)^2 \approx \mathbf{14500 \text{ m}} \quad \text{Ans. (b)}$$

3.101 Modify Prob. 3.100 by accounting for air drag on the missile $F \approx C\rho D^2 V^2$, where $C \approx 0.02$, ρ is the air density, D is the missile diameter, and V is the missile velocity. Solve numerically for (a) the velocity and altitude at burnout and (b) the maximum altitude attained.

Solution: The CV vertical-momentum analysis of Prob. 3.100 is modified to include a drag force resisting the upward acceleration:

$$m \frac{dV}{dt} = \dot{m}V_e - mg - C_D \rho D^2 V^2, \quad \text{where } m = m_o - \dot{m}t, \quad \text{and } \rho = \rho_o \left(\frac{T_o - Bz}{T_o} \right)^{4.26}$$

with numerical values $m_o = 183.5 \text{ kg}$, $\dot{m} = 11.8 \frac{\text{kg}}{\text{s}}$, $V_e = 1150 \frac{\text{m}}{\text{s}}$, $D = 0.7 \text{ m}$, $C_D = 0.02$

We may integrate this numerically, by Runge-Kutta or a spreadsheet or whatever, starting with $V = 0$, $z = 0$, at $t = 0$. After burnout, $t \approx 6.05 \text{ s}$, we drop the thrust term. The density is computed for the U.S. Standard Atmosphere from Table A-6. The writer’s numerical solution is shown graphically on the next page. The particular values asked for in the problem are as follows:

$$\text{At burnout, } t = 6.05 \text{ s: } \mathbf{V \approx 470 \text{ m/s, } z \approx 1370 \text{ m}} \quad \text{Ans. (a)}$$

$$\text{At maximum altitude: } \mathbf{t \approx 40 \text{ s, } z_{\max} \approx 8000 \text{ m}} \quad \text{Ans. (b)}$$

We see that drag has a small effect during rocket thrust but a large effect afterwards.

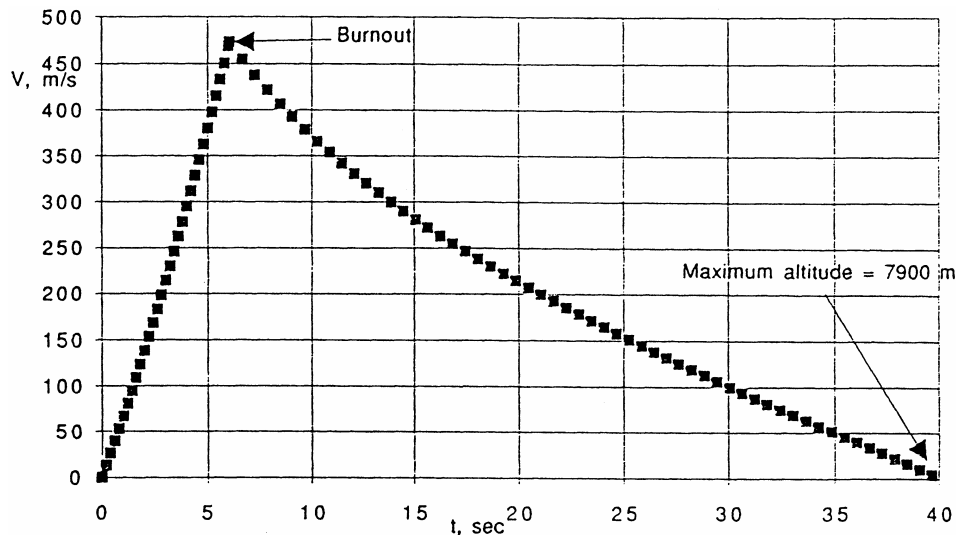

Problem 3.101 – NUMERICAL SOLUTION

3.102 As can often be seen in a kitchen sink when the faucet is running, a high-speed channel flow (V_1, h_1) may “jump” to a low-speed, low-energy condition (V_2, h_2) as in Fig. P3.102. The pressure at sections 1 and 2 is approximately hydrostatic, and wall friction is negligible. Use the continuity and momentum relations to find h_2 and V_2 in terms of (h_1, V_1).

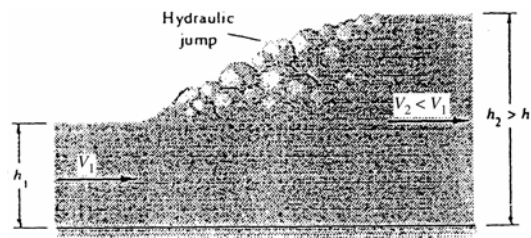

Fig. P3.102

Solution: The CV cuts through sections 1 and 2 and surrounds the jump, as shown. Wall shear is neglected. There are no obstacles. The only forces are due to hydrostatic pressure:

$$\sum F_x = 0 = \frac{1}{2} \rho g h_1 (h_1 b) - \frac{1}{2} \rho g h_2 (h_2 b) = \dot{m} (V_2 - V_1),$$

$$\text{where } \dot{m} = \rho V_1 h_1 b = \rho V_2 h_2 b$$

$$\text{Solve for } V_2 = V_1 h_1 / h_2 \quad \text{and} \quad h_2 / h_1 = -\frac{1}{2} + \frac{1}{2} \sqrt{1 + 8V_1^2 / (g h_1)} \quad \text{Ans.}$$

3.103 Suppose that the solid-propellant rocket of Prob. 3.35 is mounted on a 1000-kg car to propel it up a long slope of 15° . The rocket motor weighs 900 N, which includes 500 N of propellant. If the car starts from rest when the rocket is fired, and if air drag and wheel friction are neglected, estimate the maximum distance that the car will travel up the hill.

Solution: This is a variation of Prob. 3.100, except that “g” is now replaced by “g sin θ .” Recall from Prob. 3.35 that the rocket mass flow is 11.8 kg/s and its exit velocity is 1150 m/s. The rocket fires for $t_b = (500/9.81)/11.8 = 4.32$ sec, and the initial mass is $M_0 = (1000 + 900/9.81) = 1092$ kg. Then the differential equation for uphill powered motion is

$$m \frac{dV}{dt} = \dot{m} V_e - mg \sin \theta, \quad m = M_0 - \dot{m} t$$

This integrates to: $V(t) = -V_e \ln(1 - \dot{m} t / M_0) - g t \sin \theta$ for $t \leq 4.32$ s.

After burnout, the rocket coasts uphill with the usual falling-body formulas with “g sin θ .” The distance travelled during rocket power is modified from Prob. 3.99:

$$S = (M_0 V_e / \dot{m}) [1 + (1 - \dot{m} t / M_0) \{ \ln(1 - \dot{m} t / M_0) - 1 \}] - \frac{1}{2} g t^2 \sin \theta$$

Apply these to the given data at burnout to obtain

$$V_{\text{burnout}} = -1150 \ln(0.9533) - \frac{1}{2} (9.81) \sin 15^\circ (4.32)^2 \approx 44.0 \text{ m/s}$$

$$S_{\text{burnout}} = \frac{1092(1150)}{11.8} [1 + 0.9533 \{ \ln(0.9533) - 1 \}] - \frac{1}{2} (9.81) \sin 15^\circ (4.32)^2 \approx 94 \text{ m}$$

The rocket then coasts uphill a distance ΔS such that $V_b^2 = 2g\Delta S \sin \theta$, or $\Delta S = (44.0)^2 / [2(9.81) \sin 15^\circ] \approx 381$ m. The total distance travelled is $381 + 94 \approx \mathbf{475 \text{ m}}$ *Ans.*

3.104 A rocket is attached to a rigid horizontal rod hinged at the origin as in Fig. P3.104. Its initial mass is M_0 , and its exit properties are \dot{m} and V_e relative to the rocket. Set up the differential equation for rocket motion, and solve for the angular velocity $\omega(t)$ of the rod. Neglect gravity, air drag, and the rod mass.

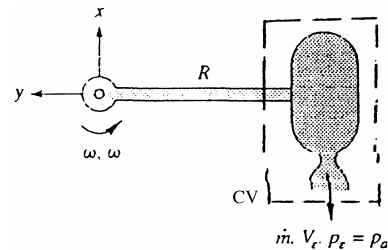

Fig. P3.104

Solution: The CV encloses the rocket and moves at (accelerating) rocket speed $\Omega(t)$. The rocket arm is free to rotate, there is no force parallel to the rocket motion. Then we have

$$\Sigma F_{\text{tangent}} = 0 - \int a_{\text{rel}} dm = \dot{m}(-V_e), \quad \text{or} \quad mR \frac{d\Omega}{dt} = \dot{m}V_e, \quad \text{where } m = M_o - \dot{m}t$$

$$\text{Integrate, with } \Omega = 0 \text{ at } t = 0, \text{ to obtain } \Omega = -\frac{V_e}{R} \ln \left(1 - \frac{\dot{m}t}{M_o} \right) \quad \text{Ans.}$$

3.105 Extend Prob. 3.104 to the case where the rocket has a linear air drag force $F = cV$, where c is a constant. Assuming no burnout, solve for $\omega(t)$ and find the *terminal* angular velocity, i.e., the final motion when the angular acceleration is zero. Apply to the case $M_o = 6$ kg, $R = 3$ m, $m = 0.05$ kg/s, $V_e = 1100$ m/s, and $c = 0.075$ N·s/m to find the angular velocity after 12 s of burning.

Solution: If linear resistive drag is added to Prob. 3.104, the equation of motion becomes

$$m \frac{d\Omega}{dt} = \frac{\dot{m}V_e}{R} - C\Omega, \quad \text{where } m = M_o - \dot{m}t, \text{ with } \Omega = 0 \text{ at } t = 0$$

The solution is found by separation of variables:

$$\text{If } B = \dot{m}V_e/R, \text{ then } \int_0^{\Omega} \frac{d\Omega}{B - C\Omega} = \int_0^t \frac{dt}{M_o - \dot{m}t}, \quad \text{or: } \Omega = \frac{B}{C} \left[1 - \left(1 - \frac{\dot{m}t}{M_o} \right)^{C/m} \right] \quad \text{Ans. (a)}$$

Strictly speaking, there is no terminal velocity, but if we set the acceleration equal to zero in the basic differential equation, we obtain an estimate $\Omega_{\text{term}} = mV_e/(RC)$. *Ans. (b)*

For the given data, at $t = 12$ s, we obtain the angular velocity

$$\text{At } t = 12 \text{ s: } \Omega = \frac{(0.05)(1100)}{(3.0)(0.075)} \left[1 - \left(1 - \frac{0.05(12)}{6.0} \right)^{\frac{0.075}{0.05}} \right] \approx 36 \frac{\text{rad}}{\text{sec}} \quad \text{Ans. (c)}$$

3.106 Extend Prob. 3.104 to the case where the rocket has a quadratic air drag force $F = kV^2$, where k is a constant. Assuming no burnout, solve for $\omega(t)$ and find the *terminal* angular velocity, i.e., the final motion when the angular acceleration is zero. Apply to the case $M_o = 6$ kg, $R = 3$ m, $m = 0.05$ kg/s, $V_e = 1100$ m/s, and $k = 0.0011$ N·s²/m² to find the angular velocity after 12 s of burning.

Solution: If quadratic drag is added to Prob. 3.104, the equation of motion becomes

$$m \frac{d\Omega}{dt} = \frac{\dot{m}V_e}{R} - kR\Omega^2, \quad \text{where } m = M_0 - \dot{m}t, \text{ with } \Omega = 0 \text{ at } t = 0$$

The writer has not solved this equation analytically, although it is possible. A numerical solution results in the following results for this particular data ($V_e = 1100$ m/s, etc.):

t, sec:	0	3	6	9	12	15	20	30	40	50	60	70
Ω , rad/s:	0	9.2	18.4	27.3	35.6	43.1	53.5	66.7	72.0	73.9	74.4	74.5

The answer desired, $\Omega \approx 36$ rad/s at $t = 12$ s, is coincidentally the same as Prob. 3.105.

Note that, in this case, the quadratic drag, being stronger at high Ω , causes the rocket to approach terminal speed before the fuel runs out (assuming it has that much fuel):

$$\text{Terminal speed, } \frac{d\Omega}{dt} = 0: \quad \Omega_{\text{final}} = \sqrt{\frac{\dot{m}V_e}{kR^2}} = \sqrt{\frac{0.05(1100)}{0.0011(3)^2}} = 74.5 \frac{\text{rad}}{\text{s}} \quad \text{Ans.}$$

3.107 The cart in Fig. P3.107 moves at constant velocity $V_0 = 12$ m/s and takes on water with a scoop 80 cm wide which dips $h = 2.5$ cm into a pond. Neglect air drag and wheel friction. Estimate the force required to keep the cart moving.

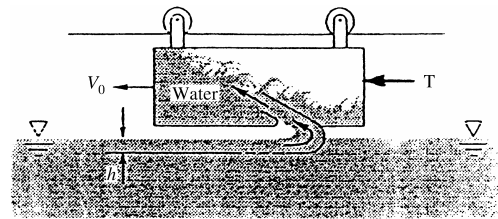

Fig. P3.107

Solution: The CV surrounds the cart and scoop and moves to the left at cart speed V_0 . Momentum *within* the cart fluid is neglected. The horizontal force balance is

$$\sum F_x = -\text{Thrust} = -\dot{m}_{\text{scoop}} V_{\text{inlet}}, \quad \text{but } V_{\text{inlet}} = V_0 \text{ (water motion relative to scoop)}$$

$$\text{Therefore } \text{Thrust} = \dot{m}V_0 = [998(0.025)(0.8)(12)](12) \approx 2900 \text{ N} \quad \text{Ans.}$$

3.108 A rocket sled of mass M is to be decelerated by a scoop, as in Fig. P3.108, which has width b into the paper and dips into the water a depth h , creating an upward jet at 60° . The rocket thrust is T to the left. Let the initial velocity be V_0 , and neglect air drag and wheel friction. Find an expression for $V(t)$ of the sled for (a) $T = 0$ and (b) finite $T \neq 0$.

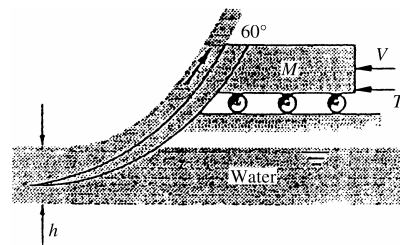

Fig. P3.108

Solution: The CV surrounds the sled and scoop and moves to the *left* at sled speed $V(t)$. Let x be positive to the left. The horizontal force balance is

$$\sum F_x = T - M \frac{dV}{dt} = \dot{m}_{\text{out}} u_{\text{out}} - \dot{m}_{\text{in}} u_{\text{in}} = \dot{m}(-V \cos \theta) - \dot{m}(-V), \quad \dot{m} = \rho b h V$$

$$\text{or: } M_{\text{sled}} \frac{dV}{dt} = T - CV^2, \quad C = \rho b h (1 - \cos \theta)$$

Whether or not thrust $T = 0$, the variables can be separated and integrated:

$$(a) T = 0: \quad \int_{V_0}^V \frac{dV}{V^2} = -\frac{C}{M} \int_0^t dt, \quad \text{or: } V = \frac{V_0}{1 + CV_0 t/M} \quad \text{Ans. (a)}$$

$$(b) T > 0: \quad \int_{V_0}^V \frac{M dV}{T - CV^2} = \int_0^t dt, \quad \text{or: } V = V_{\text{final}} \tanh[\alpha t + \phi] \quad \text{Ans. (b)}$$

where $V_{\text{final}} = [T/\rho b h (1 - \cos \theta)]^{1/2}$, $\alpha = [T \rho b h (1 - \cos \theta)]^{1/2}/M$, $\phi = \tanh^{-1}(V_0/V_f)$

This solution only applies when $V_0 < V_{\text{final}}$, which may not be the case for a speedy sled.

3.109 Apply Prob. 3.108 to the following data: $M_0 = 900$ kg, $b = 60$ cm, $h = 2$ cm, $V_0 = 120$ m/s, with the rocket of Prob. 3.35 attached and burning. Estimate V after 3 sec.

Solution: Recall from Prob. 3.35 that the rocket had a thrust of 13600 N and an exit mass flow of 11.8 kg/s. Then, after 3 s, the mass has only dropped to $900 - 11.8(3) = 865$ kg, so we can approximate that, over 3 seconds, the sled mass is near constant at about 882 kg. Compute the “final” velocity if the rocket keeps burning:

$$V_{\text{final}} = [T/\{\rho b h (1 - \cos \theta)\}]^{1/2} = \left[\frac{13600}{998(0.6)(0.02)(1 - \cos 60^\circ)} \right]^{1/2} \approx 47.66 \frac{\text{m}}{\text{s}}$$

Thus solution (b) to Prob. 3.108 does not apply, since $V_0 = 120$ m/s $>$ V_{final} . We therefore effect a numerical solution of the basic differential equation from Prob. 3.108:

$$M \frac{dV}{dt} = T - \rho b h (1 - \cos \theta) V^2, \quad \text{or: } 882 \frac{dV}{dt} = 13600 - 5.988 V^2, \quad \text{with } V_0 = 120 \frac{\text{m}}{\text{s}}$$

The writer solved this on a spreadsheet for $0 < t < 3$ sec. The results may be tabulated:

t , sec:	0.0	0.5	1.0	1.5	2.0	2.5	3.0 sec
V , m/s:	120.0	90.9	75.5	66.3	60.4	56.6	<u>53.9 m/s</u>

The sled has decelerated to 53.9 m/s, quite near its “steady” speed of about 46 m/s.

3.110 The horizontal lawn sprinkler in Fig. P3.110 has a water flow rate of 4.0 gal/min introduced vertically through the center. Estimate (a) the retarding torque required to keep the arms from rotating and (b) the rotation rate (r/min) if there is no retarding torque.

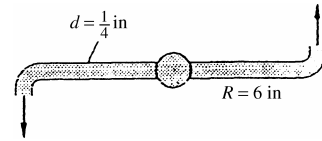

Fig. P3.110

Solution: The flow rate is 4 gal/min = 0.008912 ft³/s, and $\rho = 1.94$ slug/ft³. The velocity issuing from each arm is $V_o = (0.008912/2)/[(\pi/4)(0.25/12 \text{ ft})^2] \approx 13.1$ ft/s. Then:

(a) From Example 3.15, $\omega = \frac{V_o}{R} - \frac{T_o}{\rho QR^2}$ and, if there is no motion ($\omega = 0$),

$$T_o = \rho QR V_o = (1.94)(0.008912)(6/12)(13.1) \approx \mathbf{0.113 \text{ ft}\cdot\text{lbf}} \quad \text{Ans. (a)}$$

(b) If $T_o = 0$, then $\omega_{\text{no friction}} = V_o/R = \frac{13.1 \text{ ft/s}}{6/12 \text{ ft}} = 26.14 \frac{\text{rad}}{\text{s}} \approx \mathbf{250 \frac{\text{rev}}{\text{min}}}$ Ans. (b)

3.111 In Prob. 3.60 find the torque caused around flange 1 if the center point of exit 2 is 1.2 m directly below the flange center.

Solution: The CV encloses the elbow and cuts through flange (1). Recall from Prob. 3.60 that $D_1 = 10$ cm, $D_2 = 3$ cm, weight flow = 150 N/s, whence $V_1 = 1.95$ m/s and $V_2 = 21.7$ m/s. Let “O” be in the center of flange (1). Then $\mathbf{r}_{O2} = -1.2\mathbf{j}$ and $\mathbf{r}_{O1} = 0$.

The pressure at (1) passes through O, thus causes no torque. The moment relation is

$$\sum M_O = \mathbf{T}_O = \dot{m}[(\mathbf{r}_{O2} \times \mathbf{V}_2) - (\mathbf{r}_{O1} \times \mathbf{V}_1)] = \left(\frac{150}{9.81} \frac{\text{kg}}{\text{s}} \right) [(-1.2\mathbf{j}) \times (-16.6\mathbf{i} - 13.9\mathbf{j})]$$

$$\text{or: } \mathbf{T}_O = -305\mathbf{k} \text{ N}\cdot\text{m} \quad \text{Ans.}$$

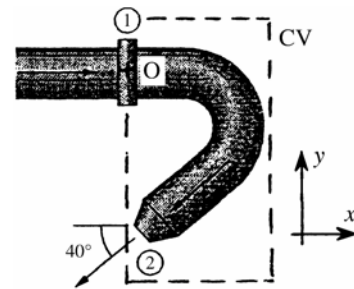

Fig. P3.60

3.112 The wye joint in Fig. P3.112 splits the pipe flow into equal amounts $Q/2$, which exit, as shown, a distance R_o from the axis. Neglect gravity and friction. Find an expression for the torque T about the x axis required to keep the system rotating at angular velocity Ω .

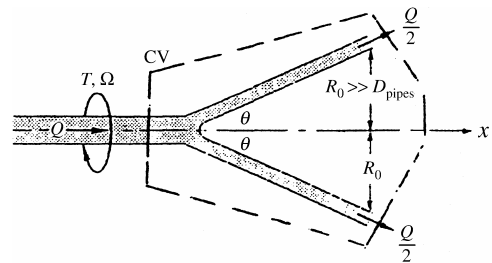

Fig. P3.112

Solution: Let the CV enclose the junction, cutting through the inlet pipe and thus exposing the required torque T . If y is “up” in the figure, the absolute exit velocities are

$$\mathbf{V}_{\text{upper}} = V_o \cos\theta \mathbf{i} + V_o \sin\theta \mathbf{j} + R_o \Omega \mathbf{k}; \quad \mathbf{V}_{\text{lower}} = V_o \cos\theta \mathbf{i} - V_o \sin\theta \mathbf{j} - R_o \Omega \mathbf{k}$$

where $V_o = Q/(2A)$ is the exit velocity relative to the pipe walls. Then the moments about the x axis are related to angular momentum fluxes by

$$\begin{aligned} \sum \mathbf{M}_{\text{axis}} &= T \mathbf{i} = (\rho Q/2)(R_o \mathbf{j}) \times \mathbf{V}_{\text{upper}} + (\rho Q/2)(-R_o \mathbf{j}) \times \mathbf{V}_{\text{lower}} - \rho Q(\mathbf{r}_{\text{inlet}} \mathbf{V}_{\text{inlet}}) \\ &= \frac{\rho Q}{2} (R_o^2 \Omega \mathbf{i} - R_o V_o \Omega \mathbf{k}) + \frac{\rho Q}{2} (R_o^2 \Omega \mathbf{i} + R_o V_o \Omega \mathbf{k}) - \rho Q(0) \end{aligned}$$

Each arm contributes to the torque via relative velocity (ΩR_o). Other terms with V_o cancel.

$$\text{Final torque result: } T = \rho Q R_o^2 \Omega = \dot{m} R_o^2 \Omega \quad \text{Ans.}$$

3.113 Modify Ex. 3.14 so that the arm starts up from rest and spins up to its final rotation speed. The moment of inertia of the arm about O is I_o . Neglect air drag. Find $d\omega/dt$ and integrate to determine $\omega(t)$, assuming $\omega = 0$ at $t = 0$.

Solution: The CV is shown. Apply clockwise moments:

$$\sum \mathbf{M}_o - \int (\mathbf{r} \times \mathbf{a}_{\text{rel}}) dm = \int_{\text{CS}} (\mathbf{r} \times \mathbf{V}) dm,$$

$$\text{or: } -T_o - I_o \frac{d\omega}{dt} = \rho Q (R^2 \omega - R V_o),$$

$$\text{or: } \frac{d\omega}{dt} + \frac{\rho Q R^2}{I_o} \omega = \frac{\rho Q R V_o - T_o}{I_o}$$

Integrate this first-order linear differential equation, with $\omega = 0$ at $t = 0$. The result is:

$$\omega = \left(\frac{V_o}{R} - \frac{T_o}{\rho Q R^2} \right) \left[1 - e^{-\rho Q R^2 t / I_o} \right] \quad \text{Ans.}$$

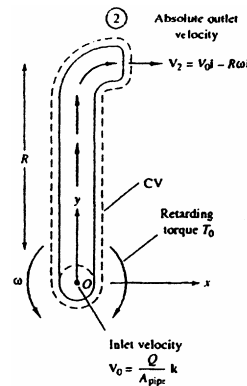

Fig. 3.14 View from above of a single arm of a rotating lawn sprinkler.

3.114 The 3-arm lawn sprinkler of Fig. P3.114 receives 20°C water through the center at 2.7 m³/hr. If collar friction is neglected, what is the steady rotation rate in rev/min for (a) $\theta = 0^\circ$; (b) $\theta = 40^\circ$?

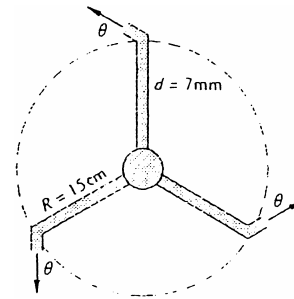

Fig. P3.114

Solution: The velocity exiting each arm is

$$V_o = \frac{Q/3}{(\pi/4)d^2} = \frac{2.7/[(3600)(3)]}{(\pi/4)(0.007)^2} = 6.50 \frac{\text{m}}{\text{s}}$$

With negligible air drag and bearing friction, the steady rotation rate (Example 3.15) is

$$\omega_{\text{final}} = \frac{V_o \cos \theta}{R} \quad (\text{a}) \quad \theta = 0^\circ: \quad \omega = \frac{(6.50) \cos 0^\circ}{0.15 \text{ m}} = 43.3 \frac{\text{rad}}{\text{s}} = \mathbf{414 \frac{\text{rev}}{\text{min}}} \quad \text{Ans. (a)}$$

$$(\text{b}) \quad \theta = 40^\circ: \quad \omega = \omega_o \cos \theta = (414) \cos 40^\circ = \mathbf{317 \frac{\text{rev}}{\text{min}}} \quad \text{Ans. (b)}$$

3.115 Water at 20°C flows at 30 gal/min through the 0.75-in-diameter double pipe bend of Fig. P3.115. The pressures are $p_1 = 30 \text{ lbf/in}^2$ and $p_2 = 24 \text{ lbf/in}^2$. Compute the torque T at point B necessary to keep the pipe from rotating.

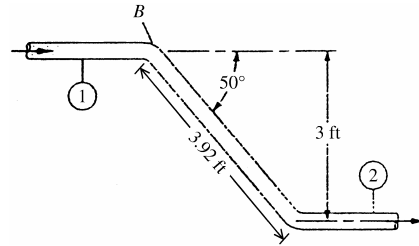

Fig. P3.115

Solution: This is similar to Example 3.13, of the text. The volume flow $Q = 30 \text{ gal/min} = 0.0668 \text{ ft}^3/\text{s}$, and $\rho = 1.94 \text{ slug/ft}^3$. Thus the mass flow $\rho Q = 0.130 \text{ slug/s}$. The velocity in the pipe is

$$V_1 = V_2 = Q/A = \frac{0.0668}{(\pi/4)(0.75/12)^2} = 21.8 \frac{\text{ft}}{\text{s}}$$

If we take torques about point B, then the distance “ h_1 ,” from p. 143, = 0, and $h_2 = 3 \text{ ft}$. The final torque at point B, from “Ans. (a)” on p. 143 of the text, is

$$T_B = h_2(p_2 A_2 + \dot{m} V_2) = (3 \text{ ft})[(24 \text{ psi}) \frac{\pi}{4} (0.75 \text{ in})^2 + (0.130)(21.8)] \approx \mathbf{40 \text{ ft} \cdot \text{lbf}} \quad \text{Ans.}$$

3.116 The centrifugal pump of Fig. P3.116 has a flow rate Q and exits the impeller at an angle θ_2 relative to the blades, as shown. The fluid enters axially at section 1. Assuming incompressible flow at shaft angular velocity ω , derive a formula for the power P required to drive the impeller.

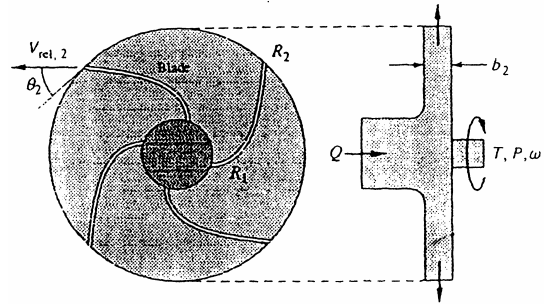
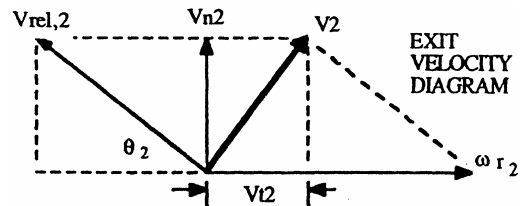

Fig. P3.116

Solution: Relative to the blade, the fluid exits at velocity $V_{rel,2}$ tangent to the blade, as shown in Fig. P3.116. But the Euler turbine formula, Ans. (a) from Example 3.14 of the text,

$$\begin{aligned} \text{Torque } T &= \rho Q (r_2 V_{t2} - r_1 V_{t1}) \\ &\approx \rho Q r_2 V_{t2} \quad (\text{assuming } V_{t1} \approx 0) \end{aligned}$$



involves the *absolute fluid velocity tangential to the blade circle* (see Fig. 3.13). To derive this velocity we need the “velocity diagram” shown above, where absolute exit velocity V_2 is found by adding blade tip rotation speed ωr_2 to $V_{rel,2}$. With trigonometry,

$$V_{t2} = r_2 \omega - V_{n2} \cot \theta_2, \quad \text{where } V_{n2} = Q/A_{\text{exit}} = \frac{Q}{2\pi r_2 b_2} \text{ is the normal velocity}$$

With torque T known, the power required is $P = T\omega$. The final formula is:

$$\mathbf{P = \rho Q r_2 \omega \left[r_2 \omega - \left(\frac{Q}{2\pi r_2 b_2} \right) \cot \theta_2 \right]} \quad \text{Ans.}$$

3.117 A simple turbomachine is constructed from a disk with two internal ducts which exit tangentially through square holes, as in the figure. Water at 20°C enters the disk at the center, as shown. The disk must drive, at 250 rev/min, a small device whose retarding torque is 1.5 N·m. What is the proper mass flow of water, in kg/s?

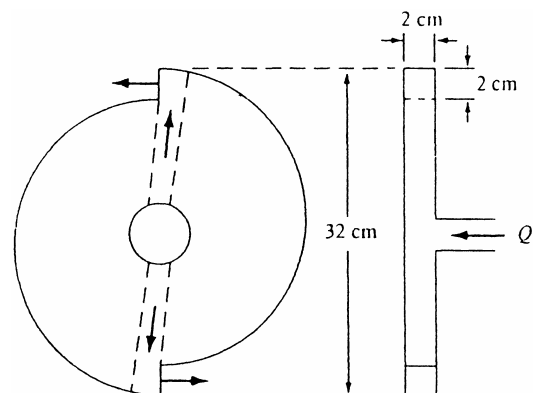

Solution: This problem is a disguised version of the lawn-sprinkler arm in Example 3.15. For that problem, the steady rotating speed, with retarding torque T_o , was

$$\omega = \frac{V_o}{R} - \frac{T_o}{\rho Q R^2}, \quad \text{where } V_o \text{ is the exit velocity and } R \text{ is the arm radius.}$$

Enter the given data, noting that $Q = 2V_o \Delta L_{\text{exit}}^2$ is the total volume flow from the two arms:

$$\omega = 250 \left(\frac{2\pi}{60} \right) \frac{\text{rad}}{\text{s}} = \frac{V_o}{0.16 \text{ m}} - \frac{1.5 \text{ N} \cdot \text{m}}{998(2V_o)(0.02 \text{ m})^2(0.16 \text{ m})^2}, \quad \text{solve } V_o = \mathbf{6.11} \frac{\text{m}}{\text{s}}$$

The required mass flow is thus,

$$\dot{m} = \rho Q = \left(998 \frac{\text{kg}}{\text{m}^3} \right) \left(2 \left(6.11 \frac{\text{m}}{\text{s}} \right) \right) (0.02 \text{ m})^2 = \mathbf{2.44} \frac{\text{kg}}{\text{s}} \quad \text{Ans.}$$

3.118 Reverse the flow in Fig. P3.116, so that the system operates as a radial-inflow turbine. Assuming that the outflow into section 1 has no tangential velocity, derive an expression for the power P extracted by the turbine.

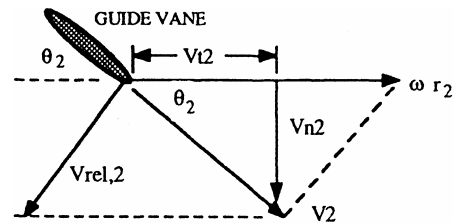

Solution: The Euler turbine formula, “Ans. (a)” from Example 3.14 of the text, is valid in reverse, that is, for a turbine with inflow at section 2 and outflow at section 1. The torque developed is

$$T_o = \rho Q (r_2 V_{t2} - r_1 V_{t1}) \approx \rho Q r_2 V_{t2} \quad \text{if } V_{t1} \approx 0$$

The velocity diagram is reversed, as shown in the figure. The fluid enters the turbine at angle θ_2 , which can only be ensured by a guide vane set at that angle. The absolute tangential velocity component is directly related to inlet normal velocity, giving the final result

$$V_{t2} = V_{n2} \cot \theta_2, \quad V_{n2} = \frac{Q}{2\pi r_2 b_2},$$

thus $P = \omega T_o = \rho Q \omega r_2 \left(\frac{Q}{2\pi r_2 b_2} \right) \cot \theta_2 \quad \text{Ans.}$

3.119 Revisit the turbine cascade system of Prob. 3.78, and derive a formula for the power P delivered, using the angular-momentum theorem of Eq. (3.55).

Solution: To use the angular momentum theorem, we need the inlet and outlet velocity diagrams, as in the figure. The Euler turbine formula becomes

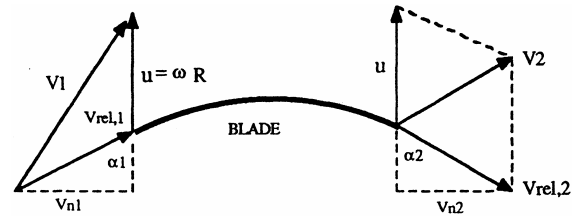

$$T_o = \rho Q(r_1 V_{t1} - r_2 V_{t2}) \approx \rho QR(V_{t1} - V_{t2})$$

since the blades are at nearly constant radius R . From the velocity diagrams, we find

$$V_{t1} = u + V_{n1} \cot \alpha_1; \quad V_{t2} = u - V_{n2} \cot \alpha_2, \quad \text{where } V_{n1} = V_{n2} = V_1 \cos \beta_1$$

The normal velocities are equal by virtue of mass conservation across the blades. Finally,

$$P = \rho Q \omega R (V_{t1} - V_{t2}) = \rho Q u V_n (\cot \alpha_1 + \cot \alpha_2) \quad \text{Ans.}$$

3.120 A centrifugal pump delivers 4000 gal/min of water at 20°C with a shaft rotating at 1750 rpm. Neglect losses. If $r_1 = 6$ in, $r_2 = 14$ in, $b_1 = b_2 = 1.75$ in, $V_{t1} = 10$ ft/s, and $V_{t2} = 110$ ft/s, compute the absolute velocities (a) V_1 and (b) V_2 , and (c) the ideal horsepower required.

Solution: First convert 4000 gal/min = 8.91 ft³/s and 1750 rpm = 183 rad/s. For water, take $\rho = 1.94$ slug/ft³. The normal velocities are determined from mass conservation:

$$V_{n1} = \frac{Q}{2\pi r_1 b_1} = \frac{8.91}{2\pi(6/12)(1.75/12)} = 19.5 \frac{\text{ft}}{\text{s}}; \quad V_{n2} = \frac{Q}{2\pi r_2 b_2} = 8.34 \frac{\text{ft}}{\text{s}}$$

Then the desired absolute velocities are simply the resultants of V_t and V_n :

$$V_1 = [(10)^2 + (19.45)^2]^{1/2} = \mathbf{22 \frac{ft}{s}} \quad V_2 = [(110)^2 + (8.3)^2]^{1/2} = \mathbf{110 \frac{ft}{s}} \quad \text{Ans. (a, b)}$$

The ideal power required is given by Euler's formula:

$$\begin{aligned} P &= \rho Q \omega (r_2 V_{t2} - r_1 V_{t1}) = (1.94)(8.91)(183)[(14/12)(110) - (6/12)(10)] \\ &= 391,000 \frac{\text{ft}\cdot\text{lbf}}{\text{s}} \approx \mathbf{710 \text{ hp}} \quad \text{Ans. (c)} \end{aligned}$$

3.121 The pipe bend of Fig. P3.121 has $D_1 = 27$ cm and $D_2 = 13$ cm. When water at 20°C flows through the pipe at 4000 gal/min, $p_1 = 194$ kPa (gage). Compute the torque required at point B to hold the bend stationary.

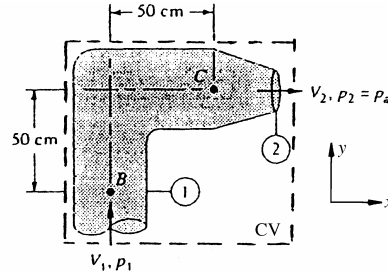

Fig. P3.121

Solution: First convert $Q = 4000$ gal/min = 0.252 m³/s. We need the exit velocity:

$$V_2 = Q/A_2 = \frac{0.252}{(\pi/4)(0.13)^2} = 19.0 \frac{\text{m}}{\text{s}} \quad \text{Meanwhile, } V_1 = Q/A_1 = 4.4 \frac{\text{m}}{\text{s}}$$

We don't really need V_1 , because it passes through B and has no angular momentum. The angular momentum theorem is then applied to point B :

$$\sum \mathbf{M}_B = \mathbf{T}_B + \mathbf{r}_1 \times p_1 A_1 \mathbf{j} + \mathbf{r}_2 \times p_2 A_2 (-\mathbf{i}) = \dot{m}(\mathbf{r}_2 \times \mathbf{V}_2 - \mathbf{r}_1 \times \mathbf{V}_1)$$

But r_1 and p_2 are zero,

$$\text{hence } \mathbf{T}_B = \dot{m}(\mathbf{r}_2 \times \mathbf{V}_2) = \rho Q[(0.5\mathbf{i} + 0.5\mathbf{j}) \times (19.0\mathbf{i})]$$

Thus, finally, $\mathbf{T}_B = (998)(0.252)(0.5)(19.0)(-\mathbf{k}) \approx -2400 \text{ k N}\cdot\text{m}$ (clockwise) *Ans.*

3.122 Extend Prob. 3.46 to the problem of computing the center of pressure L of the normal face F_n , as in Fig. P3.122. (At the center of pressure, no moments are required to hold the plate at rest.) Neglect friction. Express your result in terms of the sheet thickness h_1 and the angle θ between the plate and the oncoming jet 1 .

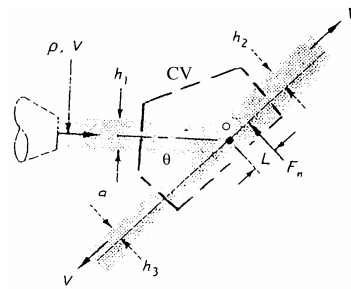

Fig. P3.122

Solution: Recall that in Prob. 3.46 of this Manual, we found $h_2 = (h_1/2)(1 + \cos\theta)$ and that $h_3 = (h_1/2)(1 - \cos\theta)$. The force on the plate was $F_n = \rho Q V \sin\theta$. Take clockwise moments about O and use the angular momentum theorem:

$$\begin{aligned} \sum M_o &= -F_n L = \dot{m}_2 |\mathbf{r}_{2o} \times \mathbf{V}_2|_z + \dot{m}_3 |\mathbf{r}_{3o} \times \mathbf{V}_3|_z - \dot{m}_1 |\mathbf{r}_{1o} \times \mathbf{V}_1|_z \\ &= \rho V h_2 (h_2 V/2) + \rho V h_3 (-h_3 V/2) - 0 = (1/2) \rho V^2 (h_2^2 - h_3^2) \end{aligned}$$

$$\text{Thus } L = -\frac{(1/2)\rho V^2 (h_2^2 - h_3^2)}{\rho V^2 h_1 \sin \theta} = -\frac{(h_2^2 - h_3^2)}{2h_1 \sin \theta} = -\frac{1}{2} h_1 \cot \theta \quad \text{Ans.}$$

The latter result follows from the (h_1, h_2, h_3) relations in 3.46. The C.P. is below point O.

3.123 The waterwheel in Fig. P3.123 is being driven at 200 r/min by a 150-ft/s jet of water at 20°C. The jet diameter is 2.5 in. Assuming no losses, what is the horsepower developed by the wheel? For what speed Ω r/min will the horsepower developed be a maximum? Assume that there are many buckets on the waterwheel.

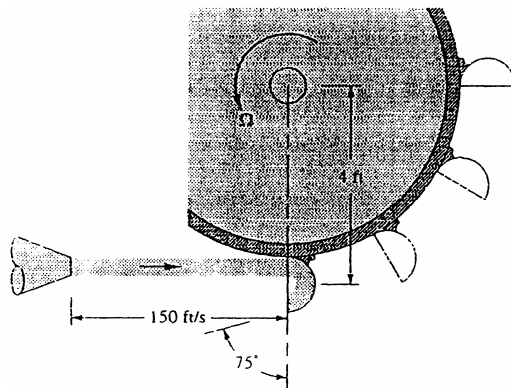

Fig. P3.123

Solution: First convert $\Omega = 200 \text{ rpm} = 20.9 \text{ rad/s}$. The bucket velocity = $V_b = \Omega R = (20.9)(4) = 83.8 \text{ ft/s}$. From Prob. 3.51 of this Manual, if there are many buckets, the entire (absolute) jet mass flow does the work:

$$\begin{aligned} P &= \dot{m}_{\text{jet}} V_b (V_{\text{jet}} - V_b)(1 - \cos 165^\circ) = \rho A_{\text{jet}} V_{\text{jet}} V_b (V_{\text{jet}} - V_b)(1.966) \\ &= (1.94) \frac{\pi}{4} \left(\frac{2.5}{12} \right)^2 (150)(83.8)(150 - 83.8)(1.966) \\ &= 108200 \frac{\text{ft} \cdot \text{lbf}}{\text{s}} \approx \mathbf{197 \text{ hp}} \quad \text{Ans.} \end{aligned}$$

Prob. 3.51: Max. power is for $V_b = V_{\text{jet}}/2 = 75 \text{ ft/s}$, or $\Omega = 18.75 \text{ rad/s} = \mathbf{179 \text{ rpm}}$ Ans.

3.124 A rotating dishwasher arm delivers at 60°C to six nozzles, as in Fig. P3.124. The total flow rate is 3.0 gal/min. Each nozzle has a diameter of $\frac{3}{16}$ in. If the nozzle flows are equal and friction is neglected, estimate the steady rotation rate of the arm, in r/min.

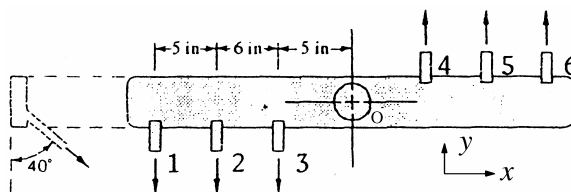

Fig. P3.124

Solution: First we need the mass flow and velocity from each hole “i,” $i = 1$ to 6:

$$V_i = \frac{Q_i}{A_i} = \frac{(3.0/448.8)/6}{(\pi/4)\left(\frac{3/16}{12}\right)^2} \approx 5.81 \frac{\text{ft}}{\text{s}} \quad \dot{m}_i = \frac{\rho Q}{6} = 1.94 \left(\frac{3/448.8}{6}\right) = 0.00216 \frac{\text{slug}}{\text{s}}$$

Recall Example 3.15 from the text. For each hole, we need the absolute velocity, $V_i - \Omega r_i$. The angular momentum theorem is then applied to moments about point O:

$$\sum M_O = T_O = \sum \dot{m}_i (\mathbf{r}_{iO} \times \mathbf{V}_{i,\text{abs}}) - \dot{m}_{\text{in}} V_{\text{in}} = \sum \dot{m}_i r_i (V_i \cos 40^\circ - \Omega r_i)$$

All the velocities and mass flows from each hole are equal. Then, if $T_O = 0$ (no friction),

$$\Omega = \frac{\sum \dot{m}_i r_i V_i \cos 40^\circ}{\sum \dot{m}_i r_i^2} = V_i \cos 40^\circ \frac{\sum r_i}{\sum r_i^2} = (5.81)(0.766) \frac{5.33}{5.58} = 4.25 \frac{\text{rad}}{\text{s}} = \mathbf{41 \text{ rpm}} \quad \text{Ans.}$$

3.125 A liquid of density ρ flows through a 90° bend as in Fig. P3.125 and issues vertically from a uniformly porous section of length L . Neglecting weight, find a result for the support torque M required at point O.

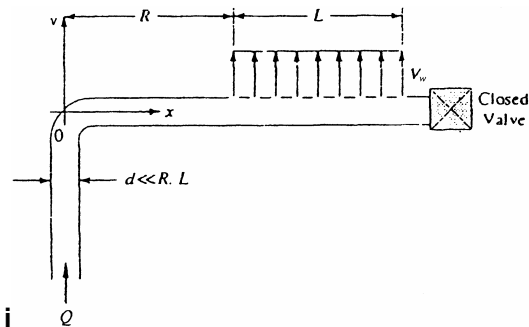

Fig. P3.125

Solution: Mass conservation requires

$$Q = \int_0^L V_w (\pi d) dx = V_w \pi d L, \quad \text{or:} \quad \frac{dQ}{dx} = \pi d V_w$$

Then the angular momentum theorem applied to moments about point O yields

$$\begin{aligned} \sum \mathbf{M}_O = \mathbf{T}_O &= \int_{\text{CS}} (\mathbf{r}_O \times \mathbf{V}) d\dot{m}_{\text{out}} = \mathbf{k} \int_0^L (R+x) V_w \rho \pi d V_w dx \\ &= \frac{\mathbf{k}}{2} \rho \pi d V_w^2 [(R+x)^2 - R^2] \Big|_0^L \end{aligned}$$

Substitute $V_w \pi d L = Q$ and clean up to obtain $\mathbf{T}_O = \rho Q V_w \left(R + \frac{L}{2} \right) \mathbf{k} \hat{\mathbf{r}}$ Ans.

3.126 Given a steady isothermal flow of water at 20°C through the device in Fig. P3.126. Heat-transfer, gravity, and temperature effects are negligible. Known data are $D_1 = 9$ cm, $Q_1 = 220$ m³/h, $p_1 = 150$ kPa, $D_2 = 7$ cm, $Q_2 = 100$ m³/h, $p_2 = 225$ kPa, $D_3 = 4$ cm, and $p_3 = 265$ kPa. Compute the rate of shaft work done for this device and its direction.

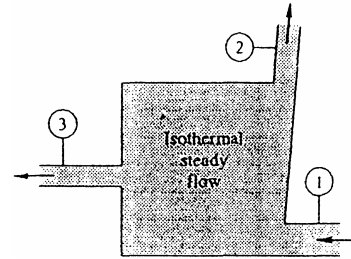

Fig. P3.126

Solution: For continuity, $Q_3 = Q_1 - Q_2 = 120$ m³/hr. Establish the velocities at each port:

$$V_1 = \frac{Q_1}{A_1} = \frac{220/3600}{\pi(0.045)^2} = 9.61 \frac{\text{m}}{\text{s}}; \quad V_2 = \frac{100/3600}{\pi(0.035)^2} = 7.22 \frac{\text{m}}{\text{s}}; \quad V_3 = \frac{120/3600}{\pi(0.02)^2} = 26.5 \frac{\text{m}}{\text{s}}$$

With gravity and heat transfer and internal energy neglected, the energy equation becomes

$$\dot{Q} - \dot{W}_s - \dot{W}_v = \dot{m}_3 \left(\frac{p_3}{\rho_3} + \frac{V_3^2}{2} \right) + \dot{m}_2 \left(\frac{p_2}{\rho_2} + \frac{V_2^2}{2} \right) - \dot{m}_1 \left(\frac{p_1}{\rho_1} + \frac{V_1^2}{2} \right),$$

$$\text{or: } -\dot{W}_s/\rho = \frac{100}{3600} \left[\frac{225000}{998} + \frac{(7.22)^2}{2} \right] + \frac{120}{3600} \left[\frac{265000}{998} + \frac{(26.5)^2}{2} \right] \\ + \frac{220}{3600} \left[\frac{150000}{998} + \frac{(9.61)^2}{2} \right]$$

Solve for the shaft work: $\dot{W}_s = 998(-6.99 - 20.56 + 12.00) \approx -15500 \text{ W}$ Ans.

(negative denotes work done on the fluid)

3.127 A power plant on a river, as in Fig. P3.127, must eliminate 55 MW of waste heat to the river. The river conditions upstream are $Q_1 = 2.5$ m³/s and $T_1 = 18^\circ\text{C}$. The river is 45 m wide and 2.7 m deep. If heat losses to the atmosphere and ground are negligible, estimate the downstream river conditions (Q_0 , T_0).

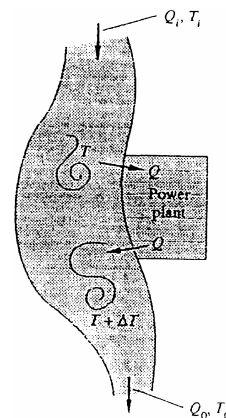

Fig. P3.127

Solution: For water, take $c_p \approx 4280 \text{ J/kg}\cdot^\circ\text{C}$. For an overall CV enclosing the entire sketch,

$$\dot{Q} = \dot{m}_{\text{out}}(c_p T_{\text{out}}) - \dot{m}_{\text{in}}(c_p T_{\text{in}}),$$

or: $55,000,000 \text{ W} \approx (998 \times 2.5)[4280 T_{\text{out}} - 4280(18)]$, solve for $T_{\text{out}} \approx \mathbf{23.15^\circ\text{C}}$ *Ans.*

The power plant flow is “internal” to the CV, hence $Q_{\text{out}} = Q_{\text{in}} = \mathbf{2.5 \text{ m}^3/\text{s}}$. *Ans.*

3.128 For the conditions of Prob. 3.127, if the power plant is to heat the nearby river water by no more than 12°C , what should be the minimum flow rate Q , in m^3/s , through the plant heat exchanger? How will the value of Q affect the downstream conditions (Q_o, T_o)?

Solution: Now let the CV only enclose the power plant, so that the flow going through the plant shows as an inlet and an outlet. The CV energy equation, with no work, gives

$$\dot{Q}_{\text{plant}} = \dot{m}_{\text{out}} c_p T_{\text{out}} - \dot{m}_{\text{in}} c_p T_{\text{in}} = (998)Q_{\text{plant}}(4280)(12^\circ\text{C}) \quad \text{since } Q_{\text{in}} = Q_{\text{out}}$$

$$\text{Solve for } Q_{\text{plant}} = \frac{55,000,000}{(998)(4280)(12)} \approx \mathbf{1.07 \text{ m}^3/\text{s}} \quad \text{Ans.}$$

It’s a lot of flow, but if the river water mixes well, the downstream flow is still the same.

3.129 Multnomah Falls in the Columbia River Gorge has a sheer drop of 543 ft. Use the steady flow energy equation to estimate the water temperature rise, in $^\circ\text{F}$, resulting.

Solution: For water, convert $c_p = 4200 \times 5.9798 = 25100 \text{ ft}\cdot\text{lbf}/(\text{slug}\cdot^\circ\text{F})$. Use the steady flow energy equation in the form of Eq. (3.66), with “1” upstream at the top of the falls:

$$h_1 + \frac{1}{2}V_1^2 + gz_1 = h_2 + \frac{1}{2}V_2^2 + gz_2 - q$$

Assume adiabatic flow, $q = 0$ (although evaporation might be important), and neglect the kinetic energies, which are much smaller than the potential energy change. Solve for

$$\Delta h = c_p \Delta T \approx g(z_1 - z_2), \quad \text{or: } \Delta T = \frac{32.2(543)}{25100} \approx \mathbf{0.70^\circ\text{F}} \quad \text{Ans.}$$

3.130 When the pump in Fig. P3.130 draws $220 \text{ m}^3/\text{h}$ of water at 20°C from the reservoir, the total friction head loss is 5 m . The flow discharges through a nozzle to the atmosphere. Estimate the pump power in kW delivered to the water.

Solution: Let “1” be at the reservoir surface and “2” be at the nozzle exit, as shown. We need to know the exit velocity:

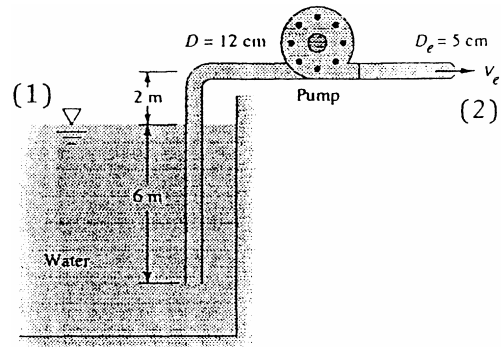

Fig. P3.130

$$V_2 = Q/A_2 = \frac{220/3600}{\pi(0.025)^2} = 31.12 \frac{\text{m}}{\text{s}}, \quad \text{while } V_1 \approx 0 \text{ (reservoir surface)}$$

Now apply the steady flow energy equation from (1) to (2):

$$\frac{p_1}{\rho g} + \frac{V_1^2}{2g} + z_1 = \frac{p_2}{\rho g} + \frac{V_2^2}{2g} + z_2 + h_f - h_p,$$

$$\text{or: } 0 + 0 + 0 = 0 + (31.12)^2/[2(9.81)] + 2 + 5 - h_p, \quad \text{solve for } h_p \approx 56.4 \text{ m.}$$

$$\begin{aligned} \text{The pump power } P &= \rho g Q h_p = (998)(9.81)(220/3600)(56.4) \\ &= 33700 \text{ W} = \mathbf{33.7 \text{ kW}} \quad \text{Ans.} \end{aligned}$$

3.131 When the pump in Fig. P3.130 delivers 25 kW of power to the water, the friction head loss is 4 m . Estimate (a) the exit velocity; and (b) the flow rate.

Solution: The energy equation just above must now be written with V_2 and Q unknown:

$$0 + 0 + 0 = 0 + \frac{V_2^2}{2g} + 2 + 4 - h_p, \quad \text{where } h_p = \frac{P}{\rho g Q} = \frac{25000}{(998)(9.81)Q}$$

$$\text{and where } V_2 = \frac{Q}{\pi(0.025)^2}. \quad \text{Solve numerically by iteration: } V_2 \approx \mathbf{28.1 \text{ m/s}} \quad \text{Ans. (a)}$$

$$\text{and } Q = (28.1)\pi(0.025)^2 \approx 0.0552 \text{ m}^3/\text{s} \approx \mathbf{200 \text{ m}^3/\text{hr}} \quad \text{Ans. (b)}$$

3.132 Consider a turbine extracting energy from a penstock in a dam, as in the figure. For turbulent flow (Chap. 6) the friction head loss is $h_f = CQ^2$, where the constant C depends upon penstock dimensions and water physical properties. Show that, for a given penstock and river flow Q , the maximum turbine power possible is $P_{\max} = 2\rho gHQ/3$ and occurs when $Q = (H/3C)^{1/2}$.

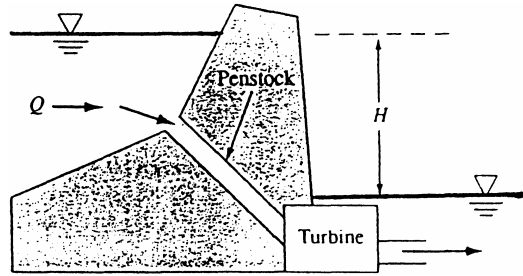

Solution: Write the steady flow energy equation from point 1 on the upper surface to point 2 on the lower surface:

$$\frac{p_1}{\rho g} + \frac{V_1^2}{2g} + H = \frac{p_2}{\rho g} + \frac{V_2^2}{2g} + 0 + h_f + h_{\text{turbine}}$$

But $p_1 = p_2 = p_{\text{atm}}$ and $V_1 \approx V_2 \approx 0$. Thus the turbine head is given by

$$h_t = H - h_f = H - CQ^2,$$

$$\text{or: Power} = P = \rho g Q h_t = \rho g Q H - \rho g C Q^3$$

Differentiate and set equal to zero for max power and appropriate flow rate:

$$\frac{dP}{dQ} = \rho g H - 3\rho g C Q^2 = 0 \quad \text{if } Q = \sqrt{H/3C} \quad \text{Ans.}$$

$$\text{Insert } Q \text{ in } P \text{ to obtain } P_{\max} = \rho g Q \left(\frac{2H}{3} \right) \quad \text{Ans.}$$

3.133 The long pipe in Fig. 3.133 is filled with water at 20°C. When valve A is closed, $p_1 - p_2 = 75$ kPa. When the valve is open and water flows at 500 m³/h, $p_1 - p_2 = 160$ kPa. What is the friction head loss between 1 and 2, in m, for the flowing condition?

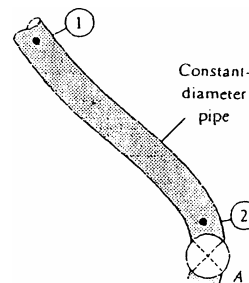

Fig. P3.133

Solution: With the valve closed, there is no velocity or friction loss:

$$\frac{p_1}{\rho g} + z_1 = \frac{p_2}{\rho g} + z_2, \quad \text{or:} \quad z_2 - z_1 = \frac{p_1 - p_2}{\rho g} = \frac{75000}{998(9.81)} \approx 7.66 \text{ m}$$

When the valve is open, the velocity is the same at (1) and (2), thus “d” is not needed:

$$\text{With flow: } h_f = \frac{p_1 - p_2}{\rho g} + \frac{V_1^2 - V_2^2}{2g} + (z_1 - z_2) = \frac{160000}{998(9.81)} + 0 - 7.66 \approx \mathbf{8.7 \text{ m}} \quad \text{Ans.}$$

3.134 A 36-in-diameter pipeline carries oil (SG = 0.89) at 1 million barrels per day (bbl/day) (1 bbl = 42 U.S. gal). The friction head loss is 13 ft/1000 ft of pipe. It is planned to place pumping stations every 10 mi along the pipe. Estimate the horsepower which must be delivered to the oil by each pump.

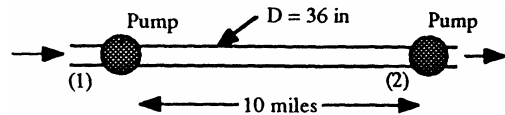

Solution: Since ΔV and Δz are zero, the energy equation reduces to

$$h_f = \frac{\Delta p}{\rho g}, \quad \text{and} \quad h_f = 0.013 \frac{\text{ft-loss}}{\text{ft-pipe}} (10 \text{ mi}) \left(5280 \frac{\text{ft}}{\text{mi}} \right) \approx 686 \text{ ft}$$

Convert the flow rate from 1E6 bbl/day to 29166 gal/min to **65.0** ft³/s. Then the power is

$$P = Q\Delta p = \gamma Q h_f = (62.4)(65.0)(686) = 2.78\text{E}6 \frac{\text{ft} \cdot \text{lb}_f}{\text{s}} \approx \mathbf{5060 \text{ hp}} \quad \text{Ans.}$$

3.135 The *pump-turbine* system in Fig. P3.135 draws water from the upper reservoir in the daytime to produce power for a city. At night, it pumps water from lower to upper reservoirs to restore the situation. For a design flow rate of 15,000 gal/min in either direction, the friction head loss is 17 ft. Estimate the power in kW (a) extracted by the turbine and (b) delivered by the pump.

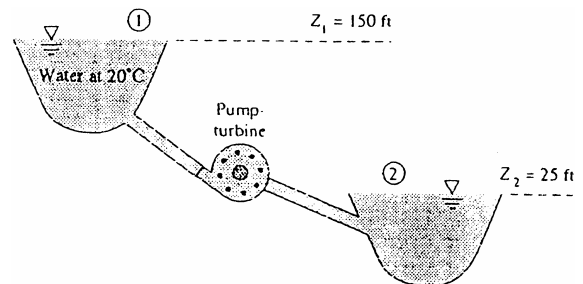

Fig. P3.135

Solution: (a) With the turbine, “1” is upstream:

$$\frac{p_1}{\rho g} + \frac{V_1^2}{2g} + z_1 = \frac{p_2}{\rho g} + \frac{V_2^2}{2g} + z_2 + h_f + h_t,$$

$$\text{or: } 0 + 0 + 150 = 0 + 0 + 25 + 17 + h_t$$

Solve for $h_t = 108$ ft. Convert $Q = 15000$ gal/min = **33.4** ft³/s. Then the turbine power is

$$P = \gamma Q h_{\text{turb}} = (62.4)(33.4)(108) = 225,000 \frac{\text{ft} \cdot \text{lbf}}{\text{s}} \approx \mathbf{410 \text{ hp}} \quad \text{Ans. (a)}$$

(b) For pump operation, point “2” is upstream:

$$\frac{p_2}{\rho g} + \frac{V_2^2}{2g} + z_2 = \frac{p_1}{\rho g} + \frac{V_1^2}{2g} + z_1 + h_f - h_p,$$

$$\text{or: } 0 + 0 + 25 = 0 + 0 + 150 + 17 - h_p$$

$$\text{Solve for } h_p \approx 142 \text{ ft}$$

The pump power is $P_{\text{pump}} = \gamma Q h_p = (62.4)(33.4)(142) = 296000$ ft·lbf/s = **540 hp**. *Ans. (b)*

3.136 Water at 20°C is delivered from one reservoir to another through a long 8-cm-diameter pipe. The lower reservoir has a surface elevation $z_2 = 80$ m. The friction loss in the pipe is correlated by the formula $h_{\text{loss}} \approx 17.5(V^2/2g)$, where V is the average velocity in the pipe. If the steady flow rate through the pipe is 500 gallons per minute, estimate the surface elevation of the higher reservoir.

Solution: We may apply Bernoulli here,

$$h_f = \frac{17.5V^2}{2g} = z_1 - z_2$$

$$\frac{17.5}{2(9.81 \text{ m/s}^2)} \left[\frac{(500 \text{ gal/min})(3.785 \text{ m}^3/\text{gal})(\text{min}/60 \text{ s})}{\frac{\pi}{4}(0.08^2)} \right]^2 = z_1 - 80 \text{ m}$$

$$z_1 \approx \mathbf{115 \text{ m}} \quad \text{Ans.}$$

3.137 A fireboat draws seawater ($SG = 1.025$) from a submerged pipe and discharges it through a nozzle, as in Fig. P3.137. The total head loss is 6.5 ft. If the pump efficiency is 75 percent, what horsepower motor is required to drive it?

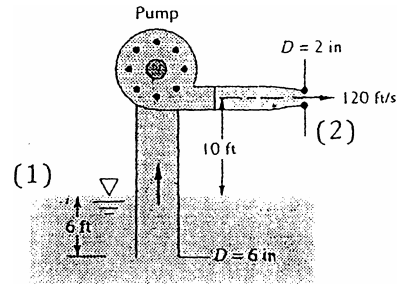

Fig. P3.137

Solution: For seawater, $\gamma = 1.025(62.4) = 63.96 \text{ lbf/ft}^3$. The energy equation becomes

$$\frac{p_1}{\rho g} + \frac{V_1^2}{2g} + z_1 = \frac{p_2}{\rho g} + \frac{V_2^2}{2g} + z_2 + h_f - h_p,$$

$$\text{or: } 0 + 0 + 0 = 0 + \frac{(120)^2}{2(32.2)} + 10 + 6.5 - h_p$$

Solve for $h_p = 240 \text{ ft}$. The flow rate is $Q = V_2 A_2 = (120)(\pi/4)(2/12)^2 = 2.62 \text{ ft}^3/\text{s}$. Then

$$P_{\text{pump}} = \frac{\gamma Q h_p}{\text{efficiency}} = \frac{(63.96)(2.62)(240)}{0.75} = 53600 \frac{\text{ft} \cdot \text{lbf}}{\text{s}} \approx \mathbf{97 \text{ hp}} \quad \text{Ans.}$$

3.138 Students in the fluid mechanics lab at Penn State University use the device in the figure to measure the viscosity of water: a tank and a capillary tube. The flow is laminar and has negligible entrance loss, in which case Chap. 6 theory shows that $h_f = 32\mu LV/(\rho g d^2)$. Students measure water temperature with a thermometer and Q with a stopwatch and a graduated cylinder. Density is measured by weighing a known volume. (a) Write an expression for μ as a function of these variables. (b) Calculate μ for the following actual data: $T = 16.5^\circ\text{C}$, $\rho = 998.7 \text{ kg/m}^3$, $d = 0.041 \text{ in}$, $Q = 0.31 \text{ mL/s}$, $L = 36.1 \text{ in}$, and $H = 0.153 \text{ m}$. (c) Compare this μ with the published result for the same temperature. (d) Compute the error which would occur if one forgot to include the kinetic energy correction factor. Is this correction important here?

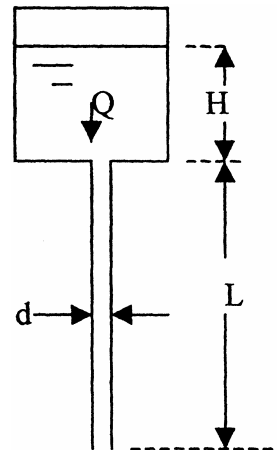

Solution: (a) Write the steady flow energy equation from top to bottom:

$$\frac{p_1}{\rho g} + \frac{\alpha_1 V_1^2}{2g} + (H + L) = \frac{p_2}{\rho g} + \frac{\alpha_2 V_2^2}{2g} + 0 + h_f, \quad \text{or:} \quad h_f = \frac{32\mu LV}{\rho g d^2} = H + L - \frac{\alpha_2 V_2^2}{2g}$$

Noting that, in a tube, $Q = V\pi d^2/4$, we may eliminate V in favor of Q and solve for the fluid viscosity:

$$\mu = \frac{\pi \rho g d^4}{128 L Q} (H + L) - \frac{\alpha_2 \rho Q}{16 \pi L} \quad \text{Ans. (a)}$$

(b) For the given data, converting $d = 0.041 \text{ in} = 0.00104 \text{ m}$, $L = 36.1 \text{ in} = 0.917 \text{ m}$, and $Q = 0.31 \text{ mL/s} = 3.1 \text{E-}7 \text{ m}^3/\text{s}$, we may substitute in the above formula (a) and calculate

$$\begin{aligned} \mu &= \frac{\pi(998.7)(9.81)(0.00104)^4}{128(0.917)(3.1\text{E-}7)}(0.153 + 0.917) - \frac{2.0(998.7)(3.1\text{E-}7)}{16\pi(0.917)} \\ &= 0.001063 - 0.000013 \approx \mathbf{0.00105} \frac{\text{kg}}{\text{m} \cdot \text{s}} \quad \text{Ans. (b)} \end{aligned}$$

(c) The accepted value (see Appendix Table A-1) for water at 16.5°C is $\mu \approx 1.11\text{E-}3 \text{ kg/m}\cdot\text{s}$, the error in the experiment is thus about -5.5% . *Ans. (c)*

(d) If we forgot the kinetic-energy correction factor $\alpha_2 = 2.0$ for laminar flow, the calculation in part (b) above would result in

$$\mu = 0.001063 - 0.000007 \approx \mathbf{0.001056} \text{ kg/m}\cdot\text{s} \text{ (negligible 0.6\% error)} \quad \text{Ans. (d)}$$

In this experiment, the dominant (first) term is the *elevation change* ($H + L$)—the momentum exiting the tube is negligible because of the low velocity (0.36 m/s).

3.139 The horizontal pump in Fig. P3.139 discharges 20°C water at $57 \text{ m}^3/\text{h}$. Neglecting losses, what power in kW is delivered to the water by the pump?

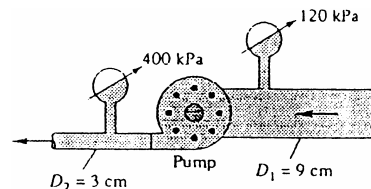

Fig. P3.139

Solution: First we need to compute the velocities at sections (1) and (2):

$$V_1 = \frac{Q}{A_1} = \frac{57/3600}{\pi(0.045)^2} = 2.49 \frac{\text{m}}{\text{s}}; \quad V_2 = \frac{Q}{A_2} = \frac{57/3600}{\pi(0.015)^2} = 22.4 \frac{\text{m}}{\text{s}}$$

Then apply the steady flow energy equation across the pump, neglecting losses:

$$\frac{p_1}{\rho g} + \frac{V_1^2}{2g} + z_1 = \frac{p_2}{\rho g} + \frac{V_2^2}{2g} + z_2 + h_f - h_p,$$

$$\text{or: } \frac{120000}{9790} + \frac{(2.49)^2}{2(9.81)} + 0 = \frac{400000}{9790} + \frac{(22.4)^2}{2(9.81)} + 0 + 0 - h_p, \quad \text{solve for } h_p \approx 53.85 \text{ m}$$

$$\text{Then the pump power is } P_p = \gamma Q h_p = 9790 \left(\frac{57}{3600} \right) (53.85) = 8350 \text{ W} = \mathbf{8.4 \text{ kW}} \quad \text{Ans.}$$

3.140 Steam enters a horizontal turbine at 350 lbf/in² absolute, 580°C, and 12 ft/s and is discharged at 110 ft/s and 25°C saturated conditions. The mass flow is 2.5 lbm/s, and the heat losses are 7 Btu/lb of steam. If head losses are negligible, how much horsepower does the turbine develop?

Solution: We have to use the Steam Tables to find the enthalpies. State (2) is *saturated* vapor at 25°C = 77°F, for which we find $h_2 \approx 1095.1 \text{ Btu/lbm} \approx 2.74\text{E}7 \text{ ft}\cdot\text{lbf/slug}$. At state (1), 350 psia and 580°C = 1076°F, we find $h_1 \approx 1565.3 \text{ Btu/lbm} \approx 3.92\text{E}7 \text{ ft}\cdot\text{lbf/slug}$. The heat loss is 7 Btu/lbm $\approx 1.75\text{E}5 \text{ ft}\cdot\text{lbf/slug}$. The steady flow energy equation is best written on a per-mass basis:

$$q - w_s = h_2 + \frac{1}{2}V_2^2 - h_1 - \frac{1}{2}V_1^2, \quad \text{or:}$$

$$-1.75\text{E}5 - w_s = 2.74\text{E}7 + (110)^2/2 - 3.92\text{E}7 - (12)^2/2, \quad \text{solve for } w_s \approx 1.16\text{E}7 \frac{\text{ft}\cdot\text{lbf}}{\text{slug}}$$

The result is positive because work is done by the fluid. The turbine power at 100% is

$$P_{\text{turb}} = \dot{m}w_s = \left(\frac{2.5}{32.2} \frac{\text{slug}}{\text{s}} \right) \left(1.16\text{E}7 \frac{\text{ft}\cdot\text{lbf}}{\text{slug}} \right) = 901000 \frac{\text{ft}\cdot\text{lbf}}{\text{s}} \approx \mathbf{1640 \text{ hp}} \quad \text{Ans.}$$

3.141 Water at 20°C is pumped at 1500 gal/min from the lower to the upper reservoir, as in Fig. P3.141. Pipe friction losses are approximated by $h_f \approx 27V^2/(2g)$, where V is the average velocity in the pipe. If the pump is 75 percent efficient, what horsepower is needed to drive it?

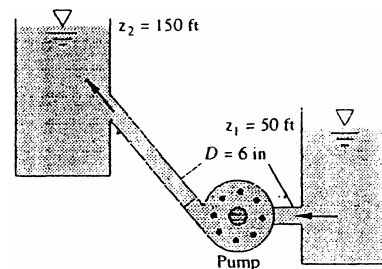

Fig. P3.141

Solution: First evaluate the average velocity in the pipe and the friction head loss:

$$Q = \frac{1500}{448.8} = 3.34 \frac{\text{ft}^3}{\text{s}}, \quad \text{so } V = \frac{Q}{A} = \frac{3.34}{\pi(3/12)^2} = 17.0 \frac{\text{ft}}{\text{s}} \quad \text{and} \quad h_f = 27 \frac{(17.0)^2}{2(32.2)} \approx \mathbf{121 \text{ ft}}$$

Then apply the steady flow energy equation:

$$\frac{p_1}{\rho g} + \frac{V_1^2}{2g} + z_1 = \frac{p_2}{\rho g} + \frac{V_2^2}{2g} + z_2 + h_f - h_p,$$

$$\text{or: } 0 + 0 + 50 = 0 + 0 + 150 + 121 - h_p$$

$$\begin{aligned} \text{Thus } h_p = 221 \text{ ft, so } P_{\text{pump}} &= \frac{\gamma Q h_p}{\eta} = \frac{(62.4)(3.34)(221)}{0.75} \\ &= 61600 \frac{\text{ft} \cdot \text{lbf}}{\text{s}} \approx \mathbf{112 \text{ hp}} \quad \text{Ans.} \end{aligned}$$

3.142 A typical pump has a head which, for a given shaft rotation rate, varies with the flow rate, resulting in a *pump performance curve* as in Fig. P3.142. Suppose that this pump is 75 percent efficient and is used for the system in Prob. 3.141. Estimate (a) the flow rate, in gal/min, and (b) the horsepower needed to drive the pump.

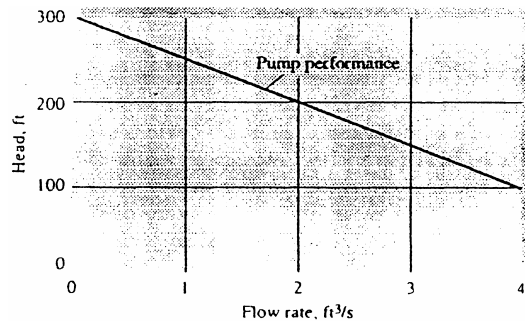

Fig. P3.142

Solution: This time we do not know the flow rate, but the pump head is $h_p \approx 300 - 50Q$, with Q in cubic feet per second. The energy equation directly above becomes,

$$0 + 0 + 50 = 0 + 0 + 150 + (27) \frac{V^2}{2(32.2)} - (300 - 50Q), \quad \text{where } Q = V \frac{\pi}{4} (0.5 \text{ ft})^2$$

This becomes the quadratic $Q^2 + 4.60Q - 18.4 = 0$, solve for $Q \approx 2.57 \text{ ft}^3/\text{s}$

$$\begin{aligned} \text{Then the power is } P_{\text{pump}} &= \frac{\gamma Q h_p}{\eta} = \frac{(62.4)(2.57)[300 - 50(2.57)]}{0.75} \\ &= 36700 \frac{\text{ft} \cdot \text{lbf}}{\text{s}} \approx \mathbf{67 \text{ hp}} \quad \text{Ans.} \end{aligned}$$

3.143 The insulated tank in Fig. P3.143 is to be filled from a high-pressure air supply. Initial conditions in the tank are $T = 20^\circ\text{C}$ and $p = 200 \text{ kPa}$. When the valve is opened, the initial mass flow rate into the tank is 0.013 kg/s . Assuming an ideal gas, estimate the initial rate of temperature rise of the air in the tank.

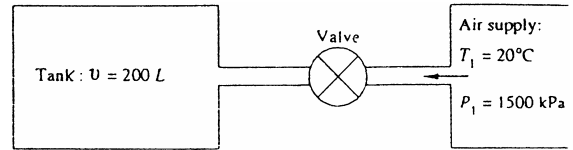

Fig. P3.143

Solution: For a CV surrounding the tank, with *unsteady* flow, the energy equation is

$$\frac{d}{dt} \left(\int e \rho d\nu \right) - \dot{m}_{\text{in}} \left(\hat{u} + \frac{p}{\rho} + \frac{V^2}{2} + gz \right) = \dot{Q} - \dot{W}_{\text{shaft}} = 0, \quad \text{neglect } V^2/2 \text{ and } gz$$

$$\text{Rewrite as } \frac{d}{dt} (\rho \nu c_v T) \approx \dot{m}_{\text{in}} c_p T_{\text{in}} = \rho \nu c_v \frac{dT}{dt} + c_v T \nu \frac{d\rho}{dt}$$

where ρ and T are the instantaneous conditions inside the tank. The CV mass flow gives

$$\frac{d}{dt} \left(\int \rho d\nu \right) - \dot{m}_{\text{in}} = 0, \quad \text{or: } \nu \frac{d\rho}{dt} = \dot{m}_{\text{in}}$$

Combine these two to eliminate $\nu(d\rho/dt)$ and use the given data for air:

$$\left. \frac{dT}{dt} \right|_{\text{tank}} = \frac{\dot{m}(c_p - c_v)T}{\rho \nu c_v} = \frac{(0.013)(1005 - 718)(293)}{\left[\frac{200000}{287(293)} \right] (0.2 \text{ m}^3)(718)} \approx 3.2 \frac{^\circ\text{C}}{\text{s}} \quad \text{Ans.}$$

3.144 The pump in Fig. P3.144 creates a 20°C water jet oriented to travel a maximum horizontal distance. System friction head losses are 6.5 m . The jet may be approximated by the trajectory of frictionless particles. What power must be delivered by the pump?

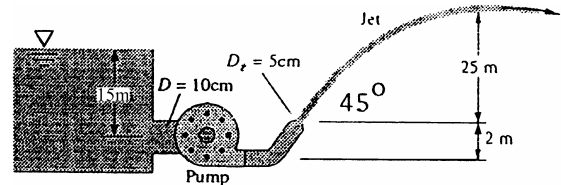

Fig. P3.144

Solution: For maximum travel, the jet must exit at $\theta = 45^\circ$, and the exit velocity must be

$$V_2 \sin \theta = \sqrt{2g\Delta z_{\text{max}}} \quad \text{or: } V_2 = \frac{[2(9.81)(25)]^{1/2}}{\sin 45^\circ} \approx 31.32 \frac{\text{m}}{\text{s}}$$

The steady flow energy equation for the piping system may then be evaluated:

$$p_1/\gamma + V_1^2/2g + z_1 = p_2/\gamma + V_2^2/2g + z_2 + h_f - h_p,$$

or: $0 + 0 + 15 = 0 + (31.32)^2/[2(9.81)] + 2 + 6.5 - h_p$, solve for $h_p \approx 43.5$ m

$$\text{Then } P_{\text{pump}} = \gamma Q h_p = (9790) \left[\frac{\pi}{4} (0.05)^2 (31.32) \right] (43.5) \approx \mathbf{26200 \text{ W}} \quad \text{Ans.}$$

3.145 The large turbine in Fig. P3.145 diverts the river flow under a dam as shown. System friction losses are $h_f = 3.5V^2/(2g)$, where V is the average velocity in the supply pipe. For what river flow rate in m^3/s will the power extracted be 25 MW? Which of the *two* possible solutions has a better “conversion efficiency”?

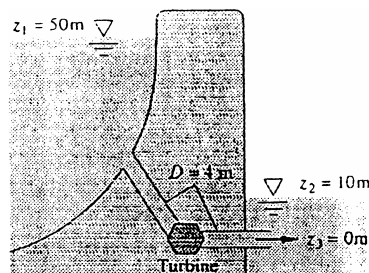

Fig. P3.145

Solution: The flow rate is the unknown, with the turbine power known:

$$\frac{p_1}{\gamma} + \frac{V_1^2}{2g} + z_1 = \frac{p_2}{\gamma} + \frac{V_2^2}{2g} + z_2 + h_f + h_{\text{turb}}, \quad \text{or: } 0 + 0 + 50 = 0 + 0 + 10 + h_f + h_{\text{turb}}$$

$$\text{where } h_f = 3.5V_{\text{pipe}}^2/(2g) \quad \text{and} \quad h_p = P_p/(\gamma Q) \quad \text{and} \quad V_{\text{pipe}} = \frac{Q}{(\pi/4)D_{\text{pipe}}^2}$$

Introduce the given numerical data (e.g. $D_{\text{pipe}} = 4$ m, $P_{\text{pump}} = 25\text{E}6$ W) and solve:

$$Q^3 - 35410Q + 2.261\text{E}6 = 0, \quad \text{with roots } Q = +76.5, +137.9, \text{ and } -214.4 \text{ m}^3/\text{s}$$

The *negative* Q is nonsense. The large Q ($=137.9$) gives large friction loss, $h_f \approx 21.5$ m. The smaller Q ($=76.5$) gives $h_f \approx 6.6$ m, about right. Select $Q_{\text{river}} \approx \mathbf{76.5 \text{ m}^3/\text{s}}$. *Ans.*

3.146 Kerosene at 20°C flows through the pump in Fig. P3.146 at $2.3 \text{ ft}^3/\text{s}$. Head losses between 1 and 2 are 8 ft, and the pump delivers 8 hp to the flow. What should the mercury-manometer reading h ft be?

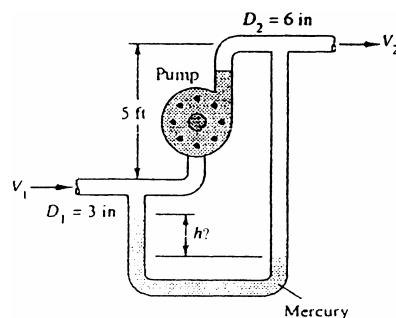

Fig. P3.146

Solution: First establish the two velocities:

$$\begin{aligned} V_1 &= \frac{Q}{A_1} = \frac{2.3 \text{ ft}^3/\text{s}}{(\pi/4)(3/12 \text{ ft})^2} \\ &= 46.9 \frac{\text{ft}}{\text{s}}; \quad V_2 = \frac{1}{4}V_1 = 11.7 \frac{\text{ft}}{\text{s}} \end{aligned}$$

For kerosene take $\rho = 804 \text{ kg/m}^3 = 1.56 \text{ slug/ft}^3$, or $\gamma_k = 1.56(32.2) = 50.2 \text{ lbf/ft}^3$. For mercury take $\gamma_m = 846 \text{ lbf/ft}^3$. Then apply a manometer analysis to determine the pressure difference between points 1 and 2:

$$p_2 - p_1 = (\gamma_m - \gamma_k)h - \gamma_k \Delta z = (846 - 50.2)h - \left(50.2 \frac{\text{lbf}}{\text{ft}^3}\right)(5 \text{ ft}) = 796h - 251 \frac{\text{lbf}}{\text{ft}^2}$$

Now apply the steady flow energy equation between points 1 and 2:

$$\frac{p_1}{\gamma_k} + \frac{V_1^2}{2g} + z_1 = \frac{p_2}{\gamma_k} + \frac{V_2^2}{2g} + z_2 + h_f - h_p, \quad \text{where } h_p = \frac{P}{\gamma_k Q} = \frac{8(550) \text{ ft} \cdot \text{lbf/s}}{(50.2)(2.3 \text{ ft}^3/\text{s})} = 38.1 \text{ ft}$$

$$\text{Thus: } \frac{p_1}{50.2} + \frac{(46.9)^2}{2(32.2)} + 0 = \frac{p_2}{50.2} + \frac{(11.7)^2}{2(32.2)} + 5 + 8 - 38.1 \text{ ft} \quad \text{Solve } p_2 - p_1 = 2866 \frac{\text{lbf}}{\text{ft}^2}$$

Now, with the pressure difference known, apply the manometer result to find h :

$$p_2 - p_1 = 2866 = 796h - 251, \quad \text{or: } h = \frac{2866 + 251 \text{ lbf/ft}^2}{796 \text{ lbf/ft}^3} = \mathbf{3.92 \text{ ft}} \quad \text{Ans.}$$

3.147 Repeat Prob. 3.49 by assuming that p_1 is unknown and using Bernoulli's equation with no losses. Compute the new bolt force for this assumption. What is the head loss between 1 and 2 for the data of Prob. 3.49?

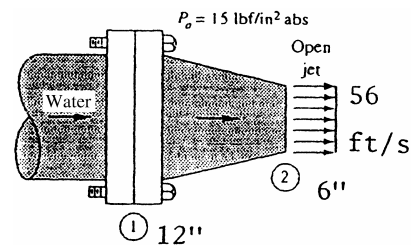

Fig. P3.49

Solution: Use Bernoulli's equation with no losses to estimate p_1 with $\Delta z = 0$:

$$\frac{p_1}{\gamma} + \frac{(14)^2}{2(32.2)} \approx \frac{15(144)}{62.4} + \frac{(56)^2}{2(32.2)}, \quad \text{solve for } p_{1,\text{ideal}} \approx \mathbf{34.8 \text{ psia}}$$

From the x -momentum CV analysis of Prob. 3.49, the bolt force is given by

$$\begin{aligned} F_{\text{bolts}} &= p_{2,\text{gage}} A_2 - \dot{m}(V_2 - V_1) \\ &= (34.8 - 15)(144) \frac{\pi}{4} (1 \text{ ft})^2 - 1.94 \left(\frac{\pi}{4} \right) (1 \text{ ft})^2 (14)(56 - 14) \approx \mathbf{1340 \text{ lbf}} \quad \text{Ans.} \end{aligned}$$

We can estimate the friction head loss in Prob. 3.49 from the steady flow energy equation, with p_1 taken to be the value of 38 psia given in that problem:

$$\frac{38(144)}{62.4} + \frac{(14)^2}{2(32.2)} = \frac{15(144)}{62.4} + \frac{(56)^2}{2(32.2)} + h_f, \quad \text{solve for } h_f \approx \mathbf{7.4 \text{ ft}} \quad \text{Ans.}$$

P3.148 Extend the siphon analysis of Ex. 3.22 as follows. Let $p_1 = 1 \text{ atm}$ and let the fluid be hot water at 60°C . Let $z_{1,2,4}$ be the same, with z_3 unknown. Find the value of z_3 for which the water might begin to vaporize.

Solution: Given $p_1 = 101350 \text{ Pa}$ and recall that $z_1 = 60 \text{ cm}$, $z_2 = -25 \text{ cm}$, and z_4 was not needed. Then note that, because of steady-flow one-dimensional continuity, from Ex. 3.22,

$$V_3 = V_2 = \sqrt{2g(z_1 - z_2)} = \sqrt{2(9.81)[0.6 - (-0.25)]} = 4.08 \text{ m/s}$$

For cavitation, p_3 should drop down to the vapor pressure of water at 60°C , which from Table A.5 is 19.92 kPa. And, from Table A.3, the density of water at 60°C is 983 kg/m^3 . Now write Bernoulli from point 1 to point 3 at the top of the siphon:

$$\begin{aligned} \frac{p_1}{\rho} + \frac{V_1^2}{2} + gz_1 &= \frac{p_3}{\rho} + \frac{V_3^2}{2} + gz_3 \\ \frac{101350}{983} + \frac{0^2}{2} + (9.81)(0.6\text{m}) &= \frac{19920 \text{ Pa}}{983 \text{ kg/m}^3} + \frac{(4.08 \text{ m/s})^2}{2} + 9.81z_3 \\ 103.1 + 0 + 5.9 &= 20.3 + 8.3 + 9.81z_3, \quad \text{Solve } z_3 \approx \frac{80.4}{9.81} = \mathbf{8.2 \text{ m}} \quad \text{Ans.} \end{aligned}$$

That's pretty high, so the writer does not think cavitation is a problem with this siphon.

3.149 A jet of alcohol strikes the vertical plate in Fig. P3.149. A force $F \approx 425$ N is required to hold the plate stationary. Assuming there are no losses in the nozzle, estimate (a) the mass flow rate of alcohol and (b) the absolute pressure at section 1.

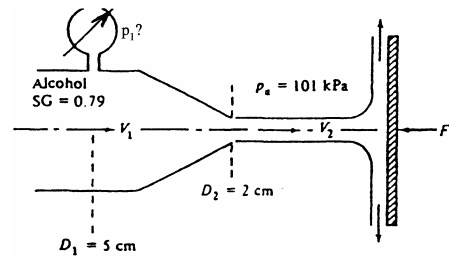

Solution: A momentum analysis of the plate (e.g. Prob. 3.40) will give

$$F = \dot{m}V_2 = \rho A_2 V_2^2 = 0.79(998) \frac{\pi}{4} (0.02)^2 V_2^2 = 425 \text{ N,}$$

$$\text{solve for } V_2 \approx 41.4 \text{ m/s}$$

$$\text{whence } \dot{m} = 0.79(998) \left(\frac{\pi}{4} \right) (0.02)^2 (41.4) \approx \mathbf{10.3 \text{ kg/s}} \quad \text{Ans. (a)}$$

We find V_1 from mass conservation and then find p_1 from Bernoulli with no losses:

$$\text{Incompressible mass conservation: } V_1 = V_2 (D_2/D_1)^2 = (41.4) \left(\frac{2}{5} \right)^2 \approx 6.63 \text{ m/s}$$

$$\text{Bernoulli, } z_1 = z_2: \quad p_1 = p_2 + \frac{1}{2} \rho (V_2^2 - V_1^2) = 101000 + \frac{0.79(998)}{2} [(41.4)^2 - (6.63)^2]$$

$$\approx \mathbf{760,000 \text{ Pa}} \quad \text{Ans. (b)}$$

3.150 An airfoil at an angle of attack α , as in Fig. P3.150, provides lift by a Bernoulli effect, because the lower surface slows the flow (high pressure) and the upper surface speeds up the flow (low pressure). If the foil is 1.5 m long and 18 m wide into the paper, and the ambient air is 5000 m standard atmosphere, estimate the total lift if the average velocities on upper and lower surfaces are 215 m/s and 185 m/s, respectively. Neglect gravity.

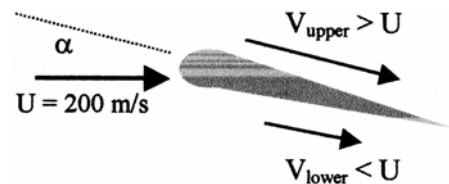

Fig. P3.150

Solution: A vertical force balance gives,

$$\begin{aligned}F_{Lift} &= (p_l - p_u)A_{planform} = \frac{1}{2}\rho(V_u^2 - V_l^2)(bL) \\ &= \frac{1}{2}(0.7361)(215^2 - 185^2)(18)(1.5) \\ &= 119,250 \text{ N} = \mathbf{119 \text{ kN}} \quad \text{Ans.}\end{aligned}$$

3.151 Water flows through a circular nozzle, exits into the air as a jet, and strikes a plate. The force required to hold the plate steady is 70 N. Assuming frictionless one-dimensional flow, estimate (a) the velocities at sections (1) and (2); (b) the mercury manometer reading h .

Solution: (a) First examine the momentum of the jet striking the plate,

$$\sum F = F = -\dot{m}_{in}u_{in} = -\rho A_2 V_2^2$$

$$70 \text{ N} = -(998) \left(\frac{\pi}{4} \right) (0.03^2) (V_2^2) \quad V_2 = \mathbf{9.96 \text{ m/s}} \quad \text{Ans. (a)}$$

$$\text{Then } V_1 = \frac{V_2 A_2}{A_1} = \frac{(9.96) \left(\frac{\pi}{4} \right) (0.03^2)}{\frac{\pi}{4} (0.1^2)} \quad \text{or } V_1 = \mathbf{0.9 \text{ m/s}} \quad \text{Ans. (a)}$$

(b) Applying Bernoulli,

$$p_2 - p_1 = \frac{1}{2} \rho (V_2^2 - V_1^2) = \frac{1}{2} (998) (9.96^2 - 0.9^2) = 49,100 \text{ Pa}$$

And from our manometry principles,

$$h = \frac{\Delta p}{\rho g} = \frac{49,100}{(133,100 - 9790)} \approx \mathbf{0.4 \text{ m}} \quad \text{Ans. (b)}$$

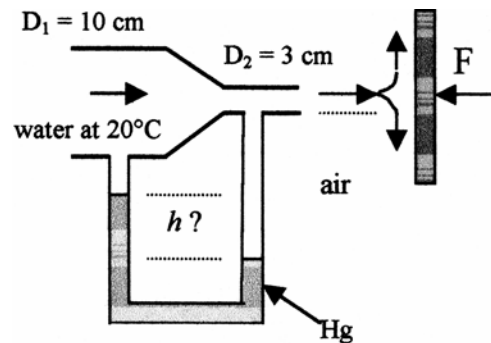

Fig. P3.151

3.152 A free liquid jet, as in Fig. P3.152, has constant ambient pressure and small losses; hence from Bernoulli's equation $z + V^2/(2g)$ is constant along the jet. For the fire nozzle in the figure, what are (a) the minimum and (b) the maximum values of θ for which the water jet will clear the corner of the building? For which case will the jet velocity be higher when it strikes the roof of the building?

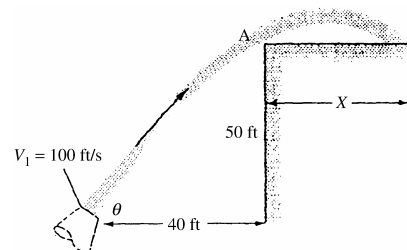

Fig. P3.152

Solution: The two extreme cases are when the jet just touches the corner A of the building. For these two cases, Bernoulli's equation requires that

$$V_1^2 + 2gz_1 = (100)^2 + 2g(0) = V_A^2 + 2gz_A = V_A^2 + 2(32.2)(50), \quad \text{or: } V_A = 82.3 \frac{\text{ft}}{\text{s}}$$

The jet moves like a frictionless particle as in elementary particle dynamics:

$$\text{Vertical motion: } z = V_1 \sin \theta t - \frac{1}{2} g t^2; \quad \text{Horizontal motion: } x = V_1 \cos \theta t$$

Eliminate "t" between these two and apply the result to point A:

$$z_A = 50 = x_A \tan \theta - \frac{g x_A^2}{2 V_1^2 \cos^2 \theta} = 40 \tan \theta - \frac{(32.2)(40)^2}{2(100)^2 \cos^2 \theta}; \quad \text{clean up and rearrange:}$$

$$\tan \theta = 1.25 + 0.0644 \sec^2 \theta, \quad \text{solve for } \theta = \mathbf{85.94^\circ} \quad \text{Ans. (a)} \quad \text{and } \mathbf{55.40^\circ} \quad \text{Ans. (b)}$$

Path (b) is shown in the figure, where the jet just grazes the corner A and goes over the top of the roof. Path (a) goes nearly straight up, to $z = 155$ ft, then falls down to pt. A.

3.153 For the container of Fig. P3.153 use Bernoulli's equation to derive a formula for the distance X where the free jet leaving horizontally will strike the floor, as a function of h and H . For what ratio h/H will X be maximum? Sketch the three trajectories for $h/H = 0.4, 0.5$, and 0.6 .

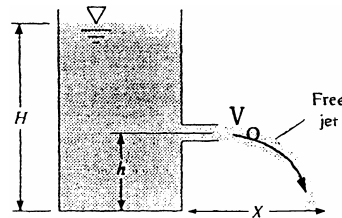

Fig. P3.153

Solution: The velocity out the hole and the time to fall from hole to ground are given by

$$V_o = \sqrt{2g(H-h)} \quad t_{\text{fall}} = \sqrt{2h/g}$$

Then the distance travelled horizontally is

$$X = V_o t_{\text{fall}} = 2\sqrt{h(H-h)} \quad \text{Ans.}$$

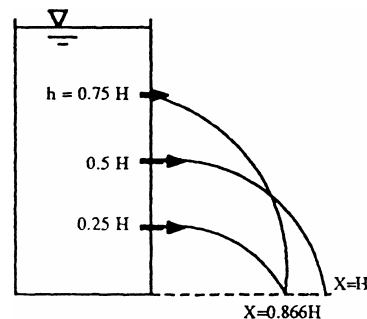

Maximum X occurs at $h = \mathbf{H/2}$, or $\mathbf{X_{max} = H}$. When $h = 0.25H$ or $0.75H$, the jet travels out to $H = 0.866H$. These three trajectories are shown in the sketch on the previous page.

P3.154 Water at 20°C , in the pressurized tank of Fig. P3.154, flows out and creates a vertical jet as shown. Assuming steady frictionless flow, determine the height H to which the jet rises.

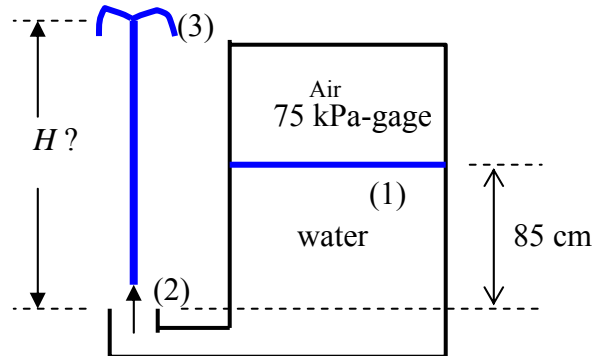

Fig. P3.154

Solution: This is a straightforward Bernoulli problem. Let the water surface be (1), the exit plane be (2), and the top of the vertical jet be (3). Let $z_2 = 0$ for convenience. If we are clever, we can bypass (2) and write Bernoulli directly from (1) to (3):

$$\frac{p_1}{\rho g} + \frac{V_1^2}{2g} + z_1 = \frac{p_3}{\rho g} + \frac{V_3^2}{2g} + z_3, \quad \text{or:}$$

$$\frac{75000}{(9.81)(998)} + 0 - 0.85\text{m} = 0 + 0 + H$$

$$\text{Solve} \quad H = 7.66\text{m} + 0.85\text{m} = \mathbf{8.51\text{m}} \quad \text{Ans.}$$

If we took an intermediate step from (1) to (2), we would find $V_2^2/2g = 8.51\text{m}$, and then going from (2) to (3) would convert the velocity head into pure elevation, because $V_3 = 0$.

3.155 Bernoulli's 1738 treatise *Hydrodynamica* contains many excellent sketches of flow patterns. One, however, redrawn here as Fig. P3.155, seems physically misleading. What is wrong with the drawing?

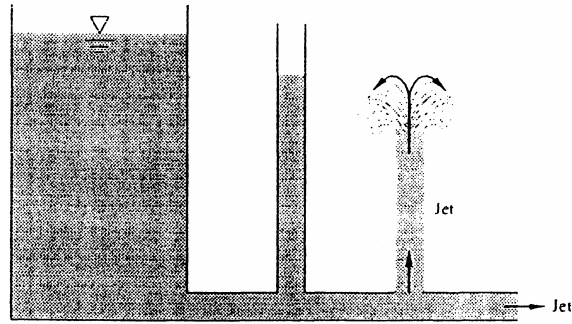

Fig. P3.155

Solution: If friction is neglected and the exit pipe is fully open, then pressure in the closed “piezometer” tube would be atmospheric and the fluid would not rise at all in the tube. The open jet coming from the hole in the tube would have $V \approx \sqrt{2gh}$ and would rise up to nearly the same height as the water in the tank.

P3.156 Extend Prob. 3.13 as follows. (a) Use Bernoulli's equation to estimate the elevation of the water surface above the exit of the bottom cone. (b) Then estimate the time required for the water surface to drop 20 cm in the cylindrical tank. If you fail to solve part (a), assume that the initial elevation above the exit is 52 cm. Neglect the possible contraction and nonuniformity of the exit jet mentioned in Ex. 3.21.

Solution: This is a “Torricelli” flow, like Ex. 3.21. Using the continuity relation in Prob. 3.tank, we found that $V \approx 3.2$ m/s. (a) Thus we know everything except $\Delta z = h_{\text{cyl}} + h_{\text{cone}}$:

$$V = \sqrt{2g \Delta z} \approx 3.2 \text{ m/s} = \sqrt{2(9.81 \text{ m/s}^2) \Delta z} \quad , \text{ solve for } \Delta z = 0.52 \text{ m} = \mathbf{52 \text{ cm}} \quad \text{Ans.(a)}$$

(b) The time Δt to drop from 52 cm to 32 cm could be obtained by numerical quadrature, or, better, we could solve for Δt analytically:

$$Q_{\text{out}} = \frac{\pi}{4} D_{\text{exit}}^2 V = -\frac{d}{dt} \left(\frac{\pi}{4} D^2 h \right) = \frac{\pi}{4} D_{\text{exit}}^2 \sqrt{2g \Delta z} = -\frac{\pi}{4} D^2 \frac{dh}{dt} = \frac{\pi}{4} D^2 \frac{d(\Delta z)}{dt}$$

$$\text{Separate \& integrate: } \int_{0.52}^{0.32} \frac{d(\Delta z)}{\sqrt{\Delta z}} = -\sqrt{2g} \left(\frac{D_{\text{exit}}}{D} \right)^2 \int_0^{\Delta t} dt$$

$$\text{Result: } \Delta t = \frac{2(\sqrt{0.52} - \sqrt{0.32})}{\sqrt{2g}} \left(\frac{D}{D_{\text{exit}}} \right)^2 = \frac{0.3108}{\sqrt{2(9.81)}} \left(\frac{0.2 \text{ cm}}{0.03 \text{ cm}} \right)^2 = \Delta t = \mathbf{3.12 \text{ s}} \quad \text{Ans.(b)}$$

3.157 The manometer fluid in Fig. P3.157 is mercury. Estimate the volume flow in the tube if the flowing fluid is (a) gasoline and (b) nitrogen, at 20°C and 1 atm.

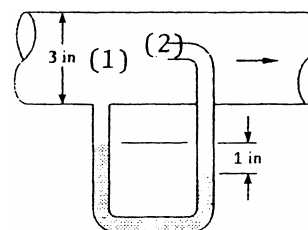

Fig. P3.157

Solution: For gasoline (a) take $\rho = 1.32$ slug/ft³. For nitrogen (b), $R \approx 297$ J/kg·°C and $\rho = p/RT = (101350)/[(297)(293)] \approx 1.165$ kg/m³ = 0.00226 slug/ft³. For mercury, take

$\rho \approx 26.34$ slug/ft³. The pitot tube (2) reads stagnation pressure, and the wall hole (1) reads static pressure. Thus Bernoulli's relation becomes, with $\Delta z = 0$,

$$p_1 + \frac{1}{2}\rho V_1^2 = p_2, \quad \text{or} \quad V_1 = \sqrt{2(p_2 - p_1)/\rho}$$

The pressure difference is found from the manometer reading, for each fluid in turn:

$$(a) \text{ Gasoline: } \Delta p = (\rho_{\text{Hg}} - \rho)g\eta = (26.34 - 1.32)(32.2)(1/12 \text{ ft}) \approx 67.1 \text{ lbf/ft}^2$$

$$V_1 = [2(67.1)/1.32]^{1/2} = 10.1 \frac{\text{ft}}{\text{s}}, \quad Q = V_1 A_1 = (10.1) \left(\frac{\pi}{4} \right) \left(\frac{3}{12} \right)^2 = \mathbf{0.495} \frac{\text{ft}^3}{\text{s}} \quad \text{Ans. (a)}$$

$$(b) \text{ N}_2: \quad \Delta p = (\rho_{\text{Hg}} - \rho)g\eta = (26.34 - 0.00226)(32.2)(1/12) \approx 70.7 \text{ lbf/ft}^2$$

$$V_1 = [2(70.7)/0.00226]^{1/2} = 250 \frac{\text{ft}}{\text{s}}, \quad Q = V_1 A_1 = (250) \left(\frac{\pi}{4} \right) \left(\frac{3}{12} \right)^2 \approx \mathbf{12.3} \frac{\text{ft}^3}{\text{s}} \quad \text{Ans. (b)}$$

3.158 In Fig. P3.158 the flowing fluid is CO₂ at 20°C. Neglect losses. If $p_1 = 170$ kPa and the manometer fluid is Meriam red oil (SG = 0.827), estimate (a) p_2 and (b) the gas flow rate in m³/h.

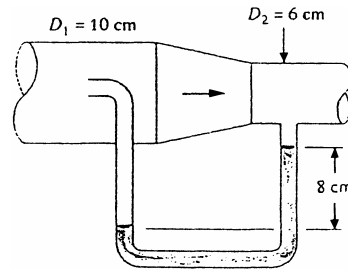

Fig. P3.158

Solution: Estimate the CO₂ density as $\rho = p/RT = (170000)/[189(293)] \approx 3.07$ kg/m³. The manometer reading gives the downstream pressure:

$$p_1 - p_2 = (\rho_{\text{oil}} - \rho_{\text{CO}_2})gh = [0.827(998) - 3.07](9.81)(0.08) \approx 645 \text{ Pa}$$

$$\text{Hence } p_2 = 170,000 - 645 \approx \mathbf{169400 \text{ Pa}} \quad \text{Ans. (a)}$$

Now use Bernoulli to find V_2 , assuming $p_1 \approx$ stagnation pressure ($V_1 = 0$):

$$p_1 + \frac{1}{2}\rho(0)^2 \approx p_2 + \frac{1}{2}\rho V_2^2,$$

$$\text{or: } V_2 = \sqrt{\frac{2(p_1 - p_2)}{\rho}} = \sqrt{\frac{2(645)}{3.07}} \approx 20.5 \frac{\text{m}}{\text{s}}$$

$$\text{Then } Q = V_2 A_2 = (20.5)(\pi/4)(0.06)^2 = 0.058 \text{ m}^3/\text{s} \approx \mathbf{209 \frac{\text{m}^3}{\text{hr}}} \quad \text{Ans. (b)}$$

P3.159 The cylindrical water tank in Fig. P3.159 is being

filled at a volume flow $Q_1 = 1.0$ gal/min, while the

water also drains from a bottom hole of diameter $d =$

6 mm. At time $t = 0$, $h = 0$. Find (a) an expression for

$h(t)$ and (b) the eventual maximum water depth h_{max} .

Assume that Bernoulli's steady-flow equation is valid.

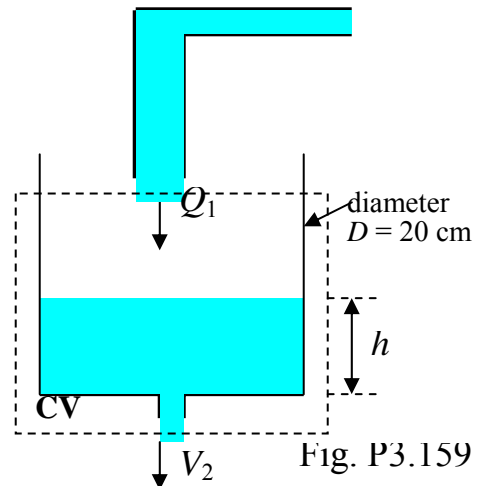

Fig. P3.159

Solution: Bernoulli predicts that $V_2 \approx \sqrt{2gh}$.

Convert $Q_1 = 6.309E-5 \text{ m}^3/\text{s}$. A control volume around the tank gives the mass balance:

$$\frac{dm}{dt} \Big|_{\text{system}} = 0 = \frac{d}{dt}(Ah) - Q_1 + A_2\sqrt{2gh} \quad , \quad \text{where } A = \frac{\pi}{4}D^2 \quad \text{and } A_2 = \frac{\pi}{4}d^2$$

Rearrange, separate the variables, and integrate:

$$\int_0^{h(t)} \frac{dh}{Q_1 - A_2\sqrt{2gh}} = \frac{1}{A} \int_0^t dt$$

(a) The integration is a bit tricky and laborious. Here is the writer's result:

$$t = \frac{2Q_1 A}{\alpha^2} \ln\left(\frac{Q_1}{Q_1 - \alpha\sqrt{h}}\right) - \frac{2A\sqrt{h}}{\alpha} \quad , \quad \text{where } \alpha = A_2\sqrt{2g} \quad \text{Ans.(a)}$$

(a) A graph of h versus t for the particular given data is as follows:

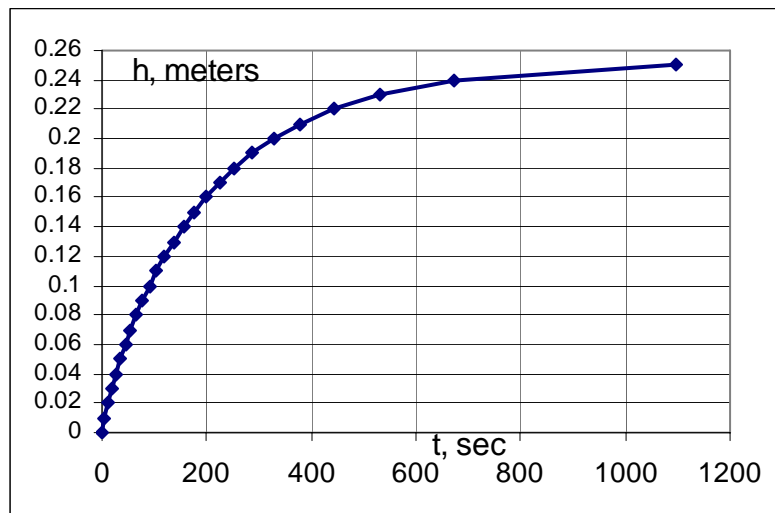

(b) The water level rises fast and then slower and is asymptotic to the value $h_{\max} = 0.254 \text{ m}$. This is when the outflow through the hole exactly equals the inflow from the pipe:

$$Q_1 = A_2\sqrt{2gh_{\max}} \quad , \quad \text{or : } 6.309E-5 \frac{\text{m}^3}{\text{s}} = \frac{\pi}{4}(0.006\text{m})^2\sqrt{2(9.81)h_{\max}}$$

Solve for $h_{\max} = \mathbf{0.254\text{m}}$ Ans.(b)

3.160 The air-cushion vehicle in Fig. P3.160 brings in sea-level standard air through a fan and discharges it at high velocity through an annular skirt of 3-cm clearance. If the vehicle weighs 50 kN, estimate (a) the required airflow rate and (b) the fan power in kW.

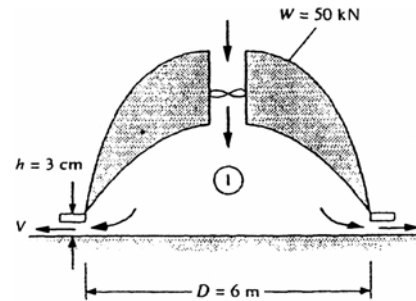

Fig. P3.160

Solution: The air inside at section 1 is nearly stagnant ($V \approx 0$) and supports the weight and also drives the flow out of the interior into the atmosphere:

$$p_1 \approx p_{01}: \quad p_{01} - p_{\text{atm}} = \frac{\text{weight}}{\text{area}} = \frac{50,000 \text{ N}}{\pi(3 \text{ m})^2} = \frac{1}{2} \rho V_{\text{exit}}^2 = \frac{1}{2} (1.205) V_{\text{exit}}^2 \approx 1768 \text{ Pa}$$

$$\text{Solve for } V_{\text{exit}} \approx 54.2 \text{ m/s, whence } Q_e = A_e V_e = \pi(6)(0.03)(54.2) = 30.6 \frac{\text{m}^3}{\text{s}}$$

Then the power required by the fan is $P = Q_e \Delta p = (30.6)(1768) \approx \mathbf{54000 \text{ W}}$ Ans.

3.161 A necked-down section in a pipe flow, called a *venturi*, develops a low throat pressure which can aspirate fluid upward from a reservoir, as in Fig. P3.161. Using Bernoulli's equation with no losses, derive an expression for the velocity V_1 which is just sufficient to bring reservoir fluid into the throat.

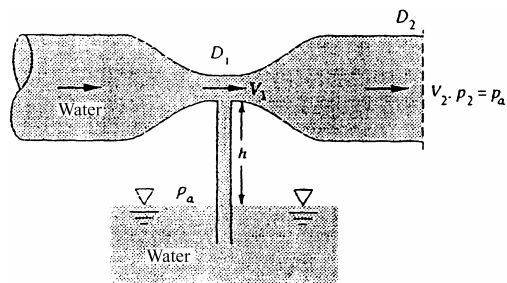

Fig. P3.161

Solution: Water will begin to aspirate into the throat when $p_a - p_1 = \rho gh$. Hence:

$$\text{Volume flow: } V_1 = V_2 (D_2/D_1)^2; \quad \text{Bernoulli } (\Delta z = 0): \quad p_1 + \frac{1}{2} \rho V_1^2 \approx p_{\text{atm}} + \frac{1}{2} \rho V_2^2$$

$$\text{Solve for } p_a - p_1 = \frac{\rho}{2}(\alpha^4 - 1)V_2^2 \geq \rho gh, \quad \alpha = \frac{D_2}{D_1}, \quad \text{or: } V_2 \geq \sqrt{\frac{2gh}{\alpha^4 - 1}} \quad \text{Ans.}$$

$$\text{Similarly, } V_{1,\min} = \alpha^2 V_{2,\min} = \sqrt{\frac{2gh}{1 - (D_1/D_2)^4}} \quad \text{Ans.}$$

3.162 Suppose you are designing a 3 × 6-ft air-hockey table, with 1/16-inch-diameter holes spaced every inch in a rectangular pattern (2592 holes total), the required jet speed from each hole is 50 ft/s. You must select an appropriate blower. Estimate the volumetric flow rate (in ft³/min) and pressure rise (in psi) required. *Hint:* Assume the air is stagnant in the large manifold under the table surface, and neglect frictional losses.

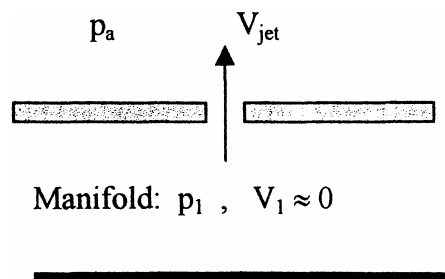

Solution: Assume an air density of about sea-level, **0.00235 slug/ft³**. Apply Bernoulli's equation through any single hole, as in the figure:

$$p_1 + \frac{\rho}{2}V_1^2 = p_a + \frac{\rho}{2}V_{jet}^2, \quad \text{or:}$$

$$\Delta p_{required} = p_1 - p_a = \frac{\rho}{2}V_{jet}^2 = \frac{0.00235}{2}(50)^2 = 2.94 \frac{\text{lbf}}{\text{ft}^2} = \mathbf{0.0204 \frac{\text{lbf}}{\text{in}^2}} \quad \text{Ans.}$$

The total volume flow required is

$$\begin{aligned} Q &= VA_{1-hole}(\# \text{ of holes}) = \left(50 \frac{\text{ft}}{\text{s}}\right) \frac{\pi}{4} \left(\frac{1/16}{12} \text{ ft}\right)^2 (2592 \text{ holes}) \\ &= 2.76 \frac{\text{ft}^3}{\text{s}} = \mathbf{166 \frac{\text{ft}^3}{\text{min}}} \quad \text{Ans.} \end{aligned}$$

It wasn't asked, but the power required would be $P = Q\Delta p = (2.76 \text{ ft}^3/\text{s})(2.94 \text{ lbf/ft}^2) = 8.1 \text{ ft}\cdot\text{lbf/s}$, or about 11 watts.

3.163 The liquid in Fig. P3.163 is kerosine at 20°C. Estimate the flow rate from the tank for (a) no losses and (b) pipe losses $hf \approx 4.5V^2/(2g)$.

Solution: For kerosine let $\gamma = 50.3$ lbf/ft³. Let (1) be the surface and (2) the exit jet:

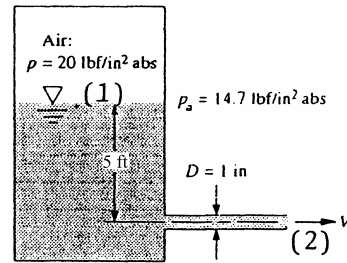

Fig. P3.163

$$\frac{p_1}{\gamma} + \frac{V_1^2}{2g} + z_1 = \frac{p_2}{\gamma} + \frac{V_2^2}{2g} + z_2 + h_f, \quad \text{with } z_2 = 0 \text{ and } V_1 \approx 0, \quad h_f = K \frac{V_2^2}{2g}$$

$$\text{Solve for } \frac{V_2^2}{2g}(1+K) = z_1 + \frac{p_1 - p_2}{\gamma} = 5 + \frac{(20 - 14.7)(144)}{50.3} \approx 20.2 \text{ ft}$$

We are asked to compute two cases (a) no losses; and (b) substantial losses, $K \approx 4.5$:

$$\text{(a) } K = 0: \quad V_2 = \left[\frac{2(32.2)(20.2)}{1+0} \right]^{1/2} = 36.0 \frac{\text{ft}}{\text{s}}, \quad Q = 36.0 \frac{\pi}{4} \left(\frac{1}{12} \right)^2 \approx \mathbf{0.197} \frac{\text{ft}^3}{\text{s}} \quad \text{Ans. (a)}$$

$$\text{(b) } K = 4.5: \quad V_2 = \sqrt{\frac{2(32.2)(23.0)}{1+4.5}} = 16.4 \frac{\text{ft}}{\text{s}}, \quad Q = 16.4 \frac{\pi}{4} \left(\frac{1}{12} \right)^2 \approx \mathbf{0.089} \frac{\text{ft}^3}{\text{s}} \quad \text{Ans. (b)}$$

3.164 An open water jet exits from a nozzle into sea-level air, as shown, and strikes a stagnation tube. If the centerline pressure at section (1) is 110 kPa and losses are neglected, estimate (a) the mass flow in kg/s; and (b) the height H of the fluid in the tube.

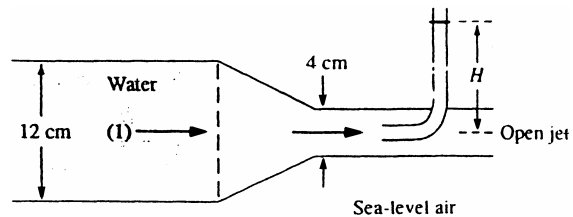

Fig. P3.164

Solution: Writing Bernoulli and continuity between pipe and jet yields jet velocity:

$$p_1 - p_a = \frac{\rho}{2} V_{jet}^2 \left[1 - \left(\frac{D_{jet}}{D_1} \right)^4 \right] = 110000 - 101350 = \frac{998}{2} V_{jet}^2 \left[1 - \left(\frac{4}{12} \right)^4 \right],$$

$$\text{solve } V_{jet} = \mathbf{4.19} \frac{\text{m}}{\text{s}}$$

$$\text{Then the mass flow is } \dot{m} = \rho A_{jet} V_{jet} = 998 \frac{\pi}{4} (0.04)^2 (4.19) = \mathbf{5.25} \frac{\text{kg}}{\text{s}} \quad \text{Ans. (a)}$$

(b) The water in the stagnation tube will rise above the jet surface by an amount equal to the stagnation pressure head of the jet:

$$\mathbf{H} = R_{jet} + \frac{V_{jet}^2}{2g} = 0.02 \text{ m} + \frac{(4.19)^2}{2(9.81)} = 0.02 + 0.89 = \mathbf{0.91 \text{ m}} \quad \text{Ans. (b)}$$

3.165 A *venturi meter*, shown in Fig. P3.165, is a carefully designed constriction whose pressure difference is a measure of the flow rate in a pipe. Using Bernoulli's equation for steady incompressible flow with no losses, show that the flow rate Q is related to the manometer reading h by

$$Q = \frac{A_2}{\sqrt{1 - (D_2/D_1)^4}} \sqrt{\frac{2gh(\rho_M - \rho)}{\rho}}$$

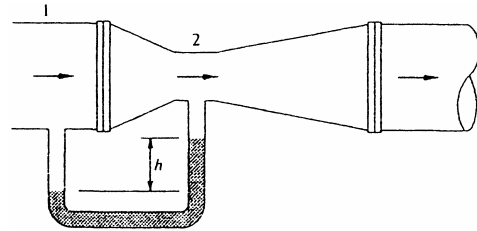

Fig. P3.165

where ρ_M is the density of the manometer fluid.

Solution: First establish that the manometer reads the pressure difference between 1 and 2:

$$p_1 - p_2 = (\rho_M - \rho)gh \quad (1)$$

Then write incompressible Bernoulli's equation and continuity between (1) and (2):

$$(\Delta z = 0): \quad \frac{p_1}{\rho} + \frac{V_1^2}{2} \approx \frac{p_2}{\rho} + \frac{V_2^2}{2} \quad \text{and} \quad V_2 = V_1(D_1/D_2)^2, \quad Q = A_1V_1 = A_2V_2$$

$$\text{Eliminate } V_2 \text{ and } (p_1 - p_2) \text{ from (1) above:} \quad \mathbf{Q} = \frac{A_2 \sqrt{2gh(\rho_M - \rho)/\rho}}{\sqrt{1 - (D_2/D_1)^4}} \quad \text{Ans.}$$

3.166 A wind tunnel draws in sea-level standard air from the room and accelerates it into a 1-m by 1-m test section. A pressure transducer in the test section wall measures $\Delta p = 45 \text{ mm water}$ between inside and outside. Estimate (a) the test section velocity in mi/hr; and (b) the absolute pressure at the nose of the model.

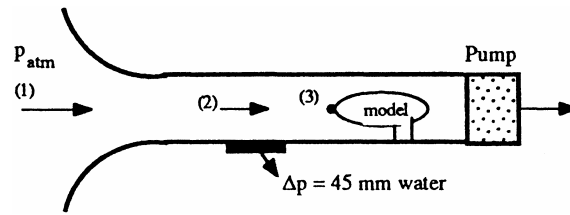

Solution: (a) First apply Bernoulli from the atmosphere (1) to (2), using the known Δp :

$$p_a - p_2 = 45 \text{ mm H}_2\text{O} = 441 \text{ Pa}; \quad \rho_a = 1.225 \text{ kg/m}^3; \quad p_1 + \frac{\rho}{2} V_1^2 \approx p_2 + \frac{\rho}{2} V_2^2$$

Since $V_1 \approx 0$ and $p_1 = p_a$, we obtain $V_2 = \sqrt{\frac{2\Delta p}{\rho}} = \sqrt{\frac{2(441)}{1.225}} = 26.8 \frac{\text{m}}{\text{s}} = \mathbf{60 \frac{mi}{hr}}$ *Ans. (a)*

(b) Bernoulli from 1 to 3: both velocities = 0, so $p_{nose} = p_a \approx \mathbf{101350 \text{ Pa}}$. *Ans. (b)*

3.167 In Fig. P3.167 the fluid is gasoline at 20°C at a weight flux of 120 N/s. Assuming no losses, estimate the gage pressure at section 1.

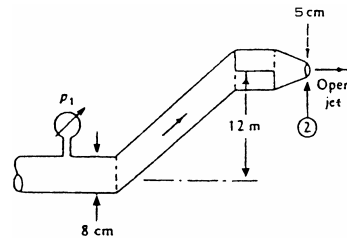

Fig. P3.167

Solution: For gasoline, $\rho = 680 \text{ kg/m}^3$. Compute the velocities from the given flow rate:

$$Q = \frac{\dot{W}}{\rho g} = \frac{120 \text{ N/s}}{680(9.81)} = 0.018 \frac{\text{m}^3}{\text{s}},$$

$$V_1 = \frac{0.018}{\pi(0.04)^2} = 3.58 \frac{\text{m}}{\text{s}}; \quad V_2 = \frac{0.018}{\pi(0.025)^2} = 9.16 \frac{\text{m}}{\text{s}}$$

Now apply Bernoulli between 1 and 2:

$$\frac{p_1}{\rho} + \frac{V_1^2}{2} + gz_1 \approx \frac{p_2}{\rho} + \frac{V_2^2}{2} + gz_2, \quad \text{or:} \quad \frac{p_1}{\rho} + \frac{(3.58)^2}{2} + 0 \approx \frac{0(\text{gage})}{680} + \frac{(9.16)^2}{2} + 9.81(12)$$

Solve for $p_1 \approx \mathbf{104,000 \text{ Pa (gage)}}$ *Ans.*

3.168 In Fig. P3.168 both fluids are at 20°C. If $V_1 = 1.7$ ft/s and losses are neglected, what should the manometer reading h ft be?

Solution: By continuity, establish V_2 :

$$V_2 = V_1(D_1/D_2)^2 = 1.7(3/1)^2 = 15.3 \frac{\text{ft}}{\text{s}}$$

Now apply Bernoulli between 1 and 2 to establish the pressure at section 2:

$$p_1 + \frac{\rho}{2} V_1^2 + \rho g z_1 = p_2 + \frac{\rho}{2} V_2^2 + \rho g z_2,$$

$$\text{or: } p_1 + (1.94/2)(1.7)^2 + 0 \approx 0 + (1.94/2)(15.3)^2 + (62.4)(10), \quad p_1 = 848 \text{ psf}$$

This is gage pressure. Now the manometer *reads* gage pressure, so

$$p_1 - p_a = 848 \frac{\text{lbf}}{\text{ft}^2} = (\rho_{\text{merc}} - \rho_{\text{water}})gh = (846 - 62.4)h, \quad \text{solve for } h \approx \mathbf{1.08 \text{ ft}} \quad \text{Ans.}$$

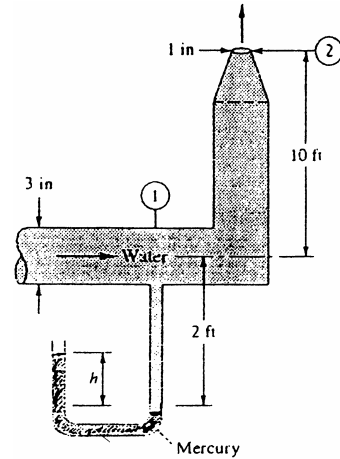

Fig. P3.168

P3.169 Extend the siphon analysis of Ex. 3.22 to account for friction in the tube, as follows. Let the friction head loss in the tube be correlated as $5.4(V_{\text{tube}})^2/(2g)$, which approximates turbulent flow in a 2-m-long tube. Calculate the exit velocity in m/s and the volume flow rate in cm^3/s . We repeat the sketch of Ex. 3.22 for convenience.

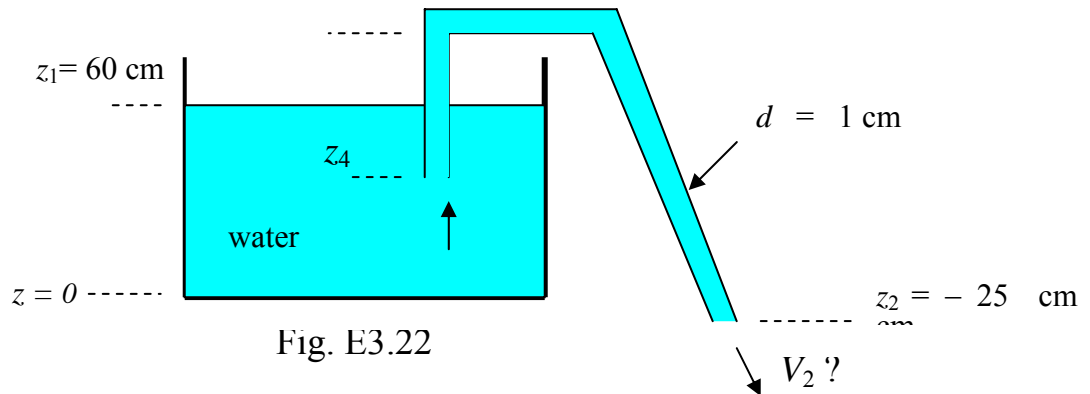

Fig. E3.22

Solution: Write the steady flow energy equation from the water surface (1) to the exit (2):

$$\frac{p_1}{\rho g} + \frac{V_1^2}{2g} + z_1 = \frac{p_2}{\rho g} + \frac{V_2^2}{2g} + z_2 + h_f, \quad \text{where } h_f = 5.4 \frac{V_{\text{tube}}^2}{2g}$$

The tube area is constant, hence $V_{\text{tube}} = V_2$. Also, $p_1 = p_2$ and $V_1 \approx 0$. Thus we obtain

$$z_1 - z_2 = 0.6\text{m} - (-0.25\text{m}) = 0.85\text{m} = \frac{V_2^2}{2g}(1+5.4)$$

$$\text{Solve } V_2 = \sqrt{\frac{2(9.81\text{m/s}^2)(0.85\text{m})}{1+5.4}} = \mathbf{1.61 \frac{\text{m}}{\text{s}}} \quad \text{Ans.}$$

$$\text{and } Q = V_2 A_2 = (1.61 \frac{\text{m}}{\text{s}}) \frac{\pi}{4} (0.01\text{m})^2 = 0.000167 \frac{\text{m}^3}{\text{s}} = \mathbf{127 \frac{\text{cm}^3}{\text{s}}} \quad \text{Ans.}$$

Tube friction has reduced the flow rate by more than 60%.

3.170 If losses are neglected in Fig. P3.170, for what water level h will the flow begin to form vapor cavities at the throat of the nozzle?

Solution: Applying Bernoulli from (a) to (2) gives Torricelli's relation: $V_2 = \sqrt{2gh}$. Also,

$$V_1 = V_2 (D_2/D_1)^2 = V_2 (8/5)^2 = 2.56V_2$$

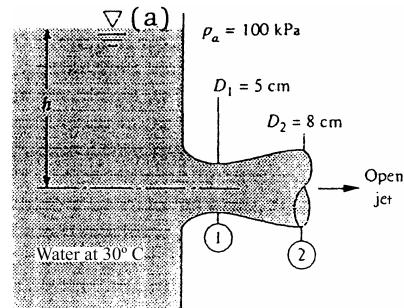

Fig. P3.170

Vapor bubbles form when p_1 reaches the vapor pressure at 30°C , $p_{\text{vap}} \approx 4242 \text{ Pa}$ (from Table A.5), while $\rho \approx 996 \text{ kg/m}^3$ at 30°C (Table A.1). Apply Bernoulli between 1 and 2:

$$\frac{p_1}{\rho} + \frac{V_1^2}{2} + gz_1 \approx \frac{p_2}{\rho} + \frac{V_2^2}{2} + gz_2, \quad \text{or: } \frac{4242}{996} + \frac{(2.56V_2)^2}{2} + 0 \approx \frac{100000}{996} + \frac{V_2^2}{2} + 0$$

$$\text{Solve for } V_2^2 = 34.62 = 2gh, \quad \text{or } h = 34.62/[2(9.81)] \approx \mathbf{1.76 \text{ m}} \quad \text{Ans.}$$

3.171 For the 40°C water flow in Fig. P3.171, estimate the volume flow through the pipe, assuming no losses; then explain what is wrong with this seemingly innocent question. If the actual flow rate is $Q = 40 \text{ m}^3/\text{h}$, compute (a) the head loss in ft and (b) the constriction diameter D which causes cavitation, assuming that the throat divides the head loss equally and that changing the constriction causes no additional losses.

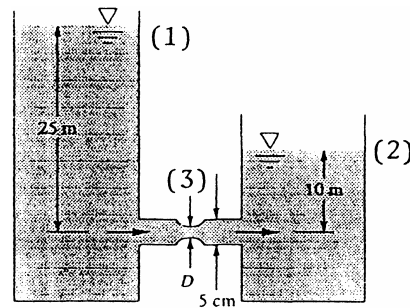

Fig. P3.171

Solution: Apply Bernoulli between 1 and 2:

$$\frac{p_1}{\gamma} + \frac{V_1^2}{2g} + z_1 \approx \frac{p_2}{\gamma} + \frac{V_2^2}{2g} + z_2, \quad \text{or: } 0 + 0 + 25 \approx 0 + 0 + 10, \quad \text{or: } \mathbf{25 = 10 ??}$$

This is madness, what happened? The answer is that this problem cannot be free of losses. There is a 15-m loss as the pipe-exit jet dissipates into the downstream reservoir. *Ans.* (a) Examining analysis (a) shows that the head loss is 15 meters. For water at 40°C, the vapor pressure is 7375 Pa (Table A.5), and the density is 992 kg/m³ (Table A.1). Now write Bernoulli between (1) and (3), assuming a head loss of 15/2 = 7.5 m:

$$\frac{p_1}{\rho} + \frac{V_1^2}{2} + gz_1 = \frac{p_3}{\rho} + \frac{V_3^2}{2} + gz_3 + \frac{g}{2} h_{f,\text{total}}, \quad \text{where } V_3 = \frac{Q}{A_3} = \frac{40/3600}{(\pi/4)D^2} = \frac{0.0141}{D^2}$$

$$\text{Thus } \frac{101350}{992} + 0 + 9.81(25) \approx \frac{7375}{992} + \frac{(0.0141/D^2)^2}{2} + 0 + (9.81)(7.5)$$

$$\text{Solve for } D^4 \approx 3.75\text{E-}7 \text{ m}^4, \quad \text{or } D \approx \mathbf{0.0248 \text{ m} \approx 25 \text{ mm}} \quad \text{Ans.}$$

This corresponds to $V_3 \approx 23 \text{ m/s}$.

3.172 The 35°C water flow of Fig. P3.172 discharges to sea-level standard atmosphere. Neglecting losses, for what nozzle diameter D will cavitation begin to occur? To avoid cavitation, should you increase or decrease D from this critical value?

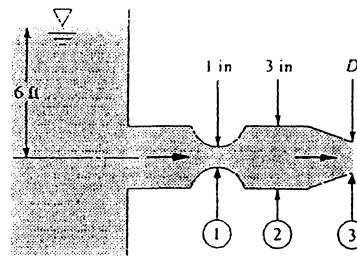

Fig. P3.172

Solution: At 35°C the vapor pressure of water is approximately 5600 Pa (Table A.5). Bernoulli from the surface to point 3 gives the Torricelli result $V_3 = \sqrt{2gh} = \sqrt{2(32.2)(6)} \approx 19.66$ ft/s. We can ignore section 2 and write Bernoulli from (1) to (3), with $p_1 = p_{\text{vap}}$ and $\Delta z = 0$:

$$\frac{p_1}{\rho} + \frac{V_1^2}{2} \approx \frac{p_2}{\rho} + \frac{V_2^2}{2}, \quad \text{or:} \quad \frac{117}{1.93} + \frac{V_1^2}{2} \approx \frac{2116}{1.93} + \frac{V_3^2}{2},$$

$$\text{but also } V_1 = V_3 \left(\frac{D}{1/12} \right)^2$$

Eliminate V_1 and introduce $V_3 = 19.66 \frac{\text{ft}}{\text{s}}$ to obtain $D^4 = 3.07\text{E-}4$, $D \approx 0.132$ ft *Ans.*

To avoid cavitation, we would keep $D < 0.132$ ft, which will keep $p_1 > p_{\text{vapor}}$.

3.173 The horizontal wye fitting in Fig. P3.173 splits the 20°C water flow rate equally, if $Q_1 = 5 \text{ ft}^3/\text{s}$ and $p_1 = 25 \text{ lbf/in}^2$ (gage) and losses are neglected, estimate (a) p_2 , (b) p_3 , and (c) the vector force required to keep the wye in place.

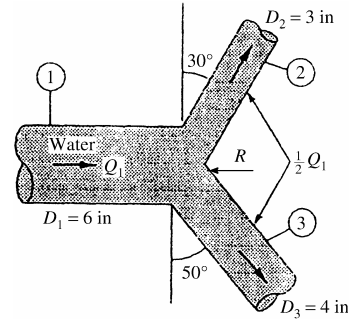

Fig. P3.173

$$V_1 = \frac{Q}{A_1} = \frac{5.0}{(\pi/4)(6/12)^2} = 25.46 \frac{\text{ft}}{\text{s}}; \quad V_2 = \frac{2.5}{(\pi/4)(3/12)^2} = 50.93 \frac{\text{ft}}{\text{s}}, \quad V_3 = 28.65 \frac{\text{ft}}{\text{s}}$$

Then apply Bernoulli from 1 to 2 and then again from 1 to 3, assuming $\Delta z \approx 0$:

$$p_2 = p_1 + \frac{\rho}{2}(V_1^2 - V_2^2) = 25(144) + \frac{1.94}{2}[(25.46)^2 - (50.93)^2] \approx \mathbf{1713 \text{ psfg}} \quad \text{Ans. (a)}$$

$$p_3 = p_1 + \frac{\rho}{2}(V_1^2 - V_3^2) = 25(144) + \frac{1.94}{2}[(25.46)^2 - (28.65)^2] \approx \mathbf{3433 \text{ psfg}} \quad \text{Ans. (b)}$$

(c) to compute the support force \mathbf{R} (see figure above), put a CV around the entire wye:

$$\begin{aligned} \sum F_x &= R_x + p_1 A_1 - p_2 A_2 \sin 30^\circ - p_3 A_3 \sin 50^\circ = \rho Q_2 V_2 \sin 30^\circ + \rho Q_3 V_3 \sin 50^\circ - \rho Q_1 V_1 \\ &= R_x + 707 - 42 - 229 = 124 + 106 - 247, \quad \text{or: } R_x = \mathbf{-453 \text{ lbf}} \quad (\text{to left}) \quad \text{Ans. (c)} \end{aligned}$$

$$\begin{aligned} \sum F_y &= R_y - p_2 A_2 \cos 30^\circ + p_3 A_3 \cos 50^\circ = \rho Q_2 V_2 \cos 30^\circ + \rho Q_3 (-V_3) \cos 50^\circ \\ &= R_y - 73 + 193 = 214 - 89, \quad \text{or: } R_y \approx \mathbf{+5 \text{ lbf}} \quad (\text{up}) \quad \text{Ans. (c)} \end{aligned}$$

3.174 In Fig. P3.174 the piston drives water at 20°C. Neglecting losses, estimate the exit velocity V_2 ft/s. If D_2 is further constricted, what is the maximum possible value of V_2 ?

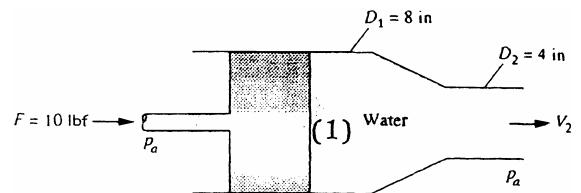

Fig. P3.174

Solution: Find p_1 from a freebody of the piston:

$$\sum F_x = F + p_a A_1 - p_1 A_1, \quad \text{or: } p_1 - p_a = \frac{10.0 \text{ lbf}}{(\pi/4)(8/12)^2} \approx 28.65 \frac{\text{lbf}}{\text{ft}^2}$$

Now apply continuity and Bernoulli from 1 to 2:

$$V_1 A_1 = V_2 A_2, \quad \text{or} \quad V_1 = \frac{1}{4} V_2; \quad \frac{p_1}{\rho} + \frac{V_1^2}{2} \approx \frac{p_a}{\rho} + \frac{V_2^2}{2}$$

Introduce $p_1 = p_a$ and substitute for V_1 to obtain $V_2^2 = \frac{2(28.65)}{1.94(1 - 1/16)}$,

$$V_2 = 5.61 \frac{\text{ft}}{\text{s}} \quad \text{Ans.}$$

If we reduce section 2 to a pinhole, V_2 will drop off slowly until V_1 vanishes:

Severely constricted section 2: $V_2 = \sqrt{\frac{2(28.65)}{1.94(1 - 0)}} \approx 5.43 \frac{\text{ft}}{\text{s}} \quad \text{Ans.}$

3.175 If the approach velocity is not too high, a hump in the bottom of a water channel causes a dip Δh in the water level, which can serve as a flow measurement. If, as shown in Fig. P3.175, $\Delta h = 10$ cm when the bump is 30 cm high, what is the volume flow Q per unit width, assuming no losses? In general, is Δh proportional to Q ?

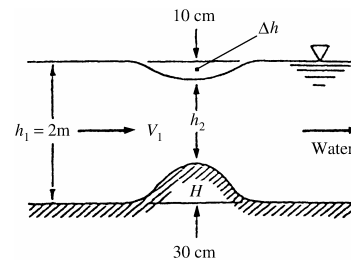

Fig. P3.175

Solution: Apply continuity and Bernoulli between 1 and 2:

$$V_1 h_1 = V_2 h_2; \quad \frac{V_1^2}{2g} + h_1 \approx \frac{V_2^2}{2g} + h_2 + H, \quad \text{solve} \quad V_1^2 \approx \frac{2g\Delta h}{(h_1^2/h_2^2) - 1} \quad \text{Ans.}$$

We see that Δh is proportional to the square of V_1 (or Q), not the first power. For the given numerical data, we may compute the approach velocity:

$$h_2 = 2.0 - 0.3 - 0.1 = 1.6 \text{ m}; \quad V_1 = \sqrt{\frac{2(9.81)(0.1)}{[(2.0/1.6)^2 - 1]}} = 1.87 \frac{\text{m}}{\text{s}}$$

whence $Q_1 = V_1 h_1 = (1.87)(2.0) \approx 3.74 \frac{\text{m}^3}{\text{s} \cdot \text{m}} \quad \text{Ans.}$

3.176 In the spillway flow of Fig. P3.176, the flow is assumed uniform and hydrostatic at sections 1 and 2. If losses are neglected, compute (a) V_2 and (b) the force per unit width of the water on the spillway.

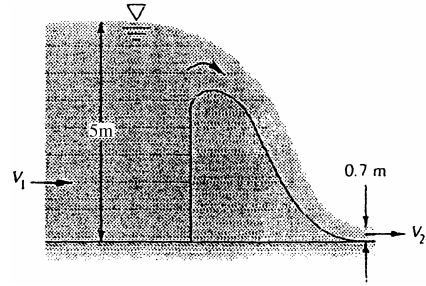

Fig. P3.176

Solution: For mass conservation,

$$V_2 = V_1 h_1 / h_2 = \frac{5.0}{0.7} V_1 = 7.14 V_1$$

(a) Now apply Bernoulli from 1 to 2:

$$\frac{p_1}{\gamma} + \frac{V_1^2}{2g} + h_1 \approx \frac{p_2}{\gamma} + \frac{V_2^2}{2g} + h_2; \quad \text{or:} \quad 0 + \frac{V_1^2}{2g} + 5.0 \approx 0 + \frac{(7.14V_1)^2}{2g} + 0.7$$

$$\text{Solve for } V_1^2 = \frac{2(9.81)(5.0 - 0.7)}{[(7.14)^2 - 1]}, \quad \text{or } V_1 = \mathbf{1.30 \frac{m}{s}}, \quad V_2 = 7.14 V_1 = \mathbf{9.28 \frac{m}{s}} \quad \text{Ans. (a)}$$

(b) To find the force on the spillway ($F \leftarrow$), put a CV around sections 1 and 2 to obtain

$$\sum F_x = -F + \frac{\gamma}{2} h_1^2 - \frac{\gamma}{2} h_2^2 = \dot{m}(V_2 - V_1), \quad \text{or, using the given data,}$$

$$F = \frac{1}{2}(9790)[(5.0)^2 - (0.7)^2] - 998[(1.30)(5.0)](9.28 - 1.30) \approx \mathbf{68300 \frac{N}{m}} \quad \text{Ans. (b)}$$

3.177 For the water-channel flow of Fig. P3.177, $h_1 = 1.5$ m, $H = 4$ m, and $V_1 = 3$ m/s. Neglecting losses and assuming uniform flow at sections 1 and 2, find the downstream depth h_2 , and show that *two* realistic solutions are possible.

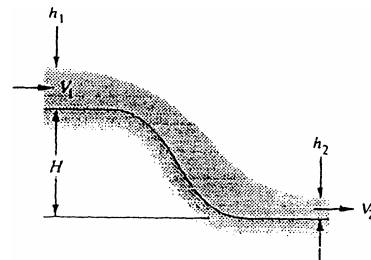

Fig. P3.177

Solution: Combine continuity and Bernoulli between 1 and 2:

$$V_2 = V_1 \frac{h_1}{h_2} = \frac{3(1.5)}{h_2}; \quad \frac{V_1^2}{2g} + h_1 + H \approx \frac{V_2^2}{2g} + h_2 = \frac{V_1^2}{2(9.81)} + 1.5 + 4 \approx \frac{(4.5/h_2)^2}{2(9.81)} + h_2$$

Combine into a cubic equation: $h_2^3 - 5.959 h_2^2 + 1.032 = 0$. The three roots are:

$$h_2 = -0.403 \text{ m (impossible); } h_2 = +5.93 \text{ m (subcritical);}$$

$$h_2 = +0.432 \text{ m (supercritical) } \textit{Ans.}$$

3.178 For the water channel flow of Fig. P3.178, $h_1 = 0.45$ ft, $H = 2.2$ ft, and $V_1 = 16$ ft/s. Neglecting losses and assuming uniform flow at sections 1 and 2, find the downstream depth h_2 . Show that *two* realistic solutions are possible.

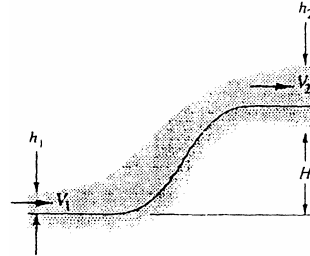

Fig. P3.178

Solution: The analysis is quite similar to Prob. 3.177 - continuity + Bernoulli:

$$V_2 = V_1 \frac{h_1}{h_2} = \frac{16(0.45)}{h_2}; \quad \frac{V_1^2}{2g} + h_1 = \frac{V_2^2}{2g} + h_2 + H = \frac{V_1^2}{2(32.2)} + 0.45 = \frac{(7.2/h_2)^2}{2(32.2)} + h_2 + 2.2$$

Combine into a cubic equation: $h_2^3 - 2.225 h_2^2 + 0.805 = 0$. The three roots are:

$$h_2 = -0.540 \text{ ft (impossible); } h_2 = +2.03 \text{ ft (subcritical);}$$

$$h_2 = +0.735 \text{ ft (supercritical) } \textit{Ans.}$$

3.179 A cylindrical tank of diameter D contains liquid to an initial height h_0 . At time $t = 0$ a small stopper of diameter d is removed from the bottom. Using Bernoulli's equation with no losses, derive (a) a differential equation for the free-surface height $h(t)$ during draining and (b) an expression for the time t_0 to drain the entire tank.

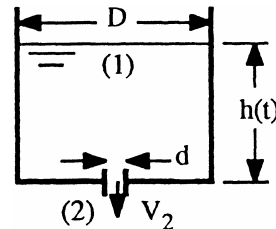

Solution: Write continuity and the unsteady Bernoulli relation from 1 to 2:

$$\int_1^2 \frac{\partial V}{\partial t} ds + \frac{p_2}{\rho} + \frac{V_2^2}{2} + gz_2 = \frac{p_1}{\rho} + \frac{V_1^2}{2} + gz_1; \quad \text{Continuity: } V_2 = V_1 \frac{A_1}{A_2} = V_1 \left(\frac{D}{d} \right)^2$$

The integral term $\int \frac{\partial V}{\partial t} ds \approx \frac{dV_1}{dt} h$ is very small and will be neglected, and $p_1 = p_2$. Then

$V_1 \approx \left[\frac{2gh}{\alpha - 1} \right]^{1/2}$, where $\alpha = (D/d)^4$; but also $V_1 = -\frac{dh}{dt}$, separate and integrate:

$$\int_{h_0}^h \frac{dh}{h^{1/2}} = - \left[\frac{2g}{\alpha - 1} \right]^{1/2} \int_0^t dt, \quad \text{or: } \mathbf{h} = \left[\mathbf{h_0^{1/2}} - \left\{ \frac{\mathbf{g}}{2(\alpha - 1)} \right\}^{1/2} \mathbf{t} \right]^2, \quad \alpha = \left(\frac{D}{d} \right)^4 \quad \text{Ans. (a)}$$

(b) the tank is empty when $h = 0$ in (a) above, or $\mathbf{t_{final}} = [2(\alpha - 1)g/h_0]^{1/2}$. *Ans. (b)*

3.180 The large tank of incompressible liquid in Fig. P3.180 is at rest when, at $t = 0$, the valve is opened to the atmosphere. Assuming $h \approx \text{constant}$ (negligible velocities and accelerations in the tank), use the unsteady frictionless Bernoulli equation to derive and solve a differential equation for $V(t)$ in the pipe.

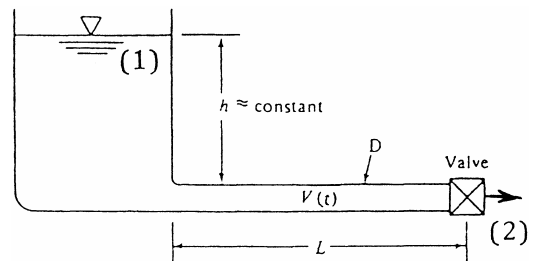

Fig. P3.180

Solution: Write unsteady Bernoulli from 1 to 2:

$$\int_1^2 \frac{\partial V}{\partial t} ds + \frac{V_2^2}{2} + gz_2 \approx \frac{V_1^2}{2} + gz_1, \quad \text{where } p_1 = p_2, \quad V_1 \approx 0, \quad z_2 \approx 0, \quad \text{and } z_1 = h = \text{const}$$

The integral approximately equals $\frac{dV}{dt} L$, so the diff. eqn. is $2L \frac{dV}{dt} + V^2 = 2gh$

This first-order ordinary differential equation has an exact solution for $V = 0$ at $t = 0$:

$$\mathbf{V} = \mathbf{V_{final}} \mathbf{\tanh} \left(\frac{\mathbf{V_{final}} \mathbf{t}}{2\mathbf{L}} \right), \quad \text{where } \mathbf{V_{final}} = \sqrt{2\mathbf{gh}} \quad \text{Ans.}$$

3.181 Modify Prob. 3.180 as follows. Let the top of the tank be enclosed and under constant gage pressure p_0 . Repeat the analysis to find $V(t)$ in the pipe.

Solution: The analysis is the same as Prob. 3.180, except that we now have a (constant) surface-pressure term at point 1 which contributes to V_{final} :

$$\int_1^2 \frac{\partial V}{\partial t} ds + \frac{V_2^2}{2} + gz_2 \approx \frac{p_o}{\rho} + \frac{V_1^2}{2} + gz_1 = \frac{dV}{dt} L + \frac{V^2}{2} = \frac{p_o}{\rho} + gh, \quad \text{with } V = 0 \text{ at } t = 0.$$

The solution is: $V = V_{\text{final}} \tanh\left(\frac{V_{\text{final}} t}{2L}\right)$, where $V_{\text{final}} = \sqrt{\frac{2p_o}{\rho} + 2gh}$ Ans.

3.182 The incompressible-flow form of Bernoulli's relation, Eq. (3.77), is accurate only for Mach numbers less than about 0.3. At higher speeds, variable density must be accounted for. The most common assumption for compressible fluids is *isentropic flow of an ideal gas*, or $p = C\rho^k$, where $k = c_p/c_v$. Substitute this relation into Eq. (3.75), integrate, and eliminate the constant C . Compare your compressible result with Eq. (3.77) and comment.

Solution: We are to integrate the differential Bernoulli relation with variable density:

$$p = C\rho^k, \quad \text{so} \quad dp = kC\rho^{k-1} d\rho, \quad k = c_p/c_v$$

Substitute this into the Bernoulli relation:

$$\frac{dp}{\rho} + V dV + g dz = \frac{kC\rho^{k-1} d\rho}{\rho} + V dV + g dz = 0$$

$$\text{Integrate: } \int kC\rho^{k-2} d\rho + \int V dV + \int g dz = \int 0 = \text{constant}$$

The first integral equals $kC\rho^{k-1}/(k-1) = kp/[\rho(k-1)]$ from the isentropic relation. Thus the compressible isentropic Bernoulli relation can be written in the form

$$\frac{kp}{(k-1)\rho} + \frac{V^2}{2} + gz = \text{constant} \quad \text{Ans.}$$

It looks quite different from the incompressible relation, which only has "p/ρ." It becomes more clear when we make the ideal-gas substitution $p/\rho = RT$ and $c_p = kR/(k-1)$. Then we obtain the equivalent of the adiabatic, no-shaft-work energy equation:

$$c_p T + \frac{V^2}{2} + gz = \text{constant} \quad \text{Ans.}$$

3.183 The pump in Fig. P3.183 draws gasoline at 20°C from a reservoir. Pumps are in big trouble if the liquid vaporizes (cavitates) before it enters the pump. (a) Neglecting losses and assuming a flow rate of 65 gal/min, find the limitations on (x, y, z) for avoiding cavitation. (b) If pipe-friction losses are included, what additional limitations might be important?

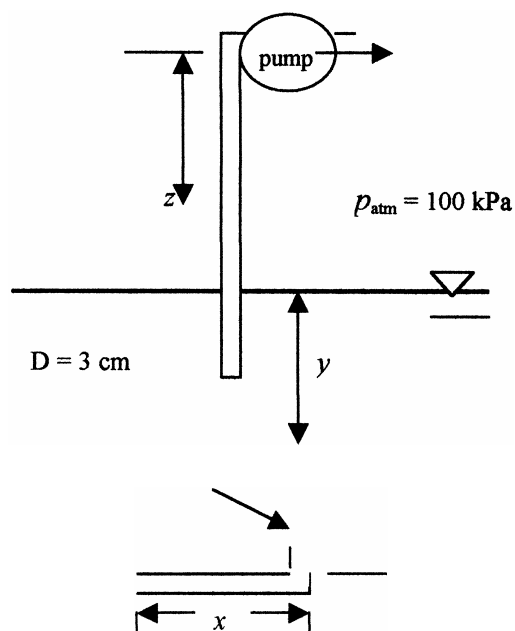

Fig. P3.183

Solution: (a) From Table A.3, $\rho = 680 \text{ kg/m}^3$ and $p_v = 5.51\text{E}+4$.

$$z_2 - z_1 = y + z = \frac{p_1 - p_2}{\rho g} = \frac{(p_a + \rho g y) - p_v}{\rho g}$$

$$y + z = \frac{(100,000 - 55,100)}{(680)(9.81)} + y \quad z = 6.73 \text{ m}$$

Thus make length z appreciably less than 6.73 (25% less), or $z < 5 \text{ m}$. *Ans. (a)*

(b) **Total pipe length $(x + y + z)$ restricted by friction losses.** *Ans. (b)*

3.184 For the system of Prob. 3.183, let the pump exhaust gasoline at 65 gal/min to the atmosphere through a 3-cm-diameter opening, with no cavitation, when $x = 3 \text{ m}$, $y = 2.5 \text{ m}$, and $z = 2 \text{ m}$. If the friction head loss is $h_{\text{loss}} \approx 3.7(V^2/2g)$, where V is the average velocity in the pipe, estimate the horsepower required to be delivered by the pump.

Solution: Since power is a function of h_p , Bernoulli is required. Thus calculate the velocity,

$$V = \frac{Q}{A} = \frac{(65 \text{ gal/min}) \left(6.3083\text{E}-5 \frac{\text{m}^3/\text{s}}{\text{gal/min}} \right)}{\frac{\pi}{4} (0.03^2)} = 5.8 \text{ m/s}$$

The pump head may then be found,

$$\frac{p_1}{\gamma} + z_1 = \frac{p_2}{\gamma} + z_2 + h_f - h_p + \frac{V_j^2}{2g}$$

$$\frac{100,000 + (680)(9.81)(2.5)}{(680)(9.81)} - 2.5 = \frac{100,000}{(680)(9.81)} + 2 + \frac{3.7(5.8^2)}{2(9.81)} - h_p + \frac{(5.8^2)}{2(9.81)}$$

$$h_p = 10.05 \text{ m}$$

$$P = \gamma Q h_p = (680)(9.81)(0.0041)(10.05) \quad \mathbf{P = 275 \text{ W} = 0.37 \text{ hp}} \quad \text{Ans.}$$

3.185 Water at 20°C flows through a vertical tapered pipe at 163 m³/h. The entrance diameter is 12 cm, and the pipe diameter reduces by 3 mm for every 2 meter rise in elevation. For frictionless flow, if the entrance pressure is 400 kPa, at what elevation will the fluid pressure be 100 kPa?

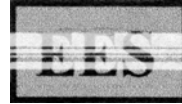

Solution: Bernoulli's relation applies,

$$\frac{p_1}{\gamma} + z_1 + \frac{Q_1^2}{2gA_1^2} = \frac{p_2}{\gamma} + z_2 + \frac{Q_2^2}{2gA_2^2} \quad (1)$$

Where,

$$d_2 = d_1 - 0.0015(z_2 - z_1) \quad (2)$$

Also, $Q_1 = Q_2 = Q = (163 \text{ m}^3/\text{h})(\text{h}/3600\text{s}) = 0.0453 \text{ m}^3/\text{s}$; $\gamma = 9790$; $z_1 = 0.0$; $p_1 = 400,000$; and $p_2 = 100,000$. Using EES software to solve equations (1) and (2) simultaneously, the final height is found to be $z \approx \mathbf{27.2 \text{ m}}$. The pipe diameter at this elevation is $d_2 = 0.079 \text{ m} = 7.9 \text{ cm}$.

FUNDAMENTALS OF ENGINEERING EXAM PROBLEMS: Answers

FE3.1 In Fig. FE3.1 water exits from a nozzle into atmospheric pressure of 101 kPa. If the flow rate is 160 gal/min, what is the average velocity at section 1?

- (a) **2.6 m/s** (b) 0.81 m/s (c) 93 m/s (d) 23 m/s (e) 1.62 m/s

FE3.2 In Fig. FE3.1 water exits from a nozzle into atmospheric pressure of 101 kPa. If the flow rate is 160 gal/min and friction is neglected, what is the gage pressure at section 1?

- (a) 1.4 kPa (b) 32 kPa (c) 43 kPa (d) **22 kPa** (e) 123 kPa

FE3.3 In Fig. FE3.1 water exits from a nozzle into atmospheric pressure of 101 kPa. If the exit velocity is $V_2 = 8$ m/s and friction is neglected, what is the axial flange force required to keep the nozzle attached to pipe 1?

- (a) 11 N (b) **36 N** (c) 83 N (d) 123 N (e) 110 N

FE3.4 In Fig. FE3.1 water exits from a nozzle into atmospheric pressure of 101 kPa. If the manometer fluid has a specific gravity of 1.6 and $h = 66$ cm, with friction neglected, what is the average velocity at section 2?

- (a) 4.55 m/s (b) 2.4 m/s (c) **2.8 m/s** (d) 5.55 m/s (e) 3.4 m/s

FE3.5 A jet of water 3 cm in diameter strikes normal to a plate as in Fig. FE3.5. If the force required to hold the plate is 23 N, what is the jet velocity?

- (a) 2.85 m/s (b) **5.7 m/s** (c) 8.1 m/s (d) 4.0 m/s (e) 23 m/s

FE3.6 A fireboat pump delivers water to a vertical nozzle with a 3:1 diameter ratio, as in Fig. FE3.6. If friction is neglected and the flow rate is 500 gal/min, how high will the outlet water jet rise?

- (a) 2.0 m (b) 9.8 m (c) **32 m** (d) 64 m (e) 98 m

FE3.7 A fireboat pump delivers water to a vertical nozzle with a 3:1 diameter ratio, as in Fig. FE3.6. If friction is neglected and the pump increases the pressure at section 1 to 51 kPa (gage), what will be the resulting flow rate?

- (a) **187 gal/min** (b) 199 gal/min (c) 214 gal/min (d) 359 gal/min (e) 141 gal/min

FE3.8 A fireboat pump delivers water to a vertical nozzle with a 3:1 diameter ratio, as in Fig. FE3.6. If duct and nozzle friction are neglected and the pump provides 12.3 feet of head to the flow, what will be the outlet flow rate?

- (a) 85 gal/min (b) 120 gal/min (c) **154 gal/min** (d) 217 gal/min (e) 285 gal/min

FE3.9 Water flowing in a smooth 6-cm-diameter pipe enters a venturi contraction with a throat diameter of 3 cm. Upstream pressure is 120 kPa. If cavitation occurs in the throat at a flow rate of 155 gal/min, what is the estimated fluid vapor pressure, assuming ideal frictionless flow?

- (a) 6 kPa (b) 12 kPa (c) 24 kPa (d) **31 kPa** (e) 52 kPa

FE3.10 Water flowing in a smooth 6-cm-diameter pipe enters a venturi contraction with a throat diameter of 4 cm. Upstream pressure is 120 kPa. If the pressure in the throat is 50 kPa, what is the flow rate, assuming ideal frictionless flow?

- (a) 7.5 gal/min (b) 236 gal/min (c) **263 gal/min** (d) 745 gal/min (e) 1053 gal/min

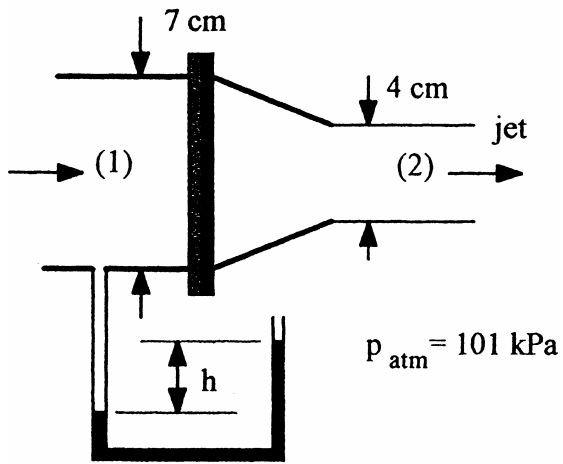

Fig. FE3.1

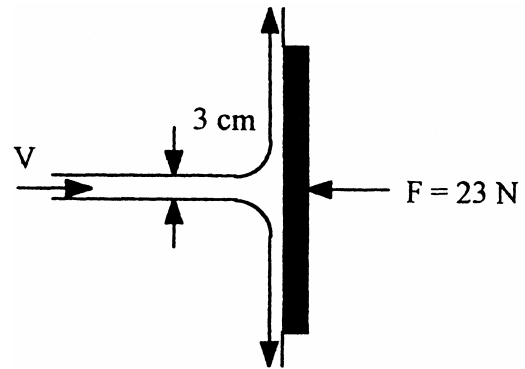

Fig. FE3.5

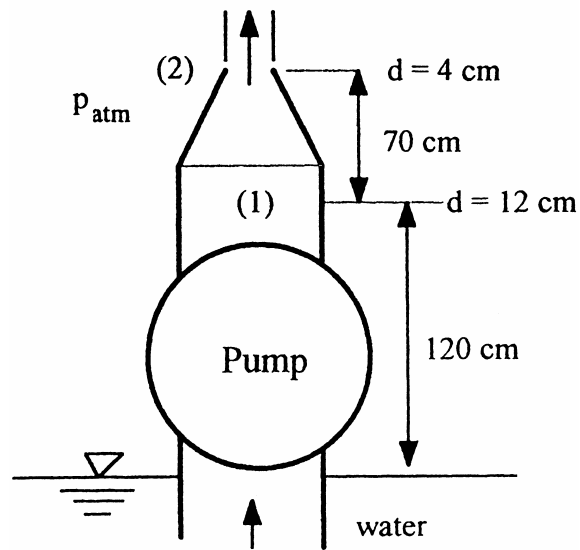
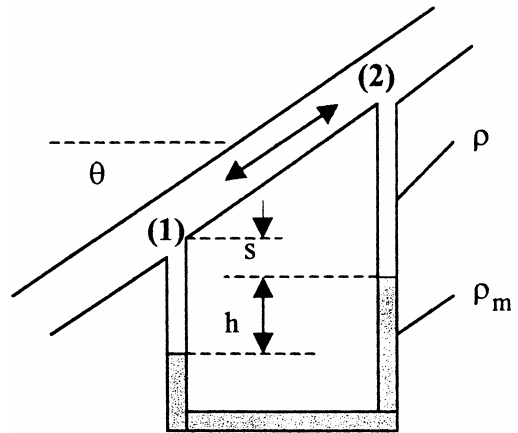

Fig. FE3.6

COMPREHENSIVE PROBLEMS

C3.1 In a certain industrial process, oil of density ρ flows through the inclined pipe in the figure. A U-tube manometer with fluid density ρ_m , measures the pressure difference between points 1 and 2, as shown. The flow is steady, so that fluids in the U-tube are stationary. (a) Find an analytic expression for $p_1 - p_2$ in terms of system parameters. (b) Discuss the conditions on h necessary for there to be no flow in the pipe. (c) What about flow *up*, from 1 to 2? (d) What about flow *down*, from 2 to 1?



Solution: (a) Start at 1 and work your way around the U-tube to point 2:

$$p_1 + \rho g s + \rho g h - \rho_m g h - \rho g s - \rho g \Delta z = p_2,$$

$$\text{or: } p_1 - p_2 = \rho g \Delta z + (\rho_m - \rho) g h \quad \text{where } \Delta z = z_2 - z_1 \quad \text{Ans. (a)}$$

(b) If there is no flow, the pressure is entirely hydrostatic, therefore $\Delta p = \rho g$ and, since $\rho_m \neq \rho$, it follows from Ans. (a) above that $h = 0$ Ans. (b)

(c) If h is positive (as in the figure above), p_1 is greater than it would be for no flow, because of head losses in the pipe. **Thus, if $h > 0$, flow is up from 1 to 2.** Ans. (c)

(d) If h is negative, p_1 is less than it would be for no flow, because the head losses act against hydrostatics. **Thus, if $h < 0$, flow is down from 2 to 1.** Ans. (d)

Note that h is a direct measure of flow, regardless of the angle θ of the pipe.

C3.2 A rigid tank of volume $\nu = 1.0 \text{ m}^3$ is initially filled with air at 20°C and $p_0 = 100 \text{ kPa}$. At time $t = 0$, a vacuum pump is turned on and evacuates air at a constant volume flow rate $Q = 80 \text{ L/min}$ (regardless of the pressure). Assume an ideal gas and an isothermal process. (a) Set up a differential equation for this flow. (b) Solve this equation for t as a function of (ν, Q, p, p_0) . (c) Compute the time in minutes to pump the tank down to $p = 20 \text{ kPa}$. [Hint: Your answer should lie between 15 and 25 minutes.]

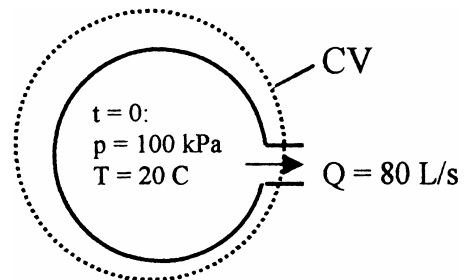

Solution: The control volume encloses the tank, as shown. The CV mass flow relation becomes

$$\frac{d}{dt} \left(\int \rho dv \right) + \Sigma \dot{m}_{out} - \Sigma \dot{m}_{in} = 0$$

Assuming that ρ is constant throughout the tank, the integral equals ρv , and we obtain

$$v \frac{d\rho}{dt} + \rho Q = 0, \quad \text{or:} \quad \int \frac{d\rho}{\rho} = -\frac{Q}{v} \int dt, \quad \text{yielding} \quad \ln \left(\frac{\rho}{\rho_0} \right) = -\frac{Qt}{v}$$

Where ρ_0 is the initial density. But, for an isothermal ideal gas, $\rho/\rho_0 = p/p_0$. Thus the time required to pump the tank down to pressure p is given by

$$t = -\frac{v}{Q} \ln \left(\frac{p}{p_0} \right) \quad \text{Ans. (a, b)}$$

(c) For our particular numbers, noting $Q = 80 \text{ L/min} = 0.080 \text{ m}^3/\text{min}$, the time to pump a 1 m^3 tank down from 100 to 20 kPa is

$$t = -\frac{1.0 \text{ m}^3}{0.08 \text{ m}^3/\text{min}} \ln \left(\frac{20}{100} \right) = \mathbf{20.1 \text{ min}} \quad \text{Ans. (c)}$$

C3.3 Suppose the same steady water jet as in Prob. 3.40 (jet velocity 8 m/s and jet diameter 10 cm) impinges instead on a cup cavity as shown in the figure. The water is turned 180° and exits, due to friction, at lower velocity, $V_e = 4 \text{ m/s}$. (Looking from the left, the exit jet is a circular annulus of outer radius R and thickness h , flowing toward the viewer.) The cup has a radius of curvature of 25 cm. Find (a) the thickness h of the exit jet, and (b) the force F required to hold the cupped object in place. (c) Compare part (b) to Prob. 3.40, where $F = 500 \text{ N}$, and give a physical explanation as to why F has changed.

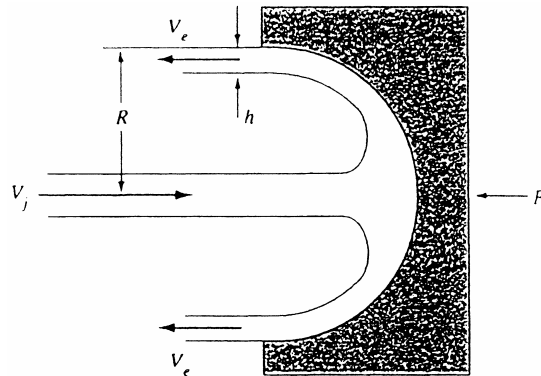

Fig. C3.3

Solution: For a steady-flow control volume enclosing the block and cutting through the jets, we obtain $\Sigma Q_{in} = \Sigma Q_{out}$, or:

$$V_j \frac{\pi}{4} D_j^2 = V_e \pi [R^2 - (R-h)^2], \quad \text{or:} \quad h = R - \sqrt{R^2 - \frac{V_j D_j^2}{V_e}} \quad \text{Ans. (a)}$$

For our particular numbers,

$$h = 0.25 - \sqrt{(0.25)^2 - \frac{8}{4} \frac{(0.1)^2}{4}} = 0.25 - 0.2398 = 0.0102 \text{ m} = \mathbf{1.02 \text{ cm}} \quad \text{Ans. (a)}$$

(b) Use the momentum relation, assuming no net pressure force except for F:

$$\sum F_x = -F = \dot{m}_{jet}(-V_e) - \dot{m}_{jet}(V_j), \quad \text{or:} \quad F = \rho V_j \frac{\pi}{4} D_j^2 (V_j + V_e) \quad \text{Ans. (b)}$$

For our particular numbers:

$$F = 998(8) \frac{\pi}{4} (0.1)^2 (8 + 4) = \mathbf{752 \text{ N to the left}} \quad \text{Ans. (b)}$$

(c) The answer to Prob. 3.40 was 502 N. We get **50% more** because we turned through 180°, not 90°. *Ans. (c)*

C3.4 The air flow beneath an air hockey puck is very complex, especially since the air jets from the table impinge on the puck at various points asymmetrically. A reasonable approximation is that, at any given time, the

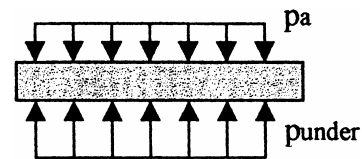

gage pressure on the bottom of the puck is halfway between zero (atmospheric) and the stagnation pressure of the impinging jets, $p_o = 1/2 \rho V_{jet}^2$. (a) Find the velocity V_{jet} required to support a puck of weight W and diameter d , with air density ρ as a parameter. (b) For $W = 0.05 \text{ lbf}$ and $d = 2.5 \text{ inches}$, estimate the required jet velocity in ft/s.

Solution: (a) The puck has atmospheric pressure on the top and slightly higher on the bottom:

$$(p_{under} - p_a)A_{puck} = W = \frac{1}{2} \left(0 + \frac{\rho}{2} V_{jet}^2 \right) \frac{\pi}{4} d^2, \quad \text{Solve for } V_{jet} = \frac{4}{d} \sqrt{\frac{W}{\pi \rho}} \quad \text{Ans. (a)}$$

For our particular numbers, $W = 0.05 \text{ lbf}$ and $d = 2.5 \text{ inches}$, we assume sea-level air, $\rho = 0.00237 \text{ slug/ft}^3$, and obtain

$$V_{jet} = \frac{4}{(2.5/12 \text{ ft})} \sqrt{\frac{0.05 \text{ lbf}}{\pi(0.00237 \text{ slug/ft}^3)}} = \mathbf{50 \text{ ft/s}} \quad \text{Ans. (b)}$$

C3.5 Neglecting friction sometimes leads to odd results. You are asked to analyze and discuss the following example in Fig. C3.5. A fan blows air vertically through a duct from section 1 to section 2, as shown. Assume constant air density ρ . Neglecting frictional losses, find a relation between the required fan head h_p and the flow rate and the elevation change. Then explain what may be an unexpected result.

Solution: Neglecting frictional losses, $h_f = 0$, and Bernoulli becomes,

$$\frac{p_1}{\rho g} + \frac{V_1^2}{2g} + z_1 = \frac{p_2}{\rho g} + z_2 + \frac{V_2^2}{2g} - h_p$$

$$\frac{p_1}{\rho g} + \frac{V_1^2}{2g} + z_1 = \frac{p_2 + \rho g(z_1 - z_2)}{\rho g} + \frac{V_2^2}{2g} + z_2 - h_p$$

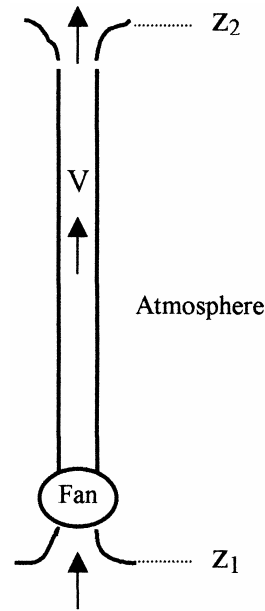

Fig. C3.5

Since the fan draws from and exhausts to atmosphere, $V_1 = V_2 \approx 0$. Solving for h_p ,

$$h_p = \rho g(z_1 - z_2) + \rho g z_2 - \rho g z_1 = 0 \quad \text{Ans.}$$

Without friction, and with $V_1 = V_2$, the energy equation predicts that $h_p = 0$! Because the air has insignificant weight, as compared to a heavier fluid such as water, the power input required to lift the air is also negligible.
