

# Dryer

Refer to Page 4 for Model Identification

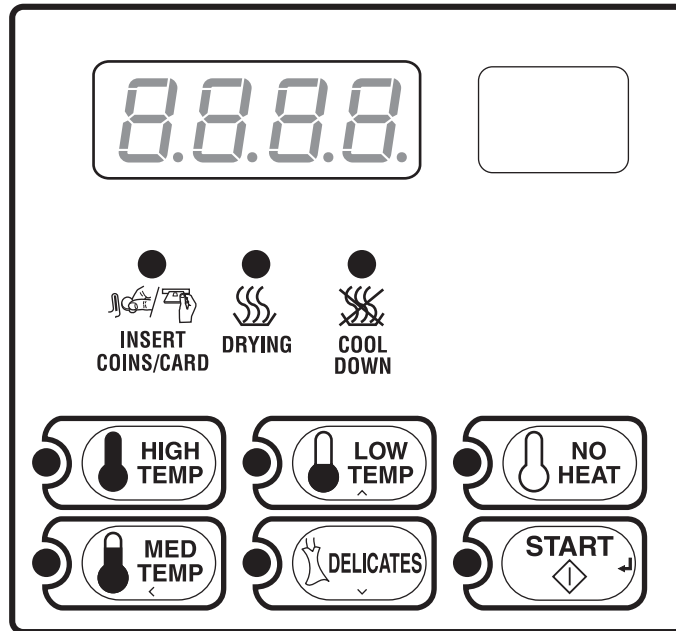

DRY576F

**Keep These Instructions for Future Reference.**

(If this machine changes ownership, this manual must accompany machine.)





## WARNING

Failure to install, maintain, and/or operate this machine according to the manufacturer's instructions may result in conditions which can produce bodily injury and/or property damage.

W030

**NOTE: The WARNING and IMPORTANT instructions appearing in this manual are not meant to cover all possible conditions and situations that may occur. It must be understood that common sense, caution, and carefulness are factors which cannot be built into these dryers. These factors MUST BE supplied by the person(s) installing, maintaining, or operating the dryer.**

Always contact the distributor, service agent, or the manufacturer about any problems or conditions you do not understand.

# Table of Contents

<b>Model Identification</b> .....	4
<b>Preliminary Information</b> .....	5
About the Control .....	5
Glossary of Terms.....	5
Power Failure Recovery .....	5
Communications .....	5
<b>Control Identification</b> .....	6
SELECT CYCLE Pads .....	6
START Pad.....	6
<b>Display Identification</b> .....	7
Light Emitting Diodes (LEDs) .....	7
<b>Dryer Operation</b> .....	8
Start Up .....	8
Ready Mode.....	8
Partial Vend Mode.....	8
Additional Vend Mode .....	8
Start Mode .....	8
Entering Coins .....	8
Entering Cards .....	9
Changing Active Cycles .....	9
Opening the Dryer Door .....	9
Signals.....	9
Extended Tumble Mode .....	9
<b>Special Features</b> .....	10
Programming Control .....	10
Collecting Audit Information .....	10
Testing Machine and Control Functions.....	10
Rapid Advance Feature.....	10
Clearing the Vend Feature .....	10
Communications Mode.....	10
Coin Drop .....	10
Start Pulse Operation .....	11
Service Door and Coin Vault Openings .....	11
Special Vend.....	11
OPL Mode .....	11
Drop-Off Mode.....	11
Low Power/Auto-Shutdown Option .....	11
<b>Opening the Service Door</b> .....	12
Stacked Washers and Dryers, Stacked Dryers, Front Control Dryers, and Coin Rear Control Dryers .....	12
Rear Control Dryers with Card Reader .....	12
<b>Entering the Manual Mode</b> .....	13
How to Enter the Manual Mode .....	13
<b>Programming Control</b> .....	15
What Can Be Programmed? .....	15

© Published by permission of the copyright owner.

All rights reserved. No part of the contents of this book may be reproduced or transmitted in any form or by any means without the expressed written consent of the publisher.

Programmable Options Available.....	15
1. Heat Vend Price “AtSH” .....	23
2. Coin #1 Value “dEn1” .....	24
3. Coin #2 Value “dEn2” .....	25
4. Start Pulse Value “PLSE” .....	26
5. Start Pulse Mode “PLSn” .....	27
6. Available Type “AtyP” .....	28
7. Default Cycle “dCYC” .....	29
8. OPL Mode Enable/Disable “oPL” .....	30
9. Audio Signal “Aud” or “AUd”* .....	31
10. Card Reader Display Control “CAd” .....	33
11. Error Code Programming “Err-” .....	34
12. Top-Off Data “toP-” .....	35
13. Cycle Time “CyC-” .....	36
14. Cool Down Time “Cdt-” .....	37
15. Temperature “tEP-” .....	38
16. Temperature (Fahrenheit/Celsius) “t FC” .....	39
17. No Heat Vend Price “AtSn” .....	40
18. Set Real-Time Clock “rtC-” .....	41
19. Special Vend A Data “SPA-” .....	42
20. Special Vend B Days Enable “SPb-” .....	56
21. Special Vend C Days Enable “SPC-” .....	56
22. Special Vend D Days Enable “SPd-” .....	57
23. Drop Off Mode (On/Off) “droP” .....	58
24. Low Power/Auto Shutdown A Days Enable “LPSA” .....	58
25. Low Power/Auto Shutdown B Days Enable “LPSb” .....	59
26. Low Power/Auto Shutdown C Days Enable “LPSC” .....	59
27. Low Power/Auto Shutdown D Days Enable “LPSd” .....	60
28. Power Fail Reset “PFr” .....	60
29. IR Access (On/Off) “IrA” .....	62
30. Manual Rapid Advance (On/Off) “rAEn” .....	62
31. Manual Diagnostics (On/Off) “dAEn” .....	63
32. Production Test Cycle (On/Off) “PtEn” .....	63
<b>Collecting Audit Information</b> .....	64
<b>Manual Reset</b> .....	65
<b>Testing Machine and</b>	
<b>Electronic Control Functions</b> .....	66
Diagnostic Test Descriptions .....	68
Production Test Cycle.....	72
<b>Error Codes</b> .....	73
<b>Rapid Advance Feature</b> .....	75
<b>Clear Vend Feature</b> .....	76
<b>Power Fail Recovery</b> .....	77
Power Fail Reset Disabled.....	77
Power Fail Reset Enabled.....	77
<b>Communications Mode</b> .....	78
Infra-red Communications.....	78
Card Reader Communications	
(Card Models Only).....	78
Network Communications.....	78

# Model Identification

Information in this manual is applicable to these dryer models:

BD3LLFGS401UN01	HDGLXFGS111CW01	NT3LLFSP401NN22	SSELCFGS151TW01
BD3LLFGS401UW01	HDGLXFGS111CWNA	NT3LLFSP401NW22	SSELCFGS171TW01
BD3LLFSS401UN01	HDGLXFGW111CN01	NT3LLFSP401UN01	SSELCFGW151TW01
BD3LXFGS401UN01	HDGLXFSW111CN01	NT3LLFSP401UW01	SSELCFGW171TN01
BD3LXFGS401UW01	HDGLXRG111CW01	NT3LXFSP401UN01	SSELCFGW171TW01
BD3LXFSS401UN01	HDGLYFGS111CW01	NT3LXFSP401UW01	SSELXFGW171TW01
BDGLLFGS301EN01	HDGLYFGS111CWNA	NTHLXFSP571NW01	SSELYFGS171TW01
BDGLLFGS301EW01	HDGLYRG111CW01	NTHLYFSP571NW01	SSELYFGW171TN01
BDGLLFSS301EN01	HSELXFGW281CW01	RDELYFGS151CW01	SSELYFGW171TW01
BDGLXFGS301EN01	HSELXFGW291CW01	RDELYFGS171CW01	SSELYFGW171TWNA
BDGLXFGS301EW01	HSELYFGW281CW01	RDGLYFGS111CW01	SSGLCFG111TW01
BDGLXFSS301EN01	HSELYFGW291CW01	SDELCFGS171TW01	SSGLCFG111TWNA
BT3LLFSG401UN01	HSGLXFGW091CW01	SDELCFGW171TN01	SSGLCFGW111TN01
BT3LLFSG401UW01	HSGLYFGW091CW01	SDELCFSW171TN01	SSGLCFGW111TW01
BT3LLFSP401UN01	HTELXFS281CW01	SDELCRGS151TW01	SSGLCFGW111TWNA
BT3LLFSP401UW01	HTELXFS291CW01	SDELCRGS171TW01	SSGLXFGW111TW01
BT3LXFSG401UN01	HTELYFS281CW01	SDELCRGS171TW02	SSGLYFGS111TW01
BT3LXFSG401UW01	HTELYFS291CW01	SDELCRGS171TWNA	SSGLYFGS111TWNA
BT3LXFSP401UN01	HTENXFS281CW01	SDELXRG171TW01	SSGLYFGW111TN01
BT3LXFSP401UW01	HTENXFS291CW01	SDELXRG171TW02	SSGLYFGW111TW01
HDELEFGS151CW01	HTENYFS281CW01	SDELXRG301AW01	SSGLYFGW111TWNA
HDELEFGS151CWNA	HTENYFS291CW01	SDELYFGS171TW01	ST3LXFSP401NW22
HDELEFGS171CQ01	HTGLXFS091CW01	SDELYFGW171TN01	STELCFSP171TW01
HDELEFGS171CW01	HTGNXFS091CW01	SDELYFSW171TN01	STELXFS171TW01
HDELERGS151CW01	ND3LLFSS401UN01	SDELYRGS151TW01	STELYFS171TW01
HDELERGS151CWNA	ND3LXFSS401UN01	SDELYRGS171TW01	STENCFS171TW01
HDELERGS171CW01	NDELXFGS301UW01	SDGLCFG111TW01	STENXFS171TW01
HDELXFGS151CW01	NDGLLFSS301EN01	SDGLCFGW111TN01	STENYFS171TW01
HDELXFGS171CW01	NDGLXFGS301EW01	SDGLCFSW111TN01	STGLCFSP111TW01
HDELXFGW171CN01	NDGLXFSS301EN01	SDGLCRGS111TW01	STGLCFSP111TWNA
HDELXFSW171CN01	NT1LLFSP411CW01	SDGLCRGS111TW02	STGLXFSG111TW01
HDELXRG151CW01	NT1LLFSP411UW06	SDGLCRGS111TWNA	STGLXFS111TW01
HDELXRG171CW01	NT1LXFS401UN01	SDGLXRG111TW01	STGLYFS111TW01
HDELYFGS151CW01	NT1LXFS401UW01	SDGLYFGS111TW01	STGLYFS111TWNA
HDELYFGS171CW01	NT2LLFSP401UN01	SDGLYFGS111TWNA	STGNCFSP111TW01
HDELYRGS151CW01	NT2LLFSP401UW01	SDGLYFGW111TN01	STGNXFSG111TW01
HDELYRGS151CWNA	NT2LLFSP401UW06	SDGLYFSW111TN01	STGNXFS111TW01
HDELYRGS171CW01	NT2LXFS401UN01	SDGLYRGS111TW01	STGNYFS111TW01
HDGLEFGS111CW01	NT2LXFS401UW01	SDGLYRGS111TWNA	
HDGLERGS111CW01	NT3LLFSG401UW01	SDGLXRG111TW02	
HDGLERGS111CWNA	NT3LXFSG401UW01	SDGLXRG301AW01	

# Preliminary Information

## About the Control

This control is an advanced, programmable computer that lets the owner control machine features by pressing a sequence of SELECT CYCLE pads. Refer to *Figure 1*.

The control allows the owner to program custom cycles, set vend prices, retrieve audit information, run diagnostic tests, program special vend features and other programmable features. Refer to ***Programming Control*** for a list of features. Dryers shipped from the factory have a default cycle (MED TEMP) built in. However, the owner can change the default cycle, or any cycle, as needs permit.

**IMPORTANT: In the event of a power failure, the control will not have to be reprogrammed. It is designed with a memory system that will remember how it was programmed (for up to 10 years) until the electrical power is restored.**

**IMPORTANT: It is extremely important that the dryer has a positive ground and that all mechanical and electrical connections to the control are made before applying power to or operating the dryer.**

## Glossary of Terms

The following are a few terms and abbreviations to learn. These are referred to throughout the instructions.

Display – This term refers to the window area of the control that displays words and values.

LED (Light Emitting Diode) – This term refers to the lights next to the keypads and status words of the control.

## Power Failure Recovery

If a cycle is in progress and the power fails, the cycle status is saved in memory. When the power recovers, the dryer will resume into the previously active cycle (if so programmed by the owner), by pressing the START pad. If the power failure occurs while the control is in a fatal error mode, it will return to Ready Mode upon recovery.

The owner may program a special feature called POWER FAIL RESET which sets a maximum power failure duration. To program this feature, refer to ***Programming Control, option 28***.

If the length of the power failure is greater than the POWER FAIL RESET time, the control will end the cycle and the display will revert back to the Ready Mode rather than resume the previously active cycle. If the length of the power failure is less than the POWER FAIL RESET time and the power failure is greater than 2 seconds, or the POWER FAIL RESET is turned off, the dryer will enter START mode.

## Communications

The control may be programmed manually, by infra-red with an external device or by the network. A limited number of features can be programmed by a card reader.

### Infra-red Communications (Optional)

An external device, such as a PDA, allows the owner to program and retrieve information from the control without touching the keypad. An external device greatly expands the programming options available to the owner. However, the external device is not required to program and operate the dryer. The operation of an external device and the advanced features available are covered separately in the instructions included with the external device software. Contact Alliance Laundry Systems for a list of approved PDAs and other external devices.

### Serial Card Reader Communications (Card Models Only)

The control will accept communication with a serial card reader in order to perform vending transactions when a card is inserted to pay for cycles. The card reader can also allow the owner to program and collect audit information.

For detailed information on serial card reader communications, refer to instructions included with card reader.

### Network Communications

The control will also accept communication with a network interface board which allows the control to be linked to a personal computer. This network link allows an owner to program, collect data and run diagnostics on any machine.

For detailed information on network communications, refer to the network instructions.

# Control Identification

## SELECT CYCLE Pads

(Refer to *Figure 1*)

SELECT CYCLE pads are used to select the specific dryer cycle and temperature. These pads include HIGH TEMP, MED TEMP, LOW TEMP, DELICATES and NO HEAT. The selection of one of these cycles will light up the corresponding LED. The factory default cycle is MED TEMP.

## START Pad

(Refer to *Figure 1*)

The START pad is used to start the dryer after the full vend price has been satisfied and the dryer door is closed.

Both the START pad and the SELECT CYCLE pads are used in various combinations for programming cycles, retrieving audit information, running diagnostic tests, and other operations. During an active cycle (card reader equipped machines only), the START pad may be pressed (with a card inserted) to add time to a cycle.

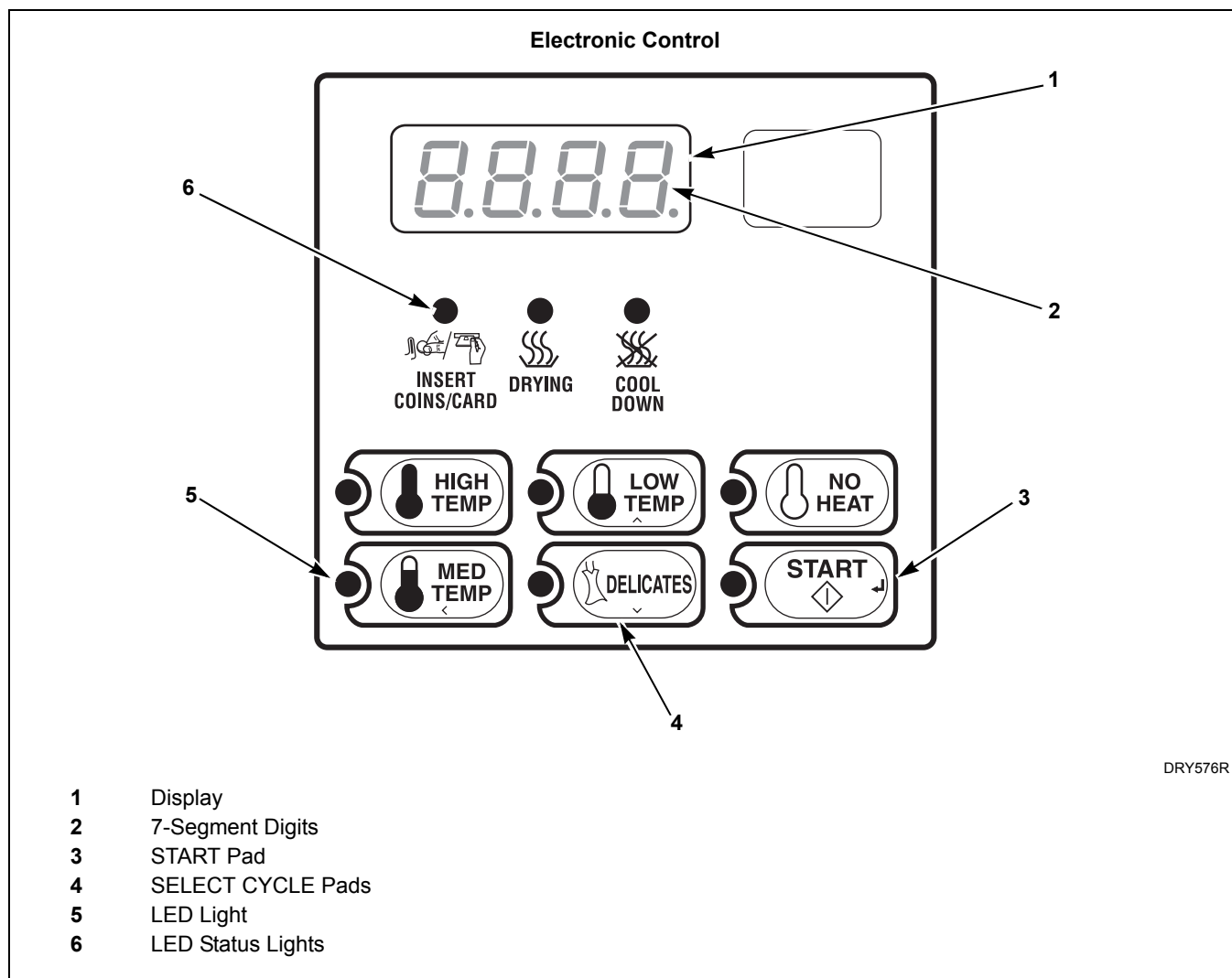

Figure 1



# Display Identification

## Light Emitting Diodes (LEDs)

(Refer to *Figure 1*)

LIGHT EMITTING DIODES (LEDs) are used to indicate the chosen temperature and cycle status. See below for information on each LED.

### INSERT COINS/CARD LED

The *INSERT COINS/CARD* LED is lit to prompt the user to insert coins or a card to satisfy the vend price for the chosen cycle. The LED is lit during the “Ready” mode. During Partial and Additional Vend, the LED flashes one second on and one second off. The *INSERT COINS/CARD* LED will shut off when the vend price has been satisfied.

### START LED

The *START* pad LED flashes whenever the dryer is not in a cycle, the full vend price has been satisfied, and the dryer door is closed. When the *START* pad is pressed, the cycle will begin or resume. The *START* LED will shut off when the *START* pad is pressed. The *START* LED will also flash any time a card is inserted to add time to the current cycle.

### DRYING LED

The *DRYING* LED is lit to indicate that one of the heated cycles (HIGH TEMP, MED TEMP, LOW TEMP, DELICATES) is currently in operation. The *DRYING* LED goes off at the end of a heated cycle, if the heated cycle is changed to a NO HEAT cycle, or when the COOL DOWN cycle begins.

## COOL DOWN LED

The *COOL DOWN* LED is lit whenever the COOL DOWN portion of a heated cycle is active. It is also lit when the NO HEAT cycle is in operation. The *COOL DOWN* LED will shut off when a cycle ends or more time is added, pushing the cycle back into the heated portion of a cycle.

## Four 7-Segment Digits

The 7-SEGMENT DIGITS are used to display the time remaining in a cycle, vend price, error messages and descriptive codes. During diagnostic testing or manual programming of the control, these digits will display descriptive codes and values (as described in *Entering the Manual Mode*).

# Dryer Operation

## Start Up

When power is applied to the dryer, the control becomes active and will display its software version as “SXX” (“XX” is the version number) for one second and then the subversion as “XX” (if subversion isn’t zero) for one second. If the control was not powered down during a running cycle, it will enter the Ready Mode.

## Ready Mode

In Ready Mode, the default cycle LED is lit, and the full vend price is displayed.

The user may select a different cycle, if desired. If the vend price is not satisfied within 4.25 minutes, the dryer control will return to the Ready Mode. The display will continue to show the remaining vend needed to start a cycle.

## Partial Vend Mode

The control enters this mode when part of the vend price has been entered, but not enough vend is entered to satisfy the vend price. The control will display the remaining vend price needed to start the cycle and the *INSERT COINS/CARD* LED is lit.

## Additional Vend Mode

The control enters this mode if the cycle is changed to a cycle that requires more money. If the vend price is not satisfied within 60 seconds, the control will go back to the first selection and the cycle will continue.

## Start Mode

Vends may be satisfied by a coin drop, start pulses, or by a third party card reader. If a coin drop is used, the remaining vend price will decrease with each coin entry. If start pulses are used, the remaining vend price will decrease with each received pulse. Once the vend is satisfied, the START LED will begin to flash and signal will sound for ten seconds. If a third party card reader is used, the START LED will begin to flash when a valid cash card is entered into the reader.

When the START keypad is pressed, the dryer will start. The START LED will stop flashing and either the DRYING LED or the COOL DOWN LED will be lit. The display will change to show the remaining cycle time on the display. The DRYING LED will be lit during the heat portion of a heat cycle. The COOL DOWN LED will be lit during the cool down portion of a heat cycle and during an entire no heat cycle.

When a cycle is complete, the display will show “00” until the door is opened, a key is pressed, a coin or card is entered, or a start pulse is received. When any of the above happens, the display will revert back to the Ready Mode.

## Entering Coins

Coins are entered to satisfy the programmed vend price for a selected cycle. Coins may be entered before selecting a cycle or during an active cycle. When coins are entered during an active cycle, the time remaining is increased by the amount programmed by the owner (refer to *Programming Control*).

The owner may choose to add additional time for each coin entered. If coins are entered for an active cycle currently in the COOL DOWN Mode, coins entered may push the cycle back into the DRYING Mode. The maximum time for any cycle is 99 minutes.

## Entering Cards

A card is entered to satisfy the programmed vend price for a selected cycle. The card may be entered before selecting a cycle or during an active cycle. When the card is entered during an active cycle and the START keypad is pressed, the time remaining is increased by the amount programmed by the owner. Refer to *Programming Control* section.

The owner may choose to add additional time by deducting a vend from the card or may require an additional full vend price be deducted from the card. If vend is deducted during an active heated cycle that is currently in the COOL DOWN Mode, the additional time added may put the cycle back into the DRYING Mode. The maximum time for any cycle is 99 minutes. Additional time cannot be added if it exceeds the 99 minute limit on a drying cycle.

## Changing Active Cycles

In OPL machines, the active cycle may be changed at any time during dryer operation. In vend machines, the active cycle may be changed in the first five minutes for more expensive cycles. Cycles that are the same price or less expensive can be chosen anytime. The last five minutes of cycle can be changed with no change to vend or time remaining.

## Opening the Dryer Door

Opening the dryer door in a running cycle will automatically stop the cycle. When the dryer door is opened, the DRYING LED or COOL DOWN LED is turned off.

**NOTE: When the door is opened during an active cycle, the time will continue to count down and the display will toggle every five seconds between showing “door” and the remaining cycle time.**

Once the dryer door is closed, the START pad LED flashes at one second intervals until the START pad is pushed. Pressing the START pad will start or resume the active cycle.

## Signals

There are six instances when a signal may sound during dryer operation. The owner may program the signal to be turned on or off (refer to *Programming Control, option 9*). These six instances are listed below:

### 1. End of Cycle Signal

By default, this signal is turned off. If turned on, the signal will sound for three seconds at the end of a cycle.

### 2. Keypad Depression Signal

The signal will sound for a quarter of a second each time a keypad is pressed.

### 3. Coin Input/Start Pulse Input/Card Insertion Signal

The signal will sound for a quarter of a second each time a coin or start pulse is received or a card is entered.

### 4. Remove Card Signal

This signal will sound one second on and one second off while the control prompts for card removal.

### 5. Start Pad Flashing Signal

This signal will sound one second on and one second off when the START LED is flashing, for the first ten seconds after vend has been satisfied.

### 6. Extended Tumble Mode Signal

This signal cannot be disabled. While in extended tumble mode, the signal will sound one second on and one second off for five seconds and then continuously for five seconds before starting the extended tumble.

## Extended Tumble Mode

The control enters Extended Tumble Mode twenty minutes after a cycle has ended. The signal will sound one second on and one second off for five seconds and then continuously for five seconds before starting the extended tumble, which lasts two minutes, every hour, for up to 18 hours. Extended Tumble Mode ends with any user interaction.

# Special Features

## Programming Control

The control allows the dryer owner to program the control with the use of the keypad. Cycle and vend information may be programmed, audit information may be viewed and diagnostic tests may be run by pressing keypad combinations.

For details on programming cycle and vend information, refer to *Programming Control*.

## Collecting Audit Information

The control will store audit information in its memory that can be retrieved by pressing various keypad combinations. The control will record coins entered, total machine cycles, top-offs, and total start pulses.

For more information on the audit features, refer to *Collecting Audit Information*.

**NOTE: Additional audit information is retrievable with an external device, a card reader or a network. Refer to the appropriate instruction manual.**

## Testing Machine and Control Functions

Special programmable diagnostic features built into the control allow the owner to run specific diagnostic tests. By opening and closing the service door, with coin vault closed, and then pressing various sequences of keypads, the owner may retrieve and perform the following tests:

- Control Software Version Number
- Service Door Opening Test
- Coin Vault Opening Test
- Coin Drop #1 Input Test
- Coin Drop #2 Input Test
- Start Pulse Test
- Dryer-on Temperature Test
- Thermistor Temperature Test
- Configuration Display Tests
- Coin Header Present Status

For detailed information on running diagnostic tests, refer to *Testing Machine and Electronic Control Functions*.

## Rapid Advance Feature

This feature allows the user to quickly advance through an active dryer cycle or advance into a cycle from the Ready Mode. This feature is useful when tests must be performed immediately on a dryer currently in an active cycle. In this case, the user can quickly advance through the cycle to the Ready Mode. At this point, the user can perform the required tests and then return the dryer to the active cycle.

For detailed information on using the Rapid Advance feature, refer to *Rapid Advance Feature*.

## Clearing the Vend Feature

This feature allows the user to return the control back to the Ready Mode if coins have been entered but the full vend price has not yet been satisfied, while in Partial Vend Mode.

For more information on using the Clear Vend feature, refer to *Clear Vend Feature*.

## Communications Mode

This feature allows the dryer control to communicate with an external device, a card reader or a network. This allows the dryer control to be programmed and have its data read without using the keypad.

For more detailed information on using the Communications Mode feature, refer to *Communications Mode*.

## Coin Drop

The control will accept pulses from a single or dual coin drop to satisfy vend price. Each coin drop will have the ability to satisfy the vend.

## Start Pulse Operation

The control will accept pulses from optional payment systems. The machine can be programmed to receive a single start pulse or multiple start pulses, or the Start Pulse Option can be turned off. The Start Pulse Mode allows the machine to go from the “Ready” mode to the “START” mode after single or multiple pulses are received.

## Service Door and Coin Vault Openings

The control will capture the times and dates of the openings of the Coin Vault and the Service Door. The information is saved in memory. An open service door combined with various keypad presses allows the control to enter manual modes of operation if the Break-In Alarm is not on. These modes include Manual Programming, Audit Collection, Diagnostics, Rapid Advance, and reset to factory defaults.

## Special Vend

This feature allows the owner to program the control to allow programmable vend prices for specific hours and dates.

For details on programming Special Vend, refer to *Programming Control*.

## OPL Mode

This feature allows the user to start a cycle without satisfying the vend price.

Press the START keypad to add time to the cycle. Press the LOW TEMP and DELICATES keypads to end the cycle.

For details on enabling OPL Mode, refer to *Programming Control*.

## Drop-Off Mode

This feature allows the owner to limit machine use to an attendant without requiring vend. Starting the machine will require the correct sequence of four keypad presses as programmed by an external device or a network.

Press the START keypad to add time to the cycle. Press the LOW TEMP and DELICATES keypads to end the cycle.

For details on enabling Drop-Off Mode, refer to *Programming Control*.

## Low Power/Auto-Shutdown Option

This feature allows the owner to program the control to shut down or enter a low power consumption mode based on programmable times and dates if either of these options are enabled.

For details on programming the Low Power/Auto-Shutdown option, refer to *Programming Control*.

# Opening the Service Door

## Stacked Washers and Dryers, Stacked Dryers, Front Control Dryers, and Coin Rear Control Dryers

Manually programming the control requires the user to open and close the service door. Opening and closing the service door trips a switch allowing access to various programming options, diagnostics, and audit capabilities.

On stacked dryers, stacked washers and dryers, and front control dryers, the service door is located in the control panel. On rear control dryers, the service door is located on the top of the meter case. Refer to *Figure 2*.

After opening and closing the service door, the programmer has 4.25 minutes to begin programming. If a SELECT CYCLE pad has not been pressed in that time, the control will revert back to the Ready Mode. Refer to *Figure 2*.

## Rear Control Dryers with Card Reader

Manually programming the control requires the user to remove the control panel and unplug the bullet connector located between the “white/black” and “red/blue” wires or to insert an appropriate card into the reader. This will allow the user to access various programming options, diagnostics and audit capabilities. The control panel is located on the control hood. Refer to *Figure 2*.

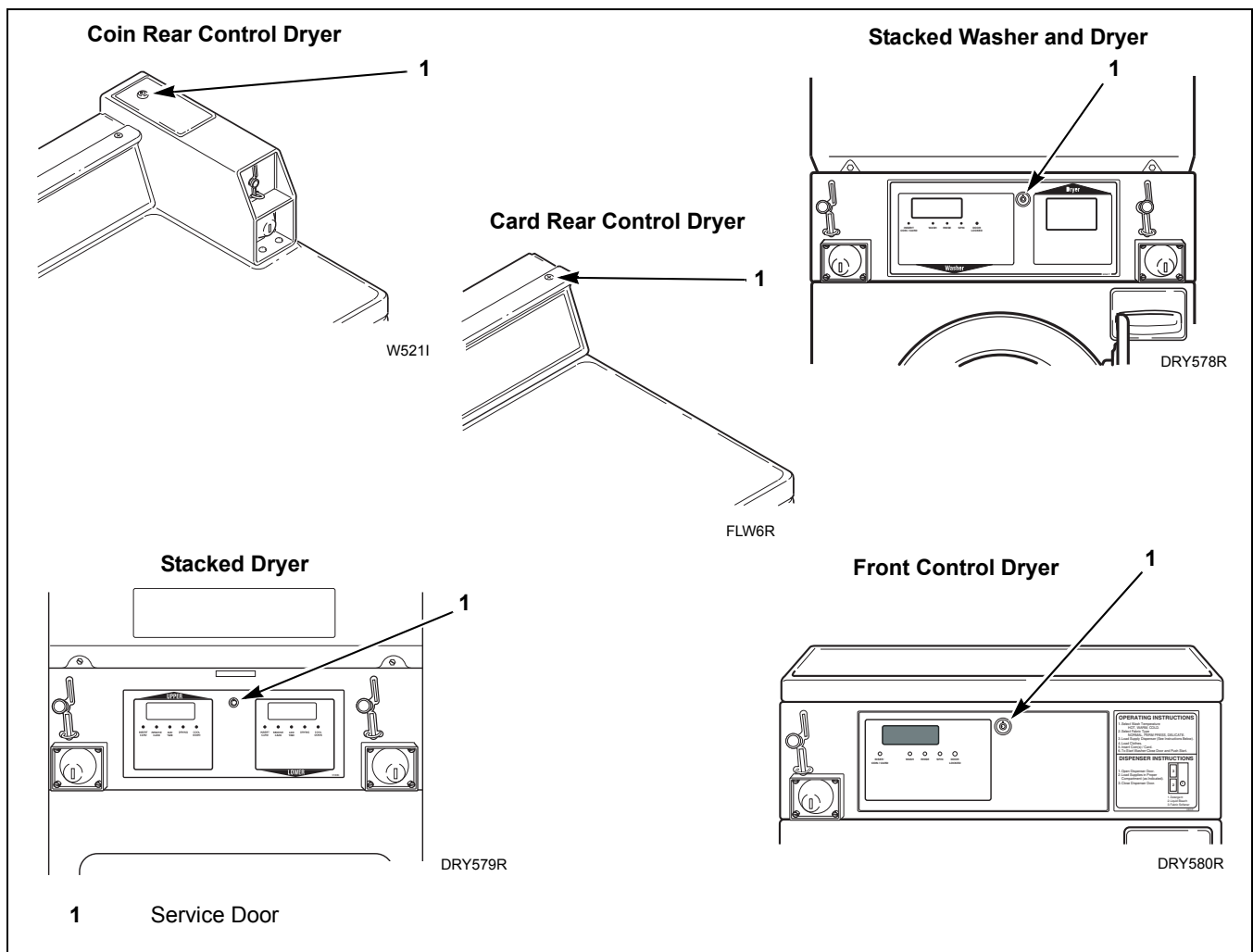

Figure 2

# Entering the Manual Mode

For programming, testing, and retrieving information from the control, it is often necessary to enter the Manual Mode by following the four simple steps below.

For an overview of entering the manual mode, refer to the flowchart on the following page.

## How to Enter the Manual Mode

1. If accessing Diagnostic Tests, be sure the dryer is in the Ready Mode before continuing to step 2. If the dryer is in an active cycle, rapid advance through the cycle. Refer to **Rapid Advance Feature**. If coins or a card has been entered, refer to **Clear Vend Feature**.
2. Open the service door. Refer to **Opening the Service Door**.

**NOTE: Coin Models – The coin vault switch must be closed to enter the Manual Mode. Card Reader Models – Unplug bullet connector.**

3. While pressing and holding the HIGH TEMP keypad with one hand, press the MED TEMP keypad with the other hand.
4. The display will show “rAPd”.
5. Press the LOW TEMP (^) or the DELICATES (v) keypad to scroll through the options until the desired option appears in the display.
6. Press the START (enter) keypad to enter the displayed mode.
7. To exit, press the MED TEMP(<) keypad. The control will revert back to Ready Mode.

Manual Programming can only be turned on or off with an external device or a network. Refer to the appropriate instruction manual. Manual Rapid Advance and Diagnostics can be turned on and off using an external device by manual programming (refer to *options 30 and 31 of Programming Control*), or with the network.

By default, Manual Programming is turned “ON”.

The manual features available in each group are as follows (the menu displayed on the display in this mode is in parenthesis).

Rapid Advance (rAPd)

Manual Programming (Prog)

Manual Read Audit (AUdt)

Manual Reset (rSEt)

Diagnostic Tests (diAg)

If a manual parameter is turned off or unavailable (i.e. attempting to enter diagnostics while a cycle is running), the display will change from the selected feature to “OFF”, an audio signal will sound for one second and the features in the parameter cannot be entered. The display will then return to the selected feature.

## Entering the Manual Mode

**Manual Mode:** Enter by opening and closing service door. Then press HIGH TEMP and MED TEMP keypads pads at same time.

To enter a programming option, press the START keypad. To exit, press the MED TEMP keypad.

Press the LOW TEMP or the DELICATES keypad to scroll through the Manual Mode options.

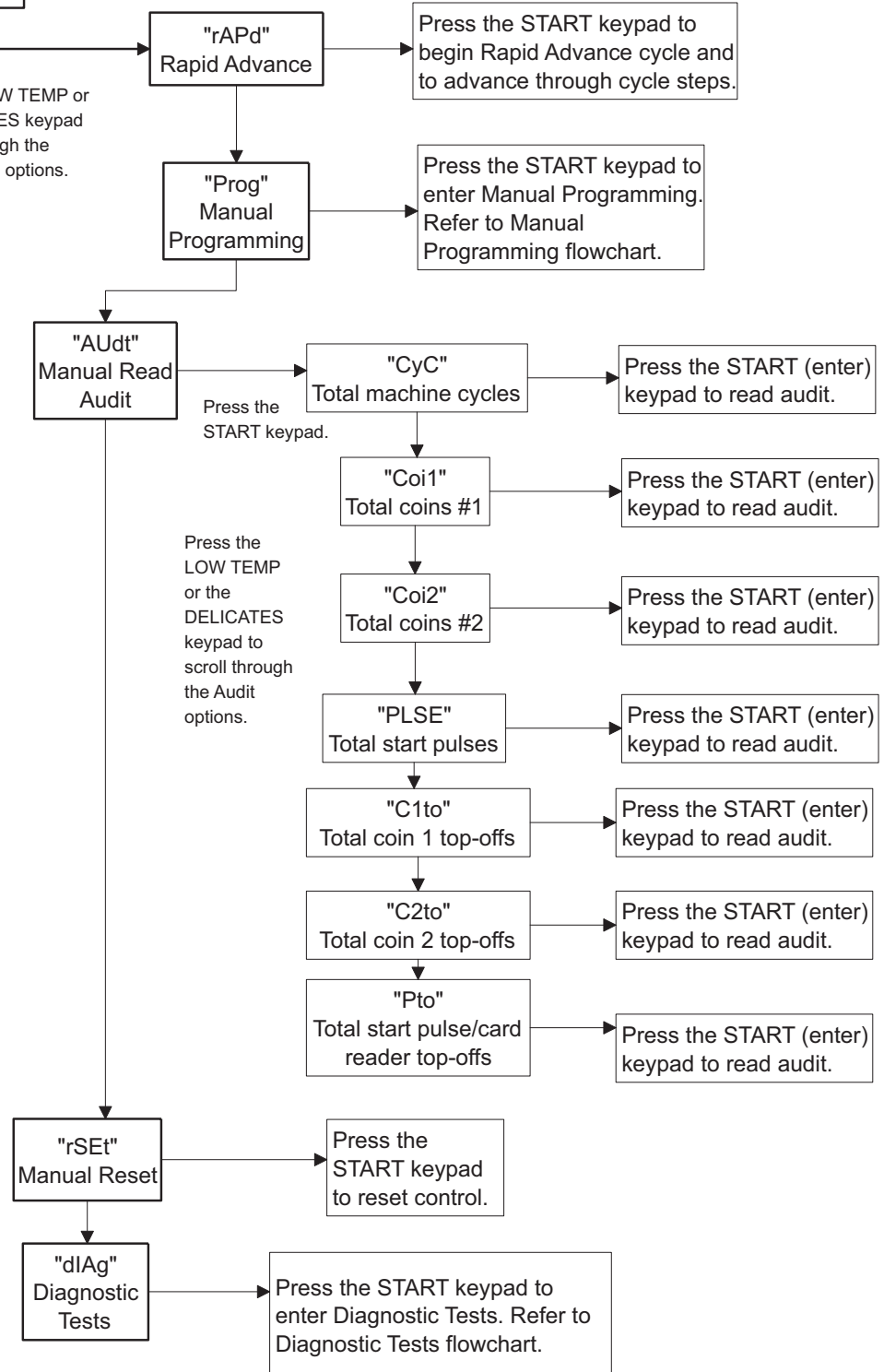

DRY581R



# Programming Control

## What Can Be Programmed?

This feature allows the owner to program cycle parameters, standard vend pricing, special vends, and other features by using the keypads. The control must have the Manual Programming Mode enabled, which is the factory default. This mode can only be turned OFF and ON by using an external device or a network. Refer to this section when programming the control.

This section offers a detailed description of all programmable options.

Each description includes instructions on when and why the option might be used and, more importantly, how to program the option.

For an overview of the programming organization, refer to the flowcharts on the following pages.

For more advanced users, a quick reference list of the options available through the programming mode is located on this page.

**NOTE: The codes in the Option column of the Programmable Options List are what will show in the display when that option is selected.**

## Programmable Options Available

Option Number	Option Display	Description	Default Value	Value Range
1	“AtSH”	Heat Vend Price	200	0-65535
2	“dEn1”	Coin #1 Value	25	1-65535
3	“dEn2”	Coin #2 Value	100	1-65535
4	“PLSE”	Start Pulse Value	25	1-65535
5	“PLSn”	Start Pulse Mode	128	128 (on - single pulse), 192 (on - multiple pulses) or oFF
6	“AtyP”	Available Type	0	** 0-3; 0-7
7	“dCyC”	Default Cycle	4	1 (High Temp), 2 (Low Temp), 3 (No Heat), 4 (Med Temp), or 5 (Delicates)
8	“oPL”	OPL Mode	oFF	on/oFF
9	“Aud” or “AUd”*	Audio	29	0-31
10	“CArd”	Card Reader Display Control	oFF	on/oFF
11	“Err-”	Errors	–	–
a	“CEr-”	Coin Error Parameters	–	–
1	“CEr1”	Coin Error	on	on/oFF
2	“CEr2”	Coin Error Penalty	oFF	on/oFF
3	“CEr3”	Coin Drops Header Present Error	on	on/oFF
12	“toP-”	Top-Off Data	–	–
a	“toP1”	Top-Off	on	on/oFF
b	“toP2”	Coin 1 Top-Off Time Minutes	5	1-99
c	“toP3”	Coin 1 Top-Off Time Seconds	38	0-59
d	“toP4”	Coin 2 Top-Off Time Minutes	22	1-99
e	“toP5”	Coin 2 Top-Off Time Seconds	30	0-59

\* “Aud” is displayed for Control Software version 01 and “AUd” is displayed for Control Software version 02 or later.

\*\* 0-7 is available in software version “S 05” or higher only.

## Programming Control

Option Number	Option Display	Description	Default Value	Value Range
<b>13</b>	<b>“CyC-”</b>	<b>Cycle Time</b>	–	–
a	“CyC1”	Heat Cycle Time Minutes	45	1-99
b	“CyC2”	Heat Cycle Time Seconds	0	0-59
c	“CyC3”	No Heat Cycle Time Minutes	45	1-99
d	“CyC4”	No Heat Cycle Time Seconds	0	0-59
<b>14</b>	<b>“Cdt-”</b>	<b>Cooldown Time</b>	–	–
a	“Cdt1”	High Temp Cooldown Time	3	1-15
b	“Cdt2”	Medium Temp Cooldown Time	3	1-15
c	“Cdt3”	Low Temp Cooldown Time	3	1-15
d	“Cdt4”	Delicates Temp Cooldown Time	3	1-15
<b>15</b>	<b>“tEP-”</b>	<b>Temperature</b>	–	–
a	“tEP1”	High Temperature	160°F/71°C	100°-160°F/38°-71°C
b	“tEP2”	Medium Temperature	155°F/68°C	100°-160°F/38°-71°C
c	“tEP3”	Low Temperature	145°F/62°C	100°-160°F/38°-71°C
d	“tEP4”	Delicates Temperature	115°F/46°C	100°-160°F/38°-71°C
<b>16</b>	<b>“t FC”</b>	<b>Temperature (Fahrenheit/Celsius)</b>	<b>0</b>	<b>0 (Fahrenheit)/1 (Celsius)</b>
<b>17</b>	<b>“AtSn”</b>	<b>No Heat Vend Price</b>	<b>200</b>	<b>0-65535</b>
<b>18</b>	<b>“rtC-”</b>	<b>Real Time Clock</b>	–	–
a	“rtC1”	Minutes	–	0-59
b	“rtC2”	Hours	–	0-23
c	“rtC3”	Day	–	1-7
d	“rtC4”	Date	–	1-31
e	“rtC5”	Month	–	1-12
f	“rtC6”	Year	–	0-99
g	“rtC7”	Daylight Savings	on	on/oFF
<b>19</b>	<b>“SPA-”</b>	<b>Special Vend A Data</b>	–	–
a	“SA01”	Days Enable	oFF	on/oFF
b	“SA02”	Start Hour	0	0-23
c	“SA03”	Start Minute	0	0-59
d	“SA04”	Length in Hours	0	0-24
e	“SA05”	Start Month	0	0/1-12
f	“SA06”	Start Date	0	0/1-31
g	“SA07”	Start Year	0	0-99
h	“SA08”	End Month	0	0/1-12
i	“SA09”	End Date	0	0/1-31
j	“SA10”	End Year	0	0-99
k	“SA11”	Heat Price	0	0-65535
l	“SA12”	No Heat Price	0	0-65535
m	“SA13”	Heat Time Minutes	1	1-99
n	“SA14”	No Heat Time Minutes	1	1-99
o	“SA15”	Coin #1 Top-Off Time Minutes	1	1-99
p	“SA16”	Coin #2 Top-Off Time Minutes	1	1-99

Option Number	Option Display	Description	Default Value	Value Range
20	“SPb-”	Special Vend B Days Enable	oFF	on/oFF
21	“SPC-”	Special Vend C Days Enable	oFF	on/oFF
22	“SPd-”	Special Vend D Days Enable	oFF	on/oFF
23	“droP”	Drop Off Mode	oFF	on/oFF
24	“LPSA”	Low Power/Auto Shutdown A Days Enable	oFF	on/oFF
25	“LPSb”	Low Power/Auto Shutdown B Days Enable	oFF	on/oFF
26	“LPSC”	Low Power/Auto Shutdown C Days Enable	oFF	on/oFF
27	“LPSd”	Low Power/Auto Shutdown D Days Enable	oFF	on/oFF
28	“PFr”	Power Fail Reset	oFF	on (133 [5 minutes] - 255 [127 minutes])/oFF
29	“lrA”	IR Access	on	on/oFF
30	“rAEn”	Manual Rapid Advance	on	on/oFF
31	“dAEn”	Manual Diagnostics	on	on/oFF
32	“PtEn”	Production Test Cycle	on	on/oFF

# Programming Control

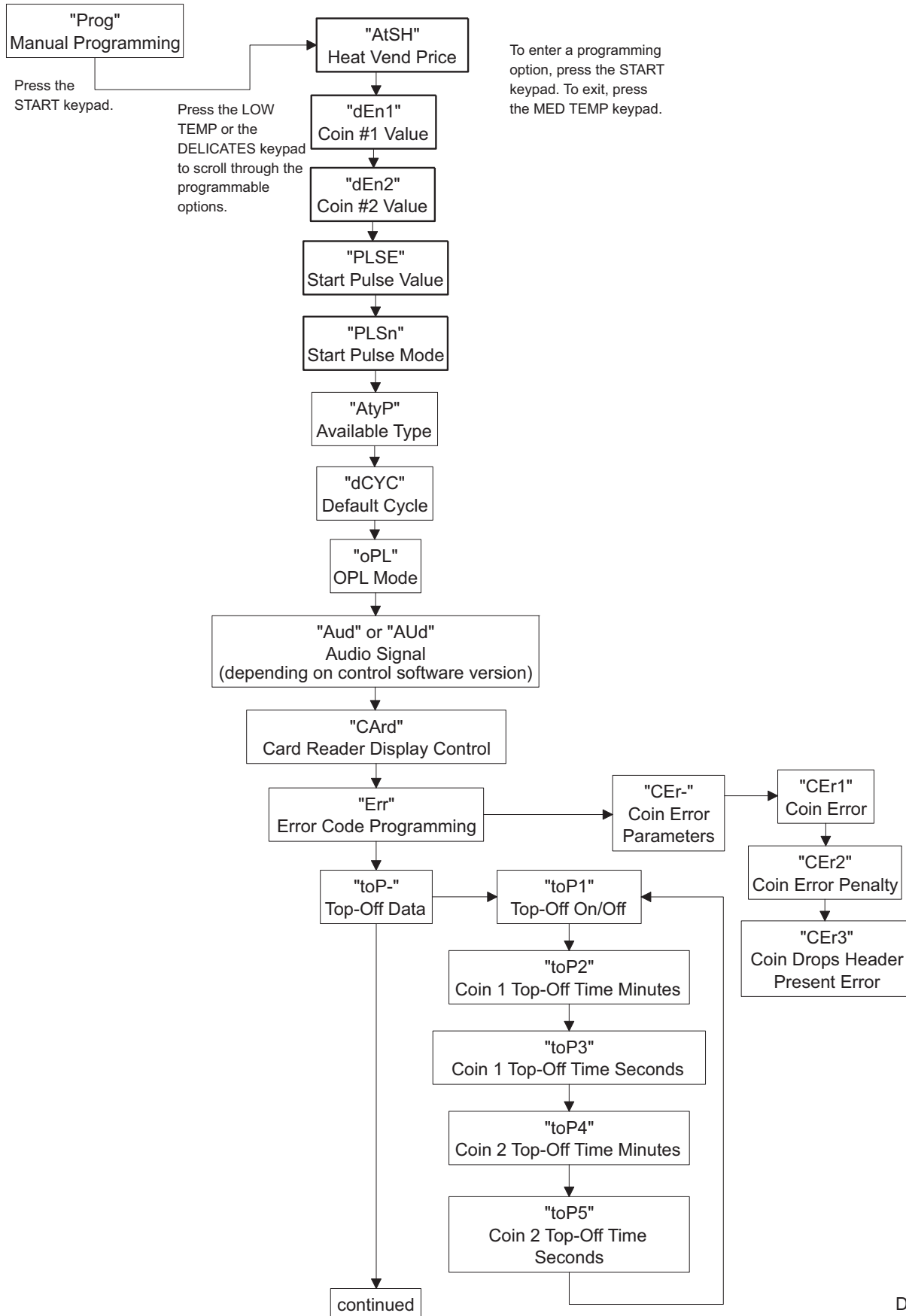

DRY582R-a

Press the LOW TEMP or the DELICATES keypad to scroll through the programmable options.

To enter a programming option, press the START keypad. To exit, press the MED TEMP keypad.

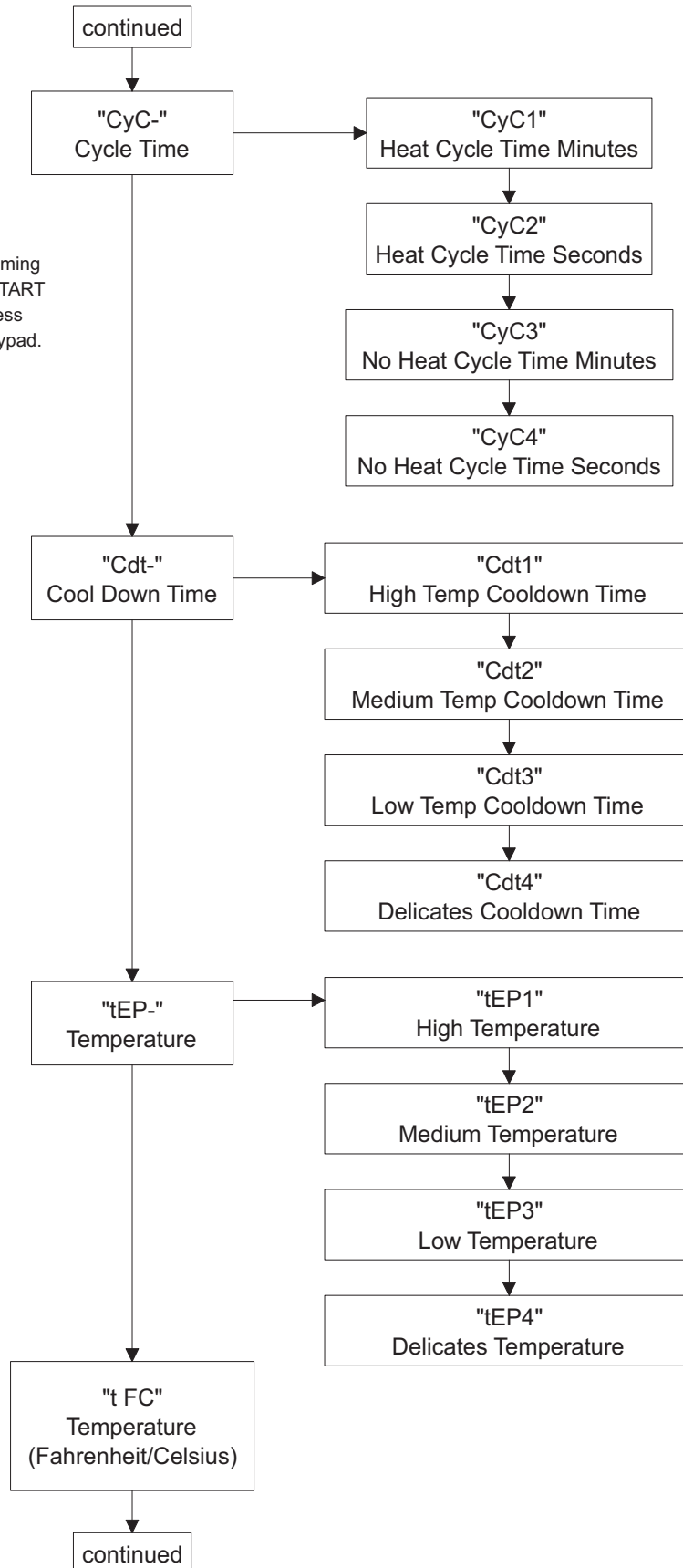

DRY582R-b

# Programming Control

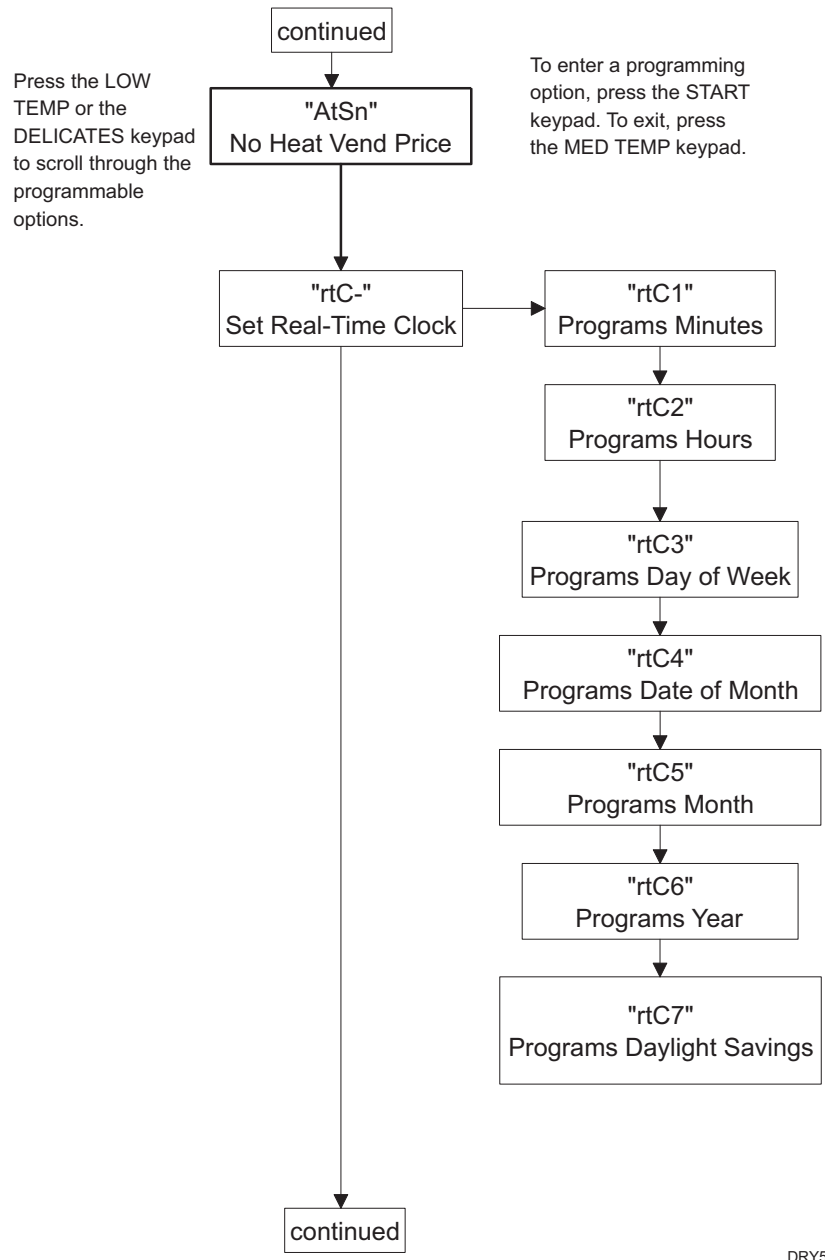

DRY582R-c

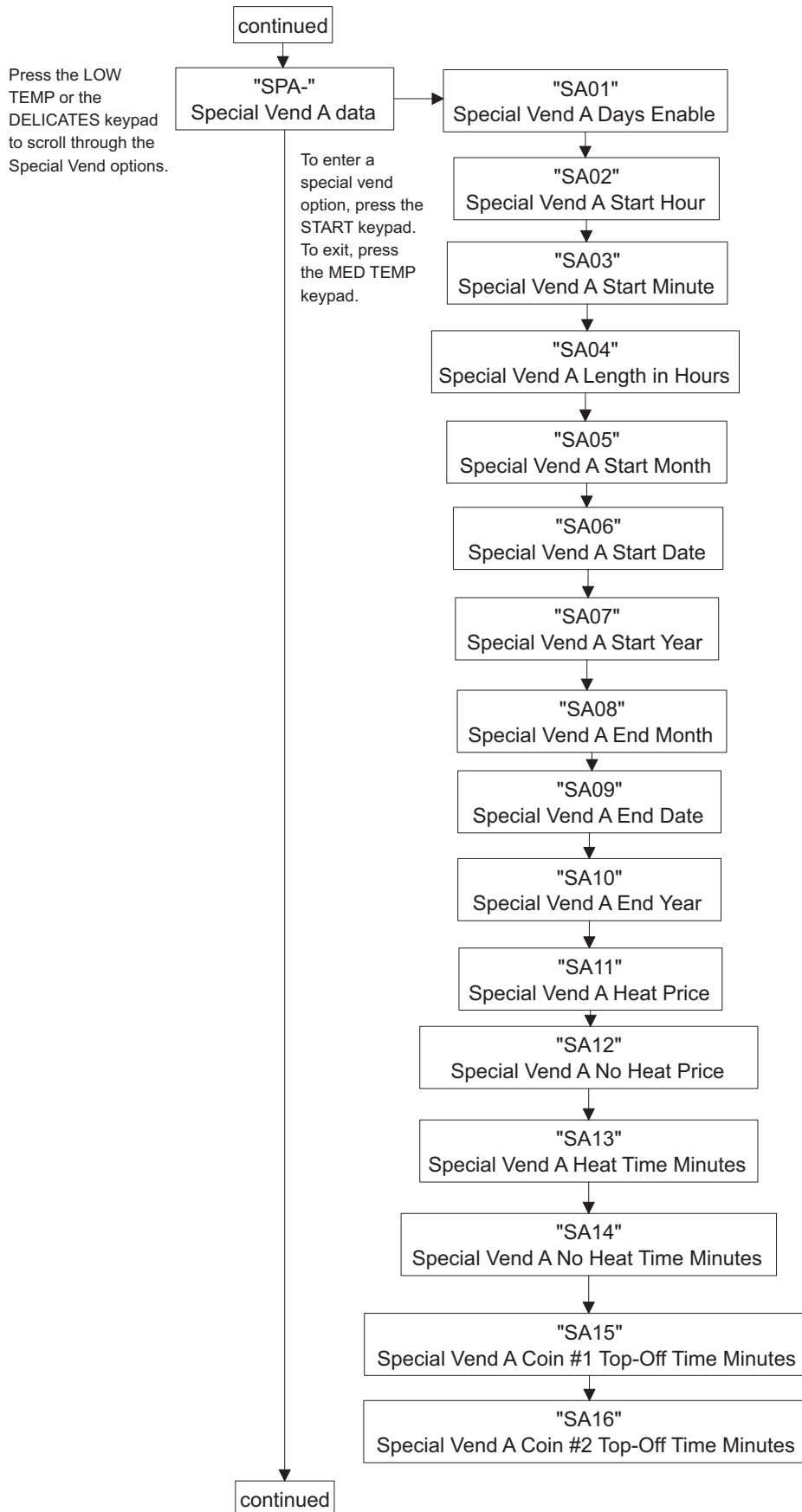

DRY582R-d

## Programming Control

Press the LOW TEMP or the DELICATES keypad to scroll through the programmable options.

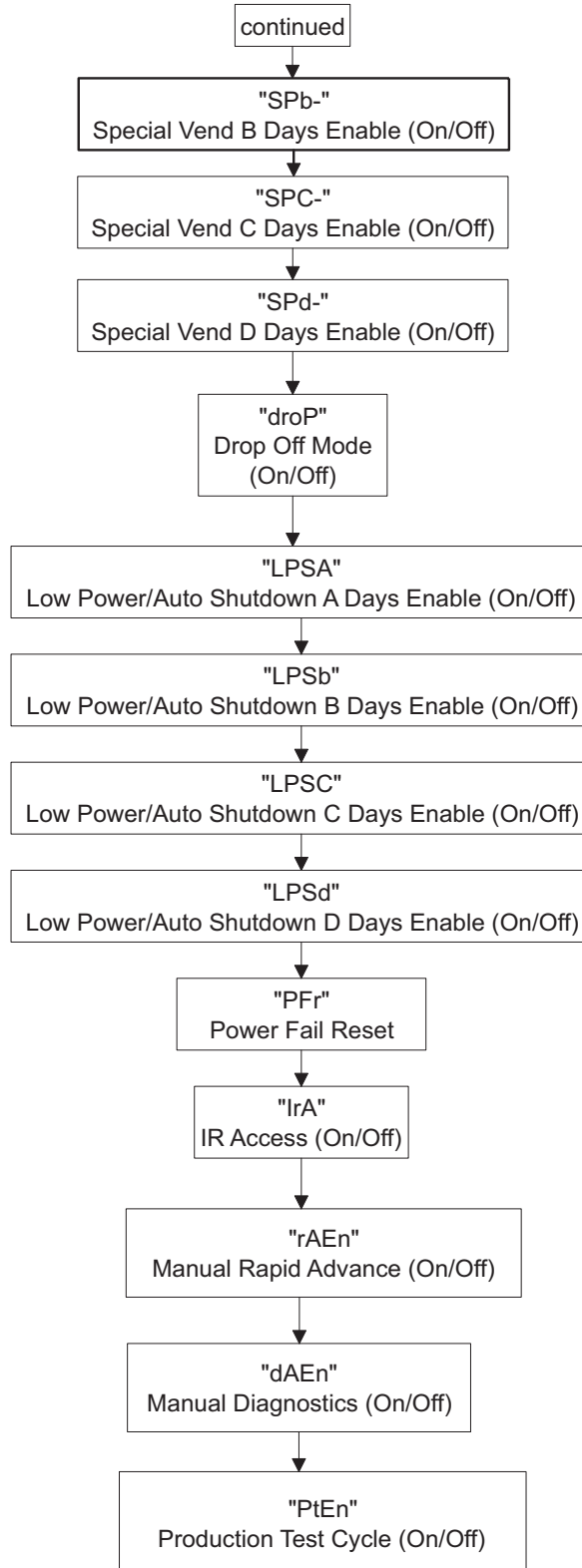

To enter a programming option, press the START keypad. To exit, press the MED TEMP keypad.

DRY582R-e



## 1. Heat Vend Price “AtSH”

This option allows the owner to set the vend price for a heated cycle. This vend price will be shown in the display when in Ready Mode.

### How to Program Heat Vend Price

1. Control must be in Manual Mode. Refer to *Entering the Manual Mode*.
2. Press the LOW TEMP (^) or the DELICATES (v) keypad until “Prog” appears in the display. Press the START (enter) keypad.
3. “AtSH” will appear in the display. Press the START (enter) keypad.
4. There are five digits in the Heat Vend Price. The fifth digit will appear in the display and will flash one second on, one second off.

**NOTE: If the vend price is \$100.00 or more, the fifth digit is “1-6”. If the vend price is \$99.99 or less, the fifth digit is “0”.**



Figure 3

5. Press the LOW TEMP (^) or the DELICATES (v) keypad to increase or decrease the value of the fifth digit.

**NOTE: The vend price can be set from 0 to 65,535. The default value is 200.**

6. Press the START (enter) keypad to enter the fifth digit and display remaining four digits. The active digit will flash one second on and one second off.

**NOTE: To go back to the current programmable option without changing the value press the MED TEMP (<) keypad.**

7. Press the LOW TEMP (^) or the DELICATES (v) keypad to increase or decrease the value of the active digit and the START (enter) keypad to enter the value of the digit and advance to the next digit.
8. Press the START (enter) keypad with the last active digit. The new value is saved and the next option, “dEn1”, will appear in the display.

**NOTE: To program “dEn1” (Coin #1 Value), refer to *option 2*. To program other options, refer to the appropriate section.**

### How to Exit Programming Feature

Press the MED TEMP (<) keypad until the control returns to Ready Mode.

## Programming Control

### 2. Coin #1 Value “dEn1”

This option allows the owner to set a specific numerical value for a coin entered. For example, in the United States the coin value for one quarter would be measured in cents (25). Therefore, the coin value entered for one quarter would 00025.

If the Heat Vend Price (*option 1*) is set for “150”, and the Coin #1 Value is set for “00025”, the vend price displayed will decrease by 25 for each coin entered into coin drop #1.

#### How to Program Coin #1 Value

1. Control must be in Manual Mode. Refer to *Entering the Manual Mode*.
2. Press the LOW TEMP (^) or the DELICATES (v) keypad until “Prog” appears in the display. Press the START (enter) keypad and “AtSH” will appear in the display.
3. Press the LOW TEMP (^) or the DELICATES (v) keypad to scroll through the programmable options until “dEn1” appears in the display.
4. When “dEn1” appears in the display, press the START (enter) keypad. There are five digits in the Coin #1 Value. The fifth digit will appear in the display and will flash one second on, one second off. Refer to *Figure 4*.

**NOTE: If the coin value is \$100.00 or more, the fifth digit is “1-6”. If the vend price is \$99.99 or less, the fifth digit is “0”.**

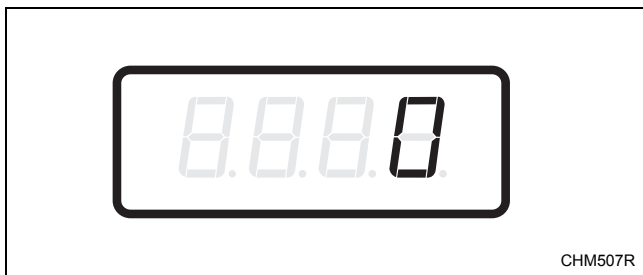

Figure 4

5. Press the LOW TEMP (^) or the DELICATES (v) keypad to increase or decrease the value of the fifth digit.

**NOTE: The coin value can be set from 1 to 65,535. The default value is 25.**

6. Press the START (enter) keypad to enter the fifth digit and display remaining four digits. The active digit will flash one second on and one second off.

**NOTE: To go back to the current programmable option without changing the value press the MED TEMP (<) keypad.**

7. Press the LOW TEMP (^) or the DELICATES (v) keypad to increase or decrease the value of the active digit and the START (enter) keypad to enter the value of the digit and advance to the next digit.
8. Press the START (enter) keypad with the last active digit. The new value is saved and the next option, “dEn2”, will appear in the display.

**NOTE: To program “dEn2” (Coin #2 Value), refer to *option 3*. To program other options, refer to the appropriate section.**

#### How to Exit Programming Feature

Press the MED TEMP (<) keypad until the control returns to Ready Mode.

### 3. Coin #2 Value “dEn2”

This option allows the owner to set a specific numerical value for a coin entered when using the dual coin drop. For example, the coin value for a dollar coin would be measured in cents (100). Therefore, the coin value entered for one dollar coin would be 00100.

If the Heat Vend Price (*option 1*) is set for “200”, and the Coin #2 Value is set for “00100”, the vend price displayed will decrease by 100 for each dollar coin entered in coin drop #2.

#### How to Program Coin #2 Value

1. Control must be in Manual Mode. Refer to *Entering the Manual Mode*.
2. Press the LOW TEMP (^) or the DELICATES (v) keypad until “Prog” appears in the display. Press the START (enter) keypad and “AtSH” will appear in the display.
3. Press the LOW TEMP (^) or the DELICATES (v) keypad to scroll through the programmable options until “dEn2” appears in the display.
4. When “dEn2” appears in the display, press the START (enter) keypad. There are five digits in the Coin #2 Value. The fifth digit will appear in the display and will flash one second on and one second off. Refer to *Figure 5*.

**NOTE: If the coin value is \$100.00 or more, the fifth digit is “1-6”. If the coin value is \$99.99 or less, the fifth digit is “0”.**

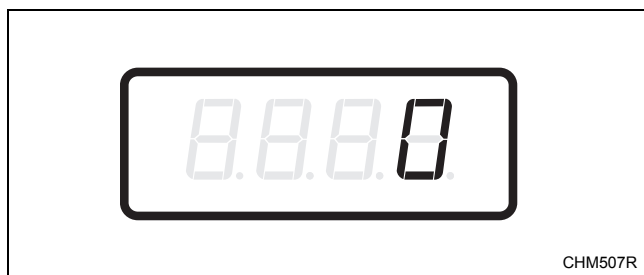

Figure 5

5. Press the LOW TEMP (^) or the DELICATES (v) keypad to increase or decrease the value of the fifth digit.

**NOTE: The coin value can be set from 1 to 65,535. The default value is 100.**

6. Press the START (enter) keypad to enter the fifth digit and display remaining four digits. The active digit will flash one second on and one second off.

**NOTE: To go back to the current programmable option without changing the value press the MED TEMP (<) keypad.**

7. Press the LOW TEMP (^) or the DELICATES (v) keypad to increase or decrease the value of the active digit and the START (enter) keypad to enter the value of the digit and advance to the next digit.
8. Press the START (enter) keypad with the last active digit. The new value is saved and the next option, “PLSE”, will appear in the display.

**NOTE: To program “PLSE” (Start Pulse Value), refer to *option 4*. To program other options, refer to the appropriate section.**

#### How to Exit Programming Feature

Press the MED TEMP (<) keypad until the control returns to Ready Mode.

## Programming Control

### 4. Start Pulse Value “PLSE”

This option allows the owner to program the value of the Start Pulse if used for multiple pulses with an after-market central card reader or pay system. Refer to *option 5* for additional information.

#### How to Program Start Pulse Value

1. Control must be in Manual Mode. Refer to *Entering the Manual Mode*.
2. Press the LOW TEMP (^) or the DELICATES (v) keypad until “Prog” appears in the display. Press the START (enter) keypad and “AtSH” will appear in the display.
3. Press the LOW TEMP (^) or the DELICATES (v) keypad to scroll through the programmable options until “PLSE” appears in the display.
4. When “PLSE” appears in the display, press the START (enter) keypad. There are five digits in the Start Pulse Value. The fifth digit will appear in the display and will flash one second on and one second off. Refer to *Figure 6*.

**NOTE: If the Start Pulse Value is \$100.00 or more, the fifth digit is “1-6”. If the Start Pulse Value is \$99.99 or less, the fifth digit is “0”.**

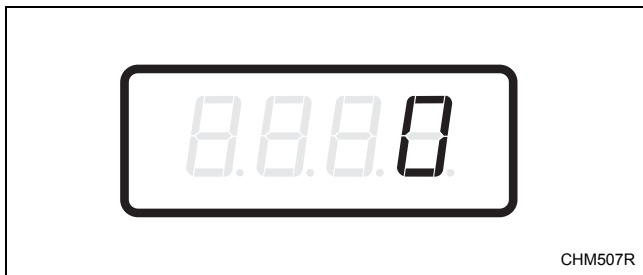

Figure 6

5. Press the LOW TEMP (^) or the DELICATES (v) keypad to increase or decrease the value of the fifth digit.

**NOTE: The Start Pulse Value can be set from 1 to 65,535. The default value is 25.**

6. Press the START (enter) keypad to enter the fifth digit and display remaining four digits. The active digit will flash one second on and one second off.

**NOTE: To go back to the current programmable option without changing the value press the MED TEMP (<) keypad.**

7. Press the LOW TEMP (^) or the DELICATES (v) keypad to increase or decrease the value of the active digit and the START (enter) keypad to enter the value of the digit and advance to the next digit.
8. Press the START (enter) keypad with the last active digit. The new value is saved and the next option, “PLSn”, will appear in the display.

**NOTE: To program “PLSn” (Start Pulse Mode), refer to *option 5*. To program other options, refer to the appropriate section.**

#### How to Exit Programming Feature

Press the MED TEMP (<) keypad until the control returns to Ready Mode.

## 5. Start Pulse Mode “PLSn”

This option allows the owner to program the Start Pulse Input. The Start Pulse Mode can be used for after-market central pay or card systems. The central system sends the start pulse to the Start Pulse Input of the control to start the cycle. If set for single pulse, one start pulse from the central system will start the cycle. If set for multiple pulses, each pulse will deduct from the vend price the value set up in *option 4 (Start Pulse Value)* until the vend is satisfied.

### How to Program Start Pulse Mode

1. Control must be in Manual Mode. Refer to *Entering the Manual Mode*.
2. Press the LOW TEMP (^) or the DELICATES (v) keypad until “Prog” appears in the display. Press the START (enter) keypad and “AtSH” will appear in the display.
3. Press the LOW TEMP (^) or the DELICATES (v) keypad to scroll through the programmable options until “PLSn” appears in the display.
4. When “PLSn” appears in the display, press the START (enter) keypad. A number, or “oFF”, will appear in the display. The number corresponds to the current Start Pulse Mode Programming Value.

5. Locate the desired number in the first column of *Table 1* below.

“PLSn”		
Start Pulse Mode Value	Start Pulse ON/OFF	Single Pulse/ Multiple Pulses
oFF	OFF	Single Pulse
128	ON	Single Pulse
192	ON	Multiple Pulses

Table 1

**NOTE: The default value is 128.**

6. Press the LOW TEMP (^) or the DELICATES (v) keypad to increase or decrease the current number until correct.

**NOTE: To go back to the current programmable option without changing the value press the MED TEMP (<) keypad.**

7. Press the START (enter) keypad when the correct number appears in the display. The new value is saved and the next option, “AtyP” will appear in the display.

**NOTE: To program “AtyP” (Available Type), refer to *option 6*. To program other options, refer to the appropriate section.**

### How to Exit Programming Feature

Press the MED TEMP (<) keypad until the control returns to Ready Mode.

## 6. Available Type “AtyP”

This option allows the owner to program when the control provides an available output for card and central pay systems.

### How to Program Available Type

1. Control must be in Manual Mode. Refer to *Entering the Manual Mode*.
2. Press the LOW TEMP (^) or the DELICATES (v) keypad until “Prog” appears in the display. Press the START (enter) keypad and “AtSH” will appear in the display.
3. Press the LOW TEMP (^) or the DELICATES (v) keypad to scroll through the programmable options until “AtyP” appears in the display.
4. When “AtyP” appears in the display, press the START (enter) keypad. A number will appear in the display. This number corresponds to the current Available Type Value.

5. Press the LOW TEMP (^) or the DELICATES (v) keypad to increase or decrease the current number to the desired number selected from *Table 2*.

Available Type Value	Mode(s) in Which Available Signal is Active
0	Ready Mode only
1	Ready Mode, Partial Vend Mode
2	Ready Mode, End of Cycle Mode
3	Ready Mode, End of Cycle Mode, Partial Vend Mode.
4*	Ready Mode, Start Mode
5*	Ready Mode, Partial Vend Mode, Start Mode
6*	Ready Mode, End of Cycle Mode, Start Mode
7*	Ready Mode, End of Cycle Mode, Partial Vend Mode, Start Mode

\*Available in software version “S 05” or higher only.

Table 2

**NOTE: The default value is 0.**

6. Press the START (enter) keypad when the correct number appears in the display. The new value is saved and the next option, “dCYC”, will appear in the display.

**NOTE: To program “dCYC” (Default Cycle), refer to *option 7*. To program other options, refer to the appropriate section.**

### How to Exit Programming Feature

Press the MED TEMP (<) keypad until the control returns to Ready Mode.

## 7. Default Cycle “dCYC”

This option allows the owner to set the default cycle the machine will enter when in the Ready Mode. When programming the default cycle, refer to *Table 3*.

### How to Program Default Cycle

1. Control must be in Manual Mode. Refer to *Entering the Manual Mode*.
2. Press the LOW TEMP (Λ) or the DELICATES (∨) keypad until “Prog” appears in the display. Press the START (enter) keypad and “AtSH” will appear in the display.
3. Press the LOW TEMP (Λ) or the DELICATES (∨) keypad to scroll through the programmable options until “dCYC” appears in the display.
4. When “dCYC” appears in the display, press the START (enter) keypad. A number will appear in the display. This number corresponds to the current default cycle value. Refer to *Table 3*.
5. Press the LOW TEMP (Λ) or the DELICATES (∨) keypad to increase or decrease the current number to the desired number selected from *Table 3*.
6. Press the START (enter) keypad when the correct number appears in the display. The new value is saved and the next option, “oPL”, will appear in the display.

**NOTE: To program “oPL” (OPL Mode), refer to option 8. To program other options, refer to the appropriate section.**

### How to Exit Programming Feature

Press the MED TEMP (<) keypad until the control returns to Ready Mode.

### How to Read *Table 3*

To determine the correct number required to program Default Cycle, use the following table. The Default Value column contains the number required in step 5.

The corresponding cycle LED will be lit while selecting a default cycle. For example, when the display shows “5”, the Delicates LED is lit.

“dCYC”	
Default Cycle Value	Cycle Type
1	HIGH TEMP
2	LOW TEMP
3	NO HEAT
4	MED TEMP
5	DELICATES

Table 3

**NOTE: The default cycle programmed at the factory is 4, Med Temp.**

## Programming Control

### 8. OPL Mode Enable/Disable “oPL”

This option allows the owner to enable or disable the OPL Mode in which no vend price needs to be satisfied to operate the machine.

#### How to Program the OPL Mode Enable/Disable

1. Control must be in Manual Mode. Refer to *Entering the Manual Mode*.
2. Press the LOW TEMP (^) or the DELICATES (v) keypad until “Prog” appears in the display. Press the START (enter) keypad and “AtSH” will appear in the display.
3. Press the LOW TEMP (^) or the DELICATES (v) keypad to scroll through the programmable options until “oPL” appears in the display.
4. When “oPL” appears in the display, press the START (enter) keypad. The current OPL Mode Enable/Disable status will appear in the display.  
“on” = Option Enabled  
“oFF” = Option Disabled

**NOTE: The default value is “oFF”.**

5. Press the LOW TEMP (^) or the DELICATES (v) keypad to change the current status.
6. Press the START (enter) keypad when the desired status appears in the display. The new value is saved and the next option, “Aud” or “AUd” (depending on control software version), will appear in the display.

**NOTE: To program “Aud” or “AUd” (depending on control software version) (Audio Signal), refer to *option 9*. To program other options, refer to the appropriate section.**

#### How to Exit Programming Feature

Press the MED TEMP (<) keypad until the control returns to Ready Mode.



## 9. Audio Signal “Aud” or “AUd”\*

\* “Aud” is displayed for control software version 01 and “AUd” is displayed for control software version 02 or later.

This option allows the owner to program when the signal will sound.

There are six occasions when a signal may sound during the dryer operation. These six occasions are listed below:

1. **End of Cycle Signal**  
By default, the signal is turned off. If turned on, the signal will sound for three seconds at the end of a cycle.
2. **Keypad Depression Signal**  
By default, this signal is turned on and will sound for a quarter of a second. This signal will sound each time a keypad is pressed.
3. **Coin Input/Card Insertion Signal**  
By default, this signal is turned on and will sound for a quarter of a second each time a coin or card is entered.
4. **Remove Card Signal (Card Models Only)**  
By default, this signal is turned on and will sound one second on and one second off when the control is prompting for card removal.
5. **Signal for Start**  
By default, this signal is turned on and will sound one second on and one second off for 10 seconds when START LED is flashing after vend price has been satisfied.
6. **Extended Tumble Mode Signal**  
This signal cannot be disabled. While in extended tumble mode, the signal will sound one second on and one second off for five seconds and then continuously for five seconds before starting the extended tumble.

## How to Program the Audio Signal

1. Control must be in Manual Mode. Refer to *Entering the Manual Mode*.
2. Press the LOW TEMP (Λ) or the DELICATES (∨) keypad until “Prog” appears in the display. Press the START (enter) keypad and “AtSH” will appear in the display.
3. Press the LOW TEMP (Λ) or the DELICATES (∨) keypad to scroll through the programmable options until “Aud” or “AUd” (depending on control software version) appears in the display.
4. When “Aud” or “AUd” appears in the display press the START (enter) keypad. A number will appear in the display. This number corresponds to the current Audio Signal Programming Value.
5. Locate the desired number in the first column of *Table 4* on the following page.
6. Press the LOW TEMP (Λ) or the DELICATES (∨) keypad to increase or decrease the current number until correct.

For Example: A user might wish to have the signal sound only when a keypad is pressed. Entering the number “1” in step 5 would turn off all the options except KEYPAD. In this instance, the signal would sound only when a keypad is pressed.

7. Press the START (enter) keypad when the correct number appears in the display. The new value is saved and the next option, “CArd”, will appear in the display.

**NOTE: To program “CArd” (Card Reader Display Control), refer to *option 10*. To program other options, refer to the appropriate section.**

## How to Exit Programming Feature

Press the MED TEMP (<) keypad until the control returns to Ready Mode.

## Programming Control

### How to Read *Table 4*

To determine the correct number required to program the Audio Signal, use the following chart. The Signal Value column contains the number required in step 6. The other columns correspond to individual options.

Each column of options contains a unique combination of the words “ON” and “OFF” that indicates if that column’s option is turned on or off when the Signal Value is entered. Select the desired combination of options and enter the number found in the Signal Value column.

**NOTE: The default setting programmed at the factory is 29.**

Signal Value	Start Mode	Remove Card	Coin/ Card Input	End of Cycle	Key Pressed
0	OFF	OFF	OFF	OFF	OFF
1	OFF	OFF	OFF	OFF	ON
2	OFF	OFF	OFF	ON	OFF
3	OFF	OFF	OFF	ON	ON
4	OFF	OFF	ON	OFF	OFF
5	OFF	OFF	ON	OFF	ON
6	OFF	OFF	ON	ON	OFF
7	OFF	OFF	ON	ON	ON
8	OFF	ON	OFF	OFF	OFF
9	OFF	ON	OFF	OFF	ON
10	OFF	ON	OFF	ON	OFF
11	OFF	ON	OFF	ON	ON
12	OFF	ON	ON	OFF	OFF
13	OFF	ON	ON	OFF	ON
14	OFF	ON	ON	ON	OFF
15	OFF	ON	ON	ON	ON
16	ON	OFF	OFF	OFF	OFF
17	ON	OFF	OFF	OFF	ON
18	ON	OFF	OFF	ON	OFF
19	ON	OFF	OFF	ON	ON
20	ON	OFF	ON	OFF	OFF
21	ON	OFF	ON	OFF	ON
22	ON	OFF	ON	ON	OFF
23	ON	OFF	ON	ON	ON
24	ON	ON	OFF	OFF	OFF
25	ON	ON	OFF	OFF	ON
26	ON	ON	OFF	ON	OFF
27	ON	ON	OFF	ON	ON
28	ON	ON	ON	OFF	OFF
29	ON	ON	ON	OFF	ON
30	ON	ON	ON	ON	OFF
31	ON	ON	ON	ON	ON

Table 4

## 10. Card Reader Display Control “CArd”

This option allows the owner to program whether the display is controlled by the machine’s electronic control or by the card reader.

**NOTE: This feature does not need to be programmed manually. The card reader itself makes this determination.**

### How to Program the Card Reader Display Control

1. Control must be in Manual Mode. Refer to *Entering the Manual Mode*.
2. Press the LOW TEMP (^) or the DELICATES (v) keypad until “Prog” appears in the display. Press the START (enter) keypad and “AtSH” will appear in the display.
3. Press the LOW TEMP (^) or the DELICATES (v) keypad to scroll through the programmable options until “CArd” appears in the display.
4. When “CArd” appears in the display, press the START (enter) keypad. The current Card Reader Display Control status will appear in the display.  
 “on” = Card Reader controls display  
 “oFF” = Machine Electronic Control controls display

**NOTE: The default value is “oFF”.**

5. Press the LOW TEMP (^) or the DELICATES (v) keypad to change the current status.
6. Press the START (enter) keypad when the desired status appears in the display. The new value is saved and the next option, “Err-”, will appear in the display.

**NOTE: To program “Err-” (Error Code Programming), refer to *option 11*. To program other options, refer to the appropriate section.**

### How to Exit Programming Feature

Press the MED TEMP (<) keypad until the control returns to Ready Mode.

## 11. Error Code Programming “Err-”

This option allows the owner to turn on or turn off certain errors in the control.

### How to Program Error Code Programming

1. Control must be in Manual Mode. Refer to *Entering the Manual Mode*.
2. Press the LOW TEMP (Λ) or the DELICATES (∇) keypad until “Prog” appears in the display. Press the START (enter) keypad and “AtSH” will appear in the display.
3. Press the LOW TEMP (Λ) or the DELICATES (∇) keypad to scroll through the programmable options until “Err-” appears in the display.
4. When “Err-” appears in the display, press the START (enter) keypad. The control will display “CEr-”. Press the START (enter) keypad. The control will display “CEr1”. Refer to *Table 5*.

“CEr-”	Coin Error Parameters	
	“CEr1”	Coin Error – Determines if display will show error.
	“CEr2”	Coin Error Penalty – If enabled, coin error will erase previous coins entered and reset the vend price.
	“CEr3”	Coin Drops Header Present Error – If enabled and coin drop header is unplugged, control ignores coin inputs.

Table 5

5. Press the LOW TEMP (Λ) or the DELICATES (∇) keypad to select error code.
6. Press the START (enter) keypad when the correct code appears in the display. The current status will appear in the display.
7. “oFF” indicates the option is disabled. “on” indicates the option is enabled. Press the LOW TEMP (Λ) or the DELICATES (∇) keypad to change the status.

**NOTE: The default values for Coin Error and Coin Drops Header are on. The default value for Coin Error Penalty is oFF.**

8. Press the START (enter) keypad when the correct status appears in the display. The new value is saved and the next option in the parameter will appear in the display.

**NOTE: To program the next option, “toP-” (Top-Off Data), press the MED TEMP (<) keypad until “Err-” is displayed, then press the LOW TEMP (Λ) or DELICATES (∇) keypad until “toP-” appears in the display and refer to *option 12*. To program other options, refer to the appropriate section.**

### How to Exit Programming Feature

Press the MED TEMP (<) keypad until the control returns to Ready Mode.

## 12. Top-Off Data “toP-”

This option allows the owner to set the amount of top-off time for Coin #1 and Coin #2.

### How to Program Top-Off Data (Minutes Per Coin)

1. Control must be in Manual Mode. Refer to *Entering the Manual Mode*.
2. Press the LOW TEMP (Λ) or the DELICATES (√) keypad until “Prog” appears in the display. Press the START (enter) keypad and “AtSH” will appear in the display.
3. Press the LOW TEMP (Λ) or the DELICATES (√) keypad to scroll through the programmable options until “toP-” appears in the display.
4. When “toP-” appears in the display, press the START (enter) keypad. There are five programmable top-off options. Refer to *Table 6*.

Display	Top-Off Options
“toP1”	Top-Off ON/OFF
“toP2”	Coin 1 Top-Off Time Minutes
“toP3”	Coin 1 Top-Off Time Seconds
“toP4”	Coin 2 Top-Off Time Minutes
“toP5”	Coin 2 Top-Off Time Seconds

Table 6

**NOTE: If Top-Off is enabled, each coin entered will add a top-off time. If Top-Off is disabled, the full vend price must be entered to add time.**

5. Press the LOW TEMP (Λ) or the DELICATES (√) keypad to select the desired top-off option.
6. Press the START (enter) keypad when the correct option appears in the display.
7. Press the LOW TEMP (Λ) or the DELICATES (√) keypad to increase or decrease the number of minutes or seconds displayed to the desired number of minutes or seconds.

**NOTE: Top-Off minutes can be set from one (1) to 99 minutes and Top-Off seconds can be set from 0-59 seconds. The maximum amount of time for a cycle, including the top-off time, is 99 minutes.**

**NOTE: Top-Off is on by default. The default values for each option are as follows:**

- Coin 1 Top-Off Time Minutes = 5**
- Coin 1 Top-Off Time Seconds = 38**
- Coin 2 Top-Off Time Minutes = 22**
- Coin 2 Top-Off Time Seconds = 30**

8. Press the START (enter) keypad when the correct number of minutes or seconds appears in the display. The new value is saved and the next option in the parameter will appear in the display.

**NOTE: To program the next option, “CyC-” (Cycle Time), press the MED TEMP (<) keypad until “toP-” is displayed, then press the LOW TEMP (Λ) or DELICATES (√) keypad until “CyC-” appears in the display and refer to *option 13*. To program other options, refer to the appropriate section.**

### How to Exit Programming Feature

Press the MED TEMP (<) keypad until the control returns to Ready Mode.

### 13. Cycle Time “CyC-”

This option allows the owner to set the amount of time for all cycles.

#### How to Program Cycle Time

1. Control must be in Manual Mode. Refer to *Entering the Manual Mode*.
2. Press the LOW TEMP (^) or the DELICATES (v) keypad until “Prog” appears in the display. Press the START (enter) keypad and “AtSH” will appear in the display.
3. Press the LOW TEMP (^) or the DELICATES (v) keypad to scroll through the programmable options until “CyC-” appears in the display.
4. When “CyC-” appears in the display, press the START (enter) keypad. There are four programmable cycle time options. Refer to *Table 7*.

Display	Cycle Time Options
“CyC1”	Heat Cycle Time Minutes
“CyC2”	Heat Cycle Time Seconds
“CyC3”	No Heat Cycle Time Minutes
“CyC4”	No Heat Cycle Time Seconds

Table 7

5. Press the LOW TEMP (^) or the DELICATES (v) keypad to select the desired cycle time option.

**NOTE: Cycle time can be set from one (1) to 99 minutes.**

**NOTE: The default value for both cycles in minutes is 45 and the default value for seconds is 0.**

6. Press the START (enter) keypad when the correct option appears in the display.
7. Press the LOW TEMP (^) or the DELICATES (v) keypad to increase or decrease the number of minutes or seconds displayed to the desired number of minutes or seconds.
8. Press the START (enter) keypad when the correct number of minutes or seconds appears in the display. The new value is saved and the next option in the parameter will appear in the display.

**NOTE: To program the next option, “Cdt-” (Cooldown Time), press the MED TEMP (<) keypad until “CyC-” is displayed, then press the LOW TEMP (^) or DELICATES (v) keypad until “Cdt-” appears in the display and refer to *option 14*. To program other options, refer to the appropriate section.**

#### How to Exit Programming Feature

Press the MED TEMP (<) keypad until the control returns to Ready Mode.

## 14. Cool Down Time “Cdt-”

This option allows the owner to set the amount of cool down time for all heat cycles.

### How to Program Cool Down Time

1. Control must be in Manual Mode. Refer to *Entering the Manual Mode*.
2. Press the LOW TEMP (^) or the DELICATES (v) keypad until “Prog” appears in the display. Press the START (enter) keypad and “AtSH” will appear in the display.
3. Press the LOW TEMP (^) or the DELICATES (v) keypad to scroll through the programmable options until “Cdt-” appears in the display.
4. When “Cdt-” appears in the display, press the START (enter) keypad. There are four programmable cool down time options. Refer to *Table 8*.

Display	Cooldown Time Options
“Cdt1”	High Temp Cooldown Time
“Cdt2”	Medium Temp Cooldown Time
“Cdt3”	Low Temp Cooldown Time
“Cdt4”	Delicates Cooldown Time

Table 8

5. Press the LOW TEMP (^) or the DELICATES (v) keypad to select the desired cooldown time option.

**NOTE: Cooldown time can be set from one (1) to 15 minutes. The default value for each option is 3.**

6. Press the START (enter) keypad when the correct option appears in the display.
7. Press the LOW TEMP (^) or the DELICATES (v) keypad to increase or decrease the number of minutes displayed to the desired number of minutes.
8. Press the START (enter) keypad when the correct number of minutes appears in the display. The new value is saved and the next option in the parameter will appear in the display.

**NOTE: To program the next option, “tEP-” (Temperature), press the MED TEMP (<) keypad until “Cdt-” is displayed, then press the LOW TEMP (^) or DELICATES (v) keypad until “tEP-” appears in the display and refer to *option 15*. To program other options, refer to the appropriate section.**

### How to Exit Programming Feature

Press the MED TEMP (<) keypad until the control returns to Ready Mode.

## 15. Temperature “tEP-”

This option allows the owner to set the temperature of the heat cycles.

### How to Program Temperature

- Control must be in Manual Mode. Refer to *Entering the Manual Mode*.
- Press the LOW TEMP (^) or the DELICATES (v) keypad until “Prog” appears in the display. Press the START (enter) keypad and “AtSH” will appear in the display.
- Press the LOW TEMP (^) or the DELICATES (v) keypad to scroll through the programmable options until “tEP-” appears in the display.
- When “tEP-” appears in the display, press the START (enter) keypad. There are four programmable temperature options. Refer to *Table 9*.

Display	Temperature Options
“tEP1”	High Temperature
“tEP2”	Medium Temperature
“tEP3”	Low Temperature
“tEP4”	Delicates Temperature

Table 9

- Press the LOW TEMP (^) or the DELICATES (v) keypad to select the desired temperature option.
- Press the START (enter) keypad when the correct option appears in the display. Refer to *Table 10* for values.

Temperature Options
100°F (38°C)
105°F (41°C)
110°F (43°C)
115°F (46°C)
120°F (49°C)
125°F (52°C)
130°F (54°C)
135°F (57°C)
140°F (60°C)
145°F (62°C)
150°F (66°C)
155°F (68°C)
160°F (71°C)

Table 10

**NOTE: The default values are as follows:**

**High Temperature = 160°F (71°C)**

**Medium Temperature = 155°F (68°C)**

**Low Temperature = 145°F (62°C)**

**Delicates Temperature = 115°F (46°C)**

- Press the LOW TEMP (^) or the DELICATES (v) keypad to increase or decrease the current number of degrees displayed in the display to the desired number of degrees.
- Press the START (enter) keypad when the correct number of degrees appears in the display. The new value is saved and the next option in the parameter will appear in the display.

**NOTE: To program the next option, “t FC” (Temperature [Fahrenheit/Celsius]), press the MED TEMP (<) keypad until “tEP-” is displayed, then press the LOW TEMP (^) or DELICATES (v) keypad until “t FC” appears in the display and refer to *option 16*. To program other options, refer to the appropriate section.**

### How to Exit Programming Feature

Press the MED TEMP (<) keypad until the control returns to Ready Mode.



## 16. Temperature (Fahrenheit/Celsius) “t FC”

This option allows the owner to set whether the display will be shown in Fahrenheit or Celsius.

### How to Program Temperature (Fahrenheit/Celsius)

1. Control must be in Manual Mode. Refer to *Entering the Manual Mode*.
2. Press the LOW TEMP (^) or the DELICATES (v) keypad until “Prog” appears in the display. Press the START (enter) keypad and “AtSH” will appear in the display.
3. Press the LOW TEMP (^) or the DELICATES (v) keypad to scroll through the programmable options until “t FC” appears in the display.
4. When “t FC” appears in the display, press the START (enter) keypad. A number will appear in the display. This number (found below) corresponds to the current Temperature (Fahrenheit/Celsius) setting.  
One (1) = Celsius  
Zero (0) = Fahrenheit

**NOTE: The default value is 0.**

5. Press the LOW TEMP (^) or the DELICATES (v) keypad to increase or decrease the current number to the desired number.
6. Press the START (enter) keypad when the correct number appears in the display. The new value is saved and the next option, “AtSn”, will appear in the display.

**NOTE: To program “AtSn” (No Heat Vend Price), refer to *option 17*. To program other options, refer to the appropriate section.**

### How to Exit Programming Feature

Press the MED TEMP (<) keypad until the control returns to Ready Mode.

## Programming Control

### 17. No Heat Vend Price “AtSn”

This option allows the owner to set the vend price for a NO HEAT cycle. This vend price will be shown in the display when NO HEAT is selected.

#### How to Program No Heat Vend Price

1. Control must be in Manual Mode. Refer to *Entering the Manual Mode*.
2. Press the LOW TEMP (^) or the DELICATES (v) keypad until “Prog” appears in the display. Press the START (enter) keypad, and “AtSH” will appear in the display.
3. Press the LOW TEMP (^) or the DELICATES (v) keypad to scroll through the programmable options until “AtSn” appears in the display.
4. When “AtSn” appears in the display, press the START (enter) keypad. There are five digits in the No Heat Vend Price. The fifth digit will appear in the display and will flash one second on, one second off. Refer to *Figure 7*.

**NOTE: If the vend price is \$100.00 or more, the fifth digit is “1-6”. If the vend price is \$99.99 or less, the fifth digit is “0”.**

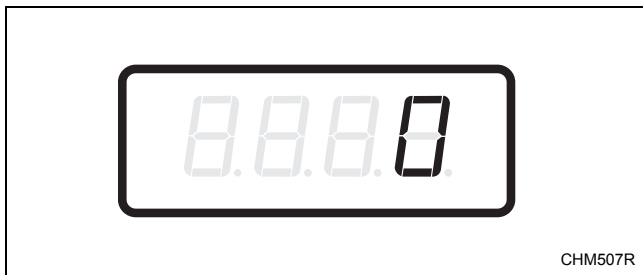

Figure 7

5. Press the LOW TEMP (^) or the DELICATES (v) keypad to increase or decrease the value of the fifth digit.

**NOTE: The vend price can be set from 0 to 65,535. The default value is 200.**

6. Press the START (enter) keypad to enter the fifth digit and display remaining four digits. The active digit will flash one second on and one second off.

**NOTE: To go back to the current programmable option without changing the value, press the MED TEMP (<) keypad.**

7. Press the LOW TEMP (^) or the DELICATES (v) keypad to increase or decrease the value of the active digit and the START (enter) keypad to enter the value of the digit and advance to the next digit.
8. Press the START (enter) keypad with the last active digit. The new value is saved and the next option, “rtC-”, will appear in the display.

**NOTE: To program “rtC-” (Real Time Clock), refer to *option 18*. To program other options, refer to the appropriate section.**

#### How to Exit Programming Feature

Press the MED TEMP (<) keypad until the control returns to Ready Mode.

## 18. Set Real-Time Clock “rtC-”

This option allows the owner to set the control’s internal clock to the correct time and date.

### How to Program the Time and Date

1. Control must be in Manual Mode. Refer to *Entering the Manual Mode*.
2. Press the LOW TEMP (^) or the DELICATES (v) keypad until “Prog” appears in the display. Press the START (enter) keypad and “AtSH” will appear in the display.
3. Press the LOW TEMP (^) or the DELICATES (v) keypad to scroll through the programmable options until “rtC-” appears in the display. Press the START keypad and “rtC1” will appear in the display.
4. Press the LOW TEMP (^) or the DELICATES (v) keypad to scroll through the programmable options. Refer to *Table 11*.

Display	Real Time Clock Options
“rtC1”	Programs Minutes
“rtC2”	Programs Hours
“rtC3”	Programs Day of Week
“rtC4”	Programs Date of Month
“rtC5”	Programs Month
“rtC6”	Programs Year
“rtC7”	Programs Daylight Savings

Table 11

5. When the desired option appears in the display, press the START (enter) keypad. The current value will appear in the display.
6. Press the LOW TEMP (^) or the DELICATES (v) keypad to increase or decrease the minutes, hours, day of week, date of the month, month, year to the correct time or date.

**NOTE: The hours will be displayed in military time. For day of week, Sunday is considered day one (001), Monday is day two (002) and so on. For year, the year 2000 is “00”, the year 2001 is “01” and so on.**

If programming Daylight Savings, “rtc7”, “on” enables Daylight Savings Time and “off” disables Daylight Savings Time.

**NOTE: Daylight Savings Time is on by default.**

7. Press the START (enter) keypad when the correct time or date appears in the display. The new value is saved and the next Set Real-Time Clock option will appear in the display.

**NOTE: To program the next option, “SPA-” (Special Vend A Data), press the MED TEMP (<) keypad until “rtC-” is displayed, then press the LOW TEMP (^) or DELICATES (v) keypad until “SPA-” appears in the display and refer to *option 19*. To program other options, refer to the appropriate section.**

### How to Exit Programming Feature

Press the MED TEMP (<) keypad until the control returns to Ready Mode.

## Programming Control

### 19. Special Vend A Data “SPA-”

This option allows the owner to set the day or days of a special vend.

Special Vend A is used to change the standard vend prices for special occasions. The special vend can be programmed to start and end on a specific day or days of the week.

The owner may also turn the Special Vend A option on or off if desired.

#### How to Program Special Vend A Days Enable “SA01”

1. Control must be in Manual Mode. Refer to *Entering the Manual Mode*.
2. Press the LOW TEMP (^) or the DELICATES (v) keypad until “Prog” appears in the display. Press the START (enter) keypad and “AtSH” will appear in the display.
3. Press the LOW TEMP (^) or the DELICATES (v) keypad to scroll through the programmable options until “SPA-” appears in the display. Press the START (enter) keypad and “SA01” will appear in the display.
4. When “SA01” appears in the display, press the START (enter) keypad. A number will appear in the display that corresponds to the current Special Vend A Days Enable Programming Value.
5. Locate the desired number in the first column of *Table 12* on the following pages.
6. Press the LOW TEMP (^) or the DELICATES (v) keypad to increase or decrease the current number until correct.
7. Press the START (enter) keypad when the correct number appears in the display. The new value is saved and the next Special Vend A option, “SA02”, will appear in the display.

**NOTE: To program “SA02” (Special Vend A Start Hour), continue to the next Special Vend A option. To program other options, press the MED TEMP (<) keypad and refer to the appropriate section.**

#### How to Exit Programming Feature

Press the MED TEMP (<) keypad until the control returns to Ready Mode.

**How to Read Table 12**

To determine the correct number required to program the Special Vend Days Enable, use the following table. The Special Vend Value column contains the number required in step 6. The other columns correspond to individual days.

Each column of days contains a unique combination of the words “ON” and “OFF” that indicates if that column’s day is turned on or off when the value is entered. Select the desired combination of days and enter the number found in the value column.

**NOTE: The default value is 0.**

"SA01"								
SPECIAL VEND VALUE	SAT	FRI	THUR	WED	TUE	MON	SUN	ON/OFF
0	OFF	OFF	OFF	OFF	OFF	OFF	OFF	OFF
3	OFF	OFF	OFF	OFF	OFF	OFF	ON	ON
5	OFF	OFF	OFF	OFF	OFF	ON	OFF	ON
7	OFF	OFF	OFF	OFF	OFF	ON	ON	ON
9	OFF	OFF	OFF	OFF	ON	OFF	OFF	ON
11	OFF	OFF	OFF	OFF	ON	OFF	ON	ON
13	OFF	OFF	OFF	OFF	ON	ON	OFF	ON
15	OFF	OFF	OFF	OFF	ON	ON	ON	ON
17	OFF	OFF	OFF	ON	OFF	OFF	OFF	ON
19	OFF	OFF	OFF	ON	OFF	OFF	ON	ON
21	OFF	OFF	OFF	ON	OFF	ON	OFF	ON
23	OFF	OFF	OFF	ON	OFF	ON	ON	ON
25	OFF	OFF	OFF	ON	ON	OFF	OFF	ON
27	OFF	OFF	OFF	ON	ON	OFF	ON	ON
29	OFF	OFF	OFF	ON	ON	ON	OFF	ON
31	OFF	OFF	OFF	ON	ON	ON	ON	ON
33	OFF	OFF	ON	OFF	OFF	OFF	OFF	ON
35	OFF	OFF	ON	OFF	OFF	OFF	ON	ON
37	OFF	OFF	ON	OFF	OFF	ON	OFF	ON
39	OFF	OFF	ON	OFF	OFF	ON	ON	ON
41	OFF	OFF	ON	OFF	ON	OFF	OFF	ON
43	OFF	OFF	ON	OFF	ON	OFF	ON	ON
45	OFF	OFF	ON	OFF	ON	ON	OFF	ON
47	OFF	OFF	ON	OFF	ON	ON	ON	ON
49	OFF	OFF	ON	ON	OFF	OFF	OFF	ON
51	OFF	OFF	ON	ON	OFF	OFF	ON	ON
53	OFF	OFF	ON	ON	OFF	ON	OFF	ON
55	OFF	OFF	ON	ON	OFF	ON	ON	ON
57	OFF	OFF	ON	ON	ON	OFF	OFF	ON
59	OFF	OFF	ON	ON	ON	OFF	ON	ON
61	OFF	OFF	ON	ON	ON	ON	OFF	ON
63	OFF	OFF	ON	ON	ON	ON	ON	ON
65	OFF	ON	OFF	OFF	OFF	OFF	OFF	ON

Table 12 (continued)

**Programming Control**

Table 12 (continued)

<b>“SA01”</b>								
<b>SPECIAL VEND VALUE</b>	<b>SAT</b>	<b>FRI</b>	<b>THUR</b>	<b>WED</b>	<b>TUE</b>	<b>MON</b>	<b>SUN</b>	<b>ON/OFF</b>
67	OFF	ON	OFF	OFF	OFF	OFF	ON	ON
69	OFF	ON	OFF	OFF	OFF	ON	OFF	ON
71	OFF	ON	OFF	OFF	OFF	ON	ON	ON
73	OFF	ON	OFF	OFF	ON	OFF	OFF	ON
75	OFF	ON	OFF	OFF	ON	OFF	ON	ON
77	OFF	ON	OFF	OFF	ON	ON	OFF	ON
79	OFF	ON	OFF	OFF	ON	ON	ON	ON
81	OFF	ON	OFF	ON	OFF	OFF	OFF	ON
83	OFF	ON	OFF	ON	OFF	OFF	ON	ON
85	OFF	ON	OFF	ON	OFF	ON	OFF	ON
87	OFF	ON	OFF	ON	OFF	ON	ON	ON
89	OFF	ON	OFF	ON	ON	OFF	OFF	ON
91	OFF	ON	OFF	ON	ON	OFF	ON	ON
93	OFF	ON	OFF	ON	ON	ON	OFF	ON
95	OFF	ON	OFF	ON	ON	ON	ON	ON
97	OFF	ON	ON	OFF	OFF	OFF	OFF	ON
99	OFF	ON	ON	OFF	OFF	OFF	ON	ON
101	OFF	ON	ON	OFF	OFF	ON	OFF	ON
103	OFF	ON	ON	OFF	OFF	ON	ON	ON
105	OFF	ON	ON	OFF	ON	OFF	OFF	ON
107	OFF	ON	ON	OFF	ON	OFF	ON	ON
109	OFF	ON	ON	OFF	ON	ON	OFF	ON
111	OFF	ON	ON	OFF	ON	ON	ON	ON
113	OFF	ON	ON	ON	OFF	OFF	OFF	ON
115	OFF	ON	ON	ON	OFF	OFF	ON	ON
117	OFF	ON	ON	ON	OFF	ON	OFF	ON
119	OFF	ON	ON	ON	OFF	ON	ON	ON
121	OFF	ON	ON	ON	ON	OFF	OFF	ON
123	OFF	ON	ON	ON	ON	OFF	ON	ON
125	OFF	ON	ON	ON	ON	ON	OFF	ON
127	OFF	ON	ON	ON	ON	ON	ON	ON
129	ON	OFF	OFF	OFF	OFF	OFF	OFF	ON
131	ON	OFF	OFF	OFF	OFF	OFF	ON	ON
133	ON	OFF	OFF	OFF	OFF	ON	OFF	ON
135	ON	OFF	OFF	OFF	OFF	ON	ON	ON
137	ON	OFF	OFF	OFF	ON	OFF	OFF	ON
139	ON	OFF	OFF	OFF	ON	OFF	ON	ON
141	ON	OFF	OFF	OFF	ON	ON	OFF	ON
143	ON	OFF	OFF	OFF	ON	ON	ON	ON
145	ON	OFF	OFF	ON	OFF	OFF	OFF	ON
147	ON	OFF	OFF	ON	OFF	OFF	ON	ON
149	ON	OFF	OFF	ON	OFF	ON	OFF	ON
151	ON	OFF	OFF	ON	OFF	ON	ON	ON
153	ON	OFF	OFF	ON	ON	OFF	OFF	ON

Table 12 (continued)

Table 12 (continued)

"SA01"								
SPECIAL VEND VALUE	SAT	FRI	THUR	WED	TUE	MON	SUN	ON/OFF
155	ON	OFF	OFF	ON	ON	OFF	ON	ON
157	ON	OFF	OFF	ON	ON	ON	OFF	ON
159	ON	OFF	OFF	ON	ON	ON	ON	ON
161	ON	OFF	ON	OFF	OFF	OFF	OFF	ON
163	ON	OFF	ON	OFF	OFF	OFF	ON	ON
165	ON	OFF	ON	OFF	OFF	ON	OFF	ON
167	ON	OFF	ON	OFF	OFF	ON	ON	ON
169	ON	OFF	ON	OFF	ON	OFF	OFF	ON
171	ON	OFF	ON	OFF	ON	OFF	ON	ON
173	ON	OFF	ON	OFF	ON	ON	OFF	ON
175	ON	OFF	ON	OFF	ON	ON	ON	ON
177	ON	OFF	ON	ON	OFF	OFF	OFF	ON
179	ON	OFF	ON	ON	OFF	OFF	ON	ON
181	ON	OFF	ON	ON	OFF	ON	OFF	ON
183	ON	OFF	ON	ON	OFF	ON	ON	ON
185	ON	OFF	ON	ON	ON	OFF	OFF	ON
187	ON	OFF	ON	ON	ON	OFF	ON	ON
189	ON	OFF	ON	ON	ON	ON	OFF	ON
191	ON	OFF	ON	ON	ON	ON	ON	ON
193	ON	ON	OFF	OFF	OFF	OFF	OFF	ON
195	ON	ON	OFF	OFF	OFF	OFF	ON	ON
197	ON	ON	OFF	OFF	OFF	ON	OFF	ON
199	ON	ON	OFF	OFF	OFF	ON	ON	ON
201	ON	ON	OFF	OFF	ON	OFF	OFF	ON
203	ON	ON	OFF	OFF	ON	OFF	ON	ON
205	ON	ON	OFF	OFF	ON	ON	OFF	ON
207	ON	ON	OFF	OFF	ON	ON	ON	ON
209	ON	ON	OFF	ON	OFF	OFF	OFF	ON
211	ON	ON	OFF	ON	OFF	OFF	ON	ON
213	ON	ON	OFF	ON	OFF	ON	OFF	ON
215	ON	ON	OFF	ON	OFF	ON	ON	ON
217	ON	ON	OFF	ON	ON	OFF	OFF	ON
219	ON	ON	OFF	ON	ON	OFF	ON	ON
221	ON	ON	OFF	ON	ON	ON	OFF	ON
223	ON	ON	OFF	ON	ON	ON	ON	ON
225	ON	ON	ON	OFF	OFF	OFF	OFF	ON
227	ON	ON	ON	OFF	OFF	OFF	ON	ON
229	ON	ON	ON	OFF	OFF	ON	OFF	ON
231	ON	ON	ON	OFF	OFF	ON	ON	ON
233	ON	ON	ON	OFF	ON	OFF	OFF	ON
235	ON	ON	ON	OFF	ON	OFF	ON	ON
237	ON	ON	ON	OFF	ON	ON	OFF	ON
239	ON	ON	ON	OFF	ON	ON	ON	ON
241	ON	ON	ON	ON	OFF	OFF	OFF	ON

Table 12 (continued)

**Programming Control**

Table 12 (continued)

<b>"SA01"</b>								
<b>SPECIAL VEND VALUE</b>	<b>SAT</b>	<b>FRI</b>	<b>THUR</b>	<b>WED</b>	<b>TUE</b>	<b>MON</b>	<b>SUN</b>	<b>ON/OFF</b>
243	ON	ON	ON	ON	OFF	OFF	ON	ON
245	ON	ON	ON	ON	OFF	ON	OFF	ON
247	ON	ON	ON	ON	OFF	ON	ON	ON
249	ON	ON	ON	ON	ON	OFF	OFF	ON
251	ON	ON	ON	ON	ON	OFF	ON	ON
253	ON	ON	ON	ON	ON	ON	OFF	ON
255	ON	ON	ON	ON	ON	ON	ON	ON

Table 12



## How to Program Special Vend A Start Hour “SA02”

This option allows the owner to set the hour that Special Vend A will begin.

1. Press the LOW TEMP (^) or the DELICATES (v) keypad to scroll through the programmable Special Vend A options until “SA02” appears in the display.
2. When “SA02” appears in the display, press the START (enter) keypad. The current start hour (in military time) will appear in the display.

**NOTE: The hours will be displayed in military time.**

3. Press the LOW TEMP (^) or the DELICATES (v) keypad to increase or decrease the start hour to the desired hour.

**NOTE: The value can be set from 0-23. The default value is 0.**

4. Press the START (enter) keypad when the correct hour appears in the display. The new value is saved and the next Special Vend A option, “SA03”, will appear in the display.

**NOTE: To program “SA03” (Special Vend A Start Minute), continue to next Special Vend A option. To program other options, press the MED TEMP (<) keypad and refer to the appropriate section.**

### How to Exit Programming Feature

Press the MED TEMP (<) keypad until the control returns to Ready Mode.

## How to Program Special Vend A Start Minute “SA03”

This option allows the owner to set the minute that Special Vend A will begin.

1. Press the LOW TEMP (^) or the DELICATES (v) keypad to scroll through the programmable Special Vend A options until “SA03” appears in the display.
2. When “SA03” appears in the display, press the START (enter) keypad. The current start minute will appear in the display.
3. Press the LOW TEMP (^) or the DELICATES (v) keypad to increase or decrease the start minute to the desired minute.

**NOTE: The value can be set from 0-59 minutes. The default value is 0.**

4. Press the START (enter) keypad when the correct minute appears in the display. The new value is saved and the next Special Vend A option, “SA04”, will appear in the display.

**NOTE: To program “SA04” (Special Vend A Length in Hours), continue to next Special Vend A option. To program other options, press the MED TEMP (<) keypad and refer to the appropriate section.**

### How to Exit Programming Feature

Press the MED TEMP (<) keypad until the control returns to Ready Mode.

## Programming Control

### How to Program Special Vend A Length in Hours “SA04”

This option allows the owner to set the length in hours for Special Vend A.

1. Press the LOW TEMP (^) or the DELICATES (v) keypad to scroll through the programmable Special Vend A options until “SA04” appears in the display.
2. When “SA04” appears in the display, press the START (enter) keypad. The current length in hours will appear in the display.
3. Press the LOW TEMP (^) or the DELICATES (v) keypad to increase or decrease the current length of hours to the desired number of hours.

**NOTE: The value can be set from 0-24. The default value is 0.**

4. Press the START (enter) keypad when the correct hour appears in the display. The new value is saved and the next Special Vend A option, “SA05”, will appear in the display.

**NOTE: To program “SA05” (Special Vend A Start Month), continue to next Special Vend A option. To program other options, press the MED TEMP (<) keypad and refer to the appropriate section.**

### How to Exit Programming Feature

Press the MED TEMP (<) keypad until the control returns to Ready Mode.

### How to Program Special Vend A Start Month “SA05”

This option allows the owner to set the month that Special Vend A will begin.

**NOTE: If Special Vend A Start Month, Start Date, End Month, or End Date are programmed to zero (default is zero), the Special Vend A will be active every week on the days programmed in Table 12.**

1. Press the LOW TEMP (^) or the DELICATES (v) keypad to scroll through the programmable Special Vend A options until “SA05” appears in the display.
2. When “SA05” appears in the display, press the START (enter) keypad. The current start month will appear in the display.
3. Press the LOW TEMP (^) or the DELICATES (v) keypad to increase or decrease the start month to the desired month.

If “0” is selected and Special Vend A is on, Special Vend A will occur at the time and days of week selected, regardless of the month.

**NOTE: The value can be set at 0 (off) or from 1-12. The default value is 0.**

4. Press the START (enter) keypad when the correct month appears in the display. The new value is saved and the next Special Vend A option, “SA06”, will appear in the display.

**NOTE: To program “SA06” (Special Vend A Start Date), continue to next Special Vend A option. To program other options, press the MED TEMP (<) keypad and refer to the appropriate section.**

### How to Exit Programming Feature

Press the MED TEMP (<) keypad until the control returns to Ready Mode.

## How to Program Special Vend A Start Date “SA06”

This option allows the owner to set the date that Special Vend A will begin.

1. Press the LOW TEMP (^) or the DELICATES (v) keypad to scroll through the programmable Special Vend A options until “SA06” appears in the display.
2. When “SA06” appears in the display, press the START (enter) keypad. The current start date will appear in the display.
3. Press the LOW TEMP (^) or the DELICATES (v) keypad to increase or decrease the start date to the desired date.

If “0” is selected and Special Vend A is on, Special Vend A will occur at the time and days of week selected, regardless of the date.

**NOTE: The value can be set at 0 (off) or from 1-31. The default value is 0.**

4. Press the START (enter) keypad when the correct date appears in the display. The new value is saved and the next Special Vend A option, “SA07”, will appear in the display.

**NOTE: To program “SA07” (Special Vend A Start Year), continue to next Special Vend A option. To program other options, press the MED TEMP (<) keypad and refer to the appropriate section.**

### How to Exit Programming Feature

Press the MED TEMP (<) keypad until the control returns to Ready Mode.

## How to Program Special Vend A Start Year “SA07”

This option allows the owner to set the year that Special Vend A will begin.

1. Press the LOW TEMP (^) or the DELICATES (v) keypad to scroll through the programmable Special Vend A options until “SA07” appears in the display.
2. When “SA07” appears in the display, press the START (enter) keypad. The current start year will appear in the display.
3. Press the LOW TEMP (^) or the DELICATES (v) keypad to increase or decrease the start year to the desired year.

If the start/end date or month are set to “0”, the year is ignored. “01” is year 2001, “02” is year 2002, and so on.

**NOTE: The value can be set from 0-99. The default value is 0.**

4. Press the START (enter) keypad when the correct year appears in the display. The new value is saved and the next Special Vend A option, “SA08”, will appear in the display.

**NOTE: To program “SA08” (Special Vend A End Month), continue to next Special Vend A option. To program other options, press the MED TEMP (<) keypad and refer to the appropriate section.**

### How to Exit Programming Feature

Press the MED TEMP (<) keypad until the control returns to Ready Mode.

## Programming Control

### How to Program Special Vend A End Month “SA08”

This option allows the owner to set the month that Special Vend A will end.

1. Press the LOW TEMP (^) or the DELICATES (v) keypad to scroll through the programmable Special Vend A options until “SA08” appears in the display.
2. When “SA08” appears in the display, press the START (enter) keypad. The current end month will appear in the display.
3. Press the LOW TEMP (^) or the DELICATES (v) keypad to increase or decrease the end month to the desired month.

If “0” is selected and Special Vend A is on, Special Vend A will occur at the time and day of week selected, regardless of the month.

**NOTE: The value can be set at 0 (off) or from 1-12. The default value is 0.**

4. Press the START (enter) keypad when the correct month appears in the display. The new value is saved and the next Special Vend A option, “SA09”, will appear in the display.

**NOTE: To program “SA09” (Special Vend A End Date), continue to next Special Vend A option. To program other options, press the MED TEMP (<) keypad and refer to the appropriate section.**

### How to Exit Programming Feature

Press the MED TEMP (<) keypad until the control returns to Ready Mode.

### How to Program Special Vend A End Date “SA09”

This option allows the owner to set the date that Special Vend A will end.

1. Press the LOW TEMP (^) or the DELICATES (v) keypad to scroll through the programmable Special Vend A options until “SA09” appears in the display.
2. When “SA09” appears in the display, press the START (enter) keypad. The current end date will appear in the display.
3. Press the LOW TEMP (^) or the DELICATES (v) keypad to increase or decrease the end date to the desired date.

If “0” is selected and Special Vend A is on, Special Vend A will occur at the time and days of week selected, regardless of the date.

**NOTE: The value can be set at 0 (off) or from 1-31. The default value is 0.**

4. Press the START (enter) keypad when the correct date appears in the display. The new value is saved and the next Special Vend A option, “SA10”, will appear in the display.

**NOTE: To program “SA10” (Special Vend A End Year), continue to next Special Vend A option. To program other options, press the MED TEMP (<) keypad and refer to the appropriate section.**

### How to Exit Programming Feature

Press the MED TEMP (<) keypad until the control returns to Ready Mode.

## How to Program Special Vend A End Year “SA10”

This option allows the owner to set the year that Special Vend A will end.

1. Press the LOW TEMP (^) or the DELICATES (v) keypad to scroll through the programmable Special Vend A options until “SA10” appears in the display.
2. When “SA10” appears in the display, press the START (enter) keypad. The current end year will appear in the display.
3. Press the LOW TEMP (^) or the DELICATES (v) keypad to increase or decrease the end year to the desired year.

If the start/end date or month are set to “0”, the year is ignored. “01” is year 2001, “02” is year 2002 and so on.

**NOTE: The value can be set from 0-99. The default value is 0.**

4. Press the START (enter) keypad when the correct year appears in the display. The new value is saved and the next Special Vend A option, “SA11”, will appear in the display.

**NOTE: To program “SA11” (Special Vend A Heat Price), continue to next Special Vend A option. To program other options, press the MED TEMP (<) keypad and refer to the appropriate section.**

## How to Exit Programming Feature

Press the MED TEMP (<) keypad until the control returns to Ready Mode.

## Programming Control

### How to Program Special Vend A Heat Price “SA11”

This option allows the owner to set the vend price for a heat cycle in Special Vend A.

1. Press the LOW TEMP (^) or the DELICATES (v) keypad to scroll through the programmable Special Vend A options until “SA11” appears in the display.
2. When “SA11” appears in the display, press the START (enter) keypad. There are five digits in the Special Vend A Heat Price. The fifth digit will appear in the display and will flash one second on and one second off. Refer to *Figure 8*.

**NOTE: If the vend price is \$100.00 or more, the fifth digit is “1-6”. If the vend price is \$99.99 or less, the fifth digit is “0”.**

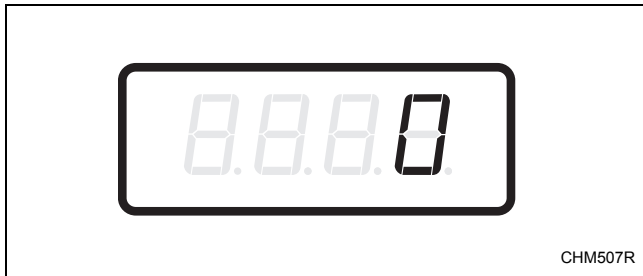

Figure 8

3. Press the LOW TEMP (^) or the DELICATES (v) keypad to increase or decrease the value of the fifth digit.

**NOTE: The vend price can be set from 0 to 65,535. The default value is 0.**

4. Press the START (enter) keypad to enter the fifth digit and display remaining four digits. The active digit will flash one second on and one second off.

**NOTE: To go back to the current programmable Special Vend A option without changing the value, press the MED TEMP (<) keypad.**

5. Press the LOW TEMP (^) or the DELICATES (v) keypad to increase or decrease the value of the active digit and the START keypad to enter the value of the digit and advance to the next digit.
6. Press the START (enter) keypad with the last active digit. The new value is saved and the next Special Vend A option, “SA12”, will appear in the display.

**NOTE: To program “SA12” (Special Vend A No Heat Price), continue to next Special Vend A option. To program other options, press the MED TEMP (<) keypad and refer to the appropriate section.**

### How to Exit Programming Feature

Press the MED TEMP (<) keypad until the control returns to Ready Mode.

## How to Program Special Vend A No Heat Price “SA12”

This option allows the owner to set the vend price for a no heat cycle in Special Vend A.

1. Press the LOW TEMP (^) or the DELICATES (v) keypad to scroll through the programmable Special Vend A options until “SA12” appears in the display.
2. When “SA12” appears in the display, press the START (enter) keypad. There are five digits in the Special Vend A No Heat Price. The fifth digit will appear in the display and will flash one second on and one second off. Refer to *Figure 9*.

**NOTE: If the vend price is \$100.00 or more, the fifth digit is “1-6”. If the vend price is \$99.99 or less, the fifth digit is “0”.**

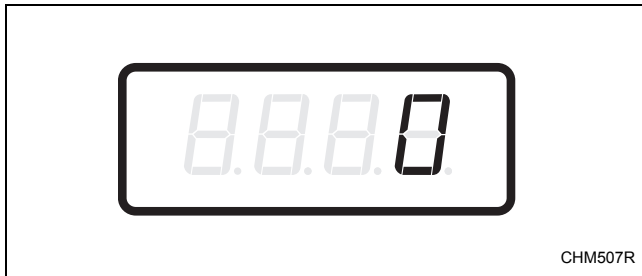

Figure 9

3. Press the LOW TEMP (^) or the DELICATES (v) keypad to increase or decrease the value of the fifth digit.

**NOTE: The vend price can be set from 0 to 65,535. The default value is 0.**

4. Press the START (enter) keypad to enter the fifth digit and display remaining four digits. The active digit will flash one second on and one second off.

**NOTE: To go back to the current programmable Special Vend A option without changing the value, press the MED TEMP (<) keypad.**

5. Press the LOW TEMP (^) or the DELICATES (v) keypad to increase or decrease the value of the active digit and the START keypad to enter the value of the digit and advance to the next digit.
6. Press the START (enter) keypad with the last active digit. The new value is saved and the next Special Vend A option, “SA13”, will appear in the display.

**NOTE: To program “SA13” (Special Vend A Heat Time Minutes), continue to next Special Vend A option. To program other options, press the MED TEMP (<) keypad and refer to the appropriate section.**

## How to Exit Programming Feature

Press the MED TEMP (<) keypad until the control returns to Ready Mode.

## Programming Control

### How to Program Special Vend A Heat Time Minutes “SA13”

This option allows the owner to set the amount of time in minutes for a heat cycle in Special Vend A.

1. Press the LOW TEMP (^) or the DELICATES (✓) keypad to scroll through the programmable Special Vend A options until “SA13” appears in the display.
2. When “SA13” appears in the display, press the START (enter) keypad. The current number of minutes set for Special Vend A Heat Time Minutes will appear in the display.
3. Press the LOW TEMP (^) or the DELICATES (✓) keypad to increase or decrease the current number of minutes displayed to the desired number of minutes.

**NOTE: The number of minutes can be set from 1 to 99 minutes. The control will not allow the cycle time to exceed 99 minutes. The default value is 1.**

4. Press the START (enter) keypad when the correct number of minutes is displayed. The new value is saved and the next Special Vend A option “SA14”, will appear in the display.

**NOTE: To program “SA14” (Special Vend A No Heat Time Minutes), continue to next Special Vend A option. To program other options, press the MED TEMP (<) keypad and refer to the appropriate section.**

### How to Exit Programming Feature

Press the MED TEMP (<) keypad until the control returns to Ready Mode.

### How to Program Special Vend A No Heat Time Minutes “SA14”

This option allows the owner to set the amount of time in minutes for a no heat cycle in Special Vend A.

1. Press the LOW TEMP (^) or the DELICATES (✓) keypad to scroll through the programmable Special Vend A options until “SA14” appears in the display.
2. When “SA14” appears in the display, press the START (enter) keypad. The current number of minutes set for Special Vend A No Heat Time Minutes will appear in the display.
3. Press the LOW TEMP (^) or the DELICATES (✓) keypad to increase or decrease the current number of minutes displayed to the desired number of minutes.

**NOTE: The number of minutes can be set from 1 to 99 minutes. The control will not allow the cycle time to exceed 99 minutes. The default value is 1.**

4. Press the START (enter) keypad when the correct number of minutes is displayed. The new value is saved and the next Special Vend A option “SA15”, will appear in the display.

**NOTE: To program “SA15” (Special Vend A Coin #1 Top-Off Time Minutes), continue to next Special Vend A option. To program other options, press the MED TEMP (<) keypad and refer to the appropriate section.**

### How to Exit Programming Feature

Press the MED TEMP (<) keypad until the control returns to Ready Mode.



### How to Program Special Vend A Coin #1 Top-Off Time Minutes “SA15”

This option allows the owner to set the amount of top-off time in minutes in Special Vend A.

1. Press the LOW TEMP (^) or the DELICATES (v) keypad to scroll through the programmable Special Vend A options until “SA15” appears in the display.
2. When “SA15” appears in the display, press the START (enter) keypad. The current number of minutes set for Special Vend A Coin #1 Top-Off Time Minutes will appear in the display.
3. Press the LOW TEMP (^) or the DELICATES (v) keypad to increase or decrease the current number of minutes displayed to the desired number of minutes.

**NOTE: The minimum time for top-offs is one minute. The number of minutes can be set from 1 to 99 minutes. The default value is 1.**

4. Press the START (enter) keypad when the correct number of minutes is displayed. The new value is saved and the next Special Vend A option “SA16”, will appear in the display.

**NOTE: To program “SA16” (Special Vend A Coin #2 Top-Off Time Minutes), continue to next Special Vend A option. To program other options, press the MED TEMP (<) keypad and refer to the appropriate section.**

### How to Exit Programming Feature

Press the MED TEMP (<) keypad until the control returns to Ready Mode.

### How to Program Special Vend A Coin #2 Top-Off Time Minutes “SA16”

This option allows the owner to set the amount of top-off time in minutes in Special Vend A.

1. Press the LOW TEMP (^) or the DELICATES (v) keypad to scroll through the programmable Special Vend A options until “SA16” appears in the display.
2. When “SA16” appears in the display, press the START (enter) keypad. The current number of minutes set for Special Vend A Coin #2 Top-Off Time Minutes will appear in the display.
3. Press the LOW TEMP (^) or the DELICATES (v) keypad to increase or decrease the current number of minutes displayed to the desired number of minutes.

**NOTE: The minimum time for top-offs is one minute. The number of minutes can be set from 1 to 99 minutes. The default value is 1.**

4. Press the START (enter) keypad when the correct number of minutes is displayed. The new value is saved and the next Special Vend A option, “SA01”, will appear in the display.

**NOTE: To program “SPb-” (Special Vend B Days Enable), press the MED TEMP (<) keypad and refer to *option 20*. To program other options, refer to the appropriate section.**

### How to Exit Programming Feature

Press the MED TEMP (<) keypad until the control returns to Ready Mode.

## Programming Control

### 20. Special Vend B Days Enable “SPb-”

This option allows the owner to enable or disable a second special vend.

Special Vend B can be programmed using an external device or network.

The owner may also turn the Special Vend B option on or off if desired.

#### How to Program Special Vend B Days Enable

1. Control must be in Manual Mode. Refer to *Entering the Manual Mode*.
2. Press the LOW TEMP (Λ) or the DELICATES (∨) keypad until “Prog” appears in the display. Press the START (enter) keypad and “AtSH” will appear in the display.
3. Press the LOW TEMP (Λ) or the DELICATES (∨) keypad to scroll through the programmable options until “SPb-” appears in the display.
4. When “SPb-” appears in the display, press the START (enter) keypad. The control displays “on” or “off” for this parameter.

**NOTE: The default value is “off”.**

5. Press the LOW TEMP (Λ) or the DELICATES (∨) keypad to select “on” or “off”.
6. Press the START (enter) keypad when the desired status appears in the display. The new value is saved and the next option, “SPC-”, will appear in the display.

**NOTE: To program “SPC-” (Special Vend C Days Enable), refer to *option 21*. To program other options, refer to the appropriate section.**

#### How to Exit Programming Feature

Press the MED TEMP (<) keypad until the control returns to Ready Mode.

### 21. Special Vend C Days Enable “SPC-”

This option allows the owner to enable or disable a third special vend.

Special Vend C can be programmed using an external device or network.

The owner may also turn the Special Vend C option on or off if desired.

#### How to Program Special Vend C Days Enable

1. Control must be in Manual Mode. Refer to *Entering the Manual Mode*.
2. Press the LOW TEMP (Λ) or the DELICATES (∨) keypad until “Prog” appears in the display. Press the START (enter) keypad and “AtSH” will appear in the display.
3. Press the LOW TEMP (Λ) or the DELICATES (∨) keypad to scroll through the programmable options until “SPC-” appears in the display.
4. When “SPC-” appears in the display, press the START (enter) keypad. The control displays “on” or “off” for this parameter.

**NOTE: The default value is “off”.**

5. Press the LOW TEMP (Λ) or the DELICATES (∨) keypad to select “on” or “off”.
6. Press the START (enter) keypad when the desired status appears in the display. The new value is saved and the next option, “SPd-”, will appear in the display.

**NOTE: To program “SPd-” (Special Vend D Days Enable), refer to *option 22*. To program other options, refer to the appropriate section.**

#### How to Exit Programming Feature

Press the MED TEMP (<) keypad until the control returns to Ready Mode.

## 22. Special Vend D Days Enable “SPd-”

This option allows the owner to enable or disable a fourth special vend.

Special Vend D can be programmed using an external device or network.

The owner may also turn the Special Vend D option on or off if desired.

### How to Program Special Vend D Days Enable

1. Control must be in Manual Mode. Refer to *Entering the Manual Mode*.
2. Press the LOW TEMP (^) or the DELICATES (v) keypad until “Prog” appears in the display. Press the START (enter) keypad and “AtSH” will appear in the display.
3. Press the LOW TEMP (^) or the DELICATES (v) keypad to scroll through the programmable options until “SPd-” appears in the display.
4. When “SPd-” appears in the display, press the START (enter) keypad. The control displays “on” or “oFF” for this parameter.

**NOTE: The default value is oFF.**

5. Press the LOW TEMP (^) or the DELICATES (v) keypad to select “on” or “oFF”.
6. Press the START (enter) keypad when the desired status appears in the display. The new value is saved and the next option, “droP”, will appear in the display.

**NOTE: To program “droP” (Drop Off Mode), refer to *option 23*. To program other options, refer to the appropriate section.**

### How to Exit Programming Feature

Press the MED TEMP (<) keypad until the control returns to Ready Mode.

## 23. Drop Off Mode (On/Off) “droP”

This option allows the owner to limit machine use to an attendant without requiring vend.

### How to Program the Drop Off Mode (On/Off)

1. Control must be in Manual Mode. Refer to *Entering the Manual Mode*.
2. Press the LOW TEMP (^) or the DELICATES (v) keypad until “Prog” appears in the display. Press the START (enter) keypad and “AtSH” will appear in the display.
3. Press the LOW TEMP (^) or the DELICATES (v) keypad to scroll through the programmable options until “droP” appears in the display.
4. When “droP” appears in the display, press the START (enter) keypad. The current Drop Off Mode (On/Off) Status will appear in the display.  
“on” = Option Enabled  
“oFF” = Option Disabled

**NOTE: The default value is “oFF”.**

When the Drop Off Mode is enabled, starting the machine requires the correct sequence of four keypad presses. The default sequence programmed at the factory is HIGH TEMP, LOW TEMP, MED TEMP, DELICATES.

5. Press the LOW TEMP (^) or the DELICATES (v) keypad to change the current status.
6. Press the START (enter) keypad when the desired status appears in the display. The new value is saved and the next option, “LPSA”, will appear in the display.

**NOTE: To program “LPSA” (Low Power/Auto Shutdown A Days Enable), refer to *option 24*. To program other options, refer to the appropriate section.**

### How to Exit Programming Feature

Press the MED TEMP (<) keypad until the control returns to Ready Mode.

## 24. Low Power/Auto Shutdown A Days Enable “LPSA”

This option allows the owner to enable or disable Low Power/Auto Shutdown. Low Power or Auto Shutdown duration are programmed using an external device or network.

### How to Program the Low Power/Auto Shutdown A Days Enable

1. Control must be in Manual Mode. Refer to *Entering the Manual Mode*.
2. Press the LOW TEMP (^) or the DELICATES (v) keypad until “Prog” appears in the display. Press the START (enter) keypad and “AtSH” will appear in the display.
3. Press the LOW TEMP (^) or the DELICATES (v) keypad to scroll through the programmable options until “LPSA” appears in the display.
4. When “LPSA” appears in the display, press the START (enter) keypad. The current Low Power/Auto Shutdown A Days Enable status will appear in the display.  
“on” = Option Enabled  
“oFF” = Option Disabled

**NOTE: The default value is “oFF”.**

5. Press the LOW TEMP (^) or the DELICATES (v) keypad to change the current status.
6. Press the START (enter) keypad when the correct number appears in the display. The new value is saved and the next option, “LPSb”, will appear in the display.

**NOTE: To program “LPSb” (Low Power/Auto Shutdown B Days Enable), refer to *option 25*. To program other options, refer to the appropriate section.**

### How to Exit Programming Feature

Press the MED TEMP (<) keypad until the control returns to Ready Mode.

## 25. Low Power/Auto Shutdown B Days Enable “LPSb”

This option allows the owner to enable or disable Low Power/Auto Shutdown. Low Power or Auto Shutdown duration are programmed using an external device or network.

### How to Program the Low Power/Auto Shutdown B Days Enable

1. Control must be in Manual Mode. Refer to *Entering the Manual Mode*.
2. Press the LOW TEMP (^) or the DELICATES (v) keypad until “Prog” appears in the display. Press the START (enter) keypad and “AtSH” will appear in the display.
3. Press the LOW TEMP (^) or the DELICATES (v) keypad to scroll through the programmable options until “LPSb” appears in the display.
4. When “LPSb” appears in the display, press the START (enter) keypad. The current Low Power/Auto Shutdown B Days Enable status will appear in the display.  
“on” = Option Enabled  
“off” = Option Disabled

**NOTE: The default value is “off”.**

5. Press the LOW TEMP (^) or the DELICATES (v) keypad to change the current status.
6. Press the START (enter) keypad when the desired status appears in the display. The new value is saved and the next option, “LPSC”, will appear in the display.

**NOTE: To program “LPSC” (Low Power/Auto Shutdown C Days Enable), refer to *option 26*. To program other options, refer to the appropriate section.**

### How to Exit Programming Feature

Press the MED TEMP (<) keypad until the control returns to Ready Mode.

## 26. Low Power/Auto Shutdown C Days Enable “LPSC”

This option allows the owner to enable or disable Low Power/Auto Shutdown. Low Power or Auto Shutdown duration are programmed using an external device or network.

### How to Program the Low Power/Auto Shutdown C Days Enable

1. Control must be in Manual Mode. Refer to *Entering the Manual Mode*.
2. Press the LOW TEMP (^) or the DELICATES (v) keypad until “Prog” appears in the display. Press the START (enter) keypad and “AtSH” will appear in the display.
3. Press the LOW TEMP (^) or the DELICATES (v) keypad to scroll through the programmable options until “LPSC” appears in the display.
4. When “LPSC” appears in the display, press the START (enter) keypad. The current Low Power/Auto Shutdown C Days Enable status will appear in the display.  
“on” = Option Enabled  
“off” = Option Disabled

**NOTE: The default value is “off”.**

5. Press the LOW TEMP (^) or the DELICATES (v) keypad to change the current status.
6. Press the START (enter) keypad when the desired status appears in the display. The new value is saved and the next option, “LPSd”, will appear in the display.

**NOTE: To program “LPSd” (Low Power/Auto Shutdown D Days Enable), refer to *option 27*. To program other options, refer to the appropriate section.**

### How to Exit Programming Feature

Press the MED TEMP (<) keypad until the control returns to Ready Mode.

## 27. Low Power/Auto Shutdown D Days Enable “LPSd”

This option allows the owner to enable or disable Low Power/Auto Shutdown. Low Power or Auto Shutdown duration are programmed using an external device or network.

### How to Program the Low Power/Auto Shutdown D Days Enable

1. Control must be in Manual Mode. Refer to *Entering the Manual Mode*.
2. Press the LOW TEMP (^) or the DELICATES (v) keypad until “Prog” appears in the display. Press the START (enter) keypad and “AtSH” will appear in the display.
3. Press the LOW TEMP (^) or the DELICATES (v) keypad to scroll through the programmable options until “LPSd” appears in the display.
4. When “LPSd” appears in the display, press the START (enter) keypad. The current Low Power/Auto Shutdown D Days Enable status will appear in the display.  
“On” = Option Enabled  
“OFF” = Option Disabled

**NOTE: The default value is “OFF”.**

5. Press the LOW TEMP (^) or the DELICATES (v) keypad to change the current status.
6. Press the START (enter) keypad when the desired status appears in the display. The new value is saved and the next option, “PFR”, will appear in the display.

**NOTE: To program “PFR” (Power Fail Reset), refer to *option 28*. To program other options, refer to the appropriate section.**

### How to Exit Programming Feature

Press the MED TEMP (<) keypad until the control returns to Ready Mode.

## 28. Power Fail Reset “PFR”

This option allows the owner to set the amount of time the control will store active cycle information in the event of a power failure. The default setting for Power Fail Reset is OFF. If Power Fail Reset is turned OFF, the cycle will be saved.

### How to Program Power Fail Reset

1. Control must be in Manual Mode. Refer to *Entering the Manual Mode*.
2. Press the LOW TEMP (^) or the DELICATES (v) keypad until “Prog” appears in the display. Press the START (enter) keypad and “AtSH” will appear in the display.
3. Press the LOW TEMP (^) or the DELICATES (v) keypad to scroll through the programmable options until “PFR” appears in the display.
4. When “PFR” appears in the display, press the START (enter) keypad. A number will appear in the display. This number corresponds to the current Power Fail Reset setting.
5. Press the LOW TEMP (^) or the DELICATES (v) keypad to increase or decrease the current number to the desired number selected from *Table 13*.
6. Press the START (enter) keypad when the desired status appears in the display. The new value is saved and the next option, “lRA”, will appear in the display.

**NOTE: To program “lRA” (IR Access [On/Off]), refer to *option 29*. To program other options, refer to the appropriate section.**

### How to Exit Programming Feature

Press the MED TEMP (<) keypad until the control returns to Ready Mode.

**How to Read Table 13**

Use this table to set the amount of time for Power Fail Reset.

“oFF” turns the option OFF. The current cycle status will be saved. When power is restored, the cycle will begin where it was interrupted.

If 133 is entered, the current cycle will be saved for up to five minutes. If power is not restored within five minutes, the control will erase the cycle status. The minimum power failure time is five minutes. The maximum power fail reset time is 127 minutes.

**NOTE: The default value is “oFF”.**

<b>“PFR”</b>	
<b>DISPLAY TO ENTER IN STEP 6</b>	<b>POWER FAIL RESET TIME</b>
“oFF”	Turned OFF. Cycle will be saved.
133	5 minutes without power before cycle is lost
. . . add one minute for every number up to	
255	127 minutes without power before cycle is lost

Table 13

## 29. IR Access (On/Off) “IrA”

This option allows the owner to enable or disable allowing the control to be read by an external device.

### How to Program the IR Access (On/Off)

1. Control must be in Manual Mode. Refer to *Entering the Manual Mode*.
2. Press the LOW TEMP (^) or the DELICATES (v) keypad until “Prog” appears in the display. Press the START (enter) keypad and “AtSH” will appear in the display.
3. Press the LOW TEMP (^) or the DELICATES (v) keypad to scroll through the programmable options until “IrA” appears in the display.
4. When “IrA” appears in the display, press the START (enter) keypad. The current IR Access status will appear in the display.  
“on” = Option Enabled  
“OFF” = Option Disabled

**NOTE: The default value is “on”.**

5. Press the LOW TEMP (^) or the DELICATES (v) keypad to change the current status.
6. Press the START (enter) keypad when the desired status appears in the display. The new value is saved and the next option, “rAEn”, will appear in the display.

**NOTE: To program “rAEn” (Manual Rapid Advance [On/Off]), refer to *option 30*. To program other options, refer to the appropriate section.**

### How to Exit Programming Feature

Press the MED TEMP (<) keypad until the control returns to Ready Mode.

## 30. Manual Rapid Advance (On/Off) “rAEn”

This option allows the owner to enable or disable the rapid advance feature. Refer to *Rapid Advance Feature* section for more information.

### How to Program the Manual Rapid Advance (On/Off)

1. Control must be in Manual Mode. Refer to *Entering the Manual Mode*.
2. Press the LOW TEMP (^) or the DELICATES (v) keypad until “Prog” appears in the display. Press the START (enter) keypad and “AtSH” will appear in the display.
3. Press the LOW TEMP (^) or the DELICATES (v) keypad to scroll through the programmable options until “rAEn” appears in the display.
4. When “rAEn” appears in the display, press the START (enter) keypad. The current Manual Rapid Advance status will appear in the display.  
“on” = Option Enabled  
“OFF” = Option Disabled

**NOTE: The default value is “on”.**

5. Press the LOW TEMP (^) or the DELICATES (v) keypad to change the current status.
6. Press the START (enter) keypad when the desired status appears in the display. The new value is saved and the next option, “dAEn”, will appear in the display.

**NOTE: To program “dAEn” (Manual Diagnostics [On/Off]), refer to *option 31*. To program other options, refer to the appropriate section.**

### How to Exit Programming Feature

Press the MED TEMP (<) keypad until the control returns to Ready Mode.



## 31. Manual Diagnostics (On/Off) “dAEEn”

This option allows the owner to enable or disable the manual diagnostics option. Refer to *Testing Machine and Electronic Control Functions* section for more information.

### How to Program the Manual Diagnostics (On/Off)

1. Control must be in Manual Mode. Refer to *Entering the Manual Mode*.
2. Press the LOW TEMP (^) or the DELICATES (v) keypad until “Prog” appears in the display. Press the START (enter) keypad and “AtSH” will appear in the display.
3. Press the LOW TEMP (^) or the DELICATES (v) keypad to scroll through the programmable options until “dAEEn” appears in the display.
4. When “dAEEn” appears in the display, press the START (enter) keypad. The current Manual Diagnostics status will appear in the display.  
“on” = Option Enabled  
“oFF” = Option Disabled

**NOTE: The default value is “on”.**

5. Press the LOW TEMP (^) or the DELICATES (v) keypad to change the current status.
6. Press the START (enter) keypad when the desired status appears in the display. The new value is saved and the next option, “PtEn”, will appear in the display.

**NOTE: To program “PtEn” (Production Test Cycle [On/Off]), refer to *option 32*. To program other options, refer to the appropriate section.**

### How to Exit Programming Feature

Press the MED TEMP (<) keypad until the control returns to Ready Mode.

## 32. Production Test Cycle (On/Off) “PtEn”

This option allows the owner to enable or disable access to the production test cycle. Refer to *Production Test Cycle* section for more information.

### How to Program the Production Test Cycle (On/Off)

1. Control must be in Manual Mode. Refer to *Entering the Manual Mode*.
2. Press the LOW TEMP (^) or the DELICATES (v) keypad until “Prog” appears in the display. Press the START (enter) keypad and “AtSH” will appear in the display.
3. Press the LOW TEMP (^) or the DELICATES (v) keypad to scroll through the programmable options until “PtEn” appears in the display.
4. When “PtEn” appears in the display, press the START (enter) keypad. The current Production Test Cycle status will appear in the display.  
“on” = Option Enabled  
“oFF” = Option Disabled

**NOTE: The default value is “on”.**

5. Press the LOW TEMP (^) or the DELICATES (v) keypad to change the current status.
6. Press the START (enter) keypad when the desired status appears in the display. The new value is saved and the next option, “AtSH”, will appear in the display.

**NOTE: To program “AtSH” (Heat Vend Price), refer to *option 1*. To program other options, refer to the appropriate section.**

### How to Exit Programming Feature

Press the MED TEMP (<) keypad until the control returns to Ready Mode.

# Collecting Audit Information

This feature allows the owner to retrieve audit information stored in the dryer by pressing a sequence of pads on the control. For an explanation of the audit options available, refer to the Audit Options List on this page.

## How to Enter Audit Feature

There are two methods the owner can use to enter the Audit Feature.

### Entering the Audit Feature by Manual Mode

1. Control must be in Manual Mode to start. Refer to *Entering the Manual Mode*.
2. Press the LOW TEMP (^) or the DELICATES (v) keypad until "AUDT" appears.
3. Press the START keypad. "CyC" will appear.

If the procedure did not work, the control will return to the Ready Mode.

### Entering the Audit Feature with the Coin Vault Open

1. Open coin vault. The service door must be closed, and have remained closed for 4.25 minutes.
2. Press the START (enter) keypad.

## How to Read Audit Data

1. Use the LOW TEMP (^) or the DELICATES (v) keypad to scroll through various options until the desired option is shown in the display. Refer to the Audit Options List, *Table 14*, for an explanation of the audit options available.

2. Once the desired option appears in the display, press the START (enter) keypad **once** to start the audit count. At this point, the display will show the first four-digit segment of the audit value. If the audit count is 10,000 or higher, press the START (enter) keypad again to view the last four digits of the number.

**NOTE: The display can show up to 4 digits at one time. Audit counts 10,000 or higher are separated into two 4-digit segments. Each time the START (enter) keypad is pressed in step 2, the display will show the next four-digit segment in the audit value.**

For Example: In the Total Number of Coins #1 option with "Coi1" shown in the display, the audit has counted 10,009 coins. Pressing the START (enter) keypad one time will show " \_ \_ \_ 1" to represent ten thousand. Pressing the START (enter) keypad a second time will display "0009" meaning nine. The total equals "00010009" or 10,009.

3. Press the START (enter) keypad again. The control will go to the next audit option in the Audit Options List.
4. To select other audit options, repeat steps 1 – 4.

## How to Exit Audit Feature

Press the MED TEMP (<) keypad until the control returns to Ready Mode.

**NOTE: To exit Audit Feature when using Coin Vault method, owner must close coin vault.**

Audit Options List	
Display	Description
"CyC"	Total # of machine cycles
"Coi1"	Total # of coins #1
"Coi2"	Total # of coins #2
"PLSE"	Total # of start pulses
"C1to"	Total # of coin 1 top-offs
"C2to"	Total # of coin 2 top-offs
"Pto"	Total # of start pulse/card reader top-offs

Table 14

# Manual Reset

This feature allows the owner to reset the dryer control's programming data to the factory default settings by pressing a sequence of pads on the control. For an explanation of the Factory Default Settings, refer to *Default Dryer Settings*.

## How to Enter Manual Reset

1. Control must be in Manual Mode to start.  
Refer to *Entering the Manual Mode*.
2. Press the LOW TEMP (^) or the DELICATES (v) keypad until "rSEt" appears.
3. Press the START (enter) keypad. The control will be blank until the programming is complete. Once the program has been reset, the control will revert back to the Manual Mode, displaying "diAg".

# Testing Machine and Electronic Control Functions

This feature allows the owner to run diagnostic tests on various dryer operations without servicing the dryer. The following tests are available:

- Control Software Version Number
- Service Door Opening Test
- Coin Vault Opening Test
- Coin Drop #1 Input Test
- Coin Drop #2 Input Test
- Start Pulse Test
- Dryer-on Temperature Test
- Thermistor Temperature Test
- Machine Configuration #1 Display Test
- Machine Configuration #2 Display Test
- Machine Configuration #3 Display Test
- Coin Header Present Status Test

For an overview of the manual diagnostic test feature, refer to the flowchart on the following page.

## How to Enter Testing Feature

1. Control must be in Ready Mode. If it is not, rapid advance through a cycle, refer to **Rapid Advance Feature**, or if coins or a card has been entered, refer to **Clear Vend Feature**.
2. Enter Manual Mode. Refer to **Entering the Manual Mode**.
3. Press the LOW TEMP (Λ) or the DELICATES (√) keypad until “diAg” appears.
4. Press the START (enter) keypad. Display will change to “d001” indicating the control software version number test.
5. Press the LOW TEMP (Λ) or the DELICATES (√) keypad to scroll through the diagnostic test options.

## How to Start Tests

To start a diagnostic test, refer to the quick reference chart below (*Table 15*). Press the START (enter) keypad when the desired test number is displayed. For detailed information on each test, read the appropriate description.

## How to Exit Testing Feature

Press the MED TEMP (<) keypad. The display will return to Ready mode.

Diagnostic (Testing) Mode – Quick Reference Chart		
Test Number	Diagnostic Mode	Display
“d001”	Control Software Version # Test	“S xx”
“d002”	Service Door Opening Test	“S oP” or “S CL”
“d003”	Coin Vault Opening Test	“U oP” or “U CL”
“d004”	Coin Drop #1 Input Test	“C1xx”
“d005”	Coin Drop #2 Input Test	“C2xx”
“d006”	Start Pulse Test	“Stxx”
“d007”	Dryer-on Temperature Test	“F---” or “C---”
“d008”	Thermistor Temperature Test	“Fxxx”, “Cxxx”, “SH” or “oP”
“d009”	Machine Configuration #1 Display Test	“bxxx”
“d010”	Machine Configuration #2 Display Test	“Cxxx”
“d011”	Machine Configuration #3 Display Test	“dxxx”
“d012”	Coin Header Present Status Test	“CHoP” (Open) or “CHCL” (Closed)

Table 15

## Testing Machine and Electronic Control Functions

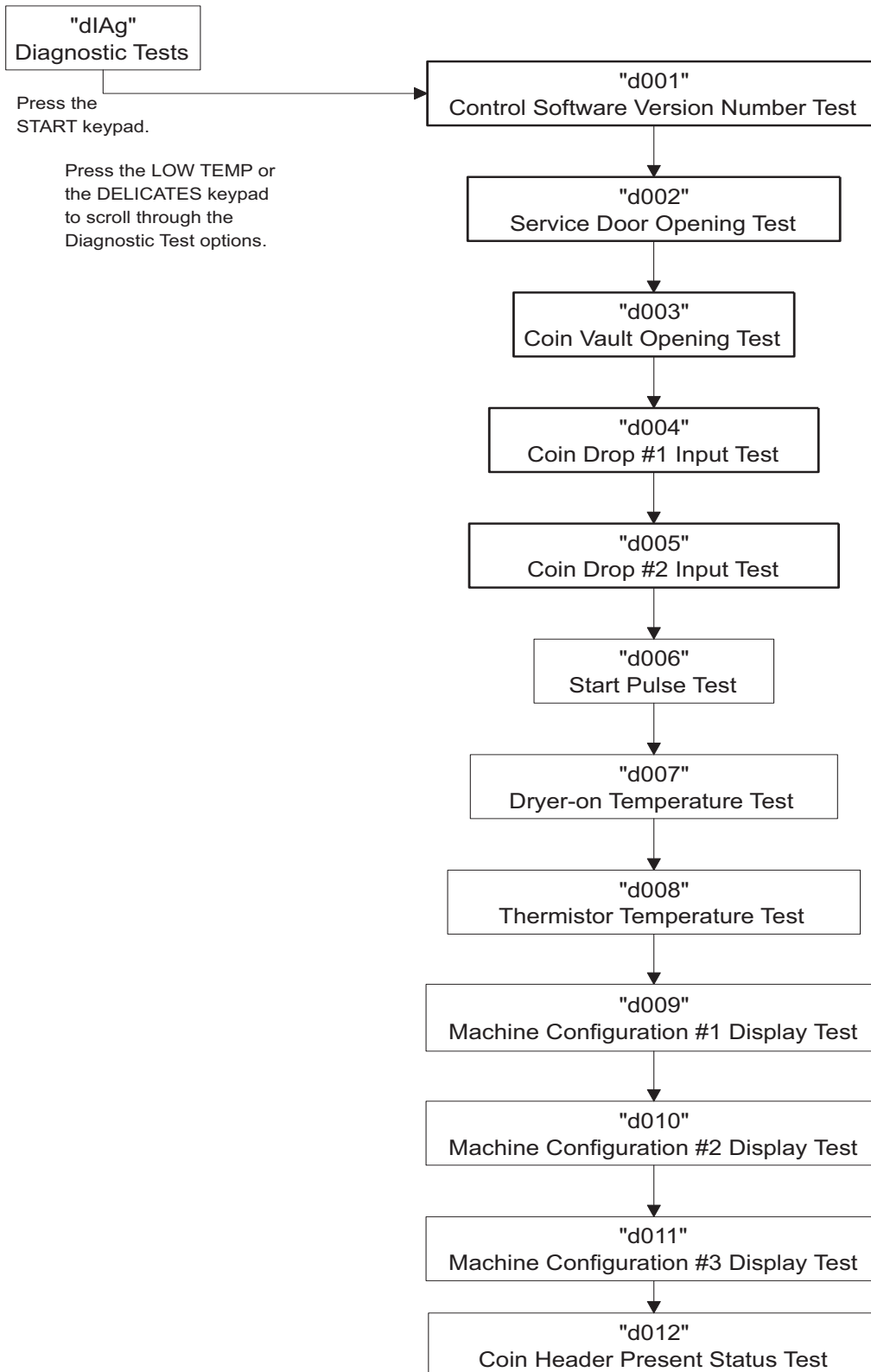

To enter a test, press the START keypad.  
To exit a test, press the MED TEMP keypad.

Press the START keypad.

Press the LOW TEMP or the DELICATES keypad to scroll through the Diagnostic Test options.

DRY583R

## Diagnostic Test Descriptions

### Control Software Version Number Test

This option displays the control software version number. To start test, control must be in the Testing Mode. Refer to “*How to Enter Testing Feature*” at the beginning of this section.

To enter, press the START (enter) keypad. The display will show “S xx” where “xx” is the software version number.

To exit the Software Version Number Test, press the MED TEMP (<) keypad. The control will return to the testing mode.

### Service Door Opening Test

This option tests the service door switch. To start test, control must be in the Testing Mode. Refer to “*How to Enter Testing Feature*” at the beginning of this section.

To enter, press the START (enter) keypad. The display will show “S oP” when the service door switch is open and “S CL” when the service door switch is closed.

The service door switch has to be closed for at least one second and opened for at least a half a second to make a valid count. This test will add counts to the service door opening counter for the audit and save the date/time for each opening of the test.

To exit the Service Door Opening Test, press the MED TEMP (<) keypad. The control will return to the testing mode.

### Coin Vault Opening Test

This option tests the coin vault switch. To start test, the control must be in the Testing Mode. Refer to “*How to Enter Testing Feature*” at the beginning of this section.

To enter, press the START (enter) keypad. The display will show “U oP” when the coin vault switch is open and “U CL” when the coin vault switch is closed.

The coin vault switch has to be closed for at least one second and opened for at least a half a second to make a valid count. This test will add counts to the coin vault opening counter for the audit and save the time/date for each opening of the test.

To exit the Coin Vault Opening Test, press the MED TEMP (<) keypad. The control will return to the testing mode.

### Coin Drop #1 Input Test

This option tests coin drop #1. To start test, control must be in the Testing Mode. Refer to “*How to Enter Testing Feature*” at the beginning of this section.

To enter, press the START (enter) keypad. The display will show “C1xx”. The “xx” will show the number of coins entered and will increment one for each coin entered in coin drop #1.

**NOTE: Coins entered in test mode will not increment the total # of coins counter that is accessed in the audit feature.**

To exit the Coin Drop #1 Input Test, press the MED TEMP (<) keypad. The control will return to the testing mode.

### Coin Drop #2 Input Test

This option tests coin drop #2. To start test, control must be in the Testing Mode. Refer to “*How to Enter Testing Feature*” at the beginning of this section.

To enter, press the START (enter) keypad. The display will show “C2xx”. The “xx” will show the number of coins entered and will increment one for each coin entered in coin drop #2.

**NOTE: Coins entered in test mode will not increment the total # of coins counter that is accessed in the audit feature.**

To exit the Coin Drop #2 Input Test, press the MED TEMP (<) keypad. The control will return to the testing mode.

### Start Pulse Test

This option tests the Start Pulse. To start test, control must be in the Testing Mode. Refer to “*How to Enter Testing Feature*” at the beginning of this section.

To enter, press the START (enter) keypad. The display will show “Stxx”. The “xx” will show the number of pulses entered. This test will add counts to the total number of Start Pulses counter.

To exit the Start Pulse Test, press the MED TEMP (<) keypad. The control will return to the testing mode.

## Dryer-on Temperature Test

This option tests the temperature inside the cylinder while running a cycle.

To start test, control must be in the Testing Mode. Refer to *“How to Enter Testing Feature”* at the beginning of this section.

To enter, press the START (enter) keypad. The display will show “F---” for degrees in Fahrenheit or “C---” for degrees in Celsius. The “---” will show the degrees.

To exit the test, press the MED TEMP (<) keypad. The control will then return to the testing mode.

## Testing Machine and Electronic Control Functions

### Thermistor Temperature Test

This option displays the temperature sensed at the thermistor in 5°F increments.

To start test, control must be in the Testing Mode. Refer to “How to Enter Testing Feature” at the beginning of this section.

To enter, press the START (enter) keypad. The display will show “Fxxx” or “Cxxx”. The “F” will show Fahrenheit, the “C” will show Celsius and the “xxx” will show degrees. If control senses a shorted thermistor, the display will show “SH”. If the control senses an open thermistor, the display will show “OP”.

To exit this test, press the MED TEMP (<) keypad. The control will return to the testing mode.

### Machine Configuration Display #1 Test

This option shows the machine configuration values. To start test, control must be in the Testing Mode. Refer to “How to Enter Testing Feature” at the beginning of this section.

To enter, press the START (enter) keypad. The display will show “bxxx”, with “xxx” a number corresponding to whether or not coin drops are connected, or serial card reader or network board are connected.

Refer to *Table 16* for test information.

To exit Machine Configuration Display #1 Test, press the MED TEMP (<) keypad. The control will return to the testing mode.

Machine Configuration Table

CONFIG VALUE	NETWORK BOARD PRESENT	CARD READER PRESENT	COIN DROP #2 PRESENT	COIN DROP #1 PRESENT
17	OFF	OFF	OFF	ON
18	OFF	OFF	ON	OFF
19	OFF	OFF	ON	ON
20	OFF	ON	OFF	OFF
25	ON	OFF	OFF	ON
26	ON	OFF	ON	OFF
27	ON	OFF	ON	ON
28	ON	ON	OFF	OFF

Table 16



### Machine Configuration Display #2 Test

This option shows the machine configuration values for the machine type.

To start test, control must be in the Testing Mode. Refer to “How to Enter Testing Feature” at the beginning of this section.

To enter, press the START (enter) keypad. The display will show “Cxxx”, with “xxx” the number corresponding to the machine type. For a dryer the value is “0”.

To exit Machine Configuration Display #2 Test, press the MED TEMP (<) keypad. The control will return to the testing mode.

### Machine Configuration Display #3 Test

This option shows the machine configuration values for the machine capacity.

To start test, control must be in the Testing Mode. Refer to “How to Enter Testing Feature” at the beginning of this section.

To enter, press the START (enter) keypad. The display will show “dxxx”, with “xxx” representing the machine capacity. Refer to *Table 17*.

To exit Machine Configuration Display #3 Test, press the MED TEMP (<) keypad. The control will return to the testing mode.

### Coin Header Present Status Test

This option tests the status of the coin header present jumper.

To start test, control must be in Testing Mode. Refer to “How to Enter Testing Feature” at the beginning of this section.

To enter, press the START (enter) keypad. The display will show “CHCL” if jumper is present and “CHoP” if jumper is not present.

To exit the Coin Header Present Status Test, press the MED TEMP (<) keypad. The control will return to the testing mode.

Value	Description
020	Dryer (unprogrammed)
021	Dryer – Single Pocket
022	Dryer – Stack
023	Dryer – Stack Lower Pocket
024	Dryer – Stack Upper Pocket

Table 17

## Testing Machine and Electronic Control Functions

### Production Test Cycle

#### To Enter Production Test Cycle

1. Be certain control is in Ready Mode, and access panel or coin vault is open.
2. While pressing and holding the HIGH TEMP keypad with one hand, press the LOW TEMP keypad with the other hand.
3. When the control enters the Production Test Cycle, it will first display “S xx” with the “xx” showing the software version of the control.

4. The control will advance through the sequence of test steps whenever any keypad is pressed, with the exception of the Keypad Test. Refer to *Table 18* for all tests in the Production Test Cycle.

#### To Exit Production Test Cycle

The test will be exited when the time reaches “00” on the control in Step #10. Otherwise, the control must be powered down to end the test.

Production Test Cycle Quick Reference Table		
Display	Test Mode	Comments
Sxx	Software Version	xx is the software version number.
Cxxx	Machine Configuration #2 Display Mode	xxx is machine configuration value.
Ct 4	Control Type	4 is the control type.
All LEDs and display segments will light	Show Entire Display Mode	The audio signal is turned off.
CxCx	Coin Drop Test	x is the number of coins entered. If dual coin drops are installed, coin drop #1 will be shown on the left of the display and coin drop #2 will be shown on the right of the display. If a single coin drop is used, only one coin count will increment.
U xx	Coin Vault Switch Test	xx is either oP to signify coin vault switch is open or CL to signify coin vault switch is closed.
S xx	Service Door Switch Test	xx is either oP to signify service door switch is open or CL to signify service door switch is closed.
Degrees in 5°F increments, SH, oP	Thermistor Temperature Test	The temperature will be displayed in either Fahrenheit or Celsius, depending on machine’s configuration (refer to <i>Programming Control, option 16</i> ). If control senses a shorted thermistor, SH will be displayed. If control senses an open thermistor, oP will be displayed.
PAdx	Keypad Test	When a key is pressed, the control will display the number assigned to the keypad (1 – HIGH TEMP, 2 – LOW TEMP, 3 – NO HEAT, 4 – MED TEMP, 5 – DELICATES, 6 – START). As each keypad is pressed, its corresponding LED will be lit and remain on for the duration of the test. When all keypads have been pressed, the control will advance to 10 minute test cycle.
10	10 Minute Test Cycle	Determines if dryer can function in a cycle for 10 minutes. START pad will flash one second on and one second off. The START pad can be used to decrease time remaining. If START pad is not pressed within 4.25 minutes, the control will return to Ready Mode.

**NOTE: If power to the control is turned off before 10 Minute Test Cycle has ended, the cycle will be cleared from control.**

Table 18

# Error Codes

Following is a list of possible error codes for an electronic control. Errors beginning with “EI” refer to external device Infra-red communication errors. Errors

beginning with “EC” refer to card reader errors. All other errors refer to machine errors.

<b>Display</b>	<b>Description</b>	<b>Cause/ Corrective Action</b>
EI01	Transmission Failure	Communication failure. Re-aim external device and try again.
EI02	Device Time-out	Communication failure. Re-aim external device and try again.
EI03	Invalid Command Code	Incorrect machine type. Before downloading, ensure data is for current machine type.
EI04	Command Packet Time Out	Communication failure. Re-aim external device and try again.
EI05	Invalid or Out-of-Range Data	Incorrect machine type. Before downloading, ensure data is for current machine type and values entered are within the minimum and maximum limits.
EI09	CRC-16 Error	Communication failure. Re-aim external device and try again.
EI0A	Framing Error	Communication error. Re-aim external device and try again.
EI0C	Time-out Exceeded	Communication error. Re-aim external device and try again.
EI0E	Encryption Error	Incorrect machine type. Before downloading, ensure data is for current machine type.
EI0F	Invalid Wake-up or Infra-red Disabled	Communication failure or infra-red is disabled. Manually enable infra-red on control or re-aim external device and try again.
EC02	Time-out Error	Communication failure. Try card again.
EC03	Invalid Command Code	Incorrect machine type. Before downloading, ensure data is for current machine type.
EC05	Invalid or Out-of-Range Data	Incorrect machine type. Before downloading, ensure data is for current machine type and values entered are within the minimum and maximum limits.
EC11	No Card Reader Initialization	Communication is valid, but there is no card reader initialization. Power down, power up and try again.
EC18	No Communication	Card reader initialized, communication lost. Power down, power up and try again. If error persists, replace control or card reader.

Table 18 (Continued)

**Error Codes**

Table 18 (Continued)

<b>Display</b>	<b>Description</b>	<b>Cause/ Corrective Action</b>
EC19	No Card Reader Communication and No Card Reader Initialization	Communication failure. Power down, power up, check connections and try again. If error persists, replace control or card reader.
EC36	Audit Card Removed Prematurely	Re-insert Audit Card and wait until machine prompts for card removal.
Right most decimal point Lit	Network Communication Error	Communication problem. Wait for 1.5 minutes for error to clear. If error doesn't clear, power-down and power-up the machine. Check all network connections. If error persists, replace control or network board.
ALrn	Break-in Alarm Error	Service the service door or coin vault switches.
oFF	Break-in Alarm Shutdown Error	Service the service door or coin vault switches.
Err	Coin Error	Invalid coin pulse or inoperative coin sensor. Check coin drop area and remove obstructions. If error persists, tampering may have occurred. Evaluate security procedures.
ESH	Shorted Thermistor Error	Remove any lint build-up around thermistor. If problem persists, replace control or thermistor.
EoP	Open Thermistor Error	Remove any lint build-up around thermistor. If problem persists, replace control or thermistor.

Table 19

# Rapid Advance Feature

The Rapid Advance feature allows the owner to quickly advance through active cycles or advance into a cycle from the ready mode.

## How to Enter Rapid Advance from Ready Mode

1. If control is in Ready Mode, control must be put into Manual Mode. Refer to *Entering the Manual Mode*.
2. Press the LOW TEMP (^) or the DELICATES (v) keypad until “rAPd” appears in the display.
3. Press the START (enter) keypad. The display will show “PUSH” then Strt” followed by the cycle time.
4. Press the START (enter) keypad to start cycle.

While in the Rapid Advance Mode, pressing the START (enter) keypad will advance the cycle time by one minute. Pressing and holding the START (enter) keypad will advance the cycle four minutes for every second the START (enter) keypad is held down.

## How to Enter Rapid Advance During an Active Cycle

1. Be certain service door is open.
2. While pressing and holding the HIGH TEMP keypad with one hand, press the MED TEMP keypad with the other hand. The display will show “rAPd”.

Control may be in an active cycle or in the ready mode to use the Rapid Advance feature.

## How to Exit Rapid Advance Feature

1. Advance through the cycles until reaching the ready mode.

**NOTE: The Manual Rapid Advance option must be turned on for Rapid Advance to work. Refer to option 30 in Programming Control.**

# Clear Vend Feature

The Clear Vend feature allows the owner to clear a control which is in the middle of satisfying the initial vend price, and set it back to the ready mode.

**NOTE: The Clear Vend Feature does not work with Additional Vend Mode or Additional Cycle Top-Off.**

## How to Clear Vend

1. Open the service door. Refer to *Opening the Service Door*. The coin vault must remain closed.
2. While pressing and holding the MED TEMP keypad with one hand, press the LOW TEMP keypad with the other hand. The control will reset to the ready mode.

# Power Fail Recovery

The Power Fail Recovery feature allows the cycle status to be saved in memory in the event of a power failure.

If a cycle is in progress when the power fails, the cycle status is saved in memory. When power recovers, the control will determine whether to automatically continue the cycle from the point it left off, requiring the user to press the START pad to continue the cycle, or end the cycle and put the control into the Ready Mode. To program this feature, refer to *Programming Control*.

## Power Fail Reset Disabled

If the Power Fail feature is disabled, the control will resume the cycle from the point it left off after the START pad is pressed.

## Power Fail Reset Enabled

If the length of the power failure is less than the programmed Power Failure Reset time, the control will resume the cycle from the point it left off. The cycle will resume after the START pad is pressed.

If the power failure lasted more than the programmed power failure reset time, the control will end the cycle and will return to the Ready Mode.

# Communications Mode

## Infra-red Communications

The Infra-red Communications feature allows the control to communicate with an external device. The control can be programmed and have its data read without using the keypad. It may also be used to start and stop various diagnostic tests.

### How to Begin Communications with An External Device

The control will go blank and the display will show “-C-” until the communication is complete. The display will return to the previous mode. If an error occurs that terminates communication, the display will show “Elxx” (“xx” represents the error code).

**NOTE: The Infra-red Communications option must be turned on. Refer to *option 29* in *Programming Control*.**

## Card Reader Communications (Card Models Only)

The Card Reader Communications feature allows the control to communicate with the card reader. The control can be programmed and have its data read without using the keypad.

## Network Communications

The Network Communications feature allows the control to communicate with a network. The control can be programmed and have its data read without using the keypad.