

Non-Verbal Predication and Head-Movement

by

Andrew Hay Carnie

Bachelor of Arts,
Linguistics and Celtic Studies
St. Michael's College, University of Toronto
(1991)

Submitted to the Department of Linguistics and Philosophy
in partial fulfillment of the requirements for the
degree of

Doctor of Philosophy

at the

MASSACHUSETTS INSTITUTE OF TECHNOLOGY
August 1995

© 1995 Andrew Carnie
All rights reserved

The author hereby grants to MIT permission to reproduce and to distribute publicly
paper and electronic copies of this thesis document in whole or in part.

Signature of Author _____
Department of Linguistics and Philosophy
June 9, 1995

Certified by _____
Kenneth L. Hale
Ferrari P. Ward Professor of Modern Languages and Linguistics
Thesis Supervisor

Accepted by _____
Wayne O'Neil
Head, Department of Linguistics and Philosophy

Non-Verbal Predication and Head-Movement

by

Andrew Hay Carnie

Submitted to the Department of Linguistics and Philosophy on June 9, 1995
in partial fulfillment of the requirements for the
degree of Doctor of Philosophy

ABSTRACT

This thesis surveys the interaction between non-verbal predication in matrix clauses and processes of head-movement. Focusing mainly on the syntax of Modern Irish nominal predicates, it is claimed that matrix non-verbal predication can occur without any verbal support. When this happens, non-verbal predicates bear inflectional features directly and behave just like verbs with respect to processes of head-movement. In particular, it is claimed that non-verbal predicates raise through the inflectional complex to the highest inflectional head, just like verbal predicates in matrix VSO clauses.

It is also claimed that complex phrasal predicates are allowed to undergo head-movement, contra many standard assumptions. A new theory of phrase structure based on Chomsky's Bare Phrase Structure is proposed, where phrasal status (i.e. X-bar status) is determined by behavior of the phrase-marker involved, rather than the status determining the behavior. This derived notion of X-bar status is shown to account for a variety of phenomena from a variety of languages (such as construct state nominals in Celtic and Tagalog clitic placement).

The thesis also argues that the distribution of word order types from Irish copular clauses argues against a unified or single *be* analysis. It is claimed that at least two types of copular construction: a one placed predicative construction, and a two placed equative construction are present in the grammar. Structural asymmetries between the two arguments in equative constructions are shown to follow from their behavior with respect to theta marking.

Finally, a new analysis of Verb-Subject-Object (VSO) order is presented which accounts for a wide variety of phenomena, including non-verbal predicates, in the syntax of Modern Irish. This analysis makes use of verb raising, a split VP structure, and a new view of clausal architecture.

Dissertation Committee: **Kenneth Hale (chair)**
 Ferrari P. Ward Professor of Languages and Linguistics

Morris Halle
Institute Professor of Linguistics

Alec Marantz
Associate Professor of Linguistics

David Pesetsky
Professor of Linguistics

Acknowledgments

Like almost every other linguist, whenever I open up a thesis, one of the first things I turn to is the acknowledgments pages to see who is thanked. Before I started on this work, it always struck me that acknowledgments were over-effusive and self-serving, filled with "I couldn't possibly have done this without the help of ..." and "this was nearly impossible without the help of..." etc. I thought that writing a thesis couldn't possibly be *that* difficult. But truth be known, now that I'm done, I see that none of the acknowledgment pages that I have read were exaggerating. Writing a thesis *really* is a difficult task and there is absolutely no way it could be done without the help of a huge number of people. So now I begin the task of giving my thanks to people who have helped me enormously over the years in preparation for this. I only want you all to know that a measly three pages of thank-yous cannot possibly begin to relieve the debt I owe you all.

A more helpful committee could not be found than mine. Ken Hale, my chair, is not only one of the best linguists alive, he is also without doubt the most caring and kind. Despite an overly hectic schedule as a teacher, president of the LSA, language revivalist, polyglot, field researcher and member of uncountable committees, Ken always found time to meet with me, provide me with leads, criticisms, and support. (not to mention the fact that he caught many missing *fadas* in earlier drafts!) *Go raibh mile maith agat, a Ken*, I'll truly miss working with you. Morris Halle is one of the greats and I'm truly honored that he was a member of my committee. From my earliest moments here at MIT, Morris has kept me "honest" as a linguist, has challenged my assumptions and pushed me to pursue ideas that I might have otherwise dismissed. His wisdom in matters linguistic is only excelled by the amount of support he gives to his students. The same could be said of Alec Marantz. Alec, who came not only to be a professor, but a good friend, often seemed to understand my theory better than I did! He was always available not only for advice about linguistics, but also for linguistic politics, job hunting, computers, and life in general. My education here at MIT wouldn't have been the same without the valuable input of David Pesetsky. David, who is also a stunning lecturer, allowed me the honor of taking over half of his "Topics in Syntax" class this past year to run a seminar on VSO order. By allowing me to do this David essentially gave me a forum to do my thesis research (and reading), with the input of some 50 top researchers in the field. This was absolutely invaluable, and led to much of the work found in chapters 2 and 3 of this thesis. Once again my heartfelt thanks to all my committee.

My education here at MIT wasn't just the result of my committee, however. I was privileged to take classes with some of the finest teachers in the field today. One of the great honors of going to school at MIT is the opportunity to work with Noam Chomsky, an experience I will never forget. My intellectual debt to him is enormous. I also benefited enormously from meetings, lectures and discussions with Jim Harris, Jim Higginbotham, Irene Heim, Michael Kenstowicz, Utpal Lahiri, Howard Lasnik, Shigeru Miyagawa, Wayne O'Neil, Ken Wexler, and Kai von Stechow.

I never would have become a linguist if it wasn't for the support, encouragement and instruction from the fabulous faculty at the University of Toronto. I was lucky enough to meet with, attend classes under, and receive a great deal of attention from the following people in /tra:no/ both in the Linguistic and Celtic Studies Departments: Ed Burstynsky, Barb Brunson, Strang Burton, Elizabeth Cowper, Ann Dooley, Elan Dresher, Diane Massam, Máirín Nic Dhiarmada, Peter Reich, Keren Rice, Hank Rogers and Tom Wilson. All of these people were very important to my undergraduate education and to my desire to work on Irish and linguistics, however, I'd like to single four of them for their outstanding role in my life. The first university level class I ever walked into was Liz Cowper's 'Intro to Linguistics'. This was a room of

approx. 200 faceless scared undergrads, within a few weeks, Liz knew almost everyone's name, and had turned us all on to one of the funnest fields around. Two years later, at the beginning of my advanced syntax course, I was amazed that Liz still remembered my name. It was Liz who pushed me to pursue syntax as a field of study, and Liz will always be my inspiration for the ideal teacher. I was lucky enough to have Elan Dresher not only as a professor but as a supervisor for my teaching stint at Toronto. As both an instructor and boss, Elan was the most conscientious and caring person I know. As a night owl myself, I can honestly say that there is nothing more helpful than a professor who is in his office at 11:00 at night. I wrote my first paper on the Irish Copula for Diane Massam's Topics in Syntax class. This entire thesis is an outgrowth of that paper. Her early encouragement to pursue this is not easily forgotten. Finally, I'd like to thank Keren Rice, whose status as a role model for me almost turned me into a phonologist! Keren is always there to help students both in work and in their personal lives.

Although I've only ever taken classes at the University of Toronto and at MIT, there are a number of linguists who have had a great influence on me over the past few years. In particular there is the small, but close-knit community of Celtic linguists. Of special mention are two people who have never failed to encourage me in everything to do with Irish syntax, no matter how crazy and misguided my ideas: Jim McCloskey and Eithne Guilfoyle. Many others have given encouragement and comments through out this and other work: Paolo Acquaviva., David Adger, Stephen Anderson, Bob Borsley, Anna Bosch, Susan Clack, Siobhán Cottrell, Cathal Doherty, Nigel Duffield, Anthony Green, George Halliday, Randy Hendrick, John Koch, John McCranie, Máire Ní Chiosain, Máire Noonan, Donall Ó Baoill, Elizabeth Pyatt, Gillian Ramchand, Ian Roberts, Koldo Sáinz, Robin Schafer, Jim Scobbie, Peter Slomanson, Nancy Stenson, Maggie Tallerman, and Lori Zaring. My thanks to them all.

It would be impossible to write a thesis on a language other than your own without the help of patient informants. For this I'd like to thank Máirín Nic Dhiarmada, Máire Ní Chiosain and Donall Ó Baoill. They never hesitated to give me good and useful judgments and corrections even when the results weren't what I was hoping for! I'm sure there are mistakes in the data in this thesis but it should be emphasized that these are *my* faults and mistakes not those of my language consultants.

This thesis could never have been completed without the careful eye of people who read it out of the goodness of their own hearts for content, style and typos: Masha Babyonyshev, Jonathan Bobaljik, Cathal Doherty, Heidi Harley, Colin Phillips, Norvin Richards, V.J. Sarma, Martha Sullivan and Dana Sussman. Several other people gave me helpful comments on other work that is related to this: Josef Aoun, Judy Baek, Pilar Barbosa, Liz Cowper, Danny Fox, Anthony Green, Jacqueline Guéron, Jila Ghomeshi, Caroline Heycock, Diane Jonas, Howard Lasnik, Andrea Moro, Elliott Moreton, Martha Jo McGinnis, Rosanne Pelletier, Orin Percus, Betsy Ritter, Michael Rochemont, Michele Sigler, Höskuldur Thráinsson, Lisa Travis, Hubert Truckenbrodt, Hiro Ura, James Yoon, Marie Therèse Vinet, Rachel Walker, as well as all the Celticists above and the participants in VSO seminar at MIT fall 1994. I sure hope I haven't forgotten someone. If I have, you have my sincere apologies. I really did appreciate your input!

Several organizations and people are to be thanked for their financial and administrative help over the years. Right before I came to MIT, the Department of Linguistics at the University of Toronto was kind enough to give me a very well paid job, which allowed me to save enough money to make the move to Boston. The Department of Linguistics here at MIT, has been kind enough to pay my hefty tuition for the past few years, as well as pay for some pretty fun conferences around the world. My first two years here at MIT came with funding from the Alberta Heritage Fund, and my last three with support from the Social Sciences and Humanities Research Council of Canada. Uncle MITWPL has also made sure that I've never starved, and been able to go to all the conferences I want. I'd like to thank the RTG grant holders David Pesetsky and Ken Wexler for the use of the computers and printers in the RTG room. The support staff here are a treasure, I've really appreciated the personal attention they've all given me: Marilyn Goodrich, Rachel Pearl, Jen Purdy, Bev Stohl, Linda Thomas, and Jamie Young. On a totally different note, I'd like to thank attorney Steven Hope for his help with that "little legal problem" in my thesis year, he made it as painless as possible at a very busy and stressful time. Maya Honda will forever be associated with chocolate in my mind; thanks Maya!

What would MIT have been like without my classmates? A very sad place I think. Fortunately, however, I was blessed with a class of smart and friendly colleagues who not only made life here a thousand times more fun, but helped me with assignments, papers, thesis and stray random thoughts. Thanks guys! Masha Babyonyshev's work always seemed to intersect with mine, I hope it will more in the future. Masha, get over the hair, eh? Heidi Harley is doubtless one of the kindest, most thoughtful, loyal friends a person could ever have. She has been a constant companion over the past two years, doing things I want to do even if she doesn't (Hey Heidi, folkdancing turned out to be fun after all didn't it?!?!? Flick, snork, I win.). She was always there when I needed an ear to hear my woes, or a shoulder to cry on. MIT would have been a

very lonely place if not for her. She is also one of the best linguists I know, and probably the most modest. There is almost nothing in this thesis that hasn't come out of lengthy discussions with her over dinner or coffee. I will miss her when I leave here, and feel greatly privileged to have known her. Shawn Kern, was a close buddy from the time we went for lunch on that first day here at MIT. A brilliant guy, *fear alainn*, a great salesman, patient roommate, and a good friend. Thanks for all the pool, Shawn, as well as for helping me pass semantics. Good luck with whatever you decide to do. Masa Koizumi, although the quietest of a rowdy crowd was always a happy presence at any of our many social gatherings. His comments on some of my earlier work on VSO were invaluable and have led me to greater things. Renate Musan, half of our stunning germanic contingent, constantly reminded us of the importance of both play *and* work. Orin Percus, a thespian and semanticist of the highest level, has always been a bright enthusiastic light for us all to follow, not a bad dinner companion either. Ciao Orino! (insert large dramatic hand gesture here). Colin Phillips and I always seem to take opposite sides on any issue or debate, yet I cannot think of someone I end up agreeing with more. Colin was the first classmate I ever met, and I hope he will remain a close friend throughout my career. Finally, Hubert Truckenbrodt entertained us always with his bright spirits and interesting dance style. Ling-91, I'll miss you all. By some magic feat, my class also been lucky enough to inherit classmates from other years. Pilar Barbosa's work on clitics and word order has been a big influence on mine and she has been a friendly companion in those late night thesis writing sessions in the RTG room. Jonathan Bobaljik, minimalist magician, BPS-Brahmin and the Indiana Jones of linguistics, has not only been a good friend, but a patient and hard-working co-author. I could go on like this for hours writing a sentence or two about how special all the students here have been to me, but then the acknowledgments would be longer than my thesis, so I'm afraid there has to be a list. You all know what you've done for me: Judy Baek, David Braun, Tony Bures, Chris Collins, Diana Cresti, Hamida Demirdache, Danny Fox, Delia Graf, Tom Green, Paul Hagstrom, Marthajo McGinnis, Kumiko Murasugi, Rolf Noyer, Rob Pensalfini, Taylor Roberts, V.J. Sarma, Carson Schütze, Uli Sauerland, Chris Tancredi, Hiro Ura, Akira Watanabe, MIT's great social director: Susi Wurmbrand, and always last but never the least Andrea Zukowski. On a related note, my school mates at Toronto (notably: Peter Avery, Becky Carpenter, Carrie Dyck, Jila Ghomeshi, Zvi Gilbert, Amy Green, Päivi Koskinen, Regina Moorcroft, Jennifer Ormston, Rebecca Smolet, Sharon Rose, Rachel Walker, Tom Wilson and Hitay Yüксеker) always were there when I needed a good Tequila Bonding.

I wouldn't want anyone to think (except perhaps my committee) that the only reason I came to MIT was to work on linguistics. Not true at all! Boston is the center of one of the biggest and best folk dance and music communities. I'd like to thank all my friends in the MITFDC for all the good times, in particular, I'd like to thank Marilyn Richards for always looking out for us spacy thesis writers. Vinovana (a.k.a. the PG) holds a very special place in my heart-- the one that I probably will have the hardest time letting go of. I will miss you all, but in particular Deniz, Martha, Elliott, Dale, Jen, Kim, John, Dana, Elizabeth, Mari, Heidi and Chris. *Bivaj!* Chris Ricciotti, as well as being a sweet supportive guy, introduced me to the world of contra dance in my last year here. There is no doubt in my mind that the LCFD dancers played a pivotal part in my retaining my sanity this past year. And Chris, *mo stoirín*, stay just the way you are. There are also some friends of mine that don't fall into the varied categories I've sketched above, over the years they have each been very important to me and I'd like to thank them for all the fun times: Stefan Abt, Anne Alton, Roger Haessel, Slavko Ivankovic, Jason McVean, Kevin Rasmussen and Peter Slomanson.

It goes without saying that I wouldn't be here without my family. My sisters Fiona and Morag, through fun and fights, have always kept a careful eye on their little bro. My mother, Jean Carnie, has always been there ready to help me in any way she can, always filled with love. My father, Robert Carnie, a kind man and a true scholar, has been, without doubt, my inspiration to become an academic. I love them all very much and owe them more than any few sentences on a page like this can express.

Well, I think that's it, those are the people I want to thank for helping me write this monster. So perhaps my acknowledgments at times seemed over-effusive or self-serving, but I assure you all that they are totally heartfelt and true. Four years has been too short, but every moment has been worth it. *Go raibh maith agaibh!*

As•berat trá augtair na nGoídel combad sí tucait airic in bérla Féne gním n-ingnad n-indligthech for•chaemnacair isin domun .i. comtach in tuir Nemruaid ... Is and íarum ro•ríaglad a mbér-la-sa: a mba ferr íarum do cach bérlu & a mba leithiu & a mba cáimiu, is ed do•reped isin nGoídilc...

"Now the authors of the Irish say that the cause of the invention of the language of the Féni [Irish] was a strange wonderful deed that took place in the world i.e. the construction of Nimrod's tower [at Babel]... It is there then that this language was given its rules: what was best then of every language and what was widest and finest was cut out into Irish..."

*Auraicept na nÉces*¹ (Irish Grammar dating from the early Old Irish period (c. 600-800AD))

¹Translation and text taken from Ahlqvist (1982)

Table of Contents

Chapter 1. The Problem and Initial Assumptions	15
1.1 The problem	15
1.2 Organization	18
1.3 Some initial assumptions	21
1.3.1 Minimalism and the Minimalist Program	22
1.3.2 Phrase structure: a starting point	24
1.3.3 Movement as feature checking: a starting point	25
1.3.4 Predication	28
1.4 Now let's get on with it.	30

PART 1. HEAD MOVEMENT IN IRISH SYNTAX

Chapter 2. A Short history of VSO	33
2.0 Introduction, 33	33
2.1 Flat structure	35
2.2 Subject lowering	48
2.3 Verb raising analyses I	55
2.3.1 Irish ellipsis as evidence for raising	56
2.3.2 Raising to C°	59
2.3.2.1 McCloskey (1992b): evidence against raising to C°	61
2.3.2.2 Old Irish: a language with raising to C°	66
2.4 Chapter summary	78

Chapter 3. Modern Irish VSO order	79
3.0 Introduction, 79	79
3.1 Verb Raising Analyses II: Raising to INFL /AGR/T	81
3.1.1 VP internal subjects	81
3.1.2 The Great Irish Infinitive dialect debate	85
3.1.2.1 The facts of Irish infinitives	87
3.1.2.2 Chung and McCloskey/McCloskey and Sells	90
3.1.2.3 Duffield (1990, 1991)	91
3.1.2.4 Noonan (1992)	95
3.1.2.5 Bobaljik and Carnie (1992, forthcoming)	98
3.1.2.6 Guilfoyle (1994)	105
3.1.2.7 Summary	109
3.2 A Theory of Irish VSO order	110
3.2.1 The issues	110
3.2.2 A revised system of functional categories	111
3.2.3 Recent Perfectives, and Infinitives	116
3.3 Chapter Summary	123

PART 2 HEAD-MOVEMENT AND NON-VERBAL PREDICATION IN IRISH

Chapter 4. The Verb <i>to be</i> in Irish.	127
4.0 Introduction	127
4.1 <i>Is</i> is not a verb	130
4.1.1 <i>Is</i> as a particle	130
4.1.2 Morphological evidence	133
4.1.3 Phonological evidence	134
4.1.4 Evidence from language shift	136
4.1.5 Evidence from language acquisition	136
4.1.5 Summary	137
4.2 Where <i>Is</i> and <i>Tá</i> are found.	137
4.2.1 The distribution	138
4.2.2 Doherty 1992	140
4.2.3 Carnie 1993	143
4.3 Why the apparent stage/individual level split?	146
4.4 Conclusion	148
Chapter 5. Accounting for the Word Order Alternations	151
5.0 Introduction: The three <i>Is</i> orders	151
5.1 Two types of Nominal predicates	154
5.2 The Predicative and Equative constructions in Irish	157
5.3 Case	160
5.4 The agreement morpheme	164
5.5 Pronominal Subjects of COP: rightwards movement	168
5.6 Reciprocal binding	170
5.7 The Highest Subject restriction	173
5.8 Conclusion and Summary	179
Chapter 6. What's a phrase like you doing in a head like this?	183
6.0 Introduction	183
6.1 The status of the notions <i>Head</i> and <i>Phrase</i>	184
6.1.1 A short history of phrase structure	186
6.1.2 The Bare Theory of phrase structure	188
6.2 Evidence for the X° status of nominal predicates	191
6.2.1 Evidence from wh-extraction	192
6.2.2 Evidence from the responsive system	195
6.2.3 Section Summary	197
6.3 The Mechanics of an XP that behaves like an X°	198
6.4 What does the morphology do with these complex X°s	205
6.5 How the theory explains a problematic Irish construction	207
6.6 Extensions of the bare theory approach to X° and XP	210
6.6.1 Tagalog Clitic Placement	211
6.6.2 Construct State Nominals	215
6.7 A few potentially related phenomena	218
6.7.1 Dutch Resultatives	219
6.7.2 Yiddish Periphrastic Verbs, the Stem construction and the Particle construction	221
6.7.3 Yoruba derived phrasal nominals	223
6.7.4 The Modern Persian <i>Ezafe</i> Construction	226
6.8 Conclusion	229

PART 3 ALTERNATIVES AND EXTENSIONS

Chapter 7. Other theories of <i>be</i> word order alternations	233
7.0 Introduction	233
7.1 "Unified" Theories of copular constructions	237
7.1.1 Heggie (1988)	237
7.1.2 Moro (1991,1993), Heycock (1991, 1992)	239
7.2 Against a UBA account of Irish	241
7.2.1 Why the Irish word alternations are not canonical/inverse distinctions	242
7.2.2 Evidence in favor of the MBA	245
7.2.4 Accounting for the English inverse canonical asymmetries	247
7.3 Conclusion	248
Chapter 8. Other theories of <i>be-less</i> copular sentences	251
8.0 Introduction	251
8.1 ECP accounts of <i>be-less</i> sentences	252
8.1.1 Heggie (1988, 1990)	252
8.1.2 DeGraff (1992)	254
8.1.3 Section Summary	257
8.2 Doherty (1992, forthcoming)	257
8.3 Conclusion	261
Chapter 9. Concluding Remarks	263
Appendix. The morphology of <i>to be</i>	267
Bibliography	271

Chapter One

The problem and some initial assumptions

1.1 The Problem

Identifying individuals and attributing properties to them can surely be considered one of the primary properties of language; this is the function of predication. Of particular interest are sentences in which the verbal element, if there is one, plays little or no role in determining predication relations; instead NPs, APs, or locative PPs take on the role of predicate. In this thesis, I provide an account of several interacting problems of non-verbal predication. I am going to make the following claims, in increasing order of controversiality:

- i) In many languages, such as Modern Irish, matrix non-verbal predication¹ can appear without an overt verb of any kind.
- ii) There is more than one kind of copular construction; i.e., there are both predicative and equative structures, and these differ in their argument structure.
- iii) In some languages, non-verbal predicates may behave exactly like verbal ones with respect to the syntax of head-movement.
- iv) Under certain specific conditions complex, apparently phrasal, nominal predicates may undergo head-movement.

¹By "matrix non-verbal predication", I mean constructions roughly equivalent to English "be". I will use this term and the term "copular" interchangeably here, even when I am talking about constructions that lack a verbal copula.

Let us consider each of these claims in a little more detail. First, I will claim that under certain conditions, non-verbal predicates in copular constructions appear without any kind of verbal support at all. That is, they have a structure where the non-verbal predicate directly takes an inflectional complex (here represented as IP for convenience) without an intervening verbal *be*, null or otherwise.

1)

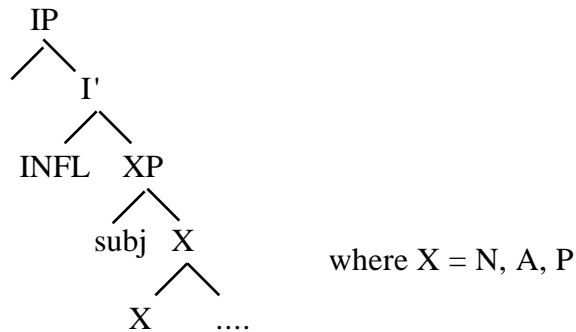

In adopting (1), I follow Rapoport (1987) and Déchaine (1993), among many others, and differ from Heggie (1988), among many others. This kind of structure makes certain predictions concerning the movement of predicates. In particular, it predicts that in languages such as Modern Irish which both exploit verb raising strategies and have structures like that in (1), non-verbal predicates undergo, under appropriate circumstances, head-movement (Travis 1984) exactly equivalent to verb raising:

2)

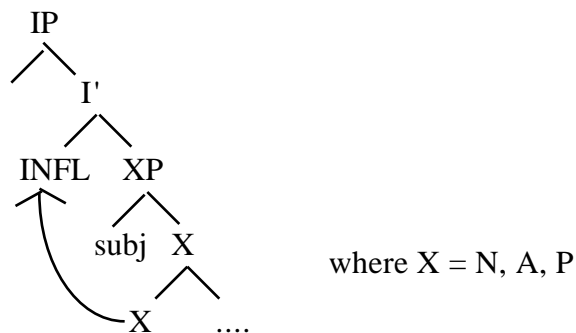

In fact, I am going to make an even more radical claim than (2): I claim that *phrasal* non-verbal predicates can undergo head-movement. This, of course, will require a serious revision of our notion of what an X° or an XP is. I make the highly surprising claim that

there is no primitive phrase/head distinction. I claim, instead, that rather than the phrasal or head status of a phrase marker determining its behavior, the behavior of the p-marker determines its head or phrase status. Since X-bar status is a derivative notion, I will show that complex nominal predicates can behave like words with respect to head-movement.

Finally, I take issue with several recent proposals that there is a single "be" construction throughout languages. Many authors (Partee 1986, Heggie 1988, Heycock 1991, 1992, Moro 1991, 1993, DeGraff 1992 among many others²), following the Fregean tradition, assume that there is no structural difference³ between the two sentences below in (3):

- 3) a) John is a doctor
- b) John is the doctor

These authors all claim that the argument structure of both these sentences involves one NP functioning as a predicate, the other as a subject:

- 4) NP2 (NP1)

I argue that this approach is false. I argue, following Rapoport (1987) among many others, that the sentence in (3b) involves a two place "equative" verb (COP) that takes both NPs as arguments:

- 5) COP(NP1, NP2)

This equative verb, I claim, is not a true "=" relation in the mathematical sense. Rather, I claim that the relation is asymmetrical and that the two arguments bear different theta roles (attribute and attribute recipient).

²For a more complete list, see chapter 7.

³other than, of course, the difference in determiner type.

1.2 Organization

The thesis will be organized as follows. Part one provides some background information on Irish syntax. The bulk of data in this thesis concerning non-verbal predicates comes from Irish. Irish is a VSO language:

- 6) Leanann an t-ainmní an briathar i nGaeilge
 follow.PRES the subject the verb in Irish
 ‘The subject follows the verb in Irish’

In chapter 2, I provide a historical survey of the literature on VSO order. I show there that Flat Structure, Subject Lowering, and Raising to C° analyses of VSO order are inadequate to deal with the facts of Irish and many other VSO languages. In chapter 3, I provide an account of Irish VSO order that makes use of verb raising to the highest inflectional head, and the raising of the arguments via NP movement to the specifiers of case assigning inflectional heads. To account for certain problems of adverbial placement, word order in infinitives, auxiliaries, and aspectual morphology, I propose certain revisions to the architecture of heads:

7)

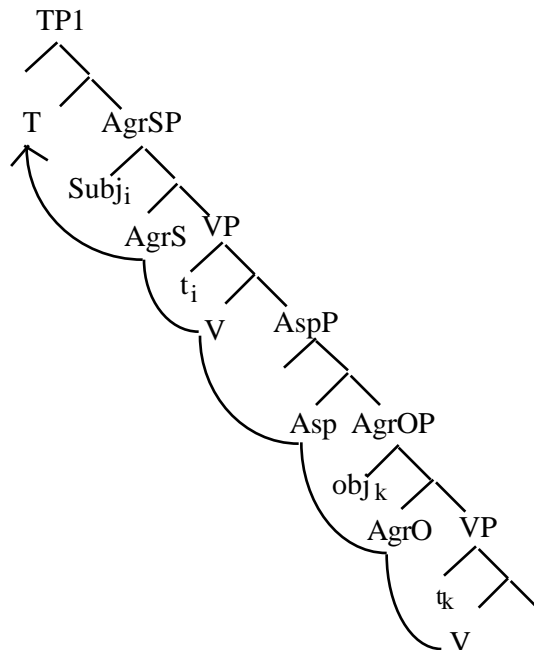

(7) shows this revised architecture as well as the location of arguments and verbs in Irish. Of interest in this structure is the fact that there are two inflectional complexes separated by a VP. Both inflectional complexes consist of a tense projection (T or ASP) which dominates case-assigning Agreement nodes. The higher VP is headed by a light verb which introduces external arguments. In Irish, I claim, the verb raises through all the inflectional heads (and the upper light verb) to rest in the highest T. The subject NP raises to the specifier of AgrSP, where it receives case. It does not raise any further, thus resulting in VSO order. In a parallel manner, objects raise to the specifier of AgrOP. Evidence for this proposal comes from infinitives, auxiliary placement, and adverbials.

In part II, we turn to non-verbal predication in Modern Irish. In chapter 4, I take a look at the various kinds of Irish copular constructions. There, I show after Doherty (1992, forthcoming) that the traditional Irish copula *Is* bears many of the characteristics of a complementizer particle, rather than a verb. I then go on to claim that under appropriate circumstances, such as when they bear inflectional features, non-verbal predicates in Irish do not require verbal support. Rather, I claim that they take inflectional features directly and undergo head-movement to the front of the clause just like verbs. When they do not bear inflectional features, they require verbal support in the form of the verb *Tá*. The difference between *Tá* and *Is* constructions, I claim, is not one of the stage/individual level distinction of Carlson (1977), but is rather one of what elements are allowed to undergo head-movement in a given language. The apparent correlation between the stage/individual level distinction and the *Is/Tá* distinction, I claim, is a straightforward consequence of whether the predicate needs verbal support or not. The fact that *Is* predicates never have stage level readings correlates, I claim, with the fact that they don't have light verb support. I claim, following Harley (forthcoming), who is extending a claim by Kratzer (1993), that light verbs are required to introduce event arguments. If stage level predicates are simply individual level predicates plus a Davidsonian event argument (Kratzer 1988) and light

verbs are required to introduce such event arguments, then it follows that when there is no light verb, only individual level readings will be available. This is the case in Irish.

In chapter 5, I turn to some word order alternations within the syntax of Irish copular clauses. I claim there that the differences in word orders between the sentences in (8) follows only from a theory of copular constructions that distinguishes predicative from equative copular constructions.

- 8) a) Is é Seán an platapas
C agr John the platypus
"John is the Platypus"
- b) Is platapas (é) Seán
C platypus agr John
"John is a Platypus"

In particular, I claim that order (8a) is reflective of an equative construction where both NPs are arguments connected by some abstract equative predicate. The order in (8b), on the other hand, is derived via the head-movement of a true NP predicate. This predicate takes a single NP argument.

In chapter 6, I take up the problem of complex nominal predicates in Irish. In chapter 4, I propose that nominal predicates that appear in the *Is* construction undergo head raising in Irish to initial position around their subjects, just like verbs. This may look problematic when it comes to sentences such as (9):

- 9) Is *amhrán a^L bhuailfidh an píobaire* **"Yellow Submarine"**
C song C play.fut. the piper
"'Yellow Submarine' is a song which the bagpiper is going to play"

In this sentence the entire NP predicate (in italics) precedes the subject (in bold). We have here a sentence which I claim involves head-movement; however, a phrase appears in the position of the head-moved constituent. Rather than claiming that this is a problem for my theory, I claim that this is evidence against a primitive notion of phrase or head. I follow work in Chomsky's (1994) *Bare Phrase Structure*, in claiming that phrasal status is

determined by a p-marker's behavior with respect to output conditions rather than the behavior being determined by the X-bar status. I present evidence from the responsive/ellipsis system and from extraction phenomena that the phrasal predicates such as that in (9) are behaving like X°s. I then extend this analysis to construct state nominals in Irish and to copular constructions in Tagalog.

Chapter 7 begins part III of this thesis. This part takes a brief look at previous proposals concerning non-verbal predication and copular word order alternations. In chapter 7, I examine the various "unified be" analyses of copular word order alternations (Heggie (1988), Heycock (1991, 1992), Moro (1991, 1993)) and show that their approaches do not argue for a single copular *be* construction. Further, I show that the canonical/inverse alternation of Moro (1991) and Heycock (1991) is not the same alternation as the predicative/equative alternation discussed in chapter 5. Finally, in Chapter 8, I discuss previous accounts of non-verbal predication without verbal support. I show that accounts of the distribution of agreement morphology in languages such as Irish, Hebrew, and Haitian cannot possibly fall out from ECP effects. Further, I show that Doherty's (1992, forthcoming) account misses several important generalizations about Irish syntax in general. The broad empirical failure of these other approaches thus provides support for the analysis given in part II.

1.3 Some Initial Assumptions

Before turning to the issues at hand, I would like to sketch out some initial assumptions. Throughout this thesis, I modify many of these assumptions (especially in chapters 3 and 6.) However, by listing these assumptions here I provide a starting point from which to view the rest of the thesis.

1.3.1 Minimalism and the Minimalist Program

This thesis is written within the version of the principles and parameters framework commonly known as *minimalism*. Early work in generative grammar (such as the standard theory, generative semantics, and the extended standard theory) concentrated primarily on determining mechanisms for describing and generating all the sentences of natural language. Later work in the 1970s and 1980s, such as, for example, the so-called *Government and Binding* (GB) framework (Chomsky 1981), focused on limiting the scope of generative power by increasing the role of constraints in grammar and limiting the power of generative rules. This research produced an enormous range of constraints and syntactic relations. Throughout much work late in the GB era, attention started to shift to notions of economy and simplicity (e.g. Rizzi 1990, Chomsky 1991). Chomsky's (1992, 1993) *Minimalist Program for Linguistic Theory*^{4,5} (henceforth MPLT) proposes to extend notions of economy and simplicity to their logical end point⁶. He proposes to reduce the conceptual machinery of the grammar to only the "conceptually necessary" components, eliminating as many stipulations as possible. For example, he eliminates such relations as Government, replacing them with the more local specifier/head and head/complement relations.

The minimalist program also eliminates all D-structure and S-structure conditions on the grammar. The only conditions on derivations are "output conditions"—those that hold at the levels of phonetic form (PF) and logical form (LF). Sentences are simple pairings of well-formed PF and LF representations. The generation of these levels may be

⁴A note in order here about exactly what variety of Chomskyan "minimalism" I am adopting here. All of the work in this thesis was conducted prior to the publication of Chomsky (1995a). For this reason, it does not adopt any of the mechanisms (e.g., Affect-F) discussed therein. Minimalism as described in this thesis is minimalism *a la* Chomsky (1992, 1993).

⁵Apart from my recasting of the clausal architecture in chapter 3, I am fairly consistent with canonical minimalism. One way in which I differ from Chomsky, however, is that I assume late insertion of morphological items. See chapter 6 for discussion.

⁶For an excellent and clear discussion of the MPLT see Marantz (1995a).

parallel for an early part of the derivation of the sentence. The stage at which the derivations diverge is called *SPELLOUT*. *SPELLOUT* has no formal status in the grammar, other than being the dividing line between PF and LF derivations. There are essentially two kinds of operations in minimalism: overt and covert operations. Overt operations occur before the level of PF (thus are "pronounced"); covert operations occur after *SPELLOUT* on the way to LF. The structure of the grammar thus looks something like (10):

10)

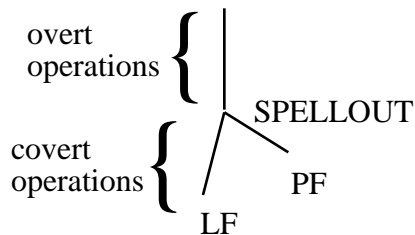

The determination of when an operation occurs (i.e. overtly or covertly) is a function of language-specific conditions specified in a language's inflectional morphology. Movement of XPs and X^os occurs for reasons of convergence. Terminal nodes in trees are inserted with inflectional features attached. The principle of *greed* requires that these inflectional features must be checked against an inflectional head to insure they match other inflectional features in the sentence. This feature checking may occur via head-to-head-movement (in the case of predicates) or via movement to the specifier of a phrase (in the case of arguments)⁷. The grammar prefers to wait until after *SPELLOUT* (covertly), if it can, to do such feature checking. This is the principle of *procrastinate*. *Procrastinate* is counteracted by "strong" morphological features which need to be checked before both LF and PF. If a language allows such features to appear in a phrase marker, then movement for checking must occur overtly (before *SPELLOUT*), so that the features can be checked before both LF and PF. If this movement does not occur, then at the level of PF the strong features will not be checked and the derivation will *crash* (i.e. not converge). A principle of *Full*

⁷Chomsky (1994) reduces these operations to the operations of MERGE and MOVE. See Chapter 6 for more discussion.

Interpretation applies which requires that before a relevant interface level all features that must be checked are checked. If this does not occur, the derivation is said to crash.

Language-specific syntactic variation in this view is simply a matter of the differing strengths of the inflectional features involved and, consequently, the stage at which SPELLOUT occurs. The derivation, movement, and LF of all languages is identical. Language-specific variation lies simply in where the derivation to PF breaks off from the derivation to LF.

Movement within the syntax (both overt and covert) is constrained by yet another principle. That is the minimality constraint of *shortest move*. Shortest move requires that all movement take the shortest path available to it. Following an observation of Holmberg (1986), Chomsky ties movement of objects to the head-movement of the verb. Movement of the verb to an inflectional head allows an object NP to move to the specifier of that head (for a contrasting view see Zwart (1995)). This is the intuitive notion behind Chomsky's principle of *Equidistance* and is often called Holmberg's generalization.

Now that I have outlined the basic outline of the model of grammar proposed in the MPLT, I will sketch some relevant details. Again in many cases the points sketched below are meant only as starting points from which we will depart.

1.3.2 Phrase Structure: a Starting Point

For the first 5 chapters of this thesis, I am assuming a version of Jackendoff's (1977) proposal that phrase structure is constrained by an X-bar schema. Every head (X°) projects to a maximal category (XP); it may take a complement (sister to head) which must be phrasal. It may also have a specifier (sister to unit of complement and head):

11)

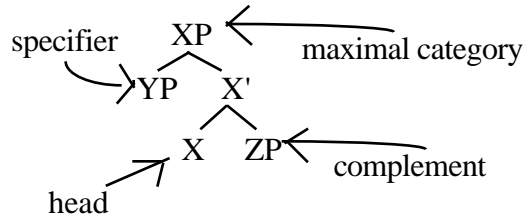

These notions are primitive and determine the behavior of a phrase marker in the syntax. In chapter 6, following Chomsky (1994) *Bare Phrase Structure*, I reject this approach and claim that X-bar status of a particular phrase marker is determined by its behavior. The assumptions underlying this claim are sketched out in chapter 6.

1.3.3 Movement as Feature Checking: A Starting Point

Chomsky (1991, 1992, 1993) assumes that the underlying architecture of the clause is:

12)

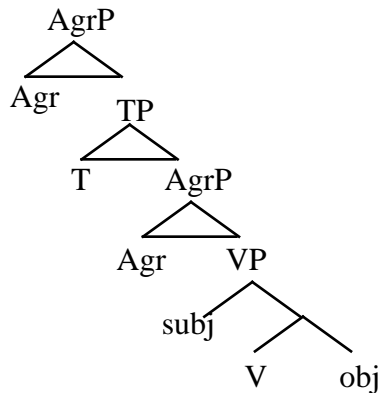

The clause consists of an inflectional complex and a VP shell. The VP shell contains the verb, its complement, and, following Kuroda (1986), Fukui and Speas (1986) among many others, its subject. The inflectional complex consists of two non-distinct AgrPs, one for the subject and one for the object, and a TP. In chapter 3, we will make extensive revisions to this architecture, proposing a split VP and two inflectional complexes each consisting of a Tense node dominating an Agr node (see (7) above).

Chomsky (1991,1993) has suggested that both structural cases (i.e. nominative and accusative) are realized in a parallel manner, via movement (either overtly or covertly) of the arguments to positions within the inflectional complex. Specifically, it is suggested that *all* agreement and structural case is the realization of a specifier/head relationship with an appropriate functional (Agr) head. As the agreement heads are non-distinct⁸, the case with which each is associated is determined by the nature of the element which adjoins to it. The accusative case, being in some sense a verbal attribute, must be realized in the specifier/head relationship with the complex head [V, AgrO] derived via the first step of the head-to-head-movement of the verb when the verb is transitive.

13)

ACCUSATIVE CASE:

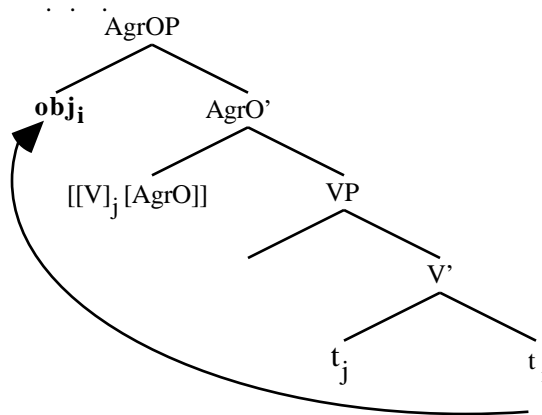

By similar logic, head-movement of Tense (T) to AgrS will create the complex head [T, AgrS], and nominative case will be realized in a specifier/head relationship to this head.

⁸In this framework, they are only a collection of relevant -features such as person, number, and gender.

14)

NOMINATIVE CASE:

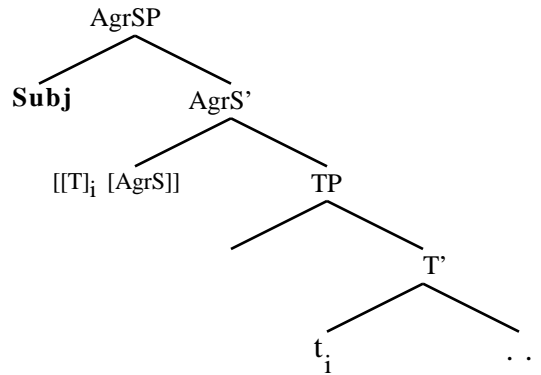

As discussed above, the motivation for such movement prior to SPELLOUT, when this occurs, comes from the strength of the inflectional features involved. Chomsky (1992, 1993) proposes that each of the heads (Tense and the two Agrs) have N[ominal] and V[erbal] features which may be parameterized with either a “strong” value or a “weak” one. Strong features are required to be checked in the derivation by Spell-Out (i.e. in the overt syntax), while weak features need not be. The interaction of these features with independent principles (for example, Procrastinate) will dictate whether certain steps of the derivation occur overtly or covertly. The N-features correlate with the specifier positions, governing NP movement, and the V-features with the heads, governing head-movement^{9, 10}

⁹Let us consider how this system accounts for the difference between English and French discussed in Pollock (1989) and Chomsky (1991). French is a language which exploits overt verb raising; English is not. This is represented here by the feature valencies in (i) (as presented by Bobaljik and Carnie (1992, forthcoming) contra Chomsky (1992, 1993)):

i)

		English	French
AGR	N	weak	weak
	V	weak	strong
Tense	N	strong	strong
	V	strong	strong

Strong features must be checked in the overt syntax. As N-features are correlated with the specifier/head relationship, the specification *strong* for the N-feature of Tense in both languages requires that an NP argument raise to check its features in the specifier/head configuration with Tense overtly. This, in essence, is what ultimately derives the requirement that all sentences have a subject (i.e. the “Extended Projection Principle” of Chomsky (1981); see Harley (forthcoming) for an alternative view). By hypothesis (Chomsky 1993), both English and French require that Tense raise overtly to AgrS to check its N features. This is encoded by a strong valence for the V-features of Tense, requiring overt raising (head-movement) of T to AgrS to check these features. This raising will mean that the specifier of the Tense Phrase is not licensed for feature-checking, despite its strong N feature. In order for the strong N-features of Tense to be checked, then, an NP-argument (the subject) will have to raise overtly to the specifier of the complex head [AgrS T+AgrS] resulting from the head-movement of Tense to AgrS. This is illustrated schematically in

1.3.4 Predication

This is a thesis about non-verbal predication; however, I am going to have almost nothing to say about what "predication" is. The issue of what "predication" is the subject of a great deal of literature, which I will not review here. See Williams (1980, 1983a, 1983b, 1994), Stowell (1983, 1991), Safir (1987), Higginbotham (1987), Culicover and Wilkins (1984), Napoli (1987b), Baltin (1995), Kearns (1989), Stroik (1994), Hoekstra (1988), Zwart (1992), Rothstein (1983), Higgins (1976), Bowers (1993), Rapoport (1987), and Déchaine (1993) for more discussion. These authors differ on whether predication is identical to theta marking or is a binding relation; whether it is a syntactic relation or a semantic one; whether it requires mediation of a "predicate" head or not; and whether or not it is represented by a [+Predicate] feature. These issues need not concern us here. For the purposes of this thesis I assume the common-sense approach presented in Stroik (1994). Roughly, this approach holds that predication is an LF requirement that "unsaturated" predicates must be saturated, either through base generation in a small clause

(ii)

ii)

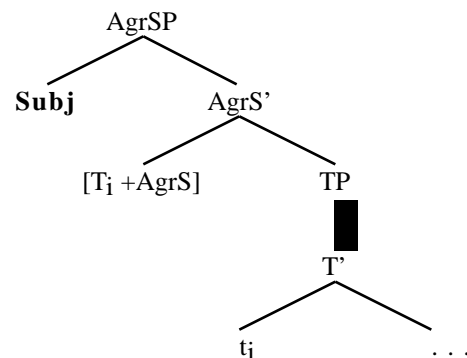

There are three distinct head-movement processes in English and French: (1) T moves to AgrS, (2) V moves to AgrO, and (3) [V + AgrO] moves to AgrS. The first movement is overt in both languages as required by the strong V-features of Tense. The remaining movements are governed by the V-features of the Agr nodes. In English, the V-features of Agr are weak and thus only the raising of Tense to AgrS occurs overtly, whereas in French, the V-features of Agr are strong and the both of the remaining head-movements occur overtly, with all (finite) verbs raising in the visible syntax. Following Pollock (1989) and Chomsky (1991,1993) this accounts for the differences between the two languages. The only relevant difference between the two languages then is in the specification for the V-features of AGR.

¹⁰What has been called the Head Movement Constraint (HMC) (Travis 1984) is also subsumable under Shortest Move. I will use the HMC terminology throughout this thesis to disambiguate cases of Short Move constraining argument movement and Shortest Move constraining head movement.

structure or by movement before LF. Saturation is accomplished by indexation of the subject with the predicate. See Stroik's paper for more discussion.

1.4 Now, Let's Get On With It

In this chapter, I have given a rough sketch of issues under consideration in this thesis and the controversial conclusions that I will draw. I've also provided a rough sketch of a set of starting assumptions underlying much of the work in this thesis. However, I reserve the right to (and will) modify these assumptions as the thesis goes on. Now, let's get on with the issues at hand.

Chapter Two A Short History of VSO Order¹

2.0 Introduction

This chapter is the first in a two-chapter discussion on the nature of the derivation of Verb-Subject-Object (VSO) order. In this chapter, I will present a short history of the various analyses of the derivation of VSO in the literature,² for both Irish and for VSO languages in general. In chapter 3, I focus narrowly on the syntax of Irish, where I present some previous analyses of Irish within an approach that assumes the verb raises only as high as the left edge of the inflectional complex. I present there an analysis of Irish VSO order there that resolves many of the empirical problems of previous analyses.

Given that this is a thesis about non-verbal predication the reader might be curious why I am choosing to devote two chapters to the behavior of verbal predicates in Irish. The answer is simple: in order to explain the behavior of non-verbal predicates with respect to head-movement, we must first determine how Irish derives its basic word order with verbal predicates. In particular, we must determine whether Irish exploits overt verb raising, and if it does, to what functional category this raising occurs. We must also ask what the

¹The section on Old Irish in this chapter is a revised version of Carnie, Pyatt and Harley (1994).

²For other histories of the derivation of VSO order see Duffield (1991) and Fassi Fehri (1993).

surface positions of the arguments are.

Irish is a VSO language, as is seen in (1):

- 1) Leanann an t-ainmní an briathar i nGaeilge
follow. PRES the subject the verb in Irish
'The subject follows the verb in Irish'

This kind of word order is problematic for any theory of grammar that relies on verbs and objects functioning as a single syntactic unit excluding the subject. Since the verb and object in Irish are not contiguous— they are separated by the subject— it would be surprising if they behaved like a syntactic unit (under the not unreasonable assumption that syntactic constituents must be contiguous). Interestingly, as will be seen below, they do behave like such a unit. In this chapter, I will explore the issues surrounding the derivation of VSO order³ and the history of treatments of VSO in the generative paradigm, with a particular focus on the derivation of Irish word order. The reader who is not interested in such a survey may wish to skip directly to Chapter 3, where more recent analyses of Irish VSO are presented and where I present an account based on the principles and assumptions of the minimalist framework.

In the principles and parameters framework, it has long been assumed that simple differences in word order are the result of binary parameter settings such as the headedness and specifier parameters. For example, SVO order is derived by assuming that both heads and specifiers appear on the left of the phrase structure tree. Similarly, SOV order can be derived by switching the headedness parameter to the right (Speas 1990). It would be a pleasing result if we could derive VSO order in a similar way, i.e., in the form of a VSO parameter as suggested by Sproat⁴ (1985). A recurring theme of this chapter, however, will be that this is not a realistic goal, and that (as is noted by McCloskey (forthcoming)) there

³I will focus here on the derivation of VSO; for a look at the typological correspondences to VSO order see Myhill (1985).

⁴Sproat's VSO parameter is, in fact, not a phrase structure parameter, but one based on the directionality of Case assignment. This will be discussed in more detail below.

is no single VSO parameter. Different VSO languages, despite their surface similarity, may very well derive the order very differently. Although we will examine many different languages, the focus of this and the next chapter will be on how the different theories of VSO apply to Irish.

I wish to give one brief *caveat lector* before we start. The historical survey section of this chapter covers a wide number of languages in a wide number of theories with many diverse assumptions. These assumptions are, in many cases, not consistent with each other. Throughout I will skip from time period to time period within the history of generative syntax. Wherever possible, however, I will try to make clear what particular framework and set of assumptions are being used. In chapter 3, on the other hand, I will remain closely within the spirit and assumptions of the Minimalist Program sketched above in chapter 1 and will deal almost exclusively with Modern Irish. The discussion presented in this chapter is not in any way an argument for the analysis of Irish VSO presented in chapter 3. Rather, the work in chapter 3 should stand on its own for empirical reasons. Again, those readers not interested in a survey and discussion of the VSO literature may want to skip directly to chapter 3, where my analysis of Irish VSO is presented. This said, let us look at the syntax of VSO from a historical perspective.

2.1. Flat Structure in the Syntax of VSO.

Early work in the generative grammar of VSO languages, such as Schwartz (1972), Anderson (1984), Awberry (1976), Tallerman (1990), Stenson (1981), McCloskey (1979, 1980), and Chung (1983), assumed that VSO languages differed from SOV and SVO languages in lacking a VP phrase structure rule:

- 2) a) SVO: S NP VP
 VP V NP
- b) VSO: S V NP NP

This class of languages, then, had a “flat structure” for its underlying word order⁵:

3)

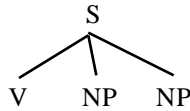

Such a structure makes very clear predictions about the behavior of the subject and object arguments. As noted by Berman (1974), who was replying to McCawley’s (1970) VSO analysis of English, it predicts that subject and object NPs, since they are both post-verbal, should not be distinguishable in contexts where only one NP argument appears. In other words, Verb-Object sequences and Verb-Subject sequences should behave identically with respect to various syntactic processes. Anderson and Chung (1977) argue that this is not true for many languages that are clearly VSO. Samoan and Tongan, two VSO languages of the South Pacific, show demonstrable differences between VO and VS sequences in the interaction of Equi-NP Deletion and Subject-to-Object Raising⁶ — two rules that make reference to subjects and not to objects. If the VO and VS sequences are structurally indistinguishable, then verbs that allow both Equi and Subject-to-Object Raising to apply should allow Subject-to-Object Raising to apply to objects, provided Equi has applied to delete the subject in an embedded context. This prediction is false, as seen in the following Samoan data.

- 4) a) ‘Ua mânana’o tagata e mâtô i le pâlota
perf want-pl people fut win in the election
“People wanted to win in the election”

⁵I will not discuss here the two arguments that have been advanced in favor of flat structure for VSO languages, since, as will be seen below, the evidence against such an approach is overwhelming. The first of these arguments is presented in Chung (1983), where she argues that the subject position in Chamorro is properly governed, thus accounting for the lack of that-trace effects and Sentential Subject Constraints in that language. I refer the reader to Sproat (1985) for extensive criticism of this approach, and to Chung (1990) for a reinterpretation of these facts. The second argument has to do with the binding facts of Jacalteco discussed in Woolford (1991). This will be discussed briefly below.

⁶In more modern terminology these are Subject Control, and Exceptional Case Marking (ECM). In order for their argument to follow, we are required to assume the pre-Principles and Parameters characterization of these processes, i.e., that there aren’t any null arguments, such as PRO, in the representation that could disambiguate VS from VO (in the form of V PRO O). Their argument then is not really consistent with more recent assumptions. However, the empirical facts do show, as will be seen below, that VSO languages distinguish subjects from objects, contra Berman (1974).

- b) E mânana'o tagata i le pâlotā 'ia manuia
 fut want-pl people at the election unreal be-well
 "People want the election to turn out well"
- c) *Sâ mânama'o tageta i le gaoi e pu'e
 past want-pl people at the burglar fut catch
 "People wanted the burglar to catch"

The Samoan verb *mana'o* 'want' allows Equi-NP Deletion, as in (4a), as well as Subject-to-Object Raising, as in (4b). Given that we could create a control context in which the subject of an embedded transitive clause was deleted via Equi-NP Deletion, the order VO would result in the embedded clause. If VO and VS sequences are not distinguished in the grammar of a language, then this should act as a valid input to the rule of Subject-to-Object Raising. As shown in (4c) this is incorrect, the object cannot undergo Subject-to-Object Raising; thus, it is clear that Samoan does, indeed, distinguish subjects from objects. Anderson and Chung present similar evidence from Tongan clitic marking and Breton object marking to show that these languages also distinguish subjects and objects⁷.

Typological arguments against a VP-less analysis (like that in (2)) of VSO languages were first presented in Emonds (1980), based on Greenberg's (1966) universals. In particular, Emonds argued that VSO languages are all derived from SVO structures. His observations based on the typology of VSO languages are quite insightful and foreshadow much later work on the head movement of verbal predicates. First, he notes that VSO languages are much rarer than SVO languages⁸. This, he claims, follows directly from the fact that VSO order is always derived, and SVO is a base order; the more derivation, he claims, the rarer the word order type. Woolford (1991) points out that given our current assumptions about V to INFL movement in SVO languages such as French (see for example Pollock 1989), such an argument cannot hold, since many SVO languages also

⁷It should be noted, as an aside, that in fact Anderson and Chung are not arguing against a flat structure representation of VSO languages. Instead, they are arguing for a model, like that of Relational Grammar that distinguishes subjects from objects as a primitive of the grammar, rather than trying to derive these relations from linear order with respect to the verb (cf. Berman 1974)

⁸Tomlin (1984) claims that 46.8% of the world's languages are SOV, 43.6% are SVO, and 9.6% are VSO.

have derived word orders. She accounts for the relative rarity of VSO by the fact that there are simply more ways to derive SVO than VSO (i.e., via head movement to various functional projections, or via non-verb movement).

Emonds' second typological argument is harder to dispute. Greenberg's Sixth Universal says that all languages with a VSO order also have an alternate SVO order⁹. The alternations between SVO and VSO would be entirely arbitrary under a flat structure analysis. However, if VSO is derived from SVO, then the correlation between the two orders is direct: SVO alternates are simply the cases where the verb-fronting rule has failed to apply.

Greenberg's universal number 12 is:

“If a language has dominant order VSO in declarative sentences, it always puts interrogative words or phrases first in interrogative word questions; if it has dominant SOV order in declarative sentences, there is never such an invariant rule.”

In other words, in VSO languages, complementizers —especially interrogative ones— (and frequently inflectional elements as well) are initial in their clause. Emonds correlates this property to what he considers to be the cause of verb movement in VSO languages. Foreshadowing much later work (see section 2.1.3 below), he claims that verb fronting is due to some morphological feature of the Complementizer head. He bases this on a principle he attributes to den Besten (1977):

⁹It is unclear to me what exactly “an alternate SVO” order means here. We may end up comparing structures that are totally unlike. For example, clauses that involve *wh*-movement, or tenseless clauses, rarely have the same word order as tensed clauses. Do these count as “alternate” orders? Or do only ordering alternations in clauses of a like-type count as “alternate orders”? We must be careful with such claims not to compare apples and oranges. Some languages such as Arabic appear to allow some type of SVO/VSO alternation in root clauses. Irish, on the other hand, never allows SVO in simple tensed root clauses — these must always be VSO. It does allow SVO order in tensed clauses, but only where the subject has been demonstrably fronted via *A*-bar movement for some kind of topicalization (as is shown by the presence of a [+*wh*] complementizer). SVO order is also found in tenseless clauses in some dialects. A related issue concerns what constitutes a “*V*”. For example, with auxiliaries, do participles constitute “*V*”s or not? If they do, then Irish allows an Aux SVO order. If they don't, then this clause type is clearly VSO. A more careful examination of Greenberg's universal is in order here, determining, in more rigorous terms, what is being compared before we draw any strong conclusions about the theory based upon it.

“All instances of movement to a pre-subject position by a grammatical transformation are attraction to a sentence initial Comp.”

Given this type of principle, the strong correlation between VSO order and clause initial complementizer particles is obvious: VSO order is caused by the clause initial particles. If we were to have a base VSO order, then the correlation between the order and clause initial particles would be mysterious; there would be no direct link between VSO order and clause initial particles.

Now turning away from typology, a great body of empirical evidence has surfaced showing that many VSO languages do not have a flat, underived VSO order. In a great many languages, there are sequences of untensed verbs or participles and objects that function as syntactic constituents, reminiscent of Verb Phrases. McCloskey (1983a) shows that participles and objects in Irish form syntactic constituents. This constituent consists of the progressive participle and object (**bold-faced** in the sentence below):

- 5) Tá na Clingeánaí **ag scaoileadh na féasar**
 Be.pres the Klingons prog fire the phasers-gen
 “The Klingons are firing the phasers”

These sequences obey several standard tests for constituency in Irish. Only maximal projections may be clefted, and more specifically only one maximal projection may be clefted at a time. For example, a direct object and an indirect object may not be clefted together:

- 6) *[Ull][don ghasúr] a thug sé
 apple to-the boy wh gave he
 “It was an apple to the boy that he gave”

In contrast, the progressive participle and the direct object can be clefted together:

- 7) Má’s **ag cuartughadh leanbh do dhearbhrathra** a tá tú ...
 if+C prog seek child your brother wh-are you...
 “If it is seeking your brother’s child that you are ...”
 (McCloskey 1983a: 14)

Similar facts are found in Breton:

- 8) **Lenn eul levr brezhoneg** a ran bembez
to-read a book breton wh do-1sg everyday
“Read a Breton book is what I do everyday”
(Anderson and Chung 1977: 22)

and in Welsh:

- 9) **Gweld y ci** y mae'r dyn
See the dog wh be-the man
“It is seeing the dog that the man is”
(Sproat 1985: 178)

McCloskey also notes that the participle and object can be the focus of the *ach* ‘only’ particle, an honor reserved only for constituents in Irish (McCloskey 1983):

- 10) **Ní raibh mé ach ag déanamh grinn**
Neg be.past I only prog make fun
“I was only making fun” (McCloskey 1983a: 20)

There thus seem to be ample examples of VP-like constituents in VSO languages, lending strong support to the idea that VSO order is derived from some structure that has a VP constituent.

Driving the final nail into the coffin of flat structure for VSO languages is evidence concerning the relative prominence of subjects and objects. In flat structure, subjects and object are sisters to one another, as is seen in (3), repeated here as (11):

11)

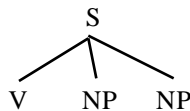

Given this, we expect that there will be no structure dependent subject/object asymmetries in VSO languages. Once again, this prediction is proven false. First, there is strong evidence from the binding theory¹⁰. For example, in Irish, a reciprocal¹¹ in subject position

¹⁰Duffield (1991) presents similar evidence of subject/object asymmetries which are not dependent upon binding theory. He notes that, in Irish, resumptive pronouns are allowed in object position, but are not allowed in subject position. See also the discussion in section 5.7 below.

¹¹A brief comment about reflexives in Irish is in order here. Strangely, Irish seems to allow completely unbound instances of the reflexive particle in emphatic contexts:

Chonaic sé fein an réaltlong

cannot be bound¹² by an object (12b), but the reverse is grammatical (12a).

- 12) a) Chonaic Seán agus Máire lena chéile
Saw John and Mary with.their other
“John and Mary saw each other”
- b) *Chonaic lena chéile Seán agus Máire
Saw with their other John and Mary
“Each other saw John and Mary”

Similar effects are seen in Niuean, as discussed in Woolford (1991):

- 13) Fana n-e ia a ia ni neafi
shoot empf-erg he abs him refl yesterday
“He shot himself yesterday”
(Seiter 1980; 78)

If the object and the subject were sisters, as predicted by the flat structure in (11), then we would expect this to be a Principle B violation: the subject pronominal could be c-commanded and bound by the object. Since the sentence is grammatical, it follows that the subject pronoun is not c-commanded by the object, and by extension that the subject and the object are not both directly dominated by the same node. Choe (1987)¹³ discusses similar data in Berber:

- 14) a) *y-utu-tj wrba_j pro_j
3ms-hit-him_j boy-nom_j
“The boy_j hit him_j” (principle B)
- b) *y-utu ixfnns_j arba_j
3ms-hit himself_j boy_j
“himself_j hit the boy_j” (Principle A and C)
- c) *y-utu pro_i ibbas wrba_i
3ms-hit pro father boy
“he_i hit the boy_i’s father” (Principle C)

Saw he self the starship

“Himself saw the starship” (referring to a particular person in the discourse setting)

Because of this emphatic use of the reflexive morpheme, which in such contexts seems to have little or nothing to do with true anaphora, I avoid using reflexives as examples of anaphora in this dissertation and use reciprocals, which do not have this emphatic reading, instead. See Ó Baoill (1995) for discussion.

¹²Here, I am operating under the standard, but not incontrovertible, assumption of Reinhart (1981,1983) that binding theory makes reference to the relations of c-command, rather than simple linear precedence. For a discussion and different views of anaphora, see Hendrick (1990), Solan (1983), Higginbotham (1983), and Barss and Lasnik (1986).

¹³See also Fassi Fehri (1993) for a discussion of the equivalent evidence in Standard Arabic.

Sproat¹⁴ (1985) presents evidence from parasitic gaps in Welsh that shows the same type of effect: subjects and objects cannot be sisters in Welsh. Chung (1983) points out that in flat structure, in contrast to traditional [_S NP VP] structures, both the subject and the object are properly governed by the verb. Thus we do not expect any subject/object asymmetries¹⁵ with respect to processes and constraints which refer to proper government, such as the ECP. For example, subject extraction in Chamorro, unlike English, is allowed to violate the that-trace filter:

- 15) Manu na katta sinangani hao as Juan na ginin i chi'luña?
 which L letter INFO.Pass.tell you Obl Juan that from the sibling-agr
 “Which letter did Juan tell you that was from his sister”

Simplifying somewhat, Kayne (1983) argues that the contrast between parasitic gaps in subjects and those in objects seen in (16) follows from the proper government restriction on the ECP, which licenses such gaps:

- 16) a) *Here are the books [which_i [they bought e_i [without knowing whether
 [reading e_i] would be a good idea.]]]
 b) ?Here are the books [which_i [they bought e_i [without knowing whether it
 would be necessary for them [to read e_i]]]]

The ungrammaticality of sentence (16a) follows from the fact that the gap within the subject NP of the most embedded clause is not properly governed. In contrast, the parasitic gap in sentence (16b) is in a governed object position, accounting for its improved acceptability. In a flat structure VSO language¹⁶, if both the subject and the object are governed by the verb, we expect no such contrast. Sproat shows that this is false; Welsh does show contrasts in its licensing of parasitic gaps parallel to those in (16) above.

¹⁴See, however, Woolford (1991) for a discussion of Sproat's arguments.

¹⁵In particular, Chung was thinking of the lack of that-trace effects and Sentential Subject Condition violations in VSO languages. She later develops an alternate theory of the lack of these effects not based on government of the subject position by the verb (Chung 1990).

¹⁶See Massam (1994), however, for the speculation that such predictions could also be made in non-flat structure VSO languages, provided the subject is VP internal and is thus properly governed by lexical m-command from the trace of the verb.

- 17) a) *Dyma'r llyfrau_i [a brynasant hwy [e_i] [heb wybod os
 here-the books wh bought they without knowing whether
 byddai [darllen [e_i]] yn syniad da]]
 would-be read prt idea good.
 "Here are the books which they bought without knowing whether reading
 would be a good idea"
- b) ?Dyma'r llyfrau_i [a brynasant hwy [e_i] [heb wybod os
 here-the books wh bought they without knowing whether
 byddai rhaid iddynt [darllen [e_i]]]
 would-be necessity to.3p read
 "Here are the books which they bought without knowing whether it would
 be necessary for them to read "

A gap embedded in an object in Welsh is noticeably better than one in a subject position. This kind of contrast is puzzling in a flat structure approach to VSO languages, if we assume that differences between subjects and objects are structurally defined, since both subject and object should be equally governed by the verb and its inflection.

Hendrick (1988, 1990) shows similar evidence from superiority effects in Welsh and Breton. Hendrick assumes that superiority effects like (18) follow from the ECP:

- 18) a) Who said what
 b) *What did who say (*What said who)

He assumes (see May (1985) and Pesetsky (1987) for a discussion of superiority effects) that in sentence (18b), the lower "who" argument adjoins to CP at LF to receive its interpretation. This is a violation of the ECP, however, since the trace of this movement is neither lexically nor antecedent governed.

- 19) [who_i [CP what_k (did) [IP t_i [VP say t_k]]]]

In (18a) by contrast, the object "what" argument, being lower than V, can adjoin to VP for its interpretation at LF, and both traces are properly governed:

- 20) [CP who_i [IP t_i [VP what_k [VP say t_k]]]]

The prediction that is made, for a flat structure, VSO language is that both types of wh-movement should be licit, since both argument positions are properly governed by the

verb. This is, unsurprisingly, a false prediction. Both Breton and Welsh show superiority effects, indicative of structural subject/object asymmetries:

- 21) Welsh:
a) Pwy a ddywedodd beth?
who wh-prt saw what
"Who saw what"
b) *Beth a ddywedodd pwy?
What wh-prt saw who
"What saw who" (Hendrick 1988)
- 22) Breton:
a) Piv a lavar Petra
who wh-prt say what
"Who said what"
b) *Petra a lavar piv
what wh-prt say what
"What said who" (Hendrick 1990)

Anderson (1984) presents evidence from Kwakwala (also known as Kwakiutl), a Wakashan VSO language that shows clear subject/object asymmetries. Kwakwala is famous for the fact that case markings and determiners do not cliticize to the word they mark, but to the preceding word; for this reason I have provided bracketings, which may appear in the middle of words, to show NP boundaries. Anderson notes that certain rules of Kwakwala morphology are sensitive to subject/object-hood. For example, the possessive marker, which is found both on simple NPs and on the subjects of nominalized embedded clauses, takes a different form when it is co-referential with the subject NP, than when it is co-referential with any other NP:

- 23) ?ax[-ida bæg^wanema][-χ-is yanema]
take-dem man -obj-poss game (hunted animals)
"The man_i took his_i game" (Anderson (1984)
- 24) ?ax[-ida bæg^wanema][-χ yanem-s]
take-dem man -obj-poss game-poss
"The man_i took his_j game" (Anderson 1984)

Only subjects can be relativized in Kwakwala (25). No other element is licit for relativization. In order to make an object oriented relative, the verb must be passivized, as

in (26):

- 25) yum[-uχ^wda bæg^wanəmi [CP yəlk^wəmas[-χ-a wats' i]]
 that-dem man cause.hurt -obj-the dog
 "That's the man who hurt the dog" (Anderson 1984)
- 26) yum[-uχ^wda wats' i [CP yəlk^wəmat-su?[-s-a bæg^wanəma][-s-a g^waχλ uχ^w]]
 that-dem dog cause.hurt-pass -inst-the man -inst-the stick
 "That's the dog which the man hurt with a stick" (Anderson 1984)

Finally, only subjects in embedded clauses can be controlled, not any other position.

Again, to control an object, the sentence must be passivized. This is seen in (27):

- 27) a) yum-ən hiʔq' al-əm hamχ[?]id-χ-a k' utəla
 that-my allow-pass eat -obj-the fish
 "That's who I let eat the fish" (e.g., the cat).
- b) yum-ən hiʔq' al-əm hamχ[?]id-su?-s-a bosu
 that-my allow-pass eat pass-inst-the cat
 "That's who I let the cat eat" (e.g., the fish).

There are thus strong subject/object asymmetries in this language arguing against a flat structure¹⁷ approach to VSO languages.

This evidence, combined with the binding and parasitic gap facts, the typological arguments of Emonds (1980), the VP clefting facts of Sproat (1985) and McCloskey, and the subject-object asymmetry facts of Anderson and Chung (1977), presents strong reasons to dismiss a flat structure approach to VSO languages like Irish, Breton, Welsh, Samoan, Tongan, and Chamorro, and perhaps to VSO languages in general. We can ask ourselves if there is any evidence for flat structure for any VSO languages. One possible candidate for a flat structure analysis might be Jacaltec, first discussed in Craig (1977) and later in

¹⁷It should be noted however, that Anderson does in fact adopt a flat structure analysis of Kwakwala. He claims that the subject/object asymmetries follow from differences in the selectional frames of the verbs in the language. He notes that subjects are always obligatory, but the presence of "VP internal" arguments is a feature of the lexical entry of the predicate involved. He claims that these lexical properties are transferred to the syntax in terms of the relation of Government. He defines government in terms of lexical selection, rather than in terms of structural properties like c-command or precedence. He thus claims that the difference between subjects and objects lies in the fact that objects are lexically governed (selected for by a lexical category like V), whereas subjects are not. Although this accounts for the subject/object asymmetries of Kwakwala, it cannot be extended to the constituency facts of the Celtic languages above. It also has the problem that it takes a relatively well motivated syntactic and structural relation and moves it to the lexical semantic domain. I, for reasons of space, will not discuss this further here.

Woolford (1991).

Jacaltec's binding facts seem to indicate that the object does mutually c-command the subject, as would be predicted in a flat structure analysis. As noted in Woolford (1991), an R-expression embedded in the subject NP cannot be co-referent with an object pronoun¹⁸:

- 28) a) Xil [smam_i naj pel] Ø_i
 Saw poss-father cl Peter him
 "Peter_i's father saw him_j"
 "*Peter_i's father saw him_i"

This data could be analyzed as a condition C effect (Chomsky 1991) where the object c-commands the R-expression in the subject NP:

29)

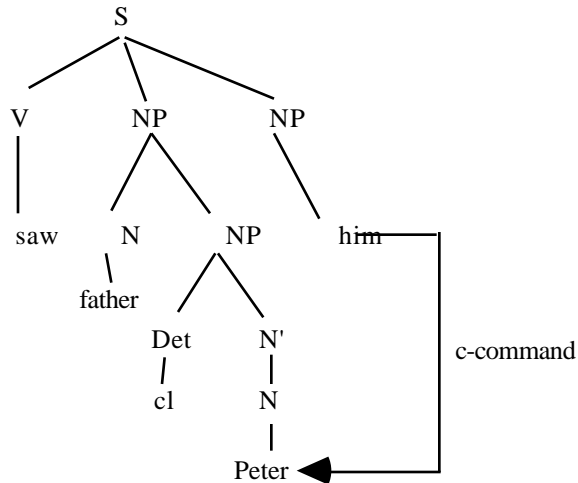

Thus, Jacaltec might well be a candidate for a flat structure VSO language, as Woolford claims. The problem with such an analysis, however, is that Jacaltec does show standard subject-object asymmetries. For example, just as in English, reflexives are not permitted in subject position (Craig 1977). Similarly, only subjects are available for the rule of "Promotion" discussed by Craig. This phenomenon, similar to subject to subject raising, is seen in the following example:

¹⁸Due to constraints on disjoint reference, the object pronoun must surface as null in this construction, see Craig (1977: 158).

- 30) x'iche smunla naj
 asp.abs.3.began erg.3.work cl
 "He began to work"

This evidence suggests that Jacaltec really does show subject/object asymmetries, and that the government of the R-expression in the subject NP, and resultant condition-C effect in (28) might be due to something other than condition C. Heidi Harley (p.c.) has suggested to me that perhaps the ungrammaticality of (28) with the coreferent reading is due to a condition B violation on the object pronoun. She proposes that the R-expression possessor of the subject NP is functioning like the head of that NP¹⁹, thus its features percolate to the NP node and trigger a condition B violation. The subject NP c-commanding the object.

31)

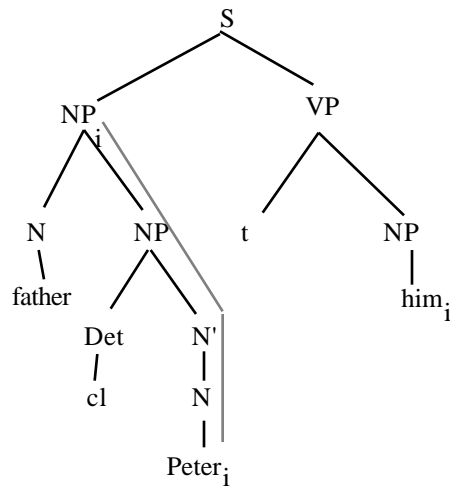

Harley (pc) has pointed out to me that this kind of head-like behaviour of possessors is found in many languages. For example, Japanese allows passivization of possessor NP (Terada 1991). This kind of analysis is too complex to work out here, but it is more consistent with the other evidence from Jacaltec which suggests that subject/object asymmetries do occur in the language.

¹⁹See Napoli (1989) for a related discussion of how the embedded PP in NPs like "that flower **of a girl**" is the semantic head of the NP. This is shown by the fact that verbs selecting [+human] complements can select for such NPs, despite the fact that the syntactic head of the NP is [-human]. For example, the verb "marry" can only take [+human] complements, yet the sentence "I want to marry that flower of a girl" is (sexism aside) grammatical.

2.2 Subject Lowering

Let us now turn to another early proposal for deriving VSO order, that of subject lowering proposed in Choe (1987) for Berber and Chung (1990) for Chamorro. Choe (1987) argues that a language like Berber derives VSO when the subject NP lowers for case reasons from its base position in the specifier of IP to a position adjoined to the verb²⁰:

32)

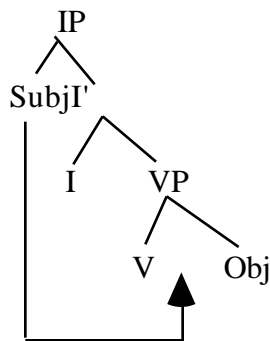

She claims, following Sproat (1985), that VSO languages are distinguished from SVO languages in terms of a parameter for their case assignment direction. She claims that all VSO languages follow the following principle:

33) *The Strict Rightward Case Assignment Principle*
Case is assigned strictly rightwards (Choe 1987: 127)

In sentence (34) below, we see two crucial pieces of evidence for her approach. First, there is an inflectional element, separate from the verb, which appears before both the verb and the subject. This kind of preverbal inflectional element is found in almost all VSO languages²¹. Second, Berber shows its agreement directly on the verb rather than on the

²⁰An interesting variation on this analysis is found in Shlonsky (1987). He argues there that in VSO languages, the subject lowers to adjoin to VP (not V) and the verb raises to INFL. His analysis is in principle different from the ones discussed in this section and more closely resembles ones using verb raising, and the VP internal subject hypothesis. One might even claim that his analysis is an early notational variant of that analysis. Verb raising and VP internal subjects are discussed in more detail in chapter 3 of this thesis.

²¹Choe claims that this is not true for languages like Irish and Welsh. She claims that these languages do not allow an IVSO order and use an ISVO order. In fact, this is based on a misunderstanding of the Irish data. She seems to have mixed Celtic auxiliaries up with inflectional particles. While it is true that Celtic languages, show Aux S V[-tns] Obj Order, it is false to claim that Inflectional particles appear before the

inflectional particle:

- 34) Ulli t-ttett Tifa iselman
 Neg.Imp 3fs-eat Tifa fish
 “Tifa is not eating fish”

She claims that since the verb is to the right of the inflectional particle, and that this inflectional particle is independent from the verb, that no raising has applied and that the verb and INFL are in their base positions. She assumes that Agr is the element that assigns nominative case, and since Agr is shown on the verb and not the inflectional particle, it is the V+Agr that assigns nominative case rightwardly to the subject. The only way for the subject to receive nominative case, then, is to lower and adjoin to the V+Agr head.

Choe presents two independent pieces of evidence in favor of this type of approach. First, she notes that unlike most languages, Berber shows verb-subject²² idioms, and verb-object idioms are very rare:

- 35) a) T-utu tfaccit arba
 3fs-hit toe-stub the boy
 “The boy stubbed his toe” (lit. “the toe-stubbed hit the boy”)
- b) T-utu tenzi mucc
 3fs-hit sneeze cat
 “The cat sneezed” (lit “the sneeze hit the cat”)
- c) y-fergh wadu i wajjarinw
 3ms-crooked wind to my neighbor
 “My neighbor is miserable” (lit “the wind crooked to my neighbor”)
 (Choe 1987: 134)

Second, she points out that all subjects in Berber are in the construct state (see Guerssel (1987) for more discussion of this construction); a form found usually only in nominal or prepositional complements in other languages (such as Hebrew and Irish). Examples of the

subject and not the verb. Both Irish and Welsh show IVSO orders without auxiliaries, and IAux SVO orders in ones with them, the generalization being that Celtic languages do show the almost universal inflection - tensed verb - subject ordering.

²²Why these are predicted to be good follows from Choe’s account of the trace of the subject NP, which c-commands its antecedent. This will be discussed in more detail below. Briefly, however, it follows from the fact that she assumes the verb and its subject are inserted “pre-adjoined” into the syntax, thus accounting for their status as idioms. I am unable to see how this really accounts for these facts. In any case, it is entirely possible, as has been pointed out to me by both David Pesetsky and Ken Hale, that these are unaccusative predicates, and the subject in these is a derived one rather than an underlying one.

construct and free state forms of some nouns in Berber are seen in (36):

- 36) a)
- | Free state | Construct State | |
|-------------|-----------------|----------|
| t-a-mttut-t | t-emttut-t | 'woman' |
| a-ryaz | w-ryaz | 'man' |
| t-a-brat-t | t-brat-t | 'letter' |
- b) y-uzn wryaz tabratt i temttutt
 3ms sent man.cs letter.fs to woman.cs
 "The man sent the letter to the woman"
- c) ajdid wryaz
 bird man.cs
 "The man's bird"

She claims that the construct state²³ only appears when the N is the sister of a [-V] element. Given that Agr is [+N,-V], the construct state is expected in a configuration where the subject NP is the sister to the Verb+Agr.

Before turning to evidence against this approach, I would like to discuss the other paper that has suggested a subject lowering approach to VSO order: Chung (1990). Like Choe, Chung assumes an IP generated subject; she assumes, however, that parallel to many other Austronesian languages, the underlying order of Chamorro is IVOS and the subject lowers leftwardly to the V, as seen in (37):

37)

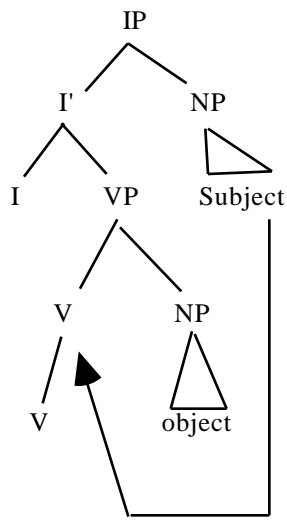

²³For a more thorough discussion of construct state nominals see section 6.6 below

Evidence for the underlying order of Chamorro, she claims, comes from the word order of sentences with non-verbal predicates. In these sentences, which lack a verbal copula, the non-verbal predicate and its complement are not separated from one another by the subject:

- 38) a) Ma'estrokku si jose
 teacher.1s Jose
 "Jose was my teacher"
- b) Esta un mes i ga'lagu
 already one month the dog
 "The dog is already one month (pregnant)"
- c) I rigalu ginin as nana-hu esti na aniyu
 the present from obl mother.1s this L ring
 "This ring is a present from my mother"

Given that subjects follow complements to non-verbal predicates, she extends the analysis to verbal predicates. Foreshadowing work that will appear in later chapters of this thesis, it should be noted that the assumption that the order Predicate - Complement - Subject appears with non-verbal predicates does not necessarily imply a VOS underlying order. For example, the main focus of this thesis will be on sentences like (39) below in Irish, where a non-verbal predicate and its complements and modifiers all precede the subject. However, as will be discussed below there is overwhelming evidence that Irish is SVO underlyingly :

- 39) Is [NP amhrán [cpa^L bhuaifidh an píobaire]](é) "Yellow Sub"
 C song COMP play.fut. the piper (agr)
 "'Yellow Submarine' is a song which the piper is going to play"

Non-verbal predicate - complement - subject order, as will be seen below, need not be taken to be evidence for VOS order.

Chung claims that evidence for the subject lowering approach to VSO comes from the fact that the subject can appear after any projection of V — a fact which only follows from a subject adjunction story, not from one that involves verb raising:

- 40) a) Ma-fa'tinas i statue nu siha **i famalao'an** ni kle
Infl-make the statue obl them the women obl clay
"The women made the statues of themselves with clay"
- b) Ma-faisin tä'lu otru na kuestión si **Francisco** ni ma'estru
Infl-pass.ask again other L question Francisco obl teacher
"Francisco was asked another question by the teacher"
- c) Ha-apápasi i lalahi si **Carmen** sinku pesos
Infl-pay.prog the men Carmen five dollars
"Carmen is paying the men five dollars"

Additional evidence for a subject lowering approach to VSO comes from coordination. Chung notes that Chamorro requires that co-ordinated elements be identical constituents. Interestingly, it appears that you can have the subject of two coordinated VPs appear between the verb and the object of the second one:

- 41) [Tumohgi] ya [ni-rekuknisa si **Maria** ni gubietnu]
Infl.stand and.then Infl.pass.recognize Maria obl Governor
"Maria stood and was recognized by the governor"

She claims that such sentences, can only follow from analysis where the subject starts in the specifier of IP, where it discharges its function as "subject" of both of the conjoined VPs, then lowers and adjoins to the VP.

There is some empirical evidence in Chamorro against such an approach. As noted by Woolford (1991), the position of VP adverbs in Chamorro reported by Chung (1983), is inconsistent with a subject lowering approach. Consider the sentence in (42):

- 42) Ma'pus esta si Juan pära i tenda
Infl-gone already unnm Juan to the store
"Juan has already gone to the store"

The VP adverb is between the subject and the verb: the regular position of such adverbs in Chamorro. Given that adverbs usually adjoin to maximal categories, the positioning of this adverb between two heads that are supposed to be head-adjoined to one another is, to be blunt, unlikely:

- 43) [_v [_v [_v ma'pus] esta] si Juan]

It is much more likely that the adverb is in fact VP adjoined, the subject is VP internal and

that the verb has somehow raised outside of the VP (we will consider this line of thought again in later sections). Given that VP adjoined adverbs appear medially in supposed verb-subject adjoined structure, I think there is fairly strong evidence against such an approach. The same sort of facts are true of Modern Irish; appositive adverbs²⁴ in Irish can appear between a verb and a full NP subject:

- 44) Chonaic, cinnte, an fear an réaltlong
 Saw, certainly, the man the starship
 "The man certainly saw a starship"

This suggests that a subject lowering approach is certainly untenable for Modern Irish.

Fassi-Fehri (1993) provides evidence from object enclisis in Standard Arabic, a VS order language, which also argues against a subject lowering account. In Arabic, object clitics appear attached to the verb:

- 45) ḍaraba-hu r-rajul-u
 beat-him the-man-nom
 "The man beat him"

Under a subject lowering approach we might predict that object enclitics could adjoin to the complex V formed by subject lowering:

- 46)

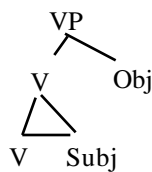

This would result in an ungrammatical order for enclitics:

- 47) *ḍaraba r-rajul-u-hu
 beat the-man-nom-him
 "The man beat him"

²⁴It should be noted, however, that Irish does not allow any other type of adverb in this position. For example, McCloskey (1983b) notes that the following are strongly ungrammatical:

i) *Chonaic **inné** na gasraí capall mór bán ansin
 Saw yesterday the boys horse big white there
 "The boys saw a big white horse there yesterday"

Only appositives are allowed in this position, and even they are not allowed when the subject is a clitic pronoun.

This then also provides evidence against subject lowering cross-linguistically.

All aesthetic objections to lowering aside (e.g. Chomsky 1992, Kayne 1994), there is also a strong theoretical problem with such approaches. As noted by Fassi Fehri (1993), this has to do with the status of the trace left behind by the subject lowering. In both Chung and Choe's story, this trace lacks a governing antecedent; it is higher in the tree than the element it is a trace of. Both Chung and Choe have answers to the problem, but they both appear to me to be somewhat *ad hoc*. Choe claims that the chain formed by the lowered subject and the trace comes into the syntax pre-formed before D-structure, thus is not subject to D-structure binding conditions. This kind of approach is clearly untenable in a system like Chomsky (1992, 1993) where all such constraints need be phrased as output conditions. Independent of this, however, the coherence of a notion like "do the movement before you get into the syntax" seems dubious to me. It is logically a contradiction; one is expected to do the syntax for syntactic reasons, before you enter the syntax, so that you can escape a constraint on the syntax. Chung (1990) seems to have a more coherent account. She claims that the trace of the movement is not a true trace, but a null expletive, which forms an expletive-subject chain. Again this seems designed simply to allow an analysis inconsistent with otherwise well-motivated constraints to escape these same constraints.

These theoretical objections aside, however, it is at least plausible that some languages, like Chamorro and Berber, make use of a subject lowering mechanism. Such an approach, unfortunately, is not available for languages like Irish, however. Elizabeth Pyatt has pointed out to me that given a verb plus adjoined subject constituent, we expect to be able to cleft VS sequences, (or at least VSO sequences). This is clearly false, as noted above, Irish never allows VS sequences to be clefted, but does allow VO ones to undergo such movement. This, combined with the fact that Irish allows certain inflectional elements to follow the verb (such as agreement morphology), and behaves as if it is a language with

object raising (see chapter 3 below) constitutes strong evidence against a subject lowering analysis of Irish.

2.3 Verb Raising Analyses: Part I.

In this section, we turn to analyses that claim VSO order is derived via the raising of the verb, or the raising of the verb and some of its arguments. Such approaches have been proposed in Emonds (1980), Sproat (1983, 1985), Sadler (1988), Mohammed (1988), Ouhalla (1994), Duffield (1991), Guilfoyle (1994), Noonan (1992), McCloskey (1991, 1992b, forthcoming), Chung and McCloskey (1987), Kaplan (1991), Fassi Fehri (1993) among many others. At issue is the question of where the verb raises to, and what, if any, NP movement occurs in conjunction with this movement. Various proposals have been put forward, including a V2-like movement of the verb to the complementizer head, and raising to various INFL projections. Similarly, various proposals have suggested that the subject and object NPs are VP internal, or in the specifiers of the Inflectional heads. In this, the final section of this chapter, we will examine first the general evidence in favor of a verb-raising approach to VSO order, independent of the landing site. We will then look at the evidence for and against the raising to C analysis. We will leave discussion of the analysis of VSO as raising to one of the inflectional projections until chapter three.

2.3.1 *Irish Ellipsis as evidence for raising*²⁵.

McCloskey (1991), building on research by Chung and McCloskey (1987), provides strong evidence in favor of a verb-raising approach to VSO order for Modern Irish. He proposes the analysis schematized abstractly in (48). For the moment, we will abstract away from exactly what heads and specifiers the elements in the Irish sentence

²⁵Discussion of a different kind of evidence for raising coming from adverb placement in Standard Arabic can be found in Fassi Fehri (1993).

actually occupy²⁶, since McCloskey's arguments hold quite independently of what the actual locations of the verb and arguments are. We will return to exact location of these elements in later sections and chapter 3.

48)

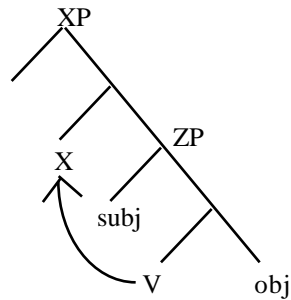

In (48) the verb has raised around the subject to a head higher than the surface position of the subject. This is the essence of the verb-raising approach to VSO order. What McCloskey noted is that in a structure like (48), once the verb has raised, there exists a constituent which consists of the subject, the trace of the verb, and the object (represented by ZP in (48)). Again, this is true independent of what the surface location of the verb and its arguments is, as long as the verb has raised around the subject. The claim here is that if such a grouping passes tests for constituency separate from the verb, then we have evidence for the verb raising analysis. In addition, if such a constituent exists, it also forms additional evidence against a flat structure approach to Irish syntax.

McCloskey's prediction is borne out. There is extensive evidence that the subject and object (and other VP internal material) do, in fact, form a constituent. Let us first consider the test of right node raising. The ZP constituent (the entire sentence minus the finite verb) appears rightmost in a Right Node Raising structure:

²⁶McCloskey (1991), who assumes the VP internal subject hypothesis after Fukui and Speas (1986), Kitagawa (1986), Koopman and Sportiche (1991) etc., claims that the verb is in INFL and the two arguments are *in situ*; the subject is in the spec of VP and the object is the complement of the verb. See chapter 3, below, for arguments against such an approach.

- 49) Níor thug, nó is beag má thug, [**an pobal aon aird ar an bhean bhocht**]
 neg gave, or C small if gave, the people any attention on the woman poor
 “The community paid no attention or almost no attention to the poor woman”
 (McCloskey (1991))

According to McCloskey, only constituents may participate in such structures. Therefore we may conclude that ZP is such a constituent.

The most convincing evidence for such a constituent, however, comes from ellipsis phenomena in Irish. Irish has a process of VP ellipsis which parallels English VP ellipsis in many ways. It applies under identity to a linguistic (i.e. non-pragmatically defined) antecedent. It is immune to island constraints. It may apply “backwards” (with the antecedent following the elided material). It tolerates antecedent contained deletion. Finally, it shows strict/sloppy pronominal interpretations. McCloskey thus claims that this phenomenon is the Irish equivalent of English VP ellipsis. It differs from English VP ellipsis, however, in what is deleted. In English, the subject obligatorily remains, but the verb and the object (and any other VP internal material) is elided and replaced with *did* (*too*). In Irish on the other hand, the verb is the one element which is not elided, rather, it is the ZP constituent which is elided:

- 50) English: S V O and S ~~V~~ O
 Irish V S O and V ~~S~~ O
- 51) Dúirt mé go gceannódh sí é agus cheannaigh ~~subj-object~~
 said I that would.buy she it and bought .
 I said that she would buy it and she did.

As McCloskey notes “...the almost unanimous view in the literature is that the elided material in VP ellipsis forms a syntactic constituent.” The raising analysis, with a ZP constituent, provides us with an elegant account of these facts. The verb has raised outside of the domain of the ellipsis process, whereas the subject and object remain within the ZP constituent, which is elided²⁷. The evidence from ellipsis is thus in favor of a verb raising approach to VSO order.

²⁷McCloskey (1991) claims that this constituent is the VP, accounting for the parallels to English VP ellipsis. We will return to this below.

A problem for McCloskey's story, however, lies in the fact that the ZP constituent fails several standard tests for constituency in Irish. For example, it cannot be the focus of an only phrase (52) and cannot be clefted (53):

- 52) *Ní chonaic ach [beirt an duine]
Neg saw but two-people the man
"only two people saw the man"
- 53) *[Seán teach i nDoire] a cheannaigh
John house in Derry C bought
"It was John a house in Derry that bought"

McCloskey claims however, that these violations should not be taken as evidence against the constituency of ZP. Instead, he shows that the ungrammaticality of sentences like that in (52) and (53) follows not from a lack of constituency, but rather from a violation of the ECP. Recall that the constituent ZP has the trace of the verb movement in it. If ZP is fronted to the beginning of a clause in a cleft (higher than the verb), or is right adjoined to the clause in an only-focus, then this trace is not antecedent governed by the verb, accounting for the ungrammaticality of the forms. This is seen in the bracketed diagram of a cleft in (54).

- 54) * $[_{CP}[_{ZP} \text{Subj } t_v \text{Obj}] C [_{IP} V [t_{zp}]]]$

not properly governed

These putative exceptions now accounted for, McCloskey's claim that the subject and VP material, less the finite verb, form a syntactic constituent is verified, lending strong support to a verb movement analysis of Irish VSO.

In the next section, and in chapter 3, we turn to the question of what the landing site of the verb is, and in chapter 3 we will explore where the arguments of the verb are to be found. In other words, we will be exploring the nature of the constituent we have thus far labeled ZP.

2.3.2 Raising to C

Perhaps the earliest raising analysis of VSO order involves the raising of the verb to the complementizer head in a manner familiar from V2 languages and from question formation in SVO languages like English. This approach to VSO order was first proposed by Emonds (1980) who suggested that all verb fronting was motivated by “attraction to the complementizer.” This approach was also popular in the early work in the Government and Binding framework (Stowell 1989, Déprez and Hale 1986, Hale 1989). More recently it has been proposed to account for the change from V2 in Middle Welsh to VSO in Modern Welsh by Clack (1994) and Sáinz (1994), for Pembrokeshire Welsh by Watanabe (1993) and for Old Irish VSO by Carnie, Pyatt, and Harley (1994).

German and Dutch stand as typical examples of V2 languages. In tensed clauses without an overt complementizer, the verb must appear in “second position.” The first position in the sentence is occupied by any constituent. In example (55) below (data from Haegeman 1991), the verb *kaufte* always appears in the second position, and any of the other elements (the subject *Karl*, the object *dieses Buch*, or the temporal adverb *gestern*) can appear in the first position. The remaining constituents follow the verb.

- 55) a) Karl kaufte gestern dieses Buch
 Karl bought yesterday this book
 ‘Karl bought this book yesterday’
- b) Dieses Buch kaufte Karl gestern
 ‘Karl bought this book yesterday’
- c) Gestern kaufte Karl dieses Buch
 ‘Karl bought this book yesterday’

In clauses with overt complementizers, by contrast, there is no V2 ordering. The verb appears in final position:

- 56) Ich dachte daß Karl gestern das Buch gekauft hat
 I thought that Karl yesterday the book bought has
 ‘I thought that Karl bought the book yesterday’

The standard analyses (see, e.g., McCloskey 1992a) of V2 hold that there is a requirement that the complementizer position be filled in tensed clauses. The verb raises to the empty complementizer position in matrix clauses. There is then an additional requirement that the specifier of a matrix complementizer be filled by some element giving the V2 order.

57)

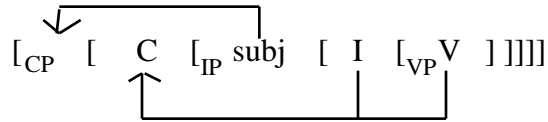

In embedded clauses, however, the complementizer position is filled, and the verb cannot raise to it. Thus V2 ordering is blocked.

An obvious extension of this approach is to posit a set of “V1” languages where the requirement on filling the specifier of CP is not imposed, resulting in a VSO ordering. In this analysis, a Modern Irish VSO sentence like (58a) would have a derivation as in (58b).

- 55) a) Leanann an t-ainmní an briathar i nGaeilge
 follow.PRES the subject the verb in Irish
 ‘The subject follows the verb in Irish’ (Modern Irish)

b)

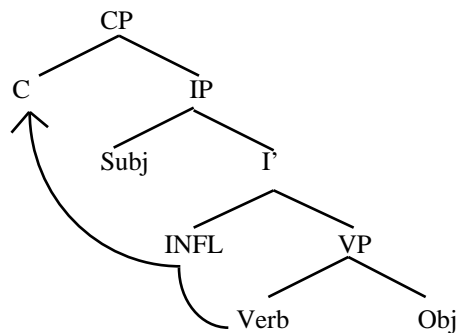

The verb raises through its inflectional complex to C° and all the other arguments stay in their canonical positions. VSO order, under this approach, is thus a ‘weak V2’

phenomenon:

- 59) *The Weak V2 Hypothesis* ($V \rightarrow C^\circ$)
 VSO order is derived via head movement of the verb to C° . There is a requirement that C° 's in VSO languages be filled, but the specifier of CP need not be filled

2.3.1.2 McCloskey (1992b): Evidence against raising to C° ²⁸

McCloskey (1992b) has argued that this approach is unavailable for deriving basic VSO order in Modern Irish. First off, as first noted in Koopman and Sportiche (1991) there is the question of word order in embedded clauses with complementizers. Recall that in German, when a clause is embedded, the complementizer position is filled, and V2 order does not arise. If Irish were to have a comparable analysis then we would expect the order C° -SOV or C° -SVO in embedded clauses. This prediction is immediately falsified by the facts of Irish. In fact we only get C° -VSO order. The verb still must raise:

- 60) Ceapaim [go bhfaca sé an madra]
 think.PRES.1s [that see.PST.DEP he.NOM the dog]
 COMP V Subj Obj
 'I think that he saw the dog.'

The motivation for this verb-first ordering cannot be an obligatorily filled C° requirement; since there is a filled complementizer, the verb should not have to raise²⁹.

McCloskey (1992b) presents a more complicated argument using the behavior of adverbs showing that the verb is no higher than the left edge of IP in Modern Irish. In English, there is a set of adverbs and adverbial clauses which appear to the right of complementizers but to the left of subjects (data from McCloskey 1992b):

- 61) a. That *in general* he understands what is going on seems fairly clear
 b. It's surprising that *most of the time* he understands what is going on.

²⁸See also Fassi Fehri (1993), chapter 2, for arguments from particles in Arabic on this issue.

²⁹A recursive CP structure like that posited for many "embedded V2 languages" like Yiddish (see Iatridou and Kroch (1992) among many others) could also account for this order. I will not discuss this option here because of the convincing nature of McCloskey's (1992b) arguments (discussed below) against a raising to C° approach for Modern Irish VSO order.

These adverbial elements can never appear to the left of the complementizer in English (the following sentence is to be read with the adverb having scope only over the embedded clause, as in the sentence in (62)):

62) *It's surprising *in general* that he understands what is going on.

McCloskey (1992a) argues that the pattern seen above follows from the Adjunction Prohibition of Chomsky (1986):

63) *Adjunction Prohibition* (after McCloskey 1992b)
Adjunction to a phrase selected by a lexical head is ungrammatical.

Under this principle, adverbials are allowed to adjoin to IPs that are complements to C°, a functional head. However, they are forbidden to adjoin to CPs that are selected by a verbal head, a lexical category. In this sense, then, the adverbials shown above in (61) and (62) can be called IP adjoined adverbs. In contrast, in matrix clauses, where there is no lexical selection of CPs, these same adverbials can appear to the left of a wh-complementizer:

64) a) *When you get home*, what do you want to do?
b) *Next Christmas*, whose parents should we go see?

In Irish, surprisingly, the order of adverbials and complementizers is different. Adverbials appear to the left of both complementizers and subjects in both matrix and embedded CPs (data again from McCloskey 1992b):

65) Adverb C V S
Líonaim d'eagla *dá dtógfainn mo radharc dóibh* go dtitfinn
Fill.1s of fear if lift-1s.cond my sight from.3.s that fall.1.s
"I fill up with fear that, were I to take my eyes off, then I would fall"

Thus Irish shows the converse pattern to English as is schematized in (66):

66)

	English	Irish
...Adv that [IP ...	* (embedded)	ok
...that Adv [IP ...	ok	* (always)

At first glance, it might appear that Irish lacks the Adjunction Prohibition. However, under closer examination it becomes apparent that this is not the case. Irish does have restriction

on adjunction to embedded CPs. Consider the following example (data from McCloskey):

- 67) *Ni bhfuair siad amach ariamh *an bhliain sin* cé a bhí ag goid a gcuid móna
 Neg found they out ever that year who C° was prog steal their turf
 “They never found out who was stealing their turf that year”

In this case—a selected wh-interrogative CP, where you have both a C° and a wh-head marking the left edge of CP—the adverb is illicit to the left of the wh-word. For this case, then, the Adjunction Prohibition holds. This must be accounted for.

McCloskey suggests that the solution to this paradox is that the adverbs in (65) are IP adjoined, despite the fact they appear to the left of the complementizer. He claims that the C° in Modern Irish lowers³⁰ to attach to the verb³¹ because it requires support as a clitic, as illustrated in (68).

68)

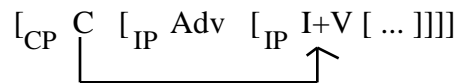

This kind of analysis is supported by two kinds of evidence. First, the lowering analysis of complementizer clitics in Irish predicts that the adverb will appear between the complementizer and any element in the specifier of CP. This is true, as is shown in (69):

- 69) a) Cé **riamh** a chuala í
 who ever C heard her
 “Who ever heard her”
 b) Cé_i t_C [_{IP} riamh [_{IP} C_C + Chuala t_i í]

This appearance of an adverb between a specifier and a head is a clearly an anomaly, and this data lends itself nicely to the idea that the complementizer has lowered itself around the adverb to the verb. The second kind of evidence comes from the phenomena of Narrative Fronting. Irish in formal narrative style allows an inversion of certain indefinite NPs in

³⁰A lowering analysis of Irish complementizers is subject to the same problems found with Chung (1990) and Choe’s (1987) account of subject positions, in that the trace of the movement is ungoverned. This might be dealt with by claiming that this clitic-lowering only occurs in the phonology, thus need not meet a syntactic requirement like the ECP.

³¹See Bobaljik (1993) for an alternative analyses of these facts.

negative contexts. An example of this is seen in (70):

- 70) *Braon eile; ní* bhfaighir t_i
drop other neg+C get-2
"Another drop you will not get!"

These fronted NPs, like IP adverbs, appear to the left of complementizers, but more interestingly, they appear to the right of (and thus lower than) IP adjoined adverbs (71). McCloskey then claims that these fronted elements are also IP adjoined. In the following sentence, we have two IP adjoined adverbs indicated in bold, and a narrative-fronted NP indicated in italics. Both of these precede the underlined determiner.

- 71) Tá sé ráite [*ariamh*] [***má chaineann tú sagart***] *maithiúna*s; nach bhfaighidh tú t_i
is it said ever if criticize you priest forgiveness negC get.fut you
It is said that if you criticize a priest you will not ever be forgiven.
(or It is always said that if you criticize a priest you will not be forgiven)

McCloskey argues that if the complementizer is lowering for phonological reasons (at PF), to adjoin to the verb, then its LF position should license negative polarity items which have IP adjoined via narrative fronting. This prediction is borne out:

- 72) [*Pingin rua*] char caith mé ar an bhád
Penny red negC spend I on the boat
"Not a red cent did I spend on the boat"
(lit "Red Cent, did I not spend on the boat.")

In this sentence, the negative polarity item *pingin rua* 'red cent' is licensed by the negative complementizer *char*, which follows it. The fact that the lowering is a PF phenomenon, accounts for why the polarity item is licensed. The LF position of the negative complementizer c-commands the IP adjoined position of the negative polarity item

Given these assumptions about complementizer lowering, where does this leave us with VSO? Since the verb is to the right of the adverbs, and these adverbs mark the left edge of IP, then it follows that the verb must be no higher than the left edge of IP, and is not in C, and Modern Irish is not a weak V2 language.

We can now ask if there is any language which uses a weak V2 strategy for VSO. Carnie, Pyatt, and Harley (1994) suggest that the form of Irish spoken in the fourth to the twelfth century, Old Irish, has weak V2 in certain contexts. We turn to these arguments in the next subsection.

2.2.2.1 *Old Irish, a language with raising to C*³².

Carnie, Pyatt and Harley (1994) (henceforth CPH) argue that Old Irish has *both* raising to the left edge of IP, like Modern Irish, and also a filled C requirement³³. Although the complex arguments from adverbial interpretation are not available for Old Irish, there is some evidence that in most cases Old Irish only moves its verb to the left edge of IP, just like Modern Irish. This evidence comes from the complementizer system. Old Irish has VSO word order in declarative sentences (73)³⁴:

- 73) Beogidir in spirut in corp
 vivifies-3s the spirit the body
 ‘The spirit vivifies the body’

As in Modern Irish, when the complementizer is filled with a particle, the verb is still otherwise clause initial:

- 74) Ní beir in fer in claideb
 Neg.C°carries-3s-conjthe man the sword
 ‘The man does not carry the sword.’

This being the case, Old Irish must be a language with raising to the left edge of IP in its derivation of VSO order.

³²This section owes a great deal to my co-authors Heidi Harley and Elizabeth Pyatt; many thanks to them both.

³³Breton, another Celtic language, seems to be both VSO and V2 (VSO in embedded clauses and V2 in matrix ones). It would then be a language that has both a left edge INFL strategy and has a full (not weak) V2 requirement. For more discussion see Schafer (1995).

³⁴Throughout, I will use the traditional spelling system of Old Irish. I refer the reader to Thurneysen (1980) for the complete details of how Old Irish is pronounced. The Old Irish examples have been taken from Strachan (1984), Strachan (1944), McCone (1987) and Thurneysen (1980) who take them from various primary sources.

CPH claim, however, using evidence from the placement of enclitic pronouns and phonological behavior of certain verbal elements, that Old Irish also has a filled C° requirement. This requirement can be met by complementizers, by verbs, or by subparts of morphologically complex verbs. Thus Old Irish is a language that has both raising to C° and raising to the left edge of IP.

A major difference between Old Irish and Modern Irish lies in the complexity of the verbal system (for discussion see McCloskey 1978 and McCone 1987). The morphology of the Old Irish verb includes verbal roots, inflectional endings and a series of preverbal particles. The preverbal particles are of three types: conjunct particles (C), preverbs (P) and object enclitics (E). These particles, the verb, and person/number endings form what is called the “verbal complex”. Excluding the enclitics for the moment, there is a strict ordering to these forms (75b). An example of a maximal verbal complex is given in (76).

- 75) Old Irish Verbal Complex
- a. *Conjunct Particles (C)* - negation, question marker, C°s
Preverbs (P) - Alters verb meaning, adds perfective aspect
Verb (V)+Subject inflection (S) - The verb root itself and person agreement.
Enclitics (E) - Object clitics and relative markers
 - b. C > P > V-S
- 76) Ní-m• accai (Ní+ m+ ad+ ci+3sng)
 Neg-me•see-3s C (E) P V-S
 ‘he does not see me’

Following Duffield (1991), CPH assume the conjunct particle position (C) corresponds to the C° position. This might explain why it must be ordered before the other preverbal particles. In Modern Irish, the conjunct particles form phonological units with overt complementizers (see Duffield 1991 for discussion):

- 77) go 'that' + ní 'neg' nach 'neg.comp'
 go 'that' + níor 'neg-past' nár 'neg.past.comp'

Similar facts are found in Old Irish, thus CPH assume that the conjunct particles correspond to C° in the older form of the language as well.

Given this cast of characters, CPH show how certain morphological, phonological and syntactic processes argue for Old Irish having both raising of the verb to the left edge of IP and for the raising of the verb to C°. In Old Irish, the verb and its inflection take two different forms depending upon whether or not these are in absolute initial position. These two forms are called absolute and conjunct (78) (examples taken from Strachan 1984):

78)	<u>Absolute</u>	<u>Conjunct</u>	
	berid	-beir	‘he carries’
	berait	-berat	‘they carry’
	marbfa -marbub		‘I will kill’
	midimmir	-midemmar	‘we judge’

The absolute form is used when the verbal root is in absolute first position in the sentence, that is when the inflected verb is not preceded by any conjunct particles, preverbs or pronouns (79). The conjunct form is used when the verb is preceded by a conjunct particle or a preverb (80).

79)	Beirid	in fer	in claideb	(Absolute)	
	Carries-3s-abs	the man	the sword		
	‘The man carries the sword.’				
80)	Ní	beir/*beirid	in fer	in claideb	(Conjunct)
	Neg	carries-3s-conj/*abs	the man	the sword	
	‘The man does not carry the sword’.				

Interestingly, the appearance of a verb in its conjunct form is not necessarily a function of the presence of the preverbs or conjunct particles. Rather, the conjunct form is found anywhere that the verb is not in absolute first position. This is called "Bergin's law"³⁵ (Bergin 1938). This is especially true in some poetic forms where strict VSO order is not obligatory. Take for example the following lines from the *Énna Labraid Luad Cáich* as cited in Carney (1978):

³⁵Bergin's law is usually not phrased exactly this way. In Thurneysen (1980:§513) for example it is articulated as "simple and compound verbs may be placed at the end of the clause; the form they have conjunct flexion...". However, Carney (1978) argues that the formulation adopted in the text above is more accurate since verbs can appear medially in some poetic registers.

- 81)... srethaib sluag **soí** Crimthan Coscrach cing céth catha, ...
 ... with lines of hosts won Crimthan victorious hero hundred battles
 ‘With lines of hosts, Crimthan the victorious hero, won a hundred battles’
 (absolute: ***soid**)

Conjunct verbal inflection, then, is a feature of non-initial position. CPH claim that this distribution is definable in a systematic way: when the verb has raised to C° it takes the absolute morphology. When the verb is in any other position (either at the left edge of IP or in verb medial order as in the poem fragment above), it takes the more basic conjunct form. In (80) above, the C° has been filled with the conjunct particle *ní* 'neg' thus blocking the raising of *beir* "carries-3s-conj" to C°. The verb raises to the left edge of INFL just like it would in Modern Irish (McCloskey 1992b); the inflected verb is thus realized as *beir*. The resultant S-structure is seen in (82).

- 82) [CP *Ní*[IP *beir*_i+INFL [IP *in fer* [VP *t_i in claideb*]]]]

In (79), by contrast, there is no overt complementizer or any other type of preverbal particle. Thus the filled C° requirement forces the verb to raise from INFL to C° (83).

- 83) [CP *Berid*_i+C°[IP *t_i* [VP *in fer* [V' *t_i in claideb*]]]

When the inflected verb *beir* "carries" raises to C°, it actually is incorporating into a null C°. This C-INFL-V complex is then realized as absolute *berid* instead of conjunct *beir*. An interesting variation to this pattern occurs in relative clauses. If the null C° is [+wh], then a third form of the verb is used in lieu of the absolute form (84). For example, in the sentence below, the inflected verb of the relative clause *gaibid* "grabs" surfaces as *gaibes*, the relative form of the verb.

- 84) *Is oinfe*_i [CP \emptyset _i *gaibes*_i [IP *t_i* *búaid*]]
 cop one-man Op. grabs-3s-rel victory
 ‘It is one man who grabs victory.’

The differences between the relative form and the absolute form show that the morphology of the absolute is used to signal which null C° ([±wh]) is present in the complementizer position. Since the verb forms in absolute initial position vary depending upon what type of complementizer is present in the clause, it lends support to the theory that these verbs are in

fact in C°.

CPH also use alternations in the status of preverbs to support their conclusion. The preverbs are the prepositional components of Old Irish compound verbs. For example, given the basic verb *berid* ‘carries’, the addition of a preverbal particle shifts the meaning in unpredictable ways: *as•berid* means “says” (literally “out-carry”). Similar forms, such as *shine/outshine* and *blow/blow up*, are occasionally found in English. In Old Irish, however, the use of these particles is quite common, and help to form a large class of Old Irish verbal morphology. CPH claim that depending upon what other elements appear in the complex, these preverbal particles can behave as if they were either in C° or as if they were combined with the verb in INFL. In particular, it seems that given a compound verb with no conjunct particle, a preverbal particle satisfies the filled C° requirement.

Consider the following compound verb: *as•beir* “says-3s”. This is composed of the preverbal particle *as-* and *beir* “carries”. However, when this verb comes after a conjunct complementizer particle *ní* “neg”, the form of the verb is radically changed. In the example below, the form for “say-1s” is *as•biur* when there is no conjunct particle (85), but *epur* when it follows a conjunct particle like *ní* (86).

- 85) *as•biur* in so
 say-1s this
 ‘I say this.’
- 86) *Ní epur/*as•biur* a n-anman sund
 Neg say-1s their names here
 ‘I do not say their names here.’

Despite the obvious differences between these forms, there is no suppletion here. Instead, rules of stress shift, syncope, provection, reduplication and lenition all interact to muddy the forms (see McCloskey 1978 for more detailed discussion). The domain of application of these phonological rules provides evidence for CPH’s analysis. The entire verbal complex forms a single phonological unit that cannot be broken apart by adverbs and other

intrusive material. This grouping, CPH call the “clitic group” - (). However, there is a smaller phonological unit, the word () which is the domain of stress and syncope. Consistently, conjunct particles (C) and enclitic pronouns stand outside the phonological word (87a). Preverbal particles (P) on the other hand vary in their position, depending upon what other material is in the clitic group (87b).

- 87)a) [C [P (P) (P) (P) V]]
 b) [P [P (P) (P) V]]

For concreteness let us consider the example of stress. Stress in Old Irish is always on the leftmost syllable in the word. This is true of absolute verbs, nouns, and adjectives. When the verb is complex however, either with a conjunct particle or with a preverb, the stress falls on the second non-enclitic morphological unit:

- 88) a) C •P (P) (P) (P) V
 b) C •V
 c) P •P (P) (P) V
 d) P •V

There thus appears to be a special “pre-tonic” slot in initial position for a preverb or conjunct particle, which does not participate in the metrical structure of the rest of the verbal complex. CPH indicate the division between the pre-tonic position and the rest of the complex with the use of the symbol <•> (following Thurneysen 1946). Usually, the enclitic and any syllabic material it brings with it will be part of the pre-tonic. We can thus describe the distribution of the elements as follows:

- 89) i. Conjunct particles are always pretonic
 ii. If there is no conjunct particle, then the first preverb is pretonic

If we add a conjunct particle to a verb with preverbs, then the previously pretonic preverb joins the rest of the verbal complex and participates in its metrical structure, causing stress pattern to change as seen in (90).

- 90) a. *as•biur* “say-1s” /as.bjur /
 b. •*epur* “say-1s” /e.bur/;

The underlined syllable is the one that receives the stress. In (90a) the preverb *as* appears

in pretonic position and does not participate in the metrical structure of the verb (stress falls on *biur*). When the conjunct particle is added (90b), the preverb behaves as if it is part of the second element in the complex, and takes main stress. The other phonological alternations (/a/~e/ and /sb/~p/) follow from this shift in metrical structure. See McCone (1987) for more details.

As the conjunct particles always fall in the pretonic position, CPH conclude that the pretonic position is associated with the complementizer head. Since one preverb is required to be pretonic when there is no conjunct complementizer, it follows that a preverb can satisfy the filled C° requirement. When there is no overt complementizer, only the preverb, not the entire inflected verb, raises to C° to satisfy the Filled- C° requirement.

Let us consider a derivation of this type. CPH assume that the preverbal particles are reflexes of a Hale & Keyser (1991) type complex VP, or of Pesetsky's (1995) stacked PP "cascade" structure. We will consider the sentence in (85) with the base form in (91)

91) $[_{CP} [\emptyset] [_{IP} [_{INFL}] [_{VP} \textit{pro} [_{V'} \textit{as} [_{V'} \textit{biur} [_{ADVP} \textit{in so}]]]]]]]$

The preverb *as* raises to C° to satisfy the filled C° requirement. The verbal root *biur* raises to I° , as in modern Irish, accounting for the difference in phonological domains. The two domains correspond to distinct heads: INFL and C° .

92) $[_{CP} [\textit{as}_i] [_{IP} [\textit{biur}_j] [_{VP} \textit{pro} [_{V'} \textit{t}_i] [_{V'} \textit{t}_j] [_{ADVP} \textit{in so}]]]]]$

When a conjunct particle complementizer like *ní* "neg" is present, however, the preverb remains at the left edge of IP with the rest of the verb, putting it into the same metrical unit with the root verb. (93)

93) $[_{CP} \textit{Ní} [_{IP} [I^\circ \textit{epur} (< \textit{as} + \textit{biur})] \quad \textit{a} \quad \textit{n-anman} \quad \textit{sund}]]$
 Neg say-1s their names here
 'I do not say their names'.

The reader may have noticed that in allowing the two verbal heads (the preverb and

the verbal root) to raise to separate functional categories, CPH may well have created a violation of the Head Movement Constraint (HMC) (Travis 1984). Consider (94), which is a diagram representing a strict interpretation of CPH's analysis:

94)

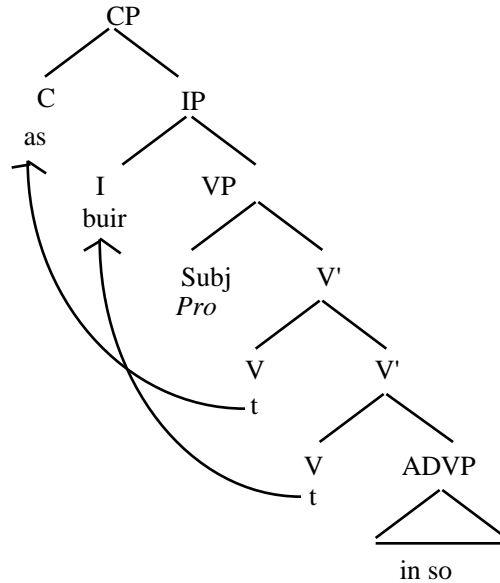

It appears as if the verbal root skips the intermediate preverb on its way to INFL. Similarly, the preverb seems to skip the intermediate inflectional heads on its way to C°.

This problem is especially acute in the cases where more than one preverb appears, as in (95). In *ad•cosnai* "strives after" (*ad-com-sní*), the first preverb moves to the C° head, but the other preverb is incorporated with the verbal root (*com + sní* → *•cosnai*). This type of example shows that there are cases where the verbal root *does* incorporate into a preverb.

95)

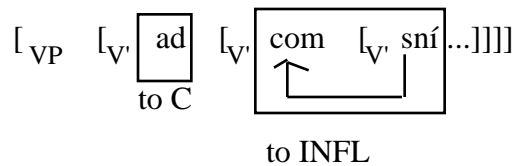

This incorporation suggests a solution to the HMC violation. The verb head-moves from

preverb to preverb, skipping none (in compliance with the HMC) and incorporating each preverb as it raises. After the verb has raised to the highest projection in the inflectional complex, the filled C° requirement is still not met. In order to satisfy this requirement, the first preverb in the string (the least embedded preverb) excorporates (see Watanabe (1993) for more discussion) and moves into C° . This is illustrated in (96).

96)

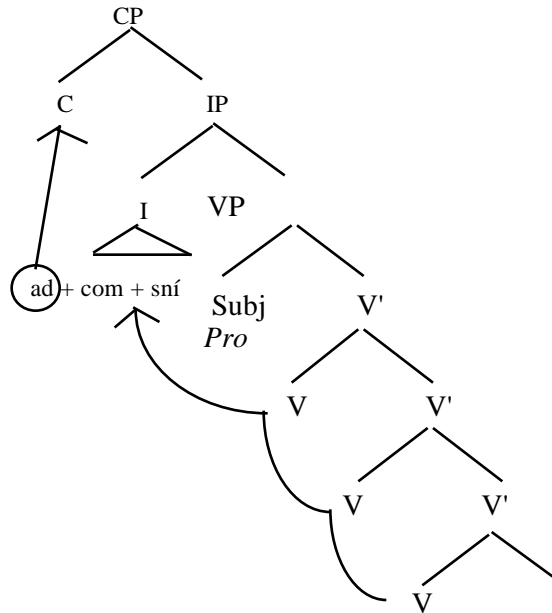

This excorporation account, satisfying the requirement on filled C° s, gives good empirical coverage of the phonological distribution of the preverbs. The HMC problem aside, the two different phonological domains formed by the complementizer head and the verbal head and the alternations in the shape of the preverbs strongly suggest that Old Irish had a weak V2 requirement.

The final piece of evidence which CPH present in favor of their approach comes from the position of object enclitics. Old Irish has Wackernaglian second position enclitics (E) which include object pronouns, relative pronouns, and conjunctions. The enclitic pronouns are always found after the first morphological element in the verbal complex (97). The following examples are taken from Strachan (1984):

- 97)a) Ní-m• accai (Ní + m + ad + cí-3sng)
Neg -me see-3s C E P V-S
 ‘she does not see me’
- b) aton•cí (ad + (do)n + cí -3sng)
P-us see -3s P E V-S
 ‘she sees us’
- c) bertaigh-i³⁶ (bertaig -th +i)
shake-3s.abs-him V- S E
 ‘he shakes him’

The distribution of enclitics is somewhat puzzling from a syntactic perspective; sometimes they precede the verb (when there is a preverb or conjunct particle); other times they follow the verb (when the verb is absolute). This distribution is transparent when we assume, following CPH, that Old Irish had a filled C° requirement. Once we make this claim, the distribution of enclitic pronouns is straightforward:

- (98) Enclitics (E) adjoin to C°. ^{37,38}

This is true whether the C is filled by a conjunct particle, a preverb or an absolute verb form.

Let us consider a few derivations. The underlying structure and verb raising to the left edge of IP of the sentence *bertaigh-i* ‘he shakes him’ is shown in (99).

- 99)
- $$[{}_{CP} [\emptyset] [{}_{IP} [INFL] [[v' \text{bertaigh } i]]]]$$
-

The filled C° requirement must still be met, as must the requirement on object pronominal encliticization. So the verb raises to C°, and the object clitic adjoins to it (100):

³⁶This form is later replaced by *no-s•mbertaigedar*, where the clitic is hosted by the semantically null preverb *no*. However, the absolute form continues to be used when there is no object pronoun. We will be concerned mainly with the period when object clitics adjoined after the main verb.

³⁷An equally empirically adequate account, consistent with the analysis of verb movement to C° proposed here, is found in Duffield (1994). He proposes that there is an extra position between the highest Inflectional position and the C°. This is the ‘‘Wackernaglian’’ head. The pronominal clitics could occupy this position in Old Irish and still be consistent with the analysis of verb movement presented here.

³⁸Old English clitics have been analyzed as marking the left edge of IP in a similar manner, see, e.g., Pintzuk (1991). This principle could equally be termed as the left adjunction of enclitics to IP in a similar manner.

100)

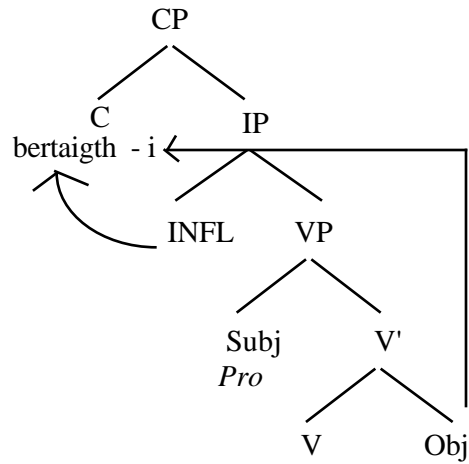

With this structure, then, we get the correct absolute inflectional marking and the correct object enclitic placement.

Let us now consider the more complicated example of a verb with a preverb such as *aton•cí* “he sees us”. The underlying structure will look like (101):

101)

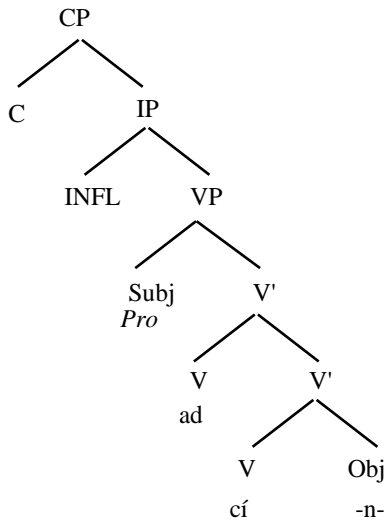

The C° requirement is met by raising the preverb *ad-*. The verb raises, through all of the inflectional heads to the left edge of IP, and the object cliticizes to C° (102):

102)

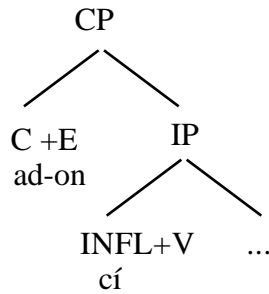

Finally, let us consider the complicated case of a verb with both a preverb and a conjunct particle: *Ní-t accai* “he does not see you”). The underlying structure is:

103) [CP[NÍ] [IP [INFL] [VP *pro* [v' [ad] [v [cí] (obj-t-)]]]]]]

The conjunct particle occupies C° and satisfies the filled C° requirement. The pronominal object cliticizes to C°. The verb first incorporates into its preverb then proceeds through the inflectional heads (104) to the left edge of IP:

104) [CP [C+E **Ní-t**] [IP [I+V+V **ad +cí**] [vp *pro* [...]]]

CPH thus account for the complex and intricate behavior of verbs, preverbs, particles and clitics in the Old Irish verbal complex. They argue that Old Irish makes use of raising to C° due to a filled C° requirement. The fact that the pretonic and the rest of the complex behave metrically like two words rather than one follows from the fact that the two elements are in different structural positions in the sentence, forming a “clitic group” rather than a single phonological word. The distribution of absolute inflection is now definable in a systematic way: when the verb has raised to C° it takes different morphology. Finally, the position of enclitics is now uniformly accounted for. They always attach to C°, whether this be a preverb, conjunct particle, or the verb itself. The fact that this analysis provides a systematic account for these facts is a strong argument for the raising to C° analysis. The filled-Comp requirement, not active in Modern Irish, thus explains many facts about the Old Irish verbal complex that would otherwise remain mysterious.

2.4 Chapter Summary

In this chapter, I've attempted to provide some strong evidence against both the flat structure and subject lowering approaches to VSO order, in particular for Irish. I have also attempted to show, following McCloskey (1991) that in principle, the approach of verb raising is the correct one for Irish. Within the confines of this approach, I have presented evidence that such an option may well be present for deriving VSO order in Old Irish, but that following McCloskey (1992b) it is not tenable for Modern Irish. With this as background I turn, in the next chapter, to the possibility that VSO order in Modern Irish involves raising to the highest head in the inflectional complex. I will survey the various versions of such an analysis and will present one of my own, synthesizing the best aspects of these previous analyses.

Chapter Three Modern Irish VSO¹

3.0 Introduction

This is the second chapter in my discussion of verb-movement and VSO order. In this chapter, I will focus solely on Irish Gaelic and will remain strictly within the class of analyses where the verb raises around the subject to an inflectional head. Of issue here is the exact location of the verb and the positions of the subject and object.

Before delving into the issue at hand, let us quickly review the conclusions of chapter 2 that are relevant here:

- i) Flat structure is inadequate for Irish because of subject/object asymmetries
- ii) There is evidence from progressive constructions for a verb/object constituent in Irish
- iii) Evidence from clefting and adverbial placement, along with theory internal problem, argue against a subject lowering account of Irish.
- iv) Evidence from ellipsis phenomena (following McCloskey 1991) argues for a verb raising analysis of Irish. However, following McCloskey (1992b), there is strong evidence from adverbial placement that this is not raising to C^o (in contrast to the situation in Old Irish where raising to C^o does seem to be the correct mechanism for deriving VSO).

With these conclusions in mind we now turn to the option of deriving VSO by raising the verb around the subject to an inflectional head.

¹The description of the Bobaljik and Carnie system for VSO found in this chapter is a revised version of Bobaljik and Carnie (1992, forthcoming).

This chapter will be organized as follows. In section 3.1, I examine previous analyses proposed in the literature for deriving Irish VSO. In section 3.1.1, I look at proposals suggesting that the subjects of Irish clauses are VP internal. I will show, however, that these all suffer from serious inadequacies with respect to Case theory, the placement of adverbials, and alternate word orders. I then turn, in section 3.1.2, to the issue of word order in Irish infinitivals which bears on the issue of the placement of nominals in Irish syntax. Finally, in section 3.2, I propose a theory of Irish VSO order that attempts to reconcile the various problems found in previous analyses.

The theory which I propose in section 3.2 of this chapter, based upon the set of assumptions laid out in chapter one and the conclusions of chapter 2, derives Irish VSO order from an underlying SVO order by raising the verb to the highest inflectional category under C° . Based on evidence from infinitives and auxiliary constructions, as well as evidence from adverbial placement, I argue that both subjects and objects raise in the overt syntax to the specifiers of case positions, which are located lower than the verb. Following McCloskey (forthcoming), I will assume that the specifier of the highest inflectional position (the specifier occupied by subjects in SVO languages like English) is unavailable for subjects in Irish due to the weakness of its features. Finally, due to theory internal problems of minimality in deriving infinitival word order and an apparent violation of the HMC, I adopt a version of the split VP theory suggested in Travis (1991), Guilfoyle (1993), Koizumi (1994, 1995), and Kratzer (1994), among many others. These mechanisms will be seen to provide the most adequate account of Irish word order consistent with the theory and assumptions laid out in chapter 1.

3.1 Verb Raising Analyses II: Raising to INFL/AGR/T

An alternative approach to VSO order to the ones presented in chapter 2 is that the verb does not appear in C° , but rather appears at the left edge of the inflectional complex, as suggested by McCloskey (1992b). In this kind of approach the verb need not raise to C° to be initial in its clause; instead it can raise to the highest inflectional category with its arguments in the specifiers of lower inflectional phrases, or in VP. We will call this class of analyses the “left edge of inflection” approach:

- 1) *The Left Edge of Inflection approach.*
VSO order is derived via head-movement of the verb to the highest inflectional head (AgrS). Arguments appear in surface positions lower than this head. There is no (overt) raising to C° .

In this section we will review the various approaches to VSO order that have been proposed along these lines.

3.1.1 VP Internal Subjects

Sproat (1983, 1985) argues, using evidence from Welsh, that VSO languages differ from SVO languages in terms of the direction of their subject case assignment. VSO languages have strictly rightward case assignment. For him, the verb must raise around an IP-based generated subject to adjoin to the S node in order to assign case rightwardly to the subject.

- 2)

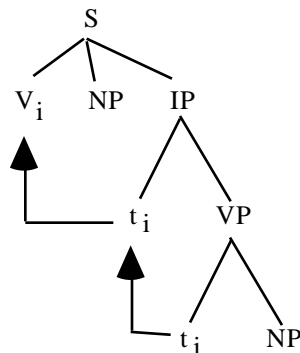

This kind of story, given the VP internal subject hypothesis of Fukui and Speas (1986), Kitagawa (1986), Kuroda (1986), Koopman and Sportiche (1991), translates nicely into an account of VSO order. Under such an account, the subject remains VP internal², and the verb raises to INFL where it assigns case rightwardly under government (3) to the subject:

3)

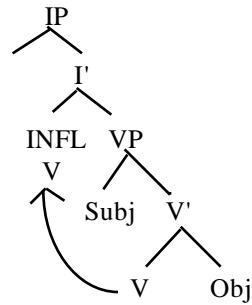

With minor variations, this is the view adopted by Guilfoyle (1990), Noonan (1992) and McCloskey (1991) for Irish; Mohammed (1988) and Fassi-Fehri (1989) for Arabic; Sadler (1988) for Welsh; Schafer (1994, 1995) for Breton; Woolford (1991) for Chamorro and Niuean; Guilfoyle, Hung and Travis (1992) for Tagalog and Cebuano; Massam (1994) for Niuean; Kaplan³ (1991) for Welsh, Breton, Berber and Biblical Hebrew, Koopman and Sportiche (1991) for Irish, Welsh, and post-verbal subjects in Italian and Kilega, and by Borer (1995) for stylistic inversion structures in Modern Hebrew, among many others.

If we are to assume the kind of theory outlined in the Minimalist Program (Chomsky 1992, 1993), discussed above in chapter 1, however, there is a strong conceptual argument against this approach. In the minimalist framework, only Agreement categories (with adjoined verbal heads) assign case, and they only do so in the minimal spec-head relation⁴. Case under government is not an available option. Chomsky's system,

²A variation on this approach is found in Shlonsky (1987) who argues that the subject in VSO languages lowers from a base generated spec,IP position to adjoin to VP. This appears to be a notational variation of the VP internal approach.

³Actually Kaplan locates subjects in the specifier of PrP, a verbal projection proposed by Bowers (1994). This projection in many ways resembles the light VPs shells of Larson (1988) and Hale and Keyser (1991)

⁴See also Aoun, Benmamoun, and Sportiche (1994) who make a similar claim about case (referring to Arabic VSO order) using a pre-minimalist assumptions.

however, does allow subjects to surface VP internally, as discussed in the MPLT. Recall that movement for case checking may apply covertly at LF, due to the principle of Procrastinate. Chomsky (1993) claims that in VSO languages, the verb moves overtly before Spell Out and the arguments remain *in situ* until LF:

4)

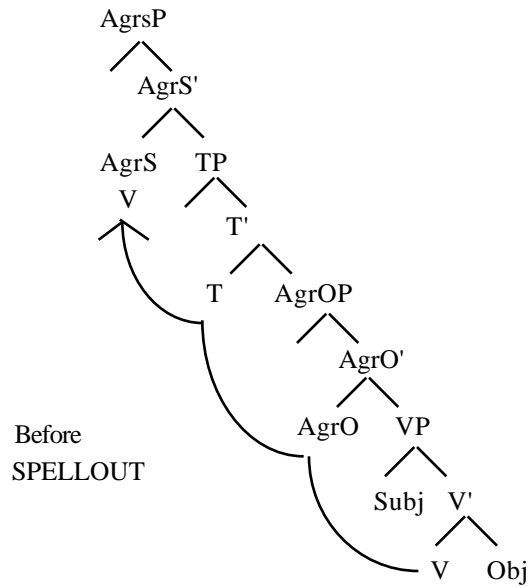

At Logical Form, the arguments raise for case/feature checking:

5)

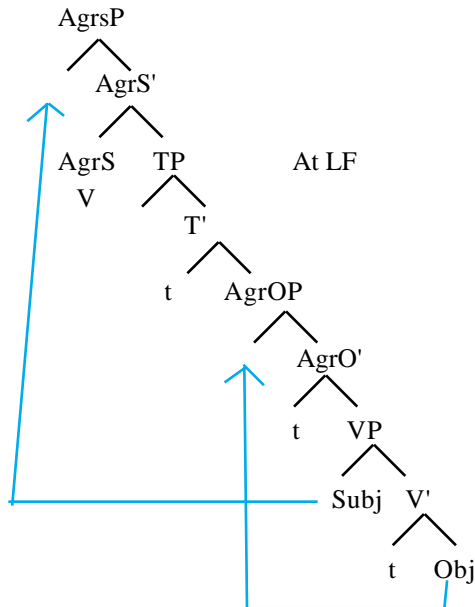

There are two serious empirical problems with such an approach for Irish⁵, both showing that subject NPs are VP external in the overt syntax in Irish. McCloskey (forthcoming) notes that certain temporal adverbs⁶, presumably VP adjoined, appear between the subject and the object in Irish⁷:

- 6) a) Níor shaothraigh Eoghan **ariamh** pingin
 V S adv O
 neg earned Owen ever penny
 “Eogan never earned a penny”

If we assume that adverbs cannot be adjoined to a single bar level category— a not unreasonable assumption— such an adverb position should not be available if both subject and object are VP internal. The second piece of evidence, as discussed by Bobaljik and Carnie (1992, forthcoming), is that there is evidence from infinitives for overt object shift⁸ in Irish (this will be discussed in more detail in section 3.1.2 below). Given that nominative subjects always appear to the left of objects in Irish, and that Irish has overt movement of objects, it follows that if the object has shifted to the outside of the VP, the subject must also be outside VP, a conclusion drawn independently by McCloskey (forthcoming) for Irish, and by Fassi Fehri (1993), Aoun, Benmamoun and Sportiche (1994), Rouveret (1991) for other languages. We can therefore assume a surface VP internal subject approach to VSO is not tenable for Irish. Given this, we can now ask, where is the subject? We must determine what specifiers the subject and the object are in, and what functional head the verb occupies. In order to do this, we turn to one of the most hotly debated issues in Irish syntax: the analysis of infinitives across Irish dialects. Readers

⁵Although it may be well motivated for Breton: see Schafer (1994) for discussion.

⁶Rouveret (1991) based on evidence presented in Awberry (1990) shows a similar fact using negation in the Pembrokeshire Welsh dialect. When the subject is a full definite NP, negation can follow the subject NP:

i) Redodd Siôn ddim i ffwrdd
 ran John not away
 “John didn’t run away”

Under the assumption that negation marks the left edge of VP, subjects in Pembrokeshire Welsh are higher than Negation, thus are higher than the specifier of VP.

⁷It should be noted, however, that the class of constructions like this is very limited. In general, as noted by Ernst (1991) and Ó Siadhail (1989), adverbs appear at the end of their clause after the object and oblique arguments if there are any.

⁸It should be noted at this point, that the claim that Irish has overt object shift is incompatible with McCloskey’s claim that temporal adverbs adjoin to VP, since these adverbs appear before the object. We will consider this question in more detail below in section 3.2.

not wanting the trials of reading a historical survey may wish to skip directly to section 3.2, where a brief summary is laid out and my analysis is presented.

3.1.2 *The Great Irish Infinitive Dialect Debate*⁹

Perhaps the one aspect of Irish syntax which has received more attention than any other is the issue of word order in non-finite clauses across Irish dialects. Let us first consider the facts. Under the hypothesis that non-finite verbs differ from finite ones only in their lack of strong tense features, and thus fail to undergo verb movement, we predict that given an underlying SVOX order, infinitive clauses should show overt SVOX order in Irish. This prediction is false. As discussed in Stenson (1981) and Ó Siadhail (1989) in standard Irish, we find (S)OVX order:

- 7) Ba mhaith liom [an teach a thógáil]
 C good with.1s the house.ACC TRANS build
 ‘I would like to build the house.’

One obvious analysis of these facts is to claim that Irish is underlyingly SOV (as suggested in Collberg (1990)). There are several problems with such an approach, however. First, it has been noted (Duffield 1991) that Irish is generally a head initial language. It has prepositions, determiners precede their nouns, complementizers precede their clauses, nouns precede all their modifiers¹⁰. This is seen in (8)

- 8) a) i nDoire b) an bhean c) bean mhór
 in Derry the woman woman big
 “in Derry” “the woman” “the big woman”
- d) Ceapaim [go bhfuil sé ansin]
 Think.1.s that be.pres he there
 “I think that he is there”

If we were to pursue an underlying SOV analysis of Irish, we would have to abandon the assumption that a given language is internally consistent with its headedness. We would

⁹Two significant papers on infinitival clauses have appeared since this work was prepared. These are Adger (1995) and McCloskey (1995). I will not discuss these here but will refer briefly to them in section 3.2.

¹⁰The exception to this are numeral modifiers which precede their nouns; see Ernst (1992) for more discussion.

have to claim that all phrases in Irish, except the VP, were head initial, but that the VP was head-final. This is clearly an undesirable result. Similarly, it's a fact of true head-final languages (such as Japanese) that oblique arguments and adjuncts precede the head. In Irish, however, obliques, quasi-arguments like measure phrases (Duffield 1991), and adjuncts follow the verb giving (S) O V X order (9)

- 9) Ba mhaith liom Seán an teach a thógáil **le casúr**
S O V **oblique**
C good with.1.s John the house Tran build with hammer
‘I want Sean to build the house with a hammer’

Finally, given an SOV analysis of Irish we never expect to find post-verbal objects. This too is an incorrect prediction. In progressives, a post-verbal object is the only acceptable form. In colloquial registers this NP is marked with accusative case. In more formal registers, in the speech of older speakers, and in prescriptive writing, this NP is marked with genitive case:

- 10) a) Tá mé ag scríobh an abairt anois (colloquial)
Be.pres I prog write the sentence.acc now
‘I am writing the sentence now’
b) Tá mé ag scríobh na habairte anois (formal)
Be.pres I prog write the sentence.gen now
‘I am writing the sentence now’

Similarly, in the Munster dialect, as will be discussed below, if an overt subject is present in an infinitive clause, then objects appear post-verbally, again, marked with genitive case marking:

- 11) Ba mhaith liom [CP Seán a^L scríobh na habairte]
C good with.1.S John.ACC TRAN write the sentence.GEN
‘I want John to write the sentence’

Note that although both genitive and accusative cases are allowed postverbally (depending upon the register) in both progressives across dialects and in Munster infinitives, only accusative is allowed in preverbal position:

- 12) * Ba mhaith liom [CP Seán na habairte a^L scríobh]
C good with.1.S John.ACC the sentence.GEN TRAN write
‘I want John to write the sentence’

This suggests that the preverbal position is the position of structural case assignment, and that the post-verbal position is the base position of the object, where it can either be assigned inherent genitive case or take accusative case and raise. The fact that we find an inherent case marking in one position but never in the other is suggestive that the place of inherent case marking is the base-generated position of objects. With all this evidence, it seems difficult to espouse an underlying SOV analysis of Irish.

3.1.2.1 *The facts of Irish infinitival dialect syntax*

If we assume an underlying SVO order for Irish, it becomes necessary to explain the SOV order. This topic has received considerable coverage in the literature, which I will survey below. However, let us first consider the facts of word order in infinitives in the various Irish dialects¹¹. These facts were first laid out in McCloskey (1980), and discussed in more detail in McCloskey and Sells (1988). In all dialects of Irish non-finite verbs take a special form (also found with periphrastic tenses) called the verbal noun (VN) (see Guilfoyle (1994) for a discussion of the semi-nominal status of VNs). Northern Irish

¹¹Modern Irish is, unfortunately, an endangered language. Current estimates suggest that only about 30 000 speakers use it as their everyday language, and these estimates may well be overly optimistic (Hindley 1992). Gaeltachtaí, (the official Irish speaking areas) are limited to isolated pockets on the west coast of the island. They are geographically, and to a certain extent culturally, isolated from one another. This means that the dialects of Irish are sometimes quite disparate in their grammars. There are three main dialect areas: the “Munster dialect”, centered now mostly in the Dingle peninsula in Co. Kerry, the “Connacht dialect”, found in Conamara in Co. Galway; and finally the “Ulster dialect” found on the northwest coast centered around the town of Gaoth Dobhair. Other Irish speaking areas exist, (including one in Co. Mayo in the east of the island), but they tend to fall dialectically speaking into one of the three categories discussed here. I refer the reader to Ó Siadhail (1989) for a more extensive discussion of the dialect splits in Modern Irish. Historically, Munster Irish was the literary standard of Irish. Much Modern Irish literature is written in this dialect, which is also the most heavily inflected. The official standard (An Caighdeán), used now in schools and in government documents, however, is mostly based on Connacht Irish, with some influences from the other two dialect areas. Ulster Irish, is in many respects the most different from the other two, it shares many inflectional, phonological, and lexical similarities to Scottish Gaelic which is spoken directly to its north. The isoglossic split that we will be discussing here, however, groups Ulster Irish and Connacht Irish against the Munster dialects. I will, following general practice in the syntactic literature on this subject, refer to the Ulster and Connacht dialects as the “Northern dialects” and the Munster dialects as the “Southern” ones. The reader should note, however, that in practice there are three distinct dialect splits for other syntactic and phonological features (e.g. the double subject construction discussed in McCloskey and Sells (1988) and Ó Baoill (1994) is strictly limited to the Ulster dialect and is never found in Connacht or Munster.)

dialects only allow SOV order (13). Whenever an object is present the “transitive” particle¹² *a^L* intervenes between the object and the VN (14a). When the verb is intransitive this particle does not appear (14b). The licensing of overt subjects does not seem to be linked to traditional ECM verbs; in fact, almost any subordinating verb allows either an overt subject or a PRO (15a&b), with the subject taking accusative case marking¹³ (15c).

- 13)a) Ba mhaith liom [CP Seán an abairt *a^L* scríobh] SO*a^L*V(north)
 C good with.1.S John.ACC the sentence.ACC TRAN write
 ‘I want John to write the sentence’
- b) *Ba mhaith liom [CP Seán *a^L* scríobh na habairte] *SVO(north)
 C good with.1.S John.ACC TRAN write the sentence.GEN
 ‘I want John to write the sentence’
- 14)a) Ba mhaith liom [CP Seán an abairt *a^L* scríobh] SO*a^L*V (north)
 C good with.1.S John.ACC the sentence.ACC TRAN write
 ‘I want John to write the sentence’
- b) Ba mhaith liom [CP Seán fanacht] SV (north)
 C good with.1.S John.ACC wait
 ‘I want John to wait’
- 15) a) Ní thaitheann leat_i [PRO_i dul]
 Neg please with.2 [go]
 “You are not pleased to go” PRO V (north)
- b) Ní thaitheann liom [mé an abairt *a^L* scríobh]
 Neg please with.2 me the sentence tran write
 “you are not pleased (for) me to write the sentence” ECM V (north)
- c) Ba mhaith liom [CP é an abairt *a^L* scríobh]
 C good with.1.S him the sentence.ACC TRAN write
 ‘I want him to write the sentence’ ECM(acc) V

The word order is different in Southern dialects of Irish. In Southern Irish, with the exception of intransitives with a controlled PRO subject (16), all non-finite clauses take the particle *a^L*. It appears with intransitives with overt subjects¹⁴ (17), and with overt objects,

¹²This particle also surfaces as *do* in some dialects and registers.

¹³Full NPs, like those in the examples below, do not show a morphological distinction between nominative and accusative cases; however, pronouns do. (See chapter 5 below for more discussion of case marking in Irish.)

¹⁴In practice, in the southern dialects, speakers will tend to avoid infinitives in general and prefer to use tensed subordinate clauses. I will abstract away from this pragmatic preference here.

when there is a controlled subject (18 — parallel to 15a). As noticed by Guilfoyle (1994), this leads to ambiguities like (19).

- 16) Ba mhaith liom_i [CP PRO_i fanacht] PRO V (south)
 C good with.1.S wait
 ‘I want to wait’
- 17) Ba mhaith liom [CP Seán a^L fhanacht] Sa^LV (south)
 C good with.1.S John.ACC tran wait
 ‘I want John to wait’
- 18) Ba mhaith liom_i [PRO_i an abairt a^L scríobh] PRO Oa^LV (south)
 C good with.1.S the sentence.ACC TRAN write
 ‘I want to write the sentence’
- 19) Ba mhaith liom [tú a^L phósadh] ambiguous
 C good with.1.S you tran marry
 ‘I want you to marry / I want to marry you’

When there is an overt subject, with a transitive verb, a marked order emerges: the subject precedes the particle, and the object is postverbal, usually with genitive case¹⁵ (20). This option is only available when there is an overt subject, otherwise OV order must be used.

- 20) Ba mhaith liom [CP Seán a^L scríobh na habairte] Sa^LVO-gen
 C good with.1.S John.ACC TRAN write the sentence.GEN
 ‘I want John to write the sentence’

As an aside, OV order is also found in all dialects in the recent perfective¹⁶ (also called the “after perfect”).

- 21) Tá mé taréis an teach a^L thógáil
 Be.pres I ASP the house trans build
 ‘I have just built the house’

The following chart summarizes the various orders in infinitival clauses in the two dialects.

The differences between the two are indicated in *bold italic*.

22)	Northern	Southern
Intransitives: Control	PRO V	PRO V
Intransitives: Overt Subject	Subj V	Subj <i>a^L V</i>
Transitives: Control	PRO Obj a ^L V	PRO Obj a ^L V
Transitives: Overt Subject	Subj <i>Obj a^L V</i>	Subj a ^L V <i>Obj-gen</i>

¹⁵See Duffield (1991) for more discussion of case marking in this dialect.

¹⁶See Ramchand (1993) and Adger (forthcoming) for discussion of the related construction in Scots Gaelic.

3.1.2.2 Chung and McCloskey (1989)/ McCloskey and Sells (1988)

The first¹⁷ analysis of these facts in terms of object shift is presented in Chung and McCloskey (1989) and McCloskey and Sells (1988). In both these works, it was proposed that $Oa^L V$ orders are derived via the adjunction of the object to VP, where it receives case from the verbal element a^L . This particle is present since the non-finite verbal noun is incapable of assigning structural case by itself.

23)

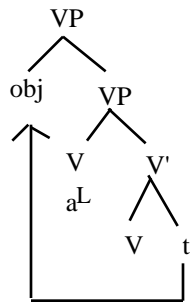

There are several problems with this approach. First, as noted by Guilfoyle (1994) it involves the addition of a new case assignment mechanism not otherwise attested in the literature: case assignment via adjunction to an A-bar position. There is also an empirical problem with such an approach: it simply cannot account for the patterns found in Southern Irish. This, in and of itself, is not a flaw of Chung and McCloskey (1987) and McCloskey and Sells (1988); since, in both cases, the authors were only dealing with phenomena in the Northern dialects. However, from the larger perspective of the grammar of Irish as a whole this is problematic.

¹⁷McCloskey (1980) presents an analysis of these facts in a traditional transformational approach positing a rule of verb postposing from a flat VSO structure:

Northern	X	V	NP	(NP)	Y	02314
					[-fin]	
		0	1	2	3	4
Southern	X	V	NP	Y	0213	
					[-fin]	
		0	1	2	3	

I will, for reasons of space, not discuss this further here.

3.1.2.3 Duffield (1990a,b, 1991)

Perhaps the earliest and most comprehensive account of these dialect difference in word order is Duffield (1991, 1990a,b). Two assumptions are critical to Duffield's account. First, he strictly adopts the split INFL structure of Pollock (1989) with only one agreement node under TP.

24)

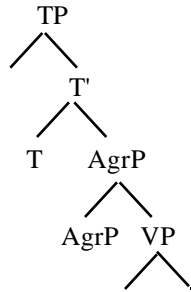

He also works under the assumption that if a particular functional feature shows up in an independent morpheme preceding the verb, then the verb cannot have raised through the head that houses that feature. He notes that not only do pre-verbal particles in Irish show negation, tense and complementizerhood (25) but that they are also morphologically decomposable (26). He concludes then that in tensed clauses the verb is no higher than agreement (27)

25) Preverbal particles:

(do) ^L	Past tense
Níor ^L	Past-negative.
Ar ^L	Past question
Nár ^L	Past negative Question
gur ^L	past complementizer
nár ^L	past negative complementizer
Ní ^L	present/future negative
An ^N	present//future question
Nach ^N	present/future negative question
go ^N	present/future complementizer
nach ^N	present/future negative complementizer

26) N-á-r
Neg-question-past

27)

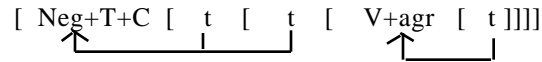

In non-finite ‘O a^L V’ clauses, Duffield claims that the object is in the specifier of Agr, headed by the particle a^L :

28)

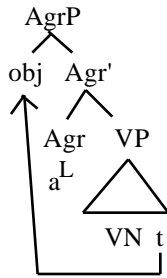

He argues that subjects in infinitives are base generated in the specifier of TP. Accusative case is licensed by non-finite tense. He claims that for reasons of minimality, the subject can not be base generated in the specifier of VP, since movement to the specifier of TP would violate economy, skipping an available A-position (the specifier of Agr) (29).

29)

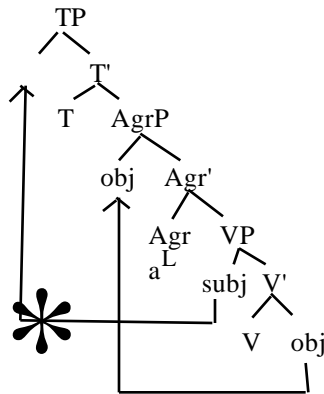

He concludes that since we get SOV order, rather than OSV order, as predicted by a VP internal subject without movement, subjects must be base generated in the specifier of TP. This problem will recur in the other analyses of Irish to be discussed below. I call this the **Minimality Problem**. Duffield is forced to claim, however, that subjects in VSO clauses

and Southern infinitives,¹⁸ however, are VP¹⁹ internal (so that the subject can absorb the accusative case of the *a^L* morpheme).

This leads us to the problems with a Duffield-style analysis. From a theoretical perspective there are two problems with this kind of approach. Duffield is forced, for theory internal reasons, to claim that subjects are base generated in two distinct positions, one the specifier of a non-theta-marking functional category. From argument structure theoretic perspective this is less than ideal. Similarly, contra the assumptions set out in chapter 1, he is forced to claim that there is more, and different, movement in non-finite than in finite clauses. In particular, he cannot claim that the movement in non-finite clauses is a subset of that found in finite ones, as would be expected given the assumptions given in chapter 1 and by the verb movement /argument movement correlations of Holmberg (1986).

These theory-internal problems aside, there are several empirical problems with his account. Several of these problems are based on data that was not available at the time Duffield was writing his work. First, we have the problem of the adverbs discussed in McCloskey (forthcoming). These adverbs, appear between the subject and object. Example (6) from above is an example of this, repeated here:

- 6) a) Níor shaothraigh Eoghan **ariamh** pingin
 V S adv O
 neg earned Owen ever penny
 “Eogan never earned a penny”

Under the assumption that adverbs cannot adjoin to a single bar level category, such data is problematic for any approach that posits a surface VP internal subject. Recall that

¹⁸I have glossed over Duffield’s account of Southern infinitives here, because of the problems to be discussed below. Roughly speaking, he claims that in southern dialects the specifier of TP is not a case position; the specifier of the lower (VP internal) subject position blocks overt object raising to the specifier of AgrP for minimality reasons, thus resulting in the S *a^L* V Obj-gen order.

¹⁹Duffield does not have VP internal subjects; instead, he has subjects base generated in the specifier of ZP: a position higher than VP, but lower than Agr. For our purposes this is equivalent to a VP internal subject.

Duffield's analysis of tensed VSO clauses has both the subject and the object as VP internal constituents. The appearance of an adverb between two such constituents is for obvious reasons problematic. The exact location of this adverb will be a recurring problem for many of the analyses sketched below. I will refer to this problem as the **Temporal Adverb Problem**.

A different problem lies in Duffield's analysis of tense morphology. Recall that Duffield's analysis of Irish head-movement has tense and negation heads incorporating into the complementizer, and the verb raising into the Agr head (27, repeated here):

27) (repeated)

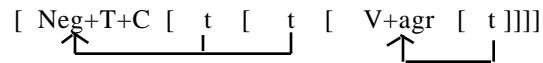

I believe there are some strong problems with this. Duffield's claim is based upon the fact that complementizers show historical vestiges of the Old Irish perfective morpheme *ro-*. The morphology of the preverbal complementizers is shown below in (30)²⁰:

30)

	Embedded		Root	
	Past	Present	Past	Present
Declarative	gur ^L	go ^N	(do) ^L	∅
Negative	nár ^L	Nach ^N	Níor ^L	Ní ^N
Question	—	—	Ar ^L	An ^N
Neg. Question	nár ^L	Nach ^N	Nár ^L	Nach ^N

The vestiges of the *ro-* morpheme are seen in the /r/ of many of the past tense forms. On the basis of this, and the simple fact that there are "past tense" forms of all these complementizers, he claims that Irish has the tense incorporating into the complementizer. The problem with this is that Irish verbs, which are not supposed to incorporate to T in Duffield's system, show a full range of tense (past, future, present, habitual). However, the complementizers — which only show a past/non-past distinction — are supposed to be

²⁰There are also a complete set of wh-complementizers which I haven't listed here, see Christian Brothers (1960) for more details

incorporated with the tense node. This seems like a strange situation to me; the element which is incorporated with the tense node doesn't show a full range of tense morphology, but the element which is not linked to the tense morpheme does show a full range of tense morphology. This apparent contradiction aside, Duffield's original question of why complementizers show an apparent past/non-past split remains open. I suggest, that the solution lies in the work of Ó Sé (1990). He claims that there is no tense distinction in complementizer particles²¹. Rather, he claims that they show a realis/irrealis modality distinction. He bases this on the semantics of the interpretation of these particles. A related analysis is found in Fassi Fehri (1993) of Arabic tense morphology, he argues there that tense morphology higher than the verb in VS structures is clearly modality rather than tense. I will adopt this approach here. Given this analysis of the particle alternations seen in (30), we have an explanation of why verbs show a full range of tense distinctions, but complementizer particles only show a binary distinction (that of realis modality): The verb raises at least as high as tense, and the modal morphology is independent of the T node.

We thus have extensive evidence that Duffield's account of the Irish dialect facts is both theoretically and empirically inadequate. It was, however, the first work to deal extensively with some interesting evidence about Irish word order and laid the groundwork for much debate.

3.1.2.4 Noonan (1992)

Noonan (1992) presents a related analysis which more closely holds to the kinds of assumptions set out in chapter 1. She assumes a two Agr system like that in Chomsky

²¹In fact, Ó Sé (1990) argues that the copula morphemes don't show tense morphology, but this modality distinction, but in other work Ó Sé (1987) claims, in the spirit of the analyses in Ahlqvist (1972), Doherty (1992, forthcoming) and this thesis (see chapter 4), that the copula and preverbal particles are all complementizer particles of a like type.

(1989). For Noonan, like Chomsky (1992), tensed VSO clauses have the verb in the highest functional head and the subject and object *in situ* within the VP:

31)

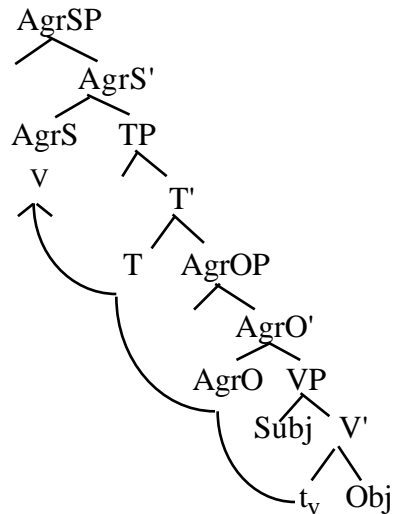

This, of course, suffers from the empirical problem of the positioning of adverbials mentioned above and in McCloskey (forthcoming). For northern non-finite clauses, she proposes that objects raise to the specifier of AgrO, licensed by verb movement. Like Duffield, she claims AgrO is headed by the particle a^L . Subjects raise to the specifier of TP where they take an exceptional accusative case marking. For Noonan, this accusative case marking is licensed by non-finite T. Non-finite T allows a subject in its specifier, since the verb does not raise to it. She proposes a principle whereby both the specifier and the head of clause cannot be filled simultaneously. A principle of *Earliness* (Pesetsky 1989) requires NPs to move as early as possible, so that in VSO clauses where the verb has previously occupied the head of TP, subjects are not allowed in the specifier of TP. In non-finite clauses, the verb has not raised, so the specifier is allowed to be occupied. This is, of course, the opposite intuition to that of Holmberg (1986) who suggests that argument movement only happens when verb movement does. Her structure for northern non-finite clauses is seen in (32).

32)

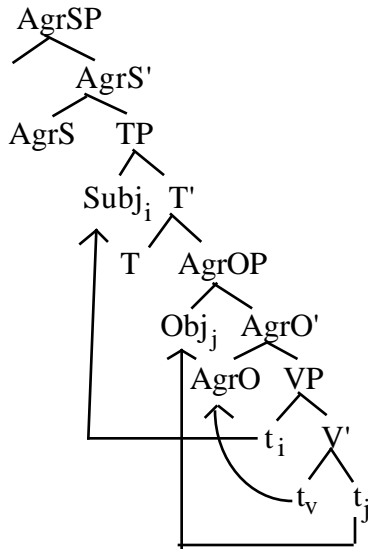

For Southern dialects, she claims no TP is projected, and both subjects and objects compete for the single Agr position, thus accounting for why an overt subject always triggers the appearance of the a^L morpheme, and why postverbal objects appear only with overt subjects:

134)

Subjects

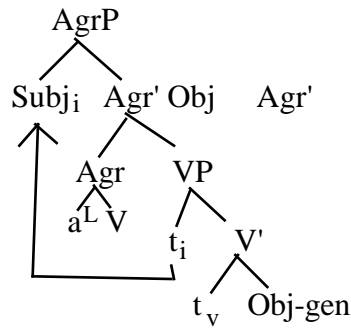

Objects

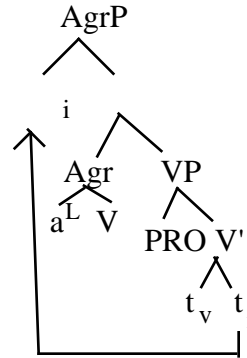

Again, as with Duffield's approach, there are some strong theoretical problems with Noonan's account. In particular, Noonan simultaneously requires both verb movement to AgrO (to license object shift) and the lack of verb movement to T (to motivate movement to the subject position). The assumptions underlying the two kinds of movement are not only incompatible, they are exactly opposite. We cannot have it both ways. Second, Noonan's account again suffers from the problem that movement in non-finite clauses is a superset of

the movement found in finite clauses. Again, an account where less verb movement means less nominal movement is more in spirit with the assumptions set out in chapter 1. Finally, Noonan is forced to claim that dialects of a given language (or for that matter between languages) vary in what functional projections are present in a particular clause — an unattractive revision to the theory.

3.1.2.5 Bobaljik and Carnie (1992, *forthcoming*)²²

Bobaljik and Carnie (1992) (henceforth B&C), in a paper originally presented in the same year as Noonan's work and later revised in (*forthcoming*), independently come to many of the same conclusions as Noonan. They agree with both Noonan (1992) and Duffield (1991) that the specifier of AgrOP is the locus of the object in OV orders and that subjects in Northern dialects are in the specifier of TP²³. They also agree with Noonan in that they assume that in southern dialects, subjects and objects compete for accusative case in AgrOP. They differ from her in terms of their accounts of finite VSO order, and in terms of the mechanisms of movement and case assignment in non-finite clauses.

Let us first consider the case of non-finite clauses in the different dialects. First, B&C claim that the reason that all nonfinite clauses in northern dialects allow overt subjects is due to ECM by a null complementizer (similar to “for” in English). They claim that southern dialects simply lack this null complementizer. If subjects are to be realized overtly in the southern dialect they simply must appear in the specifier of AgrOP, beating out the object, which is forced to take an inherent genitive. This accounts for why subjects can trigger the presence of the AgrO *a^L* morpheme in this dialect.

²²My thanks to Jonathan Bobaljik for his help in preparing this section. He is also responsible for drawing some of the trees which appear in this subsection.

²³Rouveret (1991) presages Bobaljik and Carnie in this regard by proposing the specifier of TP as the locus of subjects in Welsh. See also Pyatt (1992) and Fassi Fehri (1993) for speculations in this regard.

B&C also claim that, given Holmberg's (1986) generalization that movement of arguments is tightly linked to the movement of verbs, the movement found in non-finite clauses, where there is less verb movement, will be a subset of movement in finite clauses. In particular, they claim that, since there is object shift in non-finite clauses, the null (and minimal) assumption is that there is also object shift in finite clauses. Since subjects always precede objects in Irish, it follows that subjects must overtly shift in Irish in finite clauses. Since objects are in AgrO, and verbs must be in the highest functional head (i.e. AgrS), it follows that the subject must be in the specifier of an intermediate position: TP. This is consistent with the claim made in B&C and in Bobaljik and Jonas (forthcoming) that, for reasons of economy of derivation, a language which has overt object shift will consistently license the specifier of TP as a subject position. To summarize, B&C argue that the subject, object and verb all raise out of the VP (34).

34)

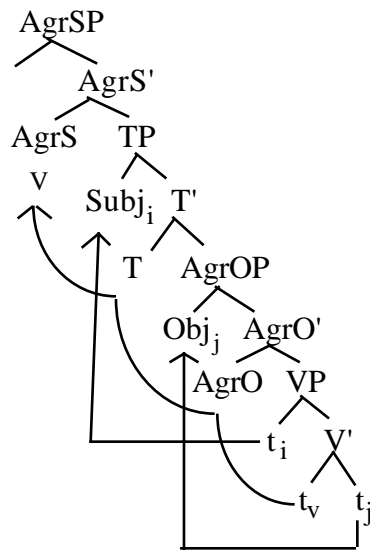

Let us explore in more detail how this works, then turn to problems with the system. The first step in the derivation is head-movement of the verb to AgrO, creating the complex head [_{AGRS} V + AgrO]. The chain created by this step allows the object to raise over the subject to the specifier of AgrO, the next highest specifier position.

35)

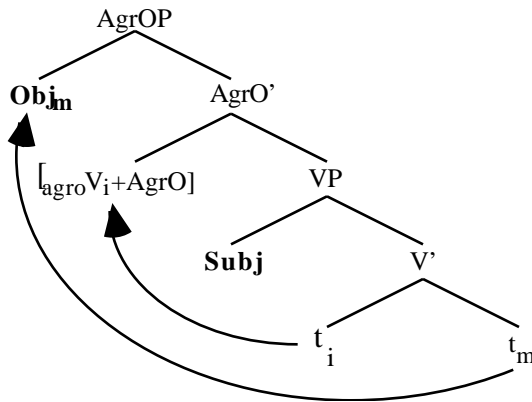

Informally, in order for the object to raise over the specifier of the VP which contains the subject, the verb must raise and adjoin to AgrO. This follows from the minimality effects of Equidistance, which ultimately can be derived from considerations of Economy (Chomsky 1991,1993). In particular, this is related to Holmberg's (1986) generalization that verb-raising is required for overt object-raising.

Next, the (complex) head AgrO (containing the verb) raises to tense (T), creating the complex head $[_T AgrO, T]$, and the subject raises to the specifier of the Tense Phrase:

36)

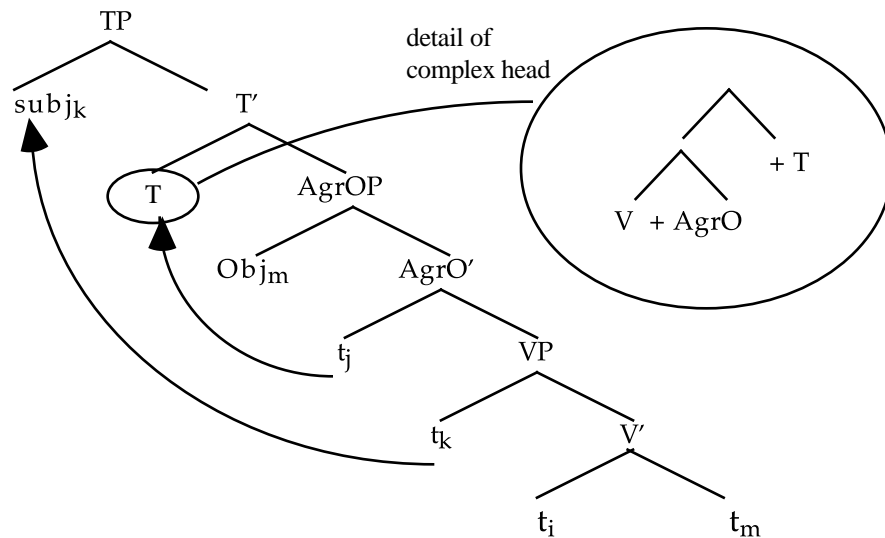

Again, considerations of economy require the head-movement in order to permit raising of the subject to ‘skip’ the intervening specifier of AgrO containing the object.

The last overt step is raising of the head T (Tense, containing Tense, AgrO and the verb) to adjoin to AgrS, creating [_{AGRS} T + AgrS].

37)

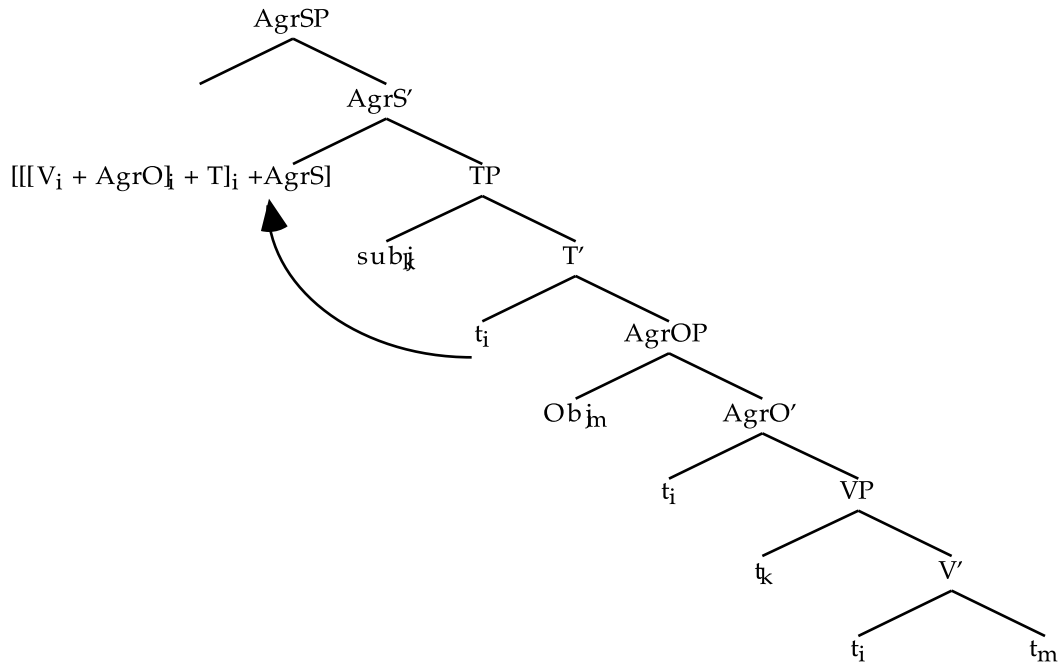

“Spell Out” occurs at this stage, resulting in “surface” VSO order.

Finally, covert movement occurs at Logical Form to check agreement features and check the nominative features of the subject. The subject raises from the specifier of the Tense Phrase to the specifier of the AgrSP. Note that this movement only occurs in the covert syntax (at LF) and is never realized in the phonological output:

38)

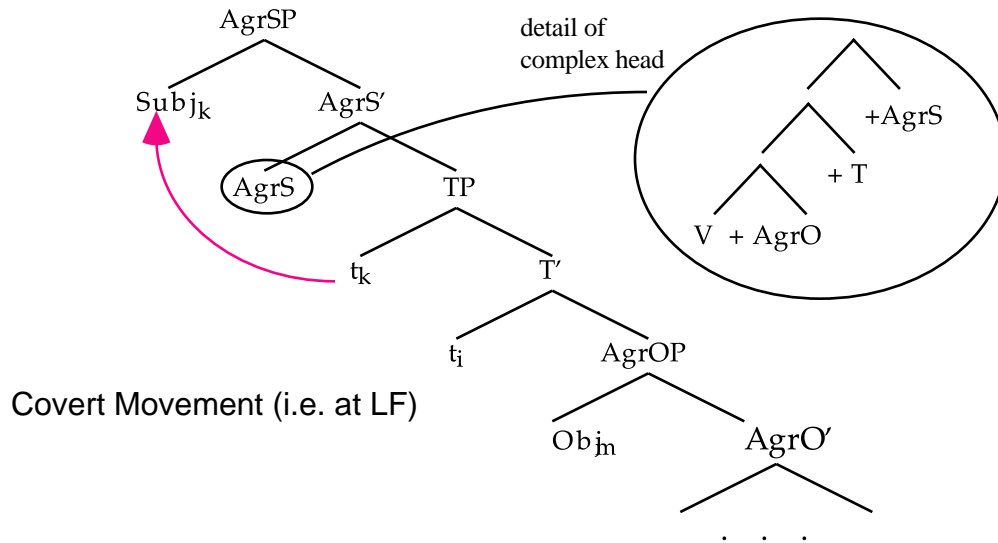

While this analysis derives the correct word order, it appears somewhat *ad hoc*. Now let us consider how such a derivation might be motivated, using the theory of syntactic features.

In B&C's analysis, Irish has strong V-features of AGR (requiring the verb to raise overtly), and strong N-features of T (requiring that the subject check its Case features in the specifier/head configuration with T), but its remaining features, including the V-feature of Tense are weak²⁴. This last is the key. In French, we saw (in Chapter 1) that strong V-features for Tense entailed overt raising of Tense to AgrS, rendering the specifier of TP unavailable, and requiring that the strong N-features of Tense be checked in the specifier of the complex head [T+AgrS]. By hypothesis, Irish has T weak V-features and thus need not (and so cannot) raise independently to AgrS. As the N-features of Tense are strong, the NP-argument which will check these features, the subject, need only raise as far as the specifier of TP in the overt syntax. The crucial difference between French, which displays

²⁴Note that B&C are using "weak V-features" somewhat loosely here. If only features of targets can vary in strength as proposed in Chomsky (1993), and not features of the heads which undergo movement (as in the text here), then "strong V-features of Tense" should be taken to mean that whatever set of features conspire to force T to raise to Agr in English "independently", their makeup is different in Irish. For more on the difference between independent raising of T to AgrS, and such raising as a part of the head chain raising, and in particular an explanation of how such raising renders the Specifier of TP unavailable, see Jonas and Bobaljik (1992).

SVO order, and Irish, which displays VSO, is a difference in the valence of the V-features of Tense, which correlates with whether or not Tense must raise overtly to AgrS (i.e. independently of the raising of V AgrO TENSE AgrS). Note that in Irish Tense does, in effect, raise overtly to AgrS, but only as a step in the sequence of Head-movements V AgrO T AgrS. This difference correlates with the possibility of checking the N-features of Tense in the specifier of TP (Irish) as opposed to in the specifier of AgrSP (with the complex head [T + AgrS]) (French). The features of English, French and Irish are thus:

39)

		English	French	Irish
AGR	N	weak	weak	weak
	V	weak	strong	strong
Tense	N	strong	strong	strong
	V	strong	strong	weak

To summarize then, the weakness of the V-feature on the Tense node indirectly licenses the specifier of TP as a possible subject position, unlike the specifier of TP in English and French. VSO order, therefore, results from the interaction of two facts. First, AgrS's N-features are weak²⁵ and Tense's N-features are strong, thus allowing NPs to raise only as far as the specifier of TP overtly. Second, and more interestingly, the specifier of TP is made available by the Tense node's weak V-features.

Let us now turn to B&C's discussion of non-finite clauses. They claim that Southern SVO non-finite clauses have their object in its base position. They claim, in contrast, like Duffield and Noonan, that in SOV infinitives, accusative objects are in the specifier of AgrOP and involve object shift. Overt raising of the object to the specifier of AgrOP is only possible if the verb has raised overtly to AgrO. Thus they are forced to claim that the verb is at least as high as AgrO in this construction. In southern dialects, subjects are also allowed to check their case features in this position.

²⁵This might correlate with the observation of Fassi Fehri (1993) that postverbal subjects are cross-linguistically linked to weak morphological agreement

The next question we must consider is how the subject is allowed to raise past the object in specifier of AgrOP if the verb has raised no higher than AgrO in the Northern dialects²⁶? That is, if the verb has not raised past the shifted object, then the specifiers of TP and AgrO should not be equidistant from the base position of the subject, thus the latter should not be able to raise overtly. This is the minimality problem of both Duffield (1991) and Noonan (1992). Bobaljik and Carnie do not try to resolve this problem, and it constitutes the greatest argument against them²⁷. Any attempt at an account of Irish word order will have to account for this fact.

Another problem lies in the specification of the N-features of Agr. B&C claimed that the N features of Agr are weak. They did this so that there is no requirement that the subject raise overtly to the specifier of AgrSP in finite clauses. In doing this, they have eliminated the trigger for object shift, which clearly appears in non-finite clauses. This is a problem they also do not attempt to resolve. This problem will arise again with respect to other analyses, I will refer to it as the **Featural Problem**. Rather than abandon the assumption that both agreement nodes have identical valency for their features, I will attempt to reconcile this view with the object shift data discussed above.

Finally, the argument of McCloskey (forthcoming) regarding adverbial position discussed above is a problem for the idea that both objects and subjects shift in VSO clauses. Recall that temporal adverbs may appear after a subject but before an object:

- 40) a) Níor shaothraigh Eoghan **ariamh** pingin
 V S adv O
 neg earned Owen ever penny
 “Eogan never earned a penny”

²⁶Recall from above that in the Southern dialects one only gets overt subjects in transitives when the object is post-verbal and genitive (i.e. one either gets OV, or SVO, but never SOV).

²⁷Watanabe (1993) offers one solution to this problem: that AgrO excorporates and raises overtly to non-finite T, stranding the main verb in AgrO. This will not be the tack taken below, since it fails to account for the adverbial and featural problems of B&C. However, it does offer an interesting solution to the minimality problem.

If these truly are VP adjoined adverbs then the object cannot have shifted to the specifier of AgrOP, as B&C claim. Of course, the assumption that these are VP adjoined adverbs can equally be called into question, as will be seen below.

3.1.2.6 Guilfoyle (1994)

Guilfoyle (1994), building on some observations of Ramchand (1993), offers what is perhaps the clearest challenge to the B&C type approach to non-finite clauses, accounting for all the problems discussed above (minimality, adverbs, and features). She does not take a stand on the derivation of finite VSO order. With respect to non-finite clauses, Guilfoyle follows Travis (1991) in assuming that there exists an Aspect phrase internal to the VP. VPs are split into a light verb, which licenses the external theta role (see also Kratzer(1993), Koizumi (1994), and Collins and Thráinsson (1994) for similar proposals), an Aspect phrase and a main VP which licenses objects:

41)

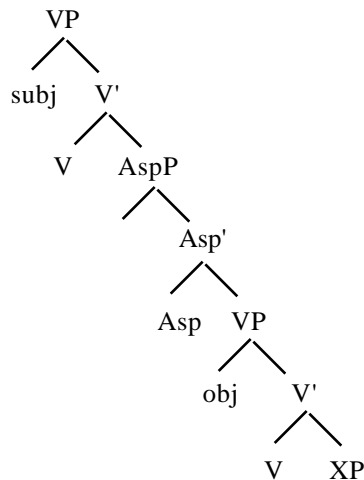

She claims that it is the specifier of this Aspect Phrase that is the locus of shifted objects, and that the particle *a^L* is an aspectual particle:

42)

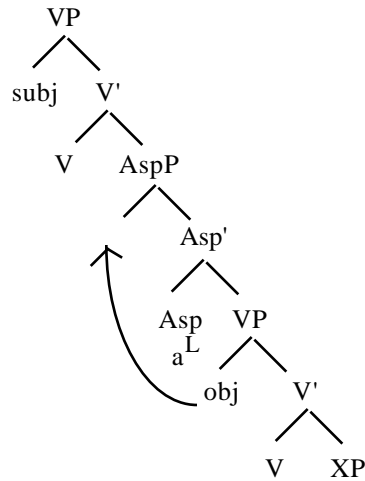

Notice that this account of Irish SOV non-finite clauses escapes the minimality problem²⁸ of B&C, Duffield, and Noonan. It also avoids the featural problem, since Agr and Asp are not necessarily predicted to be identical in terms of feature valency. Similarly, it avoids the problem of adverbial position, since adverbs can be adjoined to either the higher VP or AspP and still be both below the subject (provided the subject has raised) and above the object in finite clauses.

Turning now to the southern dialects, Guilfoyle claims [-finite] T does not select the light verb, but rather directly selects AspP. Subjects and objects are both generated in the lower VP. Either can raise to the specifier of AspP, where it triggers the appearance of the *a^L* morpheme:

²⁸Similar escape hatches from the minimality problem using split VPs are suggested in Koizumi (1994) and Noonan (1992, 1994)

43)

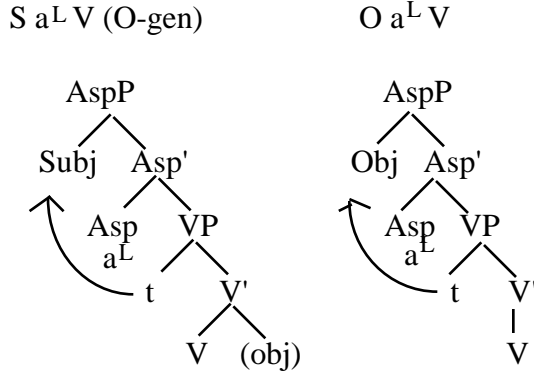

Guilfoyle's account, while it solves many of the problems found in Bobaljik and Carnie, Noonan, and Duffield, is prone to other criticism. For example, like Duffield's account, Guilfoyle is forced to claim that subjects are generated in different positions in Northern and Southern dialects.

There are also empirical reasons to believe that the *a^L* morpheme is not an aspectual particle, but an agreement morpheme. First, as shown in work by Adger (forthcoming), this particle behaves like an agreement morpheme. As discussed in McCloskey and Hale (1984), agreement and overt nominal arguments in Irish and Scots Gaelic are in complementary distribution. Except under very specific circumstances, the presence of an overt nominal argument precludes the appearance of agreement. Interestingly, in the speech of older speakers, the "transitive" particle behaves in exactly the same way as overt subject agreement. When an overt object NP is present, it takes the form of the default third person possessive pronoun *a^L* (147a). When no overt object NP is present it is inflected for person and number²⁹ (147b). When agreement is present no overt NP may surface (147c). (These data are the Irish equivalents to Adger's Scots Gaelic examples.)

²⁹Duffield (1991) claims that this option is not available for Irish. To my knowledge, he is incorrect in this regard. According to Ó Siadhail (1989) use of agreement is available in the speech of older speakers, especially in the Ulster dialect. Younger speakers tend to prefer using an overt pronominal and the default *a^L*, but both forms are found. In prescriptive grammars and formal registers, the form with no overt nominal and an agreement particle is preferred.

- 44) a) Ba mhaith liom na buachaillí a bhualadh
C good with.me the boys trans.3.sng strike
I would like to strike the boys
- b) Ba mhaith liom mo^L/do^L/a^L/ar^N/bhúr^N/a^N bualadh
C good with.me 1s/2s/3ms/3fs/1pl/2pl/3pl strike
I would like to strike me/you/him/her/us/you/them
- c) *Ba mhaith liom na buachaillí a^N mbualadh
C good with.me the boys tran.3.pl strike
"I would like to strike the boys"

These facts strongly suggests that a^L is an agreement morpheme rather than an aspectual particle (see Roberts and Shlonsky (forthcoming) and Borsley (1980) for discussion of a similar phenomenon in Welsh).

The second argument against analyzing a^L as an aspectual particle comes from the fact that it can co-occur with other aspectual particles. In particular it occurs in conjunction with the proximate perfective particle *tar éis*:

- 45) Tá mé taréis an teach a^L thógáil
Be.pres I ASP the house trans build
'I have just built the house'

Assuming that these constructions are mono-clausal, the requirement that two particles be present to indicate a proximate perfective would be quite surprising (see Adger forthcoming, for more discussion). For these reasons, then, I believe that the landing site of object shift is not the specifier of AspP, but the specifier of AgrOP.

Another paper about the positioning of objects in non-finite clauses is current in the literature: Noonan (1994). Since this paper captures many of the insights of the analysis that will be sketched below, it will be discussed with it in the next section.

3.1.2.7 Summary

The analyses and discussion in this subsection have been complex and intricate comparing theories of Irish clause types that each differ minutely from each other but are based on different assumptions and make different empirical predictions. Perhaps, then, this is a good moment to regroup the soldiers of our discussion and count our casualties in the form of a summary. We have seen that there are as many different theories of VSO as there are authors. First consider the points of agreement:

- a) OV orders involve object shift to a functional head headed by a^L .
- b) In the southern dialect subjects and objects compete for the single accusative case
- c) Northern Subjects are licensed by some default case mechanism.

What is of dispute are the following points:

- a) *VSO, SOV, SVO of related origin, in a subset relation*
 Duffield, Noonan VSO: subject and object *in situ*.
 SOV/SVO: involve argument movement
 Guilfoyle, Chung and McCloskey: no opinion
 Bobaljik and Carnie: SOV/SVO are a subset of VSO.
- b) *The nature of head occupied by a^L*
 Chung and McCloskey: Verbal head
 Duffield, Noonan, Bobaljik and Carnie: AgrO
 Guilfoyle: Asp
- c) *The solution to the minimality problem,*
 Chung and McCloskey, Bobaljik and Carnie: no discussion
 Duffield: base generation in the specifier of TP,
 Noonan: no discussion of minimality, (see Noonan 1994, however)
 Guilfoyle: Split VPs
- d) *Exact mechanism of subject case assignment.*
 Chung and McCloskey, Guilfoyle: no discussion
 Duffield: assigned by [-fin]T
 Noonan: Earliness licensing the specifier of TP
 Bobaljik and Carnie: case via complementizer ECM

In the next section, I will propose a new account of Irish VSO and infinitives that hopefully resolves some of these items of disagreement in a coherent way, but maintains the good insights of this previous work. I will assume the AgrO landing site of Noonan, Duffield and Bobaljik and Carnie, maintain as much of the minimalism of Bobaljik and Carnie as possible while avoiding the problems of features and adverbs, and will adopt a part of Guilfoyle's account of the minimality problem.

3.2. A theory of Irish VSO Order³⁰

3.2.1 The issues

Before considering my analysis, let us quickly review the issues brought up thus far in this chapter which I have to account for.

- i) First, and most obviously, we must account for basic word VSO word order. This order is repeated in (46) below.

46) Leanann an t-ainmní an briathar i nGaeilge
 follow.PRES the subject the verb in Irish
 ‘The subject follows the verb in Irish’

As discussed above, I will assume that this is a derived order and that the underlying order of Irish is SVO. In particular we must account for why the subject surfaces in position lower than verb and we must determine the principles that determine the surface position of the verb. I will assume, following the discussion in chapter 2 and McCloskey (1992), that the raising of the verb is to the highest inflectional head, and no higher (i.e. not to C°).

- ii) Second, we must account for the position of temporal adverbials, in both finite clauses and in infinitivals. Recall that certain adverbs can appear between the subject and the object as repeated in (47).

47) Níor shaothraigh Eoghan **ariamh** pingin
 V S adv O
 neg earned Owen ever penny
 “Eogan never earned a penny”

- iii) Next, we have the dialect differences in infinitives discussed above in section 3.1.2.

These difference are summarized for the reader's reference in the chart below:

48)	Northern				Southern			
Intransitives: Control	PRO		V		PRO		V	
Intransitives: Overt Subject	Subj		V		Subj	a ^L	V	
Transitives: Control	PRO	Obj	a ^L	V	PRO	Obj	a ^L	V
Transitives: Overt Subject	Subj	Obj	a ^L	V	Subj	a ^L	V	Obj-gen

³⁰For discussion related to this analysis see Barbosa (1995).

Of particular interest is the fact that subjects and objects seem to compete for accusative case in the Southern dialect, but not in the Northern dialect. This seems to correlate to the appearance of the a^L morpheme. This requires some discussion. Further we have the fact that in the Northern Dialects *all* infinitival subjects seem to be licensed via some kind of ECM, no matter what the matrix predicate is. The exact nature of this case assignment must be determined.

- iv) Related to the dialect distinctions in (iii) we have the problem of where the subject is in northern SOV orders. As discussed above in section 3.1.2, moving a subject around the object will result in a violation of Equidistance or Minimality. In section 3.1.2 we called this the Minimality Problem. This apparent violation of minimality must be given some account.
- v) Finally, we must determine the order and nature of functional heads that derive all these orders. Of particular interest is the issue we called the Featural problem, above in section 3.1.2. That is, how we can derive the correct word orders while maintaining Chomsky's assumption that Agreement Phrases are non-distinct?

In this section of the chapter then, I will show how each of these interrelated issues can be accounted for with a minimally non-stipulative analysis of functional heads and their feature valencies.

3.2.2 A revised system of functional categories:

Consider the problem of feature matching left unresolved by B&C. In order to account for why the subject NP does not raise fully to the specifier of AgrS in VSO sentences, they were forced to claim that the N-features of AgrS were weak. By contrast, since objects shift in Irish they must claim that AgrO has strong N-features. They were forced to claim that the valencies for the two Agreement heads were not identical, contra Chomsky (1992). One solution to this dilemma is to claim that Chomsky (1992) is wrong and that agreement heads are distinct in their featural makeup. This solution is not terribly

satisfying. There are also some empirical grounds for rejecting this solution. Recall that evidence from adverbs shows that subjects in Irish have raised overtly in the syntax. Similarly, evidence from the so-called ‘perfective passives’ (McCloskey 1994), which have a passive syntax (but perfective meaning) show that nominals raise to subject position for case reasons:

- 49) Beidh an trachtas críochnaithe agam amárach.
be.fut the thesis finished at.me tomorrow
“I’ll have the thesis finished tomorrow
(lit The thesis will be finished by me tomorrow)

In this sentence, the derived subject *an trachtas* “the thesis” takes nominative case in subject position. Subjects therefore can be shown to raise overtly for case reasons. As discussed above, evidence from OV non-finite clauses show that objects also shift overtly for case reasons. Since both subjects and objects raise overtly in the language, it would make sense that the features that trigger these movements are identical.

Building upon work done by Ouhalla (1994), Carnie (1991), Harley (1994), and Branigan (1992), among many others, we can assume that the case position of subject nominals, for Irish at least, is *lower* than the highest functional projection. For reasons of case assignment in Icelandic, Harley (1994) proposes, after Branigan (1992), that there is an extra functional projection corresponding to “extended projection principle” features. In earlier work she calls this an EPPP. In later work (forthcoming), following research conducted jointly with me, she labels this an extra TP, resulting in the following structure:

50)

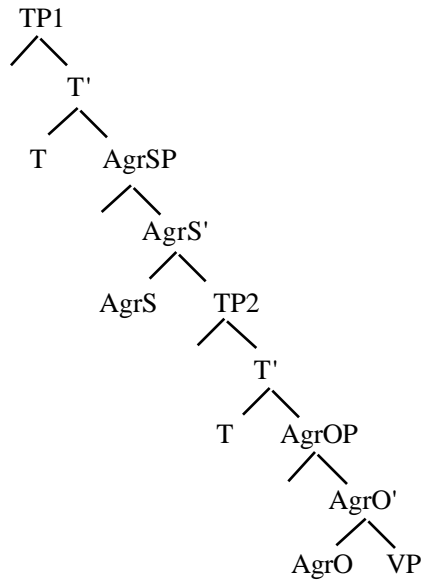

Licensing of NPs for “EPP” features happens in the TPs³¹; licensing for Case happens in Agr phrases. With this extra projection, our featural problem is now solved. Both nominal arguments can shift for case reasons, to the specifiers of the AgrPs and still be below the verb in the highest functional head (T1):

51)

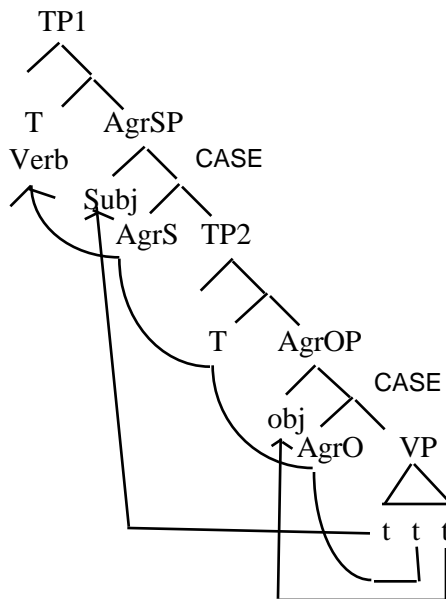

³¹See Bobaljik and Jonas (forthcoming) for a discussion of how the specifier of TP2 could be used as an EPP licensing position.

On this account, then, the Agr features triggering argument movement can be identical. We posit a strong N-feature for both the Agrs, accounting for why both objects and subjects shift overtly in the syntax.

The obvious question to ask, then, is why Irish does not require further movement of the subject NP to the specifier of TP1, like that found in languages like French. The solution lies in the status of TPs as nominal licensers. Harley (1994) proposes the features associated with this head are “EPP” features³². Interestingly, McCloskey (forthcoming) has observed that for a class of quirkily case marked unaccusative predicates in Irish, like that in (52), there appears to be no subject argument, expletive or otherwise.

- 52) Thosaigh idir na fir
 rose between the men
 “The men quarreled”

In sentences like (52) the single argument behaves like a complement rather than a subject (according to tests like clefting and the highest subject restriction (HSR)). McCloskey concludes that Irish “lacks the EPP”, but has movement for case. He notes that, in general, Irish lacks expletives³³. He claims that this follows from weak N-features in the highest functional projection (which he even suggests might be TP). This correlates nicely with Harley’s TP *qua* EPP head. We can thus posit the following feature valencies for Irish:

- | | | | |
|-----|------------|----------------------|--------|
| 53) | | Agr | T |
| | N-features | strong ³⁴ | weak |
| | V-features | strong | strong |

³²These may well be some kind of nominal inflectional features. See Pyatt (1992), Rouveret (1991), Kaplan (1991), Fassi Fehri (1993), Ouhalla (1994). for more discussion. These authors try to explain the strong/weak agreement correlations to VSO/SVO alternations found in languages like Arabic. See also Ritter (1995) and Rice and Saxon (1994) for discussion of agreement, number and correlations to multiple subject positions. I will not attempt a discussion of this here.

³³Irish does have expletives with “weather” verbs such as “rain”, and with clausal arguments. He claims that these are either truly theta marked elements (in the case of weather expletives, see also Napoli (1987) for similar arguments) or traces of CP movement (in the case of clausal arguments) so they are not true reflexes of the EPP.

³⁴The question of why we don't get expletives in the specifier of AgrP in the unaccusative sentences like (52) is a problem with this account. McCloskey (forthcoming) argues that the reasons for this follow from the strong pro-drop properties of agreement in Irish. See McCloskey for more details on this.

This revised system of functional projections also allows for an account of the fact that temporal adverbs appear between subjects and objects, but that objects shift overtly in the syntax. If we assume that these temporal adverbs adjoin to the lower TP rather than to VP, a not unreasonable assumption given their temporal character, we have an explanation of why they appear lower than both the subject and verb, but higher than the object:

54)

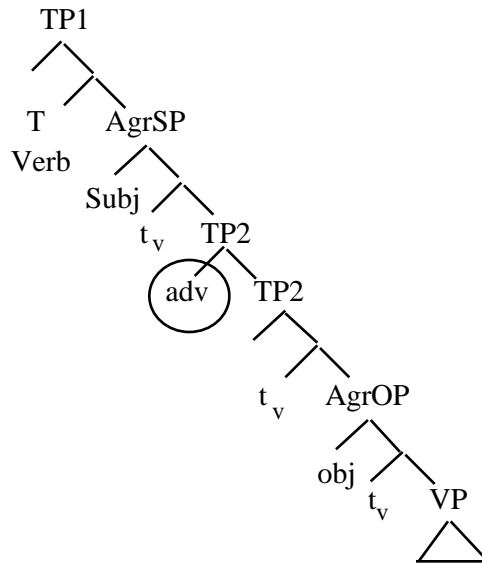

There is some empirical support for this from the positioning of such adverbs with respect to aspect particles. An example of such a sentence is seen in (55):

- 55) Bhí na sealgairí **tamall fada** *ag* amharc orthu
 Was the hunters time long prog look on.them
 “The hunters were watching them for a long time.” (McCloskey forthcoming)

In this sentence, the temporal adverb *tamall fada* ‘for a long time’ immediately precedes the progressive aspect particle *ag*. This is entirely predicted if we simply locate T2 as the aspectual head, here re-labeled as Asp³⁵:

³⁵This head might also correspond to Duffield (1994)’s ZeitsP.

56)

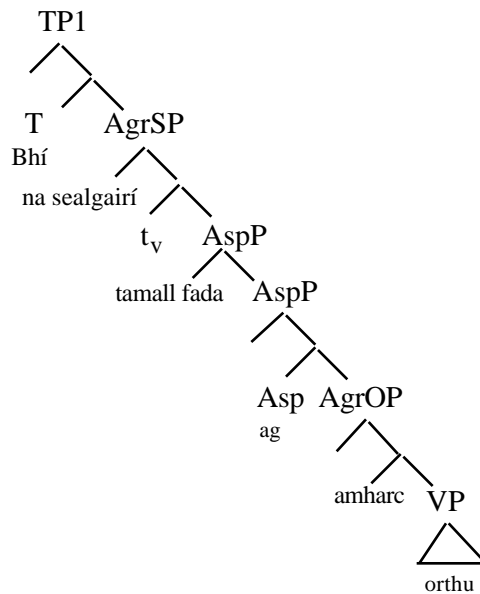

The revised system of functional projection thus allows an elegant account of adverbial placement and the lack of expletives in Irish, and allows us to posit identical N-features for the Agr heads, thus avoiding a major problem with the B&C approach.

3.2.3 *Recent perfectives, Infinitives, and Progressives*

We have not yet resolved one of the major problems of B&C (the same problem that plagued Duffield and Noonan): the problem of minimality and preverbal subjects in Northern Irish. You will recall that object shift is licensed by the raising of the non-finite verb to AgrO and no higher. The positioning of the subject before this object is an apparent violation of Shortest Move. I propose, following a suggestion by Koizumi (1994), Bobaljik (1995), Collins and Thráinsson (1994), and extensive work by Noonan (1992, 1994) and Guilfoyle (1994), that subjects are generated in a VP, headed by a null light verb, higher than AspP and AgrO. This mirrors work by Kratzer (1993) and Marantz (1984) which separates external arguments from the theta-role assignments of lexical verbs³⁶.

³⁶In work presented after this chapter was prepared, McCloskey (1995) argues that the split VP analysis

57)

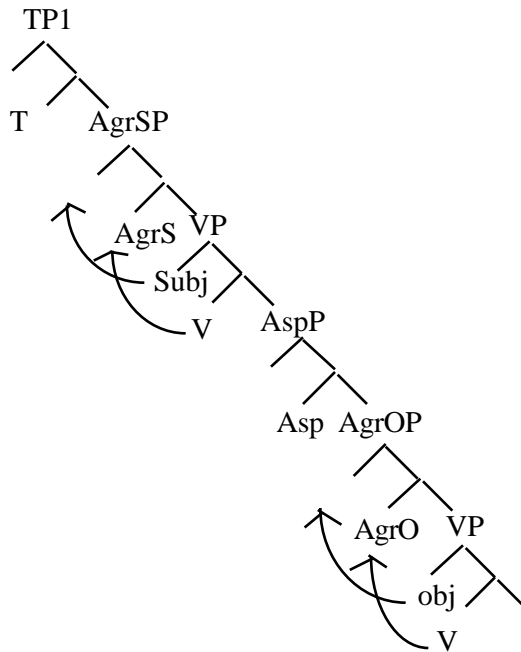

In non-finite clauses then, the lexical non-finite verb raises to AgrO, licensing object shift to the specifier of AgrOP. The null light verb raises to AgrS, licensing the appearance of the subject in the specifier of AgrS. In the Northern dialect this is always allowed.

This approach is given some empirical support by the facts of the Skye dialect of Scots Gaelic as discussed in Adger (1995). He notes that overt subjects in Scots Gaelic infinitival clauses are *only* licensed by the presense of the light verb bith "be". Omitting this verb results in ungrammaticality:

- 58) a) Bu thoigh leam sibh/Màiri a bhith a'coiseachd don sgoil
 C want with.1s you/Mary prt be prt walk to school
 "I want you/Mary to walk to school"
- b) *Bu thoigh leam sibh/Màiri a'coiseachd don sgoil
 C want with.1s you/Mary prt walk to school
 "I want you/Mary to walk to school"

Scots Gaelic, then, provides us with morphological evidence that external arguments are introduced by light verbs.

cannot account for the post-AgrO, post-verb status of certain dative subjects in Irish. Accounting for these facts will be the focus of future research.

This approach also solves a problem that has not been noted before in the literature on Irish aspectual clauses. This is an apparent violation of the head-movement constraint in the recent perfective. In later chapters of this thesis, I will show that the auxiliary *bí*³⁷ is a true light verb, not merely a realization of tense³⁸. In traditional stacked VP systems for auxiliary constructions (see, for example, Guilfoyle (1990), Hoekstra and Mulder (1990) and Dubinsky (1994) for discussion) where all the functional projections dominate all the verbal heads, the verbal auxiliary must skip two heads on its way to initial position. In sentence (58), the auxiliary *bí* must skip both the AgrO *a^L* head, and the aspectual head *tar éis*:

- 59) a) Tá mé tar éis an teach a^L thógáil
 be I after the house agro build
 “I have just built the house”

b)

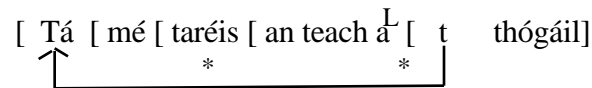

This is an obvious violation of the Head-movement Constraint (HMC). The split VP hypothesis provides a nice account of these effects, avoiding the HMC violation. The auxiliary verb³⁹ is generated above both the Asp head and the AgrO head, thus it does not skip either head:

³⁷This verb surfaces in many suppletive forms, the most common being: *tá, níl, bhfuil, beidh, beith, and raibh*. See the appendix at the end of this thesis for complete paradigms.

³⁸In particular, I will show that realization of tense in Irish in non-verbal predication structures, takes a different form than the verb ‘to be’ (it is on the declarative complementizer *Is*), and that the verb “to be” heads a real verbal projection. As a brief example of how *bí* is not simply a realization of tense, it should be noted that this verb has an infinitival form (*beith*). See also the discussion in Heggie (1988) and Kearns (1989)

³⁹I am assuming here that the light verb can be realized as either a null light verb, which the main verb raises to (resulting in VSO order), or as an auxiliary as in all aspectual constructions.

60)

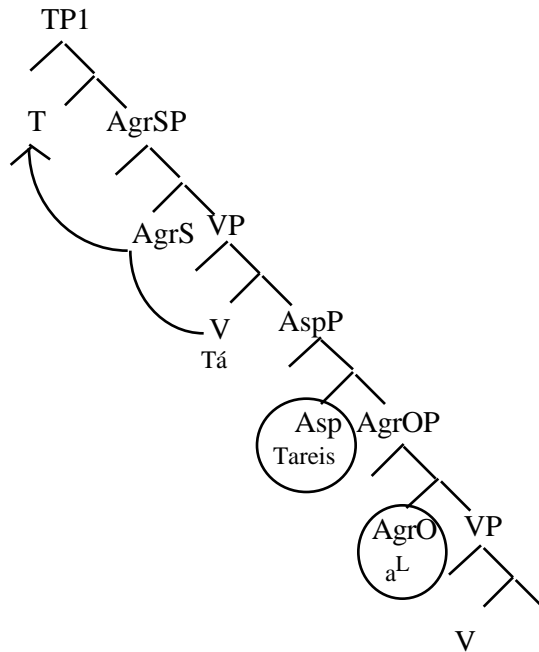

This configuration of projections provides us with an elegant placement for each element in the recent perfective clause.

By adopting the split VP story to account for recent perfectives, the minimality problem and the apparent HMC violation, however, we have run ourselves into the problem of accounting for infinitives in Southern Irish. Recall that in southern Irish, subjects and objects compete for accusative case, and both trigger the presence of the *a^L* morpheme. If the subject is generated in a VP higher than AgrO it is not clear how the subject can compete with the object for a case in a specifier position lower than its site of base generation.

Noonan (1994) proposes a solution whereby there are two AgrO projections, one above the highest VP, the other below. The inner AgrO is linked to aspect, and the outer one is where accusative NPs raise to at LF in Northern dialects. In Southern dialects, either the subject can raise to this AgrOP, or the object can raise to it overtly. When the subject

has raised to the higher AgrO, the object may not, so it must take genitive case to be licensed:

61)

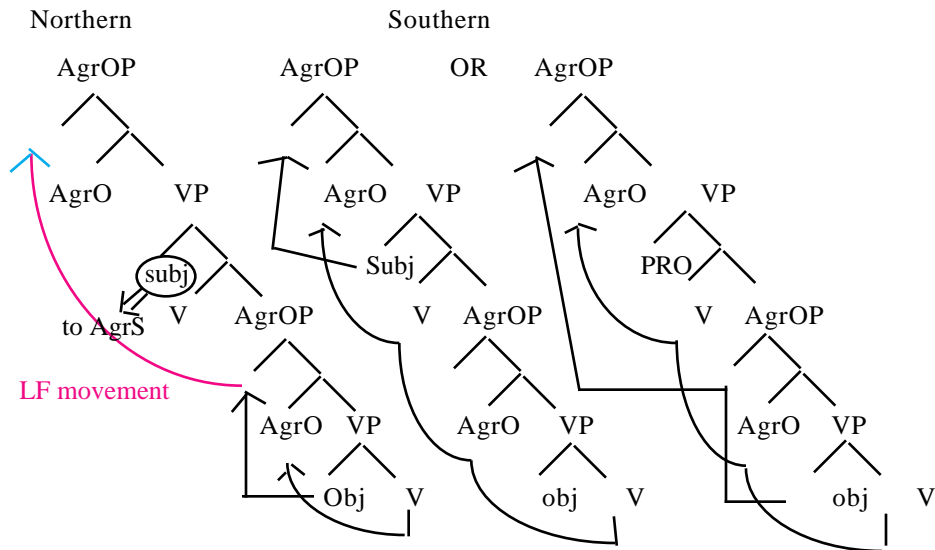

I believe that this approach is on the right track, but that there is no need to add the complication of an extra AgrO. Recall that under Chomsky's (1993) system Agrs are non-distinct, thus it follows that under certain conditions AgrS (i.e. when it is not joined with a finite T, but rather with a verbal head) could assign accusative case. I propose⁴⁰ that the difference between Northern and Southern dialects is whether the lower V incorporates into the higher light verb in non-finite clauses. In Northern dialects it never does, in Southern dialects it does so when a V+Agr sequence is needed to license an overt subject. Consider the case of a transitive clause with an overt NP subject. The verb raises to the light verb, in order to license the overt subject; the light verb and the overt non-finite verb then head-move to the AgrS, which is realized as the accusative case assigner d^L . The subject NP can raise to this position where it is assigned accusative case:

⁴⁰See Harley (1994) for a different theory of case competition.

62)

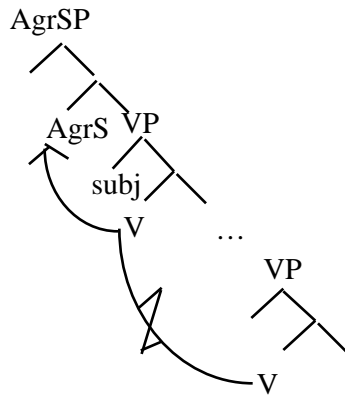

The reason the object cannot shift to the lower AgrO is that the verb has only one set of object *-features* to check, they can be checked only once and the object prefers to check them as close to the verbal head as possible (preferably in an overt spec-head relationship)⁴¹.

When there is no overt subject to be licensed (in unaccusatives or with a PRO subject), the main verb need not raise to the null light verb, and only raises to the specifier of AgrO. Like in northern dialects, the object shifts to the specifier for case checking.

Before closing our exploration of VSO, there is one more fact that bears discussion here: that being the word order in the progressive aspect in Irish. Consider the sentence in (63):

- 63) Tá mé ag scuabadh an bád / an bháid
 Be I prog sweep the boat-acc/the boat-gen
 “I am sweeping the boat”

In progressive aspect, unlike the perfective and the infinitive, the object always remains post-verbal, where it can take either accusative or genitive case depending upon register and dialect. The difference between the progressive aspect and other aspect constructions, I believe⁴², lies in the phonological status of the *ag* aspect particle. This particle is light /ə/ and may very well be a clitic. I claim, then, that the verb raises to it for phonological

⁴¹A proposal similar to this one is independently proposed in Adger (1995).

⁴²For a different analysis see Duffield (1991).

support. The object could either remain *in situ* taking genitive case, or take accusative case in the spec of AgrO, which is lower than the adjoined verb supporting aspect. The historical change from genitive to accusative, and dialect differences in these forms, may well follow from the ambiguity between these two post verbal object positions. This approach makes a very clear prediction about agreement. If the verb has raised to Asp in the progressive, object agreement, when overt (i.e. when the object is pronominal and null), should surface as part of the Asp-Verb complex rather than as an independent head. In a direct parallel to subject agreement on tensed verbs in tensed matrix clauses, we find that agreement on progressive participles is part of the AspP-V unit, rather than being an independent head:

- 64) Tá mé $\acute{a}^L/\acute{a}/\acute{a}^N$ bhualadh
 Be I his/her/their hitting
 "I am hitting him/her/them"

where $\acute{a}^L/a:L/$ = ag /ə/ + $a^L/\partial^L/$ ⁴³
 prog.3masc = prog + 3masc

$\acute{a}/a:/$ = ag /ə/ + a /ə/
 prog.3fem = prog + 3fem

$a^N/a:N/$ = ag /ə/ + $a^N/\partial^N/$
 prog.3pl = prog + 3pl

This is exactly what is predicted when the verb raises to the Asp head.

With this then, we have a straightforward account of Irish intransitive and aspectual clauses which is consistent both with a minimalist approach and the empirical facts and provides us with a nice account of VSO order in Irish.

⁴³Just to remind the non-Irish speaking reader: superscript ^L and ^N here bear no phonetic content, but are transcriptional devices (not found in the standard orthography) for indicating what initial consonant mutation is triggered by a given morpheme. ^L indicates lenition; ^N indicates nasalization/eclipsis.

3.3 Chapter Summary

In this and the preceding chapter, I have attempted to provide an account of word order phenomena of Irish VSO order. I have shown that, although such approaches may be correct for some VSO languages, there are empirical reasons for rejecting approaches using flat structure, subject lowering, raising of the verb to C, and the licensing of subjects in the specifier of VP for Irish. Instead, I have argued, following many other authors, that the verb raises to the head of the highest inflectional projection and both the subject and object raise to specifiers lower than it. I argued on the basis of evidence from infinitivals, and problems with previous approaches to infinitivals for a revised structure for functional projections. TP is the highest functional projection and is the locus of EPP feature checking. The fact that subjects in Irish don't raise to this highest specifier position in finite clauses corresponds to McCloskey's (forthcoming) observation that Irish seems to behave like it is not subject to the EPP. Subjects are licensed for case in the specifier of AgrS, dominated by TP. Subjects are base generated in the specifier of a light verb. This light VP dominates AspectP and AgrOP. This split VP accounts for problems with minimality for the locus of subjects in non-finite clauses in Northern Irish, and accounts for two apparent HMC violations in the recent perfective. Temporal adverbs which appear between the subjects and objects are adjoined to AspP. After Duffield (1991), objects are licensed in the specifier of AgrO in both finite and non-finite clauses. In non-finite clauses, where the verb does not raise to TP, AgrO is realized as the a^L morpheme and its object agreeing allomorphs. Now that we have finally developed an account of raising of verbal predicates in Irish, in subsequent chapters I will extend the analysis to non-verbal predicates.

Chapter Four

Forms of the Verb *To Be* in Irish

4.0 Introduction

This chapter begins my three chapter discussion of the behavior of non-verbal predication in Irish. In this chapter, I discuss the distribution and syntactic behavior of two different copular constructions in Irish: the *Tá* (*Bí*) and *Is*¹ constructions. In chapter 5, I look in detail at a word order alternation within the *Is* class of constructions. The final section on Irish copular constructions will be chapter 6, where I show how the analysis developed in this section and in chapter 5 runs into problems with complex non-verbal predicates, and will present a solution based on Chomsky's (1994, 1995b) Bare Theory of Phrase structure.

Like Spanish and many other languages, Irish has at least two constructions which roughly mean *be* in English. These are *Tá* (or *Bí*) and *Is*. *Tá* is known in the prescriptive grammars as ‘substantive be’; *Is* on the other hand is known as ‘copular be’. I will avoid this nomenclature where possible, since strictly speaking, both are copular in nature. I use

¹For the reader's information, these morphemes are pronounced [ta:], [bi:] and [is] (not [iz]). Irish often seems to the reader to be a language designed to frustrate English speakers because of its complex spelling and highly suppletive morphology. The forms of the verb *Tá* are no exception. In the appendix to this thesis, there is a complete set of paradigms for *Is* and *Tá*.

the Irish words *Tá* and *is* instead. There are two different versions of the *Is* construction. One which is used in a predicative sense and is used with indefinite nominal predicates, and the other is equative used with definite nominal predicates. Examples of these constructions are seen below in (1b&c). Notional predicates are shown in *italics*; notional subjects are shown in **boldface**. Example (1a) is an example of the verbal *Tá* construction where the *Tá* auxiliary stands in initial (verbal) position, followed by the subject (in this case 'Jean Luc Picard') marked with nominative case, and then the non-verbal predicate (*mór* 'big'). Nominal predicates are almost never allowed in this construction (see discussion below for more details). Example (1b) shows the predicative use of the *Is* construction. In this form, the *Is* morpheme is immediately followed by the indefinite nominal predicate, which is in turn followed an optional agreement morpheme and the subject² (*an dalta* "the ensign"). The equative *Is* construction has the subject (marked obligatorily with the preceding agreement morpheme), *Jean Luc Picard*, preceding the definite NP predicate (*an captaen*, "the captain").

- 1) a) *Tá* **Jean Luc Picard** *mór* *Tá*
 be.Pres big
 "Jean Luc Picard is big"
- b) *Is* *Clingeán* (é) **an dalta** *Is* (predicative)
 C Klingon (agr) the ensign
 "The ensign is a Klingon"
- c) *Is* é **Jean Luc Picard** *an captaen* *Is* (equative)
 C agr the captain
 "Jean Luc Picard is the captain"

For the moment, we will not deal with the equative construction (1c) and return to it in Chapter 5. In this chapter, I make two distinct points. First, I will show that the *Is* morpheme in (1b&c) does not behave like a real verb, and is really behaving like the preverbal complementizer particles found elsewhere in Irish grammar. Second, contra Doherty (1992, forthcoming) (who claims the distinction between *Is* and *Tá* is one based

²This subject takes accusative case. The case marking properties of this construction are discussed in chapter 5.

on the semantic stage/individual level contrast) I claim that the class of constructions involving *Is* have the non-verbal predicates taking inflectional features directly and that these predicates raise through the inflectional complex to clause initial position in a manner completely comparable to tensed verbal predicates (2):

2)

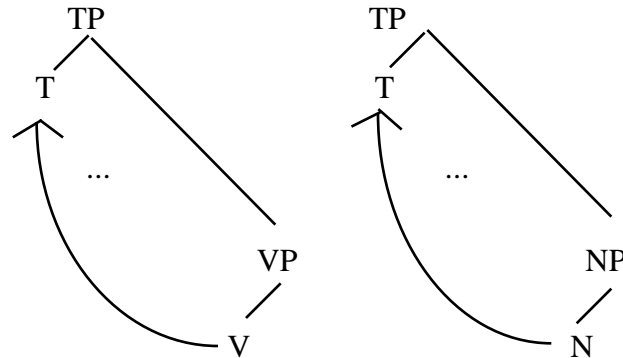

The class of *Tá* predicates, on the other hand are those that cannot directly bear inflectional features, thus need the support of the verbal auxiliary *Tá*, like non-verbal predicates in English need support from *be* for inflectional support.

In section 4.1, I examine evidence from syntax, morphology, phonology, language acquisition, and historical change that the *Is* morpheme, despite its traditional prescriptive analysis as a "defective" verb, is in fact a complementizer particle. In section 4.2, I argue for the analysis described above, where non-verbal predicates found in the *Is* constructions are marked with inflectional features and raise overtly in the syntax through the inflectional complex. The predicates found with *Tá*, on the other hand, are unable to bear such features and thus require the presence of the verbal auxiliary *Tá* to support their inflectional features. In section 4.3, I provide a brief explanation of the apparent correlation between the *Is/Tá* alternation and the stage/individual level distinction in terms of light verbs licensing event arguments.

4.1 *Is* is not a verb³

In this section, I explore the categorial status of the morpheme *Is*. I claim, following Doherty (1992, forthcoming), Hendrick (1995) and Alqvist (1972), that *Is* is not a verb, but is rather a pre-predicate complementizer particle. In traditional grammars, *Is* is often referred to as a "defective" verb (see Ó Maille 1912). From a purely descriptive perspective, as well as a historical one, there is some justification for this assumption. First, like verbs in declarative clauses, *Is* is initial in its clause. From a historical perspective, the analysis of *Is* as a verb is also understandable. In Old Irish, the *Is* morpheme was fully inflected like a verb, and shows many similarities to English "is". This is seen in (3).

3)	Am	1s	ammi	1p/	
	at/it	2s	adib/adi	2pl	
	is	3s	it	3pl	(Old Irish)

These historical and distributional arguments aside, however, there is overwhelming evidence that Modern Irish *Is* is not a verb, but is a complementizer particle.

4.1.1 *Is* as a particle

The strongest evidence for the claim that *Is* is not a verb is syntactic. There is an obvious difference in word order between the predicative *Is* construction and normal sentences with tensed verbs. Irish has a set of pre-verbal complementizer particles, these particles appear first in the sentence always immediately preceding the verb. They show negation, questionhood, embeddedness, and a realis/irrealis mood distinction (Ó Sé 1990).

4)	Níor	thóg	Seán	an	teach
	<i>Neg.past</i>	<i>build</i>	<i>J</i>	<i>the</i>	<i>house</i>
	"John did not build the house"				

³This section draws heavily on the work of Doherty (1992, forthcoming) and I owe him a large intellectual debt.

It is my contention (following Doherty 1992, forthcoming, and Ahlqvist 1972) that *Is* and its allomorphs⁴ are simply the forms of these preverbal particles that appear on non-verbal predicates. This is confirmed by the fact that if we assume that *Is* is a particle, nominal predicates appear structurally in the same position as tensed verbs:

- 5) a) Is + Predicate + subject
- b) **Particle + Predicate** + subject
 [Níor rith] sé
neg.past run he
 "he did not run"
- c. **Particle + Predicate** + subject
 [Níor dochtúir] é
Neg.past doctor him
 "He was not a doctor"

The word order for both types is that found in (5a): the particle is immediately followed by the predicate, which in turn is followed by the subject. This suggests that *Is* is functioning like a preverbal particle on sentence initial nominal predicates rather than like a verb. There is a plethora of supporting evidence for this claim.

First, we have some weak morphological evidence that these morphemes are at least loosely related to the preverbal particles. In many, but not all, cases the particles are identical to, or very similar to, the forms of the *Is* morpheme. This is seen in the following table:

⁴For a complete paradigm see the appendix at the end of this thesis.

6)

Unembedded (without Comp)								
Irrealis (past)				Realis (non-past)				
	Decl	Q	Neg	N,Q	Decl	Q	Neg	N,Q
<i>Is</i>	ba ^L	ar	níor	nár	is	an	ní	nach
<i>Particle</i>	—*	ar	níor	nár	—	an ^N	ní ^L	nach ^N

Embedded (with Comp)								
Irrealis (past)				Realis (non-past)				
	D	Q	Neg	N,Q	Decl	Q	Neg	N,Q
<i>Is</i>	gur ^L	ar	nár	nár	gur	an	nach	nach
<i>Particle</i>	gur	ar	nach ^N	nár ^N	go	an	nach ^N	nach ^N

* An old past-tense particle “do” is sometimes still seen in the written language
^L= form that lenites, ^N= form that nasalizes the following word⁵

This of course, is not in any way conclusive, but it is suggestive. However, the fact (Doherty (1992, forthcoming) that *Is* cannot cooccur with these particles is stronger evidence⁶:

7) *Ní is amadán é
Neg.pres C fool him
 “He is not a fool”

Instead of taking a particle, the copula shows the mood, questionhood and negation in a *port manteau* form:

⁵For a discussion of the mutation properties of *Is* see Duffield (1991) and Elordieta (1994)

⁶This is, in fact, a gross simplification of the data, there are certain co-occurrences of the *Is* morpheme with complementizers, many in the past tense. For example the past conditional is:

- i) Má ba
 if "is".past

Similarly, the past negative question the form *Nárbh* is decomposable into (ii)

- ii) N-á-r-bh
 Neg-Q-Past-"Is"

where the <bh> ending on the particle is a clear lenited reflex of the *ba* allomorph of the *is* morpheme. In the Cois Fhairge Dialect (Co. Galway) (Ó Siadhail 1989: 221), we find co-occurrence of preverbal particles with many forms of the copula as in (iii):

- iii) go mba An mba
 that is.past Q is.past

Although these may appear at first glance to be blatant contradictions to the claim made in the main text, two things should be noted about these forms. First, they are somewhat marked and are limited to specific dialects. Second, even though these forms are sometimes *written* as multiple words, it is not inconceivable that they are dominated by a single syntactic head. This is especially likely given that these elements together form a single phonological unit which cliticizes to a following word. Recall, there is no reason that a single head in the system of grammar described here could not be morphologically complex, either through base generation, or through head movement and incorporation. An example of how the multiple word analysis of these elements may be simply an orthographic quirk of the Irish writing system is found in the word *Nárbh* (ii), which is as clearly multi-morphemic as *go mba* (iii). The fact that *go mba* is written as two words is probably simply an arbitrary convention rather than a consequence of the syntactic configuration.

- 8) Ní amadán é
 C.neg.pres fool him
 "He is not a fool"

This is behavior that would be expected of a particle, but not of a verb.

4.1.2 Morphological evidence

Further evidence that *Is* is not a verb comes from the inflectional morphology of Irish verbs. Doherty (1992, forthcoming) notes that in Irish, verbs are inflected for a full range of tenses and moods, past, present, future, conditional and subjunctive. The copula is not; it only has a present/past distinction

- 9) Present/Future Past/conditional
 Is *ba*

This is a feature that *Is* shares with the preverbal particles. Preverbal particles also only show a past/non-past distinction.

Similar facts are found with respect to agreement phenomena in Irish. In all dialects of the language, certain person/number combinations in certain tenses allow an optional pro-drop agreement pattern (cf. McCloskey and Hale (1984) for more discussion). Take, for example, the pattern seen with the verb *Tá*. Two options are available: either the inflected verb may surface with no overt pronoun (10a), or a verb with no overt agreement may surface with an overt pronoun (10b)⁷:

- 10) a) Táim *pro* "I am"
 b) Tá mé "I am"

These patterns are productive throughout the verbal system of Irish. They are never found, however, with *Is*.

- 11). **Isim* "I am"

⁷*Tá* is, in fact, an exception in allowing both forms to surface. With other verbs if an agreeing form exists in the paradigm, then it entirely blocks the appearance of the form with a pronoun.

4.1.3 Phonological evidence

There is also considerable phonological evidence that *Is* and its allomorphs are particles rather than verbs. Firstly, unlike verbs (12c&d), it may delete freely in fast speech as shown in (12a&b)

- 12) a) *Is dochtúir é*
C doctor him
“He is a doctor”
- b) *dochtúir é*
doctor him
“He is a doctor”
- c) *Tá sé mór*
be he big
“He is big”
- d) * *sé mór*
he big
“he is big”

The *Is* morphemes also behave like preverbal particles, in that they form a proclitic to the word that follows them. For example, the underlying /s/ of the *Is* morpheme will palatalize to /ʃ/ before a high front vowel. Normally, such palatalization is restricted to clitic groups.

- 13) *Is é Seán an dochtúir* /is e: .../ [ʃe:...]
C agr John the doctor
“John is the doctor”

Similar evidence comes from ellipsis phenomena (Doherty 1992, forthcoming). Like other proclitics, the *Is* morpheme requires some phonological support to its right. Modern Irish, as will be discussed more extensively below in chapter 6, has no words for yes or no. Instead, the appropriate response to a yes/no question is the appropriately negated or affirmative form of the verb, with the rest of the sentence elided (McCloskey 1991, Doherty 1992):

- 14) *An bhfuil tú tinn?* *Tá.*
Q be.pres you sick. Am (yes)
“Are you sick? Yes”

This is not true of *Is*. *Is* cannot stand on its own. At the very least it requires the meaningless pronoun *ea*, if not the predicate itself, for phonological support.

- 15) a) An dochtúir tú? Is ea/ *Is
*Q doctor you C ø/*C*
 "Are you a doctor" "yes"
- b. An leatsa an Chevy? Ní liomsa/*Ní
Q with.2.s.emp the Chevy? C.neg with.1.s.emp
 "Is that your Chevy?" "No"
 (Lit: Is with-you the Chevy? Not with-me)

Evidence from adverb placement also supports the theory that *Is* is a proclitic particle. *Cinnté* "certainly" can be placed after a lexical verb and before the subject when that subject is a full NP⁸:

- 16) Bhí, cinnte, Seán tinn
was certainly, J sick
 "Certainly, John was sick"

This is not true when the subject is an enclitic pronoun (Chung and McCloskey 1987: 226-228):

- 17) *Bhí, cinnte, sé tinn (cf ✓Cinnté, bhí sé tinn)
Was, certainly, he sick
 "Certainly, he was sick"

Cinnté insertion, then is impossible between a clitic and its host. *Cinnté* cannot appear between *Is* and the predicate (18).

- 18). *Is, cinnte, dochtúir é
C certainly, doctor him
 "Certainly, he is a doctor.

This clearly suggests that *Is* is a clitic, thus providing support to the hypothesis that *Is* is a particle rather than a verb⁹.

⁸This, obviously, is an exception to the strict VSO order of Irish discussed above in chapter 2. *Cinnté* is one of only a few adverbs that can be found non-initially. Only appositive adverbs may appear in this position.

⁹This is assuming that functional elements show up as particles which often take the form of morphophonological clitics, whereas lexical items (pronouns excluded) rarely show up as morphophonological clitics. See Cardinaletti and Starke (1994) and Barbosa (forthcoming) for discussions of the nature of clitics.

4.1.4 Language shift evidence

There is also evidence from historical merger to suggest that *Is* is truly a preverbal particle. Ó Sé (1987) notes that in West Kerry Irish, there is a definite trend toward the phonological merger of the preverbal particles and *Is*. For example, older generations distinguished the question form of *Is* from the question particle, by the fact that the particle triggered the eclipsis mutation on following words (indicated here by a superscript ^N), the copula did not. In the speech of most modern speakers these two have merged and both particle and copula trigger eclipsis and have an identical phonological shape:

- 19) $\text{an} > \text{an}^N$ $\text{an}^N > \text{an}^N$
 Q.is *Q.part*

4.1.5 Language Acquisition Evidence

Finally, we have some evidence from language acquisition that *Is* is a complementizer particle. Children overgeneralize the use of the *is* morpheme from contexts with non-verbal predicates to contexts involving verbal predicates. Take for example the forms seen in (20). In adult speech the declarative preverbal particle on a verb like "see" is a null form; the form found with non-verbal predicates is *Is*. With both negative verbs and non-verbal predicates the form used is *Ní*. In the speech of a 6 year old Ó Murchú (1993)¹⁰ found an example of the *Is* morpheme used in a declarative sense with a verb, resulting in the form *Is fhaca*, impossible in adult speech¹¹.

¹⁰Ó Murchú is not specific as to whether this child is a native speaker or an second language learner, although given the age of the child and the location of much of Ó Murchú's work (Dublin), it is likely to be a child from an English-medium home, who has attended a *naíonra* (Irish language play group) and is now attending *bunscoil* (Irish-medium elementary education). In any case, this overgeneralization is startling confirmation of the fact that *Is* is a particle and not a verb.

¹¹This form is doubly unacceptable for adults. First, it uses the *Is* morpheme with a verb. Second, the wrong initial consonant mutation has been triggered on the verb. Were *Is* licit with verbal morphemes, we would predict **Is faca* not **Is fhaca*.

20)

Adult Speech			
Verbal Predicates		Nominal Predicates	
Positive: \emptyset	Negative: Ní	Positive: Is	Negative: Ní
\emptyset Chonaic mé Saw I	Ní fhaca mé Neg saw I	Is cailín mé C girl I	Ní cailín mé Neg girl I

Child Speech			
Is fhaca mé C Saw I	Ní fhaca mé Neg saw I	Is cailín mé C girl I	Ní cailín mé Neg girl I

4.1.6 Summary

From the morphological, syntactic, historical, phonological and acquisition evidence, then, I conclude that *Is* is really a pre-predicate complementizer particle rather than a verb. Now that this is clear, in the next section, I will discuss what determines whether a non-verbal predicate appears with verbal *Tá* or in the *Is* constructions.

4.2 Where *Is* and *Tá* are found.

In this section, I provide an account of the difference in usage between *Tá* and *Is*. In section 4.2.1, I describe the distribution of the two constructions. In section 4.2.2, I discuss Doherty's (1992, forthcoming) account of *Tá* and *Is* in terms of Carlson's (1977) stage/individual level distinction. I will reject this proposal on the basis of distributional evidence and instead will propose an analysis in terms of what lexical items and classes of lexical items in a given language may bear inflectional features. I will claim that the predicates found with *Is* are simply those that are allowed to bear inflectional features in Irish.

4.2.1 The distribution

Let us start by examining where each construction appears. *Tá* appears with all types of predicates except nouns¹². Examples of *Tá* with various types of predicates are seen below in (21):

- 21) a. Tá sé mór (adjectives)
Be.pres he big
 “he is big”
- b. Tá Seán go maith (adverbs)
be.pres John adv well
 “John is well”
- c. Tá Seán i mBaile Átha Cliath (PP)
be.pres J in Dublin
 “John is in Dublin”
- d. Tá Seán ag rith (verb- with progressive)
be.pres J prog run.
 “John is running”
- e. Bhí an obair déanta (verb-with passive/perfective)
be.past the work done
 “The work was done”
- f. *Tá sé dochtúir (*NP)
be.pres he doctor
 “He is a doctor”

Is, on the other hand, is found most productively with nominal predicates¹³:

- 22) Is dochtúir mé (NPs — Productive)
C doctor me
 I am a doctor

It is not generally found with adjectives (23) or prepositions (24) and is never found with verbal participles (25)¹⁴

- 23) *Is cliste iad (*adj)
C clever them
 “they are clever”

¹² See below for an exception to this generalization.

¹³ Except in some Northern Dialects (eg Gaoth Dobhair) (Ó Siadhail 1983)

¹⁴The *Is* morpheme is found with adjectives and prepositions in reverse pseudocleft focus constructions. For reasons of space, I will not be discussing them here, but let it suffice to note that such focus items clearly have a different semantic role than the predicates here described.

- 24) *Is i nDaoire Seán (*PP)
C in Derry John
“*John is in Derry”
- 25) *Is ag rith é (*Verb)
C prog run him
“he is running”

Doherty (1992, forthcoming) notes that there is a set of exceptions to the generalization that no adjectives or prepositional phrases may appear as predicates with *Is*.

The following lexically specified set of adjectives¹⁵ is found with *Is*:

- | | | | | |
|-----|-----------------|------------|-------------------|-----------|
| 26) | <i>fiú</i> | worthwhile | <i>fíor</i> | true |
| | <i>maith</i> | good | <i>olc</i> | evil |
| | <i>aisteach</i> | odd | <i>iontach</i> | wonderful |
| | <i>ceart</i> | right | <i>cóir</i> | just |
| | <i>leor</i> | sufficient | <i>mór</i> | big |
| | <i>beag</i> | small | <i>fuair</i> | cold |
| | <i>gruama</i> | gloomy | <i>cosúil</i> | similar |
| | <i>ionann</i> | equivalent | <i>greannmhar</i> | funny |
| | <i>mall</i> | slow | | |
- (from Doherty (1992))

This is seen in the following example taken from Doherty (1992).

- 27) Más ceart mo chuimhne (from Doherty 1992)
if+C right my memory
“If my memory is right” (Más = Má + Is)

Similarly, there is a set of exceptional PP predicates which may appear with *Is*. These are seen in (28).

- | | | | |
|-----|----|----------|-------------------------|
| 28) | de | “of” | (meaning origin) |
| | as | “out of” | (meaning origin) |
| | ó | “from” | (meaning origin) |
| | le | “with” | (indicating possession) |

Examples of these are seen below:

- 29) a. Is de bhunadh Phrotastúnach í
C of stock Protestant her
“She is of Protestant stock” (from Doherty 1992)

¹⁵Ó Siadhail (1983) notes that many of these exceptions are falling out of use in favour of *Tá*. In Old Irish All adjectives were found with the *Is*, and never with *Tá* (OIr. *attáú*). During the Middle Irish period, usage shifted and only nominal predicates were found with *Is*. See Ó Máille (1912), Thurneysen (1980), Dillon (1927/28)

- b. Is as Inis Eoghain é
C out-of Inish Owen him
“He is from Inish Owen” (from Doherty 1992)
- c. Is ó Bhaile Átha Cliath iad
C from Dublin them
“They are from Dublin” (from Doherty 1992)
- d. Is liomsa an t-Alfa Romeo sin
C with.me the Alfa Romeo that
“I own that Alfa Romeo” (from Doherty 1992)

We can conclude then that *Tá* is allowed with all predicates except nominal ones, and that *Is* is found with all types of predicates except verbal ones, but is only productively found with nominal predicates. This is summarized in the following table.

30)		<i>Tá</i>	<i>Is</i>
	NP	*	productive
	ADJ	productive	closed class
	PP	productive	closed class
	VP	productive	*

4.2.2 Doherty (1992, forthcoming)

Looking at the distribution described above in section 4.2.2, Doherty (1992, forthcoming) notes¹⁶ that all the predicates found with *Is* correspond to the class identified by Carlson (1977) as Individual level predicates, under at least one reading. Carlson claims that all predicates have readings of one of two types¹⁷. The first is the Individual level, which are permanent and stable properties of an individual. The other is Stage level, where the predicate identifies a temporary property of the individual or object in question. Kratzer (1988) extends this proposal by claiming that stage level predicates have a Davidsonian event argument (Davidson 1967) (here represented as L) which marks the predication in temporal and spatial location. Individual level predicates lack this property. Doherty (1992, forthcoming) claims that the distribution of *Is* and *Tá* is elegantly accounted for with this approach. Individual level predicates appear with *Is*, stage level ones appear

¹⁶Capturing the distinction first formally noted in Benveniste (1966) and more intuitively by traditional Irish grammarians. See also Stenson (1981).

¹⁷In fact, Carlson discusses a third type: that of *kind*. Only *individual* and *stage* are relevant here, however.

with *Tá*¹⁸. There is some empirical evidence in favour of such an approach. Consider the following English sentence:

31) John was a doctor.

Simplifying somewhat, this sentence is ambiguous between two readings. Under one reading (the individual level), being a doctor was a permanent property of John. The past tense here suggests that John is no longer alive. The other reading (the stage level), John's doctoring was a temporary thing. John is no longer a doctor, but he is still alive— perhaps he lost his license to practice. These two readings are represented in Kratzer's terms in (32):

- 32) a) PAST [doctor'(John)] Individual level
 b) (L)[PAST(L) & doctor'(John,L) Stage level

Now let's consider the equivalent Irish sentence using the morpheme *Is*:¹⁹

33) Ba dhochtúir é
C.past doctor him
 "he was a doctor"

Interestingly, this sentence can only have the reading in (32a), the individual level reading (i.e. permanent). The reading in (32b) is excluded. To get the reading in (32b), a different construction with verbal *Tá* and the morpheme *i* 'in'²⁰ must be used. This is seen in (34) where the phrase "but isn't licensed now" is used to force a stage level reading.

34) Bhí Seán ina dhochtúir (ach níl díolúine aige anois)
Be.past J in.his doctor (but be.not license at.3.s now)
 "John was a doctor (but he doesn't have a license now)
 can only have the reading of (32b)

The corresponding sentence with *Is* is ungrammatical:

¹⁸A similar distinction is frequently claimed to exist with Spanish *ser* and *estar* in the literature. See Schmitt (1992) for discussion. See also Rouveret (forthcoming) for a discussion of similar Welsh alternations.

¹⁹The suppletive forms of the various Irish morphemes may be confusing to the reader here. The present and past tense forms of these are seen in the following chart:

Present	Tá	Is
Past	Bhí	Ba ^L

See the appendix at the back of this thesis for fuller paradigms.

²⁰David Cram (1983) has analyzed the corresponding Scots Gaelic morpheme *ann* as the stative aspect particle, such an analysis could be used here.

- 35) *Ba dhochtúir é (ach níl díolúine aige anois)
“He was a doctor but now he doesn’t have a license”

Given this, then, there seems to be strong evidence in favor of Doherty’s proposals that the *Is/Tá* distinction is one of individual versus stage level. Unfortunately, this proposal does not stand up under closer scrutiny.

There are a large number of individual level predicates that not only show up with *Tá*, but cannot show up with *Is*. Consider, for example, the following two sentences.

- 36) a) Bhí sé cliste
be.past he clever
“He was clever”
b) Bíonn madraí ag amhastrach
be.habitual dogs prog bark
“Dogs bark”

(36a) is ambiguous between a stage-level and an individual level predicate, but the individual level reading is allowed with *Tá* (showing up here as *Bhí*). In fact, the corresponding sentence with *Is* is ungrammatical:

- 37) *Ba chliste é
C.past clever him
“He was clever (before he died)”

The sentence in (36b) on the other hand can only have an individual level reading, but still shows up with the verb *Tá*. (surfaces as *Bíonn*)

It thus follows then that, while it is true that all predicates found with *Is* are individual level predicates, it is not true that all individual level predicates are predicates found with *Is*.²¹ Since we are asking what the difference between an *Is* predicate and a *Tá* one is, we cannot reduce the solution to individual/stage level (contra Doherty 1992, forthcoming)²². There is no way to predict (with the exception of nouns) whether a

²¹See Schmitt (1992) for a similar argument about Spanish *ser* and *estar*. She claims that the distinction is not one of stage/individual level but rather is in terms of what elements can show aspect.

²²It is perhaps unfair to criticize Doherty (1992) in this regard since he never claims that individual level predicates are only found with *Is*. Rather, he only says that *Is* allows only individual level predicates as complements. However, the logical extension of this claim is the one examined and criticized above. The

predicate is found with *Is* or not based upon its reading as an individual or stage level predicate. The difference then must follow from another source. I claim that this difference is a lexical one, and follows from which inflectional features are found on the predicate head.

4.2.3 *Carnie (1993)*

In this section, I present an analysis of the difference between *Is* and *Tá*, based not on interpretive semantic criteria, but rather on a lexical and syntactic difference. This is the analysis which I presented in Carnie (1993) and the one that I will adopt here.

Let us first consider the basic structure of a sentence with an indefinite nominal predicate (marked with *Is*) in Irish. The word order is as follows:

38) *Is* + Predicate Nominal + subject

As mentioned above, this word order is reminiscent of the word order of simple tensed clauses:

39) Particle + Verbal Predicate + subject (+object)

Given that the word order in (39) is derived by head movement of the predicate to the highest inflectional position, let us assume that the word order in (38) is similarly derived²³ following a suggestion in Collberg (1990). A predicate raises to a functional category to check its features before SPELL OUT. This is consistent with the evidence that suggests *Is* is a tense particle (for a closely-related proposal for the Breton predicates, see Hendrick (1994, forthcoming); see also Stowell (1991) for related discussion). This type of derivation is abstractly sketched in (40)

revision of Doherty (1992): Doherty (forthcoming) argues that the fact that only individual level predicates are allowed in *Is* sentences follows from the claim that subjects in *Is* clauses appear in the specifier of IP. There are many problems with this claim (see chapter 8 of this thesis for more discussion), not the least of which is that I have argued in chapter 3 that all Irish subjects appear in the specifier of some inflectional phrase.

²³For the moment, I will ignore the issue of nominal predicates that are phrasal or otherwise complex. I will return to these in chapter 5.

40)

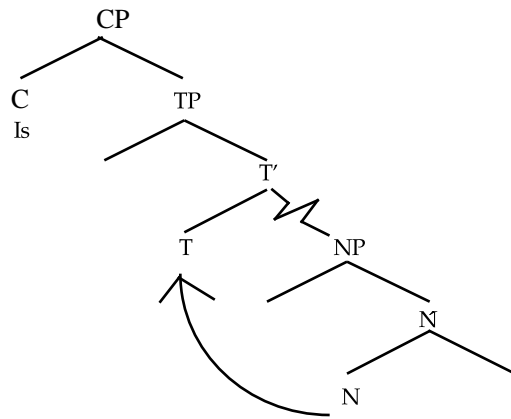

We must now ask ourselves why nominal predicates would be allowed to head-move in Irish, but not in English. The crucial difference between English and Irish, I claim, is that in Irish, nominal predicates are allowed to bear inflectional features (see Déchaine (1993) and Schmitt (1992) for related discussion). This contrasts with all English nominal predicates which require the support of some semantically null verb to bear the inflectional features. In Irish, the nominals are allowed to bear inflectional features directly (in a sense to be defined more formally in chapter 6). Given the fact that I claim the distinction between *Tá* and *Is* is one of feature marking, we might expect to find lexically-marked exceptions. This is the case in Irish. The exceptional adjectives and PPs²⁴ which are discussed above are examples of predicates that are lexically marked as being allowed to bear inflectional features.

We can ask ourselves if there is any evidence for the assertion that nominal predicates in Irish bear inflection^{25, 26}. First, we have the simple word order evidence. For

²⁴Again, I will deal with the head movement of phrasal categories in chapter 5.

²⁵This is presumably \emptyset Tense in the sense of Déchaine (1993). For more discussion on the inflectional behaviour of NPs, see Musan (forthcoming) and Endo (1994)

²⁶Crosslinguistic evidence for the claim that nominal predicates can bear inflectional features comes from the tense and agreement morphology that appears on Salish nominal predicates. Take, for example, the word meaning "you were a chief" :

si'em=IE=sx^w
noble=past=2sng.nom
"You were a chief"

See Jelinek and Demers (1994) for more discussion. See also Fassi Fehri (1993) for discussion of related Arabic facts.

both verbs and indefinite nominal predicates the word order is consistently a particle, a predicate and then the subject. Given that the clause initial position, immediately after the complementizer particle, is a position usually reserved for inflected verbs in Irish (as discussed in chapter 3) and this positioning is due to movement for a kind of inflectional feature checking, it follows that the appearance of nominal predicates in this position may well be due to the fact that they must check inflectional features in the inflectional complex.

Similar evidence comes from small clauses. Under the assumption that small clauses do not have a tense projection, nominal predicates should not be allowed with them. In Irish, the complementizer *Agus* 'while/since/and' introduces small clauses.

- 41) *Agus [é i gCalafóirnia]...*
 And him in California
 "And he is/was in California"

In keeping with the above prediction, nominal predicates are not allowed with *Agus*.

- 42) **agus [é dlíodóir]*
 and him lawyer
 "and he is/was a lawyer"

This is consistent then with the notion that nominal predicates in Irish bear inflectional features. Since small clauses have no inflectional complex, the inflectional features on the nominal predicates have nothing to check against. This accounts for the ungrammaticality of (42).

To summarize, then, *Tá*²⁷ is found with predicates that can't bear inflectional features. It is a real verb which supports such features. In contrast, in the *Is* constructions, the predicate nominal²⁸ itself bears the inflectional features and undergoes head movement so there is no need for a dummy auxiliary verb for inflectional support.

²⁷I have not given here an analysis of the verb *tá* and its behaviour. This is more for reasons of time and space than for lack of analysis. Briefly, *Tá*, after Hoekstra and Mulder (1990), is a real unaccusative verb which takes a small clause complement (Stowell 1983, 1991, Heggie 1988, cf. in contrast Williams 1983) Like any other verb, *Tá* raises through the inflectional complex to check its – features. This derives the correct word order for clauses using the *tá* construction.

²⁸See however, chapter 5 for a discussion of equative constructions.

4.3 Why the apparent stage/individual level split?

We have now established that the distinction between *Is* and *Tá* constructions is not one based on the semantic stage/individual level distinction, but rather is based upon what elements can bear inflectional features and undergo raising in the syntax. One problem remains before us, however, that being Doherty's initial observation that all predicates found with *Is* are individual level. How can we account for this? I suggest that this follows straightforwardly from how stage level predicates are to be represented in the syntax. I claim, in a view of the stage/individual level distinction very different from that in Diesing (1992), that Davidsonian event arguments are introduced by light verbs. Event arguments distinguish stage from individual level predicates. If event arguments are linked to the presence of a light verb, their absence in *Is* constructions which lack any verbs light or otherwise, is unsurprising. Let us see how this works

Recall from above the distribution of interpretations with the two constructions. *Is* only allows individual level predicates. *Tá* allows both:

- 43) a) *Is dochtúir Cathal*
 C doctor Cathal
 "Cathal is a doctor" (individual level)
- b) *Tá Cathal ina shuí*
 Be Cathal in.his sitting
 "Cathal is sitting" (stage)
- c) *Tá Cathal {cliste, mór, ard}*
 Be Cathal clever,big, tall
 "Cathal is {clever/big/tall}" (all individual level)

This is summarized in (44)

44)

	Is	Tá
stage level	*	✓
individual level	✓	✓

What we can note about this distribution is that stage level readings are only allowed with a true verbal auxiliary. I claim that there is a direct causal relationship here: the stage level

reading is directly correlated to the presence of the auxiliary verb. The lack of a light verb in *Is* constructions will account for the lack of stage level readings in these constructions.

Let us adopt Kratzer's (1988) claim that stage level predicates differ from individual predicates in possessing an event argument²⁹ which delimits the property being attributed in time and space. Further, let us adopt the claim, of Déchaine (1993) and Noonan (1993), that all arguments are introduced by their own verbal head (see also Larson (1988) and the authors listed in chapter 3 who propose the split VP hypothesis). Following Harley (forthcoming), let us extend this to event arguments as well³⁰.

The structures that would be produced by a predicate which takes *Is* (bears inflectional features directly) and by one that requires verbal support from *Tá* are seen (45) (omitting all irrelevant details) :

45)

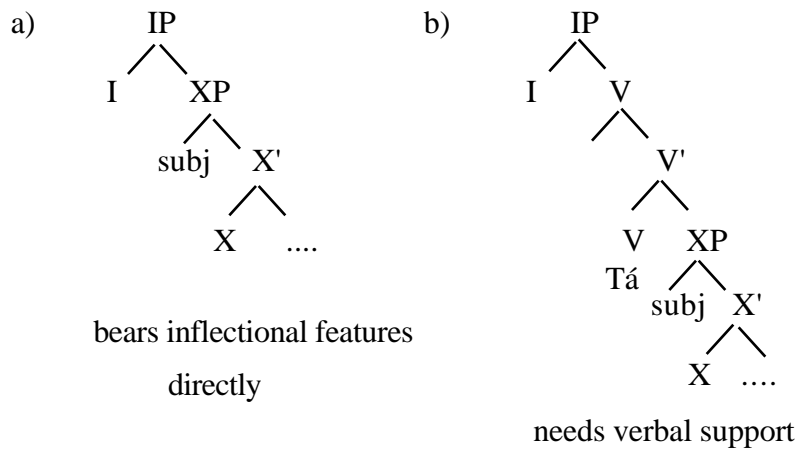

If event arguments can only be introduced via a light verb³¹, it follows that event arguments can only appear in sentences that have light verbs. *Is* sentences never have light verbs,

²⁹Kratzer actually does not claim that this is an "event" argument *per se*, but rather that this is simply a spatiotemporal argument. There seems to me to be no significant difference between the two so I will use the stronger "event" terminology here.

³⁰I will remain agnostic here about whether this event argument is in some way linked to external arguments in general or to aspect. See Harley (forthcoming) and Schmitt (1992) for more discussion.

³¹An obvious problem with this kind of account is the fact that stage level predicates can appear in small clauses, where there is no light verb. Alec Marantz points out to me that the stage-levelness of a small clause predicate seems to be determined by the eventhood of the predicate which dominates it. For example,

therefore they never can have event variables, and thus never have a stage level interpretation. *Is* predicates simply have no place to generate an event argument. The simplified structures for the *Is* construction and the two interpretations of *Tá* are summarized in (46):

- 46) a) [_{CP} *Is* [_{IP} X_i [_{XP} subj [_{X'} t_i ...]]]] *Is* construction no event argument) b) [_{IP} T_á_i [_{VP} [_{V'} t_i [_{XP} subj [_{X'} X ...]]]]]] *Tá*, individual level, no event
 c) [_{IP} T_á_i [_{VP} L [_{V'} t_i [_{XP} subj [_{X'} X ...]]]]]] *Tá*, stage level, event argument introduced by *Tá*

The light verb may or may not introduce the event argument, this is presumably a feature of the predicate which it selects.

This account of the stage/individual correlations explains both why stage level predicates are never found with *Is* and why *Tá* allows both interpretations. Stage level delimiting events are only found with light verbs. In the system described above in section 4.2, the light verb *Tá* is only found when the non-verbal predicate cannot bear inflectional features itself. It is not surprising, then, that stage level interpretations are only found with these predicates.

4.4 Conclusion

In this chapter, I've provided an account of two phenomena associated with non-verbal predication in Modern Irish. First, I showed that the *Is* morpheme and its allomorphs are not verbs, but pattern like the preverbal complementizer particles. I then claimed that the difference between the *Tá* and *Is* construction lies not in the semantic notions of Carlson's (1977) Stage/Individual level distinction, but rather follows from what elements can undergo head movement for feature checking. Those predicates that cannot bear inflectional features require the verbal auxiliary for support of those features. Those

eventive *see* and *make* matrix predicates take stage level small clauses, stative *consider* takes individual level small clause predicates. It thus seems that small clauses may inherit event arguments from the matrix clause they are contained in, and require no light verb.

that can bear inflectional features appear with the *Is* particles and themselves undergo head movement through the inflectional complex for feature checking. Finally, I showed that apparent correlations between *Is* and *Tá* and the individual/stage level distinction was an artifact of the fact that event arguments can only be introduced in the specifier of light verbs like *Tá*.

There are several issues left unresolved in this chapter. First, and most importantly, I have provided no account of the word order facts of the equative construction. I have also provided no account or description of the case and agreement properties of *Is* constructions. In the next chapter we will turn to these issues. In addition, I have yet to discuss the behavior of complex phrasal predicates. This will be the focus of chapter 6.

Chapter Five Accounting for the *Is* word order alternations*

5.0. Introduction: the three *Is* orders

In this chapter, I examine the different word orders found with *Is* constructions in Modern Irish. These orderings are seen in the following sentences. In the following sentences the notional **subject** is indicated in **bold**. The *property* being assigned to that subject is indicated in *italics* (see Stenson (1981) and Ó Siadhail (1989) for descriptions of these orders)

- 1) a) *Is dochtúir (í) Beverly Crusher*
C doctor (her)
'Beverly Crusher is a doctor'

- b) *Is é Jean Luc Picard an captaen*
C him the captain
'Jean Luc Picard is the captain'

- c) *Is é an dochtúir é*
Cop him the doctor him
'he is the doctor'

- d) *Is Klingean é*
C Klingon him
'He is a Klingon'

*Many of the ideas in this chapter have been the result of a great deal of discussion and analysis with Heidi Harley. To her, I owe a special debt of thanks for this chapter.

At first glance, there appears to be almost random ordering of the notional subject and the property being attributed to it. In sentences (1a) and (1d), which are predicative *Is* constructions (discussed above in chapter 4), we have the notional predicate preceding the notional subject. When the subject is a full NP it can optionally¹ be preceded by a pronominal which agrees with the subject as in (1a). In (1b), we have an equative *Is* construction with a full NP subject, with this construction we have the subject, preceded by the agreeing pronominal (obligatory here), which in turn precedes the predicate. Finally in (1c), we have an equative with a pronominal subject. In this, the subject is separated from the agreeing pronominal by the predicate. As seen in (1d) the subjects of both predicative and equative *Is* constructions are in the accusative case. These facts all need resolution.

In this chapter, I claim that the differences between the predicative and equative word orders follows from a complex interaction of argument structure, the head-movement of indefinite nominal predicates discussed above in chapter 4, and a rule of rightward movement motivated elsewhere in the grammar of Irish.

I claim that the difference between the two types of sentences (equatives and predicatives) follows from the type of the predicate involved. I claim that the indefinite nominals are all true one place predicates. They take a single argument, and since they can bear inflectional features, as discussed in chapter 4, they raise though the inflectional complex to the highest inflectional node, just like the tense verbs. In the equative cases where the attributed property seems to be a definite NP on the other hand, I claim that this NP is not a predicate at all (see chapter 7 for a discussion of alternative views of equatives). Rather, I claim it is an argument of a null two place predicate 'COP'. Since the definite NP is not a predicate, it will not undergo head-raising and will surface in its case position. In these cases, the null predicate is the element which undergoes head-raising. I correlate the

¹There seems to be a fair amount of dialect variation over the presence of this optional pronoun. It seems to be mostly localized in the Conamara dialect.

presence of the extra pronoun with presence of agreement features on the null copula. The order shown in (1c) follows from the rule of pronoun postposing. Finally, I claim that the so-called accusative case seen on the subjects is not true morphological or abstract case marking but is a reflex of lack of adjacency to a tensed verb.

This analysis of different kinds of copular constructions flies in the face of much recent work on copular constructions, which presents a so-called "unified account" of copular constructions, as in Heggie (1988), Moro (1991, 1993) and Heycock (1991, 1992). In these works, it is argued that there is only one structure for both equative and predicative uses of the copula. I will not be arguing against this approach in this chapter, saving such arguments for chapter 7. Instead, in this chapter I will present a modified version of the older analysis of copular constructions which uses two different copular constructions. In passing the reader will note that this older style "non-unified" account provides a more than adequate analysis of the different syntactic types of copular clauses in Irish.

This chapter will be organized as follows. The first six sections of this chapter are devoted to deriving the correct word order facts of Irish copular constructions. The last two deal with problems that Doherty (1992, forthcoming) has offered as evidence in favor of an alternative analysis of these facts. First, I discuss my version of the hypothesis that there are two different constructions for copular constructions, with different theta properites. I then extend this analysis to the facts of Irish word order. Later, in section 5.5, I show how the third word order is derivable from the equative construction by a simple and otherwise motivated rule of light pronoun postposing. In sections 5.3 and 5.4, I explain the presence and distribution of the agreement morpheme and discuss the status of accusative case on the subject. Finally, in the last two sections, I turn to some facts discussed in Doherty (forthcoming): those of reciprocal binding and the apparent exceptions to the *Highest*

Subject Restriction of McCloskey (1990). At first these may seem problematic for the approach presented here. I show, however, that these problems are easily resolved within my framework.

5.1 Two Types of Nominal Predicates

Consider the following facts about the reversability of elements in sentences where a nominal property is being attributed to another noun. In English definite properties and notional subjects are usually reversible in position:

- 2) a) The ensign (who fired the phasers) is the doctor
b) The doctor is the ensign (who fired the phasers).

When the attributed property is indefinite however, this is not true, the property must follow the verb to be:

- 3) a) The ensign is a doctor
b) *A doctor is the ensign

The standard account of such alternations (e.g. Akmajian 1970, Rothstein 1987, Higgins 1973², Vinet 1993, Zaring 1994 and Rapoport 1987) holds that this contrast follows from the types of predicates found in these sentences. According to this set of analyses, there are two different base-generated structures for the sentences in (2) and (3). Sentence (2) is an *equative* sentence where both the NPs are arguments. Sentence (3), on the other hand is a *predicative*; the first NP is an argument, the second is a predicate. Rapoport (1987) summarizes the difference as follows³:

4)	<u>Type</u>	<u>Pre-copular NP</u>	<u>Post-copular NP</u>
	Equative	argument	argument
	Predicative	argument	predicate

²Instead of the two types of copular clauses posited here, Higgins (1973) actually claims there are four types: specificational, identity, identificational and predicational. Rapoport (1987) quite effectively shows that these types can really be collapsed into the two types discussed here; see that work for more discussion.

³For a discussion of what it means to be a predicate or an argument see Williams (1994, 1995), see also Napoli (1987)

I propose, modifying slightly proposals of Rapoport (1987) and Rothstein (1987), that equatives are small clauses headed by an abstract two place COP predicate⁴. This COP predicate assigns two theta roles to its two arguments:

5)

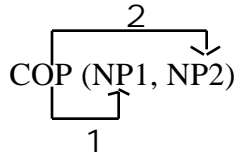

For the purpose of this work I will assume that the theta role assigned to the internal argument is the 'attribute' (2), whereas that assigned to the external argument (1) is the 'attribute recipient', (AR) for short. The evidence for having two different theta roles for the two different arguments follows from the fact that the two sentences in (2) are not exactly equivalent in meaning. See also the discussion in chapter 7, where I discuss certain structural asymmetries between the two NPs.

Let us now consider the predicative structures, which have indefinite⁵ attributed properties. I treat these, following Rapoport (1987), as one place predicates. In these, the attributed property functions directly as the predicate on a single Attribute Recipient argument:

6)

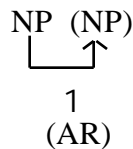

⁴There are three differences between this and Rapoport's proposal . First, Rapoport posits that her "=" predicate is base generated in INFL. In an attempt to provide a parallel between equatives and predicatives and to provide an account of its theta properties, I have placed COP as the head of the small clause that contains its arguments. Second, Rapoport's analysis has a true equative nature— both NPs are equivalents with no differences between them. Finally, with respect to predicatives (see below and chapter 4), I believe that the small clause always surfaces with an inflectional complex, thus accounting for the apparent head-movement of the predicate to initial position. Rapoport suggests that small clauses in Hebrew can surface without inflectional complexes. Note as well that COP is not isomorphic to Heggie's , which is found in both equative and predicative constructions (cf. chapter 7 below).

⁵I use the terms "indefinite" and "definite" only as mnemonics here. As Doherty (1995) shows the relevant distinction in Irish is probably one of referentiality rather than definiteness; see Doherty for more discussion.

Since the attributed nominal property is not an argument, it cannot fill the subject argument slot, thus accounting for the ungrammaticality⁶ of (3b) (repeated here as (7b)):

- 7) a) The ensign is a doctor
b) *A doctor is the ensign

This analysis is consistent with the semantics of these two types of properties as well. Indefinites, in general, are not referring expressions (following Higginbotham 1989); thus they can function predicatively. Definite NPs, on the other hand, are referring expressions. They have a reference and their argument structure is saturated and complete. Because of this, they are inherently arguments, thus participate in the equative construction, rather than the predicative one.

We thus have two different types of attributed nominal properties. One where the property behaves directly like a predicate, and one where the property is an argument and is linked to the AR by the abstract predicate COP.

As noted above, a series of recent analyses (Heggie 1988, Moro 1991, 1993, Heycock 1991, 1992) have all argued that the equative construction is really simply a sub-kind of predicative clause, with specific kinds of interpretive properties. Under these accounts, the reversability of the NPs seen in (2&3) follows from other facts (like subadjacency). For reasons that will become obvious below from the word order facts of Irish copular clauses⁷ and from the discussion in chapter 7, I will not adopt this approach here.

5.2 The Predicative and Equative Constructions in Irish.

⁶Again an alternative analyses of these facts are found in Heggie (1988), Moro (1991) and Heycock (1991) See also chapter 7 of this thesis for more discussion.

⁷To clarify, Irish has word order alternations as seen below in 5.2 that can only be accounted for if there is a clear syntactic difference between equatives and predicatives.

In this section, I sketch out the analysis of the various Irish copular word order facts first presented in Carnie (1994) and Carnie and Harley (1994a&b). I show that these two types of nominal predicate constructions discussed above provide a straightforward account of the word order alternations in Modern Irish copular clauses. I claim that in the cases where an indefinite NP is functioning as a predicate it raises past the subject to adjoin to the highest inflectional head. With definite attributes, on the other hand, it is the abstract COP predicate which undergoes the raising (contra Carnie 1993). The attribute NP argument is thus left behind and is found to the right of the subject.

Let us see how the differences in predicate types derive the differences in word order. Let us first consider an example with an indefinite predicate (a predicative construction) and a subject of any sort:

- 8) PREDICATE SUBJECT
 Is *Clingeán* {**é/an dalta/Worf**}
 C Klingon him/the ensign/Worf
 '{He/The ensign/Worf }is a Klingon'

In this case the attributive NP appears to the left of the subject. This is follows if the predicate NP (*Clingeán*) has undergone head-movement to the highest inflectional category, around the surface subject position (just like in normal VSO sentences). This is the analysis sketched in chapter 4:

9)

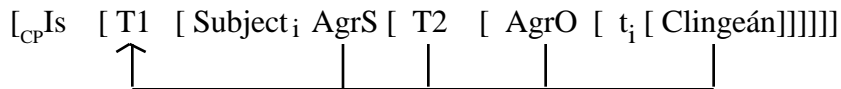

For definite attribute NPs, on the other hand, it is the abstract predicate COP which does the movement, thus leaving the attribute NP to the right of the subject:

- 10) SUBJECT ATTRIBUTE
 Is é {**Worf/an dalta**} *an Clingeán*
 C agr Worf/the ensign the Klingon
 'Worf/the ensign is the Klingon'

11)

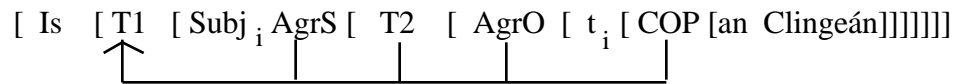

The evidence for this analysis comes from the relative placement of agreement morphology in the two kinds of copular clause. In sentences with verbal predicates, we consistently have the order where agreement morphology⁸ precedes the subject NP:

- 12) Rith+eann Cathal
 run+3s Charles
 "Charles runs"

Let us make the null assumption, then, that the order in (13) always obtains in Irish, and that the presence of agreement morphology before a noun in Irish is a clear diagnostic for the subjecthood of that noun. We can also claim that the position preceding agreement morphology (immediately following any particle) is the position reserved for predicates

- 13) Particle + Predicate+Agreement + Subject

In equative clauses the agreement morphology (see section 5.4 below for more discussion on the distribution of agreement morphology) precedes both the subject and the object NP

- 14) AGR SUBJ ATTRIBUTE
 Is é Seán an platapas
 C agr John the platypus
 "John is the platypus"

This is also true if you reverse the two NPs:

- 15) Is é an platapas Seán
 C agr the platypus John
 "The platypus is John."

⁸This is a bit of an oversimplification since overt agreement morphology is generally disallowed with overt nominals (with the exception of third person default agreement. For more discussion see McCloskey and Hale (1984)

In predicatives, on the other hand, the agreement morpheme when present⁹ appears between the predicate and the subject NP

- 16) ATTRIBUTE AGR SUBJECT
 Is platapas é Seán
 C platypus agr John
 "John is a platypus"

As predicted by the discussion above, the reverse of this sentence is ungrammatical (under the appropriate reading where John is a referring expression and not a label or role in a play):

- 17) *Is Seán é platapas
 C John agr platypus
 "**A platypus is John"

Taking a preceding agreement morpheme to be a diagnostic for the subjecthood of a following NP and assuming that the position preceding agreement is reserved for predicates, we see that in equatives, no NP is in the predicate position (between the particle and agreement heads), and both NPs (AR and attribute) are in argument positions. In contrast, in predicatives, the predicate NP appears between the particle and the agreement head (and has thus undergone head-movement). The subject follows the agreement morpheme. These facts are summarized in the chart in (18)

18)

	particle	predicate	agreement	subject	other
verb	Ní <i>neg</i>	rith <i>run</i>	+eann <i>+3s</i>	Seán <i>John</i>	
predicative	Is <i>C</i>	platapas <i>Platypus</i>	(é) <i>3s</i>	Seán <i>John</i>	
equative	Is <i>C</i>	∅ <i>COP</i>	é <i>3s</i>	Seán <i>John</i>	an platapas <i>the platypus</i>

By adopting the distinction between predicative and equative sentences, we have a straightforward account of the placement of this agreement morpheme. In the predicative construction, the predicate NP raises to the highest inflectional position, thus landing between agreement and the particle, in a manner exactly parallel to verbs. With equatives,

⁹Again, the appearance of the agreement morphology is dialect dependent.

on the other hand, both NPs are arguments. Thus neither of them raise to predicate position.

With this in mind, let us flesh out the proposal by discussing exactly what movement, both A-movement and head-movement, occurs in copular constructions. In doing so, I must still explain why the subject of copular clauses appears to take accusative case, explain the word order in (1c), and explain why the agreement morpheme is obligatory in equative constructions, but is optional in predicatives. These questions will be the focus of the next few sections.

5.3 Case

Let us now consider the status of case in these different kinds of nominal clauses. In Irish, the subjects of nominal clauses show up, surprisingly, with what appears to be accusative case:

- 19) Is dochtúir é (cf. *Is dochtúir sé (nom))
 C doctor him.acc
 He is a doctor.

This is a very puzzling feature of Irish nominal clauses. Why should the subject show up with accusative case? I claim that surface phonology to the contrary, these NPs are not, in fact showing up with accusative case (for an alternative view see Carnie 1993). Overt phonological case marking in Modern Irish is only seen on third person pronouns. For all other NPs, there is no morphological case difference between nominative and accusative case. Nominative case pronouns are simply the accusative forms preceded by an <s> (/S/):

- 20) sé 'he' é 'him'
 sí 'she' í 'her'
 siad 'they' iad 'them'

Ken Hale (p.c.) has pointed out to me that this marking is not necessarily a reflex of syntactic case. He points out that the <s> forms are never found anywhere except to the

immediate right of a tensed verb (a fact also noted in Christian Bros (1960) and McCloskey and Hale (1984)). For example, in coordinate NP subjects, a pronominal subject does not show up with <s>, even though it is in a nominative case position:

- 21) Chuir Luacsana Troí agus éisean an ríomhaire sa réaltlong
 Put.past and him.emph the computer in.the starship
 'He and Lwaxana Troi put the computer in the starship'

He claims, then, that the <s> forms are only a feature of the basic 'é/í/iad' set being cliticized to the right of a tense verb:

- 22) Chuir sé an ríomhaire sa réaltlong
 Chuir+s+é
 Put.past he the computer in.the starship
 He put the computer in the startship

Recall also, from our discussion in chapter 2, that Chung and McCloskey (1987) note that there is a strong adjacency requirement between s-grade pronouns and verbs; no adverbial material may intervene between the verb and these pronouns:

- 23) a) Fuair, cinnte, Taisia Eár bás
 Got, certainly, Tasha Yar death
 "Tasha Yar, certianly, died"
 b) *Fuair, cinnte, sí bás
 Got, certainly, she death
 "*She, certianly, died"

No such constraint holds on the *é/í/iad* class of pronouns. This supports the idea that the so-called "nominative" pronouns are not a real morphological realization of nominative case. Rather, they simply show a phonological marking¹⁰ of their clitic status to the verb. Pronouns in Irish, then, do not really show an overt morphological realization of their structural case, paralleling its close neighbour Scots Gaelic in this regard¹¹.

If this account is accurate then the case marking on the subjects of copular clauses is not puzzling at all. Nominative case is assigned to the subjects (AR) of copular clauses, just

¹⁰See Ahlqvist (1976) for some speculation on the origins of this marker.

¹¹Interestingly, according to Ahlqvist (1976) the emergence of the s-grade of pronouns, and the cliticization of them did not become fully productive until the Early Modern Irish period, about the time that Irish and Scots Gaelic diverged.

as in normal verbal clauses, in the specifier of AgrSP. The lack of the <s> is attributable to the fact that these pronouns are not adjacent to a tensed verb, but to an inflected noun (or abstract COP). The movement of elements, and their case is thus in (24) and (25). :

24)

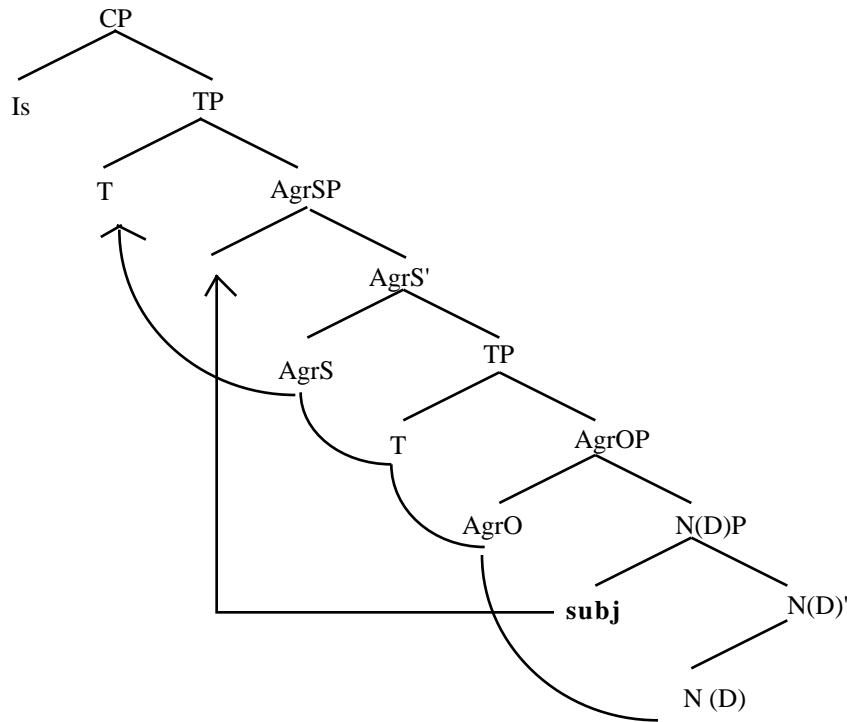

(24) represents a predicative construction where the attribute recipient role is directly predicated of the indefinite NP. The nominal predicate raises through the inflectional heads checking its inflectional features. The subject pronoun raises to the specifier of AgrSP to check its nominative case. The equative construction, on the other hand is represented in (25).

25)

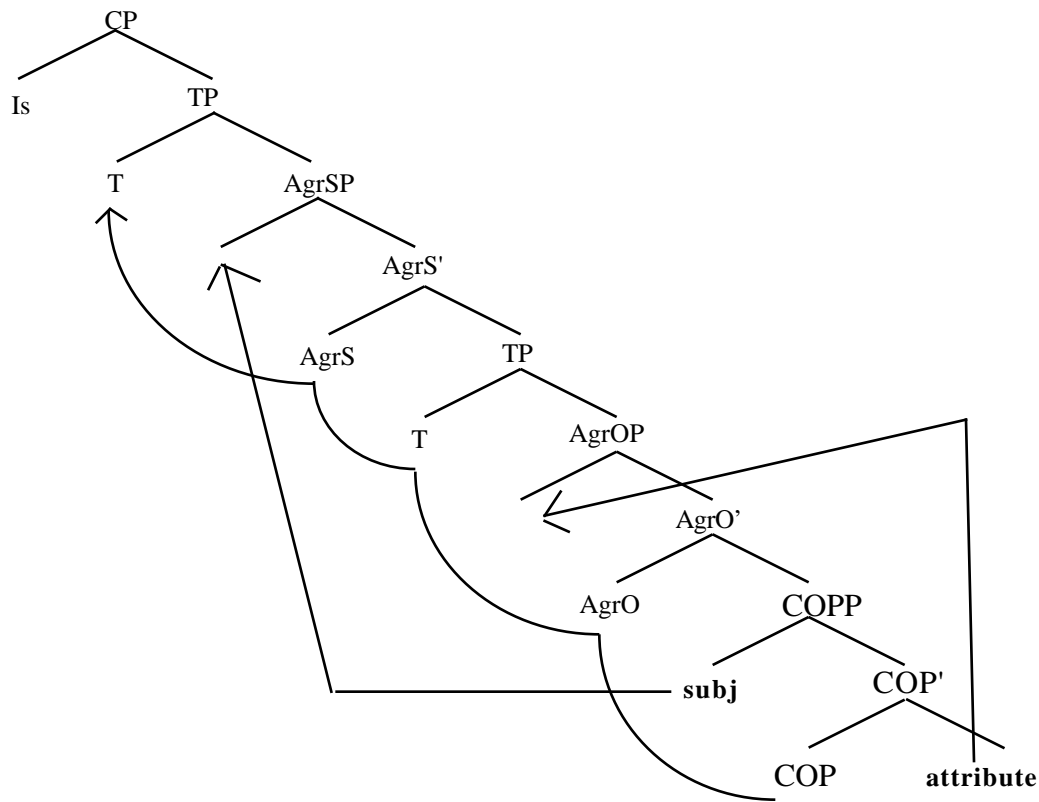

In this structure, the COP predicate bears inflectional features which it checks by head moving through the functional heads to the highest position. The arguments move to their case positions, in a manner parallel to normal VSO order.

Given these two different predicate types then, and the assumption that the <s> forms of the pronouns do *not* reflect syntactic accusative case, I have a nice account of the different word orders of the definite and indefinite attributes. They are due to different head-movement and case properties resulting from their different argument structures; in a manner strikingly similar to the derivation of words with verbal predicates.

5.4 The Agreement Morpheme

In this section, I discuss the distribution of the agreement morpheme¹². Consider the structure in (26), an equative; an agreement morpheme¹³ is obligatorily found between the *Is* proclitic and the third person subject NP. This agreement morpheme takes the form of a third person pronoun.:

- 26) a) *Is* + pronoun_i + subject_j + attribute
b) *Is é Ceannasaí Radhcár an t-amadán*
C agr Commander Riker the fool
'Commander Riker is the fool'

In sentences with indefinite predicates (predicatives), this agreement pronoun may optionally appear between the predicate and a full NP subject:

- 27) a) *Is ríomhaire é leifteanantcheannasaí Data*
C computer agr Lieutenant-Commander Data
'Lieutenant Commander Data is a computer'¹⁴
b) *Is ríomhaire leifteanantcheannasaí Data*
C computer Lieutenant-Commander Data
'Lieutenant Commander Data is a computer'

The presence of the extra pronoun is very puzzling. We must account for the facts of its co-occurrence with various types of predicates and subjects—as well as accounting for the fact that it appears at all.

Interestingly, such pronouns show up in other languages that don't use a verbal copula. For example, in Hebrew an agreeing pronoun is required in equative sentences (Rapoport 1987:65):

- 28) *Ha-melex hu david*
the-king 3.sing.masc David
'David is the King/The king is David'Hebrew

¹²For an alternative view of this morpheme see Doherty (1995) who views it as an "unsaturator" rather than an agreement morpheme. I do not adopt his analysis here, because he is forced to claim that in sentences like "John is the doctor", "John" functions like the predicate, contra the predicate hierarchy found in Heggie (1988).

¹³The Gaoth Dobhair dialect of Co. Donegal differs from other dialects in its use of agreement pronouns; ; see Ó Siadhail (1983) for a discussion of equatives in this dialect.

¹⁴For the information of readers who may not be familiar with the television show *Star Trek* (which provides the bulk of topics for my examples), Lt. Cmdr Data is a robot.

but not in predicatives:

- 29) Dani more
 Dani teacher
 'Dani is a teacher'

Similarly a demonstrative 'eto' is obligatory in Russian equatives, but not in predicatives

(Data from Rapoport 1987):

- 30) Ivan eto tot samyj čelovek (*Ivan tot samyj čelovek)
 this-n this-m very-m man-m
 'Ivan is this very man'
- 31) Ivan student
 'Ivan is a student'

What we have here then is a cross-linguistic property of languages with non-verbal copular constructions. Why should this be the case?

After Doron (1986), I suggest that this morpheme is the phonological realization of the agreement features on the COP head. It is obligatorily present when the predicate is the abstract (null) predicate COP. Following the analysis found in Rapoport (1987) it surfaces in order to indicate (or identify) the presence of this null predicate¹⁵. When we have an indefinite predicate, however, the presence of the morpheme is not required to indicate the presence of a predicate, since that predicate is overt. Thus the agreement morpheme is optional in these cases.

One piece of evidence in favour of this approach lies in the morphological shape of the pronoun. This pronoun agrees in number and gender with the subject NP. This is seen in (32) below, where the pronoun agrees in grammatical gender with the subject NP.

- 32)a) Is í an leabharlann an teach mór
C agr.fem the library.fem the house.masc big
 The library is the big house
- b) Is é an teach mór an leabharlann
C agr.masc the house.masc big the library.fem

¹⁵Heggie (1988, 1990) and DeGraff (1992) provide alternative accounts of the appearance of these morphemes using the ECP as a motivator. See chapter 8 below for discussion.

The big house is the library

In (32a) the pronoun agrees in gender with the feminine word for 'library'; in (32b) it agrees with the masculine word for 'big house'. Since the pronoun agrees with the subject, it follows that it is simply the reflex of subject agreement features showing up on the abstract COP morpheme.

If agreement morphology is simply a realization of the abstract agreement features on the null COP head, why it is allowed to show up in predicatives, which lack such a head? A related question is why is it optional in predicatives. I have no definite answers to these questions, but will offer some brief speculation. My answer to the first question is the startlingly obvious one: predicative NPs bear agreement morphology, which can surface as this agreement morpheme¹⁶. The answer to the question of its optionality is more difficult. I suggest that it may well have to do with the morphological fact that nominals do not normally show overt agreement morphology. When the morphology is presented with a verb that bears agreement features it maps this onto a verb plus verbal agreement suffix:

33)



The situation with nominal predicates in Irish, however, is different. Nouns in Irish do not take agreement morphology, there are no agreement suffixes for nominals. Thus when morphology is presented with a syntactic head like that in (33), it has a problem!

¹⁶For a discussion of why this surfaces as a separate morpheme rather than as an agreement suffix, see the discussion of syntax-morphology mapping in chapter 6.

34)

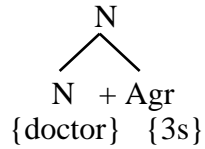

When presented with such a structure, the morphology is faced with a dilemma. It would like to create a nominal head with a third person agreement suffix. Such suffixes are not present in the lexicon for nouns and (adopting the terminology of Noyer 1992), Irish nouns have no position of exponence (or slot) for agreement suffixes. When put in this position, the morphology has two choices, it can either realize the agreement as a separate agreement morpheme (taking the form of a third person pronoun) or, alternately, it can delete (or ignore) those features, thus resulting in the construction without the agreement pronoun. This, at least tentatively, accounts for the optionality of the pronoun in predicatives. I will articulate this view of morphology in more detail in chapter 6.

A related problem lies in the fact that the agreement pronoun cannot surface when the subject is a pronoun in predicative constructions:

- 35) *Is dochtúir é é
 C doctor agr he.
 "He is a doctor"

Rapoport (1987) notes similar facts in Hebrew:

- 36) hu *hu student(cf. Dani hu student)
 He agr student
 "he is a student"

Note that in neither language is this attributable to a ban on adjacent pronouns, since adjacent pronouns are in fact found in other constructions.

- 37) a) dá mba mise túsa
 if C.irrl I.emph you.eph
 "If I were you"
- b) An seanbhuachaill ab é é¹⁷

¹⁷This sentence is an example of a cleft of the attribute NP in an equative construction. Unfortunately for

but *to its right*. The Agr morpheme is showing up not adjacent to the subject, but next to the predicate. Further this Agr morpheme is showing up with a pronominal subject. This would appear to be direct counter-evidence to the proposal I've presented above.

I claim, however, that this sentence is directly predictable given the behaviour of other pronouns in the language. Chung and McCloskey (1987) point out that there is a rule of Irish grammar, whereby pronouns of the *é/í/iad* grade postpose around obliques and adverbials to the end of the sentence. Consider the following paradigm where the object NP and pronouns are bolded:

- 40)a) Scaoil an Captaen **na féasair** ar na Clingeánaí
Fired the Captain the phasers on the Klingons
'The Captain fired the phasers at the Klingons'
- b)??Scaoil an Captaen **iad** ar na Clingeánaí
Fired the Captain them on the Klingons
'The Captain fired them at the Klingons'
- c) Scaoil an Captaen ar na Clingeánaí **iad**
Fired the Captain on the Klingons them
'The Captain fired them at the Klingons'

There thus seems to be a rule of pronoun post-posing in Irish. We can formulate this in rule in (41)

- 41) Move a *é/í/iad*-grade pronoun to the end of its clause.

I refer the reader to Ó Siadhail (1989) and Duffield (1994)¹⁸ for more discussion of this phenomenon.

Given this rule then it is not surprising that the pronominal subject of a COP predicate postposes around the attribute to final position:

¹⁸Duffield (1994) proposes that the positioning of this pronoun follows not from rightward shift of a light pronoun, but from raising the pronoun leftwards to a "wackernaglian" second position head, and subsequent topicalization of all other clausal material to the left of that pronoun in a manner similar to V2. This approach is equally consistent with the facts of Irish copular constructions presented here to the simpler postposing analysis presented in the text.

42)

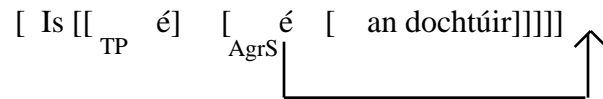

This, then, gives us the final word order of Irish. A complete summary of all the word order types and their derivation will be given in 5.8.

5.6 Reciprocal Binding

Doherty (1992) presents some evidence that, at first glance, seems problematic for the approach outlined here. In Irish, like English, the subject of nominal predicate can bind a reciprocal within that predicate:

- 43) a) [John and Mary]_i are each other_i's bosses
 b) Is cosúil lena chéile iad
C like with-3-pl-poss each-other them
 “They are like one another” (From Doherty 1992)

On the bases of this data he argues that the subject of a nominal predicate in Irish must c-command (and thus be higher) than the predicate into which it binds. He proposes the following structure¹⁹:

44)

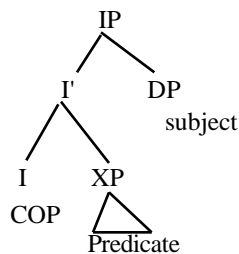

These facts appear problematic for the approach outlined in this paper, since the subject NP is c-commanded by the predicate²⁰ head. The exact reverse of what the data predicts.

¹⁹ I am not going to argue against such a structure here, as the model which Doherty presents is based upon fundamentally different assumptions about case assignment, functional categories, and head movement than the one here. See chapter 8 for further discussion of Doherty's model.

²⁰The predicate in this construction is phrasal, thus it may appear strange to claim it is in a head position. This issue will be dealt with in the next chapter.

45)

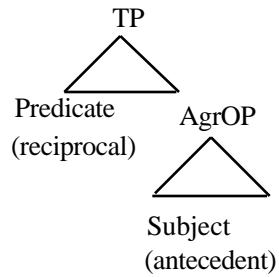

The situation is not as dire as it first appears, however, considering recent proposals about the theories of movement and reconstruction. Huang (1993) claims that, for *wh*-moved constituents at least, VPs (and by extension all predicate phrases) are subject to reconstruction. I propose that we extend this notion to predicates which have undergone head movement²¹. This extension follows naturally from the copy theory of movement found in Chomsky (1993). Under the copy theory, elements are not “moved” *per se*. Rather a copy of the constituent is adjoined at the “moved to” position. Traces under this theory are not just placemarkers, but are structurally complete — but phonologically null — copies of the moved element. Under this conception of movement, the usual *c*-command requirement on reciprocal binding is met even when a predicate has undergone head movement. Consider the following abstract tree. The phonologically null elements (“traces”) are represented as boxed in and shaded:

46)

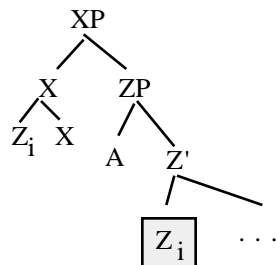

²¹Noting that Williams (1980) suggests that subjects must *c*-command their predicates, we might speculate that the cause of this reconstruction is the requirement that subjects *c*-command their predicates at LF; this is true for both verbal and non-verbal predicates.

In this configuration, the head **A** c-commands one part of the chain of **Zs**. Let us assume that for the theory of binding of reciprocals the following condition must be met.

- 47) Reciprocal Binding Condition:
 The antecedent of reciprocal R must c-command some segment of the chain containing R at LF.

This simple condition nicely accounts for the facts given in (43). The complex head containing the reciprocal has a phonologically null, but structurally complete trace below the surface subject position:

48)

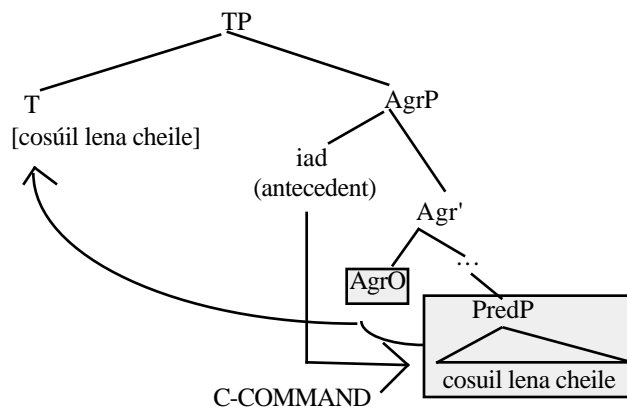

This trace is c-commanded by the antecedent head at LF, thus the condition on reciprocal binding is met.

5.7 The Highest Subject Restriction.

Doherty (1992²²) also claims that his analysis nicely accounts for the strange behaviour of copular subjects with respect to a restriction on the distribution of resumptive pronouns in Irish. McCloskey (1979, 1990) notes that the subject of the highest relative clause in an NP does not allow resumptive pronouns in Irish. Leaving a gap is the only strategy of wh-extraction allowed from this position, resumptive pronouns are disallowed:

- 49) a) *an fear a raibh sé breoite

²²But not Doherty (forthcoming), the revision of Doherty (1992).

the man who was him ill
 "The man that he was ill" (McCloskey 1990)

b) an fear a bhí ___ breoite
 the man who was ___ ill
 "The man that was ill"

This is referred to in the literature as the *Highest Subject Restriction*. (HSR). What is of interest to us here is that the subjects of copular clauses of both kinds do not seem to be subject to this restriction:

- 50) a) an fear ar dochtúir é
 the man C.rel doctor he
 "The man who he is a doctor"
- b) an fear arbh é an dochtúir é
 the man C.rel agr the doctor he
 "The man who he was the doctor" (Doherty 1992)

Doherty claims that the HSR follows from an i-within-i violation, caused by the positioning of clitics relative to complementizers in Irish clauses. Doherty is assuming that VSO order is derived by the movement of verbs through INFL to COMP. He notes that if you adjoin a resumptive clitic to a V+INFL+C complex in a relative construction, the following structure results:

51)

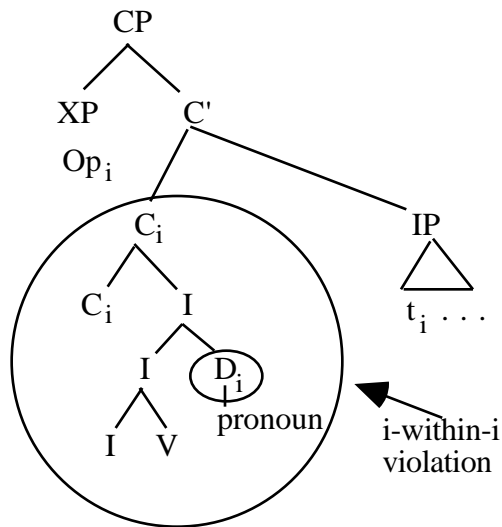

Doherty assumes the following about resumptive pronouns:

"McCloskey (1990) provides convincing evidence that resumptive pronouns are interpreted as syntactic variables and that unbounded dependencies utilizing resumptive pronoun strategies contain a null operator in the specifier of CP which is coindexed with the resumptive. Adopting this proposal, the mechanism of Spec-Head agreement will ensure that in an unbounded dependency, the index of the operator in the specifier of CP will be realized on the C head. ... [T]his leads to the C head bearing the same index as the [pronoun] which it contains. I claim that this results in an i-within-i violation."

This means that since the clitic pronoun in (51) is dominated by a complementizer head that bears an identical index, the whole structure will be ruled out. With respect to copular structure, recall from section 5.6 above, that for Doherty the subjects of copular clauses are in the specifier of IP which in copular constructions lies to the right. Pronouns in this position are not adjacent to the inflectional complex, and do not cliticize to them. This results in the structure given in (52):

52)

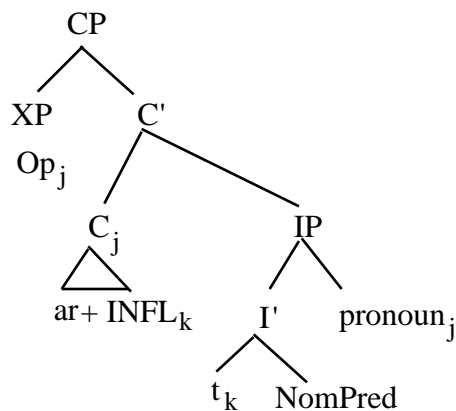

This is not an i-within-i violation, since the pronoun is not cliticized under the C head.

Perhaps the largest problem with this account lies in the nature of one of its basic assumptions, that the verb is in C at SPELLOUT in Modern Irish. As discussed at length above in chapter 2, McCloskey (forthcoming) presents extensive evidence that the verb in Irish raises no higher than the left edge of the inflectional complex; the fact that the complementizer is clitic to the verb is due to complementizer lowering, rather than raising the verb. Given McCloskey's facts, Doherty's account of the HSR restriction falls apart. If

verbs are not in C, then pronouns adjoined to those verbs cannot trigger i-within-i violations with that C:

53)

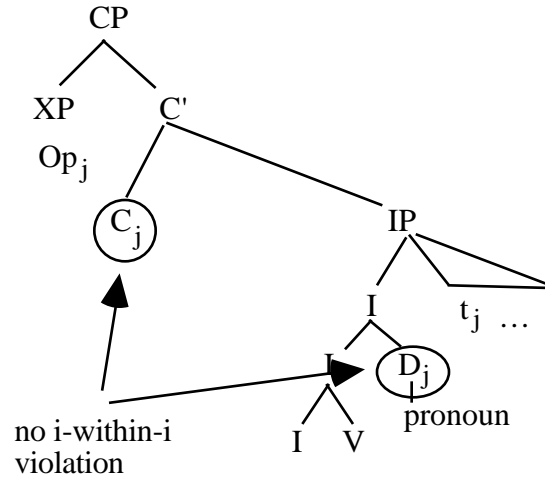

If Doherty's account of HSR falls apart, it follows that so does his account of the copular exceptions to the principle.

How then are we to account for the fact that copular structures do not obey the HSR? I suggest that Doherty's basic intuition that the reason subject pronouns in verbal clauses are subject to the HSR, whereas ones in nominal clauses are not, is due to the fact that subject resumptives are clitics in modern Irish verbal clauses, but not in nominal ones. The solution²³ I suggest, however, does not make use of i-within-i violations or raising of the verb to C. Instead, I will follow McCloskey (1990) and Déprez and Hale (1986) in assuming that the HSR is the result of an A-bar application of Principle B of the binding theory. I will show that the adjunction of a clitic to a verb+Infl head results in a different CFC (complete functional complex) for determining domains, than the non-adjunction found in clauses with nominal predicates. The difference between HSR violations and non-violations is a function of whether the resumptive pronoun is a clitic to Agr or not²⁴.

²³For a completely different view of the HSR, see Fox (1994).

²⁴In a remarkable coincidence, Doherty (forthcoming), but not Doherty (1992) independently comes up with a very similar analysis to the one presented here. Both works were prepared at approximately the same time.

For the purposes of this exercise, I will be assuming a simplified form of binding theory, one which is based in part on the work of Aoun and Li (1989). The basic principles of this simplified theory are that the domain of application of a principle of the binding theory is determined by finding, relative to a given nominal, the complete functional complex (in the sense of Chomsky 1986) which contains a subject different from that nominal. I will differ from Chomsky (1986) in assuming that all c-commanding [+N] categories²⁵, including Agr, may serve as a subject for this purpose²⁶. Aoun and Li propose the following principle to account for pronominal binding in A-bar structures:

A pronoun must be A-bar free in the least CFC containing the pronoun and a subject distinct for the pronoun. (Aoun and Li 1989, modified by McCloskey 1990)

With this in mind consider the following structure, created by cliticizing a pronoun to verbal head in T (irrelevant details omitted):

54)

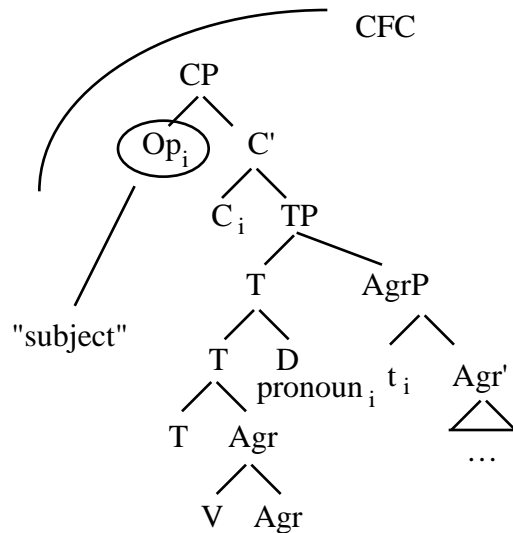

²⁵It is not entirely clear to me how this would translate into terminology compatible with the bare theory and the minimalist program, so I will use the terminology associated with older assumptions. I am thus assuming that there is some straightforward correspondence between the notion "category" and the behaviour of nodes in the bare theory.

²⁶For an alternative theory of binding that would get the same results, without allowing Agr as the subject, but making reference to T instead see Richards (in progress).

In this structure, the least CFC containing the pronoun is the CP itself. The nearest subject is the operator Op. Since Agr doesn't c-command²⁷ the pronoun, it cannot serve as the subject. This means that the smallest CFC containing both a subject and the pronoun is the CP. In this structure, the pronoun violates Aoun and Li's A-bar version of principle B. It is bound by the operator within the CP. If this approach is correct then other pronominal elements which appear within the verbal head should be ungrammatical in the same context.

This is true for overt agreement seen in the following pro-drop construction:

- 55) *na daoine a rabhadar breoite (cf. ✓na daoine a bhí breoite)
the people who were-3pl ill
"The people who they were ill" (McCloskey 1990:214)

Let us consider now what would happen if the pronoun were not cliticized to the verb. This configuration would arise when the pronoun is not in subject position, or when it is in subject position and in a conjunction like that in (57)

- 56) ✓duine ar bith a mbeadh Tóim agus é féin mór lena chéile
anyone who be.cond T and he-emp great with-each other
'Anybody that he and Tom would be very fond of one another'

When the pronoun does not adjoin to the verbal complex, the following configuration arises:

- 57)

²⁷If we wish to avoid introducing c-command into the notion of subject for determining binding domain, then we can also note that since Agr and the pronoun are part of the same complex head, the Agr node cannot serve as its subject.

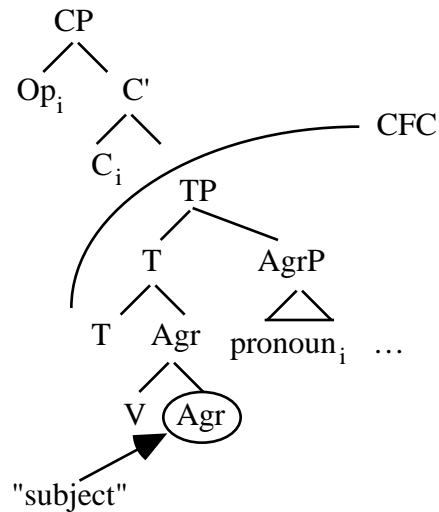

In (57) the Agr²⁸ head (or the T head containing the Agr head) c-commands the pronoun thus can serve as a subject for determining the least CFC containing both a subject and the pronoun. This CFC is thus the TP, not the CP. The pronoun in these constructions is not bound within its CFC, the Operator is outside the CFC. In constructions with a non-cliticized subject pronoun then, resumptive pronouns are allowed. To summarize the basic insight I am trying to capture here, if you cliticize a pronoun to a head containing a potential subject, you increase the size of the binding domain. In practice this means that the HSR will only ever apply to pronouns that have cliticized to the T+V+Agr complex^{29,30}. This then, like Doherty's approach, but without his analysis of copular constructions, accounts for the fact that the subjects of copular clauses are not subject to the HSR. These subjects

²⁸I assume that non-overt agreement does not bear indices linking it to the syntactic subject NP. For this reason it does not trigger a principle B violation itself. Overt agreement, on the other hand, like that found in (56) must bear such an index, to account for the ungrammaticality of that sentence. Similarly, the traces of Operator movement do not trigger violations, accounting for why it is only the highest subject, but not lower subject positions, which disallow resumptives.

²⁹Of course, with the further restriction that the binding Operator be in the CP immediately dominating the V+T+Agr complex. We need this qualification to account for the grammaticality of the following sentence where the operator is in the CP of the clause dominating the clause containing the resumptive:

✓An fear Op_i ar dhúirt mé go dtiocfadh sé_i
 the man C said I that come.cond he
 "The man that I said that the would come"

³⁰Similarly, in languages like Hebrew where the subject position is higher than Agr, resumptive pronouns are disallowed in the highest specifier of the inflectional complex (ie. Spec, TP).

are not clitics, thus are not adjoined to the Tense/Agr complex, and thus in turn are not locally A-bar bound.

5.8 Conclusion

In this chapter, I've accounted for a wide variety of word order facts with respect to the copula in Irish. I've shown that the two main word orders of Irish copular clauses follow directly if you assume that equative and predicative constructions have different theta marking properties. As discussed in chapter 4, in predicatives, the predicative N directly theta marks the attribute recipient NP. This predicate, like all inflected predicates in Irish, undergoes head movement to the highest inflectional position. The subject moves to the specifier of AgrS where it receives case. In equatives, on the other hand an abstract COP predicate appears. COP takes two arguments: an attribute and an attribute recipient. COP undergoes head movement to the highest position, and the two NPs move to argument positions. This accounts for the two main orders of Irish copular clauses. I have also shown that a third order, that of an equative with a pronominal subject follows directly if we extend Chung and McCloskey's (1987) analysis of rightward pronoun postposing to copular subjects. These orders, along with a verbal sentence for comparison are summarized in the chart in (58)

58)

C (PARTICLE)	T (PREDICATE)	Spec, AgrS (SUBJECT)	Spec, AgrO (OBJECT)	R-adj	
Ní <i>Neg</i>	fhaca <i>saw</i>	Seán <i>John</i>	an dochtúir <i>the doctor</i>		Verb
Ní <i>Neg</i>	dochtúir <i>doctor</i>	Seán <i>John</i>			Indef N
Ní <i>Neg</i>	hé <i>COP</i>	Séan <i>John</i>	an dochtúir <i>the doctor</i>		Def NP
Ní <i>Neg</i>	hé <i>COP</i>	t _i	an dochtúir <i>the doctore</i>	é _i <i>he</i>	Def NP pron. subj

I also argued that the so called "accusative" case showing up on the subjects of copular clauses is not a true morphological realization of a structural case, but is rather an artifact of the fact that the pronouns are not clitic to a tensed verb. I then argued that the extra agreement pronoun which surfaces in both Irish and Hebrew obligatorily in equatives and optionally in predicatives, is simply an overt realization of Agr. I claimed that the reason it must be present in equatives is because it identifies the otherwise abstract COP morpheme. In predicatives, on the other hand, the agreement features are on the predicate nominal. Since nominals normally do not bear agreement morphology, the morphological component is forced to either realize these features as the agreement pronoun, or to delete them entirely, thus resulting in the optionality of these forms. Finally, I showed how two of the pieces of evidence that Doherty (1992, forthcoming) uses in favor of his analysis of copular constructions can be easily accounted for under the present account. First, I showed that the fact that reciprocals in the predicate nominal can be bound by the subject, does not necessarily mean that the predicate nominal is c-commanded by the subject if we allow head-to-head movement to undergo reconstruction. Second, I showed that the fact that copular subjects are not subjected to the HSR is simply do to the fact that they are not clitic to the inflectional complex, thus are not included in the same binding domain as the HSR-inducing operator.

One major problem with the analysis sketched so far remains. In chapter 4, I claimed that predicate nominals undergo head movement through the inflectional heads. Unfortunately, however, phrasal predicates can appear in this position. This is highly surprising if the process involved is in fact head-movement rather than phrasal movement. In the next chapter, I will explore this issue in more detail and come to the surprising conclusion that, indeed, phrasal predicates in Modern Irish, undergo head-movement.

Chapter Six What's a phrase like you doing in a head like this?

6.0 Introduction

In this chapter we turn to the issue of the head-moving nominal predicates. The analysis sketched above in chapters 4 and 5 runs into problems when it comes to complex nominal predicates like those in (1). The whole predicate appears in the position associated with the head-moved element. Since head-movement is in principle the movement of heads, not of phrasal categories, it seems unusual to claim such movement is possible for what appear to be phrases.

- 1) a) Is *dochtúir capall* *é*
C doctor horses.gen him
"He is a doctor of horses"
- b) Is *amhrán a^L bhuaifidh an píobaire* "Yellow Submarine"¹
C song C play.fut. the bagpiper
"Yellow Submarine' is a song which the bagpiper is going to play"

¹As noted in Ó hAnluain (1960), this is not the only word order available for such clauses. The relative clause may optionally be left behind in the base position of the predicate:

- i) Is *amhrán é "yellow submarine" a^L bhuaifidh an píobaire*
C song agr wh play.fut the bagpiper
"Yellow submarine" is a song which the bagpiper will play"

Ó hAnluain (1960) notes "Uaireanta déanta dhá chuid d'fhaisnéis fhada d'fhonn cothromaíochta." (Sometimes, long predicates are split for the sake of balance). Ní Chiosáin (p.c.) tells me that although both are correct, the split form (i) is stylistically preferred. According to McCloskey (p.c.) Irish allows relative clause postposing in clauses in general. For a discussion of relative clause postposing and phonologically determined extraposition in general see Truckenbrodt (1994).

In Old Irish, splitting the head of a non-verbal predicate from its subject is the norm:

- ii) Ba lán **Hériu** *dia airdircus in chon*
C full Ireland of fame the dog.gen
"Ireland was full of fame of the dog" (*Scéla Mucce Meic Dathó*: Lehmann and Lehmann (1975))

However, this is exactly what I intend to do. I propose, informally for the moment, that these complex phrase-like elements are really X° s, despite their outwards phrasal appearance. This explains why they are allowed in a position normally associated with inflected predicates (i.e. between particles and subject agreement). I claim that the "phrasal" status of a phrase marker is determined not inherently, but rather is a function of its behavior. In section 6.1, I sketch some history of phrase structure, and of the notions head and phrase. I also present some discussion of how these are (not) incorporated into the bare theory of phrase structure (Chomsky 1994, 1995b) and how this allows a simple account of the fact that phrasal predicates are allowed in a head position. In section 6.2, I present some evidence that phrasal nominal predicates in Irish behave more like X° s than like phrases. In section 6.3, I show how this distribution can be captured in the bare theory of phrase structure. In section 6.4, I discuss how a p-marker which has both properties of phrases and X° is interpreted by the morphology. I adopt a theory of late insertion similar to that of Halle and Marantz (1993, 1994) (contra Chomsky 1992), which accounts for the distribution of phrase-like elements in positions associated with X° s. In section 6.5, I show how the analysis sketched in previous sections accounts for a previously mysterious construction in Irish. In section 6.6, I extend this analysis to some facts of morphology and syntax in Tagalog copular structures and the Irish construct state. Finally, in section 6.7, I provide some speculations about some other potential extensions of the theory for Yiddish, Modern Persian, Yoruba and Dutch.

6.1 The status of the notions "head" and "phrase".

It has been a standard assumption of many syntacticians since the advent of generative grammar that the notions of *phrase* and *head* are primitives (Chomsky 1957, Jackendoff 1977, Speas 1990). In fact, I believe that (to a certain extent) almost all

generative linguists assume that this is one of the most basic properties of syntactic theory². The standard assumption is that whether a phrase marker (henceforth p-marker) is a head or a phrase determines its behavior in the syntax. For example, given a structure like that in (2), we predict certain behaviors of the elements involved. Only phrasal elements like XP, YP, and ZP will be allowed to undergo A-movement and A-bar movement. From a semantic perspective, usually only phrasal elements can receive a reference³ (although they need not do so). Similarly, only heads like X (in (2)) are allowed to participate in head-to-head movement, participate in the morphology, bear inflectional features, select for complements, and, idioms aside, have idiosyncratic lexical properties of all types (phonological, semantic, syntactic and morphological)

2)

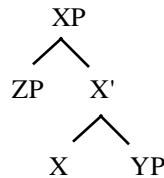

In this chapter, following Chomsky (1994, 1995b), I am going to make the controversial claim that the assumption that phrasal status determines behavior is backwards. I will show that "phrase" and "head" are not syntactic primitives; instead, I will claim, the "phrasality" or "headness" of a phrase marker is determined solely by the function and behavior of that marker. Phrases and heads in this conception are thus simple artifacts of the behavior of the p-markers involved. What limits the behavior of p-markers are other properties of the human language computational system (such as the interface with morphology/phonology and the interface with the semantic component), not the p-marker's status as a phrase or head.

²For some non-transformational models this is equally true. Take for example, Generalized Phrase Structure Grammar (GPSG) and Head-Driven Phrase Structure Grammar (HPSG).

³Leaving aside the issue of proper names and clitics for the moment.

In this chapter, I will discuss some properties of the minimalist *Bare Phrase Structure* approach of Chomsky (1994, 1995b) that lead us to this conclusion. I will show that Chomsky's definitions of the minimal relations in phrase structure cause us to lose the formal distinction between phrase and head. Rather than this being a problem for the theory, I will show that this, in fact, gains us some empirical advantages with respect to certain phenomena in the syntax of non-verbal predicates in Modern Irish. I will then show that this analysis provides a simple account of related facts in other languages.

6.1.1 A short history of phrase structure

Early work in structuralist and generativist linguistics (such as Harwood 1955 and Chomsky 1957) assumed that three different kinds of information must be contained in rules describing or generating p-markers: (i) the constituency of the linear string of elements in a sentence and the phrasal status of those elements, (ii) the linear ordering of those elements, (iii) the semantic/categorial selectional relations between those elements. Take, for example, the typical rules given in (3)

- 3) S NP VP
NP Det (AdjP) N
VP V (NP)

These rules encode such information as the phrasal status of each node in the tree, the categorial status of each node, the ordering of sister nodes, as well as subcategorizational and selectional information (such as the fact that verbs may optionally select an NP complement.) Jackendoff (1974, 1977) argued that some of this information is redundant to information already available in the lexicon. For example, information on semantic and categorial selection must already be encoded in the lexical entry for most words. The verb *kiss* has the partial lexical entry in (4):

- 4) Kiss: [NP_____] [KISS [NP_____]]
 [+animate] [-abstract]
 {agent} {patient}

To distinguish it from other verbs, *kiss* must encode such information that it takes two arguments—the animate agent and the non-abstract patient—both of which must be NPs. The patient NP must be the complement and the agent is the subject. There is considerable redundancy in this representation with respect to the information in the phrase structure rules. Since this information is necessarily idiosyncratic to specific lexical entries, Jackendoff concludes that it should be eliminated from the phrase structure. In addition he notes that the rules take a systematic shape: each phrase is the projection of one of its daughters. Similarly, building on the work Chomsky (1970), he notes that there can be no rules of the kind seen in (5):

5) *NP Det Adj

Jackendoff thus proposes that categorial and selectional information be eliminated from phrase structure rules. He thus proposes that phrase structure is determined by "X-bar schema" (a simplified version of which is sketched in (6))⁴:

6) $X^n (C_1) \dots (C_j) - X^{n-1} - (C_{j+1}) \dots (C_k)$
 where $1 \leq n \leq 3$, and $C = X^{\max}$

This schema retains information about phrasal level and about linear order. It also maintains a notion of "head", but makes this non-category specific.

Kayne (1994) proposed the first significant revision of phrase structure theory (within the generative paradigm) since Jackendoff. He proposes that we can derive the linear order of constituents from the relation of asymmetric c-command between terminal elements. He proposes that if one terminal asymmetrically c-commands another then the first precedes the second in linear order. This is encoded formally in the *Linear Correspondence Axiom*:

⁴See Muysken (1982) for a short survey of the history of X-bar theory and its crucial parts and for an alternative formalization of the schema.

- 7) *Linear Correspondence Axiom (LCA)*:
d(A) is a linear ordering of T
(where T is the set of all terminals elements, and A is the set of ordered pairs of non-terminals where the first asymmetrically c-commands the second. (Kayne 1994)

(For a more thorough discussion of the LCA see Kayne (1994) and Chomsky (1994, 1995b). With this then we have reduced phrase structure to some bare essentials. In the next subsection, we look at the theory of Chomsky which goes even further in this regard.

6.1.2 *The Bare Theory of Phrase Structure.*

Chomsky's minimalist program (1993) strives to eliminate all but the "conceptually necessary" stipulations and theoretical machinery from the grammar. Kayne's antisymmetry approach is clearly within the spirit of such an approach, since it tries to derive the ordering stipulations of X-bar theory from other relations otherwise motivated in the grammar. However, in his (1994, 1995b) *Bare Phrase Structure* (henceforth BPS), Chomsky claims that Kayne has not gone far enough in his reduction of phrase structure theory. Chomsky proposes that the bare theory of phrase structure consists of the following:

- Given two lexical items, you want to MERGE⁵ them into a single unit, with a label. The label represents the properties of the merged pair that are relevant to the syntax (e.g. features). The null assumption is that the label of the merged unit is the label of one of its daughters. Ordering is stipulated by the LCA.
- The following are the minimal relations among elements of the p-markers:
Head, Complement, Specifier

Let us take a simple example of a phrase like "the platypus". We wish to merge the two items into an unordered pair with a label. Since the definiteness of the phrase is the relevant feature which we wish to make available to the syntax, we make the determiner the label.

This is formalized in set theoretic notation as in (8):

⁵MERGE can operate on terms brought from the lexicon as well as on its own output. Chomsky also allows an operation of MOVE, which merges an item with an item, where is already a subconstituent of. This is the bare theory equivalent of Move-.

8) {the { the, platypus } }

label merged lexical items

We can informally represent this in a tree like that in (9):

9)

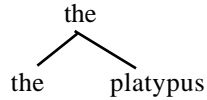

Let us now consider how this conception of phrase structure differs from previous ones. Note that there are no more category labels (like N, V, Adj etc.) and there is no more X-bar theory. This leads us to ask how a p-marker could be defined as an XP or an X^o. Although Chomsky seems to assume that such a distinction exists (since he makes frequent reference to it) and he claims this distinction is one which can be derived from other properties of the grammar, he gives us no clue as to how to derive it. At one point, he appears to make the appropriate distinction: he limits "heads" to terminal elements, thus apparently distinguishing heads from phrases. In fact, such a characterization is unfortunately untenable. There are elements which would be characterized as heads under anybody's definition which are not terminal elements. For example, complex "heads" are formed by head to head movement (like the movement of verbs through the inflectional heads.) These complex p-markers are not phrases, but they are also not terminal elements — the constituents of the complex head are terminals. For the purposes of this chapter, I will reserve the term "head" to refer to elements which give their labels to the merged complexes. I will use the term X^o to refer to elements (heads or otherwise) that are "word-like" (in a sense to be defined below) and the term XP to elements that are "phrasal" (again in a sense to be defined below). To clarify then we have the following four loose definitions:

- 10) *Terminal*: a term with no subconstituents
Head: the term that gives its label to a constituent⁶
X°: an element that is "word like" (in a sense to be defined below)
XP: an element that is "phrase like" (in a sense to be defined below)

Given then, that terminality is not the relevant distinguishing characteristic, we might ask how XPs are distinguished from X°s. Given the minimal system of labeling proposed by Chomsky the distinction is not entirely obvious. Consider the merged pair below:

- 11) {Y {Y, Z}}

This set is ambiguous in interpretation: it could be both a YP dominating a ZP, or a Y node that has had a Z node merged with it. This is seen in the diagrams in (12) (recall that linear order is irrelevant). (12a) is a YP dominating a ZP, (12b) is the result of merging a Z X° to a Y node⁷.

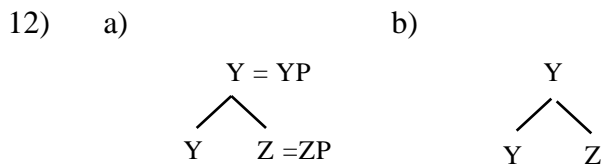

Chomsky's system, then, provides no mechanism for determining the phrasal status of a p-marker. This, however, is a good feature of the bare theory. The null, most minimal, answer to the question of what defines XP and X° is that there is no such structural definition. Instead, whether an item is an XP or an X° is an artifact of its behavior. If a node is behaving like a maximal category (i.e. input into the syntactic interpretive system) then it is an XP. If it is behaving like an X° then it is an X°.

⁶For an interesting discussion of what is meant by "head" in syntax, morphology and phonology see Muysken (1982)

⁷Chomsky's system of head raising would never create a complex head like that shown in (10), this is because, by stipulation, head-to-head movement is adjunction, thus creates a pair with a complex label : {<Y,Y> {Y,Z}}. There is no obvious reason for such a restriction, however. Furthermore, it should be noted that such a labeling still does not distinguish X°s from XPs, the set {<Y,Y> {Y,Z}} could equally describe a Z adjoined to an Y head or a ZP or Z adjoined to an YP

Chomsky notes that there is at least one case where a p-marker behaves both like an phrase and like an X° : clitics. Take, for example, the Irish subject clitic shown in (13), and the French object clitics seen (14):

- 13) [Chonaic **sé**] an platapas le ghloiní
 Saw **he** the platypus with binoculars
 "He saw the platypus with binoculars"
- 14) Jean ne [l' a] pas vu
 J neg **it** has neg seen
 "John has not seen it"

These elements have syntactic properties of both XPs and X° s. Like other arguments, these clitics are theta marked and are allowed to skip intermediate X° s in their movement up to their surface position (i.e. they violate the head-movement constraint). In this sense they behave like phrases. On the other hand, they adjoin to verbal heads, just like X° s.

In the next section of this chapter, I'll present some evidence from Modern Irish non-verbal predicates that shows a similar behavior: they look like phrases and are complex, but appear in a position normally limited to verbal heads.

6.2 Evidence for the X° status of nominal predicates in Irish

In chapters 4 and 5, I claimed that nominal predicates in predicative constructions in Irish undergo head-movement, just like verbal predicates, to the highest inflectional head in the clause. I suggested quickly above that this was true even of complex and phrasal⁸ nominal predicates. In section 6.1, I suggested that this behavior is legitimate under the bare theory of phrase structure since there is no structural definition of the notions XP or

⁸Larson (1988) makes a similar claim about the italicized element in the following Heavy-NP shift sentence:

i) Max *sent to me* the longest letter anyone had ever seen.
 He claims that V's like the italicized element in (i) undergoes head movement to a light verb higher than the heavy NP. This happens after a rule of reanalysis has applied. Although I will not go into details here, these facts may well have a straightforward account under the system described here. For a different view of Heavy NP shift see Pesetsky (1995).

X°. I claimed without argumentation or formalization (which we will return to below) that the distinction between X°s and XPs was a function of that p-marker's behavior. In this section, I will attempt to provide evidence⁹ that Irish nominal predicates are indeed behaving like both X°s and like XPs. The structure of the arguments is that these phrases show the behavior associated with X° level p-markers in Irish. In contrast, attribute NPs in equative clauses, which do not undergo head-movement, show properties associated with phrases.

6.2.1 Evidence from *wh*-extraction.

One piece of evidence in favor of the X° status of indefinite nominal predicates comes from *wh*-extraction. The argument is as follows. If predicates have undergone head movement like X°s, then subcomponents of these predicates should not be able to extract via *wh*-movement.¹⁰ Before proceeding to the actual test, it is worth noting that Moro (1993) and Heycock (1991) have argued that a similar blocking of extraction from copular clauses in English can be accounted for using subjacency. However, it should be noted that Irish does consistently allow subjacency/ECP type violations (McCloskey 1979). If the speaker leaves a resumptive pronoun at the extraction site¹¹ and changes the highest complementizer from a^L to a^N , then a sentence with such a violation is rendered

⁹In previous work (Carnie and Harley 1994a,b; Carnie 1994; Carnie and Barbosa 1995), I have presented evidence from anaphoric islands (Postal 1969) to support this conclusion as well. Unfortunately, it turns out that this evidence was based on an ill constructed example. The test was to see if complex nominal predicates in Irish behaved like compounds (X° level units) with respect to making reference to their subconstituents. As pointed out to by an anonymous reviewer, however, the example I chose was ambiguous between a compound and a phrasal constituent. The fact that this element behaved like a compound, then is unsurprising, since it could be construed as a compound. Subsequent testing with a native speaker (Ní Chiosáin p.c.) has shown that relevant contrast discussed in the above works was a spurious one. Readers should take careful note then not to cite or reproduce the data from anaphoric islands from these works.

¹⁰It should be noted that I am assuming here that what blocks extraction is "X°-hood" rather than any principle like Wexler's *Freezing Principle* (Culicover and Wexler 1973a,b, 1977, 1980; Wexler, Culicover and Hamburger 1975). This is based on the fact that we cannot, across languages extract from, for example, verbal predicate heads (i.e. we cannot extract tense, agreement or any subpart of verbal meaning from a tensed verb).

¹¹I am, of course, assuming an operator extraction analysis of relative clauses like that in McCloskey (1990).

grammatical (see McCloskey 1979, 1990 for more details). This is seen in the following examples. In (15), we have an example of a sentence with a *wh*-island. *Wh*-movement of the subject of the embedded clause (15b) is licit, as long as the highest complementizer is a^N , and the resumptive pronoun *sé* 'him' is found at the extraction site. The ECP and subjacency are allowed to be violated under such conditions. Similar facts are found with nominal islands as is seen in (16).

- 15) a) *Bíonn fios agat i gconaí [CP caidé_i a^L bhuaifidh an píobaire t_i]*
be.hab know at.2.s always what_i COMP play.fut the piper t_i
 "You always know what the bagpiper will play"
- b) *Cén Píobaire_i [CP a^N mbíonn fios agat i gconaí [CP caidé_i a^L bhuaifidh sé_i t_i]]*
Which piper COMP be.hab know at.2.s always what_i COMP play.fut. he
 "Which bagpiper do you always know what he will play"
- 16) a) *Tá máthair an fhir san otharlann*
Be.pres mother the man.gen in.the hospital
 "The man's mother is in the hospital"
- b) *Cé a^N bhfuil a_i mháthair san otharlann*
who COMP be.pres his mother in.the hospital
 "Who is (his) mother in the hospital"

Given that such extraction is licit, we can use *wh*-extraction as a test for the X° status of a nominal, in contrast to the situation found in English. If *wh*-extraction is licit, then the sequence of morphemes is phrasal; if *wh*-extraction is illicit, then the sequence is functioning as a single word.¹²

This distribution is exactly what we find with nominal predicates. An indefinite NP¹³ predicate like that in (17) does not allow extraction, despite the fact that Irish normally allows extraction out of nominal islands (*arb* is the special form of a^N found in copular clauses). This is consistent with the idea that these are really complex words.

¹²I am operating under the assumption that excorporation (as in Watanabe 1993) is not available to the grammar.

¹³or perhaps more accurately a non-referential NP

- 17)a) Is $[_{NP} amhrán_i [_{CP} a^L bhuailfidh an píobaire t_i]](é)$ “**Yellow Submarine**”
C song COMP play.fut. the piper agr
 “‘Yellow Submarine’ is a song which the bagpiper is going to play”
- b) *Cén Píobaire; arb $[_{NP} amhrán_i [_{CP} a^L bhuailfeadh sé; t_i]](é)$ “**Yellow Sub**”
Which piper rel song COMP play.cond he agr
 “*Which bagpiper is ‘Yellow Submarine’ a song which he/ t_i is going to play”

This can be strikingly contrasted with the definite NP attributes, which are not predicates and do not behave like X^o s and undergo head-movement. In these sentences, wh-extraction from the definite NP is licit.

- 18) a) Is é “**Yellow Submarine**” $[_{NP} an t-amhrán_i [_{CP} a^L bhuailfidh an píobaire t_i]]$
C agr the song COMP play.fut. the piper
 “‘Yellow Submarine’ is the song which the bagpiper is going to play”
- b) Cén Píobaire; arb é ‘**Yellow Submarine**’ $[_{NP} an t-amhrán_i [_{CP} a^L bhuailfeadh sé; t_i]]$
Which piper rel agr the song COMP play.cond he
 “Which bagpiper is ‘Yellow Submarine’ the song which he/ t_i is going to play”

To summarize, wh-extraction is generally allowed from phrases of all types throughout the grammar of Irish. However, extraction from NPs that appear in initial (predicate) position is disallowed. This is a position normally associated with head movement, so it follows naturally that the extraction facts follow from a difference in what elements have undergone head-movement for feature checking, and what elements have moved to specifier positions for feature checking.

This conclusion is given support by the *in situ* status of wh-questions of constituents in Irish questions. In Irish, wh-movement is always marked by a wh-complementizer (usually taking one of the forms a^L , a^N , *ar*, *ar(b)* depending upon the situation; see McCloskey (1979, 1990) for more discussion). As seen in (19), wh-*in-situ* in Irish is not licit with verbal predicates:

- 19) *Bhuail Cathal cad?
 Hit.past Charles what
 “Charles hit what?”

This is true independent of focus stress on the wh-word. Strangely, however, in the formation of wh-questions of constituents of indefinite nominal predicate constituents, we find that Wh *in situ* does appear. This is evidenced by the lack an overt wh-complementizer. The presence of such a complementizer (*arb/ab*) is completely illicit:

- 20) a) Cén sort dochtúra (é) McCoy
What kind doctor.gen agr McCoy
 "McCoy is what kind of Doctor?"
- b) *Cad **arb** a dhochtúir (é) McCoy
What rel his doctor agr McCoy
 "*What would McCoy be a doctor of?"
- c) *Cén sort dochtúra **ab** (é) McCoy
What kind doctor.gen C.rel agr McCoy
 "*What kind of doctor is McCoy"

This is a truly surprising fact about Irish copular clauses which is simply explained if Irish nominal predicates are X⁰s out of which extraction cannot occur.

6.2.2 Evidence from the responsive system.

Finally, there is some evidence that not only are these predicates X⁰s, but that they are also not in a specifier position either. Moro (1993), Heggie(1988), and Heycock (1991) have all argued that in the English inverse copular construction the predicate NP is in a specifier position (for Moro and Heycock this is the specifier of IP, for Heggie the specifier of CP). There is substantial evidence that this is incorrect at least for Irish. This evidence comes from the responsive system.

Irish has no words for yes or no; instead, the verb is repeated in either the positive or negative form, as seen in (21) (where the negative form is indicated by an adjoined complementizer):

- | | | | |
|---|--------------------------------|----|----------------------------|
| 21)a) An bhfaca tú an Ferengí?
Q saw you the Ferengi
"Did you see the Ferengi?" | b) Ní fhaca
Neg saw
"no" | OR | c) Chonaic
Saw
"yes" |
|---|--------------------------------|----|----------------------------|

This can be analyzed as the elision of everything to the right of the verb in a manner familiar from VP ellipsis (22) (see McCloskey (1991) for more discussion).

22) Elide everything except (complex)T(and adjoined complementizer)

For example, you elide the shaded parts of the sentence schematized in (23).

23)

C +	T	Spec,AgrSP	Spec,AgrOP	R-adj
Ní	fhaca	Seán	an ferengí	inné
<i>Neg</i>	<i>Saw</i>	<i>John</i>	<i>the Ferengi</i>	<i>today</i>

Given that I have claimed predicates in copular clauses are in T, then when elision occurs, then the predicate should remain. At least for adjectival and prepositional predicates that appear in this construction this is true (24-25).

24) Q: An le Seán an Subaru? A: Is leis "Yes"
 Q with J the Subaru C T
 "Does John own the Subaru?" C with.him

25) Q An ceart mo chuimhne A: Is ceart "Yes"
 Q right my memory C T
 "Is my memory is right?" C right (from Doherty 1992)

In sentences with definite NP predicates, similar behavior also occurs. Recall that in the analysis sketched above, definite NP predicates are not X°s in an functional projection, rather, they are the argument of an abstract COP predicate. Thus in sentences with definite NPs we expect only the pronominal agreement realization of the abstract predicate to remain. This predication is true (26).

26) Q: An é Ceannasaí an Enterprise William Riker? Is é
 Q COP+T+Agr Commander the C T
 "Is William Riker the Commander of the Enterprise?"

The situation is more complex with indefinite nominal predicates (27) which we argue appear in T. In these cases the predicate does not surface, but is replaced by the dummy pronominal "ea"

27) a) An dochtúir Leonard McCoy? b) *Is dochtúir
 Q Doctor ✓Is ea
 "Is Leonard McCoy a doctor?"

This is similar to “do support”. This dummy pronominal shows up when you have an indefinite predicate. What is crucial here is that the element appearing in the T head is retained (via the pro-form “ea”) in responsives, supporting the analysis that these complex nominal predicates are part of T°.

Now let us consider the status of specifiers. This issue is very difficult to test since the highest specifier never seems to be filled by anything in Irish. McCloskey (1993), however, points out that there is a set of elements that appear to be IP-initial or IP-adjoined elements. Based on scope and negative polarity items, he claims that the sentence initial adverbs in (28a) are IP adjoined (in our terms TP-adjoined). We refer the reader to that work for arguments in favor of this position.

28)a) I lár an gheimhridh, an bhfaca tú do chara,
in middle the winter, Q see you your friend
In the middle of winter, did you see your friend

b) Ní fhaca
No.

What is interesting about these cases is that in the responsive system the elements which are either in the specifier or adjoined are omitted. Again, only the C-V-T head remains. If we follow Kayne (1994) in assuming that specifiers and adjuncts are the same kind of object, we have strong evidence against predicates being in an specifier position. The responsive system of Irish only repeats the T head; all specifiers and adjuncts are omitted. If the predicates in Irish were in a specifier position we would expect them too to be omitted. This is contra to fact.

6.2.3 Section Summary

In this section, I've presented evidence that indefinite predicates in Modern Irish appear in a position associated with head-movement, despite the fact they can be phrasal and complex. Evidence for the X° status of these predicates comes from the responsive

system, where they behave like verbal heads in an T° head and from wh-extraction where constituents of these elements cannot be extracted.

Why is it that a phrasal element is allowed to behave like a head in this one particular case? I claim that this will follow directly from the functional definitions of phrases and heads sketched above in section 6.1.

6.3. The Mechanics of an XP that behaves like an X°

In *Bare Phrase Structure*, Chomsky (1994, 1995b), notes that, in general, the kind of movement we have been discussing above (adjunction of a phrase to a head) is disallowed. In fact, this kind of generalization is one of the primary motivations for positing a primitive head/phrase distinction. He claims that the reason that XPs never undergo head movement is because of the "natural assumption" that:

Morphology gives no output (so the derivation crashes) if presented with an element that is not an X° (BPS pg. 18)

The biggest problem with this kind of account is the fact that we have no structural definition of what a phrase or a head is. This technical problem aside, let us consider how a theory *with* a primitive phrase/head distinction might deal with the facts discussed above in section 6.2. Carnie and Harley (1994a,b) and Carnie (1993) present such a theory. They claim that indefinite predicates in Irish incorporate into their determiner, which in turn undergoes the head movement to the highest inflectional category, deriving the predicate-subject order. This is schematized abstractly in (29).

29) Carnie (1993), Carnie and Harley (1994a,b)

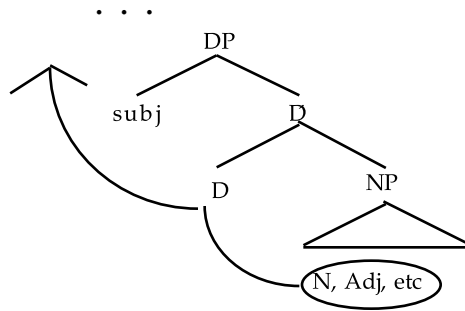

However, there is a serious empirical problem with such an approach as pointed out to me by Rachel Walker (p.c.). This lies in the behavior of specifiers that appear within the predicate. Consider a predicate like *a linguist who Shawn kissed*. An Irish sentence containing this predicate is seen in (30):

30) Is *teangeolaí ar phóg Seán* (é) Peadar
 C linguist C.rel kiss Shawn agr Peter
 "Peter is a linguist who Shawn kissed"

If we were to incorporate the entire predicate into the indefinite determiner head, we would expect to skip all specifiers in order to obey the Head Movement Constraint of Travis (1984). The tree in (34) is an abstract schematization of a predicate like that in (30), irrelevant details omitted. You will note that if we perform head-to-head movement we naturally skip the subject NP in a specifier position.

31)

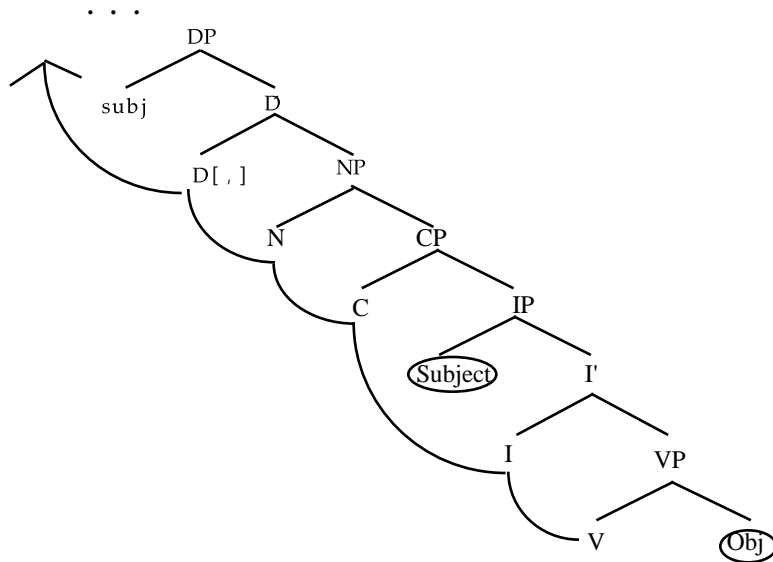

Thus we would predict that specifiers in Irish predicates would be stranded at the site of extraction. This is a blatantly false prediction:

32) *Is *teangeolaí ar phóg* (é) Peadar *Seán*
 C linguist C.rel kiss agr Peter Shawn
 "Peter is a linguist who Shawn kissed"

The only way to avoid this problem, yet still maintain the incorporation analysis would be to perform head-to-head movement, then incorporate into the subject NP in a specifier, then incorporate from that specifier back into a head. This is seen in (33):

33)

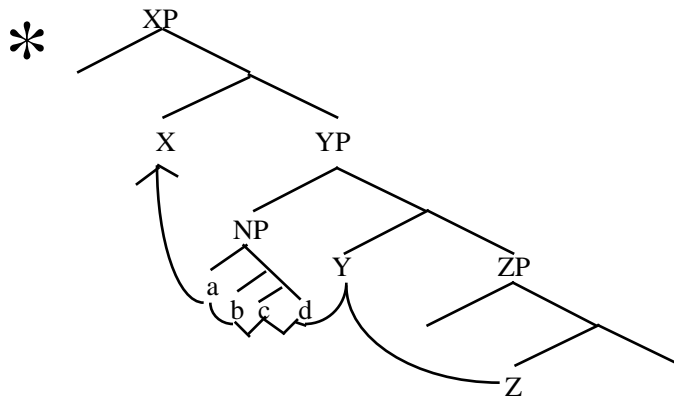

Not only is such movement unheard of elsewhere, there is no possible cause (like feature checking) that would induce such movement. There is simply no motivation for this kind of

movement. We must therefore reject an incorporation analysis of these facts. Yet we are left with the problem that these phrase-like elements behave like words with respect to extraction, the responsive system and head-movement. They appear in a position which, in Irish, is restricted to heads.

I propose that, simply, this element is an X° , as determined by its behavior. Complex nominal predicates in Irish are treated by the grammar like X° s and are allowed to undergo head-movement to adjoin to functional categories just like verbs:

34)

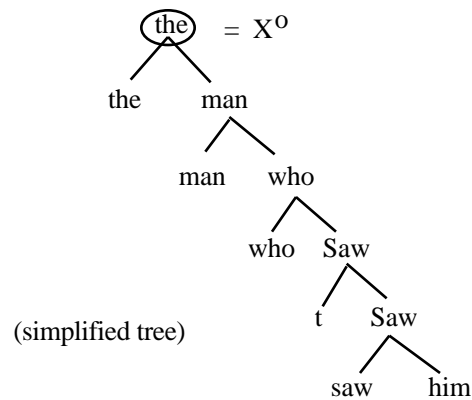

What mechanisms determine whether a p-marker is an X° or an XP? I propose, again following Chomsky (1994, 1995b), that the notions X° and XP are simply artifacts of the behavior of the p-marker with respect to other components of the computational system. For example, let us propose that the ability to bear tense and agreement features is a property only associated with elements that undergo head to head-movement, whereas the ability to bear case features is a property associated with element that undergo XP movement (A or A-bar). Notice that the relevant criterion for what is an XP and what is an X is how they behave, both with respect to bearing features and with respect to movement. What would happen if we tried to move an X° into a position associated with XP movement? The appropriate inflectional features could not be checked in such a

configuration and the derivation would crash. Similarly, the converse would be true if we tried to adjoin an XP to a head.

I suggest, following Chomsky¹⁴, that the following are some possible criteria for the XP-ness or X^o-ness of a p-marker. Recall that according to Chomsky, a p-marker can be both an XP and an X^o at the same time, so it is not the case that any one of the following properties are necessarily the definition of an XP or an X^o. Rather, it is the case, that a p-marker can have any number of properties of both X^os and XPs and thus behave accordingly.

Properties of X ^o s	Properties of XPs
theta markers	theta marked
bear Tense and Agreement features (undergoes head-movement)	bear Case features (undergoes XP movement)
select for complements	are selected for
don't have reference	may have a real world reference
input to/output from the morphology	not inputs/outputs of the morphology

The reason that complex predicates are not allowed to adjoin to heads in languages like English follows from the fact that they are not allowed to bear tense and agreement features. Adjoining a complex predicate p-marker to an inflectional head would cause the derivation to crash, since there would be no features to check. The phrase/head status of the element is thus determined by its behavior with respect to the rest of the computational system. Irish, on the other hand, is special, since it allows complex predicates to bear tense and agreement features.

¹⁴My account differs from Chomsky's in the following crucial way. I allow projecting p-markers to behave ambiguously with respect to XP or X^o status. Chomsky (as I understand him) seems to allow only non-projecting elements (like clitics) this honor.

Let us consider the derivation of a simple sentence like that in (35).

- 35) Is *fear mór* **Seán**
 C man big John
 "John is a big man"

Using the operation of MERGE we take the two lexical items *fear* 'man' and *mór* 'big' and merge them into the set {*fear* { *fear*, *mór* }}:

36)

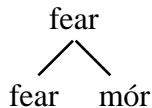

We now merge this with tense and agreement features^{15, 16} (informally represented as here). This is what distinguishes Irish from English; English does not allow its nominal predicates to merge with inflectional features. This is presumably a restriction on the English morphological component¹⁷.

37)

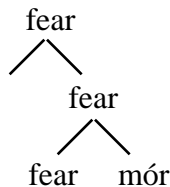

Since this element is acting as the predicate, it can be merged with an argument NP which it directly theta marks:

¹⁵It is important to note that these are features not the actual T or Agr nodes themselves. The nodes are later merged with this structure.

¹⁶As noted in Jelinek and Demers (1994) the Salish languages allow such features to be expressed overtly in the morphology, see chapter 5 of this thesis for further discussion.

¹⁷I have chosen to project *fear* as a the head here rather than . This was an arbitrary choice on my part and has no empirical consequences; the projection of would work equally well. It is also not clear to me whether we need to merge features with nominal complex non-verbal predicates or simply allow the heads of these complex preds to bear the inflection and allow feature percolation to inflect the whole unit. I choose the former entirely arbitrarily.

38)

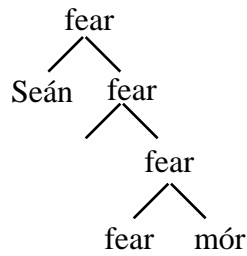

Notice that the p-marker {fear { , fear}} is behaving in many respects like an X° . It bears inflectional features, and it theta marks an argument. Because of this, it is behaving like an X° (albeit a complex one, but an X° nonetheless). It is thus allowed to undergo head to head movement. The VP-like complex NP and its subject are merged with each of the functional categories in turn, where the inflectional features are checked. The predicate undergoes head-movement and the subject raises to the specifier of AgrSP for case reasons. This is all schematized in (39).

39)

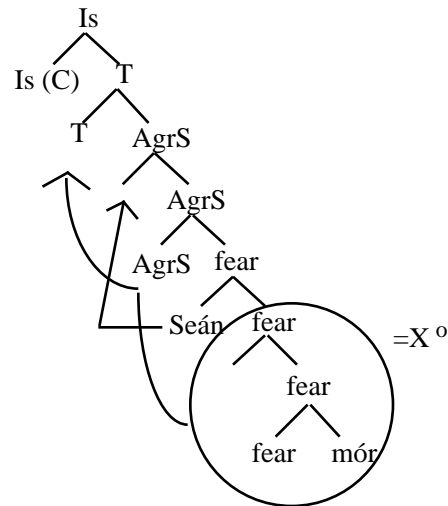

This derives the correct word order facts of Modern Irish copular constructions, and accounts for the word-like behavior of their predicates.

6.4 What does the morphology do with these complex X° s?

So far in this chapter, I have attempted to provide evidence for the fact that complex nominal predicates in Irish appear in positions associated with X° s. I have claimed that, under Chomsky's bare theory of phrase structure, there is a straightforward account of these facts in that the complex nominal is, in fact, behaving like an X° . We are left with the problem, however, that internally these X° s have the word order, morphology, and phonology of phrases rather than words. This is potentially problematic. The question then is how does morphology know whether to map a particular p-marker into word or phrase morphology. It is clear from the above that this cannot be a function of the behavior of the p-markers involved since we have a p-marker functioning like an X° but surfacing as a phrase. I suggest that this follows straightforwardly from a modified version the theory of Distributed Morphology¹⁸ (Halle and Marantz 1993, 1994, Marantz 1995b). In particular, I claim, contra Chomsky (1991, 1994, 1995b), Williams (1994) and Di Sciullo and Williams (1986), that morphological items are inserted after the syntax via a principle of *Late Insertion*. The fact that these X° s are surfacing with phrasal morphology is simply due to the fact that the vocabulary list of Irish morphemes contains no single morpheme, nor affixal equivalents to the complex X° s. In other words, the fact that these X° s surface as phrases, is because Irish simply lacks X° level morphological equivalents to these complex X° s. The morphology of Irish is thus forced to insert independent words under the terminal nodes dominated by this X° .

Simplifying greatly, the theory of morphology articulated here holds that syntax does not involve computation of the actual surface morphological items.¹⁹ Rather it computes nodes that consist of bundles of features. After SPELLOUT, principles of lexical

¹⁸I differ from Halle and Marantz in assuming that the morphology can look at more than the terminal elements in a string and can look at such things as node that dominates the terminals.

¹⁹Whether or not such a claim is consistent with the system of feature checking discussed in chapter 1 and 3 is a matter I will leave open for the purposes of this work.

insertion apply,²⁰ inserting morphological forms taken from a vocabulary list into the nodes representing the bundles of features. For example, in English, given a syntactic node that contains features associated with verbal features and agreement features, we can map directly onto this a verbal root and an agreement suffix:

40) [[verb][3 sing]] /wak+s/ "walks"

Now consider the case of the nominal predicates in Irish. Let us take a phrasal predicate like the *fear mór* 'big man' example given above in section 6.3. In this example, we have an X^o like the following (leaving off, for the moment, tense and agreement nodes). Bundles of features are represented informally here as the word in capital letters:

41)

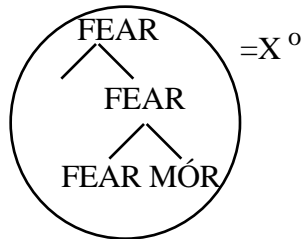

When the principles of lexical insertion try to realize this node, they find that there is no single vocabulary item matching this head. Similarly, there are no affixal forms equal to either FEAR or MÓR. The morphology is then left in a quandary; it cannot realize this node as a word level unit because there are no affixes or roots that will realize the node as a word level unit. Instead, the morphology simply inserts two word level units (*fear* /f'ar/ and *mór* /mo:r/), just as it would if it were dealing with a normal XP.

This morphological account may also explain the distribution of the agreement morpheme in predicative constructions, discussed above in chapter 5. Recall that the presence of this agreement morpheme is optional when the structure is predicative:

²⁰This is a gross oversimplification, other principles may apply (such as rules of fusion, fission, and impoverishment) before the actual lexical insertion. See Halle and Marantz (1993, 1994), Noyer (1992) for more discussion.

- 42) Is Platapas (é) Tóim
C Platypus (agr) Tom
"Tom is a platypus"

Irish has no agreement suffixes which can attach to nouns, so when faced with the structure that has a nominal predicate combined with nominal inflection, the morphology can take one of two options: it can either ignore the agreement features (i.e. not realize them), or it can realize them in the form of a separate pronoun. This then accounts for the optional distribution of the Irish agreement morphology in predicative structures.

Given that the appearance of these X° nodes as phrases is due to what vocabulary items are present in the vocabulary of Irish, we predict there may well be cross linguistic variation in what nodes can surface as "words". This is especially true under the view that the lexicon is the source of all idiosyncratic information and crosslinguistic variation. As pointed out to me by Jonathan Bobaljik, we might predict the existence of a language or a class of languages where, unlike Irish, some subset of complements (to nouns or otherwise) are affixal in nature, thus will surface as part of a complex predicate's word structure. This class may very well be the class of incorporating languages (Baker 1988). Given cross-linguistic variation in what the status as roots or affixes of lexical items is, we expect cross-linguistic variation in what is treated in a word in a given language. This seems to be borne out.

6.5 How the theory explains a problematic Irish construction

Interestingly, the account of Irish predicative constructions given above provides a simple explanation for a construction problematic for all previous accounts of the copula. This is the construction seen in (43):

- 43) Is maith an lá é
C good the day he
"It is a NICE day" (Gloss after Ó Siadhail 1989)

This construction is curious in many ways. First of all, we have the obligatory presence of the definite article *an* in a clearly indefinite NP "a nice day". Second, unlike NPs in Irish in general, the adjective modifying the noun precedes that noun. This ordering of adjective and noun is highly irregular. With the exception of numerals and a few compounding adjectives²¹, nominal modifiers in Irish follow the noun they modify:

- 44) fear bocht
man poor
"poor man"

Finally, we have the existence of constructions like (45) which have a meaning close to that of (43) without the extra focus on the adjective. This construction does not have the puzzling definite determiner or Adj N order:

- 45) Is lá maith é
C day good it
"it is a good day"

Ó Siadhail (1989) claims that the puzzling construction in (43) is only found when there is emphatic focus on the adjective. This, in and of itself, is surprising since Irish does not usually focus adjectives by reversing their order and switching the definiteness; rather emphatic stress or clefting is used.

I suggest that the translation given by Ó Siadhail is misleading. I propose that rather than translating it as:

- 46) "It is a NICE day"

a closer translation would be something like

- 47) "It_i is nice, the day_i".

Let us assume that the structure of (47) is something like (48) (irrelevant details omitted), where the extra NP is right dislocated and adjoined to the AP:

²¹*Sean* "old" and *droch* "bad" are two examples.

48)

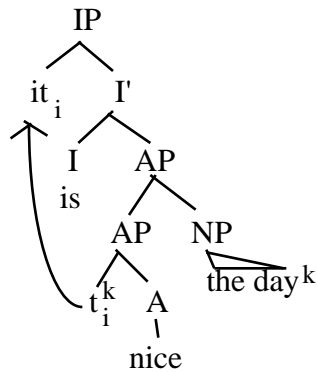

If we assume that the Irish construction has a structure in some way similar to (47), its surprising features disappear. Consider the English sentence above, notice that the adjoined NP in English cannot be indefinite:

49) *It is nice, a day

Whatever licenses²² this right dislocation in English imposes the same definiteness restriction on the equivalent construction in Irish. The strange Adj N ordering is also accounted for, since the NP is R-adjoined to the AP containing the adjective

50)

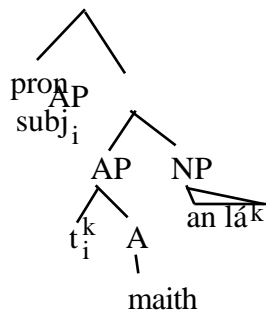

The fact that this element is adjunction (in both English and Irish) is evidence by the fact that when we leave off the NP, we receive an interpretation roughly equivalent (although, obviously not identical) to the one where the NP is present, this is true independent of whether the construction is a "weather" construction or not:

²²I have no idea what might perform this function. I leave this open for future consideration.

- 51) a) It is nice, the day It is nice
 b) She is pretty, the girl She is pretty
 c) Is deas an lá é Is deas é
 C nice the day it C nice it
 "It is nice the day" "it is nice"
 d) Is álainn an cailín í Is álainn í
 C pretty the girl her C pretty her
 "She is pretty, the girl" "She is pretty"

The structure I propose for the Irish construction, then, is (52)

52)

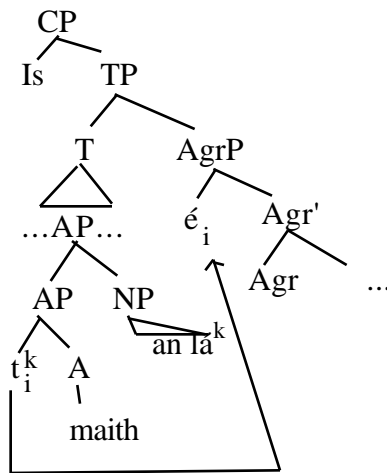

Notice that the account of X° movement of complex predicates given above in sections 6.2-6.4 gives a straightforward account of the fact that we have a right adjoined element appearing before an argument NP. The predicate and the right dislocated element undergo head-movement together to the front of the clause as part of a complex predicate.

6.6 Extensions of the Bare Theory approach to X° and XP.

In this section, I will explore some other examples of constructions where there is an ambiguity between phrasal and X° behavior, that lend principled support to the analysis presented above. I will look at the behavior of copular constructions in Tagalog and construct state nominals in Irish.

6.6.1 Tagalog Clitic Placement²³

Tagalog, a VSO language spoken in the Philippines, shows a remarkable number of similarities to Irish with respect to copular constructions. First, like in Irish, there is a difference in word order and case marking between predicative and equative sentences (Richards p.c.). Consider the sentences in (53)

- 53) a) Doktor si Beverly Crusher
 doctor NOM²⁴ Beverly Crusher
 "Beverly Crusher is a doctor"
- b) Si Jean-Luc Picard ang kapitan ng Enterprise
 NOM Jean-Luc Picard NOM captain GEN Enterprise
 "Jean-Luc Picard is the captain of the Enterprise"

In sentence (53a), a predicative construction, the predicate nominal precedes the subject NP. In the equative (53b) by contrast, the attribute NP follows the subject NP. This is the exact parallel of the Irish case. Notice also that in the predicative construction (53a) the predicate NP is not marked with any case marker; in (53b) however, both NPs are marked with a case prefix. Assuming case marking to be evidence of argumenthood (or lack thereof to be evidence of predicatehood), this supports the analysis given in chapter 5 of the difference between equatives and predicatives. Given the great similarities between Irish and Tagalog, I suggest that they are liable to the same analysis. I claim that the predicate NP *doktor* in (53a) has undergone head-movement to initial predicate position. In the equative construction (53b), both NPs remain in argument (case) positions.

Interestingly, the predictions of the claim that Tagalog copular constructions parallel Irish ones: (i) Complex non-verbal predicates will be allowed in initial position and (ii) these complex predicates will function like an X° , are held up by the data. In (54), we see an example of a complex predicate appearing in initial predicate position.

²³I would like to thank Norvin Richards for his extensive help with this section. The data provided here are his (but mistakes are mine!). He also provided much helpful discussion of the material

²⁴There is a great deal of controversy over whether Tagalog is a Nominative/Accusative language or an Ergative/Absolutive one. I avoid taking a stand on this issue and will simply gloss material as Nom/Acc following Richards (1993).

- 54) Takot sa kulog na si Worf
afraid DAT thunder now NOM Worf
"Now, Worf is afraid of thunder"

This, I claim, follows the account of Irish copular constructions given above. The evidence for these complex non-verbal predicates behaving like X° s comes from the behavior of second position clitics in this language. Tagalog has a set of Wackernaglian clitics (for more discussion see Sityar (1989) and Kroeger (1993)), one of which is the pronoun *siya* "he/she". These clitics typically are found immediately following the first X° in the clause.²⁵ This is seen in (55) with a variety of constructions with verbal clitics. As seen in (55b,d&e) positioning the clitic anywhere other than after the initial X° is illicit:

- 55) a) Bumalik siya sa Maynila
returned she DAT Manila
"She went back to Manila"
- b) *Bumalik sa Maynila siya
returned DAT Manila she
"She went back to Manila"
- c) Hindi siya bumalik sa Maynila
not she returned DAT Manila
"She didn't go back to Manila"
- d) *Hindi bumalik siya sa Maynila
not returned she DAT Manila
"She didn't go back to Manila"
- e) *Hindi bumalik sa Maynila siya
not returned DAT Manila she
"She didn't go back to Manila"

Interestingly, non-verbal predicates behave differently in this respect. The clitics can appear either immediately after the first X° in the non-verbal predicate (56a, 57a, 58a), or *after the whole complex predicate itself* (56b,57b,58b):

- 56) a) Reyna siya sa Rumanya
Queen she DAT Rumania
"She is the queen of Rumania"
- b) Reyna sa Rumanya siya
Queen DAT Rumania she
"She is the queen of Rumania"

²⁵There are also prosodic restrictions on the placement of this element. See Sityar (1989) for discussion.

- 57) a) Galing siya sa Maynila
from she DAT Manila
"She is from Manila"
- b) Galing sa Maynila siya
from DAT Manila she
"She is from Manila"
- 58) a) Takot siya sa kulog
Afraid she DAT thunder
"She is afraid of thunder"
- b) Takot sa kulog siya
afraid DAT thunder she
"She is afraid of thunder"

The analysis presented above in chapters 4, 5 and sections 6.2-6.4 provide a straightforward account of these placements. These constructions, like the predicative constructions in Irish, have raising of the complex nominal X° to the highest inflectional head (T). Let us take the sentence in (56) as an example; the resultant structure from such head-movement would be the tree in (59) (irrelevant details omitted and XP and X° notations added for convenience of the reader only):

59)

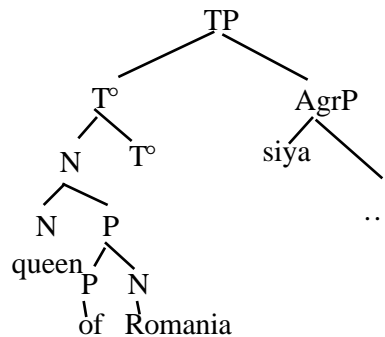

When faced with such a structure, the pronominal clitic is presented with two possible options for what constitutes the "initial" X° . First we have the option of the head *reyna* "queen":

60)

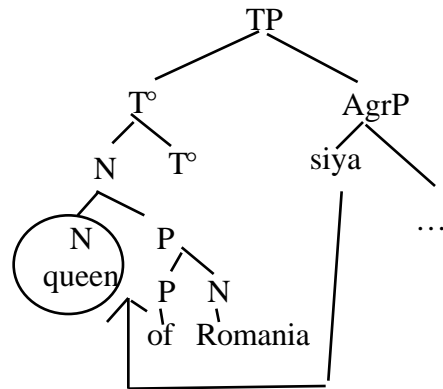

Or it can select the whole complex X° Predicate *reyna sa Rumanya* "Queen of Romania" as in (61):

61)

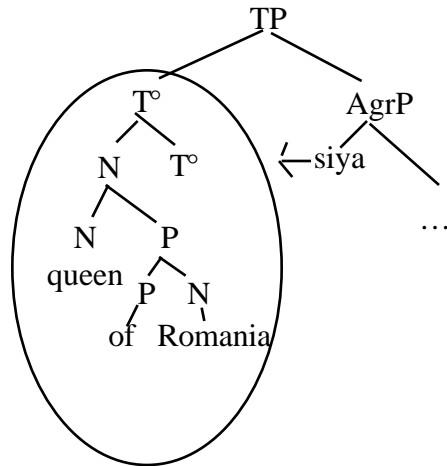

This is because both the head of the predicate and the complex predicate itself, seem to be functioning like X°s. Notice that, not only do the cliticization facts of Tagalog receive a straightforward account in the system here, they also provide cross-linguistic evidence in favor of the equative/predicative distinction, the head-movement account of non-verbal predicates, and the bare theory account of head-moving complex non-verbal predicates.

6.6.2 Construct State Nominals

Modern Irish has a genitive construction similar to the construction found in many Semitic languages called the construct state. Examples of this construction, taken from Hebrew, Maltese Arabic and Irish (data from Duffield (forthcoming)) are shown in (62):

- | | | | |
|-----|----|---|----------------|
| 62) | a) | Teach an fhir
house det man-gen
"The man's house" | Irish |
| | b) | ca'if ha-yalda
scarf det-girl
"The girl's scarf" | Hebrew |
| | c) | ras l-mara
head det-woman
"The woman's head" | Maltese Arabic |

These constructions have several properties which define them as Construct State Nominals (henceforth CSN), I refer the reader to Duffield (1992, 1993, forthcoming), Guilfoyle (1988), Ritter (1987, 1988, 1991a,b,c, 1995), Mohammed (1988), Borer (1988)²⁶ and Fassi Fehri (1993), among many others for discussion of these properties. For now, I will simply take one of these properties as being relevant for defining "Construct State", that of the mandatory lack of a definite determiner on the head noun:

- | | | |
|-----|----|--------------------|
| 63) | a) | *an teach an fhir |
| | b) | *ha-ca'if ha-yalda |
| | c) | *l-ras l-mara |

To explain this fact, Ritter (1987, 1988), Guilfoyle (1988) and Mohammed (1988) all independently proposed that possessed nominals in Hebrew, Irish and Arabic undergo head movement to a functional head in a manner completely parallel to verb raising in VSO structure (for a contrasting view see Ernst (1992)). This is schematized as in (64):

²⁶Borer (1988) notes that in many ways CSNs in Hebrew bear strong similarity to compound Ns. She suggests that CSNs are really compounds (word-level units with respect to the phonology) which are formed in the syntax. Although I will not attempt to deal with Borer's facts here, it should be noted that her analysis can be simply translated into the framework presented here: the CSN DP is interpreted as an X^o for the purposes of the phonological component.

64)

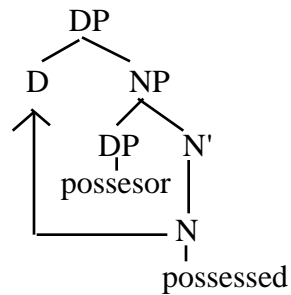

More complicated versions of this theory are expressed in Ritter (1991a,b,c, 1995) and Duffield (1992). The "determinerhood" of the possessed N head is expressed in the special construct form of the noun that surfaces in the Semitic languages.

As noticed by Duffield (1992, 1993, forthcoming) the head raising approach to CSNs runs into serious problems when it comes to Irish nominal modifiers. In the Semitic languages, adjectives and other modifiers of the head noun (possessed) noun follow the possessor DP ((65) is Maltese Arabic data taken from Duffield (forthcoming)):

- 65) sieq Willi l-leminj-a N_i DP Adj_i (Semitic)
 foot-f.sg Willy det-right-f.sg
 "Willy's right foot"

In Irish, however, this is not the case. An adjective²⁷ modifying the possessed head noun immediately follows that noun:

- 66) guth láidir an tsagairt N_i Adj_i DP (Irish)
 voice strong the priest-gen
 "The priest's powerful voice"

This order is completely disallowed in the Semitic languages:

- 67) *sieq l-leminj-a Willi *N_i Adj_i DP (Semitic)
 foot det-right-f.sg Willy
 "Willy's right foot"

A post-possessor adjective in Irish can only have an interpretation where the adjective modifies the possessor, never one where it modifies the head noun:

²⁷This is not true of full or reduced relative clauses, however.

- 68) guth an tsagairt láidir N DP_i Adj_i (Irish)
 voice the priest-gen strong *N_i DP Adj_i
 "The strong priest's voice/ *The priest's strong voice"

The head movement approach to CSN has problems accounting for the fact that adjectives modifying the possessed head noun must immediately follow the noun they modify in Irish, but not in Hebrew.

This fact is easily accounted for in the framework presented here. Let us consider the option of possessed head NPs functioning like predicates in both Semitic and Irish. Like predicates, these Ns raise to functional projections (D°), as was suggested by the various authors noted above, to check inflectional features. The difference between Irish and Semitic lies in what moves. In Irish, the whole N complex including the adjective²⁸ raises just like a complex nominal predicate raises in copular clauses. In Hebrew on the other hand, only the head noun can raise.²⁹ Thus we get the following two constructions (I am omitting here details like the adjunction of *-features*):

- 69) a)

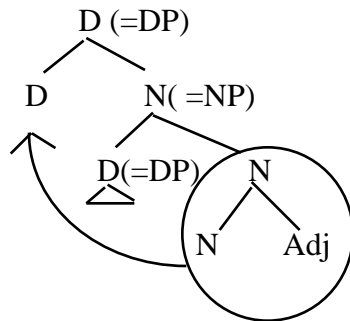

IRISH

- b)

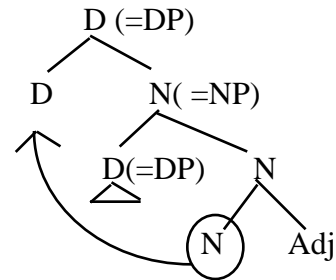

SEMITIC

Duffield (forthcoming) offers a different explanation for these facts. He suggests that the difference in word order results from the timing of the NP movement of the

²⁸I am assuming here, contra the stipulations of Cinque (1993) and Duffield (forthcoming), that APs are generated lower than the NPs that they modify.

²⁹Presumably because in Hebrew, unlike Irish, nominals are not merged with *-features* in the syntax but are base generated with them attached.

Possessor DP for case checking. I refer the reader directly to that work for more details. I present no empirical arguments against Duffield's analysis here. However, I would like to note that the behavior of complex nominal predicates in CSN and in copular constructions in Irish appears to be entirely parallel. It thus seems that the present account, which unifies the two would be preferable to one that uses different mechanisms to account for the fact that in both cases nominals and their complements (complex predicates) are appearing in a position associated with head-movement.

6.7 A few potentially related phenomena.

In section 6.6, we saw data from Irish and Tagalog that provided clear cut support for the view of phrase structure expressed in this chapter. In this section, I consider a few additional examples which might potentially be dealt with using the system described here. These examples differ substantially from the Irish and Tagalog facts. They do all have, however, the characteristic that they argue for a looser "derivative" notion of phrase and head than that available under pre-BPS assumptions.

The facts discussed in this chapter differ from the ones in 6.6 in that the mismatch between X° and XP is not uniformly a syntactic one. In these cases the mismatch seems to occur between how the p-markers are treated by the syntax and the morphology. More specifically, in each of the following cases, the syntax treats a p-marker as either an X° or an XP, but the morphology treats the same p-marker as a different type. The examples we will look at are the Dutch Resultative construction, Yiddish OV constructions, Yoruba derived nominals, and Modern Persian (Farsi) nominals. Foreshadowing slightly to the discussion, we will see that the grammar cuts the mismatches in the following ways:

	Syntax treats as	Morphology treats as
Dutch Resultatives	X° and XP	XP
Yiddish OV orders	XP	X° (mostly)
Yoruba derived nominals	X° and XP	X°

Farsi *Ezafe* construction

X°	XP
-----------	----

This then is fundamentally weaker evidence than that from Irish and Tagalog. It is, however, without a doubt, evidence that we must revise our notions of X° and XP to derivative ones.

6.7.1 Dutch Resultatives

Neeleman and Weerman (1993), present some interesting facts from resultatives³⁰ and particles in Dutch. In Dutch, like German, verbs in embedded clauses raise rightwards to an inflectional head:

- 70) ... dat Jan het meisje t_i wil opbellen_i
 that J the girl wants up-phone
- 71)

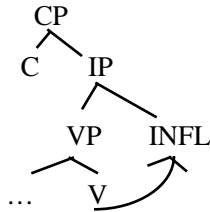

They note that both resultatives and particles show strong adjacency with the verb that embeds them

- 72) a) dat Jan het meisje vaak opmerkte
 that John the girl often up-noticed
- b) *dat Jan het meisje op vaak merkte
 that John the girl up often noticed
- 73) a) dat Jan de deur vaak groen verfde
 that John the door often green painted
- b) *dat Jan de deur groen vaak verfde
 that John the door green often painted

To explain this, they claim that both resultatives and particles raise with the verb to the inflectional head. They claim this is a result of the fact that the verb and the resultative or

³⁰See also Hoekstra (1988), Rothstein (1983) Williams (1980, 1983a 1994) Stowell (1983, 1991) Napoli (1989) for a discussion of the structure of resultatives and Di Sciullo and Williams (1986) for a discussion of a different treatment of complex predicates.

particle have formed a complex X° . For particles this is unproblematic, particles themselves are X° s and thus can be adjoined to the verb (or base generated there-adjoined):

74)

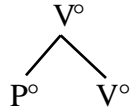

particle construction

For resultatives, on the other hand the situation is more complex. Resultatives don't pattern like X° s in many respects. In fact, they are clearly phrasal in some respects. For example, they can have specifiers and complements:

75) dat Jan de deur [prachtig groen met rode stippen] verfde
 that John the door beautifully green with red dots painted

Resultatives in Dutch have much the same distribution of as nominal predicates in Irish. They appear in a position associated with X° s, but are clearly phrasal in other regards. Neeleman and Weerman (1993) suggest the solution lies in the option of allowing syntactic adjunction of XPs to X° s for resultatives

76)

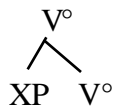

resultative

This is not a terribly attractive revision to the theory, it does however nicely capture the distribution of resultatives in Dutch.

These facts could be accounted for by the same mechanisms proposed for Irish nominal predicates. Resultative predicates affect the temporal interpretation of the verbal predicate they modify; they represent the end-point of the action involved. Given this then, it is not unreasonable to assume that they can merge with a V° to form a more complex V° for the purposes of checking tense features. Like the Irish facts above, the fact that this

complex unit is an X° follows directly from its behavior as an X° , it undergoes head-movement for feature checking. This is consistent with the bare theory discussed above. There are, however, problems with such a view. For example, the resultative+V constituent never moves as a unit to second position. Clearly more work needs to be done here to explain this.

6.7.2 *Yiddish Stem and Particle constructions and Periphrastic Verbs*

Gold (1994) presents some data from Yiddish that is the complement set to that of the Dutch and Irish examples. Yiddish shows several constructions that, for reasons of morphology and semantic composition must be generated as complex words, but behave like phrases with respect to the syntax. These are the particle-verb constructions, the stem construction and the periphrastic verb constructions³¹. Gold claims that in all of these constructions the structure of the verbal element is like that in (77):

77)

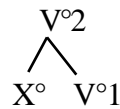

This is a morphologically complex verb. Her evidence for this comes from several sources. First, these constructions all have the reverse order of head and predicate to the rest of Yiddish. Yiddish, like English and unlike German, is a left headed language; complements appear to the right of participles:

78) ix hob gezen dem epl
I have seen the apple
"I saw the apple"

In the constructions considered by Gold, however, the complement appears uniformly to the left of the participle:

³¹Gold also claims the passive in Yiddish follows this pattern. Due to the complexity of her account of these facts, I will not summarize them here.

- 79) a) ix bin **arayn**+gekumen (particle construction³²)
I am in+came
"I came in"
- b) er hot **moyxl**+geven (periphrastic verb)
he has moyxl+been
"He forgave"
- c) zi hot **en+efn**+geton di oygn (stem construction)
she has an open done the eyes
"She suddenly opened her eyes"

The meaning for particle and periphrastic constructions is non-compositional; the meaning of the subparts does not necessarily add up to the meaning of the whole. Take, for example, the Yiddish particle verb *oyfhern* 'cease'; this word is made up of the particle *oyf* 'on' and the verb 'hear'. There is no sense in which this is compositional. This is evidence that these things are, in some sense, single words³³. With respect to certain phonological rules, these constructions behave more like words than phrases. In Yiddish, phrases, primary stress can fall on both words:

- 80) ix bin **néxtn** gekúmen
I am yesterday came
"I came yesterday"

In the particle construction, there is a single primary stress, which falls on the particle:

- 81) Ix bin **aráyn**+gekùmen
I am in-came
"I came in"

The combination of the particle plus the participle can also be the input to derivational morphology as seen in (82) (see also the discussion of Yoruba below).

- 82) arayn+brexn der araynbrexer
into+break the burglar

No elements may intervene between first element and the participle in the periphrastic verb construction:

- 83) *hot zayn tate raxmones **af im** gehat
has his father pity on him had
"so his father had pity on him"

³²Gold uses the term "adverbial complement" rather than particle to refer to these constructions.

³³See, however, Marantz (1995b) for a discussion of how non-compositionality of meaning in idioms does not necessarily correlate to "word-hood".

On the basis of all of this and much more evidence, Gold concludes that in many respects these elements must behave like X° s. She notes, however, that in many respects these must be phrasal elements as well. First, the first element in the stem construction looks suspiciously like an indefinite NP³⁴:

- 84) *zi hot en efn* geton di oygn (stem construction)
 she has an open done the eyes
 "She suddenly opened her eyes"

More importantly, however, with respect to head-movement the lexical verb and the first element must act like independent units. In all three constructions the first element is left behind when the verb undergoes raising:

- 85) a) *ix kum_v* [*arayn t_v*] (particle)
 I come in
 "I come in"
- b) *zi vert_v* [*nitsl t_v*] (periphrastic)
 she becomes rescued
 "She is rescued"
- c) *gib_v* [*a kuk t_v*] (stem construction)
 Give a look!
 "take a look"

The ability of constituents to undergo movement is a property normally associated with phrases. Here then, we have a case where the morphology and the lexicon treat a p-marker like an X° , but the syntax treats it like an XP. This is clearly an example of a situation where phrasal status is determined by behavior rather than vice-versa..

6.7.3 Yoruba derived phrasal nominals

Pullyblank and Akinlabi (1988) present some data from Yoruba where phrases behave like X° s. They note (after Eḱundayo 1976, 1977) that there is a set of derivational nominalizers which seem to take syntactic phrases as inputs. These are *a-*, *o/o-*, *i-* and phrase reduplication. Examples are seen in (86, 87, 88, 89).

³⁴They cannot, however, take adjectival modifiers. See Gold (1994) for arguments against these elements being NPs in argument positions.

- 86) a) abẹ
a+be
"er"+razor
"cut"
- b) ata
a+ta
"er"+sting
"Pepper"
- c) adémi
a+dé+omi
"er"+cover+water
"one who covers water"
- d) apeja
a+pa+eja
"er"+kill+fish
"fisherman"
- e) amòwéékà
a+mò+iwé+kà
"er"+know+book+read
"one who knows how to read"
- f) ajómọ̀şòwòmájómọ̀kéréòkodélé
a+jé+òmọ̀+şe+òwò+má+kó+èrè+dé+ilè
"er"+allow+child+make+trade+NEG+gather+harvest+reach+house
"one who lets you work but does not let you reap your harvest"³⁵
- 87) a) òmùtí
o+mu+òti
nom+drink+spirits
"drunkard"
- b) onímótò
o+ní+mótò
nom+have+car
"car owner"
- 88) a) jagunjagun
jà+ogun+REDUP
fight+war
"warrior"
- b) bẹ́ríbẹ́rí
bẹ́+orí+REDUP
cut-off+head
"executioner"
- c) şèbàjẹşèbàjẹ
şe+ibàjẹ+REDUP
do+badness
"evildoer"
- 89) a) ìbínú
ì+bí+inú
nom+annoy+stomach
"anger"
- b) ìnàwó
ì+ná+owó
nom+spend+money
"ceremony/expenditure"
- c) ìfẹşèkólẹ
ì+fi+şẹ+kó+ilẹ
nom+put+foot+entangled+ground
"walking away dejectedly"

These words have properties associated with both phrases and heads, exactly as is predicted by the bare theory. First, let us see how these elements behave like phrases. We'll see that they have the configurational properties of syntactic phrases. In dyadic verb constructions the second object is marked with the case marker *ní*:

³⁵ used derogatorily for women who dupe/cheat men

- 90) Tolú fún mi **ní** bàtà
Tolu gave me case shoes
"Tolu gave me shoes"

When such constructions are nominalized the *ní* marker is obligatory.

- 91) afúnn**ní**bàtà (*afúnníbàtà)
a+fún+ɛni+ní+bàtà
"er"+give+someone+case+shoes
"One who gives shoes"

Since case markers are obligatory in these constructions it appears as if at some stage in the derivation they behaving like units undergoing computation in the syntax. Similar evidence comes from the fact that nominalizations can occur to serial verb constructions, a clearly syntactic phenomenon:

- 92) Akin jẹun sùn
Akin eat sleep
"Akin ate before sleeping"
- 93) ajeunsùn
a+jeun+sùn
"er"+eat+sleep
"One who eats before going to bed"

Finally, these nominalizations can include relative clauses:

- 94) apejatiòdún
a+pa+ɛja+tí+kò+dùn
"er"+kill+fish+rel+neg+delicious
"person who catches fish that are not delicious"
- 95) ajeuntíòdáa
a+jeun+tí+kò+dára
"er"+eat+rel+neg+good
"person who eats what's bad"

As Pullyblank and Akinlabi (1988) note, these alone might be reasons to treat these constructions as phrases rather than words. There are several reasons to believe, however, that these really are words, rather than phrases. For example, much like the Irish case mentioned above, extraction from these constructions are illicit:

- 96) *[tikɛ̀tì]; ni mo rí [ají []; lɔ̀wɔ̀mɔ̀dɛ́] l'òjà
ticket that I saw person-who-steals-ti-from-children at the market
"Its a ticket that I saw a stealer of from children at the market"
(from ajítíkɛ̀tìlɔ̀wɔ̀mɔ̀dɛ́)

Similarly, pronouns referring to some element outside the nominalization are disallowed:

- 97) *ajítíkẹ̀tílówórẹ̀
'person who steals tickets from him/her'

Syntactically, then, these p-markers behave both like X° s and like XPs. From a morphological perspective, there is also evidence that these items are behaving like X° s rather than phrases. For example, they can be reduplicated—a feature of words rather than phrases. Similarly, the formation of these constructions can be blocked by the presence of an already existing synonymous word.

The Yoruba case discussed here, then is parallel to those discussed above, we have an element that in some ways behaves like an X° and in others like an XP. This is to be predicted under the bare theory, and the theory of morphology discussed above. The difference between languages like Irish and Yoruba is that the terminal elements of these p-markers in Yoruba can be treated as morphologically non-independent lexical items (i.e. affixes), thus forming a single morphological unit.

6.7.4 *The Modern Persian Ezafe construction*³⁶

Ghomeshi (1994, 1995, forthcoming) presents some interesting data which follows from the bare theory of phrase structure. She claims that the *Ezafe* construction, (seen below in example (98)), is an example of a construction built in the syntax, by principles normally applying in the syntax, but which has some of the properties of an X° category. *Ezafe* is used to link modifiers to a head noun. In the examples below the *Ezafe* marker is glossed EZ following Ghomeshi.

³⁶My thanks to Jila Ghomeshi helpful discussion in preparing this section.

- 98) a) Shahr-e bozorg-i
city+EZ big+inde
"a big city"
- b) âqâ-ye qomeshi
sir+EZ Ghomeshi
"Mr. Ghomeshi"
- c) xordan-e âb
drink+EZ water
"the drinking of water"
- d) âb-e xordan
water-EZ drink
"Drinking water"

Ghomeshi notes that the subconstituents of this construction have a number of properties associated with phrases. For example, like phrases, and unlike compounds they have phrasal phonology; they take more than one stress. Regular compound nouns also never show the *Ezafe* marking:

- 99) a) âb portoqâl
water orange (compound)
"Orange Juice"
- b) âb-e sib
water-EZ apple (Ezafe)
"apple juice"

Unlike subconstituents of phrases, on the other hand, the modifiers in *Ezafe* construction cannot themselves be phrasal³⁷, they must be bare heads:

- 100) a) *kif-e in charm
bag+EZ the leather
"bag (made) of the leather"
- b) *mard-e negarân bache-ha-shi-i
man -EZ worried child+pl+poss+indef
"A man worried about his children"

To account for this kind of fact, Ghomeshi proposes that subconstituents of the *Ezafe* construction are formed in the syntax rather than in the lexicon, but are formed into a

³⁷The exceptions to this are PPs and Genitive NPs, see Ghomeshi (forthcoming) for more discussion. Briefly, she argues that the PPs in this construction are really X°s and that the Genitive NPs are in fact in a specifier position, and are not adjoined to an X° category.

complex base generated X° category (for a contrasting view, see Samiiian (1983, 1994).

This is schematized abstractly in (101):

101)

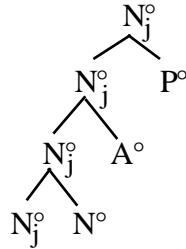

Evidence for this approach comes from the behavior of the indefinite clitic *-i*. This clitic attaches to heads and not to phrases. For example, it attaches to the head of the following appositive structure, not the whole phrase:

102) ketâb-**i**, bozorg-o qermez
 book+indef big+and red
 "a book, big and red"

Similarly, it appears on the head noun of a restrictive relative clause construction, not on the whole phrases:

103) ahmed-**i** [ke diruz âmad] injâ-st
 Ahmed+indef that yesterday came here+3s
 "The Ahmad who came yesterday is here"
 (as opposed to the one who came today)

In the *Ezafe* construction, the *-i* clitic attaches to the final modifier of the construction:

104) a) [ketâb-e bozorg-e qermez]-**i**
 book+EZ big+EZ red+indef
 "A big red book"

Since the indefinite clitic normally attaches to X° s, it follows that the *Ezafe* construction constitutes a single X° category, which the indefinite clitic may target.

Ezafe constructs, then, are constructions that have both properties of X° and phrases. They are entirely predicted by the theory sketched above, which makes no predetermination of X° and XP status.

6.8 Conclusion

In this chapter, I've attempted to show, following Chomsky (1994, 1995b), that the notions XP and X° are not primitives of the grammar, rather they are artifacts of how a p-marker behaves in the grammar. Restrictions on how a p-marker behaves should follow from other restrictions on the grammar, such as the restriction in English that nominal predicates cannot bear tense inflection. In Irish, this restriction does not hold, thus accounting for the X° -like behavior of an apparently phrasal constituent. Similar evidence from Irish construct states, Yiddish, Dutch, Tagalog, Modern Persian, and Yoruba supports this conclusion. Obviously, much research remains to be conducted. Left open in this chapter, for example, is the question of exactly what properties for any given language determine whether particular p-markers have XP- or X° -like properties. This kind of question will be the focus of future research.

Chapter Seven Other theories of *be* word order alternations

7.0 Introduction

In part two of this thesis (chapters 4-6) we looked at the kinds of *be* sentences in Modern Irish. In particular, we have seen that Irish has both a verbal *be*, which is found primarily with stage level predicates, and a non-verbal construction, which is found primarily with individual level predicates. In chapter 4 I showed that, contra Doherty, the stage/individual level distinction does not suffice for distinguishing the verbal from the non-verbal constructions. Instead, I suggested that the distinction lies in what elements are allowed to bear inflectional features and undergo head movement. In chapters 5 and 6, I looked at the word order alternations shown in (1)

- 1) a) Is *dochtúir* (í) **Beverly Crusher**
C doctor (her)
'Beverly Crusher is a doctor'

- b) Is é **Jean Luc Picard** *an captaen*
C him the captain
'Jean Luc Picard is the captain'

There, I claimed that the word order alternation seen here reflects an underlying difference in argument and predicatehood. In particular, I claimed that the order in (1a), which is predicative, has the attributive NP functioning directly as a predicate and raising to the

highest inflectional position for feature checking. This is evidenced by the placement of the agreement morpheme, which follows the predicative NP, just as it would follow a tensed verb. As discussed in chapter 6, this raising occurs independent of whether or not the nominal predicate is complex. In contrast, I claimed that (1b), an equative, has a different structure, where both the overt NPs in the sentence are functioning as arguments, as evidenced by the fact that they both follow the agreement morpheme. I claimed that the predicate in such clauses is a head-moving abstract predicate COP, the realization of which is expressed in the obligatory agreement morphology.

The alternation seen above is, at first glance, very similar to an alternation found in modern English. Consider (2):

- 2) a) John is a doctor
- b) *A doctor is John
- c) John is the doctor
- d) The doctor is John

Many authors working on copular constructions have noted the strong asymmetry seen between predicative and equative NPs in (2). In equative constructions (like 2c&d) the two NPs are reversible in order; in predicatives (2a&b), on the other hand, the two NPs cannot be reversed. There are two schools of thought on how to approach these facts. One view which we will call the *Multiple Be Analysis* (MBA), is like that discussed above for Irish in chapters 4-6. That is, there are two kinds of "be" constructions, one for equatives and one for predicatives, and these two differ in their argument structure. This view was proposed in philosophical works like Russell (1919) in the Fregean tradition, and is the approach adopted by Akmajian (1970), Higgins (1973), Vinet (1993), Zaring (1993), Rothstein (1987) and Rapoport (1987). This is schematized using my notation in (3):

3) *Multiple be Analysis (MBA)*

There are two kinds of copular structures:

1) **Predicative Structures** (where NP2, the attribute, is predicated of NP1, the subject. NP1 is thus attributed as the recipient of the property represented by NP2.) These are semantically represented as follows:

NP2(NP1)

2) **Equative Structures** (where two NPs are related as being approximately equal) These are represented as follows:

COP (NP1, NP2)

In recent work several authors including Partee (1986), Longobardi (1983), Heggie (1988), Moro (1991, 1993), Heycock (1991, 1992, 1994), Guéron (1993), Rouveret (forthcoming), Déchaine (1993), DeGraff (1992) and Zwart (1992) have denied the existence of equative constructions, following observations of Jespersen (1924), Montague (see Dowty, Wall and Peters (1981)) and Ruwet (1968). They all claim that there is no natural language equivalent to the logical '=' (EQUALS) relation. They claim that both predicatives and equatives show asymmetries between the two NPs in copular constructions. These asymmetries are assumed to follow from an underlying subject/predicate distinction to be found in both equative and predicative constructions.

This is the *Unified Be Analysis*:

4) *Unified Be Analysis (UBA)*¹

There is only one kind of be construction:

NP2(NP1)

Proponents of the UBA claim that the facts above in (2) (concerning reversibility) do not reflect an underlying distinction between equatives and predicatives, but rather follow from other facts. They claim, in particular, that the apparent reversibility of arguments in equative sentences is illusory; there is a strong asymmetry between the two NPs with

¹In much of the literature the UBA is often called the *Predicate Raising* analysis (e.g. in Heycock 1991,1992,1994) and in Moro (1991, 1993). I have chosen to adopt the term *Unified Be Analysis* (following Heggie 1988) for two reasons. First, terminology is immediately more reminiscent of the crucial difference between the two approaches; the *Unified Be Approach* has only one "to be" construction, whereas the MBA has more than one "be". Second, the term "predicate raising" could equally apply to the head-movement of non-verbal predicates that I discuss in chapters 4-6 as to the movement of predicates to specifier positions as proposed by the proponents of the UBA. To avoid this ambiguity, then, I have adopted this somewhat non-standard terminology.

respect to extraction. Consider two sentences in (5): (5a) is typical of what Moro calls a *canonical* order (where the notional subject is in first position); (5b) is an example of a *reverse* (or *inverse*) order where what he calls the "predicate" is in initial position:

- 5) a) A picture of the wall was the cause of the riot canonical
- b) The cause of the riot was a picture of the wall inverse

Heycock defines inverse copular constructions as follows:

The inverse copular construction is characterized by the occurrence of an initial DP being used attributively and a postcopular DP used referentially.

Moro (1991, 1993) notes that extraction out of the second NP in these two constructions is not symmetrical²:

- 6) a) Which riot do you think a picture of the wall was the cause of
- b) *Which wall do you think the cause of the riot was a picture of

To account for these facts, he claims that the underlying structure for both these sentences is (7):

7)

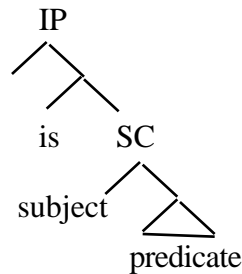

where "cause of the riot" is the head of a small clause with "A picture of the wall" serving as its subject. In canonical structures, the subject raises like a normal subject NP to its case position in the specifier of IP:

- 8) [IP [A picture of the wall]_i [[INFL was] [SC t_i [the cause of the riot]]]]

²I would like to point out at this stage that not all English speakers agree on these judgments. I and a number of native speakers I have talked to only consider (6b) to be questionable rather than ungrammatical. Speakers seem to vary wildly with respect to their judgements on these sentences. In an informal poll of 5 linguists no one was able to agree on what was grammatical and what was not. For the purposes of this chapter, and for the sake of argument, I will adopt Moro and Heycock's judgements on these kinds of sentences. I do so, however, only for the sake of consistency with established literature and only under protest.

In reverse constructions, however, it is the predicative head of the small clause that undergoes head movement to the specifier of IP.

9) IP[The cause of the riot]_i [[INFL was] [SC [a picture of the wall] t_i]]]

The cause of the extraction asymmetries is due to the fact that any extraction out of a subject NP will result in a subjacency violation (this claim will be discussed below in more detail).

The UBA, then, is an account of copular word order alternations that makes use of movement to specifier positions rather than head movement. The reductionist or minimalist might want to use this to account for the Irish word order alternations. However, while this approach may seem particularly attractive in light of its relative simplicity, I show in this chapter that it simply does not refer to the same phenomenon as the Irish copular alternations seen in this thesis. I claim that the inverse/canonical distinction is found in Irish, but only as a subcase of the construction I have described as "equative". The predicative/equative split is simply a word order alternation of a greater order than the canonical/inverse order discussed in the UBA literature. I show that the kind of asymmetries that proponents of the UBA have used as evidence for their approach can be simply reduced to subject/object asymmetries reflected in the theta marking properties of the abstract COP rather than being reflective of a predicate/subject asymmetry. This allows me to account for the various orderings of the Irish predicate/equative distinction while still explaining the behaviour of inverse and canonical structures in languages like English.

7.1 "Unified" theories of copular constructions

7.1.1 Heggie (1988)³

The first generative syntactician to propose that there is no equative/predicative distinction was Heggie (1988). She noted that in many ways the "attributive" NP in equative constructions⁴ behaves more like a predicate than like other referring NPs. She

³more discussion of Heggie (1988) can be found in Chapter 8.

⁴or "pseudo equatives" as Heggie calls them.

presents evidence from French predicate clitics, reflexive intensifiers, discourse and control to support this contention. In order to account for this, she suggests that the structure of inverse construction involves the raising of the subject NP to the specifier of IP and the raising of the predicate into the specifier of CP, with raising of the copula into C° as an instantiation of subject-aux inversion:

10)

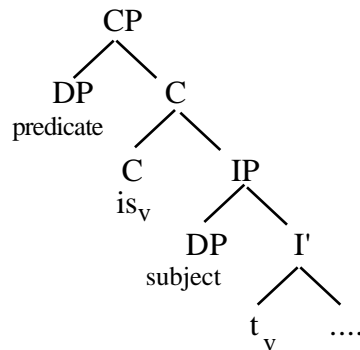

In the canonical construction, like the inverse, the subject DP occupies the specifier of IP. The predicate DP, on the other hand, remains in its D-structure position as the head of a small clause. The copula remains in INFL.

Rather than pursuing this approach and seeing how this approach accounts for the inverse/canonical asymmetries, I will simply turn to the extensive evidence against Heggie's analysis. As noted by Heycock (1992), having the predicate raise to the specifier of CP and the verb raising to C° makes certain predictions not borne out by the data⁵. For example we predict that we will not be allowed the inverse copular structure in indirect questions. This is false:

11) People are speculating about whether the culprit is John

We also predict that we will never be allowed inverse orders when subject-aux inversion has occurred. Again, this is false:

⁵These predictions are all based on the assumption that CP recursion (see Iatridou and Koch 1992) is not available to the grammar.

12) Was the culprit John?

Finally, we predict that only one auxiliary in multiple auxiliary constructions will occur between the two DPs. Once again, this is false:

13) The culprit may have been John

Heycock concludes then, that Heggie's analysis suffers from serious empirical flaws.

Irish copular constructions also bear on this issue. Irish has no subject-aux inversion. Instead, yes-no questions are indicated with a complementizer particle. Given a raising to CP analysis of inverse/canonical alternations, we predict that "inverse" orders should only occur with DPs preceding the *Is* particle. This is a false prediction. Inverse constructions in Irish have both NPs following the complementizer particle:

- 14) a) Is é Seán an Clingeán
C agr John the Klingon
"John is the Klingon"
- b) Is é an Clingeán Seán
C agr the Klingon John
"The Klingon is John"

Given this fact, we can easily reject a raising to C(P) analysis of the inverse/canonical distinction. Other UBA proposals are not so easily dismissed; these are the accounts of Moro (1991, 1993) and Heycock (1991, 1992)

7.1.2 Moro (1991, 1993), Heycock (1991,1992)

Moro (1991), as mentioned above, was the first to note that inverse and canonical copular structures differ in their extraction properties. He noted that extraction of (15) and extraction from (16) the inverse construction demonstrates that the two NPs in equatives are not necessarily "equal", since they show asymmetries (data from Heycock 1993). Extraction from the post-copular NP of canonical structure (i.e. from a predicate) is grammatical, as in (15a & 16a), but extraction from a post-copular NP in an inverse sentence (i.e. from a subject) is ungrammatical (15b, 16b):

- 15) a) Which of the themes do you think that phrase of music was?
 b) *Which phrase of music do you think one of the themes was?
- 16) a) What do you think the photograph of the president may have been the cause of?
 b) ?*What do you think the cause of the riot may have been the photograph of?

He also notes that the inverse order is almost never found in small clauses⁶:

- 17) a) I consider John the culprit
 b) *I consider the culprit John

To account for these facts he proposes (as does Heycock 1991, 1992 in related work) that the structure of a canonical sentence involves straightforward raising of the subject to the specifier of IP⁷, leaving the attributive NP in the small clause. In the inverse construction, on the other hand, the predicate NP raises to the specifier of IP, and the subject NP remains in the small clause:

18)

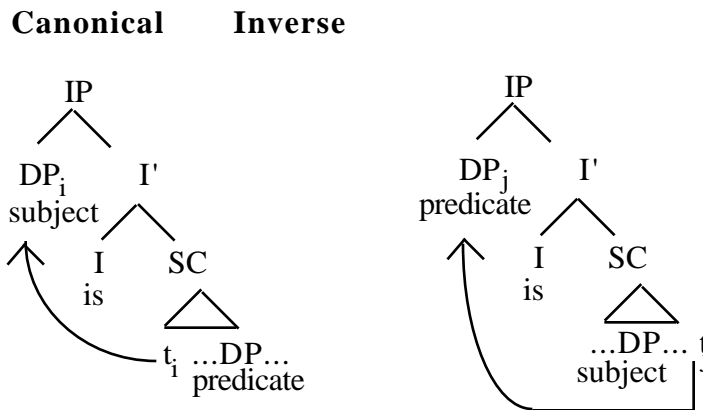

This provides a straightforward account of why the inverse order is disallowed in small clauses. Small clauses contain no inflectional material, so there is no place for the predicate to raise to; it must stay in its base position in the small clause. An account of the extraction asymmetries follows from his definition of barriers and subjacency, which we need not detail here. Roughly speaking, his account is that since the subject DP will never be theta marked by a governing head, it is an island for extraction. Thus any attempt to extract out

⁶See Heycock (1994) for a discussion of the limited set of cases where inversion does seem to occur in small clauses, and for an account thereof.

⁷Heycock (1991, 1992) gives a very similar analysis to Moro, differing from him in that the movement of the predicate to the specifier of IP is A movement, rather than A' movement as Moro claims. In order to account for the lack of subjacency violations in predicate movement, the predicate must land in the specifier of VP before raising to the specifier of IP.

of the post-copular subject position will result in a subjacency violation. This kind of account is unavailable under a story that holds the two DPs in equative clauses to be equals.

7.2 Against a UBA account of Irish

With the relative simplicity and explanatory adequacy of Moro and Heycock's story in mind, we can ask whether such an account is easily extended to the Irish word order alternations discussed in chapter 4-6. Moro's account is especially intriguing since the evidence he presents for his analysis, the extraction asymmetries, are strongly reminiscent of the extraction facts I have used to argue for the X° status of complex nominal predicates. It is an obvious question as to whether these two phenomena are really one and the same. In this section, I argue that they are most definitely not the same. I then argue that by slightly modifying Moro and Heycock's analysis — so that we have two "be" verbs, one for predicative constructions and one for equatives — but claiming that the two arguments are asymmetric, we can account for the extraction facts discussed above. In particular, I claim that the two NPs in equative constructions do not differ in terms of their argument/predicate status (they are both arguments), but differ in terms of their theta role assignment and underlying argument position. Attributive NPs will be generated as complements to the COP head, and attribute recipients will appear in the specifier. The thematic distinction here — reflected in the structural positions of the two NPs— will yield the same structural asymmetries captured by Moro and Heycock's accounts, without resorting to the empirically problematic UBA.

There are really three issues at stake here. First, we must see if the English canonical/inverse alternations are really of the same type as the Irish word order alternations. If they are not, then does the solution lie in a MBA type analysis? Finally, if there is evidence for the MBA, we must then account for the structural asymmetries that

opponents of the MBA have posited to argue against it. This is the approximate organization of this section.

7.2.1 *Why the Irish word order alternations are not canonical /inverse distinctions*

There is overwhelming evidence that the word order alternations in Irish cannot be reduced to the canonical/inverse alternations. First, we have issues of headedness. As argued in chapters 2 and 3. Irish is a strictly left-headed language and its specifiers are always to the left. This is confirmed by the structure of small clauses in Irish which are consistently Subject then Predicate in word order:

- 19) agus é i gCeannada
and him in Canada
"and him in Canada"

Were we to adopt a canonical/inverse approach to Irish copular word orders, we would be forced to claim that Irish allowed rightwards specifiers (this is the approach taken in Doherty (1992, forthcoming); see chapter 8 for more discussion). Recall that the word order in Irish predicative clauses — the order that unambiguously does not allow reversal— is Predicate-Subject. If this reflected an underlying order, as is predicted by the canonical/inverse approach to word order alternations, then Irish would have to allow rightwards specifiers in copular constructions:

- 20)

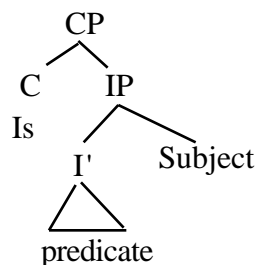

This is inconsistent with all we know about other aspects of Irish syntax and would be highly stipulative. To make matters worse, as we saw in chapter 3, nothing in Irish ever

occupies the specifier of the highest inflectional head, thus to have the subject appearing in this position in copular clauses would be highly unlikely.

Next we have the problem of positioning the agreement morpheme. Recall from chapter 5 that in the predicative order (21), the optional agreement morpheme appears between predicate and the subject. In equative constructions (22), on the other hand, the agreement morpheme appears before both NPs:

- 21) a) Is + predicate +agr_i + subject_i
 b) Is ríomhaire é leifteanantcheannasaí Data
 C computer agr Lieutenant-Commander Data
 'Lieutenant Commander Data is a computer'
- 22) a) Is + agr_i + subject_i + attribute
 b) Is é Ceannasaí Radhcár an t-amadán
 C agr Commander Riker the fool
 'Commander Riker is the fool'

The position between complementizer head and agreement morphology, as discussed extensively in previous chapters, is a privileged one in Irish syntax. Only tensed predicational material may appear there. Arguments always follow agreement morphology. The account given above, where nominal predicates head-raise to an inflectional head, accounts easily for these facts. In predicative constructions, the nominal predicate undergoes raising to the highest inflectional head, just like a verb. In equatives, both NPs are arguments, thus remain lower than the agreement morpheme. Any account given in terms of NP movement of predicates has trouble accounting for the fact that in Irish nominal predicates, but not nominal attributes, precede the agreement morpheme.

An inverse/canonical approach to Irish copular word order alternations also can't account for the special behaviour of complex predicates with respect to extraction and the responsive system. Recall that in predicative constructions constituents of a nominal predicate may not be extracted.

- 23)*Cén Píobaire_j arb [NP amhrán_i [CP^{aL} bhuilfeadh sé_j t_i]](é) "Yellow Sub"
Which piper rel song COMP play.cond he agr
 “*Which Piper is 'Yellow Submarine' a song which he/t_i is going to play”

At first glance this looks very similar to the extraction data presented by Moro (1991, 1993) in favor of his approach. However, closer examination shows that his account simply cannot deal with this extraction fact. First, the extraction in (23) is movement from a predicate (under anybody's definition), not extraction from a subject. Moro's account only explains the lack of extraction out of subjects. Second, Moro's account of ungrammaticality of extraction follows from subjacency. Recall from chapter six, however, that Irish regularly allows subjacency violations, *modulo* a change in complementizer and the presence of a resumptive pronoun:

- 24) Cén Píobaire_j [CP^{aN} mbíonn fios agat i gconaí [CP^{aL} caidé_i a^L bhuilfidh sé_j t_i]]
Which piper COMP be.hab know at.2.s always what_i COMP play.fut. he
 “Which piper do you always know what he will play”

Subjacency, then, cannot be an account of the ungrammaticality of (23). For these two reasons, it is thus clear that Moro's extraction facts and the ones discussed in chapter 6 are different phenomena. Further, his account cannot account for the ungrammaticality of these forms or the behaviour of the responsive system.

The final piece of evidence that the predicative/equative alternation in Irish is not the same thing as the canonical/inverse alternation is the simple fact that Irish also has a inverse/canonical alternation, but only as a subset of the equative construction (26):

- | | | | |
|-----|----|---|-------------|
| 25) | a) | Is captaen (é) Séamus
C captain agr James
"James is a captain | predicative |
| | b) | *Is Séamus (é) captaen
C James agr captain
"*A captain is James" | |
| 26) | a) | Is é Séamus an captaen
C agr James the captain
"James is the captain" | equative |
| | b) | Is é an captaen Séamus
C agr the captain James | |

"The captain is James"

Since Irish has a clear equivalent to the canonical/inverse construction, it thus follows that this alternation cannot be the same as the Irish predicative/equative alternation.

7.2.2 Evidence in favor of the MBA^{8,9}

We have now seen that the predicative/equative alternation of Irish cannot be reduced to Moro's inverse/canonical alternations. Given this we can ask if there is a UBA account of the equative/predicative alternation independent of the canonical/inverse facts. I believe that there isn't, and that the simpler analysis of Irish copular constructions involves more than one "be" construction. Let us recall the basic fact:

Irish has two distinct word orders for predicatives and equatives:
predicatives: C pred agr subject
equatives: C agr subject attribute

This alone is reason enough to adopt the MBA. There are two very different constructions for the two readings in Irish. It thus follows that there are two distinct underlying argument structures. This is straightforwardly supported by the fact that the order corresponding to direct predication by the NP (i.e. NP(NP)) has an order exactly equivalent to tensed verbal clauses (with the NP predicate appearing in the privileged position between the complementizer and agreement).

Zaring (1993, 1994) presents evidence from Welsh pseudoclefts against the UBA. She claims that predicational readings are allowed with any of the following constructions¹⁰ (where focus is the distinguishing characteristic among them):

⁸For a comprehensive survey of kinds of copular clauses in the various Celtic languages see Hendrick (1994 and forthcoming)

⁹See Rothstein for arguments in favor of the MBA from English and for arguments in favor of the approach to theta marking in copular clauses taken in this thesis

¹⁰See also Rouveret (forthcoming) and Hendrick (1994, forthcoming) for discussions of both these constructions and the related ones in Breton.

- 27) a) **Mae** Subject Predicate (no contrastive focus)
- Mae [lle mae Siôn] [yn Llundain]
be where is John in London
"Where John is is in London"
- b) PREDICATE[-N] **mae** subject (focus on [-N] predicate)
- [Yn Llundain] mae [lle mae Siôn]
in London be where is John
"Where John is is IN LONDON"
- c) PREDICATE [+N] **ydy** subject (focus on [+N] predicate)
- [Niwsans iddo] ydy [beth ydy Siôn]
Nuisance to-him be what is John
"What John is is A NUISANCE TO HIM"
- d) SUBJECT **sydd** Predicate (focus on the subject)
- [lle mae Siôn] sydd yn Llundain
where is John be in London
"WHERE JOHN IS is in London"

However, equative readings are only found in the following construction:

- 28) XP^i **ydy** XP^i (where the XPs can be in either order)
- [Yn Llundain] ydy [lle mae Siôn]¹¹
in London be where is John
"Where John is is in London"
(=John is in London)
(The place where John is has the property of being in London)

Since there is a special construction for equative structures¹², Zaring concludes that some version of the MBA is correct (see Rouveret forthcoming for a contrasting view of these facts).

The MBA then, provides a simple, straightforward account of the different constructions used in equative and predicative constructions, facts which cannot be accounted for using the UBA.

¹¹To clarify, this construction is crucially different from (27b) in that the form *ydy* is used instead of *mae*, and is different from (27c) because the predicate is [-N].

¹²She differs from me, however, in believing that this relation is identical to the logical "=" relation.

7.2.3 Accounting for the English inverse/canonical asymmetries

If we adopt the MBA, we might well ask how we can account for the asymmetries brought to light by proponents of the UBA. I will propose that these asymmetries follow from an asymmetry in argument structure rather than from a predicate/subject distinction.

Let us first examine the underlying assumptions of Proponents of the UBA. They all make the assumption that an equative construction must necessarily and by definition be the equivalent of the logical "=" EQUALS relation. In other words, they assume that an equative construction must have a structure like that in (29):

29)

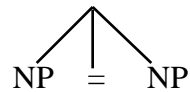

The two NPs are not distinguished structurally, thus are predicted to behave alike. They then make the (somewhat strange) assumption that an asymmetry between two NPs is necessarily encoded in a predication relation between them. For those authors (e.g. Stowell (1981), Moro (1991, 1993) Heycock (1991, 1992)) who believe predication to be linked to argument structure and projection, this distinction is encoded in a small clause structure:

30)

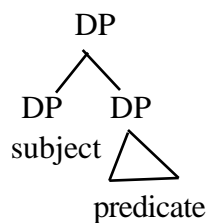

There is a strong structural asymmetry between the two NPs in (30). This structural difference explains the asymmetrical behavior of the two NPs. I believe, however, that an error has been made in conflating two separate issues: i) the predicate/subject relation and

ii) the structural asymmetries between the two NPs in equative clauses. It is not necessarily the case that the structural asymmetries are a result of a predicate/subject distinction. Rather, it is entirely possible that these follow from a difference in argument structure. If we take the view of equatives described above in chapter 5, there is a structural asymmetry between the subject NP and the attribute NP: the subject NP is generated in the specifier of COPP, and the attribute is the complement¹³. (This is presumably correlated with the different theta roles these two NPs bear.)

31)

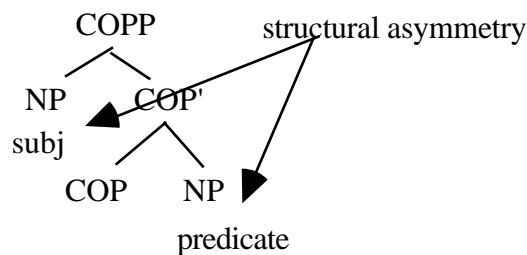

Notice that this view of equatives does not make the claim that the two NPs are "equals" in the logical sense, but instead distinguishes a reading where one NP is predicated of another (predicative constructions) from one where two NP arguments are linked to each other in approximate equivalence by the COP morpheme. This account provides a straightforward analysis of the distribution of Irish copular constructions.¹⁴

7.3 Conclusion

In this chapter, I've attempted to provide evidence that the word order alternations found in Irish copular clauses are not reducible to the inverse/canonical distinction of Moro and Heycock. I further showed that a "single be" analysis (UBA) of Irish fails to account for the distribution of Irish copular constructions. I then claimed that the asymmetries

¹³Notice, however, that this analysis cannot account for some of the asymmetries discussed in Heggie (1988), such as the distribution of intensive reflexives and the behaviour of predicate clitics in French. Accounting for these facts will be the subject of future research.

¹⁴which, in some ways, resembles that of Guéron (1993) who claims that quantificational NPs, not predicates, undergo the canonical/inverse alternation

discussed in the UBA literature can follow from a structural asymmetry reflecting an argument structure (i.e. a specifier/complement) distinction, rather than the distinction between predicates and subjects.

Chapter Eight Other theories of *be*-less copular sentences

8.0 Introduction

In an early work on types of copular clauses, Benveniste (1966b) notes that the copular verb "to be" is in fact a typologically rare phenomenon¹, basically limited to a subset of Indo-European languages and a few scattered exceptions. He notes that "...one could more quickly enumerate the inflected languages that do not have [be-less sentences] ...", than list the ones that do. The class of languages which contain be-less sentences is widespread; it includes languages from practically every language family and from every continent. What is particularly interesting, is that a large number of these languages use a construction similar to the Irish equative which uses an extra pronoun² to mark the sentence as equative. In particular it can be noted that without exception in all these languages this pronoun is obligatory in equatives and optional in predicatives. This is true of such widespread languages as Hebrew, Irish and Haitian Creole. The fact that the identical construction appears in a wide variety of languages means that this kind of construction is one easily accessed by UG. Any account of these facts must necessarily account for all the

¹As opposed to auxiliary verb *be*.

²A different group (for example Russian and some dialects of Arabic and Chinese) seems to use determiners for this function. I will have little to say about these languages here.

languages that have this construction. In this chapter, I will examine a few previous accounts of *be*-less sentences. In particular, I will examine a set of analyses of the extra agreement pronoun which use the notion of lexical government and the ECP (Empty Category Principle³) to account for the distribution. I will show that all such accounts fail for Irish, thus must be rejected. After this, I will present the single theoretical account of Irish, that of Doherty (1992, forthcoming), which I show is not consistent with other aspects of Irish syntax.⁴

8.1 ECP Accounts of *be*-less sentences.

Heggie (1988, 1990) and DeGraff (1992) present ECP analyses of *be*-less copular constructions in Hebrew⁵ and Haitian respectively. In this section, I will sketch out their arguments and then show why these accounts cannot be extended to Irish.

8.1.1 Heggie (1988, 1990)

Recall the facts of Hebrew, which are similar to those of Irish. Hebrew has no verb "to be" in the present tense. Predicative sentences (1) allow an optional agreement pronoun. Equative sentences require this pronoun (2):

- 1) a) Dani more
 Danny teacher
 "Danny is a teacher"
- b) Dani hu more
 Danny 3sng teacher
 "Danny is the teacher"
- 2) a) *Dani ha-more
 Danny the teacher
 "Danny is the teacher"
- b) Dani hu ha-more

³for discussion of this principle see, for example, Kayne (1981, 1984)

⁴A descriptive account of the facts is found in Ó Siadhail (1989) and an old account assuming flat structure is found in Stenson (1981).

⁵Several accounts of Hebrew predate these accounts, for example Doron (1986), Berman and Grosu (1976). For convincing arguments against these approaches see Rapoport (1987)

Danny is the teacher
 "Danny is the teacher"

Heggie (1988, 1990) proposes that the obligatoriness of the pronoun in equative clauses follows from the interaction of several principles. She proposes that referring attributive NPs in equative constructions must move for case reasons. She suggests that the surface position of predicate NPs is the VP-adjoined Constructional Focus position of Rochemont (1986). The structure she proposes is thus seen in (3) (where \emptyset is her null copular verb — roughly equivalent to my COP)

3)

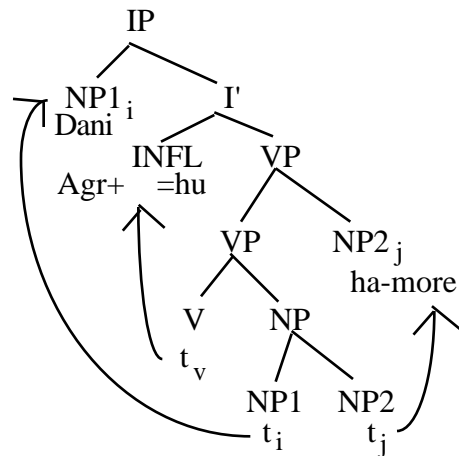

The subject has raised to the specifier of IP for case reasons. The null \emptyset verb raises to INFL, the Predicate NP raises to constructional focus position. According to Heggie the obligatoriness follows as follows:

Assuming the ECP as formulated in Aoun, Hornstein, Lightfoot and Weinberg (1987) where two requirements are placed on a trace — lexical head government at PF and generalized binding at LF — an understanding of equatives can be achieved. ... NP2 does not lexically head govern its trace. This state of affairs forces \emptyset to raise to INFL and undergo lexicalization with AGR so that it may lexically head-govern the trace of NP2 via the trace of \emptyset under V. The obligatoriness of [the agreement pronoun] in equative sentences and its optionality in predicatives can thus be understood in terms of the need for proper government of a predicate trace in the case of equatives.

In other words, the pronoun must be overt in order to lexically head govern the trace of the predicate, and save the sentence from a violation of the ECP.

Heggie's account is simple and straightforward. Unfortunately, however, it is empirically flawed both for Irish and, surprisingly, for Hebrew itself. Recall the basis of Heggie's claim: the pronominal surfaces to serve as a lexical governor of an ungoverned trace. The problem with such an account is that both Irish (McCloskey 1990) and Hebrew (Fox 1994) are languages that strictly use resumptive pronoun strategies for resolving violations of the ECP and subjacency (see chapter 6 above for discussion). To posit that the agreement pronoun surfaces to lexically govern an ungoverned trace completely fails to capture the generalization that Hebrew and Irish consistently use resumptive pronouns to save ECP violations, not some "lexicalization" of abstract heads.

This said, there is an obvious alternative to Heggie's account. This being the possibility that the pronoun is itself a resumptive pronoun (rather than a lexical governor), and that its presence is triggered as a means of making a trace overt, so that it is not subject to the ECP. This approach is the one taken in DeGraff (1992) discussed below in 8.1.2

8.1.2 DeGraff (1992)

DeGraff (1992) is concerned with the distribution of a pronominal⁶ element in Haitian Creole. This pronoun has precisely the distribution we have come to expect. It is completely disallowed with AP and PP predicates, causes slight ungrammaticality⁷ with bare NP predicates, but is obligatory with DP predicates⁸:

- 4) a) *Bouki se malad (cf. ✓ Bouki malad)
Bouki SE sick
"Bouki is sick

⁶Calling this element a "pronoun" is perhaps prejudging the situation slightly. This is especially true since it does not agree in person number or gender with the subject. This case may well be one of those languages that uses determiners to play out the role served by the agreement pronouns in languages like Irish or Hebrew.

⁷In Irish and Hebrew, with indefinite NPs the presence of the pronoun is optional. In Haitian by contrast, it causes mild ungrammaticality. Notice that although this is a different result, the contrast is cut in the same way: pronouns are obligatory in equatives and marginally allowed/or optional in predicative NPs.

⁸This is true of both definite and indefinite NPs (as seen in 4d), in this Haitian also differs from Irish and Hebrew.

- b) *Bouki se anba tab la (cf. ✓Bouki anba tab la)
Bouki SE under table the
"Bouki is under the table"
- c) ??Bouki se doktè (cf. ✓Bouki doktè)
Bouki SE doctor
"Bouki is a doctor"
- d) ✓Bouki se {yon doktè/Aristide}⁹ (cf. *Bouki {yon doktè/Aristide})
Bouki SE DET doctor/Aristide
"Bouki is {a doctor/Aristide}"

DeGraff proposes that the *se* morpheme is simply a resumptive pronoun of the subject NP.

This morpheme is simply present to rescue an ungoverned trace. DeGraff proposes that

Haitian small clauses take the following forms:

- 5) a) [AP subject [A' ...A° ...]]
- b) [PP subject [P' ...P° ...]]
- c) [NP subject [N' ...N° ...]]
- d) [DP subject [DP ...[D'...D° ...]]

DPs are different from all other small clauses in that the subject is adjoined to the phrase rather than occupying the specifier position of that XP. This, he claims, derives the crucial difference between the DP clauses and the others. In AP/PP/NP small clauses, extraction of the subject is legitimate since there is a lexical governor for the trace: the head of the small clause:

6)

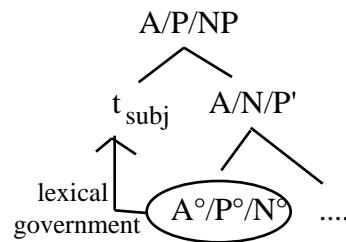

In DPs, however, the trace of the subject lies outside the immediate maximal projection of the head D°. So the D° cannot lexically govern the trace of the subject:

⁹This sentence becomes ungrammatical if a tense morpheme or a negative marker is inserted into the clause. *Se* is always omitted in these contexts. This behaviour is entirely predicted, under my account where *Se* is simply some spell out of a node in tense. A different spell-out of the T node (such a tense particle) would necessarily block the presence of *Se*.

7)

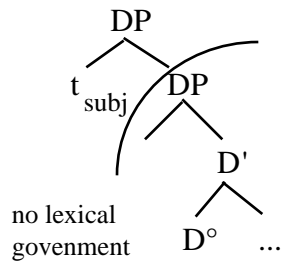

The trace of subject is thus not lexically governed. To rescue this kind of sentence from an ECP violation then, DeGraff proposes that the trace is replaced by a resumptive pronoun in the form of *se*. *Se*, being overt, requires no lexical government, so the structure is rendered grammatical.

Unfortunately, DeGraff's account simply cannot be extended to Irish. This is evidenced by the word order facts of Irish equatives. The Irish equivalents to *se*: *í, é, iad* appear to the left of both arguments:

- 7) Is é Proinseas an Platapas
 C agr Francis the Platypus
 "Francis is the Platypus"

Recall, from chapters 2 and 3, that Irish is a language that is strictly left headed and has its specifiers to the left. This means that the underlying structure of the DP small clause would have to be (under DeGraff's analysis):

8)

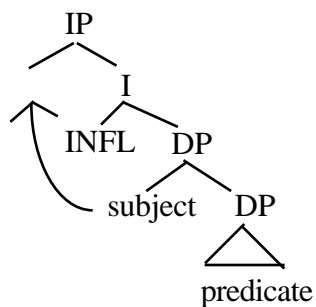

Under such an analysis, we would predict that the extra pronominal would appear after subject NP, in the base position of the subject NP:

- 9) *Is Proinseas é an Platapas
 C Francis agr the Platypus
 "Francis is the Platypus"

This sentence is completely ungrammatical¹⁰. It is completely unclear to me how the subject NP in an equative NP could appear between its own trace and the head of its small clause:

- 10) Is [_{DP} é_i [_{??} Proinseas_i] [_{DP} an Platapas]]
 pronoun Subject predicate

The fact that subjects appear between the so called resumptive pronoun trace of that subject and the predicative NP seems to me to be strong evidence against a resumptive pronoun account of Irish

8.1.3 Section Summary

I have shown here that accounts using the ECP as an explanation for the presence of the extra pronominal morphemes in *be*-less copular clauses are inadequate. This is true whether we consider the pronoun to be a lexical governor (as does Heggie) or a resumptive pronoun (like DeGraff). The only empirical account that seems to adequately account for the Irish facts is the one sketched above in chapters 4-6, where the pronoun is simply a realization of agreement features, either on a nominal predicate head, or as the obligatory realization of the null equative head COP.

8.2 Doherty (1992, forthcoming)¹¹

In this short section, I will quickly examine the ground breaking analysis of Doherty (1992, forthcoming) and show that while I adopt many of his conclusions (see chapters 4-6 for example), the basic principles upon which his analysis are founded are flawed. Therefore my analysis is to be preferred.

¹⁰Under the appropriate reading. Such a sentence could appear predicatively, where "Francis" is a category (i.e. There is a group of creatures called "the Francises", and the platypus is one of them). The meaning of the sentence would then be "The platypus is a Francis". We are concerned here, however, only with the equative reading: "Francis is the Platypus".

¹¹Doherty (1995), however, abandons many of the assumptions criticized in this section. See that work for more discussion.

Let us consider Doherty's basic analysis. He claims that copular clauses differ from verbal clauses in the following ways: (i) the subject of copular clauses is base generated in the specifier of IP, whereas the subject of verbal clauses is in the specifier of the VP (or verbal small clause). (ii) The specifier of IP is rightwards, whereas all other specifiers point leftwards. (iii) In verbal clauses, verbs raise to INFL (and subsequently to C°), but in copular clauses there is no overt head movement. He also assumes that the *Is* morpheme is a combination of INFL and C° heads. These differences are summarized in the following diagram:

11)

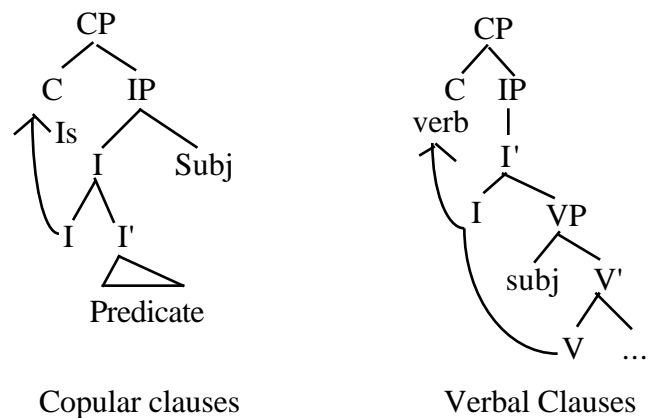

Doherty explains the lack of the agreement pronominals in predicational clauses by claiming that predicational clauses only involve NPs which do not trigger agreement, whereas equatives have DP predicates which trigger agreement¹².

In chapters 3 and 4, I argued against Doherty's view of verbal clauses, and by extension, in chapter 5, I argued that the bulk of Doherty's arguments for his approach (the highest subject restriction) cannot hold under the assumption that VSO order does not derive via raising to C° in Irish. The entire empirical basis upon which Doherty bases his

¹²For more on this kind of distinction see Mandelbaum (1991) and Takano (1992)

analysis then disappears. Further, I have shown how the HSR is easily accounted for in the system proposed here. This aside, there are many problems with Doherty's account.

First we can note that Doherty's account misses a fundamental generalization about all kinds of clauses in Irish. The word order in Irish is consistently complementizer+predicate+agreement+subject. This is true whether the predicate is verbal or not. With verbal clauses, as discussed in chapters 2 and 3, this order is derived via head movement of the verb to an Inflectional head. There is no reason that nominal predicates (even complex ones, see chapter 6) should not be derived using the same mechanism. Doherty is forced to claim that the clausal architecture of copular clauses is fundamentally different from that of verbal clauses. My account, on the other hand, neatly unifies the two clause types and derives language-specific variation from the morphological criteria. My approach to non-verbal predicates is supported via evidence from extraction phenomena and by the behaviour of non-verbal clauses with respect to Ellipsis phenomena.

Next, we can criticize Doherty for his positing of a rightwards specifier for IP. Rightwards specifiers are found nowhere else in the grammar of Irish. This is true both of base generated structures (like small clauses), but also of derived positions like that of the subject position in the specifier of AgrSP. Positing them simply for non-verbal predication seems not only *ad hoc* but entirely inconsistent with what we know otherwise of Irish clauses.

Finally, we have the problem of the equative/predicative word order alternations discussed in chapter 5. Doherty seems to make no structural distinction between the two clause types. This leads to two very problematic considerations. Firstly, Doherty is forced to conclude that the first NP in equatives is the "Predicate" NP, not the subject as I claim:

- 12) Is é Seán an dochtúir
C agr John the doctor
C agr Predicate Subject Doherty
C agr Subject Predicate Carnie
"John is the doctor"

This, of course, misses the generalization that agreement in Irish always follows predicates and precedes subjects. This also makes strange assumptions about what can serve as the attributive NP and what functions as the attribute recipient in equative clauses. Under anybody's assumptions, proper names like "John" are the least predicative of all types of NPs. Heggie (1988) for example notes that there seems to be a hierarchy of what can serve as "attributes" and what can serve as "attribute recipients". Attribute recipients must be to the left of or equal to the attribute on the following hierarchy:

- 13) Deictics > Proper Names > Definite Descriptors > Indefinites
Recipients Attributes

Given this, calling the proper NP "John" in sentence (12) the predicate seems at best counterintuitive and at worst a stipulation. This is compounded by the fact that Doherty's account has the agreement morpheme agreeing with the "predicate" NP instead of the "subject"¹³. This seems completely unmotivated to me. Finally, Doherty's account simply cannot account for the fact that the optional agreement morpheme in predicatives appears to the right of the predicate NP:

- 13) Is platapas é Seán
C platypus agr John
"John is a platypus"

Given all these problems, which are all simply accounted for by the account given in chapters 4-6, it is obvious that Doherty's account is empirically inadequate to the task of accounting for Irish copular clauses.

¹³as admittedly does the analysis in Carnie (1992)

8.3 Conclusion

To summarize the conclusions of this chapter, I've shown that the only previous theoretical account of Irish copular clauses, Doherty (1992, forthcoming) suffers from severe theoretical and empirical problems. I've also demonstrated that accounts of be-less clauses in Hebrew and Haitian, which make use of the ECP to account for the distribution of pronominal agreement morphemes, simply cannot account for the Irish facts. From this, then, we are led to the conclusion that the account sketched in chapters 4-6 is the only empirically adequate one.

Chapter Nine Concluding Remarks

This thesis, as its title implies, has been an attempt at studying the interaction of non-verbal predication with the process of X° movement. Let us take a few pages to review and summarize the varied conclusions of this work.

First, in chapter 3, I presented a new architecture for clausal structure, in order to account for certain facts of Irish word order. This structure is presented in (1)

1)

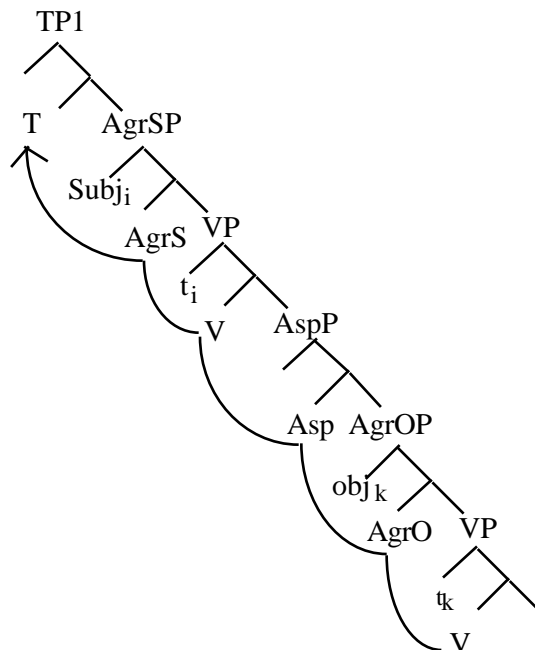

The position of arguments and the verb is also represented in (1). The important conclusion from this chapter is that Irish is a language that uses head-movement of verbal predicates to initial position in order to derive its basic word order.

In part II of the thesis, I looked closely at the behavior of non-verbal predicates in Irish. I presented the following four claims

- i) In many languages, copular non-verbal predication can appear without an verb of any kind, overt or otherwise.
- ii) There is more than one kind of copular construction, i.e. there are both predicative and equative structures and these differ in their argument structure.
- iii) In some languages non-verbal predicates may behave exactly like verbal ones with respect to the syntax of head movement.
- iv) Under certain specific conditions complex, apparently phrasal, nominal predicates may undergo head-movement.

In particular, I claimed that under certain conditions, non-verbal predicates could interact with the operation of head-movement to behave exactly like tensed verbs and raise to initial position in their clause:

2)

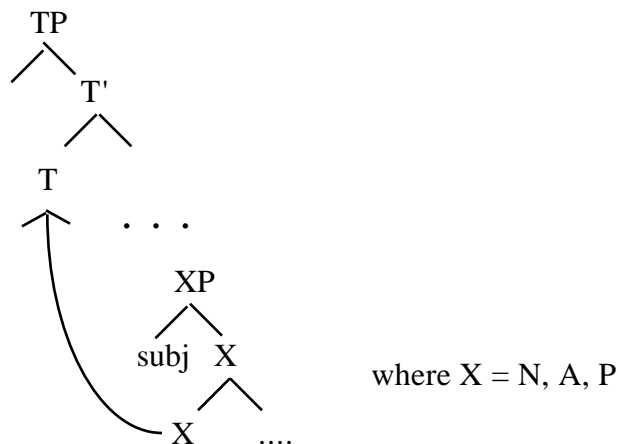

I claimed that even *phrasal* non-verbal predicates can undergo head movement. This, of course, required a serious revision of our notion of what an X° or an XP is. I made the highly surprising claim that there is no primitive phrase/head distinction. I claimed, instead,

that rather than the phrasal or head status of a phrase marker determining its behaviour, the behaviour of the p-marker determines its head or phrase status. Since X-bar status is a derivative notion, I showed that complex nominal predicates can behave like words with respect to head-movement. Evidence from the responsive system and extraction phenomena supported this conclusion.

Finally, I also took issue with several recent proposals that there is a single "be" construction throughout languages. Many authors (Partee 1986, Heggie 1988, Heycock 1991 1992, Moro 1991 1993, DeGraff 1992 among many others), following the Fregean tradition, assume that there is no structural difference between equative and predicative constructions. I presented extensive distributional evidence that we must have both the argument structure in (3a) (for predicatives) and the one in (3b) (for equatives) available in the grammar:

- 3) a) NP2 (NP1)
 b) COP(NP1, NP2)

On a related note, I claimed that the inverse/canonical alternation of Moro (1991) is not the same as the Irish predicative/equative alternation. Similarly, I showed that ECP-based accounts of non-verbal predication like that proposed in Heggie (1988) and DeGraff (1992), simply cannot account for the facts of Irish.

As a final round-up of the facts, the following chart summarizes the relevant analysis and distribution of the various Irish "be" constructions:

	Non-verbal (Is)		Verbal (Tá)
	predicative	Equative	
Example	Is platapas (é) Seán C platypus agr John "John is a platypus"	Is é Seán an Platapas C agr John the platypus "John is the platypus"	Tá Seán tuirseach Be John tired "John is tired"
Structure	<p>XP(NP)</p>	<p>COP(NP,NP)</p>	<p>Tá(ev, XP(NP))</p>
Predicate Movement	-Predicative X(P) undergoes head movement	-abstract COP predicate undergoes head-movement, realized (obligatorily) as agreement for identification	-Verbal <i>Tá</i> undergoes raising, non-verbal predicate stays <i>in situ</i>
Movement for case (not shown above)	Subject NP moves to spec AgrP where it gets NOM case. Pronouns surface in <i>é/i/iad</i> form since they are not next to a tensed verb	Both NPs are arguments and move to their respective case positions	Subject NP moves to spec AgrP for NOM case. Pronouns take <i>sé/sí/siad</i> form since they are next to a verb
Interpretation	Individual level only. There is no light verb to introduce an event argument	Individual level only, there is no light verb to introduce an event argument	Stage or individual level. Event arguments, delimiting stage level predicates, can be introduced by <i>Tá</i>
Other notes	- <i>Is</i> is a complementizer	- <i>Is</i> is a complementizer. -An alternative of this order: Is é an platapas é C agr the platypus him "He is the platypus" is the result of weak pronoun post-posing	-some non-verbal predicates may also require the presence of an aspectual head.

The conclusions of this thesis have been far reaching, with radical changes proposed for the theories of phrase structure, movement and case, as well as for our understanding of the nature of copular relations. It is my hope that future research will extend these conclusions to related phenomena in other languages and other constructions within the grammar of Irish.

Appendix The morphology of *to be* in Irish

Due to the great number of suppletive forms in the morphology of Irish *be*, I here provide some paradigms for the reader's reference:

A.1 Tá

Present Tense

Positive

	singular	plural
1	táim (tá mé)	táimid
2	tá tú	tá sibh
3 masculine	tá sé	tá siad
3 feminine	tá sí	
Arbitrary subject	táthar	

Negative

	singular	Plural
1	nílím (níl mé)	nílímid
2	níl tú	níl sibh
3 masculine	níl sé	níl siad
3 feminine	níl sí	
Arbitrary subject	níltear	

(note níl < ní fhuil (/ni: + il/))

Question (An) /Embedded (go)/Negative Question (nach)

	singular	Plural
1	an bhfuilím (an bhfuil mé)	an bhfuilímid
2	an bhfuil tú	an bhfuil sibh
3 masculine	an bhfuil sé	an bhfuil siad
3 feminine	an bhfuil sí	
Arbitrary subject	an bhfuiltear	

Present Habitual Tense

Positive

	singular	Plural
1	bím	bímid
2	bíonn tú	bíonn sibh
3 masculine	bíonn sé	bíonn siad
3 feminine	bíonn sí	
Arbitrary subject	bítear	

Negative

	singular	Plural
1	ní bhím	ní bhímid
2	ní bhíonn tú	ní bhíonn sibh
3 masculine	ní bhíonn sé	ní bhíonn siad
3 feminine	ní bhíonn sí	
Arbitrary subject	ní bhítear	

Question (An) /Embedded (go)/Negative Question (nach)

	singular	Plural
1	an mbím	an mbímid
2	an mbíonn tú	an mbíonn sibh
3 masculine	an mbíonn sé	an mbíonn siad
3 feminine	an mbíonn sí	
Arbitrary subject	an mbítear	

Past Habitual Tense

Positive

	singular	Plural
1	bhínn	bhímis
2	bhíteá	bhíodh sibh
3 masculine	bhíodh sé	bhídís
3 feminine	bhíodh sí	
Arbitrary subject	bhítí	

Negative

	singular	Plural
1	ní bhínn	ní bhímis
2	ní bhíteá	ní bhíodh sibh
3 masculine	ní bhíodh sé	ní bhídís
3 feminine	ní bhíodh sí	
Arbitrary subject	ní bhítí	

Question (An) /Embedded (go)/Negative Question (nach)

	singular	Plural
1	an mbínn	an mbímis
2	an mbíteá	an mbíodh sibh
3 masculine	an mbíodh sé	an mbídís
3 feminine	an mbíodh sí	
Arbitrary subject	an mbítí	

Past Tense

Positive

	singular	Plural
1	bhí mé	bhíomar
2	bhí tú	bhí sibh
3 masculine	bhí sé	bhí siad
3 feminine	bhí sí	
Arbitrary subject	bhíothas	

Negative

	singular	Plural
1	ní raibh mé	ní rabhamar
2	ní raibh tú	ní raibh sibh
3 masculine	ní raibh sé	ní raibh siad
3 feminine	ní raibh sí	
Arbitrary subject	ní rabhthas	

Question (An) /Embedded (go)/Negative Question (nach)

	singular	Plural
1	an raibh mé	an rabhamar
2	an raibh tú	an raibh sibh
3 masculine	an raibh sé	an raibh siad
3 feminine	an raibh sí	
Arbitrary subject	an rabhthas	

Future Tense

Positive

	singular	Plural
1	beidh mé	beimid
2	beidh tú	beidh sibh
3 masculine	beidh sé	beidh siad
3 feminine	beidh sí	
Arbitrary subject	beifear	

Negative

	singular	Plural
1	ní bheidh mé	ní bheimid
2	ní bheidh tú	ní bheidh sibh
3 masculine	ní bheidh sé	ní bheidh siad
3 feminine	ní bheidh sí	
Arbitrary subject	ní bheifear	

Question (An) /Embedded (go)/Negative Question (nach)

	singular	Plural
1	an mbeidh mé	an mbeimid
2	an mbeidh tú	an mbeidh sibh
3 masculine	an mbeidh sé	an mbeidh siad
3 feminine	an mbeidh sí	
Arbitrary subject	an mbeifear	

Bibliography

- Adger, David (1995) "Argument Placement in Non-Finite Clauses in Scottish Gaelic and Irish" Paper presented at the Celtic Linguistics Conference, Dublin.
- Adger, David (forthcoming) "Aspect, Agreement and Measure Phrases in Scottish Gaelic." in Robert Borsley and Ian Roberts. *The Syntax of the Celtic Languages* Cambridge University Press.
- Ahqvist, Anders (1972) "Some Aspects of the Copula in Irish". *Éigse* **14.4**, 269-274.
- Ahqvist, Anders (1976) "On the Position of Pronouns in Irish" *Éigse* **16.3**, 171-176.
- Akmajian, Adrian (1970) *Aspects of the grammar of focus in English* Ph.D. dissertation, MIT.
- Anderson, Stephen (1984) "Kwakwala Syntax and the Government-Binding Theory. In *The Syntax of North American Indian Languages. Syntax and Semantics* **16**. Academic Press, New York. 21-75.
- Anderson, Stephen and Sandra Chung (1977) "On Grammatical Relations and Clause Structure in Verb Initial Languages" in P. Cole and J. Saddock eds. *Grammatical Relations, Syntax and Semantics* **8**. Academic Press. 1-25.
- Aoun, Joseph, E. Benmamoun and Dominique Sportiche (1994) "Agreement, Word Order, and Conjunction in some varieties of Arabic" *Linguistic Inquiry*. **25.2**, 195-220.
- Aoun, Joseph, E and Yen Hui Audrey Li (1989) "Scope and Constituency" *Linguistic Inquiry* **20.2**, 141-172.
- Awbery, Gwennllian M. (1976) *The Syntax of Welsh*. Cambridge University Press, Cambridge.
- Awbery, Gwennllian M. (1990) Dialect Syntax: a neglected resource for Welsh. In R. Hendrick (ed.) *The Syntax of the Modern Celtic Languages. Syntax and Semantics* **22**, 1-25.
- Baker, Mark C (1988) *Incorporation: A Theory of Grammatical Function Changing*. Chicago University Press, Chicago.

- Baltin, Mark (1995) "Floating Quantifiers, PRO and Predication" *Linguistic Inquiry* **26.2**, 199-248.
- Barbosa, Pilar (forthcoming) *Null Arguments* Ph.D. Thesis, MIT.
- Barss, Andrew and Howard Lasnik (1986) "A note on anaphora and double objects" *Linguistic Inquiry* **17**, 347-354.
- Benveniste, Emile (1966a) "The Linguistic functions of 'to be' and 'to have'" *Problems in General linguistics* English edition (1970) Miami Linguistics Series **8**. University of Miami Press. 163-180.
- Benveniste, Emile (1966b) "The nominal sentence" *Problems in General linguistics* English edition (1970) Miami Linguistics Series **8**. University of Miami Press. 131-144.
- Bergin, Osborn (1938) "On the Syntax of the Old Irish Verb" *Eriu* **12**, 197-214.
- Berman, Ann (1974) "On the VSO hypothesis" *Linguistic Inquiry* **5**, 1-38.
- Berman, Ruth and Alexander Grosu (1976) "Aspects of the Copula in Modern Hebrew" in Peter Cole (ed.) *Studies in Modern Hebrew Syntax and Semantics The transformational-generative approach*. North Holland Publishing Co. Amsterdam. 265-285.
- Bobaljik, Jonathan David (1995) *Morphosyntax: The syntax of verbal inflection*. Ph.D. Dissertation, MIT.
- Bobaljik, Jonathan David (1993) "What does adjacency do?" *MIT Working Papers in Linguistics* **22**, 1-32.
- Bobaljik, Jonathan David and Andrew Carnie (1992/forthcoming). "A minimalist approach to some problems of Irish word order" *Proceedings of the Harvard Celtic Colloquium* **12**, 110-134 (revised version to appear in *The Syntax of the Celtic Languages* I. Roberts and R. Borsley eds. Cambridge University Press).
- Bobaljik, Jonathan David and Dianne Jonas (forthcoming) "Subject Positions and the Roles of TP," to appear in *Linguistic Inquiry*.
- Borer, Hagit (1988) "Morphological Parallelism between Compounds and Constructs" in Geert Booij and Jaap van Marle (eds.) *Yearbook of Morphology*, Foris, Dordrecht. 45-65.
- Borer, Hagit (1995) "The Ups and Downs of Hebrew Verb Movement" *Natural Language and Linguistic Theory* **13.3**, 527-606.
- Borsley, Robert (1983) "A Welsh Agreement Process and the status of VP and S" in Gazdar, et al. *Order Concord and Constituency* Foris Dordrecht. 57-74.
- Borsley, Robert and Ian Roberts (eds.) (forthcoming) *The Syntax of the Celtic Languages*. Cambridge University Press.
- Bowers, John (1993) "The Syntax of Predication" *Linguistic Inquiry* **24.4**, 591-656.

- Branigan, Phillip (1992) *Subjects and Complementizers* Ph.D. dissertation, MIT.
- Cardinaletti, Anna and Michel Starke (1994) "The Typology of Structural Deficiency: On the Three Grammatical Classes" ms. University of Venice, University of Geneva.
- Carlson, Gregory (1977) *Reference to Kinds in English*, Ph.D. Dissertation, University of Massachusetts, Amherst (Distributed by GLSA).
- Carlson, Gregory and Francis Pelletier (1995) *The Generic Book*. Chicago University Press.
- Carney, James (1978) 'Aspects of archaic Irish' *Éigse* **17.4**, 417-435.
- Carnie, Andrew (1993) 'Nominal predicates and absolutive case marking in Modern Irish.' *MIT Working Papers in Linguistics* **19**, 89-129.
- Carnie, Andrew (1994) 'Complex Predicates and Deriving Copular Word Order' To appear in the *Belfast Working Papers in Linguistics*.
- Carnie, Andrew and Heidi Harley (1994a) 'Nominally Complex Copular Structures'. To appear in *Proceedings of Langue et Grammaire* **1**, Université de Paris 8.
- Carnie, Andrew and Heidi Harley (1994b) 'Nominally Phrasal Copular Structures' To appear in *Proceedings of WECOL (94)* University of California, Los Angeles.
- Carnie, Andrew and Pilar Barbosa (1995) "Is Right Adjunction Right?" Paper presented at the Linguistic Society of America Meeting. New Orleans.
- Carnie, Andrew, Elizabeth Pyatt and Heidi Harley (1994) "The Resurrection: Raising to Comp, evidence from Old Irish" *Studies in the Linguistic Sciences* **24.2**.
- Choe, Hyon Sook (1987) "An SVO analysis of VSO Languages and Parameterization : A study of Berber" in Guerssel and K. Hale (1987) *Studies in Berber Syntax. Lexicon Project Working Paper* **14**. Center for Cognitive Science, MIT, Cambridge Mass (distributed by MITWPL). 121-158.
- Chomsky (1957) *Syntactic Structures. Janua Linguarum* **4**. Mouton Publishers, The Hague.
- Chomsky, N (1970) "Remarks on Nominalization" in R. Jacobs and P. Rosenbaum (eds.) *Readings in English Transformational Grammar*. Ginn Waltham, Mass. 184-221.
- Chomsky, Noam (1981) *Lectures on Government and Binding*, Foris, Dordrecht.
- Chomsky, Noam (1986) *Knowledge of language: its nature, origins, and use*. Praeger, New York.
- Chomsky, Noam (1991) "Some Notes on Economy of Derivation and Representation," in R. Friedin, ed. *Principles and Parameters in Comparative Grammar*, Cambridge: MIT Press. 417-454.
- Chomsky, Noam (1992) *A minimalist program for linguistic theory. MIT Occasional Paper in Linguistics* **1**.

- Chomsky, Noam (1993) "A Minimalist Program for Linguistic Theory," in K. Hale & S. J. Keyser, eds., *The View From Building 20*, Cambridge: MIT Press. (revised version of Chomsky (1992). 1-49.
- Chomsky, Noam (1994) *Bare Phrase Structure . MIT Occasional Paper in Linguistics 5*.
- Chomsky, Noam (1995a) *The Minimalist Program*. MIT Press, Cambridge.
- Chomsky, Noam (1995b) "Bare Phrase Structure" in Gert Webelhuth, ed. *The Principles and Parameters Approach to Syntactic Theory: A Synopsis*, Basil Blackwell. 385-439 (revised version of Chomsky 1994).
- Christian Brothers (1960) *New Irish Grammar*, C.S. Ó Fallúin, Dublin.
- Chung, Sandra and James McCloskey (1987) "Government, Barriers, and Small Clauses in Modern Irish," *Linguistic Inquiry 18.2*, 173-238.
- Chung, Sandra (1983) "The ECP and Government in Chamorro" *Natural Language and Linguistic Theory 1*. 209-244.
- Chung, Sandra (1990) "VPs and Verb Movement in Chamorro" *Natural Language and Linguistic Theory 8*, 559-619.
- Cinque, G. (1993) "On the Evidence for Partial N-Movement in the Romance DP". Ms. University of Venice.
- Clack, Susan (1994) "A consideration of V2 in relation to Middle Welsh" in Ian Roberts (ed.) *Research Papers in Welsh Syntax, Bangor Research Papers in Linguistics 5*, 38-77.
- Collberg, Sheila Dooley (1990) "An Expanded INFL syntax for Modern Irish" *Lund University Working Papers 36*, 1-17.
- Collins, Christopher and Höskuldur Thráinsson (1994) " Object Shift in Double Object Constructions and the Theory of Case" *MIT Working Paper in Linguistics 19*, 131-174.
- Craig, Colette (1977) *The Structure of Jacalteco*. University of Texas Press, Austin.
- Cram, David (1983) "Scottish Gaelic ANN as an Aspect Particle". *Studia Celtica 18*, 311-326.
- Culicover, Peter and Kenneth Wexler (1973a) "An Application of the Freezing Principle to the Dative in English." *Social Sciences Working Papers 39*, University of California, Irvine.
- Culicover, Peter and Kenneth Wexler (1973b) "Three Further Applications of the Freezing Principle in English" *Social Sciences Working Papers 48*, University of California, Irvine.
- Culicover, Peter and Kenneth Wexler (1977) "Some Syntactic implications of a theory of Language learnability". in Peter Culicover, Thomas Wasow, Adrian Akmajian (eds.) *Formal Syntax*, Academic Press, New York. 7-60.

- Culicover, Peter and Kenneth Wexler (1980) *Formal principles of language acquisition*, MIT Press, Cambridge, Mass.
- Culicover, Peter and Wendy Wilkins (1984) *Locality in Linguistic Theory*, Academic Press, New York.
- Davidson, D (1967) "The Logical form of Action Sentences" in N. Rescher (ed.) *The Logic of Decision and Action*. University of Pittsburgh Press. 81-95.
- Déchainé, Rose-Marie (1993) *Predicates Across Categories*, Ph.D. dissertation, University of Massachusetts, Amherst. (Distributed by GLSA)
- DeGraff, Michel (1992) "The Syntax of Predication in Haitian" in *Proceedings of NELS 22*, 103-117. (Distributed by GLSA)
- Di Sciullo, Anna-Maria and Edwin Williams (1987) *On the Definition of Word*. MIT Press, Cambridge, Mass.
- den Besten, Hans (1977) "On the Interaction of Root Transformations and Lexical Deletive Rules", unpublished Ms. Amsterdam Univ. (as cited in Emonds (1980))
- den Besten, Hans (1990) *Studies in West Germanic Syntax*, Ph.D. dissertation, University of Tilburg.
- Déprez, Vivienne and Kenneth Hale (1986) "Resumptive Pronouns in Irish" *Proceedings of the Harvard Celtic Colloquium 5*, 38-48.
- Diesing, Molly (1992) *Indefinites*. MIT Press, Cambridge.
- Dillon, Myles (1927/28) "Nominal Predicates in Irish". Part I *Zeitschrift für Celtische Philologie 15*, 313-356, Part II *ZCP 17*, 307-346.
- Doherty, Cathal (1992) "Clausal Structure and the Modern Irish Copula". *Syntax at Santa Cruz 1*, 65-91.
- Doherty, Cathal (forthcoming) "Clausal Structure and the Modern Irish Copula". To appear in *Natural Language and Linguistic Theory*.
- Doherty, Cathal (1995) "Identificational Sentences in Irish." Paper presented at the Celtic Linguistics Conference, Dublin.
- Doron, Edit (1986) "The Pronominal 'copula' as agreement clitic" *The Syntax of Pronominal Clitics, Syntax and Semantics 19*. Academic Press. New York. 313-332.
- Dowty, David, Robert Wall and Stanley Peters (1981) *Introduction to Montague Semantics* D. Reidel, Dordrecht.
- Dubinsky, Stanley (1994) "Syntactic underspecification: a minimalist approach to light verbs". *MIT Working Papers in Linguistics 22*, 61-81.
- Duffield, Nigel (1990b) "Movement and the Case of the Irish Verbal Noun". in B. Bird, K. Hunt, and V Samiian (eds.) *Proceedings of the Western Conference in Linguistics 3*, 79-87.

- Duffield, Nigel (1990a) "Movement and Mutation in Modern Irish". in Green, T and S Uziel *Papers from the Second Student Conference in Linguistics. MIT Working Papers in Linguistics* **12**, 14-30.
- Duffield, Nigel (1991). *Particles and Projections*. Ph.D. Dissertation, University of Southern California (also forthcoming as a volume by Kluwer, Dordrecht).
- Duffield, Nigel (1992) "The Construct State in Irish and Hebrew Part I" *Belfast Working Papers in Language and Linguistics* **12**, 1-67.
- Duffield, Nigel (1993) "Irish construct state nominals and the radical Pro-Drop phenomenon" *Proceedings of NELS* **23**, 113-127.
- Duffield, Nigel (1994) "Are You Right? On Pronoun-Postposing and other problems of Irish Word Order." *Proceedings of the West Coast Conference on Formal Linguistics* **13**, 221-236.
- Duffield, Nigel (forthcoming) "On Structural Invariance and Lexical Diversity" in Borsley and Roberts *The Syntax of the Celtic Languages*. Cambridge University Press.
- Elordieta, Gorka (1994) "On Prosodic Government" *MIT Working Papers in Linguistics* **23**, 115-133.
- Èkundayo, S.A. (1976) "An Alternative to Lexical Insertion for Yoruba Complex Nouns. *Studies in African Linguistics* **7**, 233-260.
- Èkundayo, S. A..(1977) "Lexical Nominalizability Restrictions in Yoruba" *Studies in African Linguistics*, Supplement **7**, 43-51.
- Emonds, Joseph (1980) "Word Order in Generative Grammar" *Journal of Linguistic Research* **1**, 33-54.
- Endo, Yoshio (1994) "Stage/individual Level Nouns" *MIT Working Papers in Linguistics* **22**, 83-99.
- Ernst, Thomas (1992) "Phrase Structure and Directionality in Irish." *Journal of Linguistics* **28**, 415-443.
- Fassi-Fehri, Abdelkader (1989) "Generalized IP structure, Case and VS Word Order" *MIT Working Papers in Linguistics* **10**, 75-112.
- Fassi-Fehri, Abdelkader (1993) *Issues in the Structure of Arabic Clauses and Words*. Kluwer Academic Publishers, Dordrecht.
- Fox, Danny (1994) "Relative Clauses and Resumptive Pronouns in Hebrew, an optimality-theoretic approach". Ms. MIT, Cambridge, Mass.
- Fukui, Naoki & Margaret Speas, (1986) "Specifiers and Projection," in N Fukui, T Rapoport & E Sagey, eds., *Papers in Theoretical Linguistics: MIT Working Papers in Linguistics* **8**, 128-172.
- Ghomeshi, Jila (1994) "[+N] as a non-projecting feature" Paper presented at the Annual meeting of the Canadian Linguistic Association, University of Calgary.

- Ghomeshi, Jila (1995) "The Ezafe Construction in Modern Persian" Talk presented at the University of British Columbia March 24, 1995.
- Ghomeshi, Jila (forthcoming) *Clause structure in Persian: Referentiality and Projection* Ph.D. Dissertation. University of Toronto.
- Gold, Elaine (1994) *Head-Adjunction and Movement: Evidence from Yiddish*. Ms. University of Toronto.
- Greenberg, Joseph (1966) "Some universals of Grammar with particular reference to the order of meaningful elements". in J. Greenberg ed. *Universals of Language* MIT Press, Cambridge, Mass. 73-113.
- Guéron, Jacqueline (1993) "Beyond Predication. The inverse copular construction in English" ms. University de Paris X- Nanterre.
- Guerssel, Mohammed (1987) "The Status of the Lexical Category Preposition in Berber: Implications for the Nature of the Construct State." In M. Guerssel and K. Hale (1987) *Studies in Berber Syntax. Lexicon Project Working Paper 14*, Center for Cognitive Science, MIT, Cambridge Mass (distributed by MITWPL). 159-191.
- Guerssel, Mohammed and Kenneth L. Hale (1987) *Studies in Berber Syntax. Lexicon Project Working Paper 14*, Center for Cognitive Science, MIT, Cambridge, Mass (distributed by MITWPL).
- Guilfoyle, Eithne (1988) "Parameters and Functional Projection" *Proceedings of NELS 18*, 193-207.
- Guilfoyle, Eithne (1990) *Functional Categories and Phrase Structure Parameters* Ph.D. Dissertation, McGill University.
- Guilfoyle, Eithne (1993) "Nonfinite Clause in Modern Irish and Old English" *Proceedings of the Chicago Linguistic Society 29.1*, 199-214.
- Guilfoyle, Eithne (1994). "VNPs Finiteness and External Arguments" *Proceedings of NELS 24*, 141-155
- Guilfoyle, Eithne, Henrietta Hung, and Lisa Travis (1992) "Spec of IP and Spec of VP: Two subjects in Austronesian Languages. *Natural Language and Linguistic Theory 10*, 375-414.
- Haegeman, Liliane. (1991) *Introduction to Government and Binding Theory*. Basil Blackwell, London.
- Hale, Kenneth (1989) "Incorporation and the Synthetic Verb forms in Irish" ms. MIT, Cambridge, Mass.
- Hale, Kenneth. and Samuel J. Keyser (1991). "On the syntax of argument structure" *Lexicon Project Working Paper 34*, MIT center for Cognitive Science, Cambridge.
- Halle, Morris and Alec Marantz (1993) "Distributed Morphology and the Pieces of Inflection", in Ken Hale and Samuel J. Keyser Eds. *The View from Building 20*, MIT Press, Cambridge. 111-176.

- Halle, Morris and Alec Marantz (1994) "Some Key Features of Distributed Morphology" *MIT Working Papers in Linguistics* **21**, 275-288.
- Harley, Heidi (1994) "The case of the Icelandic Experiencer" Generals Paper, MIT.
- Harley, Heidi (forthcoming) "Abstracting away from abstract case" to appear in *Proceedings of NELS* **25**.
- Harley, Heidi (forthcoming) *Subjects, Events and Licensing* Ph.D. Dissertation, MIT
- Harwood, F.W. (1955) "Axiomatic syntax; the construction and evaluation of a syntactic calculus" *Language* **31**, 409-414.
- Heggie, Lorie (1988) *The Syntax of Copular Structures* Ph.D. Dissertation, University of Southern California.
- Heggie, Lorie (1990) "An ECP Account of the Non-Overt Copula in Israeli Hebrew" *Proceedings of NELS* **20**, 185-199.
- Hendrick, Randall (1988) *Anaphora in Celtic and Universal Grammar*. Kluwer, Dordrecht.
- Hendrick, Randall (1990) "Breton Pronominals, binding and Barriers", in R. Hendrick ed. *Syntax and Semantics* **23** *The Syntax of the Modern Celtic Languages*. Academic Press, New York, 121-165.
- Hendrick, Randall (1994) "The Brythonic Celtic Copula and Head Raising" in Lightfoot and Hornstein *Verb Movement* Cambridge University Press. 163-188.
- Hendrick, Randall (forthcoming) "Syntactic Effects of Suppletion in the Celtic Copulas" to appear in Robert Borsley and Ian Roberts *The Syntax of the Celtic Languages* Cambridge University Press.
- Heycock, Caroline (1991) *Layers of Predication*. Ph.D. Dissertation, University of Pennsylvania.
- Heycock, Caroline (1992) "Layers of Predication and the Syntax of the Copula" *Belgian Journal of Linguistics* **7**, 95-123.
- Heycock, Caroline (1994) "The Internal structure of Small Clauses: New Evidence from Inversion" to appear in *proceedings of NELS* **25**. (distributed by GLSA)
- Higgins, Francis Roger (1973) *The Psuedocleft construction in English*. Ph.D. dissertation, MIT.
- Higginbotham, James (1983) "Logical Form, Binding and Variables" *Linguistic Inquiry* **14**, 395-420.
- Higginbotham, James (1987) "Indefiniteness and Predication." in Reuland and ter Meulen *The Representation of (In)definiteness*. MIT Press Cambridge, 43-70.
- Hindley, Reg (1992) *The Death of the Irish Language, a qualified obituary*. Routledge London.
- Hoekstra, Teun (1988) "Small Clause Results" *Lingua* **74**, 101-139.

- Hoekstra, Teun and Rene Mulder (1990) "Unergatives as copular verbs: locational and existential predication." *The Linguistic Review* **7**, 1-79.
- Holmberg, Anders (1986) *Word Order Variation in the Scandinavian Languages and English*. Ph.D. dissertation, University of Stockholm.
- Huang, James (1993) "Reconstruction and the Structure of VP". *Linguistic Inquiry* **24**, 1-37.
- Iatridou, Sabine and Anthony Koch (1992) "The licensing of CP Recursion and its Relevance to the Germanic Verb-Second Phenomenon. *Working Papers in Scandinavian Syntax* **50**, 1-24.
- Jackendoff, Ray (1977) *X-bar Syntax: A Study of Phrase Structure*, MIT Press, Cambridge, Mass.
- Jelinek, Eloise and Richard A. Demers (1994) "Predicates and pronominal arguments in Straits Salish" *Language* **70.4**, 697-736.
- Jespersen, Otto (1924) *The Philosophy of Grammar*. Allen and Unwin, London.
- Jonas, Diane and Jonathan Bobaljik (1992) "Specs for Subjects: the role of TP in Icelandic" in Bobaljik and Phillips, *Papers on Case and Agreement I, MIT Working Papers in Linguistics* **18**. 59-98.
- Kaplan, Tami (1991) "A classification of VSO languages" *Proceedings of ESCOL* **91**, 198-209.
- Kayne, Richard (1981) "ECP extensions" *Linguistic Inquiry* **12**, 93-134.
- Kayne, Richard (1984) *Connectedness and Binary Branching*, Dordrecht: Foris.
- Kayne, Richard (1994) "The Antisymmetry of Syntax" MIT Press, Cambridge Mass.
- Kearns, Kate (1989) "Predicate Nominals in Complex Predicates" *MIT Working Papers in Linguistics* **10**, 123-134.
- Kitagawa, Y (1986) *Subjects in Japanese and English* Ph.D. dissertation, University of Massachusetts, Amherst.
- Koopman, Hilda and Dominique Sportiche (1991) "The Position of Subjects" *Lingua* **85**, 211-258.
- Kratzer, Angelika (1988/1995) "Stage-level and individual level predicates", in Carlson and Pelletier *The Generic Book*, Chicago University Press. 125-175.
- Kratzer, Angelika (1993) "On external Arguments" *University of Massachusetts (Amherst) Occasional Papers* **17**, 103-130.
- Kroeger, Paul (1993) *Phrase Structure and grammatical relations in Tagalog*. Stanford, CSLI Publications.

- Koizumi, Masatoshi (1994) "Object Agreement Phrases and the Split VP hypothesis" in Jonathan Bobaljik and Colin Phillips (eds.) *Papers on Case and Agreement I. MIT Working Papers in Linguistics* **18**, 99-148.
- Koizumi, Masatoshi (1995) *Phrase Structure in Minimalist Syntax*. Ph.D. Dissertation, MIT, Cambridge Mass.
- Kuroda, S-Y (1986) "Whether we agree or not" Ms. University of California, San Diego.
- Larson, Richard (1988) "On the Double Object Construction". *Linguistic Inquiry* **19.3**, 335-391.
- Lehmann, R.P.M and W.P Lehmann (1975) *An Introduction to Old Irish*. Modern Language Association of America, New York.
- Longobardi, G (1983) "Le frasi copulari in italiano e la struttura della teoria sintattica" *Annali della Scuola Normale di Pisa* **13.4**, 1151-1164.
- Mandlebaum, D (1991) "When Nominals are Predicates" *Proceedings of ESCOL* **91**, 222-233.
- Marantz, Alec (1995a) "A Reader's Guide to 'A Minimalist Program for Linguistic Theory,'" in Gert Webelhuth, ed. *The Principles and Parameters Approach to Syntactic Theory: A Synopsis*, Basil Blackwell. 351-382.
- Marantz, Alec (1995b) "'Cat' as Phrasal Idiom: Separating the Lexicon, the Vocabulary, and the Encyclopedia" Talk given at MIT, May 1, 1995.
- Marantz, Alec (1984) *On Grammatical Relations*, MIT Press, Cambridge Mass.
- Massam, Diane (1994) "Case without Functional Categories" *Proceedings of the (1994) Canadian Linguistic Association Meeting*, 369-380.
- May, Robert (1985) *Logical Form, its structure and derivation*. MIT Press, Cambridge Mass.
- McCawley, James (1970) "English as a VSO Language" *Language* **46**, 286-299.
- McCloskey, James (1978) "Stress and Syntax in Old Irish Compound Verbs" *Texas Linguistic Forum* **10**, 58-71.
- McCloskey, James (1979) *Transformational Syntax and Model Theoretic Semantics: A Case Study in Modern Irish*. Reidel Publications, Dordrecht.
- McCloskey, James (1980) "Is there raising in Modern Irish" *Eriú* **31**, 59-99.
- McCloskey, James (1983a) "A VP in a VSO language" in Gazdar, G., G. Pullam, and I Sag eds. *Order Concord and Constituency*. Foris, Dordrecht. 9-55.
- McCloskey, James (1983b) "Raising, subcategorization and Selection in Modern Irish" *Natural Language and Linguistic Theory* **1**, 441-485.
- McCloskey, James (1990) "Resumptive Pronouns. A-Bar binding and Levels of Representation in Irish." *Syntax and Semantics* **23**, 199-248.

- McCloskey, James (1991) "Clause Structure, Ellipsis and Proper Government in Irish", in *The syntax of Verb Initial Languages. Lingua Special Edition* **85**; 259-302.
- McCloskey, James (1992a) "Adjunction, Selection and Embedded Verb Second" Ms University of California at Santa Cruz.
- McCloskey, James (1992b) 'On the scope of verb movement in Modern Irish'. Technical Report LRC-92-10. Linguistics Research Center, Cowell College University of California at Santa Cruz.
- McCloskey, James (forthcoming) "Subjects and Subject Positions in Modern Irish", to appear in Borsley and Roberts eds. *The Syntax of the Celtic Languages* Cambridge University Press.
- McCloskey, James (1995) "Case Marking and Clause type in Irish" Paper presented at the Celtic Linguistics Conference, Dublin.
- McCloskey, James and Ken Hale (1984) "On the Syntax of Person-Number inflection in Irish" *Natural Language and Linguistic Theory* **1**, 487-533.
- McCloskey, James and Peter Sells (1988) "Control and A-Chains in Modern Irish" *Natural Language and Linguistic Theory* **6.2**, 143-189.
- McCone, Kim (1987). *The Early Irish Verb An Sagart*, Maynooth.
- Mohammed, M. A. (1988) "On the Parallelism between IP and DP" *Proceedings of the West Coast Conference on Formal Linguistics* **7**. Stanford. Stanford Linguistic Association. 241-254.
- Moro, Andrea (1991) "The Raising of Predicates: Copula, Expletives and Existence" *MIT Working Papers in Linguistics* **15**, 119-181.
- Moro, Andrea (1993) *The Raising of Predicates*, Ms. Istituto Universitario Lingue Moderne (IUIM) Milan, Italy/
- Muysken, Pieter (1983) "Parameterizing the notion 'head'" *Journal of Linguistic Research* **2.3**, 57-75.
- Musan, Renate (forthcoming) *On the Temporal Interpretation of Noun Phrases*, PhD dissertation, MIT, Cambridge Mass.
- Myhill, John (1985) "Pragmatic and Categorical Correlates of VS word order" *Lingua* **66**, 177-200.
- Napoli, Donna Jo (1989) *Predication Theory* Cambridge University Press, Cambridge UK.
- Neeleman, Ad and Fred Weerman (1993) "The Balance between Syntax and Morphology: Dutch Particles and Resultatives" *Natural Language and Linguistic Theory* **11.3**, 433-475.
- Noonan, Máire (1992) *Case and Syntactic Geometry* Ph.D. Dissertation, McGill University, Montréal.

- Noonan, Máire (1993) "Statives, Perfectives and Accusativity: The importance of being Have," in J. Mead, ed., *Proceedings of the West Coast Conference on Formal Linguistics* **11**, 354-370.
- Noonan, Máire (1994) "VP internal and VP external AgrOP: evidence from Irish." *Proceedings of the West Coast Conference on Formal Linguistics* **13**, 318-333.
- Noyer, Rolf (1992) *Features, Positions and Affixes in Autonomous Morphological Structure*. Ph.D. dissertation, MIT, Cambridge Mass.
- Ó Baoill, Donall (1995) "The Modern Irish reflexive form *fein* as a three in one anaphor" Paper presented at the Celtic Linguistics Conference, Dublin.
- Ó Baoill, Donall (1994) "Double Subjects and A-Chains in Modern Irish", Paper presented at the Parasession on the Generative Grammar of Modern Irish, at the "Language in Ireland" Conference, University of Ulster, Jordanstown.
- Ó hAnluain, L. A. (1960) *Graiméar Gaeilge na mBráithre Críostaí*. An Gúm. Baile Átha Cliath.
- Ó Máille, Tómas (1912) "Contributions to the History of the Verbs of Existence in Irish." *Ériu* **4.1**, 1-102.
- Ó Murchú, Helen (1993) "Review of Ó Baoill, D (1992) *insealbhú na Gaeilge mar chead teanga*" *Teangeolas* **32**, 66-72.
- Ó Sé, Diarmuid (1987) "The copula and PreVerbal Particle in West Kerry Irish." *Celtica* **19**, 98-110.
- Ó Sé, Diarmuid (1990) "Tense and Mood in Irish Copula Sentences." *Ériu* **41**, 62-75.
- Ó Siadhail, Mícheal (1983) "The Erosion of the Copula in Modern Irish Dialects". *Celtica* **15**, 117-127.
- Ó Siadhail, Mícheal (1989) *Modern Irish: Grammatical Structure and dialectal variation*. Cambridge University Press.
- Ouhalla, Jamal (1994) "Verb movement and word order in Arabic" in D. Lightfoot and N. Hornstein *Verb Movement*. Cambridge University Press. 41-72.
- Partee, Barbara (1986) "Ambiguous Pseudoclefts with Unambiguous Be" in *Proceedings of NELS* **16**, 354-366.
- Pesetsky, David (1995). *Zero syntax*, MIT Press, Cambridge Mass.
- Pesetsky, David (1987) "Wh-in-situ and unselective binding" in E. Reuland and A. Ter Meulan. *The Representation of (in)definiteness*. MIT press, Cambridge. 98-129.
- Pesetsky, David (1989) "Language Particular Processes and the Earliness Principle" ms. MIT, Cambridge Mass.
- Pintzuk, Steven (1991) *Phrase structures in competition: variation and change in Old English word order*. Ph.D. Dissertation, University of Pennsylvania.

- Pollock, Jean-Yves (1989) "Verb-movement, Universal Grammar, and the Structure of IP," *Linguistic Inquiry* **20**, 365-424.
- Postal, Paul (1969) "Anaphoric Islands" *Chicago Linguistic Society* **5**, 205-239.
- Pulleyblank, Douglas and Akinbiyi Akinlabi (1988) "Phrasal Morphology in Yoruba" *Lingua* **74**, 141-166.
- Pyatt, Elizabeth (1992) "Incomplete subject raising and Welsh word order" *Proceedings of the Harvard Celtic Colloquium* **12**, 135-165.
- Ramchand, Gillian (1993) *Aspect and Argument Structure in Modern Scottish Gaelic* Ph.D. dissertation, Stanford University.
- Rapoport, Tova (1987) *Copular Nominal and Small Clauses* Ph.D. Dissertation, MIT,
- Reinhart, Tanya (1983) *Anaphora and Semantic Interpretation*. Croom Helm, London.
- Reinhart, Tanya (1981) "Definite NP anaphora and C-command domains". *Linguistic Inquiry* **12**, 605-636.
- Reuland, Eric and Alice ter Meulan (1987) *The Representation of (in)definiteness*. MIT Press, Cambridge Mass.
- Richards, Norvin (1993) *Tagalog and the typology of Scrambling*. Honors Thesis, Cornell University.
- Richards, Norvin (in progress) "Towards a theory of head-binding" ms. MIT, Cambridge Mass.
- Rice, Keren and Leslie Saxon (1994) "The Subject Positions in Athapaskan Languages" *MIT Working Papers in Linguistics* **22**, 173-196.
- Ritter, Elizabeth (1987) "NSO Noun Phrases in a SVO language" *Proceedings of NELS* **17**, 521-537.
- Ritter, Elizabeth (1988) "A Head movement Approach to Construct State Noun Phrases" *Linguistics* **26**, 909-929.
- Ritter, Elizabeth (1991a) "Evidence for number as a nominal head" Paper presented at GLOW 1991.
- Ritter, Elizabeth (1991b) "Cross Linguistic Evidence for NumP" ms. UQAM.
- Ritter, Elizabeth (1991c) "Two Functional Categories in Noun Phrases: Evidence from Modern Hebrew" *Syntax and Semantics 25: Perspectives on Phrase Structure*. New York: Academic Press. 37-62.
- Ritter, Elizabeth (1995) "On the Syntactic Category of Pronouns and Agreement" *Natural Language and Linguistic Theory*. **13.3**, 405-443.
- Rizzi, Luigi (1990) *Relativized Minimality*, MIT Press, Cambridge.

- Roberts, Ian and Ur Shlonsky (forthcoming) "Pronominal Enclisis in VSO Languages" to appear in Ian Roberts and Robert Borsley *The Syntax of the Celtic Languages*. Cambridge University Press.
- Rothstein, Susan (1983) *The Syntactic Forms of Predication* Ph.D. Dissertation. MIT Cambridge.
- Rothstein, Susan (1987) "Three forms of English *be*" *MIT Working Papers in Linguistics* **9**, 225-236.
- Rouveret, Alain (1991) "Functional Categories and Agreement". *The Linguistics Review* **8**, 353-387.
- Rouveret, Alain (forthcoming) "BOD in the present tense" to appear in Ian Roberts and Robert Borsley *The Syntax of the Celtic Languages*. Cambridge University Press.
- Russell, Bertrand (1919) *The Philosophy of Mathematics*. Allen and Unwin, London.
- Ruwet, Nicolas (1968) *Introduction à la grammaire générative*, Plon, Paris.
- Sadler, Louise (1988) *Welsh Syntax, A Government Binding Approach*. Croom Helm, New York.
- Safir, Ken (1989) "What explains the definiteness effect" in E. Reuland and A. ter Meulen *The Representation of (in)definiteness*. MIT Press, Cambridge Mass. 71-97.
- Sáinz, Koldo (1994) "Projections and Particles: V1, V2 and Agreement" Paper presented at UPV-EHU (University of the Basque Country) Donostiako Uda Ikastaroak, Abuztuak, 1-5, 1995.
- Samiian, Vida (1983) *Structure of Phrasal Categories in Persian: A X-bar Analysis*, Ph.D.. Dissertation University of California, Los Angeles.
- Samiian, Vida (1994) "The Ezafe Construction: Some Implications for the theory of X-bar Syntax" *Persian Studies in North America*. M. Marashi (ed.), Iranbooks, Bethesda Maryland. 17-41.
- Schafer, Robin (1994) *Non-finite Predicate Initial constructions in Breton*. Ph.D. Thesis University of California, Santa Cruz.
- Schafer, Robin (1995) "Negation and Verb Second in Breton" *Natural Language and Linguistic Theory* **13.1**, 135-172.
- Schmitt, Christina (1992) "*Ser* and *Estar*: A matter of Aspect" *Proceedings of NELS* **22**, 411-428.
- Schwartz, Arthur (1972) "The VP constituent of SVO languages". *Syntax and Semantics* **1**, 213- 235.
- Seiter, William (1980) *Studies in Niuean Syntax*, Garland, New York.
- Shlonsky, Ur (1987) *Null and Displaced Subjects*, Ph.D. Thesis, MIT.

- Sityar, Emily (1989) *Pronominal Clitics in Tagalog* Masters Thesis, University of California, Los Angeles.
- Solan, L (1983) *Pronominal Reference; Child Language and the Theory of Grammar*: Reidel, Dordrecht..
- Speas, Margaret (1990) *Phrase Structure in Natural Language*. Kluwer, Dordrecht.
- Sproat, Richard (1983). 'VSO languages and Welsh configurationality' *MIT Working Papers in Linguistics* **5**. 243-276.
- Sproat, Richard (1985) "Welsh Syntax and VSO Structure" *Natural Language and Linguistic Theory* **3**, 173-216.
- Stenson, Nancy (1981) *Studies in Irish Syntax*. Gunter Narr Verlag: Tubingen.
- Stowell, Tim (1983) "Subjects across Categories" *The Linguistic Review* **2**, 285-312.
- Stowell, Tim (1991) "Small Clause Restructuring" in Robert Friedin (ed.) *Principles and Parameters in Comparative Grammar*. MIT Press. Cambridge. 182-218.
- Strachan, J (1944). *Stories from the Táin*. 3rd Ed. Royal Irish Academy. Dublin.
- Strachan, J. (1984) *Old Irish paradigms and glosses* 4th edition. Royal Irish Academy, Dublin.
- Stroik, Thomas (1994) "Saturation, Predication and the DP hypothesis" *Linguistic Analysis* **24**, 39-61.
- Takano, Hisako (1992) "A non-NP analysis of Japanese Predicate Nominals" *MIT Working Papers in Linguistics* **16**, 223-238.
- Tallerman, Maggie (1990) "VSO Word Order and Consonantal Mutation in Welsh" *Linguistics* **28**, 398-416.
- Terada, Michiko (1991) *Incorporation and Argument Structure in Japanese*, Ph.D. Dissertation, University of Massachusetts, Amherst (Distributed by GLSA).
- Thurneysen, Rudolf (1980) *A Grammar of Old Irish: An Enlarged edition with supplement* (first ed. 1941). Translated by Binchy and Bergin. Dublin Institute for Advanced studies. Dublin.
- Tomlin, R (1984) "The Frequency of Basic Constituent Orders" *Papers in Linguistics* **17**, 163-196.
- Travis, Lisa (1984) *Parameters and Effects of Word-Order Variation*, Ph.D. dissertation, MIT (distributed by MITWPL).
- Travis, Lisa (1991) "Inner Aspect and the Structure of VP" Paper presented at *NELS 22*.
- Truckenbrodt, Hubert (1994) "Towards a prosodic theory of extraposition" ms, MIT.
- Vinet, Marie-Therèse (1993) "L'aspect et la Copule Vide dans la Grammaire des Titres" to appear in *Langue Française* **100**, 83-49.

- Watanabe, Akira (1993) *Agr Based Case Theory and its interaction with the A-bar system*. Ph.D. thesis MIT.
- Watkins, Calvert (1963) 'Preliminaries to a historical and comparative syntax of the Old Irish verb'. *Celtica* **6**, 1-49.
- Wexler, Kenneth, Peter Culicover and Henry Hamburger (1975) "Learning-Theoretic Foundations of Linguistic Universals" *Theoretical Linguistics* **2.3**, 215-253.
- Williams, Edwin (1980) "Predication" *Linguistic Inquiry* **11.1**, 203-238.
- Williams, Edwin (1983a) "Against Small Clauses" *Linguistic Inquiry* **14.2**, 287-308.
- Williams, Edwin (1983b) "Semantic vs. Syntactic Categories" *Linguistics and Philosophy* **6**, 423-446.
- Williams, Edwin (1994) *Thematic Structure in Syntax*. MIT Press, Cambridge Mass.
- Woolford, Ellen (1991) "VP internal Subjects in VSO and Non-configurational Languages" *Linguistic Inquiry*, **22.3**; 503-540.
- Zaring, Lorie (1994) "Two "be" or not two "be" Identity, Predication and the Welsh Copula" Ms. Carlton College.
- Zwart, C Jan-Wouter (1992) "Dutch Expletives and Small Clause Predicate Raising" *Proceedings of NELS* **22**, 477-491.
- Zwart, C Jan-Wouter (1995) "About Holmberg's Generalization" ms. University of Gronigen.