



Contents

1 INTRODUCTION	6
2 INDICATIONS FOR USE	7
3 SPECIFICATIONS	8
3.1 General	8
3.2 Electrical	8
3.3 Laser	8
3.4 Other Light Sources	8
4 EQUIPMENT DESCRIPTION	9
4.1 System Components	9
4.2 General	10
Base Console	11
Fiber Delivery System	11
Surgical Handpiece	11
Whitening Handpiece (optional)	11
Deep Tissue Handpiece (optional)	12
Wireless Footswitch	12
5 CONTRAINDICATIONS, WARNINGS, AND PRECAUTIONS	13
5.1 Contraindications	13
5.2 Warnings and Precautions	13
Prescription Statement	13
Training	13
Eyewear	13
Anesthesia	13
Adjacent Structures	14
Suction	14
Plume Removal	14
Treatment, Technique and Settings	14
Clinical Environment	14
6 SAFETY WITH THE EPIC X	15
6.1 Safety Instructions	16
6.2 Safety Classification	16
6.3 Safety Features	17
Energy Monitor	17

Contents

System Monitor	17
Power Switch	17
Access Key Code	17
Control Button	17
Wireless Footswitch	18
Remote Interlock	18
Emergency Stop	18
Functional Display	18
7 INSTALLATION AND SETUP	19
7.1 System Setup	19
7.2 Connecting the Fiber	19
7.3 Surgical Handpiece Assembly	20
7.4 Single-Use Tips	21
7.5 Connecting the Whitening Handpiece (Optional Accessory)	23
7.6 Connecting the Deep_Tissue handpiece (Optional Accessory)	24
7.7 Operation-Turn on the Epic X	26
7.8 Home Screen	26
7.9 Settings Screen	27
7.10 Pairing the Footswitch to the Laser Console	27
7.11 Control Button	28
7.12 Entering Ready or Standby Modes	29
7.13 Ready Mode	29
7.14 Wireless Footswitch	29
7.15 Peak Power Display	30
7.16 Pulse Mode Selection	30
7.17 Using the Epic X Touch Screen Display	31
7.18 Procedures Button	32
7.19 Turn the Laser Console Off	32
8 CLINICAL APPLICATIONS	33
8.1 Introduction	33
8.2 Soft-Tissue Surgery and Other Dental Use	33
Tip Initiation: Parameters and Method (Not Required if using Pre-Initiated Tips)	33
Pre-Programmed Settings for Dental Procedures	34
8.3 Table of Pre-Programmed Settings	35
8.4 Teeth Whitening	37
Preset Values	37
8.5 Pain Therapy	37

Contents

Preset Values.....	38
Pain Therapy-Adverse Effects.....	38
Pain Therapy-Warning and Precautions.....	39
Recommended Use.....	40
9 MAINTENANCE.....	41
9.1 Daily Maintenance.....	41
9.2 Cleaning and Sterilization Procedures.....	41
Step 1- Cleaning Process- Surgical Handpiece.....	41
Step 2- Sterilization Process- Surgical Handpiece.....	42
Step 3- Disinfecting the Fiber Optic Cable.....	43
Disinfecting the Whitening Handpiece.....	43
Disinfecting the Deep Tissue Handpiece Fiber.....	43
9.3 Fiber Optic Lens Inspection and Cleaning.....	44
Lens Inspection Procedure.....	44
Cleaning the Lens.....	44
9.4 Installing/Replacing the Console Battery Pack.....	45
9.5 Changing the Wireless Footswitch Batteries.....	45
9.6 Transportation.....	46
9.7 Storage.....	46
10 CALIBRATION.....	47
11 SOFTWARE SPECIFICATION.....	47
12 TROUBLESHOOTING.....	48
APPENDIX A- TIP GUIDE.....	50
Non-Initiated.....	50
Pre-Initiated.....	51
APPENDIX B- ACCESSORIES.....	52
APPENDIX C- LABELING.....	53
APPENDIX D- SAFETY PRECAUTIONS FOR LITHIUM-ION BATTERY PACKS.....	57
APPENDIX E- ELECTROMAGNETIC COMPATIBILITY.....	59
APPENDIX F- WIRELESS EQUIPMENT COMPLIANCE STATEMENT.....	63

Introduction

The Epic™ X diode laser system is a surgical and therapeutic device at the cutting edge of technology, designed for a wide variety of oral soft-tissue procedures and dental whitening, as well as for use in providing temporary relief of minor pain.

The Epic X utilizes a solid state diode as a semiconductor source for invisible infrared radiation. The energy is delivered to the treatment site via a flexible fiber connected at one end to the laser source and the other end to the Handpiece. Various types of single use, disposable Tips are designed and optimized for different applications. The device is activated by means of a wireless Footswitch.

This is a prescription device that is indicated for professional use only by licensed medical and dental practitioners. The use of this device requires proper clinical and technical training. This manual provides instructions for those professionals that have completed the appropriate training.

When used and maintained properly, the Epic X will prove a valuable addition to your practice. Please contact BIOLASE Customer Service at **1-800-321-6717** for any service needs.

This device must be installed, operated, and maintained according to the guidelines of CAN/CSA-Z386-14.



2 Indications for Use

Use of the Epic X device may be appropriate for incision, excision, vaporization, ablation and coagulation of oral soft-tissues including marginal and inter-dental gingival and epithelial lining of free gingiva and the following specific indications:

- Excisional and incisional biopsies.
- Exposure of unerupted teeth.
- Fibroma removal.
- Frenectomy.
- Frenotomy.
- Gingival troughing for crown impressions.
- Gingivectomy.
- Gingivoplasty.
- Gingival incision and excision.
- Hemostasis and coagulation.
- Implant recovery.
- Incision and drainage of abscess.
- Leukoplakia.
- Operculectomy.
- Oral papillectomies.
- Pulpotomy.
- Pulpotomy as an adjunct to root canal therapy.
- Reduction of gingival hypertrophy.
- Soft-tissue crown lengthening.
- Treatment of canker sores, herpetic and aphthous ulcers of the oral mucosa.
- Vestibuloplasty.
- Tissue retraction for impression.
- Laser soft-tissue curettage.
- Laser removal of diseased, infected, inflamed and necrosed soft-tissue within the periodontal pocket
- Sulcular debridement (removal of diseased, infected, inflamed and necrosed soft-tissue in the periodontal pocket to improve clinical indices including gingival index, gingival bleeding index, probe depth, attachment loss and tooth mobility.)
- Light activation for bleaching materials for teeth whitening.
- Laser-assisted whitening/bleaching of teeth
- Topical heating for the purpose of elevating tissue temperature for a temporary relief of minor muscle and joint pain and stiffness related to temporomandibular joint disorders, the temporary increase in local blood circulation; the temporary relaxation of muscle.

3 Specifications

3.1 GENERAL

- Dimension (W x L x H) 5.7 in x 6.5 in x 4.4 in (14.5 cm x 11.2 cm x 16.5 cm).
- Weight 2.5 lbs / 1 kg.

3.2 ELECTRICAL

- Operating voltage 100V - 240V ~ at 1.5A.
- Frequency 50 / 60 Hz.
- External Fuses None.
- Main control Main Power Switch (ON/OFF Control Button).
- Remote Interruption Remote interlock.
- Disable Control Emergency Stop Button.
- Battery Lithium Ion Rechargeable, 14.4 V, 2.9 Ah.
- DC Power Supply Module 12V DC, 5 A.

3.3 LASER

- Laser Classification IV (4).
- Medium InGaAsP Semi-conductor diode.
- Wavelength 940 ± 10 nm.
- Max Power Output 10W.
- Power Accuracy ± 20%.
- Power Modes Continuous, Pulse Modulation.
- Fiber Tips Diameter 200µm, 300 µm, 400 µm.
- Pulse Duration 0.01 ms – 20 ms.
- Pulse Interval 0.01 ms – 20 ms.
- Pulse Repetition Rate Up to 20 kHz (for reference).
- Spot Size
 - Surgical Handpiece 400 µm (maximum in contact mode).
 - Deep Tissue Handpiece 30 mm diameter = 7.1 cm² area.
 - Whitening Handpiece Rectangular 35mm x 8mm = 2.8cm²
- NOHD 2.7 meters.
- Beam Divergence 8- 22° per side angle.
- Standard Fiber Cable Length 5 feet (1.524 meters).

3.4 OTHER LIGHT SOURCES

- Aiming Beam Laser diode, max 1 mW, 625 nm – 670 nm, Class 2.

4 Equipment Description

4.1 SYSTEM COMPONENTS

The Epic X laser system includes the following:

1. Laser Console (Lithium Ion Battery Pack Already Installed).
2. Screen Protectors Box (Peel-off Clear Screen Cover - qty. 30).
3. Fiber Optic Cable Assembly (Installed).
4. Assorted Surgical Tips.
5. Surgical Handpiece (2).
6. Laser Protective Eyewear (3).
7. DC Power Supply and Power Cord (1).
8. Welcome Kit (Includes User Manual and Quick Setup Guide).
9. Laser Warning Sign.
10. Tip Initiation Kit.
11. Remote Interlock Cable.
12. Philips-Head Screwdriver (For Installing Footswitch Batteries).
13. Footswitch.
14. AAA Batteries (2).

Optional Accessories:

- Whitening Handpiece.
- Deep Tissue Handpiece.



WARNING: No modification of this equipment is allowed.

4 Equipment Description

4.2 GENERAL

The Epic X system consists of three components:



Figure 4.1

4 Equipment Description

BASE CONSOLE

The base console is portable, contains the diode laser and all the elements which power the laser, and has a touchscreen which allows the user to navigate from screen to screen, select procedures, enter and/or change settings, etc. (Figure 4.1).

CONTROL BUTTON:

Activates the controls and display; places the laser into **Standby, Ready**, or **Sleep** mode.

LED Indicators: Amber = Standby mode

Green = Ready mode

Blinking green = Laser is firing

Blinking blue = Pairing active

FIBER DELIVERY SYSTEM

The fiber delivery system consists of Fiber Optic Cable, the reusable surgical Handpiece, and the fiber Tips, and transmits laser radiation from the laser console through the Handpiece and fiber Tips to the target tissue. The laser ships from the factory with the Fiber Optic Cable already attached to the base console (Figure 4.2).



Figure 4.2

SURGICAL HANDPIECE

The surgical Handpiece is re-usable and detachable from the fiber (Figure 4.3). It is the conduit through which laser energy flows from the laser, through the Fiber Optic Cable, to the Tip.



Figure 4.3

WHITENING HANDPIECE (OPTIONAL)

The Whitening/Contour Handpiece is a re-usable Handpiece which can be used for teeth whitening and comes equipped with disposable non-sterile shields for single-patient use (Figure 4.4).



Figure 4.4

4 Equipment Description

DEEP TISSUE HANDPIECE (OPTIONAL)

The deep tissue Handpiece is a re-usable Handpiece used for pain therapy (Figure 4.5). The Handpiece is equipped with disposable non-sterile shields for single patient use. The shields are applied to the spacer and discarded after one-time use.

WIRELESS FOOTSWITCH

The Epic X laser will only emit laser energy when the user presses down on the Footswitch while the laser is in **Ready** mode. It is designed to work using wireless technology and is powered by two AAA batteries which are installed prior to shipment from the factory; it is already paired to the base console.

The Footswitch is protected by a metal cover. To access, first press down on the cover to unlatch it, then press the Footswitch to fire the laser.



Figure 4.5



Figure 4.6

5 Contraindications, Warnings, and Precautions

5.1 CONTRAINDICATIONS

All clinical procedures performed with Epic X must be subjected to the same clinical judgment and care used with traditional techniques. Patient risk must always be considered and fully understood before clinical treatment. The clinician must completely understand the patient's medical history prior to treatment and exercise caution for general medical conditions that might contraindicate a local procedure; such conditions may include, but are not limited to, allergy to local or topical anesthetics, heart disease (including pacemakers and implantable defibrillators), lung disease, bleeding disorders, sleep apnea, an immune system deficiency, or any medical conditions or medications that may contraindicate the use of certain light/laser-type sources associated with this device, including general neurovascular conditions which can reduce a patient's pain sensitivity while undergoing pain therapy procedures (e.g., patients with neurodegeneration associated with Type II diabetes). Medical clearance from the patient's physician is advisable when doubt exists regarding treatment.

5.2 WARNINGS AND PRECAUTIONS

PRESCRIPTION STATEMENT

U.S. Federal Law restricts this device to sale by or on the order of a dentist or physician or other licensed medical practitioner.

TRAINING

Only licensed professionals who have reviewed and understood this user manual should use this device. BIOLASE assumes no responsibility for parameters, techniques, methods, or results. Physicians must use their own clinical judgment and professionalism in determining all aspects of treatment, technique, proper power settings, interval, duration, etc.

EYEWEAR

Doctor, patient, assistant and all others inside or entering the operatory must wear appropriate laser protection eyewear for the 940 nm wavelength, OD 4 or greater (OD4+) whenever the laser is in use. Prior to use, inspect eyewear for pitting and/or cracking. Replace if damaged; do not use.



CAUTION: The specifications for the protective eyewear provided with the Epic X laser system are marked on the side of the glasses: 800 - 820, 920 - <955 nm DIR LB4 (OD4+). Always check the eyewear specifications marked on the glasses to ensure they offer the required protection for the specific laser wavelength.

For additional information, refer to the instructions for use provided with the glasses.

ANESTHESIA

In soft-tissue cases anesthesia may not be required, but patients should be closely monitored for signs of pain or discomfort at all times. If such signs are present, adjust settings, apply anesthesia, or cease treatment if required.

5 Contraindications, Warnings, and Precautions

ADJACENT STRUCTURES

Epic X is designed to remove soft-tissues. Therefore, always be aware of adjacent structures and substructures during use. Be extremely careful not to inadvertently penetrate or ablate underlying or adjacent tissues. Do not direct energy toward hard-tissue such as tooth or bone. Do not direct energy towards amalgam, gold or other metallic surfaces. Do not direct energy towards cements or other filling materials. Exercise extreme caution when using this device in areas such as pockets, cavities or channels such as third molar sockets, where critical structures (i.e. nerves, vessels) could be damaged. Do not proceed with using the laser if visibility is limited in these areas.

SUCTION

Use high-speed suction as required to maintain a clear field of vision during treatment. Do not fire the laser if you cannot clearly see the treatment site.

PLUME REMOVAL



CAUTION: Laser plume may contain viable tissue particulates

Special care must be taken to prevent infection from the laser plume generated by vaporization of virally or bacterially infected tissue. Ensure that appropriate protective equipment, including high-speed suction to remove the plume, appropriately filtered masks, and other protective equipment, is used at all times during the laser procedure.

TREATMENT, TECHNIQUE, AND SETTINGS

Use your clinical judgment to determine all aspects of treatment including, but not limited to, the laser treatment protocol, technique, power settings, pulse duration and interval settings, mode of operation, as well as the accessories (e.g. tip type) and other procedural requirements. Closely observe and monitor clinical effects and use your judgment to determine the clinical parameters and approach for the treatment. Make appropriate power, pulse length, and interval adjustments to compensate for varying tissue compositions, density, and thickness. Always start treatment at the lowest power setting for the specific indication and increase as required. BIOLASE assumes no responsibility for parameters, techniques, methods, or results.

CLINICAL ENVIRONMENT

Only use this device in clinical environments that observe proper standard aseptic techniques with all oral procedures.

6 Safety with the Epic X

Failure to comply with the precautions and warnings described in this user manual may lead to exposure to dangerous optical radiation sources. Please comply with all safety instructions and warnings.



WARNING: No modification of this equipment is allowed.



Symbol warns of laser beam hazard. Always wear appropriate eye protection.



Symbol indicates laser aperture is at the end of the Fiber Optic Cable; when attached to the laser console, visible and/or invisible laser radiation is emitted from this aperture.



LASER WARNING: DO NOT open the console housing at any time. This device contains no user-serviceable parts. Any attempt to modify or repair the laser by anyone other than an authorized BIOLASE technician or BIOLASE-trained representative may lead to exposure to laser radiation and collateral laser radiation, and void the product warranty.



LASER WARNING: This device contains no displaceable portions of protective housing that could allow human access to hazardous levels of laser or collateral radiation.



LASER WARNING: DO NOT aim the laser at metallic or reflective surfaces, such as surgical instruments or dental mirrors. If aimed directly at these surfaces the laser beam will reflect and create a potential hazard.



CAUTION: High temperatures produced in the normal use of this laser equipment may ignite some materials (e.g., cotton wool when saturated with oxygen); solvents or adhesive and flammable solutions used for cleaning and disinfecting should be allowed to evaporate before the laser equipment is used.



CAUTION: Be aware that the metal/plastic cannula on the Tips may become hot during use. Avoid contact of the cannula with any tissue.



CAUTION: This laser system has been designed and tested to meet the requirements of electromagnetic, electrostatic, and radio frequency interference standards. However, the possibility of electromagnetic or other interference may still exist. Relocating the device may help to eliminate the interference.

6 Safety with the Epic X

6.1 SAFETY INSTRUCTIONS

Follow these safety instructions before and during treatments:

- When the laser is in use, all operatory entrances must be marked with an appropriate warning sign (included - see Appendix C).
- **Do not** operate in the presence of explosive or flammable materials. Flammable anesthetics or oxidizing gases such as nitrous oxide (N₂O) and oxygen (O₂) should be avoided. Solvents of adhesives and flammable solutions used for cleaning and disinfecting should be allowed to evaporate before laser is used. Attention should also be drawn to the danger of ignition of endogenous gases.
- **All** persons present in the operatory must wear the appropriate laser protection eyewear. Always ensure that the laser protective eyewear is appropriate for the 940 nm wavelength (OD4+). Prior to use inspect the eyewear for pitting and/or cracking; do not use if damaged.
- **Do not** look directly into the beam or at specular reflections.
- **Never** direct or point the beam at a person's eyes.
- **Always** place the system into **Standby** mode (by pressing the control button while in **Ready** mode) before exchanging Handpieces or disposable Tips.
- **Always** ensure that the proper laser parameters are set before the Epic X laser is used in a clinical procedure.
- Toggle the ON/OFF switch (located on the rear of the console) to the OFF (O) position before leaving the unit unattended.
- **Do not** use the laser if the fiber optic cable is damaged or broken.

6.2 SAFETY CLASSIFICATION

- The following safety classifications are applicable to the device:
- Laser radiation – Class 4.
- Aiming beam – Class 2.
- Type of protections against electrical shock – Class 2.
- Degree of protection against electrical shock – Type B applied part.
- Not protected against water ingress – Ordinary equipment.
- Not suitable for use in presence of flammable anesthetic mixture.
- Operation mode – Continuous wave and pulse mode.
- Wireless Footswitch – IPX6.

6 Safety with the Epic X

6.3 SAFETY FEATURES

ENERGY MONITOR

The energy monitor measures and verifies power output. Power deviations of more than $\pm 20\%$ from the selected value will cause the display to show the error message: "LASER CURRENT HIGH/LOW".

The laser console will not operate until the system first clears the error and then goes into **Ready** mode. If the error message persists, please contact BIOLASE Service at **1-800-321-6717** or your BIOLASE-authorized service representative.

SYSTEM MONITOR

The system monitors the emergency stop switch, remote key, wireless Footswitch connection, and output power. An error in any one of these will stop the system. The text display will indicate the type of error. Operation cannot resume until the error is cleared.

POWER SWITCH

The laser console can be switched ON (I) or OFF (O) using the power switch on the back of the console. Turn the power switch OFF (O) only when the system will not be in use for a long period of time.

ACCESS KEY CODE

The Access Key Code (**888**) prevents unauthorized use of the system. It is activated every time the system is turned ON with the power switch.

Placing the laser in **Sleep** mode by pressing and holding the Control button on the front panel of the console does not re-set the access key code.

CONTROL BUTTON

Once the power switch is set to the ON (I) position, enter the access key code. After setting the desired parameters for a procedure, press the CONTROL button on the control panel to enter into **Ready** mode. The aiming beam will illuminate to indicate that the system is ready for use.



Figure 6.1: Power Switch, DC Power Input, Remote Interlock



Figure 6.2: Power Supply Module with Cord

6 Safety with the Epic X

WIRELESS FOOTSWITCH

The Epic X will not emit laser energy until the user presses down on the Footswitch while the laser is in **Ready** mode. The Footswitch is designed to work using wireless technology.

REMOTE INTERLOCK

This feature allows the laser to be connected to a remote sensor which prevents it from firing when the sensor is triggered. To install the remote interlock, insert the plug **(a)** at the end of the connector into the rear of the laser console (Figure 6.4) and attach the two wires **(b)** at the other end to a door switch; the laser will stop immediately when the connection to the door switch is deactivated, i.e., when the door is opened.

EMERGENCY STOP

Press the red emergency laser stop button (Figure 6.5) to instantly turn off the laser console. The error screen will display an “Emergency Switch Error” message and the amber LED will begin flashing. To clear the error, press the emergency laser stop button again; in 2 to 5 seconds the amber LED will stop flashing and the system will automatically go into **Standby** mode.

FUNCTIONAL DISPLAY

The system color display with touch screen and LED indicators on the control panel shows the functional conditions of the system.



Figure 6.3:
Wireless Footswitch



Figure 6.4:
Remote Interlock Connector



Figure 6.5:
Emergency Laser Stop



CAUTION: Use only the power supply module supplied with the Epic X laser system. (BIOLASE P/N 2400129)

7 Installation and Set-Up



NOTE: The laser ships with the lithium ion battery pack already installed.

7.1 SYSTEM SETUP

- Place the unit in a clean, dry, and well-ventilated area; **do not** cover or block the ventilation channels. These channels provide an air-flow path to cool the unit.
- Verify the power switch is in the OFF (O) position.
- Epic X will work using either DC power or its rechargeable battery pack
 - **DC Power:** Connect the power cord of the power supply to the laser console and plug into a wall outlet.
 - **Rechargeable Battery:** To charge the battery pack, connect the power cord of the DC power supply to the laser console and plug into a wall outlet. Before first use, fully charge the battery (at least 3 hours). Once the battery is charged, unplug the power cord from the wall outlet and the laser console. The laser console will run on battery power alone. To fully charge the battery, plug the power supply in and then turn the laser console ON (I) at the power switch. The laser console will start to charge and the unit will go into Sleep mode (the screen is dark) after 5 minutes; if the power supply is plugged in but the console is turned OFF (O) at the power switch, the battery will still charge, but at a slower rate.

7.2 CONNECTING THE FIBER

The Epic X ships with the Fiber Optic Cable already attached.



CAUTION: Do not connect or disconnect the fiber cable while the laser console is turned ON. Only connect or disconnect the fiber when the laser console is turned OFF

To disconnect the Fiber Optic Cable from the laser console, **make sure the laser console is turned off and the cable is completely unwound from the console base**, grab the Fiber Optic Cable access plug and slowly pull it straight back from the optical access port (Figure 7.1).



Figure 7.1: Fiber Optic Cable Access Plug

To re-install the Fiber Optic Cable, **make sure the laser console is turned off**. The Fiber Optic Cable is attached to the console by inserting the optical access plug (Figure 7.1) into the optical access port (Figure 7.2).

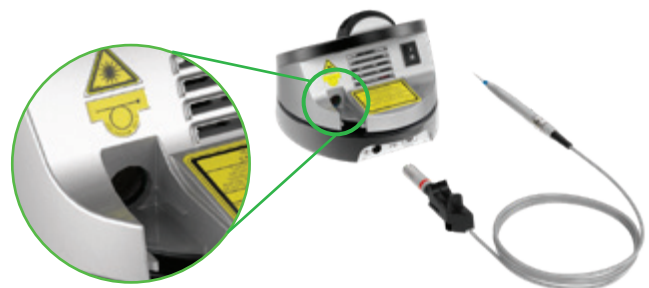

Figure 7.2: Optical Access Port

7 Installation and Set-Up

For storage, wind the cable in the fiber storage channel around the base of the console in a counterclockwise direction.



CAUTION: Do not bend the Fiber Optic Cable at a sharp angle, as it can break. Make sure it is not caught or pinched between the housing and the fiber optic access plug.

7.3 SURGICAL HANDPIECE ASSEMBLY



CAUTION: The surgical Handpiece is not sterile when sold and **MUST** be sterilized **prior to initial use, and cleaned and sterilized between patients.**

To connect the Handpiece to the Fiber Optic Cable, push the Handpiece onto the fiber shaft, without twisting, until it clicks into place and is secured (Figures 7.3, 7.4). If no click is audible, disconnect the Handpiece and then re-install it.

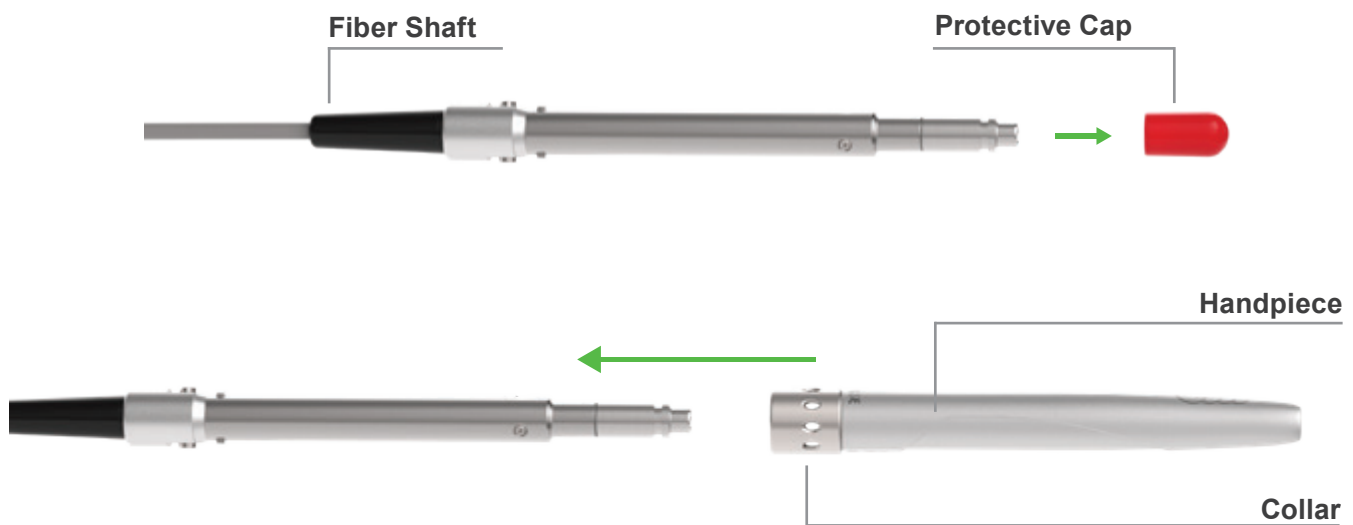

Figure 7.3: Connecting the Handpiece to the Fiber Optic Cable assembly



Figure 7.4: Surgical Handpiece Assembly fully assembled

7 Installation and Set-Up

Disconnect the Handpiece from the Fiber Optic Cable (Figure 7.5):

1. Taking the Handpiece body in one hand and the shaft in the other,
2. Pushing the two buttons on the fiber shaft,
3. Gently pull the Handpiece by the collar to separate it from the fiber shaft without twisting.

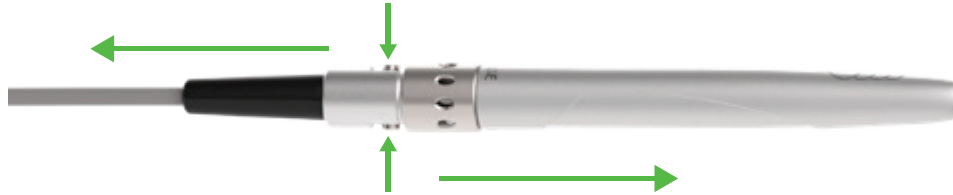

Figure 7.5: Disconnect the Handpiece from the Fiber Optic Cable

7.4 SINGLE-USE TIPS

The Tips are single-use accessories and are provided in three core diameters: 200 μ m, 300 μ m, and 400 μ m, in different lengths (see Appendix A).



CAUTION: Tips are single-use only to avoid cross-contamination and are designed to withstand only a single sterilization cycle; they must be disposed of after use in a biohazard medical waste Sharps container. Always visually inspect the Tip prior to use to make sure it is free of debris or damage.



CAUTION: Be aware that the metal/plastic cannula on the Tips may become hot during use. Avoid contact of the cannula with any tissue.

To connect the Tip, remove the protective cap from the end of the fiber shaft, connect the Handpiece to the Fiber, then insert the Tip firmly into the distal end of the Handpiece as far as it will go and tighten by turning clockwise (Figure 7.6). Bend the metal cannula according to the specific procedure requirements (Figure 7.9).

Remove the fiber Tip by twisting the Tip counterclockwise (Figure 7.7)



Figure 7.6: Insert the fiber Tip into the Handpiece (**only when the Handpiece is connected to the fiber**) and twist clockwise until snug

7 Installation and Set-Up



CAUTION: For proper laser operation, do not connect the Tip when the Handpiece is not connected to the fiber.



Figure 7.7: Remove the fiber Tip by twisting the Tip counterclockwise

Correct



Incorrect



Figure 7.8 : Installing the Tip

Correct



Incorrect

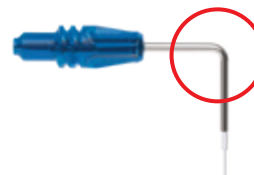

Figure 7.9: Bending the Tip cannula



CAUTION: When the aiming beam is not present or has a significantly asymmetrical shape:

- ▶ For Tips that require initiation: change the Tip
- ▶ For tips that do not require initiation: change the Tip; press the checkmark in the green circle to bypass initiation requirement.

Wind any excess Fiber Optic Cable onto the fiber spool counterclockwise around the base of the console.

The Handpiece is now ready to use. To store the Handpiece, place it in the Handpiece Holder located at the top of the laser console.



LASER WARNING: Never operate the laser without a fiber Tip attached to the Handpiece. Never point the laser at a person's eyes. All persons present in the operator must wear protective eyewear when the laser is in use.

7 Installation and Set-Up

7.5 CONNECTING THE WHITENING HANDPIECE (OPTIONAL ACCESSORY)

The Whitening Handpiece is reusable and equipped with a disposable non-sterile protective shield for single patient use. The Handpiece is non-sterile and requires disinfection before and after each patient treatment. **This Handpiece cannot be sterilized in the autoclave.**

Always wipe the disposable shield with alcohol prior to use. The disposable shield is for single-use only to avoid cross-contamination. Discard when the treatment session is completed.

To connect the Handpiece to the Fiber Optic Cable, push the Handpiece onto the fiber shaft until it clicks on and is secured.

To disconnect the Handpiece from the Fiber Optic Cable, press and hold both buttons at the base of the fiber shaft and gently pull the Handpiece to separate.

When the Whitening Handpiece is connected, the pain therapy application is disabled (Figure 7.11).



Figure 7.10: Whitening Handpiece and disposable non-sterile shield

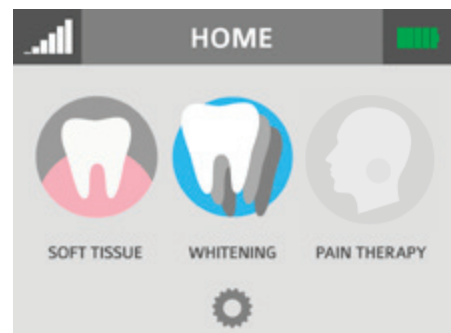

Figure 7.11



NOTE: Refer to the individual Instructions for Use included with the Whitening Handpiece packaging for additional details.

7 Installation and Set-Up

7.6 CONNECTING THE DEEP TISSUE HANDPIECE (OPTIONAL ACCESSORY)

The Deep Tissue Handpiece is permanently attached to the Fiber Optic Cable and cannot be disconnected from it; it is a reusable accessory. It is shipped non-sterile and requires disinfection before and after each patient use. This Handpiece cannot be sterilized in the autoclave, as doing so will damage its internal optics. For instruction on how to clean and disinfect the Handpiece, please refer to section 9.

A disposable, single-use non-sterile protective shield attaches to the Handpiece to avoid cross-contamination between patients. Always wipe the disposable shield with alcohol prior to use. Discard when the treatment session is completed.

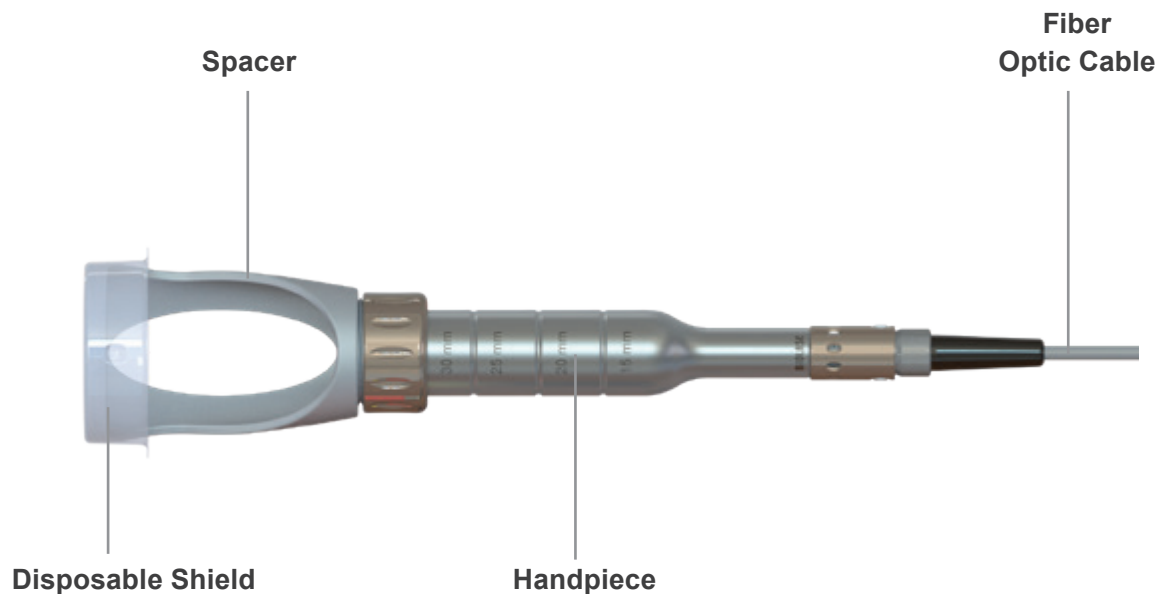

Figure 7.12: Deep Tissue Handpiece

7 Installation and Set-Up

To connect the Handpiece to the laser console:

1. Make sure the laser is turned OFF.
2. Connect the Fiber Optic Cable with the attached Deep Tissue Handpiece to the laser console (Figure 7.13).
3. Remove plastic wrapping from the distal end of the Deep Tissue Handpiece.
4. Place the protective shield over the spacer (Figures 7.14).

The Handpiece is now ready to use.

When the Deep Tissue Handpiece is connected, the surgical and whitening applications are disabled (Figure 7.16).



NOTE: When not in use, protect the lens of the Handpiece from debris; store in a safe and clean environment. Clean any debris that appears on the lens using a cotton swab moistened with isopropyl alcohol.



Figure 7.13



Figure 7.14



Figure 7.15

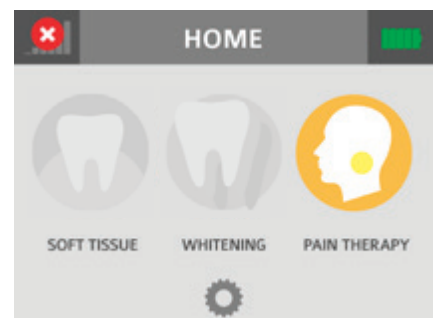

Figure 7.16



NOTE: Refer to the individual Instructions for Use included with the Whitening Handpiece packaging for additional details.

7 Installation and Set-Up

7.7 OPERATION - TURN ON THE EPIC X

Operate with the battery, or connect the power supply cord to the power connector on the laser console and plug the cord into a wall outlet.

Turn the power switch at the rear of the console to the ON (I) position. The “BIOLASE” logo screen will appear. After three (3) seconds the Epic X “Welcome” screen will be displayed.

- Enter the three digit access code using the touch screen. The access key code is 888. (If the incorrect code is entered, an ‘X’ appears briefly in the window; press the ‘X’ or wait 3 seconds to revert back to the welcome screen; re-enter the correct code.
- The system will go to the HOME screen which identifies three procedure categories to choose from: Soft-tissue, Whitening, Pain Therapy.

7.8 HOME SCREEN

The Home screen offers four operational options:

- Soft-tissue: This selection displays the procedures menu which contains 14 pre-programmed clinical procedures and up to 6 custom pre-sets.
- Whitening: This function provides access to the whitening procedure screen which displays the parameters and corresponding mode and Handpiece for the whitening application. The settings are pre-programmed at the factory and cannot be adjusted by the user.
- Pain therapy: This option displays the operation screen for pain therapy at settings pre-programmed at the factory; these settings cannot be adjusted by the user.
- Settings icon: Accesses the settings screen; allows the user to make changes to several system settings, including language (bottom center).

It also displays how much strength is left in the console battery (upper right corner), and whether the wireless connection between the Footswitch and console is at full strength (upper left hand corner).

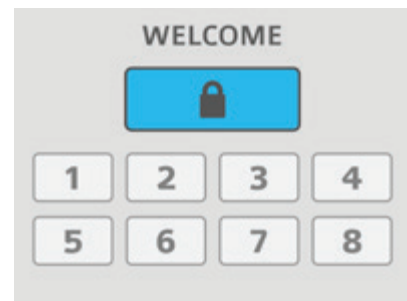

Figure 7.17

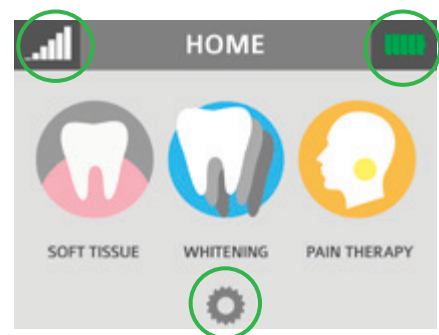

Figure 7.18

7 Installation and Set-Up

7.9 SETTINGS SCREEN

Pressing the Settings button on the HOME screen accesses the Settings screen; the user may make changes to the following system settings:

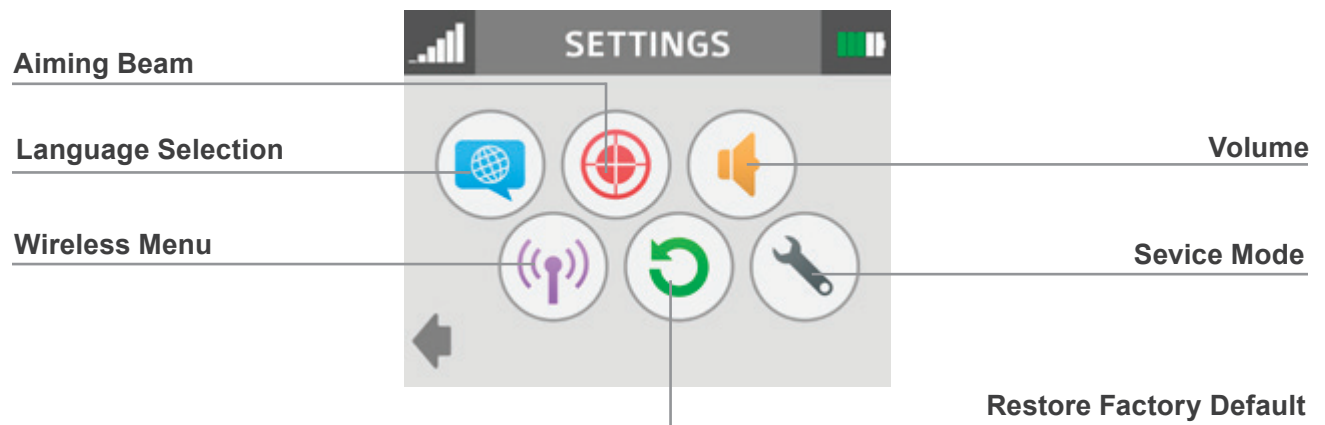

Figure 7.19

7.10 PAIRING THE FOOTSWITCH TO THE LASER CONSOLE

Verify that the Footswitch and laser console are paired; a blue LED indicator light on the laser console will blink when pairing is established. The laser and Footswitch are shipped already paired. However, if pairing is not confirmed, an "x" will appear in the pairing icon located in the upper left hand corner of the touchscreen. (Figure 7.20)

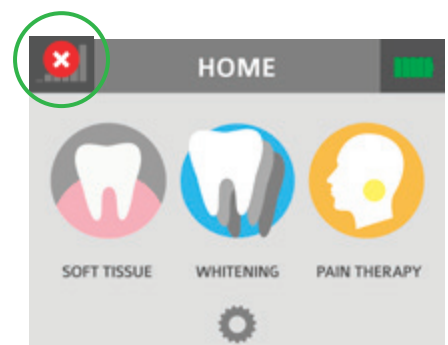

Figure 7.20

7 Installation and Set-Up

To re-establish pairing, take the following steps:

1. Go to the settings menu on the laser console display by pressing the settings icon; select the “Wireless” icon.
2. A screen will appear indicating that pairing of the Footswitch to the laser console has been lost (Figure 7.21); press the green PAIR button.
3. The message that “PAIRING WILL NOW BEGIN” will appear (Figure 7.22); press the green check mark to continue.
4. To complete the pairing process, turn the Footswitch over and press the pairing button for four (4) seconds (Figure 7.23).
5. The wireless screen will appear indicating that pairing was successful and that the Footswitch and laser console are now paired (Figure 7.24). Proceed to step 6.
6. If pairing has not occurred, the wireless screen will appear again indicating that pairing was not successful (Figure 7.25); press the green button to repeat steps 3 and 4.
7. Press the settings button to return to the settings menu; press the arrow on the bottom left of the settings screen to return to the home screen (Figure 7.26).

7.11 CONTROL BUTTON

The CONTROL button on the front of the laser console is a multi-functional button. Pressing and holding the Control Button for approximately two (2) seconds will allow the transition from **Standby** or **Ready** mode to **Sleep** mode. Note that you will not be allowed to go into **Ready** mode unless you have chosen a treatment module on the HOME screen first.



Figure 7.21



Figure 7.22



Figure 7.23



Figure 7.24



Figure 7.25

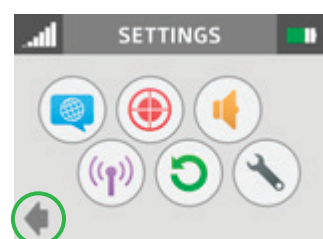

Figure 7.26

7 Installation and Set-Up

7.12 ENTERING READY OR STANDBY MODES

Press and release the control button to place the laser console into either **Ready** or **Standby** mode. The laser console will only emit laser energy when the Footswitch is pressed and the laser console is set to **Ready** mode. While in **Ready** or **Standby** mode, mode setting and/or power setting values may be changed only when the laser is not firing. If the laser is firing (i.e., the Footswitch is engaged), the ability to change the settings is blocked. (**Ready** or **Standby** is displayed in the lower right hand corner of the display screen).

7.13 READY MODE

When entering **Ready** mode, the laser console fan will turn on and pressing the Footswitch will activate laser radiation. There is a two (2) sec delay between switching to **Ready** mode and the ability of the laser console to emit a laser beam.



NOTE: The aiming beam is on only when the laser is in **Ready** mode or when adjusting the brightness of the beam while in settings mode. If the aiming beam is not visible in either instance, remove the Handpiece and confirm the beam is actually on by shining the end of the Fiber Optic Cable on a plain, non-reflective surface. **DO NOT** look directly at the output end of the Fiber Optic Cable. If the aiming beam is not on, turn off the laser console, then remove and re-install the Fiber Optic Cable cable assembly. If the aiming beam is still not on, turn off the laser console and call your authorized service representative.

7.14 WIRELESS FOOTSWITCH

The wireless Footswitch is powered by two (2) AAA batteries.

When the wireless Footswitch is pressed in **Ready** mode and the laser fires, a beeping sound indicates that laser energy is present. A green LED will begin flashing and a blue LED will light at the top corners of the laser console, confirming the Footswitch and laser are paired.

In the top left corner of most screens is a signal strength Indicator which displays the signal strength between the laser console and the Footswitch (strongest is five (5) bars). Pressing and releasing the Footswitch while in **Standby** mode will update this indicator. Although the unit will work with a signal level as low as one (1) bar, a weaker signal level will make the connection between the Footswitch and laser console more vulnerable to wireless (RF) interference from other sources, such as cell phones or microwaves. To improve the signal strength, reposition either the Footswitch or the laser console until the signal indicator achieves the strongest possible level for optimal operation.



NOTE: If the Footswitch is pressed while the system is in Standby mode, the screen will display a message indicating "System must be in Ready mode to lase." Press the control button to switch to Ready mode.

When the Footswitch is not in use, it will go into Sleep mode to conserve battery power. It automatically reactivates when pressed.

7 Installation and Set-Up

7.15 PEAK POWER DISPLAY

This number is shown only when the system is in Pulse mode and presents the value of the peak power based on the power setting and Pulse mode.

7.16 PULSE MODE SELECTION

Pulse mode selection graphically indicates whether the system is in Continuous mode or in Pulse mode.

In Continuous mode, laser power is constantly delivered when the laser console is in **Ready** mode and the wireless Footswitch is activated.

In Pulse mode, laser power is delivered in repetitive pulses, controlled by the Pulse Length and Pulse Interval settings. Pressing the Pulse mode button will allow switching between Pulsed and Continuous modes (Figure 7.28).

Mode*	Pulse Duration (on)	Pulse Interval (off)	Duty Cycle (Time On/Time off)
CP0	10 microseconds	40 microseconds	20%
CP1	100 microseconds	200 microseconds	33%
CP2	1 millisecond	1 millisecond	50%
P3	20 milliseconds	20 milliseconds	50%

*CP = Comfort pulse; P3 = Pulsed mode which is the standard for most diode lasers currently available to the dental market

Figure 7.27



NOTE: Operating the laser at a shorter pulse duration typically results in lower tissue temperature.

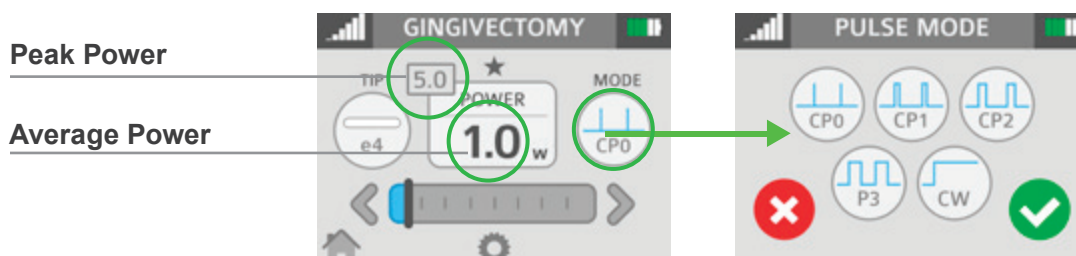

Figure 7.28

7 Installation and Set-Up

7.17 USING THE EPIC X TOUCH SCREEN DISPLAY

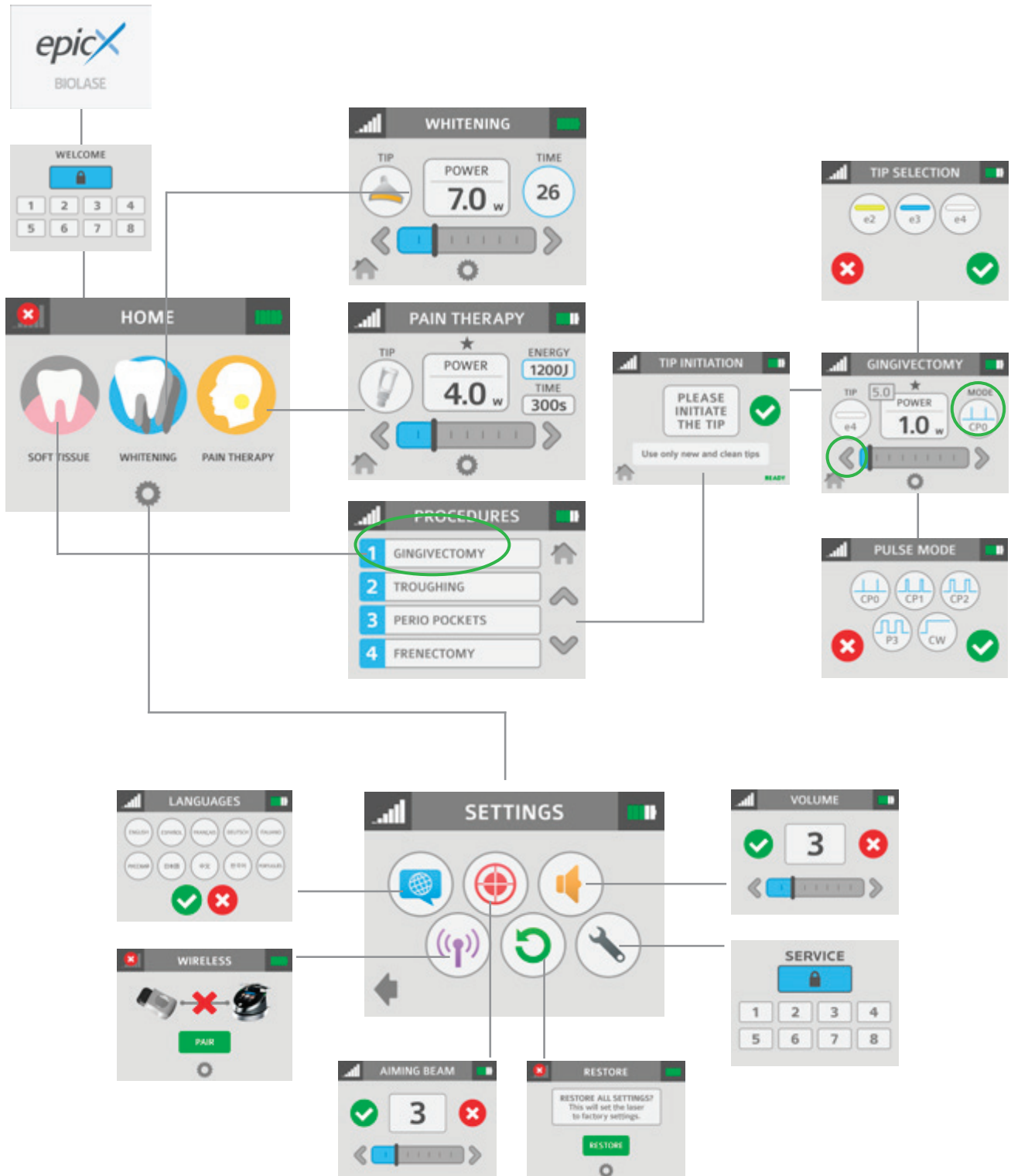

Figure 7.29

7 Installation and Set-Up

7.18 PROCEDURES BUTTON

The Epic X has the ability to store up to 20 pre-set procedures; Epic X is factory-installed with 14 pre-programmed procedural presets and 6 empty slots for custom pre-sets. All of them can be customized to your preference.

To customize the parameters (e.g., power, pulse duration, interval, etc.) for a particular clinical procedure:

1. Go to the PROCEDURES menu by pressing the soft-tissue icon on the HOME screen; scroll to and select the pre-set you wish to overwrite (Figure 7.30).
2. Press and hold the banner on the selected procedure for two seconds (Figure 7.31). The parameters for that procedure will be changed and saved (the laser console will beep when the adjusted settings are saved).



Figure 7.30



Figure 7.31

7.19 TURN THE LASER CONSOLE OFF

- Wind the Fiber Optic Cable onto the fiber spool counterclockwise around the base of the console.
- Place the Handpiece onto the Handpiece Holder.



CAUTION: Verify that the Fiber Optic Cable tubing assembly is not twisted once the Handpiece is returned to the holder. The fiber may break if it is twisted.

- Press the CONTROL button on the front of the console for more than 2 seconds to turn the display off.
- Press the power switch at the rear of the laser console to the OFF (O) position if the laser system will not be used for a long period of time.

8 Clinical Applications

8.1 INTRODUCTION

To efficiently treat tissues it is imperative to understand the nature of the Epic X device. Please review this section carefully, practice on model tissues, and attend a diode laser training session before using this device in a clinical situation.

8.2 SOFT TISSUE SURGERY AND OTHER DENTAL USE

TIP INITIATION: PARAMETERS AND METHOD (NOT REQUIRED IF USING PRE-INITIATED TIPS)

Most soft-tissue surgical procedures require initiation of the fiber Tip. **The TIP INITIATION screen will appear (in READY mode) if Tip initiation is recommended** and the system will automatically go to the settings shown in Section 8.3 based on the Tip used; while in the TIP INITIATION screen, initiate the Tip by following the steps outlined below.

Tip Diameter (µm)	(Preset) Power (W)	Mode
400	1.4	CW
300	1.4	CW
200	Tip initiation not required when used for recommended procedures	

Figure 8.1

- Touch the Tip to the surface of the initiation block, without activating the laser (don't press down on the Footswitch (Figure 8.2).
- Press the Footswitch to activate the laser, allowing the tip to sink into the block. Pull the Tip out when the metal cannula touches the block, still firing until just before the Tip is out of the block (Figure 8.3).
- Press the Footswitch to activate the laser into the air once; a white flash will be visible or the Tip will glow (Figure 8.4).
- Repeat initiation process as needed to ensure the Tip is initiated.

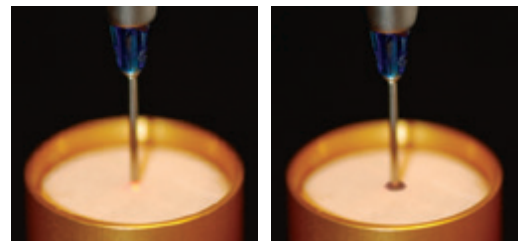

Figure 8.2

Figure 8.3



Figure 8.4

8 Clinical Applications

After Tip initiation is completed, press the check mark to access the screen for the selected procedure.

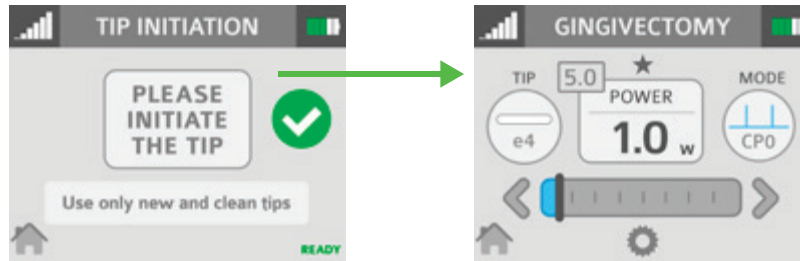

Figure 8.5



CAUTION: If the laser console is in **Ready** mode, the laser will fire if the Footswitch is activated.

PRE-PROGRAMMED SETTINGS FOR DENTAL PROCEDURES

To access the pre-programmed procedure values:

1. Go to the procedures menu by pressing the Soft-tissue icon on the Home screen.
2. Press the button associated with the desired procedure.
3. Press the up and down arrows to scroll for additional procedures.

To store your personal preferred settings for any procedure:

- A. Follow steps 1 and 2 above.
- B. Enter the new values.
- C. Touch and hold the procedure name for more than 2 seconds; you will hear a beeping sound confirming the settings are saved.



NOTE: The procedure pre-sets installed at the factory are based on clinical recommendations and feedback from experienced laser dentists. 300 μ m Tips are recommended for removing thin tissue layers. 400 μ m Tips are recommended for removing fibrous tissue.

Always use clinical judgment when selecting power, pulse, length, and pulse interval parameters to ensure optimal clinical results. **The recommended settings apply only to the 300 μ m and 400 μ m tips.** At all times observe the clinical effects on the treatment area and adjust parameters accordingly.

8 Clinical Applications

8.3 TABLE OF PRE-PROGRAMMED SURGICAL SETTINGS

	Preset name	Indications for Use	Mode	Peak power	Avg. Power	Pulse Interval	Pulse Length	Duty Cycle
1	Gingivectomy/ Gingivoplasty	Reduction of gingival hypertrophy, vestibuloplasty	CP0	5.0 W	1.0 W	0.04 ms	0.01 ms	20%
2	Troughing	Tissue retraction for impression, gingival troughing for crown impressions	CP2	2.0 W	1.0 W	1.0 ms	1.0 ms	50%
3	Curettage	Laser soft-tissue curettage	CP1	2.4 W	0.8 W	0.2 ms	0.1 ms	30%
4	Excision	Fibroma removal, excisional and incisional biopsies, gingivalsincision and excision, operculectomy, oral papillectomies, incision and drainage of absces	CP1	2.7 W	0.9 W	0.2 ms	0.1ms	30%
5	Frenectomy/ Frenotomy	Frenectomy / Frenotomy	CP1	2.0 W	1.0 W	1.0 ms	1.0 ms	50%
6	Implant Recovery	Implant recovery	CP2	2.4 W	1.2 W	1.0 ms	1.0 ms	50%
7	Perio Pockets	Sulcular debridement (removal of diseased, infected, inflamed and necrosed soft-tissue in the periodontal pocket to improve clinical indices gingival index, gingival bleeding index, probe depth, attachment loss and tooth mobility.)	CP2	1.6 W	0.8 W	1.0 ms	1.0 ms	50%
8	Pulpotomy(*)	Pulpotomy, pulpotomy as an adjunct to root canal	CW	0.1 W	0.1 W	N/A	N/A	N/A

8 Clinical Applications

8.3 TABLE OF PRE-PROGRAMMED SURGICAL SETTINGS (CONTINUED)

	Preset name	Indications for Use	Mode	Peak power	Avg. Power	Pulse Interval	Pulse Length	Duty Cycle
9	Crown Lengthening	Soft-tissue crown lengthening	CP1	2.7 W	0.9 W	0.2 ms	0.1 ms	630%
10	Infected Pockets	Laser removal of diseased, infected, inflamed and necrosed soft-tissue within the periodontal pocket	CP2	1.6 W	0.8 W	1.0 ms	1.0 ms	50%
11	Endo(*)	Pulpotomy, pulpotomy as an adjunct to root canal	CW	0.1 W	0.1 W	N/A	N/A	N/A
12	Hemostasis	Hemostasis	CW	0.5 W	0.5 W	N/A	N/A	N/A
13	Aphthous Ulcers	Treatment of canker sores, herpetic and aphthous ulcers of the oral mucosa, leukoplakia	CW	0.7 W	0.7 W	N/A	N/A	N/A
14	Exposure of Unerupted Teeth	Exposure of unerupted teeth	CP2	1.8 W	0.9 W	N/A	N/A	N/A
15-17	Custom 1-3	N/A	CW	0.1 W	0.1 W	N/A	N/A	N/A
18-20	Custom 4-6	N/A	CW	0.1 W	0.1 W	N/A	N/A	N/A

(*) Minimum defaults provided for user setting of Endodontic Procedures such as Pulpotomy and Pulpotomy as an adjunct to root canal therapy.

8 Clinical Applications

8.4 TEETH WHITENING

PRESET VALUES

- 7W, CW, 30 seconds



NOTE: Settings for the teeth whitening procedure are pre-programmed at the factory and are fixed; these settings cannot be adjusted by the user.

The following items are required to perform teeth whitening with the Epic X laser:

- Epic X diode laser
- Whitening Handpiece
- LaserWhite™ 20 Whitening Gel Kit, BIOLASE p/n 7400063, sold separately in packs of five.

Detailed step-by-step instructions, contraindications, precautions, and warnings for teeth whitening are provided with the LaserWhite™ 20 Whitening Gel Kit. Please read the instructions carefully before proceeding.



Figure 8.6 LaserWhite™ 20 Whitening Gel Kit (BIOLASE PN 7400063)

8.5 PAIN THERAPY

The Epic X diode laser is designed to provide near-infrared laser energy to a tissue surface for the purpose of temporary pain relief when applied with the Deep Tissue Handpiece. The pain therapy procedure elevates tissue temperature for the temporary relief of minor pain, the temporary increase in local blood circulation, and the temporary relaxation of muscle, as stated in the indications for use.

Affected muscles and/or joints have to be exposed to an adequate level of therapeutic energy over a short period of time to provide effective ameliorative effects. Some patients may require more than one laser application or a series of treatments before significant improvement is reported. Repeat the therapy as necessary and monitor the progress of the patient's condition throughout the treatment.

Refer to the Fitzpatrick Skin Type Scale when performing pain therapy procedures. The diode wavelength has increased absorption in melanin in the skin, causing greater heating of the skin surface of patients with a higher melanin concentration (darker skin types). Patients with higher melanin content in their skin may feel more discomfort during treatment, which may be alleviated by moving the Handpiece to defocus the energy, or decreasing the power setting.

The default settings for pain therapy are 2.75W, 10 minutes. Power can be adjusted from 2.75W to 4W max, as appropriate, based on the Fitzpatrick Skin Type Scale. Always start at the lowest power setting and increase as necessary.

8 Clinical Applications

PRESET VALUES

The Handpiece can be used in a constant location or moved around the treatment area. If holding the Handpiece in a constant location, adjust the settings on the screen to the recommended initial power settings for therapeutic effect. Always monitor patient response; adjust power and/or distance as needed for patient comfort.

Fitzpatrick Skin Type Scale		Maximum Recommended Power / Exposure
TYPE I	Always burns, never tans (pale white; blond or red hair; blue eyes; freckles).	Not recommended for laser therapy
TYPE II	Usually burns, tans minimally (white; fair; blond or red hair; blue, green, or hazel eyes).	3.25W / 10 minutes
TYPE III	Sometimes mild burn, tans uniformly (cream white; fair with any hair or eye color).	4.00W / 10 minutes
TYPE IV	Burns minimally, always tans well (moderate brown).	3.50W / 10 minutes
TYPE V	Very rarely burns, tans very easily (dark brown).	3.25W / 10 minutes
TYPE VI	Never burns, never tans (deeply pigmented dark brown to darkest brown).	2.75W / 10 minutes

PAIN THERAPY – ADVERSE EFFECTS

Some reddening of the skin at the treatment site is normal due to increased circulation; however, in very rare cases burning or blistering of the skin may occur. Immediately stop treatment, rinse the area with cool water or place a cold pack to the affected area for at least 5 minutes, then apply a burn ointment or spray. **DO NOT USE ICE.**

Patients should be monitored for discomfort and visual skin changes. Redness has been associated with increased temperature at the site of application and increased absorption properties of the skin. If discomfort or redness of the skin occurs at any time during the treatment, you have the following options:

- Move the Handpiece relative to the affected anatomy.
- Defocus the energy by moving the Handpiece further away from the skin.
- Decrease the power setting.
- Stop treatment.

8 Clinical Applications

Patients suffering from general neurovascular conditions, such as neurodegeneration associated with Type II diabetes, may have reduced sensitivity to pain affecting their response to discomfort during treatment. Refer to Section 5 "Contraindications, Warning, and Precautions" for additional information.

PAIN THERAPY – WARNINGS AND PRECAUTIONS

- Scar tissue has been associated with poor circulation and reduced cooling through heat transport by blood; power settings may have to be reduced to avoid overheating.
- Patients with tender or sensitive skin may be hypersensitive to heat; reduce power as necessary to ensure comfort during treatment.
- Patients with swelling and/or inflammation may be sensitive to heat; reduce power as necessary to ensure comfort during treatment.
- Do not treat open wounds.
- Muscle tissue closer to the skin surface may experience a higher absorption of heat; carefully monitor skin temperature and reduce power as necessary.
- Excessive fatty tissue is known to transmit heat without much attenuation; reduce power.
- Different implant materials will respond differently to laser energy and heat; be aware of any implants and their location; avoid direct exposure to laser energy or heat at the site of the implant.
- Avoid treatment of sites that have tattoos.
- Do not apply ointment, creams, lotions or heating lotion patches at, or in close proximity to, the treatment area.
- Do not apply therapies prior to treatment that could change body temperature, such as ultrasound, ice/heat pack, electrical stimulation, or heating patches.
- Do not apply treatment over articles of clothing.
- Do not apply any numbing agents to the affected area as they could reduce the patient's pain sensitivity and response to any treatment discomfort.

8 Clinical Applications

RECOMMENDED USE

There are four main variables that impact the safety and effectiveness of pain therapy procedures:

- Power output.
- Distance from the skin surface.
- Range of movement of the Handpiece.
- Patient skin type.

Safety and effectiveness are described by elevating the skin temperature in the treatment area utilizing the recommended settings (Figure 8.7). Use personal clinical judgment with consideration of the Fitzpatrick Skin Type Scale when setting the procedure parameters; monitor the patient and adjust the settings as necessary for effectiveness and comfort.



NOTE: To avoid potential patient discomfort and/or skin damage, it is advisable to use a test spot prior to the initial treatment to assess the suitability of the selected settings for the individual patient.

9 Maintenance



CAUTION: This device contains no user-serviceable parts other than what is described in this manual. Any attempt to modify or repair the laser by anyone other than an authorized BIOLASE technician or BIOLASE-trained representative may lead to exposure to laser radiation and collateral radiation and will void the product warranty.

9.1 DAILY MAINTENANCE

Use the peel-off clear covers for the laser console supplied with the system. Use disinfectant to wipe down the front panel and Handpiece Holder of the Epic X system after each procedure. **Do not use bleach or abrasive cleansers.**

9.2 CLEANING AND STERILIZATION PROCEDURES

The contamination control suggested for the Epic X Surgical Handpiece and Tips is the steam sterilization method. However, before sterilization, the Surgical Handpiece should be MANUALLY cleaned per the following procedure.



CAUTION: Handpieces and laser Tips are not sterile when sold and must be sterilized prior to initial use, and Handpieces must be cleaned and sterilized between patients. **Tips are single-use only** and must be discarded after single use in a biohazard medical waste sharps container. **Cleaning must be performed within a maximum of 1 hour after the procedure and prior to sterilization.**



CAUTION: The Fiber Optic Cable cannot be autoclaved; doing so will make it unusable. However the Fiber Optic Cable must be disinfected between patients by following the procedure outlined in Step 3 of this section.

STEP 1 - CLEANING PROCESS – SURGICAL HANDPIECE

The cleaning process is intended to remove blood, protein and other potential contaminants, as well as to reduce the quantity of particles, microorganisms and pathogens present from the Handpiece, laser Tip surfaces and crevices. Cleaning should be performed prior to sterilization and must be conducted only by qualified personnel trained in the process who know how to handle the laser Handpiece.

Wear protective latex gloves when handling the contaminated delivery system.

1. After use, carefully remove the Tip from the Handpiece and discard in a biohazard medical waste sharps container.
2. Carefully remove the Handpiece from the Fiber Optic Cable.
3. Prepare any commercially available surgical instrument detergent/enzymatic cleaning solution with a pH of 7.0, such as Enzol® or similar enzymatic presoak and cleaner, per the manufacturer's instructions. (Follow the manufacturer's instructions for disposal of used solution.)
4. Rinse the Handpiece under running lukewarm tap water (22 – 43°C) for a **minimum of 10 seconds** to remove gross soil.

9 Maintenance

5. Wrap the Handpiece in a piece of gauze that has been soaked in the cleaning solution; leave it wrapped in the gauze for a **minimum of 10 minutes**.
6. Unwrap the Handpiece from the gauze and use a soft-bristled brush dipped in the cleaning solution to gently scrub it for **at least 15 seconds**.
7. Rinse the Handpiece under running lukewarm tap water (22-43°C) for a **minimum of 10 seconds** and then dry with a lint-free cloth.
8. Visually inspect the Handpiece for any residual soil. If necessary, repeat steps 5 - 7 until **all** residual soil is removed.

STEP 2 - STERILIZATION PROCESS – SURGICAL HANDPIECE AND TIPS

The steam sterilization process is intended to destroy infectious microorganisms and pathogens.



NOTE: Always perform the procedure immediately after cleaning and prior to use; **only** use appropriate sterilization accessories, i.e., sterilization pouch and autoclave tray. The product packaging is NOT suitable for steam sterilization

1. Place the Handpiece and fiber Tips in separate single-wrap, self-seal autoclave pouches.
2. Place on an autoclave tray; do not stack other instruments on top of the pouches.
3. Place the tray inside the autoclave chamber and set the appropriate cycle as recommended in (Figure 9.1).

Type of Sterilizer	Temperature	Minimum Time	Drying Time
Gravity Displacement	121°C (250°F)	30 minutes	15 – 30 minutes
	132°C (270°F)	15 minutes	
Dynamic-Air-Removal (Pre-Vacuum)	132°C (270°F)	4 minutes	20 – 30 minutes
	134°C (273°F)	3 minutes	20 minutes

Figure 9.1

Once the cycle is completed, remove the tray and let each sterilized item cool and dry.

The Handpiece and Tips must remain in the sterilization pouches until used in order to maintain sterility.

To re-connect the Handpiece to the Fiber Optic Cable, push the Handpiece onto the fiber shaft without twisting until it clicks into place and is secured, as described in Section 7.3.

9 Maintenance

STEP 3 – DISINFECTING THE FIBER OPTIC CABLE

Always disinfect the fiber between patients by wiping it completely with an appropriate disinfecting solution such as Cavicide™ or a similar quaternary ammonium compound product (containing 20% alcohol or less), and follow the manufacturer's instructions. **DO NOT AUTOCLAVE.**

DISINFECTING THE WHITENING HANDPIECE

The Whitening Handpiece is sold with non-sterile disposable protective shields.

The Handpiece and protective shield **cannot be autoclaved**. The clear protective shields are intended for one-time use only and should never be reused to prevent cross-contamination.

To disinfect the Whitening Handpiece, wipe down the Handpiece with gauze and isopropyl alcohol. Always wipe the disposable shield with alcohol prior to use. Discard after single use.

DISINFECTING THE DEEP TISSUE HANDPIECE AND FIBER

The Deep Tissue Handpiece is sold with non-sterile, disposable protective shields.

The Handpiece with connected Fiber Optic Cable and protective shields **cannot be autoclaved**. The clear protective shields are intended for single use only and should never be reused to prevent cross-contamination.

- To disinfect the Deep Tissue Handpiece, wipe the entire outer surface of the Handpiece with cotton gauze and isopropyl alcohol or a mild chemical disinfectant
- Disinfect the attached Fiber Optic Cable by wiping it completely with an appropriate disinfecting solution such as Cavicide™ or a similar quaternary ammonium compound product (containing 20% alcohol or less), and follow the manufacturer's instructions
- Always wipe the disposable shield with alcohol prior to use. Discard after one-time use

9 Maintenance

9.3 FIBER CABLE LENS INSPECTION AND CLEANING

LENS INSPECTION PROCEDURE

The lens is at the distal end of the Fiber Optic Cable (Figure 9.2); this is where debris may accumulate over time with use. To inspect the lens, take the following steps:



CAUTION: DO NOT inspect the lens while the laser system is powered on; the aiming beam or laser beam can permanently impair vision if aimed at the eye.



CAUTION: Never reuse single-use Tips as this will damage the Fiber Optic Cable.

1. Remove the Handpiece from the fiber shaft.
2. Inspect the distal end of the fiber using a magnifier or loupes with at least 10X magnification (Figure 9.3).
3. Inspect the lens.



Figure 9.2

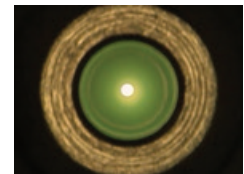

Figure 9.3

CLEANING THE LENS

If debris or dark spots are observed on the lens, clean the window using the procedure outlined below.

1. Always use a new, unused Microbrush (provided) to clean the lens (Figure 9.4).
2. Dip the Microbrush in isopropyl alcohol.
3. Gently rub the lens surface to remove debris or dark spots (Figure 9.5).
4. Repeat as needed using a new Microbrush each time until no residue appears on the swab.



Figure 9.4

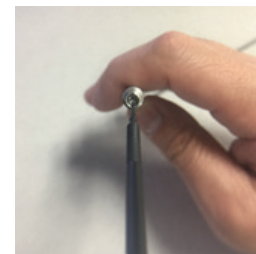

Figure 9.5

9.4 INSTALLING/REPLACING THE CONSOLE BATTERY PACK

1. To install or replace the battery pack, remove the battery cover on the underside of the console using the Phillips screwdriver included with the laser system. (Figure 9.6)
2. To remove the battery, grip the battery at the top and pull the cable away from the connector. Do not tug or wrench the cable from the connector. (Figure 9.7)
3. To install the battery, insert the connector wire from the battery to the unit, making sure the red wire is on the left, and gently place the battery into the compartment.
4. Replace the battery cover on the bottom of the unit, using a standard Phillips screwdriver.

9 Maintenance

5. Connect the power cord of the DC power supply to the unit and plug into a wall outlet. Before first use, you should fully charge the battery for at least three 3 hours. Once the battery is charged, unplug the power cord from the wall outlet and the console. The unit will run on battery power alone.
6. Recycle the used Lithium Ion battery as regulated. Do not throw it in a trash bin.

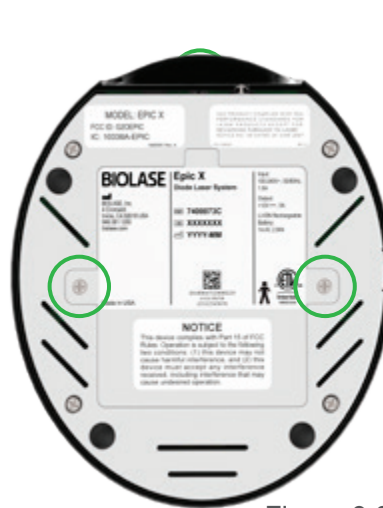

Figure 9.6

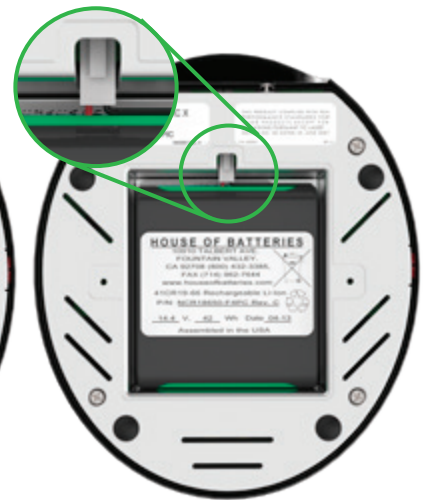

Figure 9.7



NOTE: Only use the battery pack supplied by BIOLASE. The battery pack is a separate accessory (BIOLASE P/N 6400457).

9.5 CHANGING THE WIRELESS FOOTSWITCH BATTERIES

The wireless Footswitch is powered by two AAA batteries. When the batteries are low, a warning message will appear on the touchscreen indicating that the batteries need to be replaced. To replace the batteries, remove the 3 screws on the underside of the Footswitch to remove the battery cover (Figure 9.8); take out the old batteries, and install the new ones, replacing the cover when done. Discard the used batteries as regulated; do not throw them in a trash bin.



Figure 9.8
Battery Cover Screws

Do not press/push/touch the pairing button (Figure 9.9) while changing the batteries, as this will disrupt the pairing of the laser console and Footswitch.

Replacing the batteries may disrupt the pairing of the laser console and Footswitch. If you find the wireless communication has been interrupted, reestablish pairing by following the instructions provided in Section 7.

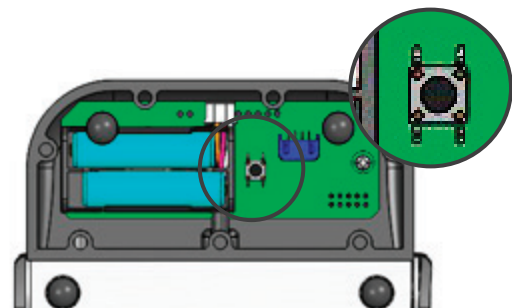

Figure 9.9
Pairing Button (internal view)



NOTE: To ensure the longevity of the battery power, only BIOLASE-supplied batteries are recommended as replacements (BIOLASE p/n 6400463); these are industrial-grade batteries which under normal use have a longer life than conventional AAA batteries.

9 Maintenance

9.6 TRANSPORTATION

The Epic X is susceptible to damage if not handled properly. The unit should ALWAYS be handled carefully and never banged, jarred, jolted, dropped, or knocked.

Do not transport the unit unless it is completely packaged inside its shipping box. If you have any questions regarding transportation please call BIOLASE Service at **1-800-321-6717**.

9.7 STORAGE

The Epic X should be stored in a cool, dry place when not in use under the following environmental conditions:

- Storage temperature: 15°C-35°C (59°F-95°F).
- Relative humidity: 10%-70%, non-condensing.

Cover the unit when not in use for extended periods of time. Store the system in a place where it will not be accidentally bumped or banged.

The Epic X is shipped inside a custom shipping box. Please save and store the box in a cool, dry place for use when transporting the laser, or for long-term storage.

10 Calibration

CALIBRATION

Calibration is recommended every twenty-four (24) months in order to maintain the required accuracy of output power versus displayed power and must be performed only at a BIOLASE-certified depot repair facility to avoid the risk of exposure to laser radiation and collateral radiation, as well as voiding the product warranty. Call BIOLASE Service at **1-800-321-6717** or your Authorized Service Representative to schedule an appointment.

11 Software Specification

SOFTWARE SPECIFICATION

BIOLASE respects the intellectual property of others, and we ask our users to do the same. Epic X software is protected by copyright and other intellectual property laws. This product contains proprietary, copyrighted software developed by BIOLASE, Inc. All rights reserved in the USA and other countries.

TROUBLESHOOTING

Should any of the on-screen messages listed in Figure 12.1 and Figure 12.2 appear, follow the troubleshooting instructions for the specific message as noted below.

12 Troubleshooting



NOTE: For any on-screen message not listed in Figure 12.1, re-power the laser console; if the message does not clear, call BIOLASE Service at **1-800-321-6717** or your Authorized Service Representative.

Screen	Message	Reason	Fix
Warning 1	Temperature high	System is hot	Allow 5-10 minutes for laser to cool down
Warning 2	Battery is low	Battery is low	Plug in DC supply
Warning 3	Battery is not connected	Battery is not connected	Plug in the battery
Warning 4	Footswitch battery is low	Battery on the Footswitch is low	Release Footswitch battery
Warning 5	Footswitch	Footswitch held	Release Footswitch
Alert 1	Wireless not paired	No wireless connection	Re-establish pairing (see sec. 7)
Alert 2	System must be in Ready mode to lase	System is not in Ready mode	Press the control button in any procedure screen

Figure 12.1

12 Troubleshooting





Screen	Message	Reason	Fix
Error 1	Thermistor open	Thermistor open	Call BIOLASE service
Error 2	Thermistor shorted	Thermistor shorted	Call BIOLASE service
Error 3	Shutdown temperature	System too hot	Allow 5-10 minutes for laser to cool down
Error 4	Laser current high/low	Output is out of specs	Call BIOLASE service
Error 5	Footswitch shorted	Footswitch is partially pressed or damaged	Press/release Footswitch or call BIOLASE service
Error 6	ON/OFF button stuck	Key stuck	Press front key
Error 7	Flash corrupted	Memory corrupted	Call BIOLASE service
Error 8	No fiber	Fiber not inserted	Plug in Fiber Optic Cable
Error 9	Lost Footswitch communication	Wireless interference	Reposition console/Footswitch to improve communication
Error 10	Emergency switch	E-switch pressed	Press E-switch again
Error 11	Remote interlock	Remote interlock open	Check remote interlock closed
Error 12	Battery critically low	Battery is critically low	Plug in DC supply
Error 13	Internal error	Internal error occurred	Restart unit
Error 14	Footswitch battery	Footswitch battery critically low	Replace Footswitch battery

Figure 12.2

Appendix A Tip Guide

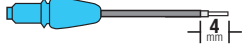
APPENDIX A – TIP GUIDE

NON-INITIATED

Tip	Name	Diameter	Length (mm)	Application	Part Number
	E4-4	400µm	4	Surgical	7400016
	E4-7	400µm	7	Perio	7410003/ 7400019
	E4-9	400µm	9	Perio	7410019
	E3-4	300µm	4	Surgical	7400017
	E3-7	300µm	7	Perio	7410002/ 7400020
	E3-9	300µm	9	Perio	7400020
	E2-4	200µm	4	Surgical	7400018
	E2-14	200µm	14	Endo	7400021
	E2-20	200µm	20	Endo	7400015

Appendix A Tip Guide

PRE-INITIATED

Name	Diameter	Length	Application	Part Number
PI3-4	300µm	4mm	Surgical	7400071
PI3-7	300µm	7mm	Perio	7400064
PI3-9	300µm	9mm	Perio	7400065
PI4-4	400µm	4mm	Surgical	7400067
PI4-7	400µm	7mm	Perio	7400068
PI4-9	400µm	9mm	Perio	7400069









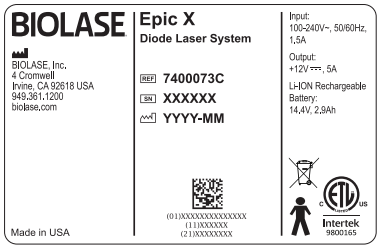

NOTE: All BIOLASE tips for diode lasers are sold non-sterile and are for single-use only. See section 9 in this User Manual for cleaning and sterilization instructions.

Appendix B Accessories

APPENDIX B – ACCESSORIES

PART NO.	DESCRIPTION
6400479	Surgical Handpiece (2-pack)
2400277	Laser Safety Glasses
6400058	Remote Interlock Plug
2400129	Power Cord with Power Supply
6400573	Wireless Footswitch
6400107	Tip Initiation Kit
7400022	Whitening Handpiece
6400180	Whitening Handpiece Disposable Shields (30-pack)
7400063	Laserwhite 20 Whitening Gel Kit (5-pack)
7420001	Deep Tissue Handpiece
6400310	Deep Tissue Handpiece Disposable Shields (qty. 20)
6400465	Peel-off Clear Screen Covers (qty. 20)
6400457	Lithium-Ion Battery Pack for Console
6400463	Battery Pack (2 x AAA)
6400437	Fiber Optic Cable
5400386	Laser Warning Sign

Appendix C Labeling

<p>PRODUCT IDENTIFICATION LABEL:</p> <p>LOCATION: Bottom of laser console.</p>	 <p>BIOLASE Epic X Diode Laser System</p> <p>Input: 100-240V~, 50/60Hz, 1.5A Output: +12V⁺, 5A Li-ION Rechargeable Battery: 14.4V, 2.9Ah</p> <p>7400073C XXXXXX YYYY-MM</p> <p>Made in USA</p> <p>Intertek 9803165</p>
<p>MANUFACTURER</p>	
<p>CATALOG/PART NUMBER</p>	
<p>PRODUCT SERIAL NUMBER</p>	
<p>DATE OF MANUFACTURE</p>	
<p>LASER WARNING: Symbol warns of laser beam hazard. Always wear appropriate eye protection.</p> <p>LOCATION: Back of Laser Console.</p>	
<p>TYPE BF APPLIED PART: The applied part is not conductive to the patient.</p>	
<p>EMERGENCY LASER STOP SWITCH: The switch used in emergencies to stop laser output.</p> <p>LOCATION: Right side of laser console.</p>	
<p>LASER APERTURE WARNING: Indicates visible and/or invisible laser radiation is emitted from this aperture.</p> <p>LOCATION: Back of laser console.</p>	

Appendix C Labeling

CERTIFICATION:

This device complies with FDA laser standards.

THIS PRODUCT COMPLIES WITH FDA PERFORMANCE STANDARDS FOR LASER PRODUCTS EXCEPT FOR DEVIATIONS PURSUANT TO LASER NOTICE NO. 50 DATED 24 JUNE 2007

P/N: 5400341

REV. B

LOCATION:

Bottom of laser console.

WARNING LABEL:

Indicates there is the risk of possible exposure to both infrared and visible laser radiation.



LOCATION:

Back of laser console

FCC AND IC LABEL:

Federal Communication Commission and Industry Canada registration numbers.

MODEL: EPIC X
FCC ID: G20EPIC-1
IC: 10338A-EPIC

5400583 Rev. A

LOCATION:

Bottom of laser console.

REFER TO USER MANUAL



FCC COMPLIANCE NOTICE:

The Footswitch and laser console comply with Part 15 of FCC Rules regarding unlicensed transmissions.

NOTICE

This device complies with Part 15 of FCC Rules. Operation is subject to the following two conditions: (1) this device may not cause harmful interference, and (2) this device must accept any interference received, including interference that may cause undesired operation.

LOCATION:

Bottom of Footswitch.

FOOTSWITCH PRODUCT ID LABEL:

LOCATION:

Bottom of Footswitch.

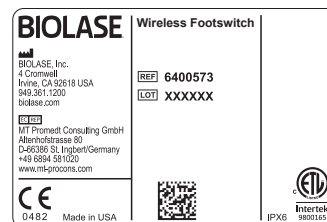





INGRESS PROTECTION CODE:

The Footswitch is water-resistant, protected splashes of water.

IPX6

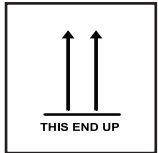
Appendix C Labeling

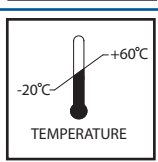
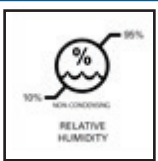
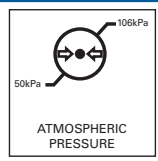
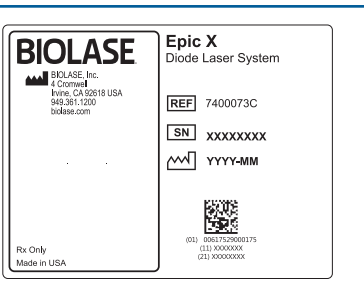
<p>SINGLE USE ONLY – DO NOT REUSE</p>	
<p>WEEE (WASTE ELECTRICAL AND ELECTRONIC): Recycle lithium ion battery as regulated. Do not throw in trash bin.</p>	
<p>THIS END UP LOCATION: Outer carton (shipping box).</p>	
<p>FRAGILE: HANDLE WITH CARE LOCATION: Outer carton (shipping box).</p>	
<p>KEEP DRY LOCATION: Outer carton (shipping box).</p>	
<p>TEMPERATURE LIMITATIONS LOCATION: Outer carton (shipping box).</p>	
<p>HUMIDITY LIMITATIONS LOCATION: Outer carton (shipping box).</p>	
<p>ATMOSPHERIC PRESSURE LIMITATIONS LOCATION: Outer carton (shipping box).</p>	
<p>SYSTEM SHIPPING LABEL: LOCATION: Outer carton (shipping box).</p>	

Appendix C Labeling

PRESCRIPTION STATEMENT:

Federal Law restricts this device to sale by or on the order of a dentist or physician or other licensed medical practitioner

Rx Only

4400417 Rev D

LOCATION: Outer carton (shipping box)

SEE INSTRUCTIONS FOR USE:

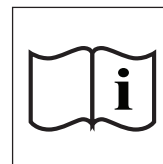

LASER WARNING SIGN

Included in the Welcome Kit; must be placed outside of the operatory whenever the laser system is in use.



DC POWER, USB, REMOTE INTERLOCK LABEL:

Identifies input ports



POWER INPUT RATING:

12 Volts Direct Current, 5 amps

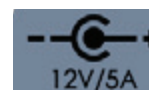

MINI USB INPUT:

For external programming



REMOTE INTERLOCK:

Input for Remote Interlock Connector



Appendix D Safety-Lithium-Ion Battery Packs

APPENDIX D – SAFETY PRECAUTIONS FOR LITHIUM-ION BATTERY PACKS

WHEN USING THE BATTERY:

WARNING:

1. Misusing the battery may cause the battery to get hot, rupture, or ignite and cause serious injury. Be sure to follow the safety rules listed below:
 - Do not place the battery in fire or heat the battery.
 - Do not install the battery backwards so that the polarity is reversed.
 - Do not connect the positive terminal and the negative terminal of the battery to each other with any metal object (such as a wire).
 - Do not carry or store the batteries together with necklaces, hairpins, or other metal objects.
 - Do not pierce the battery with nails, strike the battery with a hammer, step on the battery, or otherwise subject it to strong impacts or shocks.
 - Do not solder directly onto the battery.
 - Do not expose the battery to water or salt water, or allow the battery to get wet.
2. Do not disassemble or modify the battery. The battery contains safety and protection devices which, if damaged, may cause the battery to generate heat, rupture, or ignite.
3. Do not place the battery on or near fires, stoves, or other high-temperature locations. Do not place the battery in direct sunshine or use or store the battery inside cars in hot weather. Doing so may cause the battery to generate heat, rupture, or ignite. Using the battery in this manner may also result in a loss of performance and a shortened life expectancy.

CAUTION:

1. If the device is to be used by small children, the caregiver should explain the contents of the user's manual to the children. The caregiver should provide adequate supervision to ensure that the device is being used as explained in the user's manual.
2. When the battery is worn out, insulate the terminals with adhesive tape or similar materials before disposal.
3. Immediately discontinue use of the battery if, while using, charging, or storing the battery, the battery emits an unusual smell, feels hot, changes color, changes shape, or appears abnormal in any other way. Contact your sales location or BIOLASE if any of these problems are observed.
4. Do not place the batteries in microwave ovens, high-pressure containers, or on induction cookware.
5. In the event that the battery leaks and the fluid gets into one's eye(s), do not rub the eye(s). Rinse well with water and immediately seek medical care. If left untreated, the battery fluid could cause damage to the eye.

Appendix D Safety-Lithium-Ion Battery Packs

WHEN CHARGING THE BATTERY:

WARNING:

1. Be sure to follow the rules listed below while charging the battery. Failure to do so may cause the battery to become hot, rupture, or ignite and cause serious injury.
 - When charging the battery, either use a specified battery charger or otherwise ensure that the battery charging conditions specified are met.
 - Do not attach the batteries to a power supply plug or directly to a car's cigarette lighter.
 - Do not place the batteries in or near fire, or into direct sunlight. When the battery becomes hot, the built-in safety equipment is activated, preventing the battery from charging further, and heating the battery can destroy the safety equipment and can cause additional heating, breaking, or ignition of the battery.
2. Do not continue charging the battery if it does not recharge within the specified charging time. Doing so may cause the battery to become hot, rupture, or ignite.

CAUTION:

- The temperature range over which the battery can be charged is 0°C to 45°C. Charging the battery at temperatures outside of this range may cause the battery to become hot or to break. Charging the battery outside of this temperature range may also harm the performance of the battery or reduce the battery's life expectancy.

WHEN DISCHARGING THE BATTERY:

WARNING:

- Do not discharge the battery using any device except for the specified device. When the battery is used in devices aside from the specified device it may damage the performance of the battery or reduce its life expectancy, and if the device causes an abnormal current to flow, it may cause the battery to become hot, rupture, or ignite and cause serious injury.

CAUTION:

- The temperature range over which the battery can be discharged is -20°C to 60°C. Use of the battery outside of this temperature range may damage the performance of the battery or may reduce its life expectancy.

Appendix E Electromagnetic Compatibility

APPENDIX E – ELECTROMAGNETIC COMPATIBILITY



CAUTION: Medical electrical equipment needs special precautions regarding electromagnetic compatibility (EMC) and needs to be installed and put into service according to the EMC information provided in the following tables.

Portable and mobile radio frequency (RF) communications equipment can affect medical electrical equipment.

Accessories: Medical grade power cord, maximum length 3ft (1 meter), BIOLASE p/n 2400043.

Footswitch: Wireless, BIOLASE p/n 6400573.



WARNING: The use of accessories, other than those specified, except those supplied or sold by Biolase, Inc. as replacement parts for internal or external components, may result in increased EMISSIONS or decreased IMMUNITY of the Epic X diode laser system.

GUIDANCE AND MANUFACTURER'S DECLARATION – ELECTROMAGNETIC EMISSIONS

The Epic X diode is intended for use in the electromagnetic environment specified below.

The customer or the user of the Epic X diode should assure it is used in such an environment.

Emissions Test	Compliance	Electromagnetic environment - guidance
RF emissions CISPR 11	Group 1	The Epic X diode laser is suitable for use in all establishments other than domestic and those directly connected to the public low-voltage power supply network that supplies buildings used for domestic purposes.
RF emissions CISPR 11	Class A	
Harmonic emissions IEC 61000-3-2	Class A	
Voltage fluctuations/ flicker emissions IEC 61000-3-3	Class A	

Appendix E Electromagnetic Compatibility

GUIDANCE AND MANUFACTURER'S DECLARATION – ELECTROMAGNETIC IMMUNITY

The Epic X diode is intended for use in the electromagnetic environment specified below. The customer or the user of the Epic X diode should assure that it is used in such an environment.

Immunity test	IEC 60601 test level	Continuous level	Electromagnetic environment - guidance
Electrostatic discharge (ESD) IEC 61000-4-2	± 6 kV contact ± 8kV air	± 6 kV contact ± 8kV air	Floors should be wood, concrete or ceramic tile. If floors are covered with synthetic material, relative humidity should be at least 30%.
Electrical fast transient/burst IEC61000-4-4	± 2 kV for power supply lines ± 1 kV for input/output lines	± 2 kV for power supply lines N/A	Main power quality should be that of a typical commercial or hospital environment. Input/output that does not apply because the Footswitch cable length is less than 3 meters.
Surge IEC 61000-4-5	± 1 kV differential mode ± 2kV common mode	± 1 kV differential mode ± 2kV common mode	Mains power quality should be that of a typical commercial or hospital environment.
Voltage dips, short interruptions and voltage variations on power supply input lines. IEC 61000-4-11	<5% Ur (>95% dip in UT) for 0.5 cycle 40% Ur (60% dip in UT) for 5 cycles 70% Ur (30% dip in Ur) for 25 cycles <5% Ur (>95% dip in Ur) for 5 seconds	<5% Ur (>95% dip in UT) for 0.5 cycle 40% Ur (60% dip in UT) for 5 cycles 70% Ur (30% dip in Ur) for 25 cycles <5% Ur (>95% dip in Ur) for 5 seconds	Mains power quality should be that of a typical commercial or hospital environment. If the user of the Epic X diode requires continued operation during power mains interruptions, it is recommended that the Epic X diode be powered from an uninterrupted power supply.
Power frequency (50-60 Hz) magnetic field IEC 61000-4-8	3 A/m	3 A/m	Power frequency magnetic fields should be at levels characteristic of a typical location in a typical commercial or hospital environment.

NOTE: Ur is the A.C. mains voltage prior to applications of the test level.

Appendix E Electromagnetic Compatibility

GUIDANCE AND MANUFACTURER'S DECLARATION – ELECTROMAGNETIC IMMUNITY

The Epic X is intended for use in the electromagnetic environment specified below. The customer or the user of the Epic X should assure that it is used in such an environment.

Immunity test	IEC 60601 test level	Continuous level	Electromagnetic environment - guidance
Conducted RF IEC 61000-4-6	3 Vrms 150 kHz to 80 GHz	3 V 3Vm	<p>Portable and mobile RF communications equipment should be used no closer to any part of the Epic X diode laser, including cables, than the recommended separation distance calculated from the equation applicable to the frequency of the transmitter.</p> <p>Recommended separation distance</p> $d = 1.2\sqrt{P}$ $d = 1.2\sqrt{P} \quad 80 \text{ MHz to } 800 \text{ MHz}$ $d = 2.3\sqrt{P} \quad 800\text{MHz to } 2.5\text{GHZ}$ <p>Where P is the maximum output power rating of the transmitter in watts (W) according to the transmitter manufacturer and d is the recommended separation distance in meters (m).</p> <p>Field strengths from fixed RF transmitters, as determined by an electromagnetic site survey,^a should be less than the compliance level in each frequency range.^b</p> <p>Interference may occur in the vicinity of equipment marked with the following symbol:</p> 
Radiated RF IEC61000-4-3	3V/m 80 MHz to 2.5 GHz		

NOTE 1 - At 80 MHz and 800 MHz, the higher frequency range applies.

NOTE 2 – These guidelines may not apply in all situations. Electromagnetic propagation is affected by absorption and reflection from structures, objects, and people.

Appendix E Electromagnetic Compatibility

GUIDANCE AND MANUFACTURER'S DECLARATION – ELECTROMAGNETIC IMMUNITY

The Epic X diode is intended for use in the electromagnetic environment specified below. The customer or the user of the Epic X diode should assure that it is used in such an environment.

Immunity test	IEC 60601 test level	Continuous level	Electromagnetic environment - guidance
---------------	----------------------	------------------	--

A. Field strengths from fixed transmitters, such as base stations for radio (cellular/cordless) telephone and land mobile radios, amateur radio, AM and FM radio broadcast and TV broadcast cannot be predicted theoretically with accuracy. To assess the electromagnetic environment due to fixed RF transmitters, an electromagnetic site survey should be considered. If the measured field strength in the location in which the Epic X diode laser is used exceeds the applicable RF compliance level above, the Epic Pro diode should be observed to verify normal operation. If abnormal performance is observed, additional measures may be necessary, such as reorienting or relocating the Epic X diode laser.

B. Over the frequency range 150 kHz to 80 MHz, field strengths should be less than [V1] V/m.

RECOMMENDED SEPARATION DISTANCES BETWEEN PORTABLE AND MOBILE RF COMMUNICATIONS EQUIPMENT AND THE EPIC DIODE LASER

The Epic X diode is intended for use in an electromagnetic environment in which radiated RF disturbances are controlled. The customer or the user of the Epic X diode can help prevent electromagnetic interferences by maintaining a minimum distance between portable and mobile RF communications equipment (transmitters) and the Epic X diode as recommended below, according to the maximum output power of the communications equipment.

Separation distance according to frequency of transmitter M

Rated maximum output power of transmitter W	Separation distance according to frequency of transmitter M		
	150kHz to 80Mhz $d = 1.2\sqrt{P}$	80 MHz to 800 MHz $d = 1.2\sqrt{P}$	800 MHz to 2.5 GHz $d = 2.3\sqrt{P}$
0.01	0.12	0.12	0.23
0.1	0.38	0.38	0.73
1	1.2	1.2	2.3
10	3.8	3.8	7.3
100	12	12	23

For transmitters rated at a maximum output power not listed above, the recommended separation distance d in meters (m) can be estimated using the equation applicable to the frequency of the transmitter, where P is the maximum output power rating of the transmitter in watts (W) according to the transmitter manufacturer.

NOTE 1 – At 80 MHz and 800 MHz, the separation distance for the higher frequency range applies.

NOTE 2 – These guidelines may not apply in all situations. Electromagnetic propagation is affected by absorption and reflection from structures, objects, and people.

Appendix F Wireless Equipment Statement

APPENDIX F - WIRELESS EQUIPMENT COMPLIANCE STATEMENT

This statement applies only to the wireless portion of the device:

This equipment has been tested and found to comply with the limits for a Class B digital device, pursuant to part 15 of the FCC Rules. These limits are designed to provide reasonable protection against harmful interference in a residential installation. This equipment generates, uses, and can radiate radio frequency energy and, if not installed and used in accordance with the instructions, may cause harmful interference to radio communications. However, there is no guarantee that interference will not occur in a particular installation. If this equipment does cause harmful interference to radio or television reception, which can be determined by turning the equipment off and on, the user is encouraged to try to correct the interference by one or more of the following measures:

- Reorient or relocate the receiving antenna.
- Increase the separation between the equipment and receiver.
- Connect the equipment into an outlet on a circuit different from that to which the receiver is connected.
- Consult the dealer or an experienced radio/TV technician for help.

THIS CLASS [B] DIGITAL APPARATUS MEETS ALL REQUIREMENTS OF THE CANADIAN INTERFERENCE CAUSING EQUIPMENT REGULATIONS.



Intertek
9800165

Conforms to AAMI ES60601-1
IEC60601-1
IEC60601-2-22
IEC62366
IEC60601-2-60
IEC60825-1
Certified to: CSA CSS-S No.60601-1

BIOLASE

biolase.com



BIOLASE, INC.

4 Cromwell
Irvine, CA 92618 USA

Telephone: (888) 424-6527

Telephone: (949) 361-1200

Fax: (949) 273-6687

Service: (800) 321-6717



MADE IN THE USA

Copyright ©2018 BIOLASE, Inc. All rights reserved.

Epic X™ software copyright ©2016 BIOLASE, Inc.

Rx Only

5400620 Rev. B