

11

Renewable Energy

Convening Lead Author (CLA)

Wim Turkenburg (Utrecht University, the Netherlands)

Lead Authors (LA)

Doug J. Arent (National Renewable Energy Laboratory, USA)

Ruggero Bertani (Enel Green Power S.p.A., Italy)

Andre Faaij (Utrecht University, the Netherlands)

Maureen Hand (National Renewable Energy Laboratory, USA)

Wolfram Krewitt[†] (German Air and Space Agency)

Eric D. Larson (Princeton University and Climate Central, USA)

John Lund (Geo-Heat Center, Oregon Institute of Technology, USA)

Mark Mehos (National Renewable Energy Laboratory, USA)

Tim Merrigan (National Renewable Energy Laboratory, USA)

Catherine Mitchell (University of Exeter, UK)

José Roberto Moreira (Biomass Users Network, Brazil)

Wim Sinke (Energy Research Centre of the Netherlands)

Virginia Sonntag-O'Brien (REN21, France)

Bob Thresher (National Renewable Energy Laboratory, USA)

Wilfried van Sark (Utrecht University, the Netherlands)

Eric Usher (United Nations Environment Programme)

Contributing Authors (CA)

Dan Bilello (National Renewable Energy Laboratory, USA)

Helena Chum (National Renewable Energy Laboratory, USA)

Diana Kraft (REN21, France)

Philippe Lempp (German Development Ministry)

Jeff Logan (National Renewable Energy Laboratory, USA)

Lau Saili (International Hydropower Association, UK)

Niels B. Schulz (International Institute for Applied systems Analysis, Austria and Imperial College London, UK)

Aaron Smith (National Renewable Energy Laboratory, USA)

Richard Taylor (International Hydropower Association, UK)

Craig Turchi (National Renewable Energy Laboratory, USA)

Review Editor

Jürgen Schmid (Fraunhofer Institute for Wind Energy and Energy System Technology, Germany)

Contents

Executive Summary	767
Present uses of renewable energy.....	767
Potential and obstacles for renewable energy technologies.....	767
System integration of renewable energy technologies.....	769
Financial and investment issues.....	770
Policy instruments and measures.....	771
Future contribution of renewable energy.....	771
11.1 Introduction	773
11.1.1 Renewable Energy Sources and Potential Energy Supplies.....	773
11.1.2 Renewable Energy Conversion Technologies.....	773
11.1.3 Advantages and Disadvantages of Renewables.....	774
11.1.4 Contribution of Renewables to Global Energy and Electricity Supply.....	775
11.2 Biomass Energy	778
11.2.1 Introduction.....	778
11.2.2 Potential of Bioenergy.....	778
11.2.3 Market Developments.....	779
11.2.4 Biomass Energy Conversion Technology Development.....	782
11.2.5 Economic and Financial Aspects.....	787
11.2.6 Sustainability Issues.....	791
11.2.7 Implementation Issues.....	794
11.3 Hydropower	794
11.3.1 Introduction.....	794

11.3.2	Potential of Hydropower	795
11.3.3	Market Developments	795
11.3.4	Hydropower Technology Developments	796
11.3.5	Economic and Financial Aspects	797
11.3.6	Sustainability Issues	797
11.3.7	Implementation Issues	799
11.4	Geothermal Energy	801
11.4.1	Introduction	801
11.4.2	Potential of Geothermal Energy	801
11.4.3	Market Developments	801
11.4.4	Geothermal Energy Technology Developments	805
11.4.5	Economic and Financial Aspects	807
11.4.6	Sustainability Issues	809
11.4.7	Implementation Issues	811
11.5	Wind Energy	811
11.5.1	Introduction	811
11.5.2	Potential of Wind Energy	811
11.5.3	Market Developments	813
11.5.4	Wind Energy Technology Development	814
11.5.5	Economic and Financial Aspects	817
11.5.6	Sustainability Issues	820
11.5.7	Implementation Issues	821

11.6	Photovoltaic Solar Energy	822
11.6.1	Introduction.....	822
11.6.2	Potential of PV Solar Energy.....	822
11.6.3	Market Developments.....	823
11.6.4	PV Technology Development.....	825
11.6.5	Economic and Financial Aspects.....	830
11.6.6	Sustainability Issues.....	832
11.6.7	Implementation Issues.....	833
11.7	High-Temperature Solar Thermal Energy	833
11.7.1	Introduction.....	833
11.7.2	Potential of High-Temperature Solar Thermal Energy.....	834
11.7.3	Market Developments.....	834
11.7.4	CSP Technology Development.....	837
11.7.5	Economic and Financial Aspects.....	840
11.7.6	Sustainability Issues.....	841
11.7.7	Implementation Issues.....	842
11.8	Low-Temperature Solar Energy	843
11.8.1	Introduction.....	843
11.8.2	Potential of Low-temperature Solar energy.....	843
11.8.3	Market Developments.....	845
11.8.4	Low-temperature Solar Energy Technology Development.....	846
11.8.5	Economic and Financial Aspects.....	851

11.8.6	Sustainability Issues	851
11.8.7	Implementation Issues	851
11.9	Ocean Energy	852
11.9.1	Introduction	852
11.9.2	Potential of Ocean Energy Technologies	853
11.9.3	Market Developments	854
11.9.4	Ocean Energy Technology Developments	855
11.9.5	Economic and Financial Aspects	857
11.9.6	Sustainability Issues	859
11.9.7	Implementation Issues	860
11.10	System Integration	860
11.10.1	Introduction	860
11.10.2	Integration of Renewables into Electricity Supply Systems	860
11.10.3	Renewables in Heating and Cooling	866
11.10.4	The Way Forward	869
11.11	Financial and Investment Issues	869
11.11.1	Introduction	869
11.11.2	Commercial Financing	869
11.11.3	Linking Policy and Investments	873
11.11.4	Public Financing	874
11.11.5	Renewables as a Mainstream Energy Option	874

11.12	Policy Instruments and Measures	875
11.12.1	Introduction.....	875
11.12.2	Need for Policy Intervention and Policy Frameworks.....	875
11.12.3	Policy Approaches for Renewable Energy.....	876
11.12.4	Other Enabling RE Policies.....	879
11.12.5	Heating and Cooling and Transport.....	880
11.12.6	Links with Other Policies.....	881
11.12.7	Development Cooperation.....	883
11.12.8	International Policy Initiatives to Stimulate Renewable Energy.....	885
	References	887

Executive Summary

Renewable energy sources – including biomass, geothermal, ocean, solar, and wind energy, as well as hydropower – have a huge potential to provide energy services for the world. The renewable energy resource base is sufficient to meet several times the present world energy demand and potentially even 10 to 100 times this demand. This chapter includes an in-depth examination of technologies to convert these renewable energy sources to energy carriers that can be used to fulfill our energy needs, including their installed capacity, the amount of energy carriers they produced in 2009, the current state of market and technology development, their economic and financial feasibility in 2009 and in the near future, as well as major issues they may face relative to their sustainability or implementation.

Present uses of renewable energy

Since 1990 the energy provided from renewable sources worldwide has risen at an average rate of nearly 2% a year, but in recent years this rate has increased to about 5% annually (see Figure 11.1.) As a result, the global contribution of renewables has increased from about 74 EJ in 2005 to about 89 EJ in 2009 and represents now 17% of global primary energy supply (528 EJ, see Figure 11.2). Most of this renewable energy comes from the traditional use of biomass (about 39 EJ) and larger-scale hydropower (about 30 EJ), while other renewable technologies provided about 20 EJ.

As summarized in Table 11.1 many renewable technologies have experienced high annual growth rates – some (biofuels, wind, solar electricity, solar thermal, and geothermal heat) even experiencing double-digit growth rates globally over the past five years – and now represent an economy with more than US₂₀₀₅\$230 billion of investment annually. With cumulative installed contributions to the power, fuel, and thermal heat markets growing rapidly, turnkey costs reflect not only the capital intensity and most often zero or low fuel costs of these solutions, but also the technology and scale advancements of the past decades. The levelized costs of energy, particularly for the more mature renewable technologies, offer competitively priced solutions in some markets but are still comparatively expensive in others under current economic pricing schemes.

In 2009, the contribution of renewable energy technologies to the world's electricity generation was roughly 3800 TWh, equivalent to about 19% of global electricity consumption. Renewable power capacity additions now represent more than one-third of all global power capacity additions.

Note that in the figures presented in Table 11.1, the contribution of renewables to the primary energy supply based on the substitution calculation method is presented. Using this method, non-traditional renewables contributed 50 EJ in 2009. Following other calculation methods – see Chapter 1 and Table 11.2 – the total result for 2009 would be different: 28.5 EJ when using the physical content calculation method and 26 EJ when using the direct equivalent calculation method.

Potential and obstacles for renewable energy technologies

The potential of renewables to provide all the energy services needed is huge, as described in Chapter 7 and in the Special Report on Renewable Energy Sources and Climate Change Mitigation of the Intergovernmental Panel on Climate Change, published in 2011 (IPCC, 2011). Further developing and exploiting renewable energy sources using modern conversion technologies would enhance the world's energy security, reduce the long-term price of fuels from conventional sources, and conserve reserves of fossil fuels, saving them for other applications and for future generations. It would also reduce pollution and avoid safety risks from conventional sources, while offering an opportunity to reduce greenhouse gas emissions to levels that will stabilize greenhouse gases in the atmosphere, as agreed upon globally. It could also reduce dependence on imported fuels, minimize conflicts related to the mining

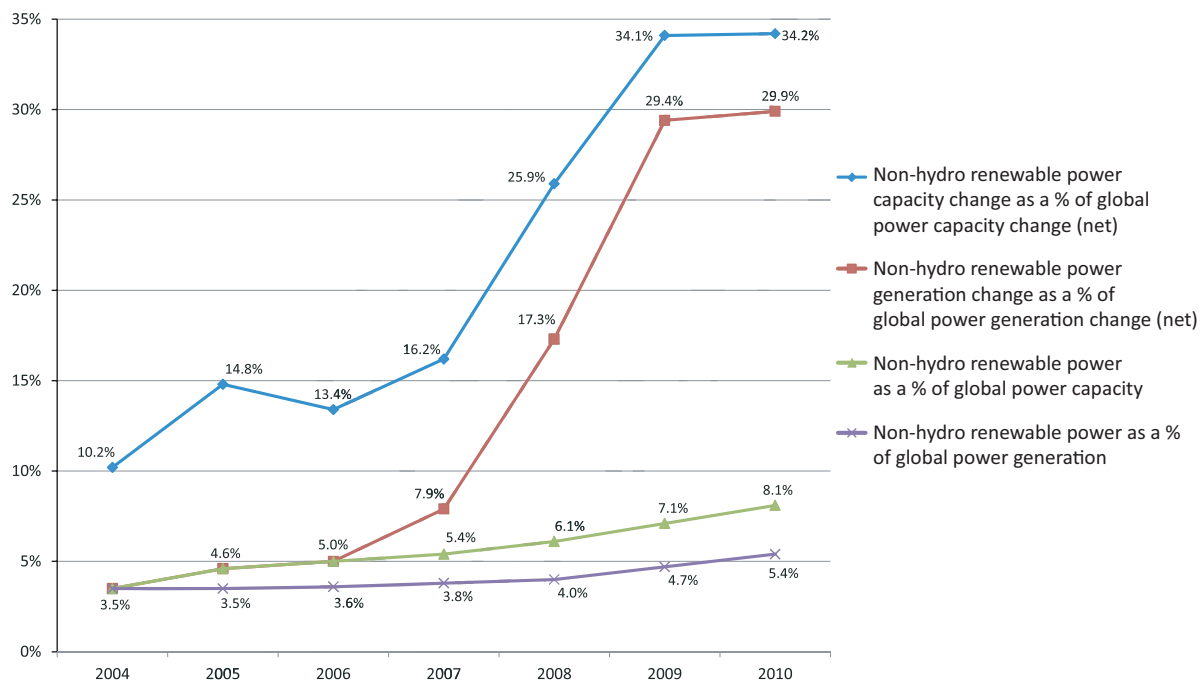

Figure 11.1 | The generating power and capacity of non-hydropower renewable energy sources as a proportion of global power generation and capacity in the period 2004–2010. Source: UNEP and BNEF, 2011.

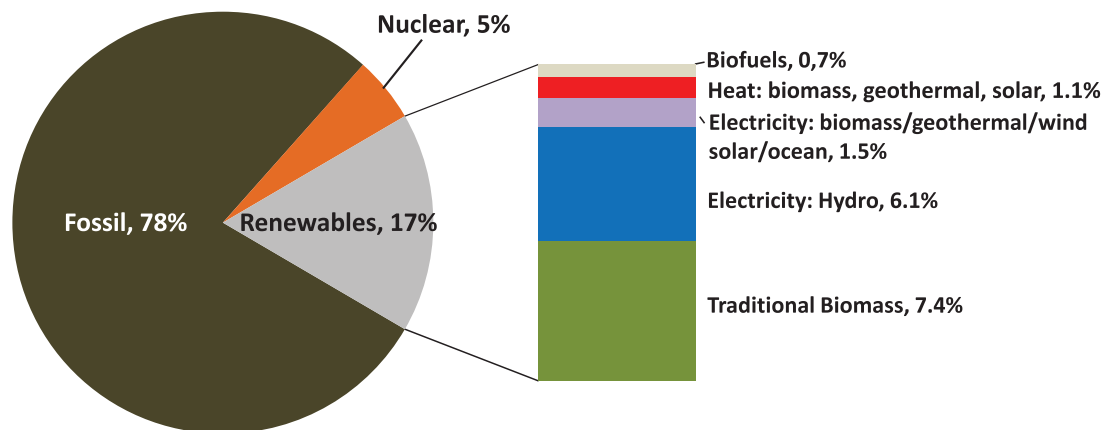

Figure 11.2 | Renewable share of primary energy supply in 2009 (528 EJ). Source: fossil and nuclear fuel use: IEA 2011; renewables: this Chapter.

and use of limited available natural resources, and spur economic development, creating new jobs and regional employment.

But using energy from renewable sources also faces a number of challenges because of their often low spatial energy intensity (J/m^2) or energy density (J/m^3) compared with most fossil fuel and nuclear energy sources, their generally capital-intensive installation costs, their sometimes higher-than-desirable operational costs, and a variety of environmental and

Table 11.1 | Status of Renewable Energy Technologies as of 2009 (all financial figures are in US₂₀₀₅\$).

Technology	Installed capacity increase in past five years (percent per year)	Operating capacity end 2009	Capacity factor (percent)	Secondary energy supply in 2009	Primary energy supply in 2009 (EJ/yr) based on the substitution calculation method	Turnkey investment costs (\$/kW of output)	Current energy cost of new systems	Potential future energy cost
Biomass energy								
Electricity	6	54 GW _e	51 ^a	~ 240 TWh _e	3.3	430–6200	2–22¢/kWh _e	2–22¢/kWh _e
Bioethanol	20	95 bln liter	80 ^a	~ 76 bln liter	2.7	200–660	11–45 \$/GJ	6–30 \$/GJ
Biodiesel	50	24 bln liter	71 ^a	~ 17 bln liter	0.9	170–325	10–27 \$/GJ	12–25 \$/GJ
Heat / CHP	~ 3	~ 270 GW _{th}	25–80	~ 4.2 EJ	5.2	170–1000	6–12¢/kWh _{th}	6–12¢/kWh _{th}
Hydroelectricity								
Total capacity	3	~ 950 GW _e	30–80	~ 3100 TWh _e	32	1000–3000	1½–12¢/kWh _e	1½–10¢/kWh _e
Smaller scale plants (<10 MW)	~ 9	~ 60 GW _e	30–80	~ 210 TWh _e	2.2	1300–5000	1½–20¢/kWh _e	1½–20¢/kWh _e
Geothermal energy								
Electricity	4	~ 10 GW _e	70–90	~ 67 TWh _e	0.7	2000–4000	3–9¢/kWh _e	3–9¢/kWh _e
Direct-use of heat	12	~ 49 GW _{th}	20–50	~ 120 TWh _{th}	0.5	500–4200	2–19¢/kWh _{th}	2–19¢/kWh _{th}
Wind electricity								
Onshore	27	~ 160 GW _e	20–35	~ 350 TWh _e	3.6	1200–2100	4–15¢/kWh _e	3–15¢/kWh _e
Offshore	28	~ 2 GW _e	35–45	~ 7 TWh _e	0.07	3000–6000	7–25¢/kWh _e	5–15¢/kWh _e
Solar Photo-Voltaics								
Electricity	45	~ 24 GW _e	9–27	~ 32 TWh _e	0.33	3500–5000	15–70¢/kWh _e	3–13¢/kWh _e
Solar thermal electricity (CSP)								
Without heat storage	15	0.8 GW _e	30–40	~ 2 TWh _e	0.02	4500–7000	10–30¢/kWh _e	5–15¢/kWh _e
With 12h heat storage	-	-	50–65	-	-	8000–10,000	11–26¢/kWh _e	5–15¢/kWh _e
Low-temperature solar thermal energy								
Low-temperature heat	19	~ 180 GW _{th}	5–12	~ 120 TWh _{th}	0.55	150–2200	3–60¢/kWh _{th}	3–30¢/kWh _{th}
Ocean energy								
Tidal head energy	0	~ 0.3 GW _e	25–30	~ 0.5 TWh _e	0.005	4000–6000	10–31¢/kWh _e	9–30¢/kWh _e
Current energy	-	exp. phase	40–70	negligible	-	5000–14,000	9–38¢/kWh _e	5–20¢/kWh _e
Wave energy	-	exp. phase	25	negligible	-	6000–16,000	15–85¢/kWh _e	8–30¢/kWh _e
OTEC	-	exp. phase	70	negligible	-	6000–12,000	8–23¢/kWh _e	6–20¢/kWh _e
Salinity gradient energy	-	R&D phase	80–90	-	-	-	-	-

^a industry-wide average figure; on plant level the CF may vary considerably.

social concerns related to their development. An additional important issue is the intermittent character of wind, solar, and several ocean energy, requiring backup system investments or other innovations to secure a reliable energy supply.

System integration of renewable energy technologies

System integration studies show no intrinsic ceiling to the share of renewables in local, regional, or global energy supplies, depending on the resource base and energy demand. Intelligent control systems, supported by appropriate

Table 11.2 | Contribution of modern renewables to primary energy supply in 2009 using three calculation methods: the substitution method (with GEA conversion efficiencies), the physical content method, and the direct equivalent method.

Technology	Primary energy supply in 2009 (EJ/yr) using the substitution method	Primary energy supply in 2009 (EJ/yr) using the physical content method	Primary energy supply in 2009 (EJ/yr) using the direct equivalent method
Biomass energy	12.1	12.1	12.1
Hydroelectricity			
Total hydropower capacity	32	11.2	11.2
Smaller scale plants (<10 MW)	2.2	0.76	0.76
Geothermal energy	1.2	3.3	0.67
Wind electricity	3.7	1.3	1.3
Solar PV electricity	0.33	0.12	0.12
Solar thermal electricity (CSP)	0.02	0.05	0.007
Low-temperature solar thermal energy	0.5	0.43	0.43
Ocean energy	0.005	0.002	0.002
Total supply	49.9	28.5	25.9

energy storage systems and energy transport infrastructure, will help renewable energy meet the energy demands of different sectors. However, the variability of wind, solar, and several ocean energy resources can create technical or cost barriers to their integration with the power grid at high levels of penetration (20% or above).

To reduce or overcome these barriers, the main approaches in the electricity sector involve: drawing power from geographically larger areas to better balance electricity demands and supplies; improving network infrastructures; increasing the transmission capacity, including the creation of so-called supergrids for long-distance power transmission; developing the Smart Grid further; applying enhanced techniques to forecast intermittent energy supplies hours and days ahead with high accuracy; increasing the flexibility of conventional generation units (including dispatchable renewables) to respond to load changes; using demand-side measures to shift loads; curtailing instantaneous renewable supplies when necessary to guarantee the reliability of power supplies; and further developing and implementing energy storage techniques.

Financial and investment issues

Annual investments in new renewables have increased tremendously, from less than US₂₀₀₅\$2 billion in 1990 to about US₂₀₀₅\$191 billion in 2010, excluding investments in larger-scale hydropower. Including large hydropower, investments were about US₂₀₀₅\$230 billion in 2010. The quickest growth in sustainable energy financing has come from three sectors of the financial community that had previously shown little interest: venture capital and private equity investors, who provide the risk capital needed for technological innovation and commercialization; public capital markets, which mobilize the resources needed to take companies and projects to scale; and investment banks, which help raise capital and arrange mergers and acquisitions. The engagement of these new financial actors has signaled a broader scale-up in asset financing of the investment in actual generating plant capacity.

In the period 2004–2009, the annual growth rates in renewable energy investments were 32% for financing technology commercialization, 45% for financing the construction of projects, and 85% for financing equipment manufacturing and scale-up. This fast-tracking of alternative energy technologies into the commercial mainstream is beginning to change

the energy paradigm, although much more growth will be needed before renewables can become the world's primary source of energy.

Policy instruments and measures

A key issue is how to accelerate the deployment of renewables so that deep penetration of these technologies into the energy system can be achieved quickly. Renewable energy technologies face a number of factors that make it harder for them to compete based solely on costs: their capital intensity, scale, and resource risk; their discounted value to traditional utility operators; their real or perceived technology risk; the absence of full-cost accounting for environmental impacts on a level playing field; generous subsidies to the use of conventional energy sources; and a lack of recognition of their long-term value for reducing utilities' exposure to variable fuel costs. These issues have a negative impact for investors by extending the time frame for returns or by increasing risk and the expected rate of return. The risks can be reduced by using public-sector financial or market instruments such as guarantees in terms of market access, market size, and price security.

A wide range of regulatory, fiscal, and voluntary policies have been introduced globally to promote renewable energy – whether renewable electricity, renewable heat, or renewable fuels. These serve a range of technology-specific objectives, including innovation, early-stage development and commercialization, manufacturing, and market deployment, as well as wider political goals such as creating new manufacturing bases for a technology, local and global environmental stewardship, and economic prosperity. These policies all help to reduce risk and encourage renewable energy development, and they are generally used in combination. Integrating renewable energy into the conventional energy system will require a portfolio approach that addresses key issues such as comprehensive and comparable cost-benefit analysis of all energy options, provision of stable and predictable policy environments, and removal of market barriers and competing subsidies for fossil fuels, thus increasing the probability for successful innovation and commercialization, provided that the policies complement one another.

Of the market pull policies, two are most common. Feed-in tariffs (FITs) ensure that renewable energy systems can connect and supply their power to the grid and offer a set price for renewable energy supplies. Policies known as quota or obligation mechanisms (also referred to as Renewable Portfolio Standards, Renewable Electricity Standards, or Renewable Fuel Standards) set an obligation to buy but not necessarily an obligation on price. So far, FITs have been used for electricity only, although some countries are now considering how to provide them for heat. Quotas have so far been used for electricity, heat, and transport. Biofuel mandates are now common globally.

The rapid expansion in renewables, which has largely taken place in only a few countries, has usually been supported by incentives or driven by quota requirements. The FITs used in the majority of European Union countries, China, and elsewhere have been exceptionally successful. The number of states, provinces, and countries that have introduced policies to promote renewable energy doubled in the period 2004–2009.

Future contribution of renewable energy

Many studies have been done on the potential of renewable energy in the remainder of the twenty-first century. Most of them indicate that the contribution of these sources, excluding traditional and non-commercial uses, could increase from today's 10% of world energy supply to 15–30% in 2030, to 20–75% in 2050, and to 30–95% in 2100, depending on assumptions made about economic growth, the volume of investments in energy efficiency and energy technology development, policies and measures to stimulate the deployment of different technologies, and public acceptance of these technologies. Some studies suggest that by 2050, renewable sources could provide 75–95% of the world's

energy, or even all of it, if there is enough societal and political will to choose a path of clean energy development that focuses mainly on renewable sources; on new energy transmission, distribution, and storage systems; and on strong improvements in energy efficiency. There is, however, no consensus on whether such a deep penetration of renewables can be achieved in practice within the indicated time frames because of physical limits on the rate at which new technologies can be deployed, the need to design targeted policies to accelerate the deployment of specific technologies, and the difficulty of curtailing energy use through actions on the demand side.

11.1 Introduction

This chapter presents an in-depth examination of major renewable energy technologies, including their installed capacity and energy supply in 2009, the current state of market and technology development, their economic and financial feasibility in 2009 and in the near future, as well as major issues they may face relative to their sustainability or implementation. Renewable energy sources have been important for humankind since the beginning of civilization. For centuries, biomass has been used for heating, cooking, steam generation, and power production; solar energy has been used for heating and drying; geothermal energy has been used for hot water supplies; hydropower, for movement; and wind energy, for pumping and irrigation. For many decades renewable energy sources have also been used to produce electricity or other modern energy carriers.

Renewable energy can be defined as “any form of energy from solar, geophysical, or biological sources that is replenished by natural processes at a rate that equals or exceeds its rate of use” (Verbruggen et al., 2011). In a broad sense, the term renewable energy refers to biomass energy, hydro energy, solar energy, wind energy, geothermal energy, and ocean energy (tidal, wave, current, ocean thermal, and osmotic energy). In the literature (see, e.g., UNDP et al., 2000) the term “new renewable” is also used, referring to modern technologies and approaches to convert energy from renewable sources to energy carriers people can use, taking into account sustainability requirements. In general, “new renewable” includes modern biomass energy conversion technologies, geothermal heat and electricity production, smaller-scale use of hydropower, low- and high-temperature heat production from solar energy, wind conversion machines (wind turbines), solar photovoltaic and solar thermal electricity production, and the use of ocean energy (UNDP et al., 2000; REN21, 2005; Johansson et al., 2006).

11.1.1 Renewable Energy Sources and Potential Energy Supplies

The energy of renewable sources originates from solar radiation (solar energy and its derivatives), geothermal heat (from the interior of the earth), and gravitational energy (mainly from the moon). The energy flow from these sources on Earth is abundant. Tapping just a small fraction of it would in theory be enough to deliver all energy services humanity needs.

A major energy source on Earth is solar energy. As indicated in Figure 11.3, the amount of solar energy directly available for energy conversion in principle is at least more than 1000 times the primary energy use of humankind at present (about 528 exajoules (EJ) in 2009). And in theory, the potential of geothermal energy and ocean energy is also impressive. In practice, however, only a fraction of these potentials can be exploited. Nevertheless, this chapter describes how this fraction can be equivalent to perhaps several times present global energy use.

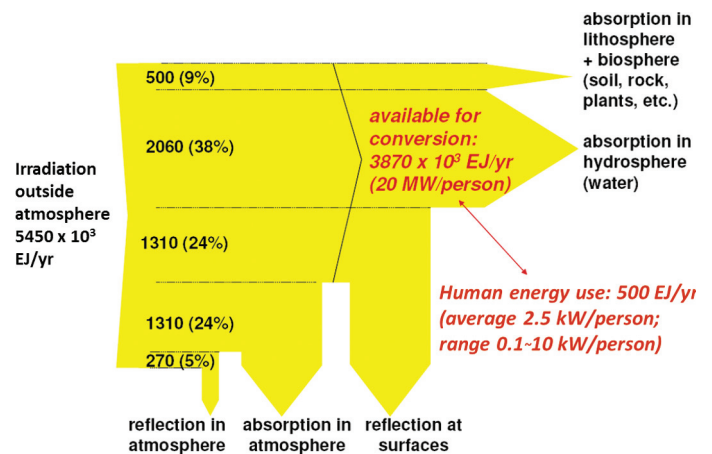

Figure 11.3 | The solar resource and its flows on Earth. The amount of solar energy available on Earth (estimated at 3.9 million EJ/yr) is many times the present human energy use (~528 EJ in 2009).

Table 11.3 presents a summary of the theoretical and technical potential of renewable sources to contribute to the production of energy carriers, based on the *World Energy Assessment* (WEA) published in 2000 (UNDP et al., 2000), on the Special Report on Renewable Energy Sources and Climate Change Mitigation of the Intergovernmental Panel on Climate Change (IPCC, 2011) and on Chapter 7. This chapter focuses on the techno-economic potential of renewables in the longer term, which is a portion of the technical potential, taking into account socioeconomic and environmental constraints. In the literature, “market potential” and “implementation potential” of renewables are also sometimes distinguished, showing a further reduction of the potential of renewables as socioeconomic barriers are taken into account and, in the case of “implementation potential,” as policies to promote the deployment of renewables as well as public attitudes are considered.

11.1.2 Renewable Energy Conversion Technologies

A wide variety of technologies are available or under development to provide affordable, reliable, and sustainable energy services from renewables (see Table 11.4), but the stage of development and the competitiveness of various technologies differ greatly. In addition, performance and competitiveness are determined by local aspects such as resource availability, technological infrastructure, socioeconomic conditions, policy measures, and the cost of other energy options.

All renewable energy sources can be converted to electricity. Only a few of them can be used to produce solid, liquid, or gaseous fuel directly, as well as heat. Some of the major sources are intermittent, e.g., solar and wind energy, which can create challenges in adopting these sources while maintaining the reliability of the overall energy supply, depending on how widely they are used.

Table 11.3 | Overview of the technical potential of renewable energy sources in EJ/yr.

Renewable Energy Source	Technical Potential (EJ/yr)		
	WEA (2000)	Chum et al. (2011)	GEA (2012)
Geothermal energy ^{a,b}	5000	130–1420	810–1545
Direct solar energy ^{c,a}	> 1575	1575–50,000	62,000–280,000
Wind energy ^{d,a}	640	85–580	1250–2250
Biomass energy – land-based ^{e,a}	> 276	50–500	160–270
Hydropower ^a	50	50–52	50–60
Ocean energy ^{f,a}	not estimated	7–331	3240–10,500
TOTAL	> 7600	1900–52,800	76,500–294,500

^a Figures from WEA and GEA are based mainly on their own assessment, whereas those from Chum et al. are the result of a review of available literature.

^b The WEA estimates relate to the amount of energy stored underground; the GEA estimates, to the annual terrestrial heat flow.

^c Differences in outcome between WEA and GEA are due to different approaches to calculating the potentials.

^d One reason for the increase of the technical potential between WEA and GEA is the inclusion of offshore wind energy.

^e Excluding marine biomass energy; the difference in theoretical potential between WEA and GEA can be explained by different calculation methods; restrictions related to sustainability criteria are the main reason for the decrease in estimated technical potential between WEA and GEA.

^f The indicated technical potential comes mainly from ocean thermal energy conversion; the GEA numbers refer to the potential before conversion, the IPCC SRREN numbers to the potential after conversion.

11.1.3 Advantages and Disadvantages of Renewables

Developing and exploiting renewable energy sources using modern conversion technologies can be highly responsive to national and international policy goals formulated because of environmental, social, and economic opportunities, objectives, and concerns:

- Diversifying energy carriers for the production fuels, electricity, and heat; enhancing energy security; and reducing the long-run price of fuels from conventional sources;
- Reducing pollution, environmental emissions, and safety risks from conventional energy sources that damage human health, natural systems, crops, and materials;
- Mitigating greenhouse gas emissions down to levels that can be sustained;
- Improving access to clean energy sources and conversion technologies, thereby helping to meet the Millennium Development Goals (MDGs) while taking advantage of the local availability of renewables;
- Reducing dependence on and minimizing spending on imported fuels;
- Reducing conflicts related to the mining and use of limited available natural resources, as most renewable energy sources are well distributed;

- Spurring economic development, creating new jobs and local employment, especially in rural areas, as most renewable energy technologies can be applied in small-, medium-, and large-scale systems in distributed and centralized application;
- Balancing the use of fossil fuels, saving them for other applications and for future generations.

Making use of renewable energy sources also has some disadvantages and drawbacks, part of which are intrinsic and part of which are due to the status of technology development:

- The spatial energy intensity (J/m^2) or density (J/m^3) of renewable energy sources is often low compared with most fossil fuel and nuclear energy sources. Consequently, space is needed where these renewable sources are converted to allow them to deliver most – and finally, perhaps all – of the energy needed. But this may create competition with other claims and requirements for the use of land, including food production, the protection of ecosystems, and biodiversity conservation. Strategies to mitigate these concerns include multifunctional land use, technologies with high conversion efficiencies, and the combination of renewables with measures to improve energy efficiency.
- Although the energy from renewable sources is most often available for free (which reduces vulnerabilities associated with the price volatility of fossil fuels), renewable energy conversion technologies are often quite capital-intensive: operating costs (fuel costs) are replaced by initial costs (installed capital costs). This can make renewables less attractive, especially when high discount rates are

Table 11.4 | Modern renewable energy conversion technologies.

Technology	Energy Product	Status
Biomass energy		
Combustion (domestic scale)	Heat (cooking, space heating)	Widely applied; improvement of technologies
Combustion (industrial scale)	Heat, steam, electricity, CHP (combined heat and power)	Widely applied; potential for improvement
Gasification/power production	Electricity, heat, CHP	Demonstration phase; large-scale deployment of small units in certain countries
Gasification/fuel production	Hydrocarbons, Methanol, H ₂	Development and demonstration phase
Hydrolysis and fermentation	Ethanol	Commercially applied for sugar/starch crops; production of fuels from lignocellulose under development
Pyrolysis/production liquid fuels	Bio-oils	Pilot and demonstration phase
Pyrolysis/production solid fuels	Charcoal	Widely applied commercially
Extraction	Bio-diesel	Commercially applied
Digestion	Biogas	Commercially applied
Marine biomass production	Fuels	R&D phase
Artificial photosynthesis	H ₂ or other fuels	Fundamental and applied research phase
Hydropower		
Mini-hydro	Movement	Remotely applied; well-known technology
Small and larger-scale hydropower	Electricity	Commercially applied
Geothermal energy		
Power production	Electricity	Commercially applied locally
Direct heating	Heat, steam	Commercially applied locally
Heat pumps	Heat	Increasingly applied
Wind energy		
Small wind machines	Movement, electricity	Water pumping / battery charging
Onshore wind turbines	Electricity	Widely applied commercially
Offshore wind turbines	Electricity	Demonstrated; initial deployment phase
Solar energy		
Passive solar energy use	Heat, cold, light, ventilation	Demonstrations and application, combined with energy-efficient buildings
Low-temperature solar energy use	Heat (water and space heating, cooking, drying) and cold	Solar collectors commercially applied; solar drying and cooking locally applied
Photovoltaic solar energy conversion	Electricity	Widely applied, remote and grid-connected; high learning rate
Concentrated solar power	Heat, steam, electricity	Demonstrated; initial deployment phase
Ocean energy		
Tidal head energy	Electricity	Applied locally; well-known technology
Wave energy	Electricity	Some experience; research, development, and demonstration (RD&D) phase
Tidal and ocean current energy	Electricity	Some experience; RD&D phase
Ocean thermal energy conversion	Heat, cold, electricity	Some experience; some application of cold use; other technologies mainly in RD&D phase
Salinity gradient / osmotic energy	Electricity	RD&D phase

applied, depending on the level of investments needed as well as governmental interventions.

- The levelized cost of energy (LCOE) from renewables is often not yet competitive in the (distorted) marketplace, especially in grid-connected applications. This may change, however, as renewable energy costs are brought down through technological learning while penetrating markets. Also, using conventional energy sources will become more expensive due to resource depletion and policies to internalize external costs.
- The exploitation of renewable energy sources may entail environmental and social concerns, as experienced with, for instance, electricity production from hydropower and wind energy and the use of biomass resources.
- The intermittent character of the production of energy carriers from wind, solar, and wave energy may set specific requirements for

the total energy system to achieve a reliable energy supply. It may require methods to predict renewable energy supplies many hours ahead, management of energy demands, availability of backup power, development of storage options, and enhanced flexibility of energy systems.

As most of these issues have to be solved in an acceptable manner within a few decades (see Cluster I, Chapters 2–6 of this assessment), this chapter also discusses policies and measures to create an environment that will enable deep penetration of renewable energy technologies into existing and new energy systems in the period 2020–2050.

11.1.4 Contribution of Renewables to Global Energy and Electricity Supply

In 2009, renewable energy, including traditional use of biomass, contributed about 89 EJ (17%) to the world's primary energy use, mostly

Table 11.5 | Contribution of renewables to global primary energy supply in 1998, 2005, and 2009, calculated using the substitution method (see Chapter 1).

Category	Renewable Energy Supply		
	1998 (WEA)	2005 (IPCC 2007)	2009 (this chapter)
Traditional biomass ^a	38 EJ	37 EJ	39 EJ
Larger-scale hydropower	26 EJ	24 EJ ^b	30 EJ
New renewables			
- Modern biomass	7.0 EJ	9.0 EJ	12.1 EJ
- Geothermal energy	0.6 EJ	1.9 EJ	1.2 EJ
- Wind energy	0.2 EJ	0.9 EJ	3.7 EJ
- Smaller-scale hydropower	0.9 EJ	0.8 EJ	2.2 EJ
- Low temp. solar energy	0.05 EJ	0.2 EJ	0.55 EJ
- Solar PV	0.005 EJ	0.2 EJ	0.33 EJ
- Conc. Solar Power / STE	0.01 EJ	0.03 E	0.02 EJ
- Ocean energy	<u>0.006 EJ</u>	<u>0.02 EJ</u>	<u>0.005 EJ</u>
	9 EJ	13 EJ	20 EJ
TOTAL	73 EJ	74 EJ	89 EJ

^a After correction for differences between calculation methods applied.

^b It is unclear why in 2005 the energy produced is below the WEA figure for 1998, whereas installed capacity increased substantially (see also Table 11.6).

through traditional biomass (about 39 EJ or 7%)¹ and larger-scale hydropower (about 30 EJ or nearly 6%), whereas the share of new renewables was 20 EJ (about 4%).² The contribution of renewables to electricity production in 2009 was around 3800 terawatt-hours (TWh), equivalent to about 19% of global electricity consumption, with new renewables accounting for about 900 TWh (4.5%). Table 11.5 presents an overview of the share of renewables in global energy use in 1998, 2005, and 2009. Note that these figures originate from different sources and that they represent savings on fossil fuel consumption as explained in Chapter 1 and footnote 2.

Since 1990 the use of energy from renewable sources has increased about nearly 2%/yr. As total primary energy use has increased at about the same rate, the relative contribution remained almost constant (IEA, 2009), but it is increasing the last few years. Investments in new renewables have increased tremendously, from less than US₂₀₀₅\$2 billion in 1990 to about US₂₀₀₅\$191 billion in 2010, excluding investments in larger-scale hydropower. Including larger-scale hydropower, investments in 2010 were about US₂₀₀₅\$230 billion (UNEP and BNEF, 2011; see Section 11.11).

To illustrate some impacts, Table 11.6 shows the increase in installed power generating capacity, heat and hot water production, and the

1 The contribution of traditional biomass in 2008 and 2009 can be estimated at 39 ± 10 EJ; see Section 11.2.

2 Different studies present different numbers for the contribution of renewables to primary energy supply. This is partly due to uncertainty about the contribution of traditional biomass energy use. The main reason, however, is the calculation method applied when converting generated heat and electricity from renewables to primary energy; see Chapter 1 and table 11.2. GEA applies the substitution method for non-combustible fuels assuming a conversion efficiency of 35% in electricity production and 85% for heat production.

production of liquid fuels between 1998 and the years 2008, 2009, and 2010 based on data published by UNDP et al. (2000) and by REN21 (2009; 2010; 2011). Throughout this chapter, an in-depth analysis of the status and contribution of each technology is made, sometimes providing slightly different numbers.

Many of the developments indicated in Table 11.6 are taking place in western industrial countries and in countries like China, Brazil, and India. However, impressive developments are also found in remote areas of developing countries (REN21, 2009). At present, nearly 600 million households depend on traditional biomass (fuelwood, dung, agricultural residues) for cooking and heating. Improving the efficiency of biomass stoves can save 10–50% of biomass consumption, strongly improve indoor air quality, and reduce time spent on collection of the biomass. More than 220 million improved stoves are now found around the world, mainly in China (180 million) and India (34 million), whereas in Africa this number is over 8 million (REN21, 2009).

In rural areas, small-scale thermal biomass gasification is also applied, especially in India and China, where the gas is used for cooking, milling, drying, and electricity generation, for example. About 25 million households worldwide, especially in China (20 million) and India (3 million), receive energy for lighting and cooking from biogas produced in household-scale plants (REN21, 2009). By 2007 more than 2.5 million households were receiving electricity, mainly for lighting and communication, from solar home systems. On the order of 1 million small-scale windmills are in use for mechanical water pumping, mainly in Argentina and South Africa. In remote areas and on islands worldwide, tens of thousands of mini-grids exist, often powered by hybrid electricity supply systems using renewables like solar PV, wind, biomass, and mini-hydro combined with batteries or backup power provided by a diesel generator (REN21, 2009). More than half of the global supply of low-temperature solar heat is found in China (see Section 11.8).

Many studies have been done on the potential contribution of renewable energy to the global energy supply in the twenty-first century. Figure 11.4 show the results for the BLUE Map scenario of the International Energy Agency (IEA), whereas Figure 11.5 also shows results for the baseline scenario of IEA and for other energy sources (IEA, 2010a). Most studies indicate that the contribution of renewables to future energy supply – excluding traditional and non-commercial uses – could increase from the present figure of about 10% up to 15–30% in 2030, 20–76% in 2050, and 30–95% in 2100, depending on assumptions made about economic growth, investments in energy efficiency and energy technology development, policies and measures to stimulate the deployment of different technologies, and public acceptance of these technologies. (See, e.g., UNDP et al., 2000; IPCC, 2000, 2007a, 2011; WGBU, 2003; Johansson et al., 2006; IEA, 2008a; 2008b; 2009a; 2010a; 2010b; Shell, 2008; 2011; Greenpeace and EREC, 2007; 2010; Krewitt et al. 2009; NEAA, 2009; ECF, 2010; WWF and Ecofys, 2011; See also Chapter 17.)

Table 11.6 | Installed capacity to generate electricity from renewable energy sources (gigawatts, GW) as well as amount of process heat (GW_{th}) and liquid fuels (billion liters per year) produced in 1998, 2008, 2009 and 2010

POWER GENERATION ^a	Existing end 1998 (UNDP et al., 2000)	Existing end 2008 (REN21, 2009)	Existing end 2009 (REN21, 2010)	Existing end 2010 (REN21, 2011)
Hydropower	665 GW	945 GW	980 GW	1010 GW
Biomass power	40 GW	52 GW	54 GW	62 GW
Wind power	10 GW	121 GW	159 GW	198 GW
Geothermal power	8 GW	10 GW	11 GW	11 GW
Solar PV (grid connected)	0.2 GW	13 GW	21 GW	40 GW
Concentrated Solar Power	0.3 GW	0.5 GW	0.6 GW	1.1 GW
Ocean power	0.3 GW	0.3 GW	0.3 GW	0.3 GW
HOT WATER / HEATING				
Biomass heating	~ 200 GW _{th}	~ 250 GW _{th}	~ 270 GW _{th}	~ 280 GW _{th}
Solar collectors	~ 18 GW _{th} ^b	145 GW _{th}	180 GW _{th}	185 GW _{th}
Geothermal heating	11 GW _{th}	~ 45 GW _{th}	~ 51 GW _{th}	~ 51 GW _{th}
LIQUID FUELS				
Bio-ethanol production	18 bln liters/yr	67 bln liters/yr	76 bln liters/yr	86 bln liters/yr
Bio-diesel production	negligible	12 bln liters/yr	17 bln liters/yr	19 bln liters/yr

^a For comparison: total installed electric power capacity in 2008 was 4700 GW.

^b As indicated in the WEA update in 2004 (UNDP et al., 2004), this figure is probably too low.

Source: UNDP et al., 2000; REN21, 2009; 2010; 2011.

Some studies suggest that 75–95% or even 100% contributions from renewables can be achieved by 2050 regionally (in the European Union (EU), for instance) as well as globally if there is enough societal and political will to choose an energy development focusing mainly on renewables and new energy transmission, distribution, and storage systems, along with strong improvements in energy efficiency (Greenpeace and EREC, 2007; 2010; Krewitt et al, 2009; ECF, 2010; WWF and Ecofys, 2011). Figures 11.6 and 11.7 show results of two of these studies.

It should be noted, however, that there is no consensus about whether deep penetration of renewables up to the level indicated in these studies can be achieved in practice within the time frames indicated in the Figures because of physical limits to the rate at which new technologies can be deployed, the need to design policies targeted at specific technologies to accelerate deployment, and actions required on demand side to (strongly) increase energy efficiencies and curtail energy use (Kramer and Haigh, 2009).

The remainder of this chapter investigates the status and potential development of renewable energy technologies as well as their market development, costs, environmental performance, deployment barriers, and incentives to overcome the barriers. The cross-cutting issues discussed in the final sections are the integration of renewables into reliable and secure energy systems, developments in renewable energy investments, and policies and measures to enhance the development and application of renewables.

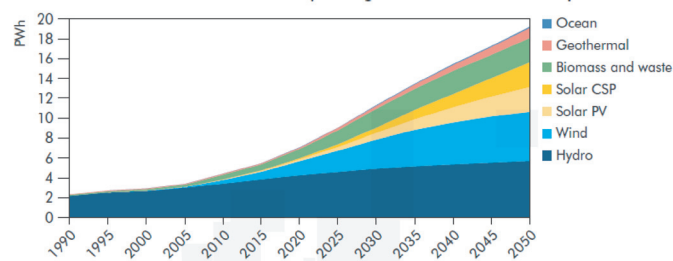

Figure 11.4 | IEA ETP-2010 BLUE Map scenario: Historical and projected contribution of renewables to global electricity generation. Source: IEA, 2010a. ©OECD/International Energy Agency 2010.

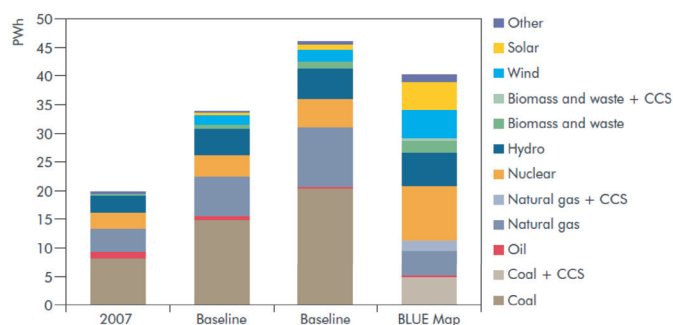

Figure 11.5 | The contribution of different energy sources to the global electricity supply in the Baseline and the BLUE Map scenario developed by IEA. Source: IEA, 2010a. ©OECD/International Energy Agency 2010.

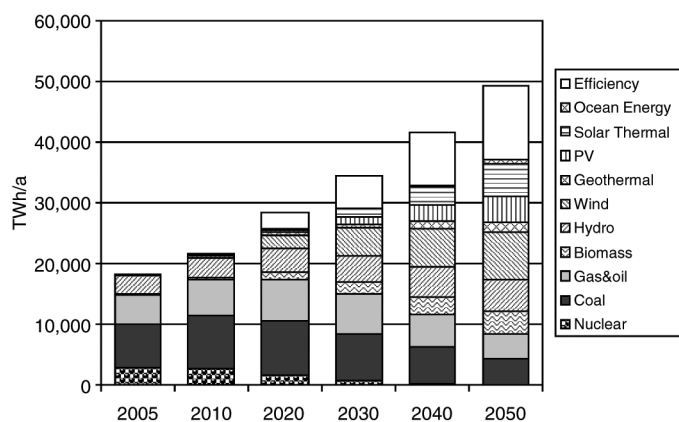

Figure 11.6 | Global electricity generation in the Energy [R]evolution scenario ("efficiency" = savings compared with Reference scenario) Source: based on Greenpeace and EREC, 2007; Krewitt et al., 2009b.

11.2 Biomass Energy

11.2.1 Introduction

Globally, photosynthesis stores energy in biomass at a rate about seven times the current 500 EJ/yr rate of total global energy use. Less than 2% of this biomass is used for human energy consumption today. Biomass resources are diverse, and the global consumption volume of the largest category of these resources (fuelwood in developing countries) rivals that of industrial roundwood (see Figure 11.8). The geographic distribution of biomass resources is uniform relative to that of most fossil fuels (see Chapter 7).

When exploited sustainably, biomass can be converted to modern energy carriers that are clean, are convenient to use, and have little or no associated greenhouse gas (GHG) emissions on a life-cycle basis. Various conversion technologies are available or under development. Sustainable bioenergy has the potential to make large contributions to rural and economic development, to enhance energy security, and to reduce environmental impacts (Chum et al., 2011).

Projections from the IEA, among others, and many national targets count on increasing biomass production and use going forward. Chapters 7 and 20 discuss factors relating to sustainable feedstock production and estimate the quantities of supplies that might be available to 2050. This chapter focuses on summarizing the status and future prospects of modern biomass energy technologies.

11.2.2 Potential of Bioenergy

Biomass accounts today for about 10% (51 EJ) of global primary energy consumption (IEA, 2010a; see also Table 11.5). Its largest, mostly traditional use is found in developing countries. Dominating the traditional use is firewood for cooking and heating. On the other hand, an

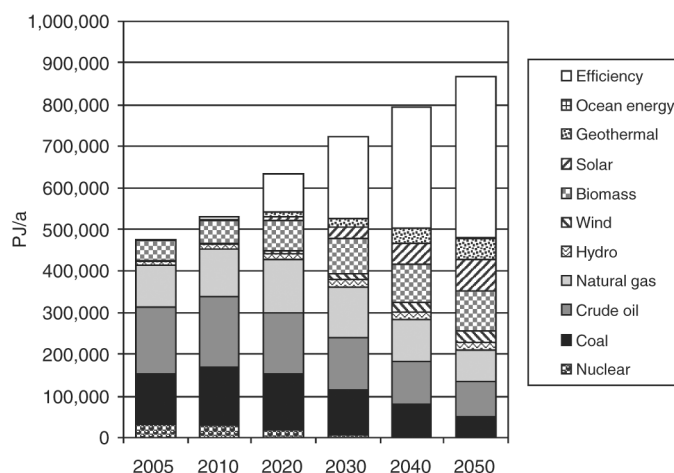

Figure 11.7 | Primary energy use in the Energy [R]evolution scenario ("efficiency" = savings compared with Reference scenario). Source: based on Greenpeace and EREC, 2007; Krewitt et al., 2009b.

estimated 12.1 EJ of primary biomass energy was converted to modern energy carriers in 2009: an estimated 3.3 EJ were converted to 241 TWh of electricity (Electricité de France and Observ'ER, 2010) (more than 1% of all global power generation); about 3.6 EJ were converted to 2.3 EJ of biofuels (REN21, 2010) (about 2% of all global transportation energy) from primarily corn, rape, soy, and sugarcane; and the remainder (about 5.2 EJ) was converted to 4.2 EJ heat, including heat from combined heat and power (CHP) systems.³

The analysis in Chapter 7 indicates projected sustainable supplies by region of five categories of biomass supplies – energy crops, forestry residues, crop residues, municipal solid wastes (MSW), and animal wastes – in 2050. Combining these estimates with estimates of prospective efficiencies of biomass electricity generation or of so-called second-generation biofuels production described in this Chapter enables order of magnitude estimates to be made for the maximum potential supplies of low-GHG electricity or liquid transportation fuels in 2050.

Table 11.7 shows that if all sustainably producible biomass supplies were to be converted to electricity, the total electricity generation could approach today's global level of electricity generation from all sources.

³ The estimate of 12.1 EJ/yr biomass energy converted to modern energy carriers assumes an average biomass power generating efficiency of 26.3% (IEA, 2010a). Also, the 2.3 EJ of ethanol plus biodiesel produced in 2009 (REN21, 2010) is assumed to have been made from primary biomass with an average energy efficiency of about 60% (Chum et al., 2011). To estimate biomass use for heat, it was conservatively assumed that all biomass use reported for the Organisation for Economic Co-operation and Development by the IEA (2010a), other than biomass used for power generation and for biofuels production, was used for heat or combined heat/power. In addition, Brazil's use of biomass in the industrial sector (as reported by the IEA) is assumed to be for modern heating (e.g., bagasse CHP in the sugarcane industry, or black liquor CHP in the pulp and paper industry). All other non-power/non-biofuel biomass in the world, as reported by the IEA, is assumed to be used in traditional fashion. The IEA estimates are for 2008. It is assumed that there was no change in heat use of biomass between 2008 and 2009. The efficiency of converting primary biomass energy into heat is assumed to be 80% (Chum et al., 2011).

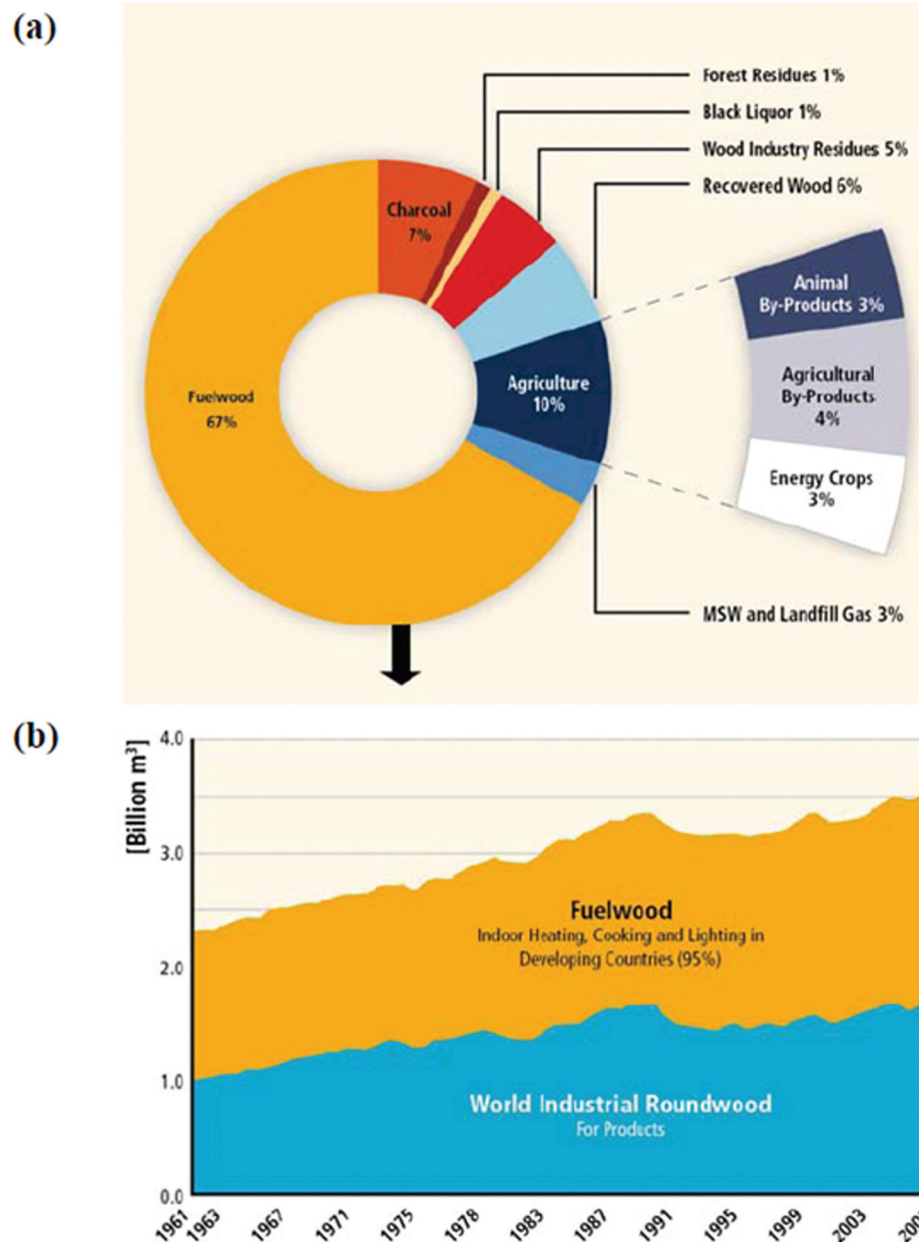

Figure 11.8 | (a) Shares of primary biomass sources in global primary energy use, (b) Fuelwood used in developing countries and world industrial roundwood production levels. Source: Chum et al., 2011.

Alternatively, if all of the biomass were to be converted to second-generation biofuels, the amount of fuel would be comparable to 70–85% of all petroleum-based transportation fuel use in the world at present. If the biomass were converted to transportation fuels in coal and biomass to liquids (CBTL) systems – that is, those that co-process some coal and capture and store by-product CO_2 (as described briefly in this chapter and more extensively in Chapter 12) – twice as much low GHG-emitting liquid transportation fuel could be produced as the level of petroleum transportation fuels consumed today.

It should be noted that in this assessment the potential to produce transportation fuels from algae was not taken into account because it

is more speculative at this time. With the large number of diverse algal species in the world, upper range productivity potentials of up to several hundred EJ for microalgae and up to several thousand EJ for macroalgae have been reported (Sheehan et al., 1998; Florentinus, 2008; van Iersel et al., 2009; Chum et al., 2011). No reliable estimates are available yet on the techno-economic potential of energy from algae.

11.2.3 Market Developments

Nearly 80% of the total biomass use for energy today occurs in rural areas of developing countries (Chum et al., 2011), and biomass as a

Table 11.7 | Order of magnitude estimate of the technical potential of biomass supply for low-carbon electricity or liquid transportation fuels in 2050 taking into account sustainability requirements.

2050 Potential Biomass Supply ^a (EJ/yr, higher heating value basis)							Electricity (TWh/yr) ^b		Second-Generation Transport Fuels (EJ/yr LHV) ^c		
GEA Region ^d	Crop residues	Animal waste	MSW	Forest residues	Energy crops	Totals	Small scale	Large scale	Low	High	High CBTL ^e
CAN	0.6	0.47	0.12	2	2.45	5.6	441	587	1.7	2.2	5.3
CHN	7.81	4.99	1.54	2.5	6.30	23.1	1,616	2,155	6.7	8.6	19.1
EAF	0.91	1.67	0.19	0	3.27	6.0	399	532	1.6	2.0	4.6
EEU	0.66	0.55	0.21	1.5	1.71	4.6	352	469	1.4	1.8	4.2
FSU	1.92	1.65	0.41	3	5.85	12.8	966	1,288	3.9	5.0	11.5
IND	6.75	6.17	0.77	0	1.66	15.3	893	1,191	3.6	4.6	9.9
JPN	0.14	0.17	0.31	1	0.37	2.0	155	207	0.6	0.8	1.8
LAC	11.28	7.9	1.75	3	22.67	46.6	3,390	4,519	14.1	18.0	40.4
MEE	0.95	0.64	0.46	0	0.59	2.6	180	240	0.8	1.0	2.1
NAF	0.93	1.33	0.2	0	1.06	3.5	211	281	0.8	1.1	2.3
OCN	0.67	1.65	0.08	0.5	5.07	8.0	561	748	2.2	2.9	6.5
OEA	0.66	0.46	0.13	0	3.16	4.4	339	452	1.4	1.8	4.1
OSA	1.95	1.46	0.33	0	0.38	4.1	252	336	1.1	1.3	2.9
PAS	4.52	1.35	1.09	0.5	4.28	11.7	894	1,192	3.9	5.0	11.0
SAF	1.63	1.14	0.27	0	4.99	8.0	598	797	2.5	3.2	7.2
USA	3.28	3.03	1.33	7	11.09	25.7	1,955	2,606	7.8	10.0	23.2
WCA	2.22	1.51	0.55	0.5	8.27	13.1	993	1,324	4.2	5.3	12.0
WEU	2.56	3.09	1.28	5.5	4.98	17.4	1,258	1,677	4.9	6.3	14.7
TOTALS	49	39	11	27	88	215	15,453	20,603	63	81	183
World production from all sources in 2008 →							Electricity ^f		Transport Fuels ^g		
							20,183		95		

^a Average of high and low estimates for 2050 of potential sustainable biomass energy production (from Chapter 7).

^b Assuming any available biomass is used only for electricity generation. All categories of biomass resource shown here except animal manures are assumed to be converted to electricity at the same efficiency. For small-scale electricity systems, the assumed conversion efficiency is 30% (gross heating value or HHV basis), a value that can be achieved today with biomass gasifier internal combustion engine systems. For large-scale systems, an efficiency of 40% (HHV) is assumed. This level is likely to be achievable with future gasifier gas turbine combined cycle systems. Animal wastes are assumed to be converted at 25% efficiency to biogas prior to conversion to electricity at the 30% and 40% efficiencies.

^c Animal wastes are neglected for the transport fuel calculations. Forest residues (assumed HHV of 20 GJ/dry t) are assumed to yield 5.9 and 7.6 GJ_{LHV} per dry t biomass for the low and high estimates. Crop residues and municipal solid waste (assumed to have HHV of 18 GJ/dry t) are assumed to yield 7.3 and 9.3 GJ_{LHV} per dry t biomass for the low and high estimates. Liquid fuel yield from energy crops is assumed to be the average of yields from forest residues and crop residues. The "High with CBTL" case assumes 19.5 GJ_{LHV} liquid yield per dry tonne of biomass for each feedstock

^d The global regions are defined in Annex II of this Assessment.

^e CBTL means co-processing coal-and-biomass-to-liquid (CBTL) fuels.

^f Source: US DOE, 2010a.

^g Source: IEA, 2010b.

whole accounts for 70% or more of total primary energy use in many of these countries (Karakezi et al., 2004).

Rural biomass use consists in general of charcoal, wood, agricultural residues, and manure used primarily by direct combustion for cooking, lighting, and space heating, with attendant negative health and socio-economic impacts that affect primarily the poor (see Chapters 2 and 4). In Asia, China's biomass consumption represented about 10% of total energy (2007), while in India and some other countries the average was

about 25%. Latin American biomass use was about 20% of primary energy, while in Africa the average approached 50% (IEA, 2009a).

Biomass is used in industrial countries differently, typically first being converted into clean modern energy carriers (electricity, process heat, transport fuels). On average, biomass accounts for 3–4% of total energy use in these countries, although in countries with supportive policies (Sweden, Finland, Austria, and others), the contribution reaches 15–20% (REN21, 2011).

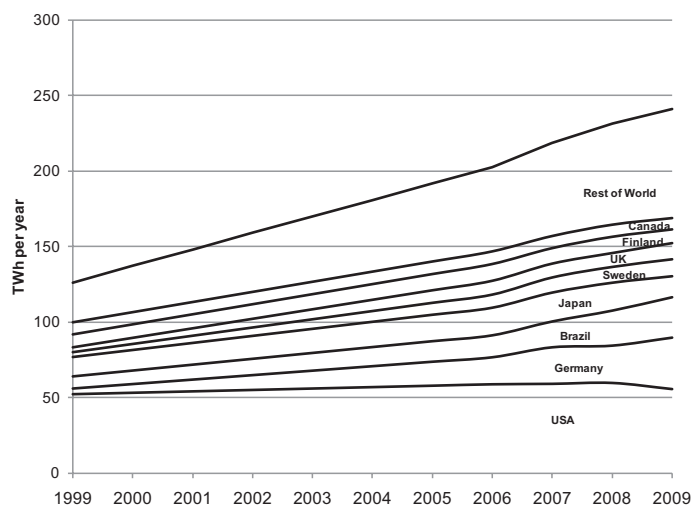

Figure 11.9 | Electricity generation from biomass in selected countries, 2007. Source: based on Electricité de France and Observ'ER, 2010.

Most electricity generation from biomass occurs in Organisation for Economic Co-operation and Development (OECD) countries, with Brazil being the leading producer outside the OECD (see Figure 11.9). Production of transportation fuels (biofuels) based on agricultural crops (principally corn, soy, rape, and sugarcane) has been growing faster than biopower generation. Figure 11.10 shows the recent rapid growth in ethanol production. Biodiesel production in the United States (from soybeans) and in Europe (from rapeseed) similarly has been growing rapidly in recent years. International trade of biofuels has also grown in recent years, with around 10% of all biofuels traded internationally. Similarly, a third of biomass pellets produced for energy are traded internationally (Junginger et al., 2011).

Combined heat and power systems in the pulp and paper industry accounted for most of the estimated 8500 MW of installed biomass-electric generating capacity in the United States by the end of 2009 (REN, 2010). Biomass CHP plants, with heat used for district heating, are found in Sweden, Finland, Austria, and elsewhere. In developing countries, biomass power generation is found most notably at sugarcane processing factories, where residue from juice extraction is the fuel. Globally, there is an estimated 4700 MW of sugarcane biomass power generating capacity.⁴

Co-combustion in existing coal-fired power plants is an important and growing conversion route for biomass in many EU countries (Spain, Germany, the Netherlands, and others).

Biogas production globally was an estimated 1 EJ in 2009, based on the following analysis. In China, 18 million small-scale anaerobic biomass waste digesters were installed in 2005, having increased an average of

⁴ Based on the update of a survey carried out by The World Alliance for Decentralized Energy (WADE) in 2005, reported in Survey of Energy Resources (WEC, 2007).

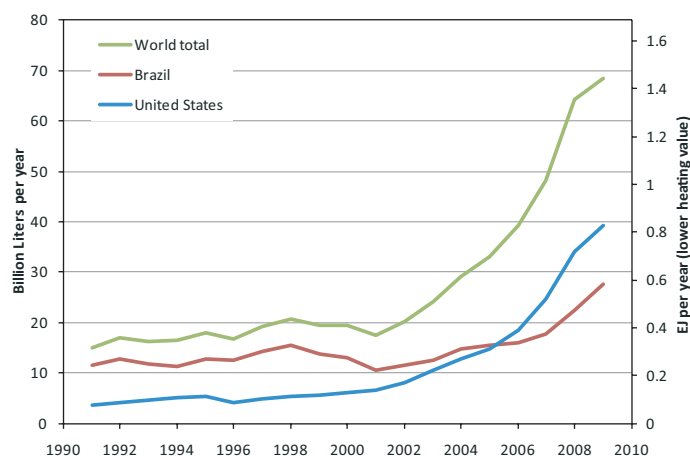

Figure 11.10 | Ethanol production from sugar and starch crops. Source: RFA, undated; UNICA, undated; BP, 2009.

16% per year starting in 2000 (Chen et al., 2010). Assuming an average per-digester production of about 400 m³ of biogas per year (22 MJ/m³ energy content) and continued 16% per year growth in installations from 2005–2009, the total biogas production (from 32.8 million digesters) in 2009 would have been 0.29 EJ. India is estimated to have several million digesters installed, and there are several hundred thousand in other developing countries (REN21, 2010). The number of digesters in industrial countries is much lower, but unit sizes are generally larger – located at large livestock processing facilities (stockyards), municipal sewage treatment plants, and landfills. Biogas production from all sources in the EU totaled 0.35 EJ in 2009, up 4.1% over 2008 (EurObserv'ER, 2010). Germany accounted for 50% of the production and the United Kingdom accounted for 21%. In the United States, biogas production in 2008 was an estimated 0.28 EJ, having increased at 4.3% per year from 2004 (US DOE, 2010a). Assuming continued growth at this rate, US production in 2009 was 0.29 EJ.

Large-scale partial-combustion biomass gasifier systems are not commercially operating today, but as a result of considerable research, development, and pilot-scale demonstration work during the past 25 years (Engstrom et al., 1981; Strom et al., 1984; Kosowski et al., 1984; Evans et al., 1987; Lau et al., 2003) these technologies are nearly commercially ready. The “downstream” components in systems for making liquid fuels from syngas derived via gasification are fully commercial in many cases. (See Chapter 12.)

The only operating commercial demonstration plant for second-generation ethanol (made from non-edible biomass) started in 2004 in Canada, using separate saccharification and fermentation to produce about 3 million liter/yr from wheat straw. Additional commercial-scale demonstration plants are under construction or in planning, largely in the United States (IEA Bioenergy Task 39, undated; US DOE, 2010c), where significant government incentives are available.

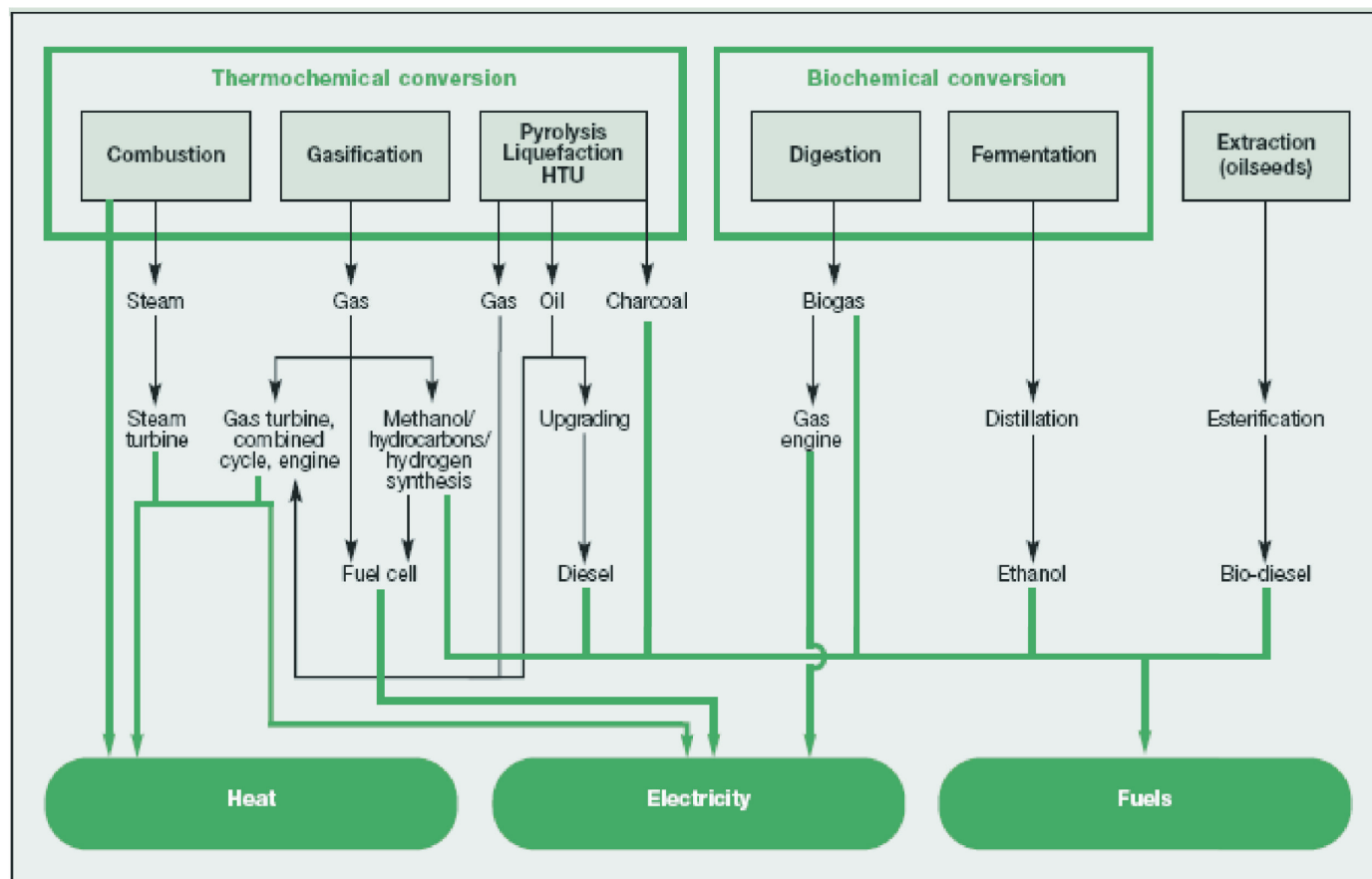

Figure 11.11 | Main conversion routes for biomass to secondary energy carriers. Source: UNDP et al., 2000.

11.2.4 Biomass Energy Conversion Technology Development

A wide variety of technologies are used today to convert raw biomass into modern energy carriers. Figure 11.11 is a simplified road map of the main options. Not shown in this figure but discussed in this section are biomass conversion systems that would include capture and storage of by-product CO₂ to achieve negative greenhouse gas emissions.

Figure 11.12 summarizes the development status of a range of technologies for producing heat and power from biomass, ranging from anaerobic digestion, co-firing, gasification, and combustion of biomass to the production of heat. The development status of different biomass densification techniques is also shown.

11.2.4.1 Electricity and Combined Heat/Power from Biomass

The predominant technology for generating megawatt levels of electricity from biomass today is the steam-Rankine cycle. Efficiencies are modest – often under 20%. To improve efficiency, most steam cycle

power plants are located at industrial sites, where they are configured for combined heat/power production. Low efficiencies, together with relatively high capital costs, explain the reliance of most existing biomass power plants on captive, low-value biomass (primarily residues of agro- and forest-product-industry operations).

Biomass is co-fired in some existing coal-fired power plants. Benefits of this approach include typically high overall efficiency (~40%) because of the large scale of the plants and low investment costs. Aside from GHG emission reductions, co-firing also leads to lower sulfur and other emissions (Faaij, 2006). Generally, relatively low co-firing shares can be deployed with very limited consequences for boiler performance and maintenance.

Many EU coal plants are now equipped with some co-firing capacity. The interest in co-firing higher shares (for instance, up to 40%) is rising. At such high levels, good technical performance (of feeding lines and boiler, for example) is more challenging. Development efforts are focusing on such issues (van Loo and Koppjan, 2002). Power plants capable of co-firing various biomass types with natural gas or with coal exist in Denmark, where alkali-rich straw is a common fuel. Increased corrosion and slagging are common alkali-related problems

Type of Plant	Type of Product	Stage of Development of Process for Product(s) or System(s)			
		Basic and Applied R&D	Demonstration	Early Commercial	Commercial
Low Moisture Lignocellulosic	Densified Biomass	Torrefaction	Hydrothermal Oil (Hy Oil)	Pyrolysis Oil (Py Oil)	Pelletization
	Charcoal	Pyrolysis (Biochar)			Carbonization
	Heat	Combustion	Small Scale Gasification		Combustion Stoves
		Combustion Coupled with	Py/Hy Oil		Home/District/Industrial
	Power or CHP	Co-Combustion or Co-Firing with Coal	Stirling Engine	ORC ¹	Steam Cycles
		Gasification (G) or Integrated Gasification (IG)	Indirect	Parallel	Direct
IG-Fuel Cell IG-Gas Turbine		IG-Combined Cycle	G and Steam Cycle		
Wet Waste	Heat or Power or Fuel	Anaerobic Digestion to Biogas			Landfills (1-Stage)
		Microbial Fuel Cell	2-Stage	Reforming to Hydrogen (H ₂)	Small Manure Digesters
Sugar or Starch Crops	Fuels	Hydrothermal Processing to Oils or Gaseous Fuels			
		Sugar Fermentation	Butanol	Ethanol	
		Microbial Processing ²	H ₂	Gasoline/ Diesel/ Jet Fuel	Biobutanol/Butanols ³
Oils Vegetable or Waste	Fuels	Extraction and Esterification		Biodiesel	
		Extraction and Hydrogenation	Renewable Diesel		
		Extraction and Refining	Jet Fuel		

Figure 11.12 | Examples of stages of development of bioenergy: thermochemical (yellow), biochemical (blue), and chemical routes (red) for heat, power, and liquid and gaseous fuels from solid lignocellulosic and wet waste biomass streams, sugars from sugarcane or starch crops, and vegetable oils. Source: Chum et al., 2011.

Notes: 1. ORC: Organic Rankine Cycle. 2. Genetically engineered yeasts or bacteria to make, for instance, isobutanol (or hydrocarbons) developed either with tools of synthetic biology or through metabolic engineering. 3. Several four-carbon alcohols are possible and isobutanol is a key chemical building block for gasoline, diesel, kerosene and jet fuel and other products.

in conventional combustion systems. In multi-fuel systems, however, these problems can be largely circumvented by using straw to raise low temperature steam, which is then superheated using heat from fossil fuel combustion (Nikolaisen et al., 1998). Finally, there is also growing interest in co-feeding of biomass with fossil fuels in gasification-based systems, as briefly discussed later in this chapter and more extensively in Chapter 12.

Advanced biomass power technologies have been the focus of considerable research, development, and demonstration work over the past 25 years to improve conversion efficiency and reduce power generation costs. Gasification of biomass (producing a gas rich in hydrogen and carbon monoxide) coupled with gas engines (Bolhar-Nordenkamp et al., 2003; Salo, 2009) or with gas turbine combined cycles (Larson et al., 2001; Williams, 2004; Sipila and Rossi, 2002; Sydkraft et al.,

1998, 2001; DeLong, 1995; Lau, 2005) have gotten the most attention. Projected conversion efficiencies for Biomass Gasification Combined Cycle systems at a scale of tens to hundreds of MWs exceed 40% (higher heating value basis). At 5–10 MWs, Biomass Gasifier Engine (BGE) efficiencies of 28–30% (lower heating value, or LHV basis) are expected, with total efficiency reaching 87% (LHV basis) in combined heat/power mode (Salo, 2009). Key technical challenges for gasification-based systems are feeding of biomass, especially against pressure (Kurkela, 2008), and cracking of heavy hydrocarbons (tars and oils) that form at typical biomass gasification temperatures (Bergman et al., 2002; Kurkela, 2008; Swedish Energy Agency, 2008; Dayton, 2002; Pfeifer and Hofbauer, 2008). Progress is being made in both these areas.

11.2.4.2 Fuel Gas from Biomass

Biomass can be converted into several types of fuel gases. These gases can be used to generate heat or electricity but also to produce synthetic natural gas or liquid fuels. Anaerobic digestion is by far the most widely used option today for gas production from biomass. The term anaerobic digestion commonly refers to low-temperature biological conversion, with the resulting product (biogas) typically being 60% methane and 40% CO₂. Its use is limited to relatively small-scale applications. Animal and human wastes, sewage sludge, crop residues, carbon-laden industrial-processing by-products, and landfill material have all been widely used as feedstocks. High-moisture feedstocks are especially suitable. Anaerobic digestion has important direct non-energy benefits: it produces concentrated nitrogen fertilizer and neutralizes environmental waste.

11.2.4.3 Liquid Transportation Fuels from Biomass

A popular (non-technical) classification for liquid fuels made from biomass includes first-, second-, and third-generation biofuels. The different generations are distinguished primarily by the feedstocks from which they are derived and the extent to which they are commercially developed.

First-generation biofuels

First-generation biofuels are the only ones being used in significant commercial quantities today. These are made from sugars, grains, or seeds – that is, from only a specific (usually edible) portion of a crop. Relatively simple processing steps convert these feedstocks into fuels (see Figure 11.13), which provides for relatively low processing costs.

Representative fuel yields for the most common first-generation biofuels range from about 2 GJ ethanol per tonne of sugarbeet or sugarcane (LHV) up to about 15 GJ biodiesel per tonne of rapeseed. In terms of land utilization efficiency, the values range from an average of about 20 GJ/ha/yr for US soy biodiesel to about 160 GJ/ha/yr for Malaysian palm biodiesel (see Table 11.8).

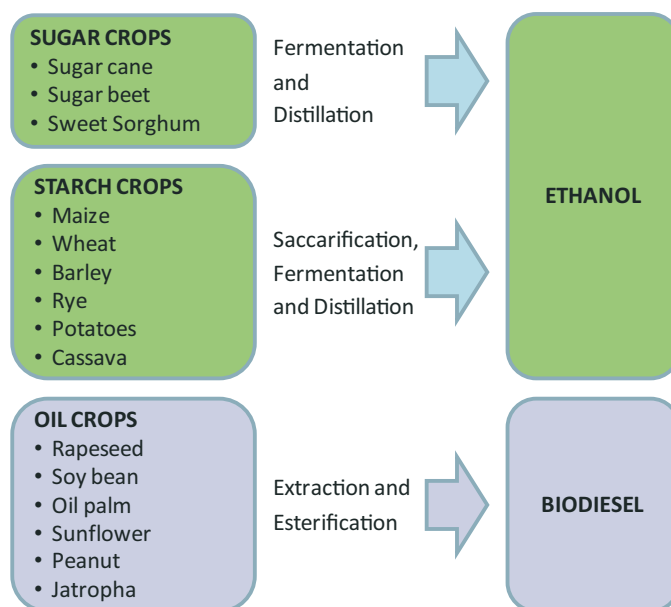

Figure 11.13 | Main feedstocks and conversion steps for first-generation biofuels.

Second-generation biofuels

Second-generation biofuels are those made from land-based non-edible lignocellulosic biomass, either residues of food crop production (such as corn stalks or rice husks) or whole-plant biomass (such as grasses or trees) (UNCTAD, 2008). There are a variety of technology routes for second-generation fuels production (Huber et al., 2006). Among these, second-generation ethanol or butanol can be made via biochemical processing, while most other second-generation fuels are made via thermochemical processing (see Figure 11.14), in some cases using processing steps that are nearly identical to those that would be used to produce synthetic fuels from fossil fuels (see Chapter 12).

Second-generation biochemically produced alcohol fuels are produced via pre-treatment, saccharification, fermentation, and distillation. Pre-treatment is designed to help separate cellulose, hemicelluloses, and lignin so that cellulose and hemicellulose can be broken down by enzyme-catalyzed or acid-catalyzed hydrolysis (water addition) into their constituent simple sugars. The use of acid hydrolysis was practiced commercially as long ago as the 1930s for ethanol production, but involves high capital and operating costs and low yields. Processes using enzymes for hydrolysis promise more competitive ethanol (UNCTAD, 2008).

A variety of process designs have been proposed for the production of second-generation ethanol, including separate enzyme-catalyzed hydrolysis (or saccharification) and fermentation steps, simultaneous saccharification and fermentation in a single reactor (Aden et al., 2002; Jeffries, 2006), and consolidated bioprocessing that incorporates enzyme production (from biomass) with saccharification and fermentation (Zhang and Lynd, 2005). Less work has been done on butanol, but similar processing ideas as for ethanol can be envisioned (UNCTAD, 2008).

Table 11.8 | Representative average yields of first-generation biofuels.

	Fuel yield from grain /seed ^a		Seed/Grain Yield ^b	Fuel per ha/yr	
	Liters/tonne	GJ/tonne	tonne/ha/yr	Liter/ha/yr	GJ/ha/yr
Bioethanol					
Corn (US)	413	8.7	10.2	4220	89
Sugarbeet (US)	100	2.1	60.6	6056	128
Sugarcane (Brazil)	95	1.8	70	5950	126
Biodiesel					
Soybean (US)	204	7.0	2.8	575	20
Rapeseed (EU)	441	15.2	3.6	1601	55
Oil palm (Malaysia)	230	7.9	20.6	4738	163

^a Fuel yields from corn, sugarbeets, and soybean are estimated averages for 2012 in the United States (FAPRI, undated). Fuel yield from rapeseed is an estimate for the United Kingdom (ESRU, undated). Oil palm estimates are from FAO (2008). Fuel yield of ethanol from sugarcane is the current average in the Center-South region of Brazil in liters per tonne of sugarcane stalk (Hassuani, 2009). The lower heating values for ethanol and biodiesel are 21.1 MJ/liter and 34.5 MJ/liter, respectively.

^b Corn grain, sugarbeet, and soybean yields are average 2008 yields in the United States (ERS, undated). Rapeseed yield is a representative 2008 average for the European Union (FAS, undated). Sugarcane yield is an estimate of the current Brazilian average in tonnes of cane/ha/yr (Matsuoka et al., 2009). Oil palm estimates are from FAO (2008).

Another biological approach to second-generation biofuels is “synthetic biology,” which involves engineering microbes to produce specifically desired fuels, especially hydrocarbon fuels that are “drop-in” replacements for petroleum diesel and gasoline. The work that has been done thus far has been targeting the development of microbes that “eat” sugar molecules and excrete diesel-like fuel (Lee et al., 2008).

Thermochemical (gasification-based) processing of biomass can produce Fisher-Tropsch Liquid fuels, dimethyl ether, gasoline made via methanol, methanol, ethanol, and other fuels.

Gasification takes place in oxygen or via indirect heating (to avoid diluting the resulting gas with nitrogen). The resulting synthesis gas (syngas) is cleaned of contaminants, and in some cases the composition of the gas is adjusted to prepare it for further downstream processing (UNCTAD, 2008). Carbon dioxide is a diluent in the syngas and so is removed to facilitate downstream reactions and reduce equipment sizes. The major components of the clean, concentrated syngas are carbon monoxide (CO) and hydrogen (H₂), usually with a small amount of methane that is unavoidably formed at typical gasification temperatures (<1000°C).

Further gas processing can follow different routes. In one class of processes the syngas is passed over a catalyst that promotes reactions between the CO and H₂ to form liquid fuels molecules. The design of the catalyst determines what fuel is produced. Not all of the syngas passing over the catalyst will be converted to fuel. The unconverted syngas can be burned to make electricity for some or all of the power needed to run the facility and in some cases to export electricity to the grid (UNCTAD, 2008).

In a second class of processes, the CO₂-free syngas goes to a reactor containing specially designed micro-organisms that ferment the CO and H₂ into ethanol or butanol (Spath and Dayton, 2003). This combined

thermochemical/biochemical route to a pure alcohol, if it can be made commercially viable, would enable the lignin in the biomass feedstock, as well as the hemicellulose and cellulose, to be converted to fuel (UNCTAD, 2008), unlike the case for purely biochemical “cellulosic ethanol,” where the lignin is unfermentable.

Second-generation biofuel yields can be high. Table 11.9 gives estimated yields per tonne of dry biomass processed for several second-generation biofuels. Also shown are estimates of yields per unit land area in the United States on two qualities of land: one suitable for agriculture and one not well suited for it. On good-quality lands, yields for second-generation biofuels are likely to exceed by a considerable margin the yields of first generation-biofuels given in Table 11.8. Yields would be higher still on good-quality lands in tropical climates, due to the longer growing season.

Direct liquefaction is one additional class of second-generation conversion that deserves mention. Fast pyrolysis (Bridgwater and Peacocke, 2000) and hydrothermal upgrading (for moist biomass) (Goudriaan and Naber, 2008) represent different variants of liquefaction. Different reaction pressures and temperatures, catalysts, and rates of heating in the absence of oxygen produce different liquid, gas, and solid output compositions (Huber et al., 2006). The liquid product is typically a “biocrude oil” that is denser than water, highly acidic, odoriferous, and carcinogenic. It requires refining into finished transportation fuels. So-called green diesel can be produced from such oils using catalytic processing that resembles conventional petroleum refining (McCall et al., 2008).

A final comment is warranted regarding the concept of biorefining because of the potential it has for optimizing economics of biofuels production. Biorefining is analogous to current petroleum refining, which leads to an array of products, including liquid fuels, other energy products, and chemicals (Kamm et al., 2006). Although the biofuel and

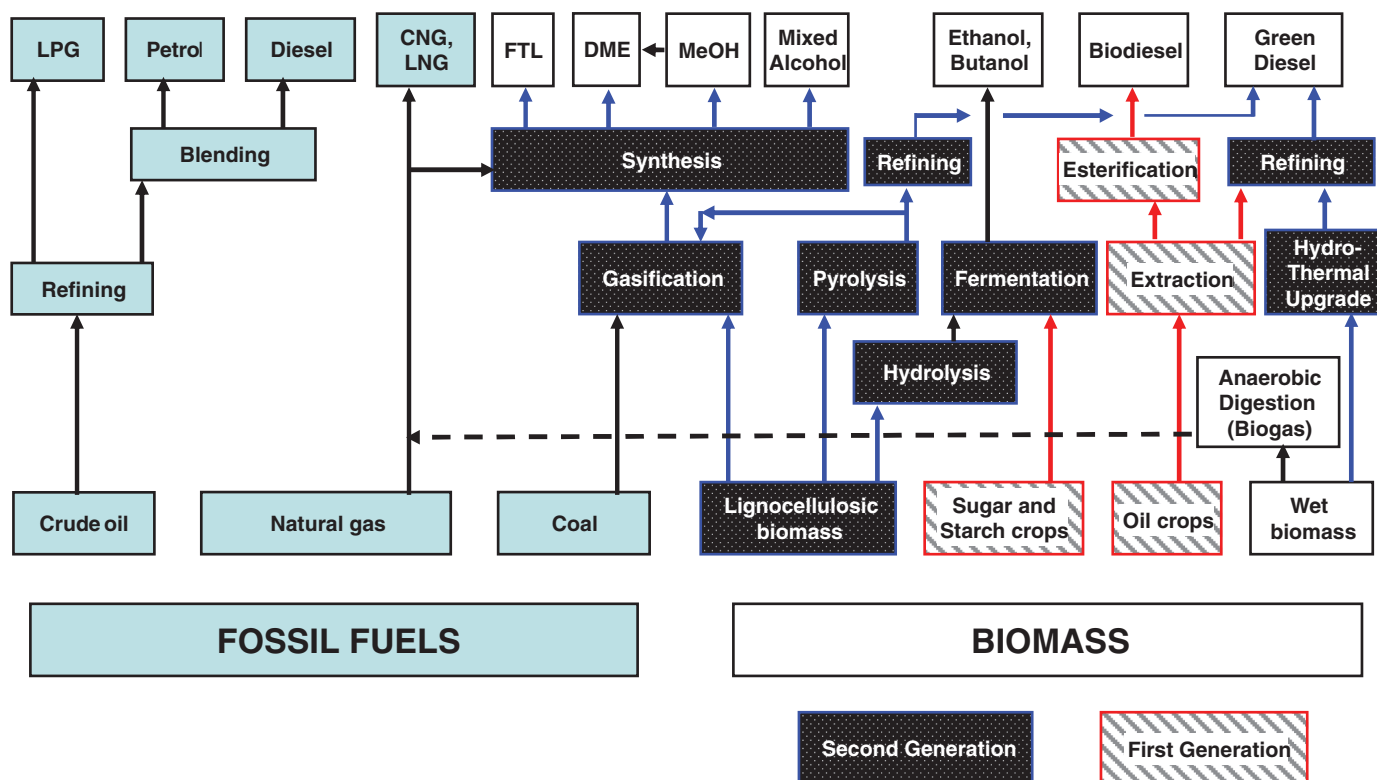

Figure 11.14 | Production paths to liquid fuels from biomass and, for comparison, from fossil fuels.

associated co-products market are not fully developed, first-generation operations that focus on single products (such as ethanol or biodiesel) are regarded as a starting point in the development of sustainable biorefineries. New sugarcane processing facilities are examples of commercial biorefineries, producing both ethanol and exported electricity (EPE, 2008). Advanced or second generation biorefineries would be based on more sustainably derived biomass feedstocks. These biorefineries aim to optimize the use of biomass and resources in general (including water and nutrients), while mitigating GHG emissions (Chum et al., 2011).

Third-generation biofuels

Third-generation biofuels are those that require considerable research and/or technology advances before they can begin to approach commercial viability. Fuels in this category include biological solar hydrogen production and photo-electrochemical fuel production (Aartsma et al., 2008), as well as algae-derived fuels (Sheehan et al., 1998a; Brennan and Owende, 2010). Such options have the potential to more easily meet sustainability constraints, especially land requirements, in part via substantially higher efficiencies of solar energy conversion than for second-generation biofuels. (See Figure 11.15.)

Among third-generation fuels, algae-derived fuels are attracting the most attention today. Algae production does not require the use of good-quality land (though water needs can be substantial). With the

large number of diverse algal species in the world, upper range productivity potentials of up to several hundred EJ for microalgae and up to several thousand EJ for macroalgae have been reported (Sheehan et al., 1998a; Florentinus, 2008; van Iersel et al., 2009; Chum et al., 2011). No reliable estimates are available on the techno-economic potential of energy from algae.

Aquatic phototrophic organisms in the world's ocean (halophytes) produce annually 350–500 billion tonnes of biomass and include microalgae (such as *Chlorella* and *Spirulina*), macroalgae (seaweeds), and cyanobacteria (also called “blue-green algae”) (Garrison, 2008). Microalgae such as *Schizochytrium* and *Nannochloropsis* can accumulate lipids, from which diesel-like oils can be extracted at reportedly greater than 50% of their dry cell weight (Chum et al., 2011). The US Department of Energy (US DOE) operated a significant algae energy research and development (R&D) program from the late 1970s until the mid-1990s, in which considerable progress was made in understanding the biochemistry of different microalgae and their potential as a source of lipids. (Still, fewer than 100 microalgae species have been tested or used industrially out of about 100,000 known species.) A realistic yield of unrefined oil from algae with a 50% oil content located on the equator has been estimated to be 40,000–50,000 lit/ha/yr, and a mere 10% yield from this oil could match palm oil productivities of about 4700 lit/ha/yr (Weyer et al., 2009). Uncultivated macro-algae can reach yields that are higher than those of sugarcane (per unit area)

Table 11.9 | Estimated yields for second-generation biofuels with current and projected future technology levels (note: none of these systems are currently commercial).

Technology	Fuel yield per tonne dry biomass		Fuel yields from dedicated bioenergy US land, with projected 2020 biomass yields ^f	
	Liters/tonne	GJ _{LHV} /tonne	Low-quality land GJ _{LHV} /ha/yr	High-quality land GJ _{LHV} /ha/yr
Ethanol via enzymes^a				
Current (woody biomass)	279	5.9	66	139
Best future (woody biomass)	362	7.6	86	180
Current (low lignin biomass)	346	7.3	82	172
Likely future (low lignin biomass)	396	8.3	94	197
Best future (low lignin biomass)	441	9.3	105	219
Ethanol via syngas fermentation^b				
Future low	120	2.5	28	60
Future high	160	3.4	38	80
Fischer-Tropsch diesel/gasoline				
Current low ^c	75	2.6	29	61
Current high ^c	200	6.9	77	162
Future ^d	236	8.1	91	191
Future, biomass/coal co-processing w/CCS ^e	568	19.5	219	460

^a Source: NAS, 2009. Biochemical processing of plantation-grown short-rotation poplar. "Current" means currently understood technology.

^b Source: Sims et al., 2010, citing Putsche, 1999. Details of the feedstock and process designs considered are not given. The process likely begins with thermochemical gasification followed by fermentation of the syngas to ethanol.

^c Source: Sims et al., 2010. Assumptions behind these estimates are not provided, but they appear to refer to only the diesel fuel that would be produced from a biomass-to-liquids (BTL) system (ignoring naphtha and other co-products).

^d Source: Liu et al., 2011. Simulation results for a BTL system using herbaceous feedstock and producing both diesel and gasoline. Gasoline is produced by refining the naphtha fraction of the raw Fischer-Tropsch product. See Chapter 12 for additional discussion of BTL options.

^e These estimates are for the CBTL-OTA-CCS (CO₂ capture and storage) process configuration described in Chapter 12.

^f Average yield of 11.2 dry t/ha/yr on lower quality lands, such as Conservation Reserve Program lands, and 23.6 t/ha/yr on lands with moist, fertile soils (NAS, 2009).

(Zemke-White and Ohno, 1999). Photosynthetic cyanobacteria can produce fuels like hydrogen directly.

Aside from questions about economic viability (Pienkos, 2009), fuels from algae grown by fertilizing with CO₂-rich flue gases from fossil fuel power plants, as is being proposed by many start-up companies today, would be far from "carbon-neutral" since the carbon in the algae originates from fossil sources and since considerable energy inputs are required for algae growing, harvesting, and oil extraction systems (Lardon et al., 2009; Cazzola, 2009).

11.2.5 Economic and Financial Aspects

Figure 11.16 presents projected ranges of commercial production costs for biomass-to-power and biomass-fired CHP plants (Bauen et al., 2009). Not all of the technologies included there are commercially mature, but the figure illustrates that there can be a wide range in costs for any technology, depending on feedstock cost, annual operating hours, and byproduct credit for heat in the case of CHP. A self-consistent set of electricity

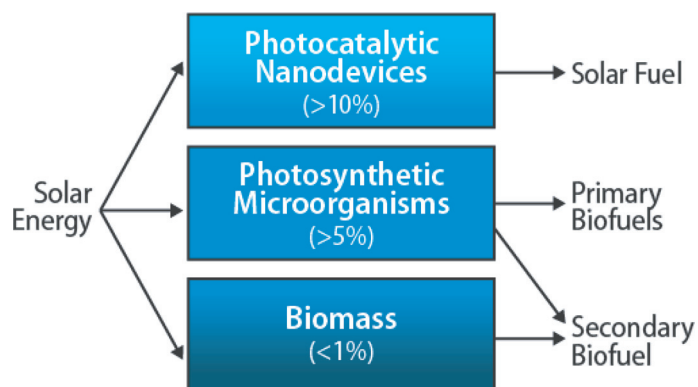

Figure 11.15 | Third-generation biofuels, with the potential for higher solar energy conversion efficiencies than first- or second-generation biofuels. Source: Aartsma et al., 2008.

generating cost estimates for several commercially mature technologies is shown in Table 11.10. Analogous estimates for commercial biomass-fired heat production technologies are provided in Table 11.11.

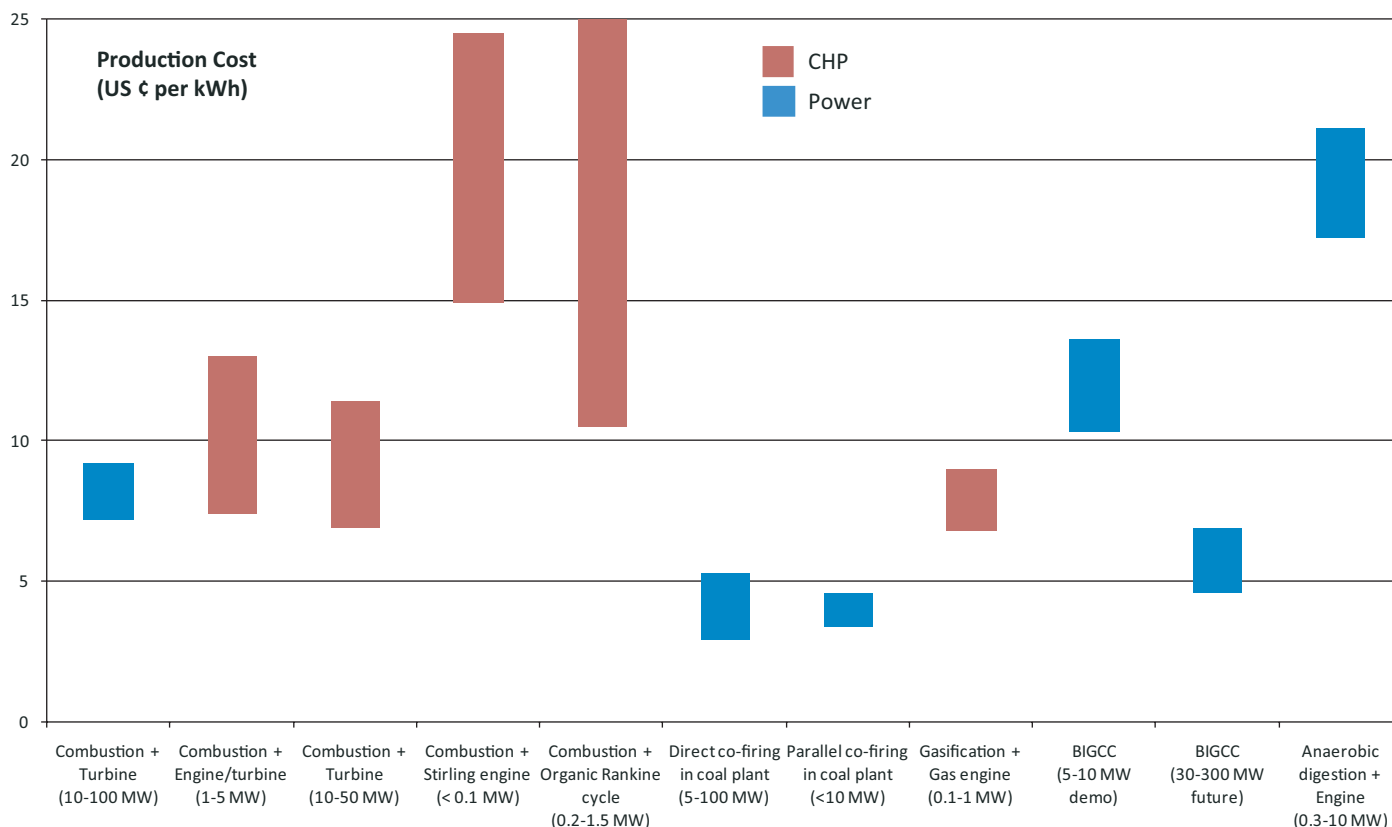

Figure 11.16 | Projected production costs for biomass to power and to CHP. Anaerobic digestion can also be operated in CHP mode; production cost will reduce by 60–80% (depending on technology and plant size) if “free” biomass feedstock is used, such as MSW, manure, or wastewater. Source: based on Bauen et al., 2009.

Table 11.10 | Estimated levelized cost of electricity for commercial biomass-fired electricity generating technologies. Capital investment, operating and maintenance costs, conversion efficiencies, and feedstock costs are from Annex III in IPCC (2011).

					US ₂₀₀₅ ¢/kWh _e			
					5% Discount rate		10% Discount rate	
					Biomass Price, \$/GJ (HHV)			
Capacity range, MW _e	Capital investment, US\$/kW _e	Annual capacity factor, %	Conversion efficiency, % (HHV)	1.25	5	1.25	5	
Stoker boiler/ steam turbine	25–100	2600	75	27	6.1	11.1	7.6	12.6
		4000			7.9	12.9	10.1	15.1
Co-feed/co-fire with coal	20–100	430	75	36	2.1	5.8	2.3	6.0
		500			2.2	5.9	2.5	6.2
Small steam CHP ^a	2.5–10	4100	62	18	7.3	14.8	10.2	17.7
		6200			10.5	18.0	14.7	22.2

^a Includes a byproduct heat credit of US¢5.4/kWh_e.

For most first-generation biofuels, fluctuating crop prices during the past decade created large swings in production costs. Even in periods with low feedstock costs, however, essentially all first-generation biofuels (with one important exception) historically have been unable to compete on cost with prevailing petroleum-derived fuels. Table 11.12

provides a self-consistent comparison of first-generation biofuel production costs.

Ethanol made from sugarcane in Brazil is the lone first-generation fuel that has been able to compete with gasoline at prevailing oil prices

Table 11.11 | Estimated levelized cost of heat from biomass CHP. Capital investment, operating and maintenance costs, conversion efficiencies, and feedstock costs are from Annex III in IPCC (2011).

					US ₂₀₀₅ \$/GJ			
					5% Discount rate		10% Discount rate	
					Feedstock Price, US\$/GJ (HHV)			
	Capacity range, MW _{th}	Capital investment, US\$/kW _{th}	Annual capacity factor, %	Conversion efficiency, % (HHV)	3.7	6.2	3.7	6.2
Biomass steam turbine CHP	12–14	370	69	25	16	26	17	27
		1000			19	29	20	30
					3.7	6.2	3.7	6.2
Biogas CHP	0.5–5	170	80	25	18	28	18	28
		1000			21	31	22	32

Table 11.12 | Estimated levelized cost of fuel for commercial first-generation biofuels. Capital investment, operating and maintenance costs, conversion efficiencies, and feedstock costs are from Annex III in IPCC (2011).

					US ₂₀₀₅ \$/GJ (HHV)			
					5% Discount rate		10% Discount rate	
					Feedstock Price, US\$/GJ (HHV)			
	Capacity range, kW _{th}	Capital investment, US\$/kW _{th}	Annual capacity factor, %	Conversion efficiency, % (HHV)				
					2.1	6.5	2.1	6.5
Brazil, cane ethanol	170–1000	200	50	17	15.0	40.9	17.7	39.2
		660			17.4	43.2	18.9	44.8
					4.2	10	4.2	10
USA, corn ethanol	140–550	168	95	54	10.8	21.5	11.0	21.7
		253			11.0	21.7	11.3	22.0
					9.7	24	9.7	24
USA, soy biodiesel	44–440	168	95	103	12.7	26.6	12.9	26.8
		316			13.1	27.0	13.5	27.4
					7	18	7	18
Brazil, soy biodiesel	44–440	168	95	103	9.7	20.4	10.0	20.6
		326			10.2	20.8	10.6	21.3

^a Byproduct credits are included in each case. See Annex III of Chum et al., 2011 for details.

in the recent past. The Brazilian industry, launched in the 1970s, was subsidized (in decreasing amounts with time) for nearly 30 years. Long-term sugarcane breeding programs, together with research and development on agronomic and distillery practices, have led to significant reductions in sugarcane production costs over time in Brazil,⁵ to the

point where Brazilian ethanol competes today without subsidy with petroleum-derived gasoline (see Figure 11.17). Also, essentially all of the energy required for processing the cane into ethanol is derived from bagasse, the fibrous residue of juice extraction, so producers incur little or no purchased-energy costs, and net greenhouse gas emissions are modest.

5 Increased sugarcane yields achieved by concerted research and development have been the main driving force behind cost reductions: sucrose content and thus ethanol yield have been increased; ratoon harvesting (multiple harvests from one planting) has been extended; efficiency of manual harvesting has improved; mechanical harvesting has increasingly displaced manual harvesting; and the use of larger transport trucks has further reduced feedstock costs. Residues used for electricity production, along with electricity production efficiency, have also been increasing.

The reliability of cost estimates for second-generation biofuels is difficult to assess due to the pre-commercial nature of technologies and the uncertainty of future feedstock costs, among other variables. With presently understood (but not yet commercially demonstrated) systems, ethanol is estimated to be competitive with oil-derived gasoline when

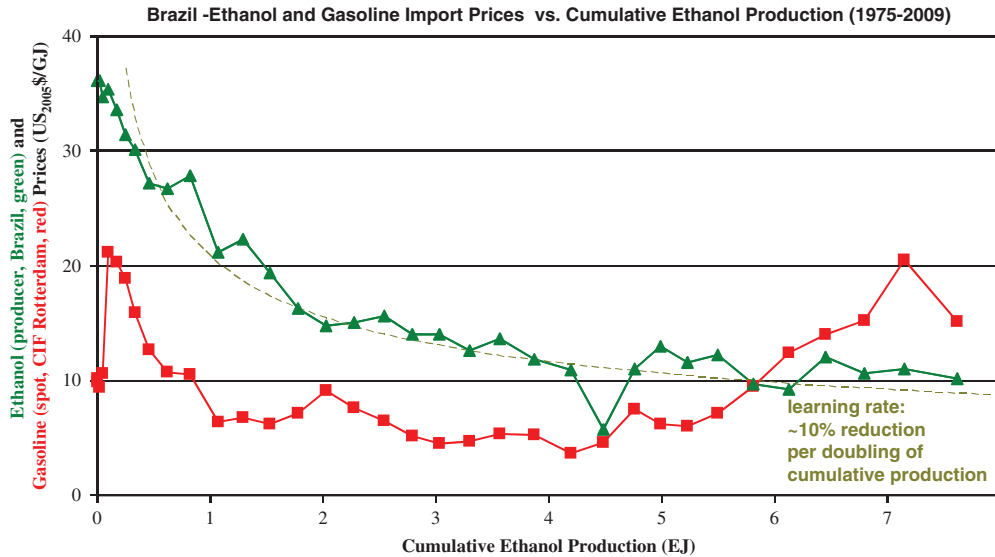

Figure 11.17 | Selling price for ethanol in Brazil versus cumulative production, compared with Rotterdam price for gasoline. Source: Mytelka and de Sousa Jr., 2011; see also van den Wall Bake et al., 2009.

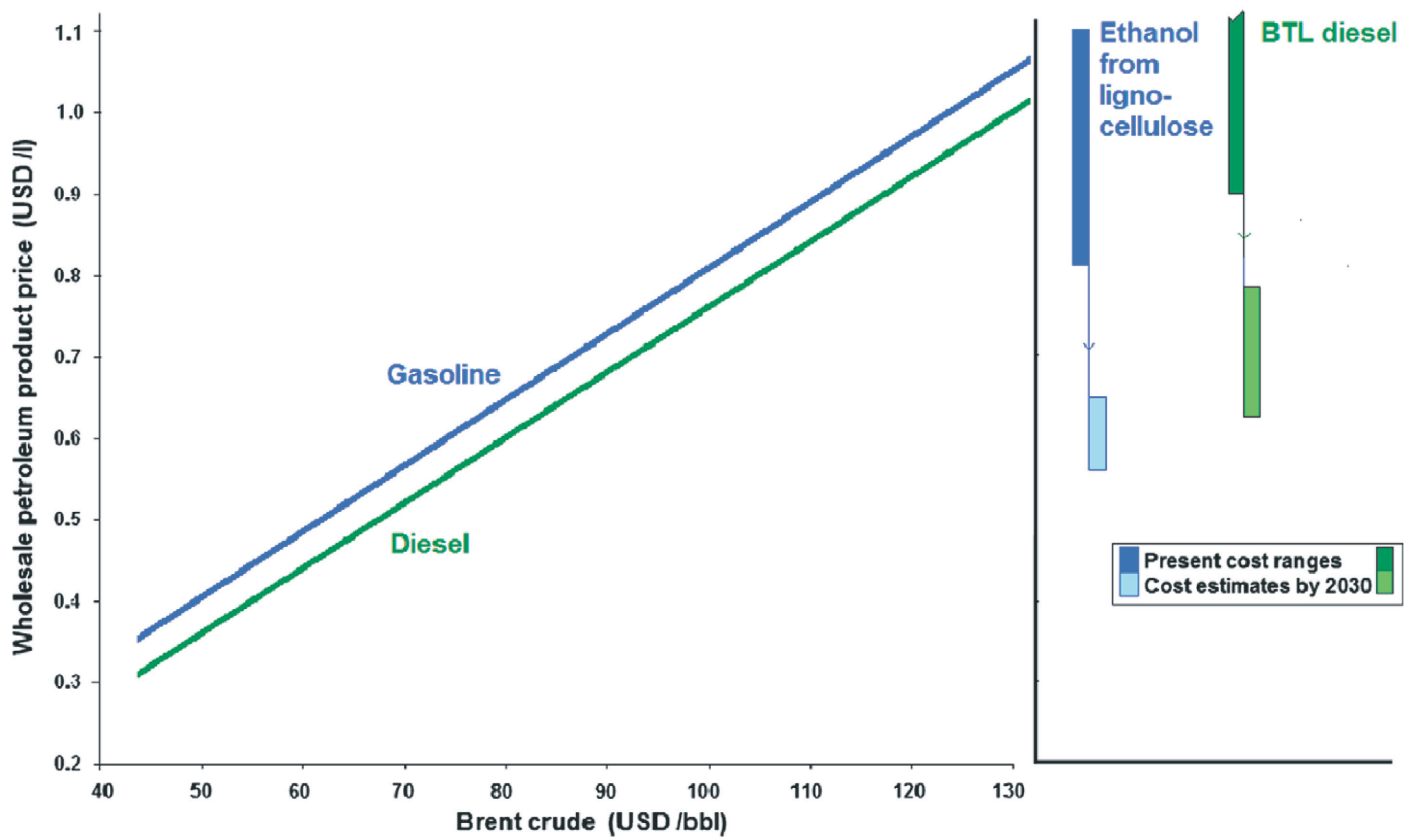

Figure 11.18 | Range of production cost estimates for second-generation biofuels (in US₂₀₀₆\$ per liter of gasoline equivalent). The 2030 estimates assume significant investment in RD&D. Source: Sims et al., 2010.

the crude oil price is in the range of US\$100–140/bbl with the range for BTL (biomass-to-Fischer-Tropsch-liquid) being higher than this. (See Figure 11.18.) With significant investments in RD&D efforts over the next 20 years, the oil price at which ethanol competes with gasoline may fall

to US\$60–80/bbl (see, e.g., Hamelinck and Faaij, 2006) and to US\$80–100/bbl in the case of BTL. Sims et al. (2010) suggest that greater cost reductions may be anticipated for ethanol than for BTL because many of the components of BTL systems are already commercially mature (in

other applications). Table 11.13 provides another perspective on projected costs for liquid biofuels in the 2020–2030 timeframe.

An important consideration is how the cost and performance of advanced biomass conversion technologies can be expected to change as commercial experience is gained. Bioenergy systems show technological learning and related cost reductions with progress ratios (a measure of the rate of reduction in cost with increasing cumulative production) comparable to those of other renewable energy technologies (Chum et al., 2011). This applies to cropping systems, supply systems, and logistics (as clearly observed in Scandinavia) and in conversion (ethanol production,

power generation, biogas, and biodiesel). There has been clear technology learning for several important bioenergy systems (see Table 11.14), but with the exception of ethanol from sugarcane in Brazil or systems with unusually low biomass feedstock costs, most still require subsidies to be competitive.

In the 2030 timeframe, the performance of existing bioenergy technologies can be improved considerably, while new technologies offer the prospect of more-efficient and competitive deployment (Chum et al., 2011).

11.2.6 Sustainability Issues

Fossil fuel inputs are significant for producing most first-generation biofuels, as shown in Figure 11.18, with the notable exception of ethanol from sugarcane in Brazil. For the other biofuels in Figure 11.19, two parameters are especially important: the amount of fossil energy consumed that is assigned to non-biofuel co-products of the process and the energy source used to provide the process heat needed at the conversion facility.

The case of ethanol made from wheat grain illustrates the significance of these parameters. For each of the wheat ethanol cases shown in Figure 11.19, the low and high estimates correspond, respectively, to use of the co-product (distillers dried grains, or DDGs) as an energy source at the facility (reducing the need for external energy inputs) or

Table 11.13 | Projected biofuel production costs in the period 2020–2030, in US₂₀₀₅\$/GJ.

Biofuel	Projected Production Costs
Sugarcane ethanol, Brazil ^a	9–10
Corn ethanol, USA ^a	16
Rapeseed biodiesel ^a	25–37
Lignocelulose sugar-based biofuels ^b	6–30
Lignocelulose syngas-based biofuels ^b	12–25
Lignocelulose pyrolysis-based biofuels ^b	14–24
Gaseous biofuels ^b	6–12

^a Numbers from Chum et al., 2011 (Table 2.7).

^b Numbers from Chum et al., 2011 (Table 2.18).

Table 11.14 | Overview of experience curves for biomass energy technologies and energy carriers. Cost/price data from various sources.*

System	Learning Rate (%)	Time frame	Region	N	R ²
Feedstock production					
Sugarcane (tonnes sugarcane per ha/yr) ^a	32 ± 1	1975–2005	Brazil	2.9	0.81
Corn (tonnes corn per ha/yr) ^b	45 ± 1.5	1975–2005	USA	1.6	0.87
Logistics chains					
Forest wood chips (Sweden) ^c	12–15	1975–2003	Sweden/Finland	9	0.87–0.93
Conversion investment & operation and maintenance (O&M) costs					
CHP plants (€/kWe) ^c	19–25	1983–2002	Sweden	2.3	0.17–0.18
Biogas plants (€/m ³ biogas/day) ^d	12	1984–1998		6	0.69
Ethanol from sugarcane ^a	19 ± 0.5	1975–2003	Brazil	4.6	0.80
Ethanol from corn (only O&M costs) ^b	13 ± 0.15	1983–2005	USA	6.4	0.88
Final energy carriers					
Ethanol from sugarcane ^a	7 / 29	1980–1985	Brazil	~6.1	n.a.
Ethanol from sugarcane ^a	20 ± 0.5	1975–2003	Brazil	4.6	0.84
Ethanol from corn ^b	18 ± 0.2	1983–2005	USA	7.2	0.96
Electricity from biomass CHP ^d	8–9	1990–2002	Sweden	~9	0.85–0.88
Electricity from biomass ^f	15	Unknown		n.a.	n.a.
Biogas ^d	0–15	1984–2001	Denmark	~10	0.97

* The learning rate is defined as the percentage reduction in cost for each doubling in cumulative production. N is the number of doublings observed in cumulative production, and R² is the regression correlation coefficient for the data.

References: ^avan den Wall Bake et al., 2009; ^bHettinga et al., 2009; ^cJunginger et al., 2005; ^dJunginger et al., 2006; ^eGoldemberg et al., 2004; ^fIEA, 2000.

Source: Chum et al., 2011.

First Generation Biofuels

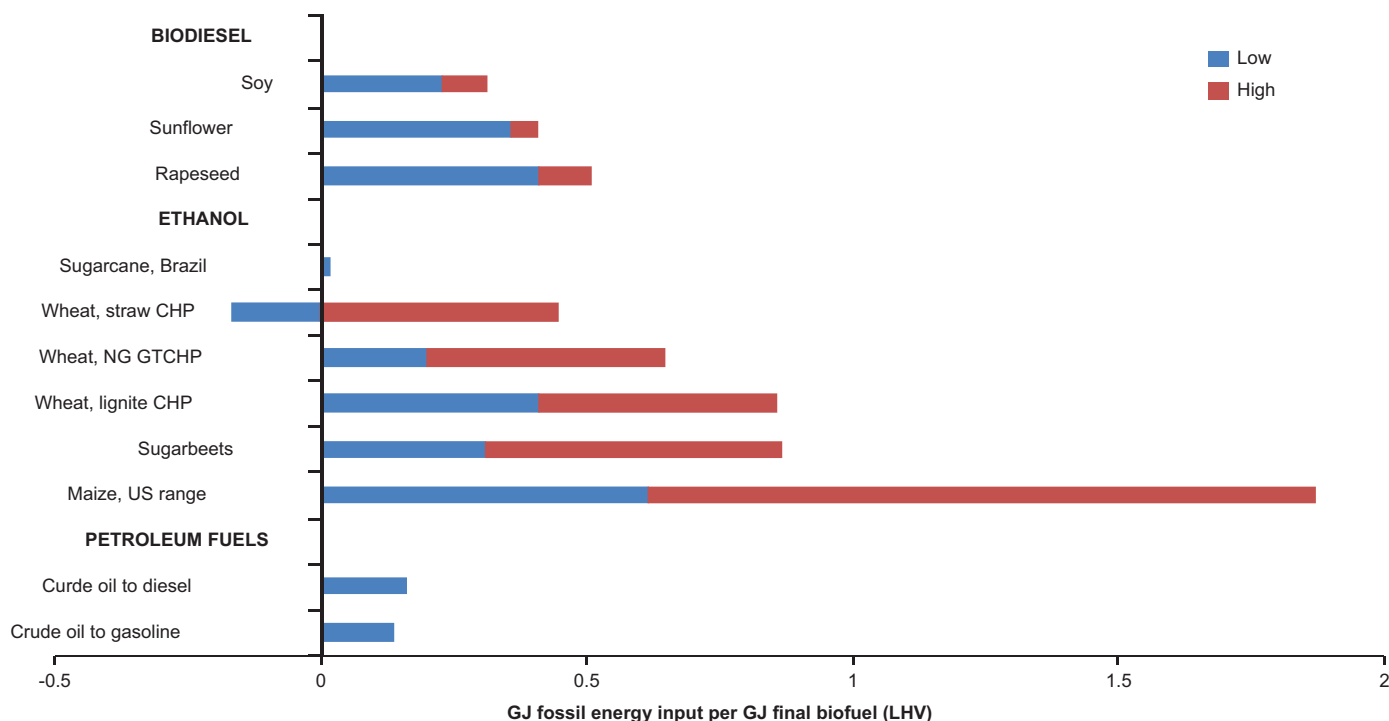

Figure 11.19 | Lifecycle fossil energy use estimates in production of several first generation biofuels and two petroleum fuels. Source: based on CONCAWE et al., 2008; Pradhan et al., 2009; Sheehan et al., 1998b; Farrell et al., 2006.

as an animal feed. For the latter case, the animal feed co-product was assigned fossil fuel emissions equivalent to the fossil energy that would have been consumed to produce animal feed from traditional sources (CONCAWE et al., 2007). The significance of external fuel used for processing energy is evident also in the wheat ethanol cases: fossil energy use is highest when lignite is used, somewhat lower when natural gas is used, and lowest when wheat straw (a non-fossil fuel) is used. In fact, when wheat straw and DDGs are used for fuel onsite, the facility is able to produce an excess of electricity that can be exported to replace electricity that would otherwise have been produced elsewhere from fossil fuels, resulting in net negative fossil fuel consumption.

Biofuels are often valued for the enhanced security of liquid fuel supplies that they provide. Thus petroleum use in the production of biofuels is an important subset of total fossil fuel use. For essentially all biofuels, petroleum use is relatively low. Estimates vary, depending on specific assumptions. In the case of corn ethanol in the United States, estimates of about 0.03–0.3 MJ of petroleum input per MJ of ethanol produced are indicated in a summary by Farrell et al. (2006).

Estimates of life-cycle GHG emissions associated with the production of first-generation biofuels span a wide range, depending on the assumptions used. As with the petroleum estimates, a particularly important assumption relates to how GHG emissions are allocated among co-products. Figure 11.20 shows ranges depending on co-product assumptions for several first-generation biofuels.

It is important to note that the results shown in Figure 11.20 exclude any considerations of GHG emissions arising from land use changes associated with production of the biofuels. Land use change emissions can result when land is converted from an existing use to production of biomass for energy (so-called direct land use change). Emissions may also result from land use changes in one region of the world as a result of establishing biomass energy production in another region (indirect land use changes). Chapter 20 discusses land use change impacts of biomass production.

The high yields for second-generation biofuels in term of GJ/ha/y (see Table 11.9) are achieved with relatively less need for fossil fuel inputs than for first-generation fuels. This is in part because well-designed second-generation conversion systems will use generally unconvertible portions of the incoming biomass as fuel to generate the energy needed to run the conversion facility. For example, lignin is envisioned to be used for this purpose in many biochemical ethanol production systems. The larger scale envisioned for second-generation biofuel production plants also enables more-energy-efficient processing.

The low fossil energy requirements result in relatively low life-cycle GHG emissions. Figure 11.21 shows estimates of emissions relative to petroleum-derived gasoline for a range of second-generation fuels (excluding any emissions associated with direct or indirect land use change). Especially notable are the highly negative emissions for systems that use CO₂ capture and storage (CCS, see Chapter 13) as part of the process.

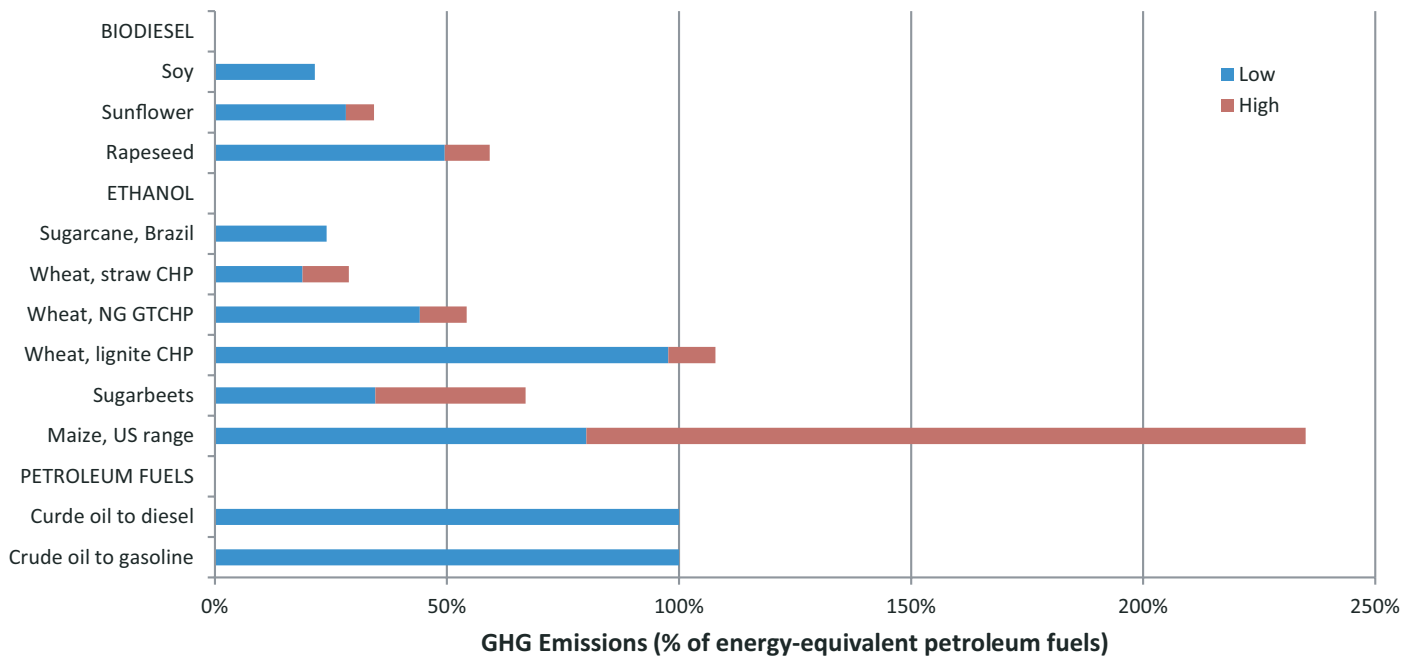

Figure 11.20 | Estimated life-cycle GHG emissions for first-generation biofuels, excluding any impacts of land use change. Source: based on CONCAWE et al., 2008; Pradhan et al., 2009; Sheehan et al., 1998b; Farrell et al., 2006; Macedo et al., 2008. The low and high values for maize ethanol are based on analysis by Shapouri et al. (2002) and Pimental and Patzek (2005), respectively, as reported by Farrell et al. (2006).

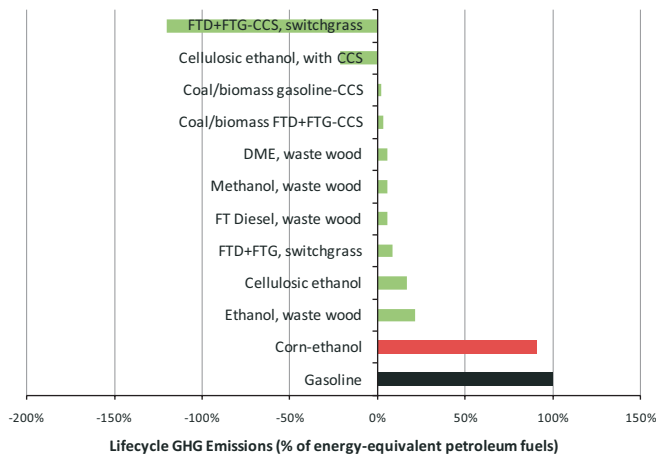

Figure 11.21 | Estimated life-cycle GHG emissions for second generation-biofuels, excluding any impacts of land use change. Estimates for fuels from waste wood are from CONCAWE et al. (2008). The corn-ethanol estimate represents the low estimate from Figure 11.20. The cellulosic ethanol estimates are based on Figure 12.22 in Chapter 12. The ethanol case with CCS assumes capture and storage of fermentation CO₂. Others are based on Table 12.15 in Chapter 12. FTD + FTG refers to synthetic diesel and gasoline made via Fischer-Tropsch synthesis. DME is dimethyl ether.

fuels displaced. If CCS were included as part of the facility design, net GHG emissions would be about the same as for petroleum fuels (see Chapter 12). By using CCS and co-processing an appropriate amount of biomass with the coal (so-called CBTL systems), net GHG emissions can be reduced to zero or less, since capture of photosynthetic carbon from the biomass provides negative GHG emissions to offset unavoidable positive emissions with coal (van Vliet et al., 2009; Larson et al., 2010).

Careful and detailed life-cycle assessments are needed to understand the gains to be made with different algal biofuel systems and thereby help guide future developments toward sustainable systems (IEA, 2010c). Kreutz (2011) has estimated the potential for GHG emissions reduction via reuse of coal power plant CO₂ to fertilize microalgae grown in ponds and converted to biodiesel. His analysis shows that with this approach the carbon mitigation potential is not sufficient to achieve deep GHG emissions reductions. As Kreutz states, “[u]sing the carbon twice fails to meet the objective of deep GHG emission reductions.”

One additional interesting second-generation thermochemical route to fuels production is co-processing of biomass with coal at a single facility. Fuels such as Fisher-Tropsch Liquids, methanol to gasoline, and others can be made purely from coal in much the same manner as they would be made from biomass, but doing so leads to fuel cycle GHG emissions that could be about double those of the petroleum

For bioelectricity, the life-cycle emissions are generally low, between about 10–50 g CO₂-eq/kWh, but also extremes like –1350 and +350 gCO₂-eq/kWh can be obtained depending on the technology and assumptions used (Chum et al., 2011). Negative emissions are achieved when biomass use is combined with CCS, allowing removal of CO₂ from the atmosphere by storing it underground.

11.2.7 Implementation Issues

A wide variety of existing and potential factors hinder the further deployment of bioenergy, related to supplies, technologies, and markets. Some essential supply side concerns relate to risks of biological production and the availability of residues. El Niño, drought, floods, fire, pests, and insect attacks affect production of biomass as well as of food. Some of these risks (fire, pests, insect attacks) can be reduced through proper management, but they cannot be eliminated. In general, diversity is the best mechanism to minimize these risks.

Concerning technologies, the main issues to be dealt with in an economic and environmentally sound manner are robustness of biomass conversion technologies to feedstock variability, the handling and storage of biomass feedstock, the commercialization of technologies with improved economics at small scale, the handling of co-products (e.g., ash, digestate) containing contaminants, and the need for flue gas cleansing meeting stringent limits on toxic emissions (e.g., NO_x, CO, particulates).

In terms of markets, the main risks and barriers are related to feedstock availability and price (representing 50–90% of the production costs of bioenergy), the competitiveness of different biomass conversion routes, the need for clarity and foresight in regulatory aspects such as planning regulation and emission standards, an unstable and unsupportive policy environment, and the interaction with other sectors – such as food and forestry – and the policies that affect them.

In the past few decades, bioenergy developments have been promoted and supported by governments of many countries through a wide variety of policy instruments. Typical examples for liquid biofuels include the Proálcool program launched in Brazil in 1975 to reduce dependence on imported oil; the Common Agricultural Policy in the EU, including production quotas for oilseed food crops as well as exemptions from certain taxes; and the US support included in several farm bills and state and federal incentives for ethanol production (Worldwatch Institute, 2006). Subsidies in one form or another to encourage consumption of first-generation biofuels amounted in 2006 to over US\$6 billion in the United States and nearly US\$5 billion in the European Union (FAO, 2008).

Successful policies to promote biomass for heat have focused on more centralized applications for heat or combined heat and power production in district heating and industry (Bauen et al., 2009). In the power sector, feed-in-tariffs have gradually become the most popular incentive. In addition, policies such as fiscal measures and soft loans have been supportive (Global Bioenergy Partnership, 2007). Quota systems have so far been less successful (van der Linden et al., 2005). Priority grid access for renewables is applied in most countries where bioenergy technologies have been successfully deployed (Sawin, 2004a).

As discussed by Chum et al. (2011), the main drivers behind governmental support for the bioenergy sector have been concerns about energy security and climate change as well as the desire to support the farm sector through increased demand for agricultural products (FAO, 2008). An estimated 69 countries had one or several biomass support policies in place in 2009 (REN21, 2010).

Concerns about the effects of these policies on food prices, questions about the GHG emission savings of biofuels, and doubts about the environmental sustainability of bioenergy have also seen countries rethinking their policies and targets for biofuels blending (IEA, 2009a). In addition, uncoordinated targets for renewables and biofuels without an overall biomass strategy may enhance competition for biomass between the power and transportation sectors (Bringezu et al., 2009). Some national targets will require increased imports, thus contributing to competition for biomass globally. An overall strategy would have to consider all types of use, especially for food and non-fiber biomass (Chum et al., 2011; see also Chapter 20).

11.3 Hydropower

11.3.1 Introduction

Hydropower is a form of renewable energy derived from moving water. It has been applied to generate mechanical power, at watermills for example, for several centuries, and has been used to generate electric power for more than 100 years. Hydropower projects may be usefully categorized by the way they harness water to generate power:

- Hydrokinetic – a project that places in a watercourse devices capable of generating electrical power from the flow of water;
- Run of river – a project that uses a watercourse to pass water through a power plant, with limited storage;
- Reservoir – a project that impounds a watercourse for storage, forming a reservoir, for release through a power plant;
- Pumped storage – a project that pumps water from a lower level to a reservoir at a higher elevation for storage in a cyclical fashion, for release through a power plant at times of high demand.

It should be noted that water is also used for power generation through other means, such as ocean energy (see Section 11.9), and water is used as a medium to drive turbines in thermal power stations or to produce hydrogen.

Hydropower plants are able to operate in isolation, but most of them are connected to a transmission network. The maximum output of individual units ranges from 0.1 kW (models) to 852 MW (Three Gorges power station, China). Three Gorges is nearing its full capacity of 22.5 GW and

is producing around 84 TWh/yr. By comparison, Itaipu power station, on the border between Brazil and Paraguay, generated a record of 95 TWh in 2008, with an installed capacity of 14 GW. This reflects the different operating regimes between the two stations, with Three Gorges fulfilling flood-control and navigational functions in addition to the generation of power. It is common for hydropower facilities, especially of the reservoir type, to serve multiple purposes.

11.3.2 Potential of Hydropower

The theoretical, technical, and economic potentials of hydropower for electricity production were presented in the *World Energy Assessment* (UNDP et al., 2000). An update of those figures is presented in Chapter 7. The main results are as follows:

- The gross theoretical potential for electricity production can be estimated at $40\text{--}55 \times 10^3$ TWh/yr (about $150\text{--}200$ EJ_e/yr).
- The technically feasible potential can be estimated at $14\text{--}17 \times 10^3$ TWh/yr (about $50\text{--}60$ EJ_e/yr).
- The potential used at present is about $3.0\text{--}3.2 \times 10^3$ TWh/yr (about 11 EJ_e/yr).
- The unexploited economic potential with production costs between US¢2–8/kWh can be estimated at about 5×10^3 TWh/yr (about 18 EJ_e/yr); at production costs ranging from US¢2–20/kWh, this figure would be about $11\text{--}14 \times 10^3$ TWh/yr ($40\text{--}50$ EJ_e/yr).

Climate change may have an impact on the potential of hydropower and the availability of hydro capacity in particular river basins, but it is unlikely to affect the global totals (see Section 11.3.3).

Recent energy scenario studies suggest that in 2050 the potential used could have increased to $18\text{--}35$ EJ_e/yr (Greenpeace and EREC, 2007; IEA, 2008b; 2009a). This figure translates into savings on primary energy use through conventional power generation of $36\text{--}70$ EJ/yr in 2050, assuming a significant improvement in the average conversion efficiency of fossil-fueled power plants from about 35% to 50% in the period 2010–2050.

11.3.3 Market Developments

In 2008 and 2009, hydropower provided about 3100 ± 100 TWh, nearly 16% of the world's electricity generation, which was more than 80% of renewable energy-sourced electricity generation (US EIA, 2011; BP, 2011). This figure translates to fossil fuel savings in conventional power production equivalent to about 32 EJ/yr (assuming a conversion efficiency of 35%) or about 6% of global primary energy

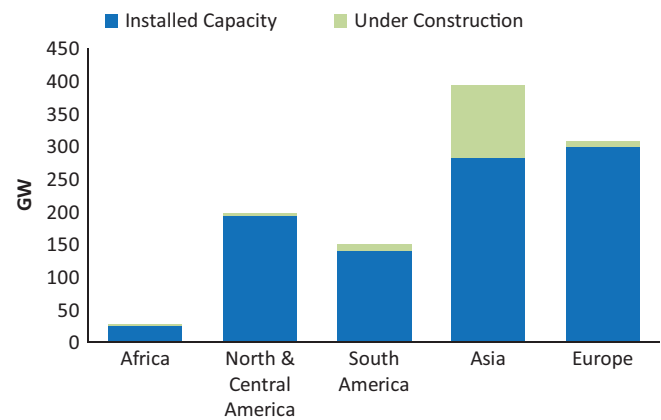

Figure 11.22 | Global installed hydropower capacity, by region, in 2009, including capacity under construction. Source: based on IHA, 2010a.

use. Hydropower is currently generating electricity in some 160 countries, using more than 11,000 stations with around 27,000 generating units (Taylor, 2010).

11.3.3.1 Installed Capacity and Capacity under Construction

Global installed capacity estimates for 2007 range from 860 to 950 GW (IHA, 2010a). According to REN21, global installed capacity can be estimated at about 920 GW in 2007, 950 GW in 2008, 980 GW in 2009, and 1010 GW in 2010 (REN21, 2009; 2010; 2011). Included in these figures are hydropower projects with less than 10 MW installed capacity (about 60 GW in 2009). A regional breakdown of installed capacity and capacity under construction for 2009 is presented in Figure 11.22. In 2009, 32% of the global capacity was installed in Asia, 29% in Europe, 20% in North and Central America, 16% in South America, and 3% in Africa.

According to regular surveys of hydro equipment suppliers by the International Hydropower Association (IHA), 2007 and 2008 were record years in the history of hydropower deployment. From 2005–2009 approximately 135 GW of additional capacity were commissioned, an average of 27 GW/yr, indicating a growth rate of 3% a year. It would appear realistic to assume at least this rate of development will continue into the foreseeable future. For smaller-scale hydro (<10 MW), the growth rate is estimated at about 9% a year.

11.3.3.2 Regional Developments

Hydropower is undergoing rapid development in Asia and Latin America in line with the remarkable growth of these regions. Aside from the recent economic transformations, other factors contributing to growth there include using hydropower to further stimulate economic growth, improve energy and water security, and mitigate and adapt to climate

Table 11.15 | Estimated changes in hydropower generation due to climate change by 2050.

Region	Installed capacity in 2005 [GW]	Generated electricity in 2005 [TWh/yr]	Change by 2050 [TWh/yr]
Africa	22	90	0.0
Asia	246	996	2.7
Europe	177	517	-0.8
North America	161	655	0.3
South America	119	661	0.3
Oceania	13	40	0.0
TOTAL	737	2931	2.5

Source: Hamududu and Killingveit, 2010.

change. Despite high levels of existing deployment in North America and Europe, these regions also continue to show sizable growth. These developments are in sharp contrast to sub-Saharan Africa, a region with proportionally the lowest deployment to potential (less than 10% of its technical potential). Governance, institutional capacity, and financing rather than the lack of available resource remain major impediments to hydropower development in this region.

11.3.3.3 Potential Impacts of Climate Change on Hydropower

Table 11.15 presents the potential impacts of climate change on hydropower. Projected power generation in 2050 is compared with 2005 based on 12 different climate models. These suggest that losses in some areas will be offset by gains in others, resulting in a largely unchanged or slightly improved global picture of hydropower availability in 2050.

Further work is required to ascertain the impacts of climate change on existing hydropower infrastructure and future development. At present these are uncertain, but it seems clear that climate change will alter the hydrologic cycle at the river basin level. Although this does not change the amount of water in the global hydrologic cycle, changes, some of them significant, are anticipated in the spatial and temporal facets of precipitation and glacial discharge, which will vary from river basin to river basin. The changes this may bring to flows in some catchments could affect hydropower availability, particularly if reservoir storage is managed poorly or if there is limited storage capacity (run of river). Overall, it may be that the positive and negative impacts of climate change balance each other out if the value of water storage is appreciated in forward planning, e.g., by increasing capacity or adding spillways.

Pressure on scarce water resources coupled with a changing hydrologic cycle also increases the importance of hydropower's water storage capabilities. The impetus for developing reservoir projects grows if it is appreciated that water storage also provides energy storage and ancillary service capabilities.

11.3.4 Hydropower Technology Developments

Hydroelectricity generation is generally regarded as a proven, mature technology. For example, conventional turbines have reached 96% efficiency. Yet advances in the technology are still being made.

11.3.4.1 Technology Improvements

Inside the powerhouse, improvements include abrasion-resistant turbines, variable speed technology, and fish-friendly equipment. Also beyond conventional project types, developments in ultra-low head technology and hydrokinetic turbines show promise, especially for existing non-hydropower facilities, such as water reservoirs, weirs, barrages, canals, and falls. Outside the powerhouse, improvements include tunnel boring by machine, roller compacted concrete dams, and use of geomembranes, allowing potential civil works cost savings.

Further efficiencies are expected to be made through modernization and up-rating of aging hydropower stations. Most of the current generation capacity will require refurbishment within the next 30 years. (On average, major refurbishment of generation equipment and machinery is required every 40 years or so.) Consequently, these are ongoing benefits.

11.3.4.2 System Integration

The role that hydro will play in future energy networks is also changing. Most of the early hydropower projects were developed to provide continuous supply (base load) to the power system. This pattern will continue in countries where hydropower provides a significant share of power generation. As other electricity generation technologies have developed, however, the role of hydropower has evolved to encompass a supporting service. Given its unique abilities to store energy and move quickly to full capacity from standstill, it has assumed importance in peak loading when demand requires it.

As other renewable energy use expands on national grids, these abilities on the part of hydropower will assume greater importance: some renewable energies tend to supply electricity on a variable basis (solar photovoltaics, for instance, and wind). By matching these with hydropower, synergies develop from hydro's capacity to supply power on demand, which allows renewable variability to be balanced, as well as matching supply with demand.

The variable nature of some renewables, as well as the costs associated with matching output at times of reduced demand with fossil fuels, geothermal, and nuclear thermal generation options (resulting in these being kept running through periods of low demand), means that there is often excess power in a grid in times of low usage. This has created an increasingly important role for pumped storage hydro through the recycling of stored water.

11.3.4.3 Pumped Storage

Pumped storage facilities make use of the energy of water pumped from a lower level to a reservoir at a higher elevation. The water is brought up to the reservoir when demand for power is low (and when there is excess capacity in the generation system, resulting in cheaper electricity), and it is stored for use to meet peaks in demand. It thus provides peak load capabilities, as well as being available to deal with the intermittency issues surrounding other renewable energies. In 2008, pumped storage capacity in operation worldwide has been estimated to be 127 GW (Ingram, 2009).

It is anticipated that the market for pumped storage will increase by 60% by 2014 (Ingram, 2009). However, as pumped storage is a net user of electricity (about 20% of the energy is lost in the cycle of pumping and generating), its viability depends on clear and predictable differentials in price between periods of low and peak demand.

11.3.5 Economic and Financial Aspects

Hydropower projects are very site-specific. This makes it difficult to predict the amount of engineering required, and therefore the final cost, until investigations are well advanced. In complicated cases, this can lead to sizable cost overruns during construction.

Projects typically have a high upfront capital cost and risk profile. But operation and maintenance costs are very low. (See Table 11.16.) The long life of projects, electro-mechanical equipment about 40 years and civil works about 80–100 years, means that once capital expenditure is amortized, electricity can be produced very economically. This gives hydropower projects an economic life cycle that is quite different from other energy options.

Development costs on hydropower plants may range from US\$1000–5000/kW installed capacity. O&M costs can be estimated at US¢0.3–1/kWh. The capacity factor of hydropower plants may be between 30–80%, depending, among other factors, on the characteristics of the energy system within which the hydro power plant operates. Assuming an economic lifetime of the system of 40–80 years and a discount rate ranging from 5–10%, the levelized cost of energy may be between US¢1.5–12/kWh for larger-scale systems (>100 MW) and between US¢1.5–20/kWh for smaller-scale systems (<10 MW). (See Table 11.17.) Because the plant is usually sited far from the point of electricity use, investments may also be required for transmission, perhaps adding another US¢1/kWh.

While these characteristics make many hydropower projects economically viable from a public sector perspective, they do not necessarily translate into financial viability for the private sector. Figure 11.23 presents a range of electric utility and project experiences, comparing average energy tariffs required to make private hydropower financially viable with the average generation cost of most electric utilities. The figure shows a high hydropower tariff in the first 10–20 years because

Table 11.16 | Costs of Hydropower Development.

Project size (MW)	Development cost (US\$ million/MW)	Operational cost (US\$/MWh)
< 10	1 to > 5	3 to 10
10 to 100	1 to 3	3 to 7
> 100	1 to 2.5	3 to 7

Source: Taylor, 2008.

of the relatively high investment costs, but a low tariff when return of investments has been achieved.

The main challenges for hydropower are therefore reducing risk and raising investor confidence, especially prior to project permitting. These challenges are compounded in the least developed countries, where international public financing (multilateral or regional development banks, for example, or bilateral development assistance) continues to play a strong role.

Given the capital cost and risk profile, there have been relatively few successful independent power producer projects above 100 MW (Trouille and Head, 2008). Most projects have required a substantial amount of state involvement to get off the ground. However, there are increasing pressures on the public sector to provide a favorable environment to attract private-sector capital. This is becoming important for hydropower developments in emerging markets. Brazil, for example, is actively using public-private partnerships to drive the development of its hydro capacity (Ray, 2009).

Financing, rather than resource availability, along with governance and institutional capacity, continue to inhibit the growth of hydropower in least developed countries. Given the role that hydropower can play not only in providing energy and water services but also in contributing to the sustainable development of these countries, it is vital that financing, governance, and institutional support mechanisms are adapted.

11.3.6 Sustainability Issues

The development of a hydropower project, whatever its scale, generates a variety of positive and negative effects and involves working with all stakeholders. With over 100 years of development experience, the effects of projects have been relatively well documented and studied. (See Box 11.1.) Modern construction of hydropower plants tries to include in the system design several approaches that minimize social and ecological impacts. Some of the most important impacts are changes in habitat, fish stocks and other species, sedimentation, water quality, and downstream flow regimes. Hydropower reservoirs may also create opportunities for ecological services, tourism, fisheries, irrigation, and secured water supply.

Of note are advances made in proactive avoidance and reduction of negative effects prior to construction of hydropower projects, particularly in the past 20 years in response to changing societal values, increased public scrutiny, and evolving environmental and social

Table 11.17 | Cost of electricity as a function of capacity factor, turnkey investment costs, discount rate, and O&M costs. The O&M costs are assumed as US¢0.3–0.7/kWh for larger-scale systems and as US¢0.3–1.0/kWh for smaller systems. The economic lifetime of a hydro system is assumed to be 40–80 years.

Capacity factor	Turnkey investment costs per kWe installed (plant > 100 MW)	Discount rate	
		5%	10%
		US¢/kWh	
80%	1000	1.4–1.8	2.0–2.4
	3000	3.5–3.9	5.3–5.7
30%	1000	2.5–2.9	4.2–4.6
	3000	6.9–7.3	11.9–12.3

Capacity factor	Turnkey investment costs per kWe installed (plant < 10 MW)	Discount rate	
		5%	10%
		US¢/kWh	
80%	1300	1.4–2.1	2.3–2.9
	5000	4.4–5.1	7.6–8.3
30%	1300	3.2–3.9	5.3–6.0
	5000	11.3–12.0	19.7–20.4

standards. Managing the positive and negative environmental, social, and economic effects of a given project at local, national, regional, and even international levels remains complex.

11.3.6.1 Sustainability Assessment Protocol

The hydropower sector has been actively addressing issues of sustainability for more than a decade through engagement with key stakeholders. This has led the International Hydropower Association to develop Sustainability Guidelines (2004) and a Sustainability Assessment Protocol (2006) to guide and measure the sustainability performance of a hydropower project from conception to operation. The Hydropower Sustainability Assessment Forum in 2008 was formed as a direct result of these efforts. The Forum contains key stakeholders: representatives of industrial and developing countries, environmental and social NGOs, commercial and development banks, and the hydropower industry. A 2010 Forum-reviewed version of the Protocol adopted by IHA has now moved into the implementation phase. It measures performance against relevant criteria over four stages of a project. (See Figure 11.24.)

The consensus among key stakeholders on how to measure project sustainability paves the way for improved sustainability performance and more informed decision-making on hydropower development, particularly in the policy and financial arenas.

11.3.6.2 GHG Status of Reservoir Hydropower

As a renewable energy source, hydropower is recognized as being both clean and a low-carbon technology. A life-cycle assessment (LCA)

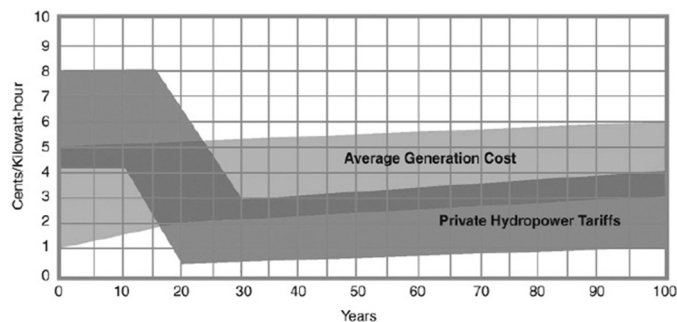

Figure 11.23 | Hydropower tariff versus average electricity generation costs in US₂₀₀₈¢/kWh. Source: Trouille and Head, 2008.

published by the International Energy Agency in 2000 suggests that GHG emissions could range from 2–48 gCO₂-eq/kWh for reservoir type systems and from 1–18 gCO₂-eq/kWh for run-of-river systems (IEA, 2000). An overview published by the IPCC concludes that “the majority of lifecycle GHG emissions estimates for hydropower cluster between about 4–14 gCO₂-eq/kWh, but under certain scenarios there is the potential for much larger quantities of GHG emissions” (Kumar et al., 2011).

In conclusion, there is uncertainty and no consensus yet on these figures among experts (or, separate from the numbers, on LCA methodology for hydropower). In some circumstances freshwater reservoirs can produce highly elevated GHG emissions, a phenomenon that is the subject of ongoing research. Specific problems have included a lack of standard measurement techniques, limited reliable information from a sufficient variety of sources, and the lack of standard tools for assessing net GHG exchanges (Goldenfum, 2011).

The lack of scientific consensus has impeded progress in decision-making on carbon accounting and in carbon markets. For example, guidance is needed to support national GHG inventories, to develop methods (measurement and predictive modeling) of establishing the GHG footprint of new reservoirs (hydro, multipurpose, and non-hydro alike), and to quantify more precisely the carbon offsets of hydropower projects for GHG emissions trading. These circumstances led to the establishment of the UNESCO/IHA GHG Status of Freshwater Reservoirs Research Project in 2008 (Goldenfum, 2011). The project’s main goals are:

- Developing, through a consensus-based, scientific approach, detailed measurement guidance for net GHG assessment
- Promoting scientifically rigorous field measurement campaigns and the evaluation of net emissions from a representative set of freshwater reservoirs throughout the world
- Building a standardized, credible set of data from these representative reservoirs

Box 11.1 | Sustainable Hydropower in Nepal



Source: IHA, 2005.

The Andhikhola Hydel & Rural Electrification Hydro Scheme in western Nepal was built in 1991 with technical and financial assistance from the Norwegian Development Agency.

A concrete gravity diversion weir on the Andhikhola River diverts water through a 1.3 km long tunnel and a 234 m vertical drop shaft. The 5 MW powerhouse is currently equipped with secondhand turbines previously used in Norway. The tunnel system also diverts water for irrigation. The opportunity was taken during construction to build Nepalese experience in tunneling technology as well as other areas of technical capability. Various elements of the scheme have demonstrated exceptional innovation to fit with aspects of capacity building, resource availability, and the remoteness of the site.

Some 100,000 people in the region now enjoy the benefits of an electricity supply for the first time. With the available power, more than 200 small enterprises have been established, creating employment for hundreds of people.

- Developing predictive modeling tools to assess the GHG status of unmonitored reservoirs and potential sites for new reservoirs
- Developing guidance and assessment tools for mitigation of GHG emissions at sites vulnerable to high net emissions.

The project has benefited from collaboration among some 160 researchers, scientists, and professionals working in the field, representing more than 100 institutions. In July 2010 the project met its first goal by publishing *GHG Measurement Guidelines for Freshwater Reservoirs*, which represents the state of the art in measurement guidance for net GHG assessment of reservoirs (Goldenfum, 2011).

11.3.7 Implementation Issues

Financing is by far the biggest obstacle for scaling up hydropower development. Barriers are especially high in the poorest countries. It is thus

important for the public and private sectors to work together to reduce risk profiles and unlock finance.

A substantial opportunity to adapt is provided by the economic dimension of climate change policy. The important role that climate change financing can play is indicated by the Clean Development Mechanism (CDM): hydropower accounts for 30% of all registered CDM projects and 48% of all registered renewable energy projects (UNEP Risø, 2011). The additional income generated for projects is generally at levels below 5% of a project's internal rate of return, a stream of revenue not normally categorized as influential. Despite this, such revenues have strong impacts on overall project feasibility. An important factor is that this revenue will be in "hard currency" and can mitigate exchange rate risks for the developer. Further climate change policy and financing innovations to target the sustainable development of developing countries may increase the appetite for investment. For example, the addition of adaptation-driven multilateral and bilateral finance looks likely to emerge as a significant lever for further hydropower development.

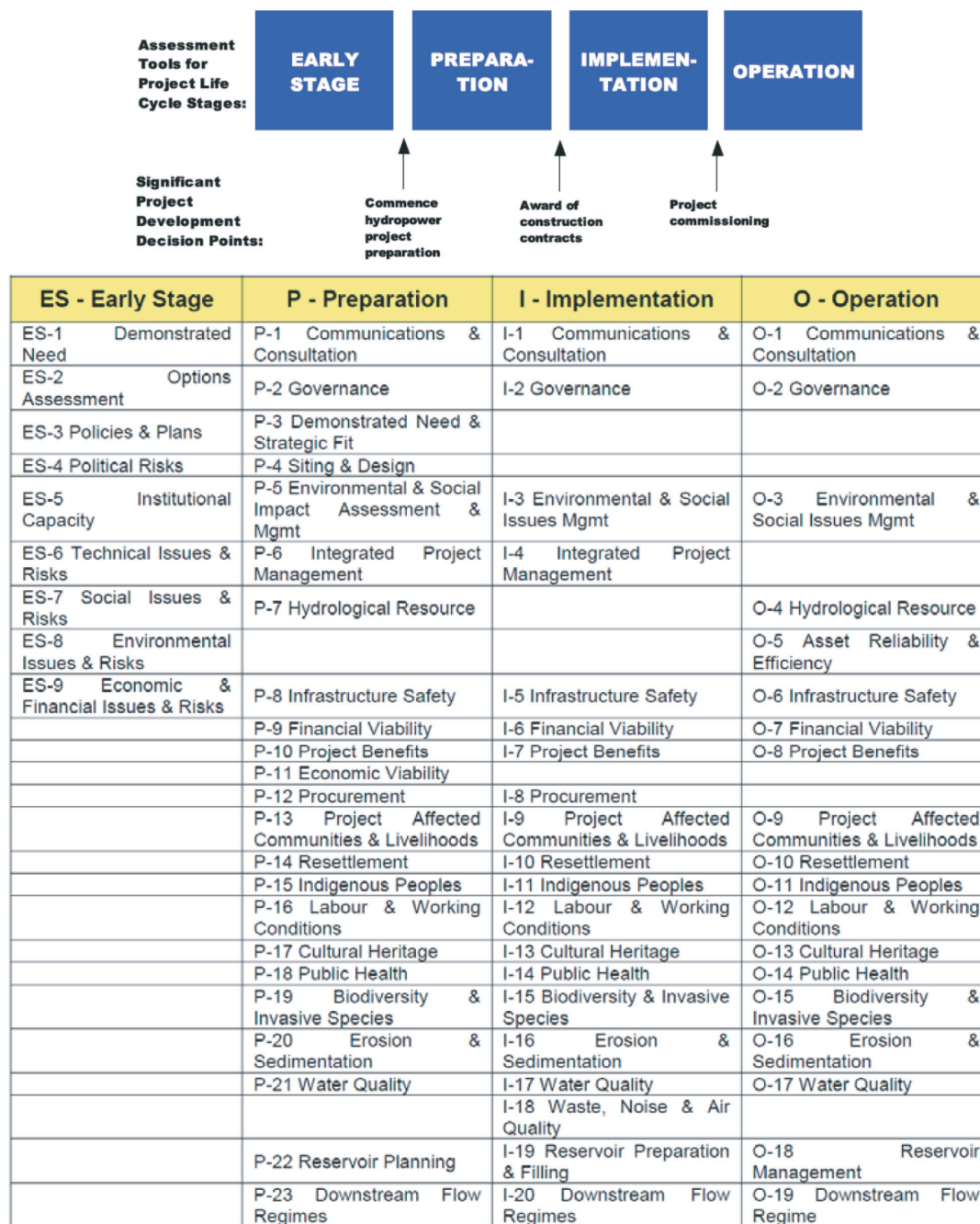

Figure 11.24 | IHA Sustainability Assessment Protocol assessment tools and major decision points, with topics by section. Source: based on IHA, 2010b.

The sustainability performance of hydropower projects remains an ongoing challenge, but this is becoming more manageable with the efforts the sector continues to make at national, regional, and international levels, such as the Hydropower Sustainability Assessment Protocol.

As hydropower can cover base load and peak load demands, its integration into transmission systems can balance the output from variable systems such as wind and solar photovoltaics and can increase the economic value of produced electricity (US DOE, 2004).

The construction and operation of hydropower plants in transboundary river basins requires international cooperation to avoid conflicts over water – particularly as a changing hydrological cycle brought about by climate change is likely to increase pressure on water resources in some river basins.

In rural areas, smaller-scale hydropower may be used alone or connected to a mini-grid to provide electricity or mechanical power for local industrial, agricultural, and domestic uses. Depending on local circumstances, it can play a major role in rural electrification, as has been demonstrated in China and other developing countries. Although

Table 11.18 | Total geothermal use in 2009.

Use	Installed capacity [GW]	Electricity production / direct use [TWh/yr]	Capacity factor	Number of countries reporting
Electric Power	10.7	67.3	0.72	24
Direct Use	48.5	117.8	0.28	78

Source: Lund et al., 2010; Bertani, 2010.

Table 11.19 | Geothermal energy use in 2009 by continent.

Region	Electric Power			Direct Use		
	Installed capacity	Electricity production	Number of countries reporting	Installed capacity	Energy use	Number of countries reporting
Africa	1.6%	2.1%	2	0.3%	0.7%	7
Americas	42.6%	39.0%	6	30.1%	19.0%	15
Asia	34.9%	35.1%	6	28.7%	34.9%	16
Europe	14.5%	16.2%	7	40.0%	43.1%	37
Oceania	6.4%	6.7%	3	0.9%	2.3%	3

Source: Lund and Bertani, 2010.

support of these smaller-scale/rural, often financially challenged projects is desirable, the categorization of hydropower by size in policy and markets in an unsophisticated fashion can distort development outcomes.

11.4 Geothermal Energy

11.4.1 Introduction

Geothermal energy has been used for thousands of years for washing, bathing, and cooking. But it was only in the twentieth century that geothermal energy was harnessed on a large scale for space heating, electricity production, and industrial use. The first large municipal district heating service started in Iceland in the 1930s, and it now provides geothermal heat to about 99% of the 200,000 residents of Reykjavik.

The use of geothermal energy has increased rapidly since the 1970s. In the first decade of the new century, the globally installed direct use capacity tripled from 15 to nearly 50 GW_{th} whereas the installed capacity for electricity production increased from 8.0 to 10.7 GW_{e} .

11.4.2 Potential of Geothermal Energy

At present, geothermal energy is used by 78 countries for heating purposes (called "direct use") and by 24 countries for electricity production (Lund et al., 2010; Bertani, 2010). Table 11.18 presents the worldwide geothermal electric and direct-use capacity as well as the generated

amount of heat and electricity in 2009, based on 70 country papers at the World Geothermal Congress 2010.

The figures for electric power capacity (MW_{e}) and annual generation values (GWh) appear to be fairly accurate. The direct-use figures are less reliable due to reporting errors and lack of data from some countries. Table 11.19 reports on geothermal energy use by continent.

The flow of heat from Earth's interior to its surface is 1400–1500 EJ/yr, with about 315 EJ/yr onshore (Stefansson, 2005; see also Chapter 7). The upper limit for the technical potential to use energy from geothermal resources is estimated at 50–60 TW_{th} (Stefansson, 2005). Part of these resources can be used to produce 1–2 TW_{e} electricity. Most resources, however, are suitable for direct use only, giving access to 22–44 TW_{th} . The technical potential for electricity production can be enhanced if the heat from hot dry rocks can be exploited using enhanced geothermal systems (EGS) technology. This may enlarge the technical potential for electricity production by about a factor of 5–10 (see, e.g., Tester et al., 2006). This may result in a total technical potential of about 700 EJ/yr; the economic potential in 2050 might be as high as 75 EJ/yr (see Chapter 7). The conversion efficiency for electricity generation is around 10% and for direct use nearly 100%.

11.4.3 Market Developments

In 1975 only 10 countries reported electrical production from or direct use of geothermal energy. By now the figure is 78 countries. At least another 10 countries are actively exploring for geothermal resources and are expected to be online by 2015 (Bertani, 2010; Lund and Bertani, 2010).

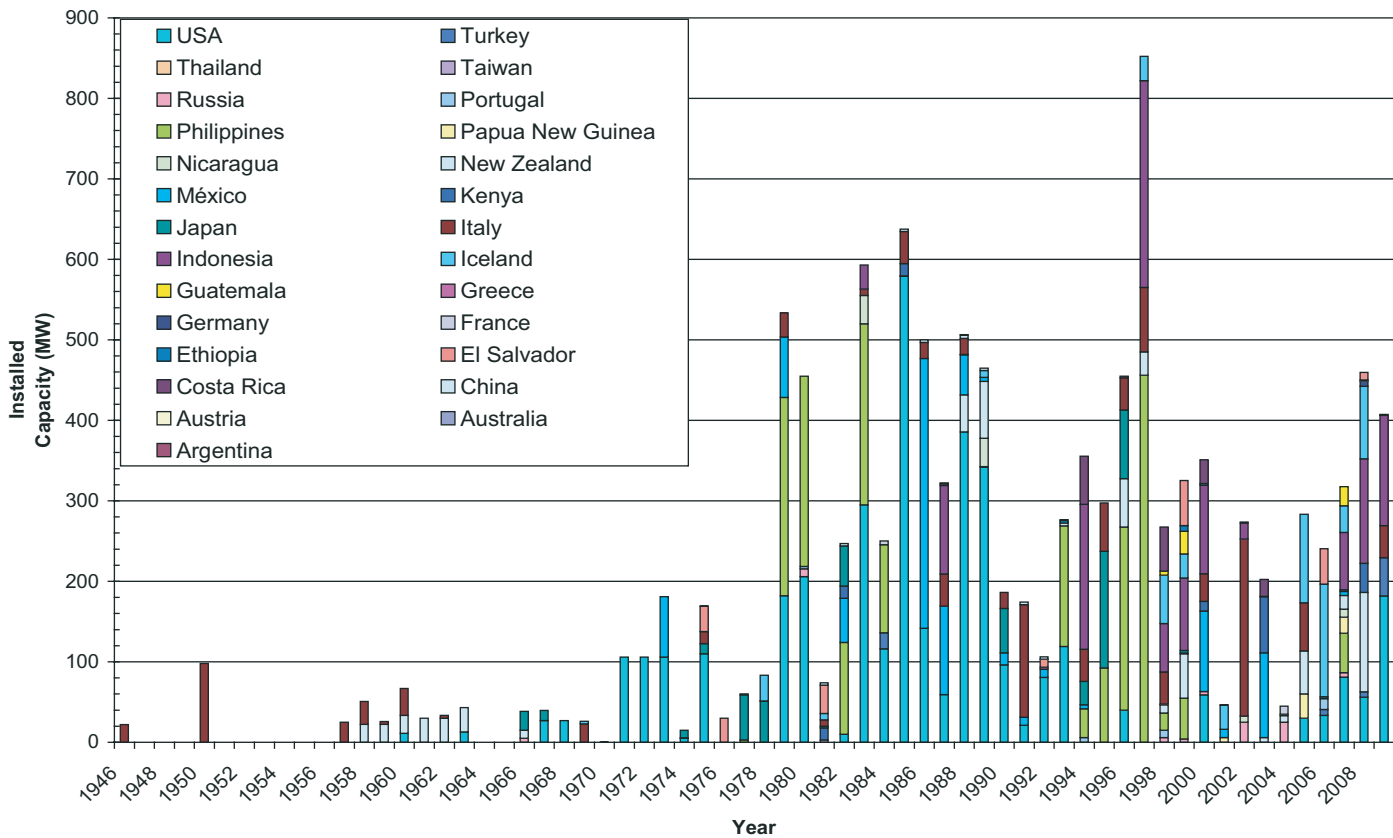

Figure 11.25 | Installed geothermal electricity capacity, 1946–2010, by country and in total. Source: data from Bertani, 2010.

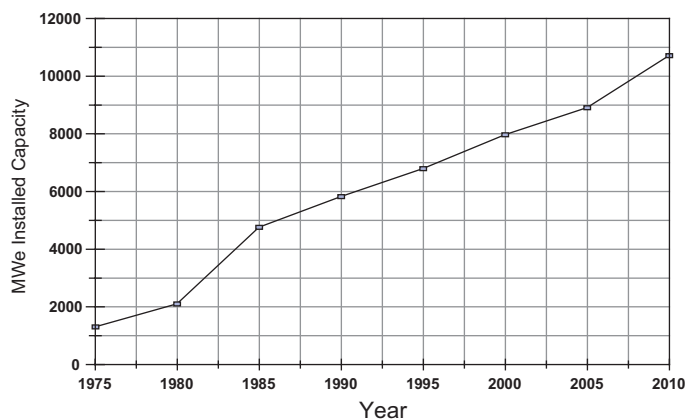

Figure 11.26 | Growth of the globally installed capacity of geothermal power production. Source: Bertani, 2010.

11.4.3.1 Geothermal Electricity Production

Use of high-temperature geothermal energy for electric power production started experimentally at Larderello, Italy, in 1904; the first commercial plant (250 kW_e) became available in 1913 and was connected to the electricity grid. In 1958, the Wairakei A station of 69 MWe came online in New Zealand. This was the first “wet steam” plant in the world. It was followed by plants using “dry steam” at Pathè, Mexico, in 1959 (3.5 MW_e); at The Geysers in the United States in 1960 (12 MW_e);

and at Matsukawa in Japan in 1966 (23 MW_e). The first low-temperature plant using a binary (organic Rankine) cycle plant was opened in 1967 at Paratunka, Kamchatka, in Siberia (680 kW_e).

Figure 11.25 shows the annual installed capacity in the 27 countries that had initiated geothermal power production by 2010, starting in 1946. The worldwide installed capacity since 1975 is presented in Figure 11.26. The average growth rate between 1975 and 2010 has been 6.5% per year. Since 2005, major increases have occurred in El Salvador, Iceland, Indonesia, New Zealand, Turkey, and the United States.

The top 10 countries in terms of installed capacity of geothermal power plants in 2009 were the United States, The Philippines, Indonesia, Mexico, Italy, New Zealand, Iceland, Japan, El Salvador, and Kenya or Costa Rica. (See Figure 11.27.) If the criterion were the percentage contribution of geothermal plants to the total generating capacity of the country or region, however, the top 10 would be Lihir Island (Papua New Guinea), Tibet, San Miguel Island (Azores), El Salvador, Tuscany (Italy), Iceland, Kenya, the Philippines, Nicaragua, and Guadeloupe (Caribbean).

11.4.3.2 Direct Use of Geothermal Energy

Since 1975 the installed capacity of geothermal direct use has increased at an average rate of about 10% annually (see Figure 11.28). In the

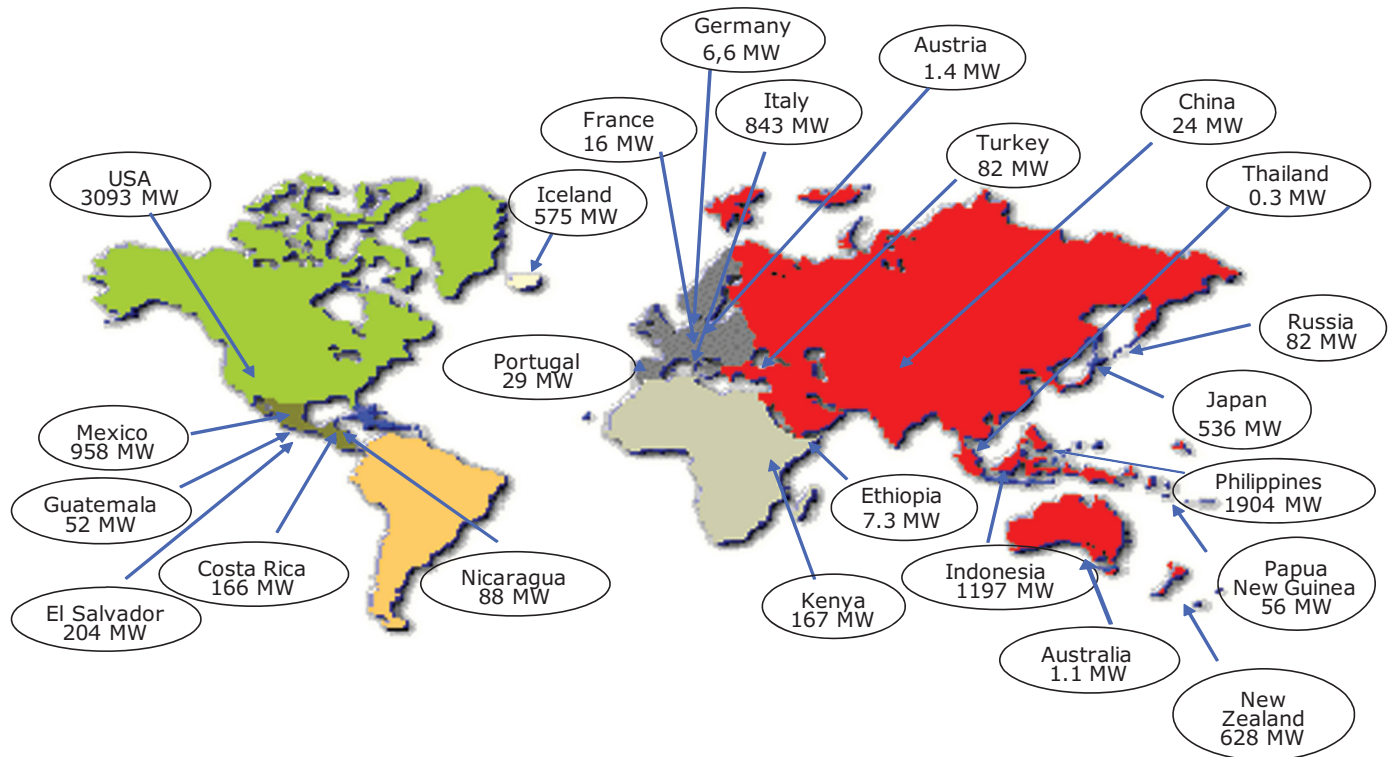

Figure 11.27 | Mapping of the 10.7 GW installed geothermal electric capacity in 2009. Source: data from Bertani, 2010.

period 2005–2009, heat production for direct use grew nearly 12% a year. Ground-source heat pumps (GHPs) alone have increased heat production about 20% per year in this period. This is due in part to the ability of geothermal heat pumps to use groundwater or ground-coupled temperatures anywhere in the world.

The annual savings achieved by geothermal energy use amounted to 36 million tons of fuel oil and 32 million tonnes of carbon emissions compared with power production from fuel oil (Lund et al., 2010).

In 2009, the top five countries with the largest installed direct-use capacity were the United States, China, Sweden, Norway, and Germany, accounting for about 63% of the total capacity worldwide. The five countries in 2009 with the largest direct use were China, the United States, Sweden, Turkey, and Japan, accounting for 55% of the world geothermal energy use.

Looking at the data in terms of the country’s land area or population, however, the smaller countries dominate. In terms of GJ/km², the top five countries in 2009 were the Netherlands, Switzerland, Iceland, Norway, and Sweden. In terms of GJ/capita, the ranking was Iceland, Norway, Sweden, Denmark, and Switzerland. In Iceland, geothermal energy saves about US\$100 million in imported oil (Lund et al., 2010).

The largest increases in direct use in terms of GJ/yr over the past five years were achieved in the United Kingdom, the Netherlands, South Korea, Norway, and Ireland, while the largest increases in installed

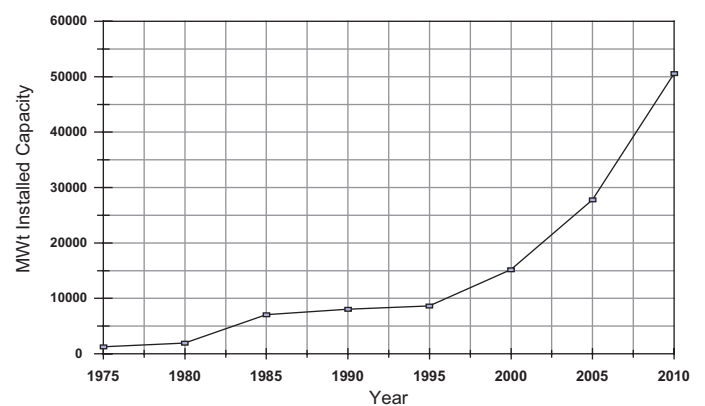

Figure 11.28 | Worldwide growth of installed capacity of geothermal direct use. Source: Lund et al., 2010.

capacity (MW_{th}) occurred in the United Kingdom, South Korea, Ireland, Spain, and the Netherlands, mainly due to an increased use of geothermal heat pumps.

In 1990 there were 14 countries reporting an installed capacity of over 100 MW_{th}. By 2000 this number had increased to 23, by 2005 it was 33, and by 2009 it reached 36. (See Box 11.2 for more details on some of these countries.)

Table 11.20 provides data on direct geothermal energy use in terms of installed capacity and thermal energy utilization for several recent years.

Box 11.2 | National Developments in Geothermal Direct Use as of 2009

- Iceland: Geothermal direct use meets 89% of the country's space heating needs.
- Japan: Over 2000 resorts, over 5000 public bath houses, and over 15,000 hotels visited by 15 million guests per year use natural hot springs.
- Tunisia: Geothermal heating of greenhouses has increased from 100 ha to 194 ha over the last five years.
- Turkey: Geothermal space heating has increased 40% in the five years, supplying 201,000 equivalent residences; 30% of the country will be heated with geothermal energy in the future.
- Switzerland: The country has installed 60,000 geothermal heat pumps; this is 1/km². Also, 2000 km of boreholes were drilled in 2009. Drain water from tunnels is used to heat nearby villages. Several geothermal projects have been developed to melt snow and ice on roads.
- United States: The country has installed 1 million geothermal heat pumps, mainly in the midwestern and eastern states, with about 12% annual growth. Around 100,000 to 120,000 units are installed per year.

Table 11.20 | Various geothermal direct-use categories worldwide, 1995–2009.

Direct-Use Category	Installed capacity [GW _{th}]				Thermal energy utilization [PJ/year]			
	1995	2000	2005	2009	1995	2000	2005	2009
Geothermal Heat Pumps	1.85	5.28	15.38	33.13	14.6	23.3	87.5	200.2
Space Heating	2.58	3.26	4.37	5.40	38.2	42.9	55.3	63.0
Greenhouse Heating	1.09	1.25	1.40	1.54	15.7	17.9	20.7	23.3
Aquaculture Pond Heating	1.10	0.61	0.62	0.65	13.5	11.7	11.0	11.5
Agricultural Drying	0.07	0.07	0.16	0.13	1.1	1.0	2.0	1.6
Industrial Uses	0.54	0.47	0.48	0.53	10.1	10.2	10.9	11.7
Bathing and Swimming	1.09	3.96	5.40	6.70	15.7	79.5	83.0	109.4
Cooling / Snow Melting	0.12	0.11	0.37	0.37	1.1	1.1	2.0	2.1
Others	0.24	0.14	0.09	0.04	2.2	3.0	1.0	1.0
Total	8.66	15.15	28.27	48.49	112.4	190.7	273.4	423.8

Source: Lund et al., 2010.

The most recent use of low-grade geothermal energy is in the form of ground-source heat pumps that use the natural temperature of the Earth (between 5° and 30°C) to produce both heating and cooling with a limited amount of electric energy input. The first commercial building installation using a groundwater heat pump took place in Portland, Oregon, in 1946. Europe began using the technology around 1970. In 2009 heat pumps were the largest portion of the installed direct-use capacity (70%) and contributed 49% to the direct use of geothermal energy. The actual number of installed GHP units is around three million. Units are found in 43 countries, although they are mainly in the United States, Canada, and Europe (Lund et al., 2010).

11.4.3.3 Development of Enhanced Geothermal Systems

While conventional geothermal resources cover a wide range of uses for power production and direct uses in profitable conditions, a large part of

the scientific and industrial community has been involved for more than 20 years in promoting enhanced geothermal systems (Ledru et al., 2007; Fridleifsson et al., 2008; Tester et al., 2006). The principle of EGS is simple: in the deep subsurface where temperatures are high enough for power generation (above 150°C), an extended fracture network is created or enlarged to act as new pathways. Water from the deep wells, or cold water from the surface, is circulated through this deep reservoir using injection and production wells and is then recovered as steam or hot water (Fridleifsson et al., 2008). These wells and further surface installations complete the circulation system. After using energy for power generation, the fluid can be cascaded for direct-use applications such as for district heating. EGS plants, once operational, can be expected to have great environmental benefits (such as zero CO₂ emissions).

The enhancement challenge is based on several conventional methods for exploring, developing, and exploiting geothermal resources that are not economically viable yet. The original idea calls for general

applicability, since the temperature increases with depth everywhere. But a number of basic problems still need to be solved; mainly, techniques need to be developed for creating, characterizing, and operating the deep fracture systems. Some environmental issues, like the chance of triggering seismicity and the availability of surface water, also need careful assessment and management (Bertani, 2009).

Targeted EGS demonstrations are under way in several places: Australia can claim a large-scale activity through a number of stock market-registered enterprises. A real boom can be observed: 19 companies are active in 140 leases (a total of 67,000 km² in four states), with an investment volume of US\$650 million. The project developers plan to establish the first power plants (with a few MWe of capacity) in the coming years (Beardsmore, 2007). The EU project EGS Pilot Plant in Soultz-sous-Forêts, France, started in 1987 and has installed a power plant of 1.5 MWe to use the enhanced fracture permeability at 200°C. In Landau, Germany, the first EGS-plant with a capacity of 2.5–2.9 MWe went into operation in fall 2007 (Baumgärtner et al., 2007). Another approach is being made for deep sediments in the in-situ geothermal laboratory in Groß Schönebeck, Germany, using two research wells (Huenges et al., 2007).

One of the main future demonstration goals in EGS will be to see whether and how power plant size could be upscaled to several tens of MWe. In the United States, the potential for EGS power generation is estimated at 1250 GW_e (based on a conservative 2% recovery factor). Assuming a capacity factor of 90%, this would correspond to 35.4 EJ/yr of electricity production (Tester et al., 2006).

11.4.3.4 New Developments: Drilling for Higher Temperatures

Production wells in high-temperature fields are commonly 1.5–2.5 km deep, and the production temperature is 250–340°C. The energy output from individual wells is highly variable, depending on the flow rate and the heat content of the fluid, but it is commonly in the range 5–10 MW_e and rarely over 15 MW_e per well.

It is well known from research on eroded high-temperature fields that much higher temperatures are found in the roots of the high-temperature systems. The International Iceland Deep Drilling Project is a long-term program to harness deep unconventional geothermal resources (Fridleifsson et al., 2007). Its aim is to produce electricity from natural supercritical hydrous fluids (at high temperature and pressure above the critical point where there is a phase change) from drillable depths. Producing supercritical fluids will require drilling wells that produce temperatures of 450–600°C. The current plan is to drill and test at least three 3.5–5 km deep boreholes in Iceland within the next few years. A deep well producing 0.67 m³/sec steam (~2400 m³/h) from a reservoir with a temperature significantly above 450°C could yield enough steam to generate 40–50 MW of electric power. This exceeds by an order of magnitude the power typically obtained from conventional geothermal wells (Fridleifsson et al. 2007).

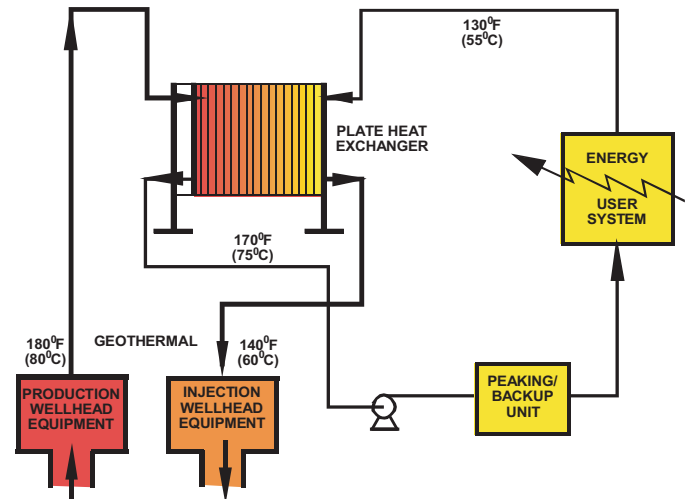

Figure 11.29 | Typical direct use geothermal heating system configuration. Source: based on Geo-Heat Center, 1998.

11.4.4 Geothermal Energy Technology Developments

11.4.4.1 Direct Use

The main advantage of using geothermal energy for direct use projects in the low- to intermediate-temperature range is that these resources are more widespread and exist in at least 80 countries at economic drilling depths. In addition, there are no conversion efficiency losses, and projects can use conventional water-well drilling and off-the-shelf heating and cooling equipment. Most projects can be online in less than a year. Projects can be on a small scale such as for an individual home, single greenhouse, or aquaculture pond, but they can also be a large-scale commercial operation such as for district heating/cooling, food and lumber drying, and mineral ore extraction.

It is often necessary to isolate the geothermal fluid from the user side to prevent corrosion and scaling. Care must be taken to prevent oxygen from entering the system (geothermal water normally is oxygen-free), and dissolved gases and minerals such as boron and arsenic must be removed or isolated, as they are harmful to plants and animals. Hydrogen sulfide, even in low concentrations, will cause problems with copper and solder and is harmful to humans. On the other hand, carbon dioxide, which often occurs in geothermal water, can be extracted and used for carbonated beverages or to enhance growth in greenhouses. The typical equipment for a direct-use system is illustrated in Figure 11.29; it includes downhole and circulation pumps, heat exchangers (normally the plate type), transmission and distribution lines (normally insulated pipes), heat extraction equipment, peaking or back-up plants (usually fossil-fueled), and fluid disposal systems (injection wells). Geothermal energy can usually meet 80–90% of the annual heating or cooling demand, yet it is only sized for 50% of the peak load (Lund, 2005).

A well-known major example of geothermal direct-use is the district heating system in Reykjavik, Iceland; in 1930, some official buildings

and about 70 private houses received hot water from geothermal wells close to old thermal springs. The results were so encouraging that other geothermal fields were explored near the city. Now 52 wells produce 2400 liters/s of water at a temperature of 62–132°C. Later the municipal district heating agency added a high-temperature field about 27 km away. Today the geothermal water from the wells flows through pipelines to six large reservoir tanks and then to six storage tanks in downtown Reykjavik that hold 24 million liters. Nine pumping stations distribute the water to consumers.

Reykjavik Energy uses either a single or a double distribution system. In the double system, the used geothermal water from radiators runs back from the consumer to the pumping stations. There it is mixed with hotter geothermal water, which serves to cool the water to the proper 80°C before it is recirculated. In the single system, the backflow drains directly into the sewer system (Gunnlaugsson and Gíslason, 2003). The system has over 2000 km of pipelines and an installed capacity of 830 MW_{th}. A fossil fuel peaking station is used to increase the fluid temperature in extremely cold weather (Lund, 2005; Ragnarsson, 2010).

11.4.4.2 Geothermal Heat Pumps

Geothermal (ground-source) heat pumps use the relatively constant temperature of Earth to provide heating, cooling, and domestic hot water for homes, schools, government, and commercial buildings. A small amount of electricity input is required to run a compressor (approximately 25% of a normal baseboard electric heating system). However, the energy output is about four times the energy input in electricity form, described as the coefficient of performance (COP) of 4.0. These “machines” cause heat to flow “uphill” from a lower to a higher temperature location. “Pump” is used to describe the work done. The temperature difference is called “lift.” The greater the lift, the greater the energy input required. The technology is not new, as Lord Kelvin developed the concept in 1852. GHPs gained commercial popularity in the 1960s and 1970s (Lund et al., 2003).

GHPs come in two basic configurations: ground-coupled (closed loop) systems, which are installed in the ground, and groundwater (open loop) systems, which are installed in wells and lakes. The type chosen depends on the soil and rock type at the installation, the land available, and whether a water well can be drilled economically or is already on-site. In the ground-coupled system, a closed loop of pipe, placed either horizontally (1–2 m deep) or vertically (50–70 m deep) is placed in the ground, and a water-antifreeze solution is circulated through the plastic pipes (high-density polyethylene) to either collect heat from the ground in the winter or reject heat to the ground in the summer (Rafferty, 2008). The open loop system uses groundwater or lake water directly in the heat exchanger and then discharges it into another well, into a stream or lake, or on the ground (say, for irrigation), depending on local laws.

The efficiency of GHP units is described by the coefficient of performance in the heating mode and by the energy efficiency ratio in the cooling

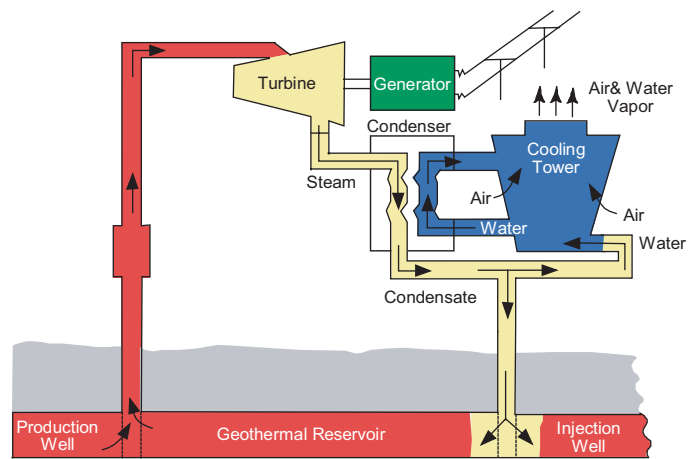

Figure 11.30 | Steam plant using a vapor or dry steam dominated geothermal resource. Source: modified from Lund, 2007.

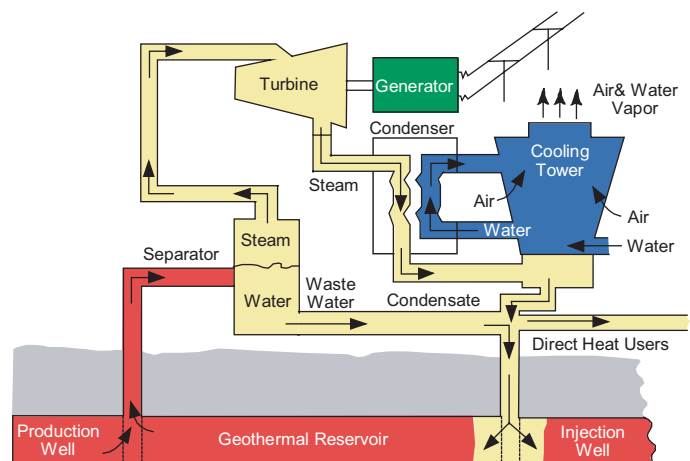

Figure 11.31 | Single-stage flash steam plant using a water-dominated geothermal resource with a separator to produce steam. Source: modified from Lund, 2007.

mode (COP_h and COP_c, respectively, in Europe), which is the ratio of the output thermal energy divided by the input energy (electricity for the compressor). The higher the number, the better the efficiency. The ratio varies from three to six with present equipment. In comparison, an air-source heat pump has a COP of around two and depends on backup electrical energy to meet peak heating and cooling requirements (Lund et al., 2003; Curtis et al., 2005; Bertani, 2010).

11.4.4.3 Electric Power Generation

Geothermal power is generated by using steam or a hydrocarbon vapor to turn a turbine-generator set to produce electricity. A vapor-dominated (dry steam) resource (see Figure 11.30) can be used directly, but a hot water resource (see Figure 11.31) needs to be flashed by reducing the pressure to produce steam, normally in the 15–20% range. Some plants use double and triple flash to improve efficiency (IEA, 2010a). In the

Table 11.21 | Average capacity and electricity produced per plant category and the share of each category.

Type of plant	Average capacity per unit (MW)	Average electricity production per unit (GWh/yr)	Share in number of plants	Share in total capacity (MWe)	Share in electricity produced (GWh)
Binary plant	5	27	44%	4%	4%
Back Pressure plant	6	50	5%	5%	6%
Single Flash plant	31	199	27%	25%	26%
Double Flash plant	34	236	12%	28%	30%
Dry Steam plant	46	260	12%	38%	34%

Source: Bertani, 2010.

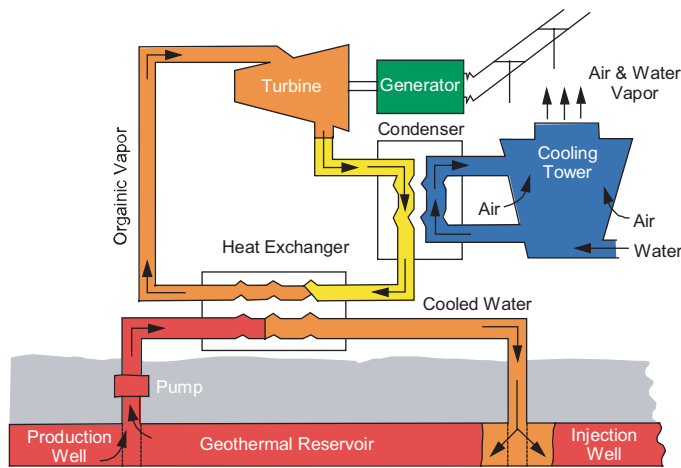

Figure 11.32 | Binary power or organic Rankine cycle plant using a low temperature geothermal resource and a secondary fluid of a low boiling-point hydrocarbon. Source: modified from Lund, 2007.

case of low-temperature resources, generally below 180°C, a secondary low boiling point fluid (typically a hydrocarbon) is needed to generate the vapor, resulting in a binary or organic Rankine cycle plant. (See Figure 11.32.)

Usually a wet or dry cooling tower is used to condense the vapor after it leaves the turbine to maximize the temperature and pressure drop between the incoming and outgoing vapor and thus increase the efficiency of the operation. Dry cooling is often used in arid areas where water resources are limited. Air cooling normally has lower efficiencies in summer months, when air temperatures are high and humidity is low.

The standard plant classifications are used here: *binary*, *back pressure*, *single flash*, *double flash*, and *dry steam* plant. Back pressure units (non-condensing) are used where condensing water is not available or based on economics to get the unit on line sooner. Table 11.21 indicates the share of each category in the total installed capacity, the electricity produced annually, and the total number of units. Average values per unit for installed capacity and annually produced electricity are also given. Hybrid plants using more than one form of energy are excluded from this overview, but their share is at present almost zero.

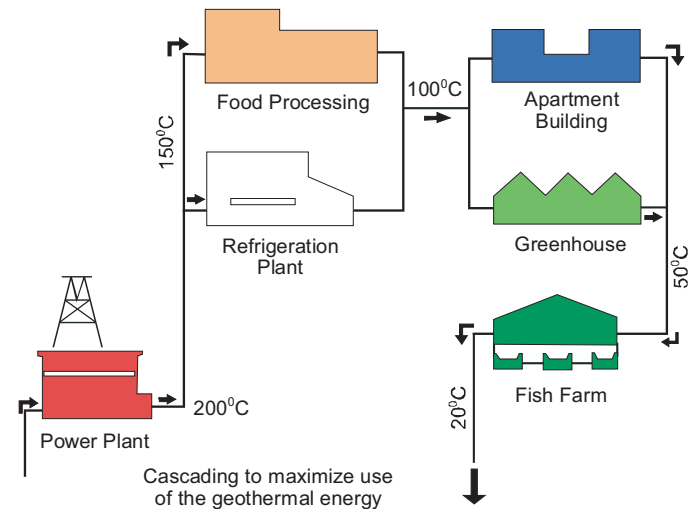

Figure 11.33 | Cascading the use of a geothermal resource for multiple applications. Source: Geo-Heat Center, 2003.

As indicated, there are three major families of plants: *small plants* (binary and back pressure plants) of about 5 MW per unit, *medium plants* (single and double flash plants) of around 30 MW per unit, and *big plants* (dry steam plants) of around 45 MW per unit or larger.

More recently, the use of combined heat and power plants has made low-temperature resources and deep drilling more economical. District heating using the spent water from a binary power plant can make a marginal project economical, as demonstrated at Neustadt-Glewe, Landau, and Bad Urach in Germany and at Bad Blumau in Austria. This was also found for high-temperature combined heat and power plants in Iceland (Geo-Heat Center, 2005). Options for cascading are shown in Figure 11.33, where the geothermal fluid is used for a number of applications at progressively lower temperatures to maximize energy use.

11.4.5 Economic and Financial Aspects

The economics of electricity production are influenced by drilling costs and resource development. The typical capital expenditure quota is 40% for reservoir and 60% for plant. The productivity of electricity per well is a

function of the thermodynamic characteristics of the reservoir fluid (phase and temperature). The higher the energy content of the reservoir fluid, the lower is the number of required wells; as a consequence, the reservoir typical capital expenditure quota is reduced. Single geothermal wells can produce from 1 to 5 MW_e, but sometimes even as high as 30 MW_e.

The cost of geothermal projects and the production of energy carriers vary considerably from site to site and from region to region, depending mainly on the depth, quality, quantity, and location of the resource. For any geothermal project, the costs can be divided into land acquisition or leasing; resource exploration and characterization; drilling and reservoir development; gathering and transmission pipelines; plant design and construction; energy or product transmission to consumers; operation and maintenance; the cost of financing, debt, and royalty payments; and costs related to permitting, legal, and institutional issues.

In this section, the levelized cost of energy is calculated for a number of applications, assuming a discount rate of 5–10%.

11.4.5.1 Electric Power Projects

Taking into account cost increases during 2006–2008, a new 50 MWe greenfield project costs in the range of US\$2000–4000 per installed kW_e (see, e.g., Geothermal Task Force Report, 2006; Bromley et al., 2010). Thus, a 50 MWe plant is estimated to cost on average US\$150 million. Of this, drilling would average US\$1500/kW_e or about US\$2200/m for a 3 MW, 2000m deep well. Average well cost are estimated to vary from US\$2–5 million, though it can approach US\$9 million (Kagel, 2006).

A typical cost breakdown for a geothermal power project in the United States is as follows: exploration 5%, confirmation 5%, permitting 1%, drilling 23%, stream gathering 7%, power plant 54%, and transmission 4% (Hance, 2005). O&M costs can be estimated at 1.8–2.6US¢/kWh with an average of 2.2US¢/kWh in the United States (Owens, 2002; Hance 2005), but at 1.0–1.4US¢/kWh in New Zealand (Barnett and Quinlivan, 2009). The calculations here use an average value ranging from US₂₀₀₅¢1.5–2.2/kWh.

At present, the capacity factor of geothermal power plants is worldwide on average 71–72% (Bertani, 2010). But new plants can achieve more than 90%. A value ranging from 70% to 90% is used here. The economic lifetime of the system is assumed to be 30 years. Based on these figures, an LCOE ranging from about US₂₀₀₅¢3–9/kWh is found. (See Table 11.22)

In the United States, a federal production tax credit of US₂₀₀₅¢1.8–2.1/kWh would just about offset the average O&M cost, increasing revenues and shortening the payback period. FITs, such as those provided in Germany, would also increase the income from the plant.

Smaller plants, around 5 MWe, are estimated to cost 20% more per installed kW_e, while binary plants of the 5 MWe size cost approximately

Table 11.22 | Cost of electricity as a function of capacity factor, turnkey investment costs, discount rate, and O&M costs. The O&M costs are assumed at ¢1.5–2.2/kWh. The assumed lifetime is 30 years.

Capacity factor	Turnkey investment costs/kWe	Discount rate	
		5%	10%
	US\$	US ₂₀₀₅ ¢/kWh	
90%	2000	3.1–3.8	4.2–4.9
	4000	4.8–5.5	6.9–7.6
70%	2000	3.6–4.3	5.0–5.7
	4000	5.7–6.4	8.3–9.0

30% more. Larger plants in the 100 MWe range can cost 10% less per installed kW_e (Al-Dabbas, 2009). Water cooling versus air cooling is estimated to cost 15% more.

11.4.5.2 Direct-use Projects

Direct-use project costs have a wide range, depending on the specific use, the temperature and flow rate required, the associated O&M and labor costs, and the income from the product produced. In addition, new construction usually costs less than retrofitting older structures. Here, estimates are made for the following: individual space heat for a residence, a greenhouse project, district heating, and an industrial application. Well drilling and casing costs would vary from US\$150–300/m for depths up to 500 m. Drilling cost will increase with depth and can approach US\$500/m, but the cost can be highly non-linear with depth (Chad et al., 2006). These values are based on projects in the United States, and they can vary for other locations, depending on resource temperature and flow, labor and materials costs, and rig availability.

Individual space heating for a building of 200 square meters may have a load of 43MJ_{th}/h, requiring a generating capacity of 12 kW_{th}. Depending on the well depth and temperature of the resource, the system could cost US\$10,000–25,000 in addition to the cost of land. This could result in total investment costs of about US\$1600–4200/kW_{th}. The capacity factor is about 30%. Assuming an economic lifetime of 30 years and O&M costs of US¢2/kWh_{th}, the LCOE ranges between US¢6–19/kWh_{th}.

Greenhouses are covered facilities costing approximately US\$150/m². Thus, a commercial facility of 2.0 ha outdoors would cost US\$3 million. The peak heating requirement is about 1.0 MJ/m². Thus an installed capacity of 5.6 MW_{th} is needed. The geothermal system may cost US\$500–1000 per installed kW_{th}. With a capacity factor of 50%, this set-up would result in a geothermal heat use of 24.3 million kWh/yr. Pumping costs and other O&M for the geothermal system may be approximately US¢2/kWh. The economic lifetime is assumed to be 20 years. The LCOE ranges between US¢3–5/kWh_{th}.

District heating may be defined as the heating of two or more structures from a central heat source. Heat may be provided in the form of either steam or hot water and may be used to meet process, space, or domestic hot water requirements. The heat is distributed through a network of insulated pipes consisting of delivery and return mains. Thermal load density (heating load per unit of land area) is critical to the feasibility of district heating, as the distribution network may be the largest single capital expense, at approximately 35–75% of the entire project cost. Thus, high-rise buildings downtown are better candidates than single family residential areas. Generally, a thermal load density above 1.2 GJ/hr/ha or a favorability ratio of 2.5 GJ/ha/yr is recommended for district heating projects. Often fossil fuel peaking is used to meet the coldest period, rather than drilling additional wells or pumping more fluid, improving the efficiency and economics of the total system (Bloomquist et al., 1987). Biomass could also be used effectively for peaking.

One example cost for a district heating projects is found in Germany (Reif, 2008), where two geothermal wells are drilled to 3200m to provide a capacity of 35 MW_{th}, and 66 GWh_{th} a year of heat to customers (load factor of 0.22). The total cost of the project, including a fossil fuel peak heating load plant, was US\$58.5 million broken down into the following components: 22.6% drilling, 1.7% pumps and accessories, 4.6% geothermal station and equipment, 1.7% peak-load heating plant, 42.4% distribution network, 14.4% service connections, 11.7% heat-transfer stations, and 0.9% land.

A smaller example is found in Elko, Nevada, in the United States (Bloomquist, 2004). The Elko Heat Company system was built in 1989 for US\$1.4 million, which at today's costs would be approximately US\$5 million; 15% was for resource assessment, 15% for drilling the production well (disposal is to a local river), 29% for the distribution system, 26% for retrofitting customer heating systems, and the remaining 15% for contract services and materials. The estimated capacity of the system is 3.8 MW_{th} and the energy provided to customers is 6.5 GWh_{th} a year. So the capacity factor is nearly 20%. In 2001, the annual operating revenue was US\$184,270. The operating expenses were US\$47,840, the maintenance US\$19,105, and contract services and materials cost US\$22,135. Translated to 2005 prices, this suggests O&M costs of US¢1.5/kWh_{th}.

From these two examples, investment costs ranging from US\$1300–1700/kW_{th} can be derived. However, lower figures are also possible, down to US\$600/kW_{th} (Lund et al., 2009). Assuming an economic lifetime of 30 years, an LCOE ranging from US₂₀₀₅¢4–12/kWh_{th} can be calculated.

Industrial applications are more difficult to quantify, as they vary widely depending on the energy requirements and product produced (Goldstein et al., 2011). These plants normally require higher temperatures and often compete with power plant use. However, they do have a high load factor of 0.40–0.70, which improves the economics.

One recent study looked at an onion drying facility in Oregon (Geo-Heat Center, 2006). A single-line dryer handling 4500 kg/h of fresh onions

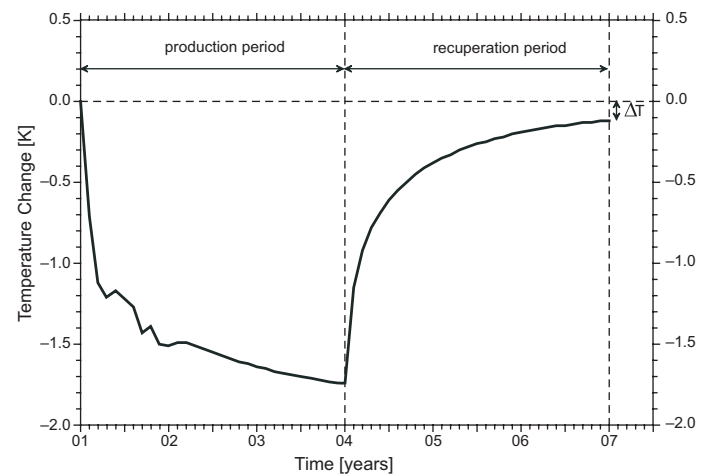

Figure 11.34 | Calculated ground temperature change at a depth of 50 m and at a distance of 1 m from a 105 m long borehole heat exchanger over a production period and a recuperation period of 30 years each. Source: Eugster and Rybach, 2000.

for 24 hr/day over a season of 250 days (0.68 load factor) produces 900 kg/h of dried product. About 35 GJ/h (about 10 MW_{th}) of direct use is required and 210 TJ would be the annual energy use, requiring a resource of at least 120°C at 57 liters per sec flow. The total cost for this facility would be US\$13.3 million. The geothermal system including the wells may add US\$3.6 million (US\$360/kW_{th}). Assuming an economic lifetime of 20 years and US¢2/kWh_{th} O&M costs, the LCOE would be US¢2.5–2.7/kWh_{th}. As in practice higher investment costs are also found (up to US\$1000/kW_{th}), an LCOE ranging from about US₂₀₀₅¢2–4/kWh_{th} is calculated.

11.4.6 Sustainability Issues

Geothermal energy is generally classified as a renewable resource, where “renewable” describes a characteristic of the resource: the energy removed from the resource is continuously replaced by more energy on time scales similar to those required for energy removal (Stefansson, 2000). Consequently, geothermal energy use is not a “mining” process. Whether the exploitation of a geothermal source can be classified as “sustainable” depends on issues like the durability of energy supplies and environmental concerns.

11.4.6.1 Durability of Geothermal Energy Supplies

It appears natural to define the term “sustainable production” as production that can be maintained for a very long time. In Iceland, a reference period for a production well of 100–300 years has been proposed (Axelsson et al., 2005), while in New Zealand, production for more than 100 years is used as a criterion (Bromley et al., 2006). Much longer time scales, such as those comparable to the lifetimes of geothermal resources, are considered unrealistic in view of human endeavors. As geothermal heat is coming from the internal part of Earth and is related to natural

decay processes of radioactive isotopes, the flow of energy to Earth's surface of 1400–1500 EJ a year will continue for many million years.

The production of geothermal fluid/heat continuously creates a hydraulic/heat sink in the reservoir. This leads to pressure and temperature gradients, which in turn – after termination of production – generate fluid/heat inflow to re-establish the pre-production state. The regeneration of geothermal resources occurs over various time scales, depending on the type and size of the production system, the rate of extraction, and the attributes of the resource. Time scales for re-establishing the pre-production state following the cessation of production have been determined using numerical model simulations (for details, see Rybach and Mongillo, 2006; Axelsson et al., 2005). The results show that after production stops, recovery driven by natural forces like pressure and temperature gradients begins. This can be illustrated by the production and recuperation periods presented in Figure 11.34. The recovery typically shows an asymptotic behavior and theoretically takes an infinite amount of time to reach its original state. However, practical replenishment (for instance, 95%) will occur much earlier, generally on time scales of the same order as the lifetime of the geothermal production systems (Axelsson et al., 2002).

Examples of long-term production and use from high-temperature geothermal fields include Larderello in Italy for over 100 years (see, e.g., Cappetti, 2009) and The Geysers in northern California for almost 50 years – both of which generate electrical energy. In recent years, however, both fields have experienced reduced production – mainly due to not injecting all the spent fluid from the plants. Another example of what appears to be a sustainable use of a low-temperature geothermal field is the Reykir field (Mosfellssveit), which has been used for district heating of Reykjavik (Iceland) since 1943 (Gunnlaugsson and Gislason, 2003).

11.4.6.2 Environmental Aspects

Geothermal fluids contain a variable quantity of gas (largely nitrogen) and carbon dioxide, plus some hydrogen sulfide and smaller proportions of ammonia, mercury, radon, and boron. The amounts depend on the geological conditions of different fields. Most of the chemicals are concentrated in the disposal water that is routinely reinjected into drill holes and thus not released into the environment. The concentration of the gases is usually not harmful, and they can be vented to the atmosphere. However, the technology for removing harmful non-condensable gases does exist, and these systems are installed at most geothermal power plants. Removing the hydrogen sulfide released from geothermal power plants is a requirement in, for example, the United States and Italy.

CO₂ emission from electricity production using high-temperature geothermal fields in the world is variable, but it is much lower than that for fossil fuel plants. Bertani and Thain (2002) reported on CO₂ emission data obtained in 2001 from 85 geothermal power plants operating

in 11 countries. These plants had an operating capacity of about 6650 MWe, which constituted 85% of the world geothermal power plant capacity at the time. The collected data showed a wide spread – from 4 g/kWh to 740 g/kWh – with the weighted average being 122 g/kWh. This compares well with the US value reported by Bloomfield et al. (2003) of 91 g CO₂/kWh. A recent comprehensive literature review by IPCC of life cycle assessments for geothermal power plants, however, concluded that “lifecycle GHG emissions are less than 50 gCO₂-eq/kWh for flash steam plants and less than 80 gCO₂-eq/kWh for projected EGS plants” (Goldstein et al., 2011).

Where there is a high natural release of CO₂ from the geothermal fields prior to development, geothermal power development may also decrease this natural emission, as happened, for example, at the Larderello field in Italy. The GHG emissions from low-temperature geothermal resources are normally only a fraction of those from the high-temperature fields used for electricity production. The gas content of low-temperature water is in many cases minute, as in Reykjavik, where the CO₂ content is lower than that of the cold groundwater. In sedimentary basins, such as the Paris basin, the gas content may cause scaling if it is released. In such cases the geothermal fluid is kept under pressure within a closed circuit (the geothermal doublet) and reinjected into the reservoir without any de-gassing taking place.

No systematic collection has been made of data about GHG emissions from geothermal district heating systems. The CO₂ emissions from low-temperature geothermal water can be less than 1 gCO₂/kWh_{th} depending on the carbonate content of the water. As an example, for Reykjavik District Heating the emissions from low-temperature areas are about 0.00005 gCO₂/kWh_{th}. Data from geothermal district heating systems in China (Beijing, Tianjin, and Xianyang) are limited but also indicate emissions of less than 1 gCO₂/kWh_{th} (Gunnlaugsson, 2007). The district heating system in Klamath Falls, Oregon, has about zero emissions, as all the geothermal water is used and reinjected in a closed system. Life-cycle analyses, taking into account indirect emissions, show GHG emissions ranging from 14–58 gCO₂-eq/kWh_{th} (Kaltschmidt, 2000).

The GHG emission rates of geothermal heat pumps depend on the energy efficiency of the equipment as well as the fuel mix and the efficiency of electricity generation. In most cases, heat pumps are driven by auxiliary electric power, so the CO₂ emissions depend on the energy source for electricity generation. The average CO₂ emission associated with generation of electricity in Europe in 2005 has been estimated to be about 0.55 kgCO₂/kWh. With proper system design, the electrically driven geothermal heat pump reduces the CO₂ emissions of an oil-fired boiler by 45% and those of a natural-gas-fired boiler by 33% (ISEO, 2010). Based on life-cycle analysis, Kaltschmitt (2000) found emission rates for GHPs ranging from 180–200 gCO₂-eq/kWh_{th}. If the electricity that drives the heat pump is produced from a renewable energy source, the emission rate will be much smaller. The total CO₂ emission reduction potential of heat pumps has been estimated to be 1.2 Gt/yr, or about 6% of global emissions (ISEO, 2010).

There are also local environmental impacts related to land and water use and the operation of an energy system. In addition, there could be some specific phenomena such as discharges of gas other than CO₂. But these can be reduced strongly where gas injection is used and nearly eliminated when binary geothermal plants are installed for power generation. Since most direct-use projects use only hot water and the spent fluid injected, the polluting emissions are nearly eliminated.

The exploration of geothermal resources can also have impacts on outstanding natural features and landscapes. And geothermal systems using wells may have an impact on seismicity and ground vibrations and contribute to risks such as hydrothermal steam eruptions. Proper design and management as well as monitoring and control are needed to avoid or mitigate these risks. Recent exploratory work on EGS has produced small earthquakes (up to 3.4 on the Richter scale) that have caused local concerns. The mitigation of these earthquakes is currently under investigation.

11.4.7 Implementation Issues

The technology to produce electricity and generate heat for direct use is mature and can be applied cost effectively depending on local circumstances. New technology developments may enhance access to geothermal energy use. Getting access to geothermal energy fields may also require the construction of transmission capacity, adding to the total costs of energy supply. Other implementation issues could include siting and permitting delays, high capital costs, the concerns of local populations, and public perceptions and support, including lack of knowledge about benefits.

Geothermal power plants are operated in base load. Geothermal energy may fit well with the use of other renewable resources such as wind, solar, biomass, and hydro, offering the potential of a reliable and secured supply of heat and electricity. Given the barriers and constraints, enhanced deployment of geothermal energy use requires government policies, regulations, and initiatives, including incentives such as a FIT for geothermal pricing, as demonstrated by a number of countries (see, e.g., Rybach, 2010; REN21, 2010). Enhanced deployment also requires education, including training and outreach, along with improvements of the technology.

11.5 Wind Energy

11.5.1 Introduction

Wind energy has been used for thousands of years in a variety of applications, but it was largely overshadowed by other fuels for much of this time for a variety of technical, social, and economic reasons. The oil crises of the 1970s, however, renewed interest in wind energy technology for grid-connected electricity production, water pumping, and power supply in remote areas (WEC, 1994; UNDP et al., 2000). This section

focuses on utility-scale, grid-connected wind technology deployed either on land or offshore.

Wind power capacity grew to meet nearly 2% of global electricity demand in 2009. Onshore wind is currently one of the most economical renewable energy generation technologies. In areas with good wind resources, generating electricity with wind turbines is already competitive. As a result, these installations have grown rapidly. Offshore wind projects are almost twice as capital-intensive as their land-based counterparts, but in Europe and Asia some countries have set aggressive goals for their deployment. The experience gained through this is expected to reduce costs and improve performance.

11.5.2 Potential of Wind Energy

Wind energy is broadly available but diffuse. There is a vast global wind resource that could be tapped (see Chapter 7) and provide carbon-free electricity. Figure 11.35 illustrates the global land-based wind resource at 50-m above ground level.

The *technical potential* of wind energy to fulfill energy needs is very large. Estimates range from about 20,000 TWh/yr (onshore only) to 125,000 TWh/yr (onshore and near-shore). The range suggests that wind could supply in principle anywhere from one to six times the 2009 global electricity production of about 20,000 TWh (IEA 2010b; BP, 2011). Although wind resource quality varies around the globe, there is sufficient potential in most regions to support high levels of wind energy generation. Wind resources are not a global barrier to expansion of the use of this technology in the coming decades.

It has been noted that local and global climate change could affect wind resources (IPCC, 2007b), although research in this area is nascent (Wiser et al., 2011). Climate change could have impacts on wind patterns locally, but it is unlikely to be a large enough magnitude to change the global technical potential of wind energy greatly (IPCC 2011).

The *economic potential* of harnessing wind energy is defined by capital investment, corresponding annual power production, competitiveness with other energy technologies, and policy measures. The *realizable (or implementation) potential* also depends on aspects such as access of a particular site to electricity markets through transmission lines; rules favorable to variable generation technologies; sufficient mitigation of visual, acoustic, and wildlife impacts; public acceptance; and maintenance costs. For a given site, the economic potential depends on the annual power production from wind technology, requiring knowledge of, for example, average wind speeds at heights above ground corresponding to wind turbine hubs, the statistical distribution of wind speeds throughout the year, turbulence intensity, and the impact of terrain features near the plant. Continued development of calculation models and increased availability of observational wind speed data are critical to optimizing the annual power production of

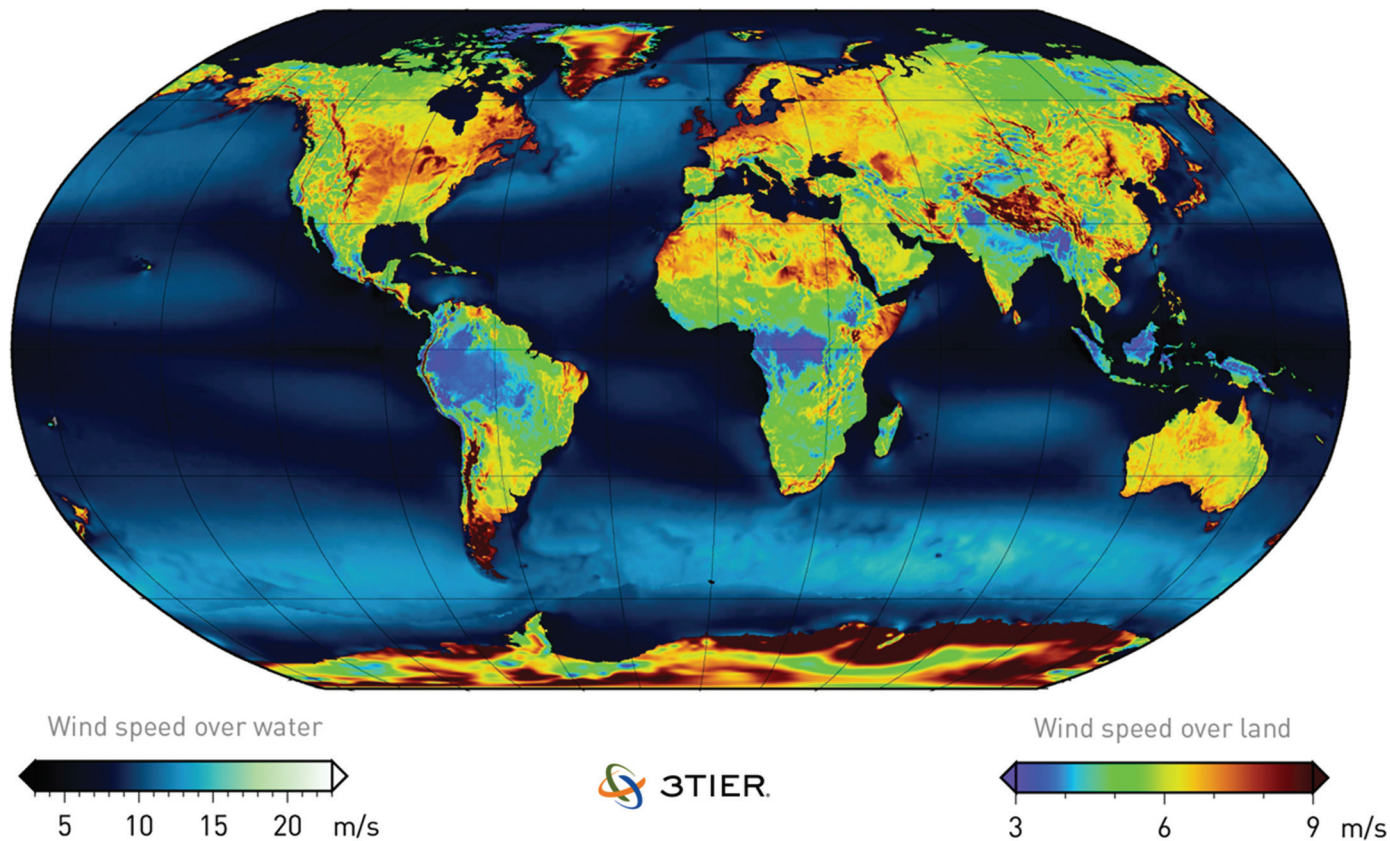

Figure 11.35 | Global wind resource. The red color represents the strongest wind and the blue color denotes the weakest wind resource. Source: 3 Tier, 2011. (c) 2011 3TIER, Inc.

wind turbines and assessing the economic potential of wind resources (IEA, 2010a).

Numerous studies and approaches have been used to develop scenarios for economic deployment of wind energy. The Global Wind Energy Council (GWEC) uses a simulation model to create scenarios for wind technology through 2050 based on different levels of political support (GWEC and Greenpeace, 2010a). GWEC poses three scenarios: Reference, Moderate, and Advanced. The Reference scenario is based on the IEA's *World Energy Outlook 2009*. The Moderate scenario accounts for all policy measures to support renewable energy either enacted or in planning stages. The Advanced scenario represents the extent to which the wind industry could grow in a base case "wind energy vision."

A second estimate, developed by the IEA in *Energy Technology Perspectives 2010* (ETP), uses an optimization model to create global energy scenarios based on different levels of commitment to carbon emission reduction (IEA, 2010a). It poses two scenarios, Baseline and BLUE Map. The Baseline scenario is based on the *World Energy Outlook 2009* extrapolated to 2050 and assumes that no new policies are intro-

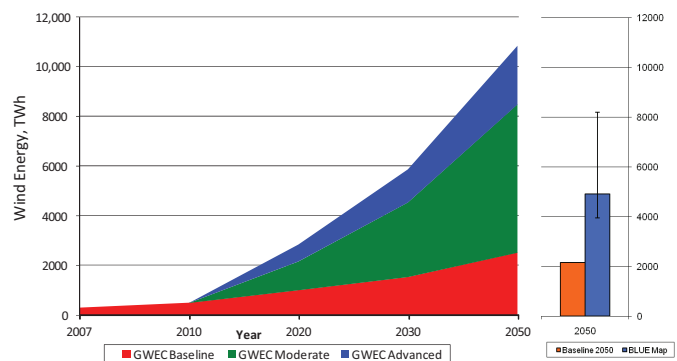

Figure 11.36 | Wind energy generation estimates from two studies (left panel: GWEC and Greenpeace, 2010a; right panel: IEA, 2010a).

duced. The BLUE Map scenario represents a reduction of CO₂ emissions to 50% below 2005 levels by 2050.

Figure 11.36 shows the estimated wind energy generation in 2050 for these two studies. The GWEC scenario projections include both onshore and offshore wind but do not estimate the proportion from each. The

error bar on the Blue Map scenario (4900 TWh/yr in 2050) represents the variation in wind energy generation estimates based on sensitivity runs.

These two studies suggest significant generation potential for wind technology, up to 10,000 TWh annually in the GWEC Advanced scenario. Wind generation as a percentage of total global electricity demand varies from 10% to 26% for the non-reference / non-baseline scenarios, depending on assumptions that influence projections of total electricity demand and the role of competing low-carbon generation technologies. These studies use different approaches to reach internally consistent scenarios. The GWEC simulation model focuses on wind industry growth potential based on historical expansion levels and considering growth rates, turbine rating and capacity factor, capital costs, and progress ratios. The IEA-ETP simulation model assesses wind technology contribution to projected electricity sector expansion relative to other generation technologies under various policy influences.

A third approach by Hoogwijk et al. (2004) explores the economic potential of onshore and offshore wind generation based on geographic location, exclusion areas for environmental and competing uses, wind speed estimates, wind technology generation estimates, and costs. This study finds that wind technology could generate an amount roughly equal to 2001 world electricity consumption, 16,000 TWh, at a cost of up to US₂₀₀₄¢7/kWh.

Although all these studies use very different approaches, they demonstrate that economically feasible wind energy generation potential is significant. The cost of wind generation relative to other generation technologies becomes the ultimate driver.

11.5.3 Market Developments

The wind industry has enjoyed sustained global growth since 1990. Almost 160 GW of wind generation capacity were installed through 2009, generating nearly 350 TWh electricity annually. At the end of 2010, almost 200 GW was operating worldwide. In the period 2004–2009, cumulative installed capacity grew at an annual average rate of approximately 27%.

Europe is the global leader in terms of installed wind capacity (76 MW in 2009) but cumulative installations in Asian and American markets grew rapidly between 2008 and 2009 at 68% and 39% respectively. (See Figure 11.37.)

European countries such as Denmark, Germany, and Spain led growth in the late 1990s. The United States and China became the fastest-growing markets from 2005 to 2010. India has moved into the top 10 wind markets. By the end of 2010, the highest installed wind capacity was found in China (45 GW), followed by the United States (40 GW), Germany (27 MW), Spain (20 GW), and India (13 GW) (GWEC, 2011).

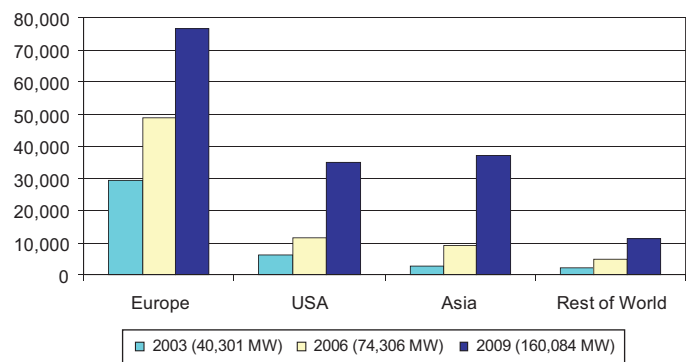

Figure 11.37 | Cumulative installed capacity in Europe, United States, Asia, and the rest of the world, 2009. Source: BTM Consult, 2010; AWEA project database for US capacity.

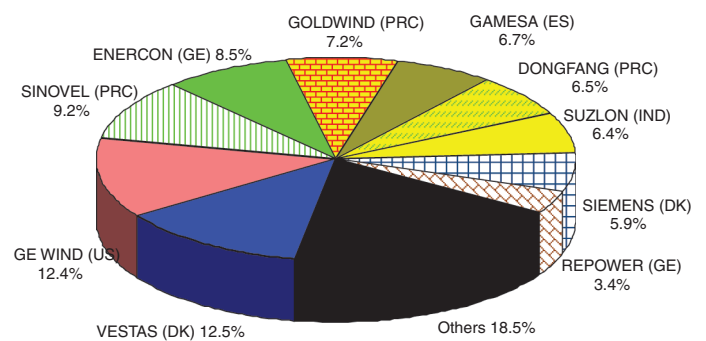

Figure 11.38 | Top 10 wind turbine suppliers, 2009. Source: based on BTM Consult, 2010.

The wind industry remains highly concentrated: just six countries are home to the top 10 wind turbine suppliers in 2009 (see Figure 11.38) – all from Europe, North America, or Asia.

While the industry was previously dominated by small independent project developers, electric utilities and large independent power producers are increasingly investing in wind projects. This is leading to increasing globalization and competitiveness in the wind turbine supply chain (BTM Consult, 2010). In 2009, investments in wind power installations totaled nearly US₂₀₀₉\$52 billion; direct employment in the wind energy sector has been roughly estimated at 600,000 jobs (GWEC and Greenpeace, 2010a).

In Europe and the United States, wind has become a major source of capacity additions to the electric sector. Between 2000 and 2009, wind capacity additions were second only to natural gas and were ahead of coal. In 2009, 39% of all capacity additions in both the United States and the European Union came from wind power. (See Figure 11.39.)

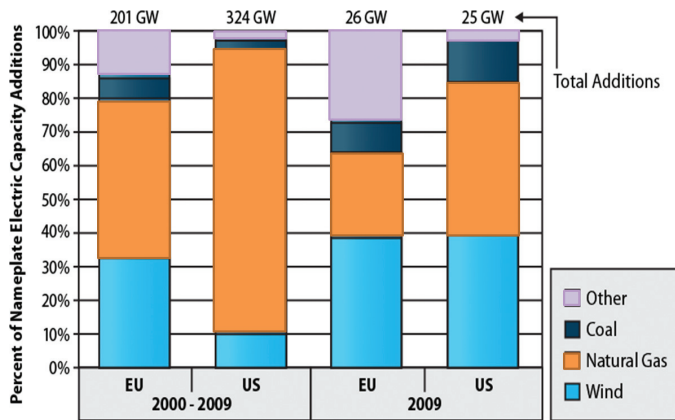

Figure 11.39 | Relative contribution of generation types to capacity additions in the United States and the European Union, 2000–2009 and 2009. Source: Wisner and Bolinger, 2010; EWEA, 2010.

By the end of 2009, the wind industry had developed 38 offshore projects in nine European countries, bringing total capacity to above 2000 MW. Annual installations grew to 577 MW in 2009, up 54% from 2008 (EWEA, 2010). The European Wind Energy Association (EWEA) estimates that the 2056 MW of capacity installed at year-end 2009 will generate more than 7 TWh of electricity annually. The development of offshore wind projects has so far been concentrated in Europe, but 2010 saw the first Chinese project commissioned and the final permitting of the Cape Wind project in the United States (Musial and Ram, 2010).

11.5.3.1 Role of Wind Turbine Standards

The development of a suite of international standards for wind turbines has been a major contributor to the evolving market for wind turbine technology over the past 15 years. The International Electrotechnical Commission (IEC) is a global organization that prepares and publishes international standards for electrical, electronic, and related technologies (IEC, 2010). These standards serve as the basis for national standards and as a reference when drafting international tenders and contracts. The standards cover wind turbine systems and subsystems, such as mechanical and internal electrical systems, support structures, and control and protection systems.

11.5.3.2 The Near-term Market Future

Near-term forecasts indicate continued rapid growth of the global wind industry from the current level of 160 GW. The Global Wind Energy Council forecasts a cumulative installed capacity (onshore and offshore) of 409 GW by 2015, meeting about 4% of global electricity demand (up from 2% in 2009) (GWEC and Greenpeace, 2010b). This equates to an investment of more than US₂₀₀₅\$225 billion. BTM Consult reaches a similar but slightly more aggressive forecast for the period, predicting that wind will achieve 447 GW by 2014 (BTM Consult, 2010).

Prospects for growth in the offshore wind market are considerable. EWEA (2010) foresees European offshore wind installations growing to 150 GW by 2030, depending on the policies implemented. The US DOE and the US Department of the Interior have adopted a strategy to realize 54 GW of offshore wind in the United States by 2030 (US DOE, 2011a). In Europe at the end of 2009, some 3500 MW of offshore wind was under construction, 16,000 MW had received final permits, and 100,000 MW had been proposed (EWEA, 2010).

11.5.3.3 Small Wind Turbines

There is also a market for small-scale wind turbines with capacities in the hundreds of watts up to 100 kW range. In rural areas they are used for battery charging and in stand-alone hybrid electricity systems. It has been estimated that annual global installations of small wind turbines may approach 40 MW (AWEA, 2009). In addition, probably more than 1 million water-pumping wind turbines (wind pumps) manufactured in developing countries supply water to livestock (UNDP et al., 2000).

11.5.4 Wind Energy Technology Development

11.5.4.1 Onshore Wind Turbine Technology: Current Status

Commercial-scale wind turbines have largely coalesced around a horizontal-axis design with three pitch-regulated blades that capture the wind resource upwind of the tower and have a diameter of 60–120m. The rotor and blades are attached to a hub and main shaft through which mechanical energy is transferred to a gearbox (depending on the design) and finally to a variable speed generator, where the energy is converted to electricity. These components are contained in a housing made of fiberglass, called a nacelle, which protects components from the elements. The nacelle is mounted on a 50–120m tower to allow the rotor to capture higher-quality wind resources than found near the ground.

Wind turbines are typically grouped together into wind power plants (wind projects, wind farms) for the commercial production of electricity (as opposed to community or residential electricity production). The electricity generated is aggregated at an on-site substation and then exported to the utility system grid. Modern onshore wind projects typically range in size from 25 to 400 MW, though the largest plant currently operating has more than 800 MW of capacity.

During the past 25 years, average wind turbine ratings have grown almost linearly since the introduction of 50 kW turbines in the early 1980s. Current commercial machines are rated at 1.5–3 MW for land-based turbines, offshore turbines as large as 5 MW are being deployed, and larger machines are on the drawing boards of several manufacturers. Wind turbine designers in the last two decades have continually predicted that the current generation of turbines had grown as large as

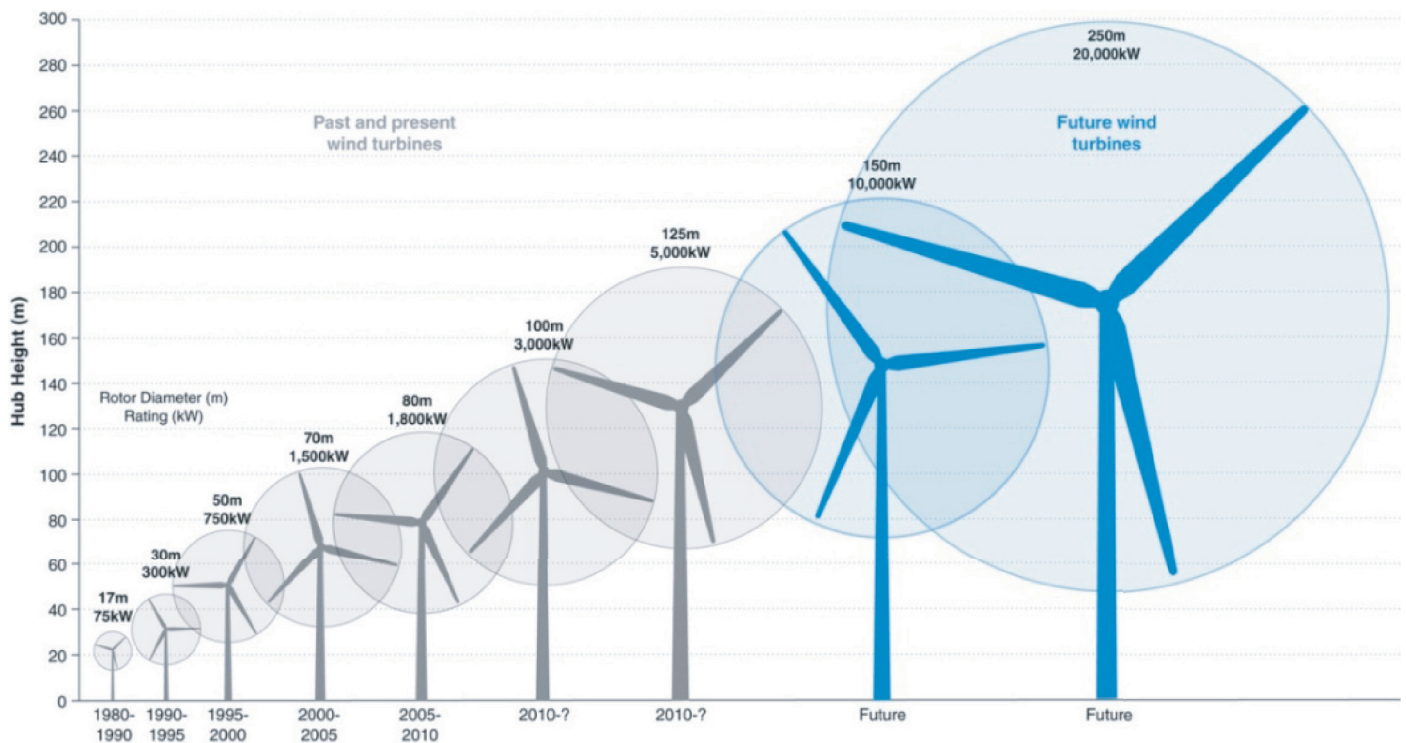

Figure 11.40 | Development and size growth (rotor diameter) of wind turbines since 1980. Source: courtesy of NREL.

they would ever be. But with each new generation of turbines, size has increased linearly and resulted in a reduction in life-cycle cost of energy. This impressive evolution of wind turbine technology is illustrated in Figure 11.40.

11.5.4.2 Potential Future Land-based Turbine Technology Improvements

The long-term drive to develop larger turbines stems from a desire to increase power production (by tapping higher-quality wind resources with larger rotors and towers), reduce investment costs per unit of capacity, and reduce operation and maintenance costs per unit of capacity. Increased size also leads to the consideration of wind turbines as energy plants – which is important to large-scale implementation – and to the introduction of more sophisticated technologies such as smart-blade designs.

There are constraints to this continued growth, however (see, e.g., Thresher et al., 2008a). In general, it costs more to build a larger turbine. The primary argument for a size limit for wind turbines is based on the “square-cube law.” Roughly stated, it says that “as a wind turbine rotor increases in size, its energy output increases with the rotor-swept area (the diameter squared), while the volume of material required, and therefore its mass and cost, increases as the cube of the diameter.” Consequently, at some size the cost for a larger turbine will grow faster than the resulting energy output and revenue, making scaling unattractive on economic terms. Engineers have successfully skirted this law by optimizing design

characteristics for a given turbine size and removing material or by using material more efficiently to trim weight and cost (Burton et al., 2001).

Constraints in transporting very large blades, towers, and nacelles over land also can pose limiting factors to wind-turbine growth. An additional constraint is the cost and availability of cranes that are capable of lifting components into place. If designers are unable to address these problems, future land-based turbines are likely to be redesigns of 2–5MW turbines, with an emphasis on greater efficiency and reliability. Transportation to offshore sites is not limited by size, and offshore wind energy is a major driver of the development of larger turbines.

Both the European Technology Platform for Wind Energy (TPWind, 2008) and the US DOE (WindPACT, 1999; US DOE, 2008a) have identified a broad array of wind energy R&D activities that have the potential to improve the cost and performance of wind technology significantly. Potential improvements are summarized in Table 11.23, which also shows the manufacturing learning-curve effect generated by several doublings of turbine manufacturing output expected. The impact on capital cost reduction is assumed to range from zero in a worst-case scenario to the historic level in a best-case scenario, with the most likely outcome halfway in between. The most probable scenario is a sizable (~ 45%) increase in capacity factor with a modest (~ 10%) drop in capital cost (Thresher et al., 2008a).

Thus although no “big breakthrough” is on the horizon for land-based wind technology, many evolutionary R&D steps can cumulatively bring

Table 11.23 | Areas of potential wind energy technology improvements.^a

Technical Area	Potential Advances	Increments from Baseline (Best/Expected/Least)	
		Annual Electricity Production per kW (%)	Turbine Investment Cost per kW (%)
Advanced Tower Concepts	<ul style="list-style-type: none"> * Taller towers in difficult locations * New materials and/or processes * Advanced structures/foundations * Self-erecting, initial or for service 	+11/+11/+11	+8/+12/+20
Advanced (Enlarged) Rotors	<ul style="list-style-type: none"> * Advanced materials * Improved structural-aero design * Active controls * Passive controls * Higher tip speed/lower acoustics 	+35/+25/+10	-6/-3/+3
Reduced Energy Losses and Improved Availability	<ul style="list-style-type: none"> * Reduced blade soiling losses * Damage-tolerant sensors * Robust control systems * Prognostic maintenance 	+7/+5/0	0/0/0
Advanced Drive Trains (Gearboxes and Generators and Power Electronics)	<ul style="list-style-type: none"> * Fewer gear stages or direct drive * Medium/low-speed generators * Distributed gearbox topologies * Permanent-magnet generators * Medium-voltage equipment * Advanced gear tooth profiles * New circuit topologies * New semiconductor devices * New materials (GaAs, SiC) 	+8/+4/0	-11/-6/+1
Manufacturing Learning	<ul style="list-style-type: none"> * Sustained, incremental design and process improvements * Large-scale manufacturing * Reduced design loads 	0/0/0	-27/-13/-3
Totals		+61/+45/+21	-36/-10/+21

^a The baseline for these estimates was a 2002 turbine system in the United States. There have already been sizable improvements in capacity factor since 2002, from just over 30% to almost 35%, while investment costs have increased due to large increases in commodity costs in conjunction with a drop in the value of the US dollar. Therefore, working from a 2008 baseline, a more-modest increase in capacity factor could be expected, but the 10% investment cost reduction is still quite possible, if not conservative, particularly from the higher 2008 starting point. The table does not consider any changes in the overall wind turbine design concept (e.g., two-bladed turbines).

Source: US DOE, 2008a.

about a 30–40% improvement in the cost effectiveness of this wind technology over the next two decades.

11.5.4.3 Offshore Wind Turbine Technology: Current Status

The typical offshore wind turbine to date has essentially been a marinated version of the standard land-based turbine installed in shallow water, with some system redesigns to account for ocean conditions (Musial and Ram, 2010). Modifications include upgrades to the support structure to address added loading from waves, pressurized nacelles and environmental controls to prevent corrosive sea air from degrading critical drive train and electrical components, and personnel access platforms to facilitate maintenance and provide emergency shelter (Thresher et al., 2008b). Offshore turbines must also have corrosion protection systems at the sea interface and high-grade marine coatings on most exterior components. For marine navigational safety, turbine arrays are equipped with warning lights, vivid markers on tower bases, and fog signals. To minimize expensive servicing, offshore turbines can be equipped with, for example,

enhanced condition monitoring systems, automatic bearing lubrication systems, and on-board service cranes – all of which exceed the standard for land-based designs (Thresher et al., 2008b).

Today's offshore turbines range in capacity from 2 to 5 MW and typically are represented by architectures that include a three-bladed horizontal-axis upwind rotor, nominally 80–126m in diameter. The drivetrain topology consists of a modular three-stage hybrid planetary-helical gearbox that steps up to generator speeds between 1000 and 1800 rpm, which is generally run with variable speed torque control, although there is some evidence that direct drive generators might offer a smaller, lighter, cheaper, and more reliable alternative. Tower heights offshore are generally less than those of land-based turbines because wind-shear profiles are less steep, tempering the energy capture gains sought with increased elevation. Lower offshore tower heights also reduce the potential for overturning – an important consideration for floating platforms (Thresher et al., 2008b).

The offshore foundation systems differ substantially from land-based turbines. Offshore wind turbines installed to date have used three main

foundation designs: monopile, gravity base, and multipile. Monopile and multipile foundation technologies require specialized installation vessels to drive piles into the seabed. Gravity bases can simply be towed to the site, where they are filled with ballast and sunk carefully onto each site. Once the foundation is prepared, the turbine is installed using a specialized crane ship or barge. Mobilization of the infrastructure and logistical support for a large offshore wind farm is a significant portion of the cost (Thresher et al., 2008b).

In 2009, some 88% of offshore turbines were installed on monopiles, 8% on gravity bases, and 3% on multipiles (EWEA, 2009). The choice of foundation technology is largely governed by project economics. Monopiles and gravity bases are the most cost-effective technologies for turbines rated lower than 5 MW and installed in shallow water (less than 30m). It is expected that it will be cost-prohibitive to use these technologies with larger turbines or transitional depths (30–60m). So the use of multipiles is expected to expand considerably.

11.5.4.4 Potential Future Offshore Turbine Technology Improvements

Three pathways for offshore technology represent progressive levels of complexity and development that will lead to cost reductions and greater deployment potential (Thresher et al., 2008b). The first path is to lower costs and remove deployment barriers for *shallow-water technology* in water depths of 0–30m, where technology has already been deployed and proven. The second path is *transitional depth technology*, which is needed for depths where current technology no longer works, up to the point where floating systems are more economical. This technology deals mostly with substructures that will be adapted from existing offshore oil and gas practices. The third path is to develop technology for *deep-water* depths of 60–900m. This could use floating systems, which will require a higher level of R&D to optimize turbines that are light-weight and can survive additional tower motion on anchored, buoyant platforms. Deep-water designs would open up major areas to wind energy development where the turbines would not be visible from shore and where competition with other human activities would be minimal. Such platforms would allow mass production of all system components, introducing a major new opportunity for cost reduction. At this time, all three of these development pathways are being explored.

The European *UpWind* research project (Hjuler Jensen, 2007) envisions offshore wind turbines growing in scale to 8–10 MW and having rotor diameters greater than 120m, which is a challenge to design, build, install, and operate at sea. The project, established to address this multitude of engineering challenges, addresses these technical areas: aerodynamics and aero-elasticity, rotor structure, and materials; foundations and support structure; controls systems; remote sensing; condition monitoring; flow; electrical grid; and management. The *UpWind* project is also designed to address systems integration topics like integrated system design, standards, metrology (measurement), training

and education, innovative rotor systems, electricity transmission and conversion, smart rotor blades, and system up-scaling.

In general, offshore wind technology is expected to gain improvements similar to those envisioned for land-based wind turbines (as outlined in Table 11.23) but at a much larger machine scale and in a more hostile operating environment. Clearly the researchers must design larger and lighter rotors.

11.5.4.5 Future Underlying Science Challenges

The very significant wind energy technology improvements and related cost reductions currently achieved have been enabled by the application of improved engineering analysis and design techniques and by testing each new wind turbine component and system. However, wind energy technology has matured to a point where it will be difficult to sustain this rapid rate of improvement without a major advance in understanding of the basic physical processes underlying wind energy science and engineering. There are fundamental knowledge barriers to further progress in virtually all aspects of wind energy engineering: scientists' understanding of atmospheric flows, unsteady aerodynamics and stall, turbine dynamics and stability, and turbine wake flows and related array effects. Even climate effects might be caused locally by the large-scale use of wind energy, both onshore and offshore (Thresher et al, 2008a).

Research in these focus areas has developed in relative isolation from the others. Continued progress in wind energy technology will require interdisciplinary reunification, especially with the atmospheric sciences, to exploit previously untapped synergies. Also, experiments and observations need to be applied in a coordinated fashion with computation and theory. The use of high-penetration wind energy deployment requires an unprecedented ability to characterize the operation of large wind turbines deployed in gigawatt-scale wind plants (Thresher et al, 2008a).

11.5.5 Economic and Financial Aspects

11.5.5.1 Present Wind Energy Costs

Capital costs for wind projects have declined dramatically since the 1980s. Figure 11.41 shows historic installed capital costs for wind projects in the United States and Denmark from 1982 to 2009. Improved design methods and experience with installations as well as upscaling of turbine technology contributed to the decreases observed until 2002/2003. Since 2004, however, capital costs have increased, driven by turbine performance improvements, rising commodity prices, currency fluctuations, high demand for turbines, supply chain constraints, higher labor costs, and increased margins for original equipment manufacturers, developers, and component suppliers. Milborrow (2010) reports that the global average capital costs for onshore wind projects installed in 2009 ranged from US\$1400–2100/kW, with an average of US₂₀₀₅\$1750/kW.

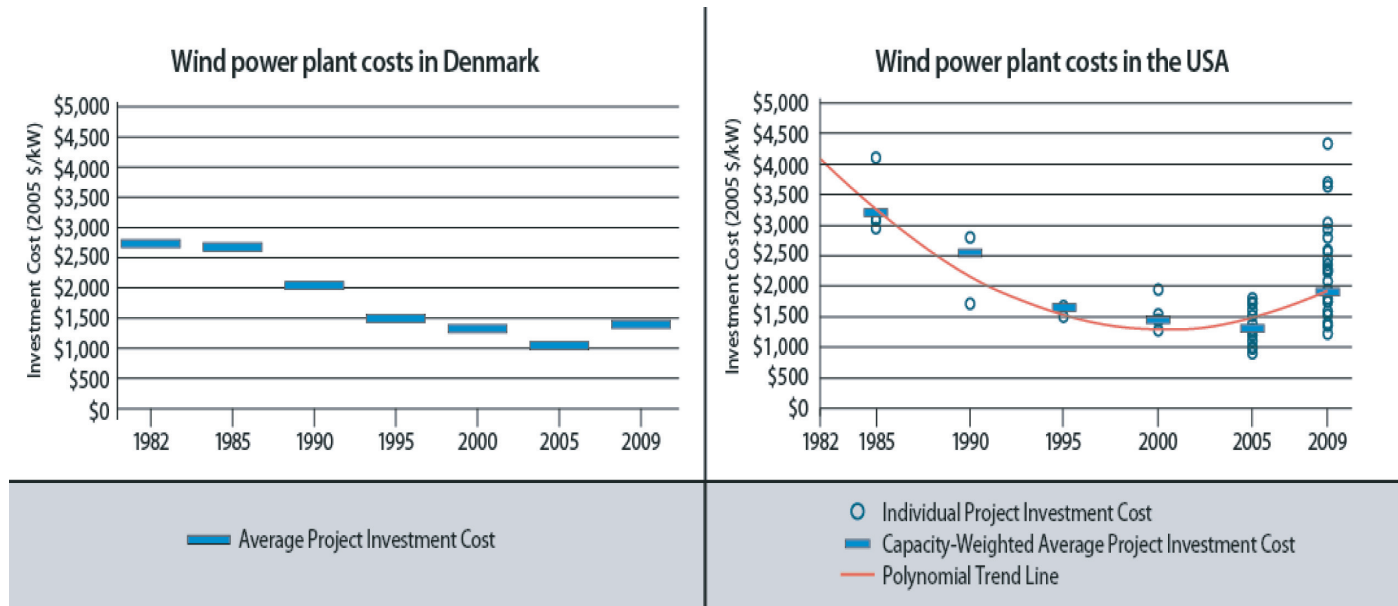

Figure 11.41a, b | Installed Wind Project Costs over time in Denmark and the United States. Source: Denmark: Nielson et al., 2010; United States: Wisner and Bolinger, 2010.

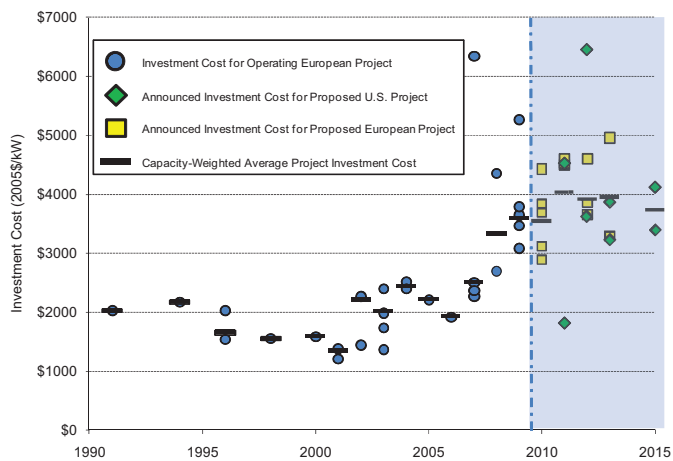

Figure 11.42 | Capital costs for installed and announced offshore wind projects. Source: Musial and Ram, 2010. Courtesy of NREL.

Wisner and Bolinger (2010) report a slightly higher average capital cost in the United States of US\$1900/kW. Capital costs for Chinese projects are substantially lower, with an average in the range of US\$1000–1300/kW as a result of low-cost turbines supplied by Chinese manufacturers (Li and Ma, 2009; Li, 2010). Some of the cost pressures (supply chain, commodity prices) appear to be easing, leading to expectations that capital costs will decrease over time (Wisner and Bolinger, 2010).

Capital costs for offshore projects are far less certain due to the relative immaturity of the technology. Figure 11.42 shows the capital costs for installed and announced offshore wind projects from 1990 to 2015. Offshore wind project capital costs rose from about US\$1300/kW to current levels of US\$3000–6000/kW, driven by similar factors as land-based wind capital costs.

But these increases were exacerbated by sector-specific factors, including a lack of competition in the market for offshore wind turbines (two manufacturers had a 90% market share in 2009), limited availability of specialized installation vessels, complexity of siting projects in deeper water and farther from shore, and increasingly robust turbine designs necessitated by a better understanding of technical risks (Musial and Ram, 2010). While the near-term trend for offshore wind capital costs is uncertain, there is a positive sign in that the supply chain is becoming more competitive. In 2010, some 21 manufacturers announced 29 different wind turbine models for the offshore market (EWEA, 2011).

Power prices for onshore wind energy have risen considerably since the low reached in 2002 and 2003. Wisner and Bolinger (2010) estimate that prices for electricity generated by onshore wind projects built in 2009 range from about US¢4–8/kWh, with a capacity-weighted average of about US¢6/kWh. (The price for projects in the United States reflects the value of state and federal incentives available to wind projects, such as the federal Production Tax Credit, worth US\$20/MWh, and the Investment Tax Credit/Cash Grant, worth 30% of installed capital cost.) This is double the average price of projects built in 2002 and 2003 and 20% higher than the average price of projects built in 2008. The authors attribute increasing prices to elevated capital costs and lower project capacity factors. EWEA (2009) reports unsubsidized levelized costs of energy ranging from US¢6–13/kWh.

Offshore wind power prices are much less well understood than land-based prices due to a lack of available data and the substantial spike in capital costs between 2004 and 2009. EWEA (2009) calculated unsubsidized LCOE for 10 European projects installed between 2001 and 2008, resulting in a range of US₂₀₀₅¢7–11/kWh. Mott MacDonald (2010) estimates that the LCOE for offshore wind projects installed between

Table 11.24 | Cost of electricity as a function of capacity factor, turnkey investment costs, discount rate, and O&M costs. The O&M costs are assumed at US¢1–2/kWh onshore and US¢2–4/kWh offshore. The economic lifetime is 30 years.

Capacity factor	Turnkey investment costs per kWe (<i>onshore</i>)	Discount rate	
		5%	10%
	US ₂₀₀₅ \$	US ₂₀₀₅ ¢/kWh	
35%	1200	3.5–4.5	5.1–6.1
	2100	5.5–6.5	8.3–9.3
20%	1200	5.4–6.4	8.2–9.2
	2100	8.7–9.7	13.5–14.5

Capacity factor	Turnkey investment costs per kWe (<i>offshore</i>)	Discount rate	
		5%	10%
	US ₂₀₀₅ \$	US ₂₀₀₅ ¢/kWh	
45%	3000	7.0–9.0	10.1–12.1
	6000	11.8–13.8	18.1–20.1
35%	3000	8.4–10.4	12.4–14.4
	6000	14.7–16.7	22.8–24.8

2010 and 2020 will range from US¢15–26/kWh. These estimates of LCOE differ considerably, based on assumptions about the capital cost of offshore wind projects: EWEA uses a range of US\$1500–3300/kW, while Mott Mac Donald uses US\$4356–6825/kWh.

The performance of wind power plants varies with the wind resource of the site, the technology deployed, and maintenance. Globally, individual project capacity factors range from a low of about 20% to a high of 50%. Average capacity factors have been estimated for Germany at about 21% (BTM Consult, 2010), China at 23% (Li, 2010), India at 20% (Goyal, 2010), and the United States at 30% (Wiser and Bolinger, 2010). Offshore turbines installed to date have had a more narrow range of capacity factors, from 35–45% (Lemming et al., 2009), but in the United Kingdom initially also about 30% was found (UKERC, 2010).

The O&M costs for wind projects onshore are estimated to range at present from about US¢1–2/kWh, while those for offshore plants are about US¢2–4/kWh (EWEA, 2009; Lemming et al., 2009; IEA, 2009b, 2010a; Milborrow, 2010; UKERC, 2010; Wiser and Bolinger, 2010).

From these figures it can be calculated, assuming an economic lifetime of the investment of 30 years, that the electricity production costs (the LCOE) range from about US¢4–15US¢/kWh for onshore wind and from US¢7–25/kWh for offshore wind. (See Table 11.24.) Assuming a lifetime of 20 years, the lowest figure increases by about US¢1/kWh.

11.5.5.2 Estimates of Future Wind Energy Costs

Estimating future wind technology costs is difficult, and various approaches have been used. Potential future cost reductions have been

shown through “bottom-up” engineering models through reduced capital cost and increased energy capture of –10% and 45%, respectively. Another methodology for the calculation of future cost reduction potential is learning curve analysis, which calculates a learning rate defined as the cost reduction that occurs with each doubling of deployment.

Learning rates for wind technology summarized for IEA over different time periods range from 8–17% for capital costs and from 18–32% for electricity production costs (IEA, 2010a). The IEA study assumed a learning rate of 7% would result in cost-competitive onshore wind technology by 2020–2025, representing a capital cost reduction of 25%. A learning rate of 9% for offshore wind technology would reach a cost-competitive level by 2030–2035, representing a capital cost reduction of 38%. The IEA study assumed that global average capacity factors would increase from current averages of 20% offshore and 38% onshore to 30% and 40% respectively.

11.5.5.3 System Integration Consideration and Costs

Electric systems have historically linked large, centralized generators to consumers. Wind resources are dispersed and often located some distance from electricity customers. Integration of large amounts of wind-generated electricity will depend on the degree to which electric networks and markets evolve to accommodate variable dispersed generation technologies. Power systems are designed to handle variability, and wind generation adds to that. Experience has shown a number of ways to mitigate this: aggregation of wind generation over large geographic areas to reduce the system-level variability; forecasting methodologies implemented in control rooms to reduce operational impacts and costs; and more flexibility in the system to increase the potential for integrating wind energy. Methods to increase flexibility include additional flexible capacity in the generation mix (such as gas turbines, pumped hydro storage, or other storage technologies), increases in the size of balancing areas, trades closer to real-time (short gate-closure), and encouragement of demand-side flexibility. (See also Section 11.10).

Costs associated with managing wind variability are small at low penetrations. As wind penetration increases, these increase. Additional system balancing costs vary widely across markets, depending on plant mix and fuel costs among other factors. Recent estimates of balancing costs range from US¢0.1–0.5/kWh for wind energy penetrations between 10% and 20% (IEA-Wind, 2010). Expansion of the transmission system to remote wind resources and reinforcing the grid will also add costs. In the United States, the transmission cost to achieve 20% of projected US electricity demand from wind generation in 2030 was estimated to add US\$150–290/kW to the investment cost of wind plants (US DOE, 2008a). Estimates by system operators in Germany, the United Kingdom, the Netherlands, and Portugal are of approximately US\$70–170/kW of wind capacity to reach penetration levels between 15–25% (IEA-Wind, 2010).

System-level costs related to balancing or transmission expansion are borne by different entities based on the operation practices of a particular electric system. As electric systems expand to meet growing demand, including the characteristics of variable generation in the planning and design stages will enable higher penetrations of wind and other renewable technologies.

11.5.6 Sustainability Issues

This section covers sustainability issues outlined by the National Research Council of the National Academies of Sciences in the United States in *Environmental Impacts of Wind-Energy Projects* (NRC, 2007).

There are a number of life-cycle analysis studies of wind turbines. The most extensive is the ExternE study on the externalities of all energy sources. There is general agreement that a modern wind turbine system has an energy payback period of less than half a year (Wiser et al., 2011). Calculated life-cycle GHG emissions for wind range generally from about 8–20 gCO₂-eq/kWh (ExternE, 1995; Tester et al., 2005; Wiser et al., 2011). It should, however, be noted that substantial penetrations of wind energy into the grid will enhance the need for backup power and/or storage and reduce the conversion efficiency of backup plants, adding to these emissions (Gross and Hepponstall, 2008).

In terms of human health and well-being, concerns are related to noise and shadow flicker caused by the turbine blades passing through the sun and creating a flickering light shadow effect that is visually annoying. The loudest noises at a wind farm are generally emitted during construction and are similar for all construction projects. Operating wind turbines are now designed to meet a maximum noise output according to the IEC Standards (IEC, 2010). A shadow flicker analysis for close neighbors is done by the developers during the layout of the wind farm. At that time turbines can be moved to eliminate the possibility of turbine rotor shadows impinging on any close residences.

Aesthetic impacts are generally handled using techniques like an opinion survey of local inhabitants and organizations that are found in or that use the area, to determine the least visually intrusive layout for the wind farm and thereby gain general public acceptance. Responsible wind developers have established methods for gaining acceptance, and they attempt to make the projects a real economic benefit to the local residents and to minimize the visual impacts (see also Wolsink, 2007).

Regarding cultural impacts, the concern is to avoid possible intrusion on important historical, sacred, or archeological sites and to preclude possible litigation.

The economic and fiscal impacts on the local inhabitants are generally felt to be beneficial. Jobs are created locally, and the tax base is often increased along with the monetary benefits associated with direct payments to landowners who allow turbines on their property.

Turbines are sited with an eye to any possible interference with microwave communications systems and electromagnetic interference. Television interference has not been much of a problem since the widespread use of cable and dish satellite TV broadcasting. Interference between wind facilities and radar is real. If the radar unit cannot perform its intended functions, the effects must be mitigated. This can involve blocking the interference using a software fix or moving the turbines. Sometimes the radar unit must be moved or additional radar units added to the system (NWCC, 2006).

The environmental issues for wind technology concern the impacts of facilities on wildlife and wildlife habitat, including wildlife fatalities and habitat loss and modification, as well as animal displacement and fragmentation both for onshore and offshore wind facilities. This impact on wildlife can be direct (for example, fatalities or reduced reproduction) or indirect (such as habitat loss or behavioral displacement). The largest impacts to date are on flying animals, such as birds and bats. At the current level of deployment, land-based wind energy does not appear to have a significant impact on bird fatalities compared with other sources of fatalities, such as collisions with buildings and communication towers as well as predation by cats.

The general conclusion from site monitoring in the United States indicates that the average fatality rate is approximately three birds per MW annually, with about 70% of the fatalities being passerines (song birds) (Wildlife Society, 2007; NRC, 2007). Bat fatalities have been reported at land-based facilities either anecdotally or by post-construction monitoring. The highest fatalities have been recorded at wind farms located on ridges in eastern deciduous forests of the United States. Recent reports showing greater bat fatalities in the open prairie regions of southern Alberta, Canada, and in mixed agricultural and forested lands in New York suggest that the impacts on bats could be higher than currently assumed. Bats are long-lived and have low reproductive rates, so their ability to recover from population declines is limited. This increases the risk of local population extinctions and the loss of species biodiversity (Wildlife Society, 2007). Similar observations are found in Europe. In general, the variability of fatalities between facilities is quite high.

Commercial offshore wind energy facilities require a relatively large expanse of seabed floor for foundations and related structures to fix (or anchor) the structures and for deployment of interconnection cabling. These facilities will cause a degree of physical disturbance to the sea and surrounding seabed, with possible ecological responses (Gill, 2005). Therefore ecologists have expressed concerns about the impact on benthic communities, fisheries resources, marine mammals, sea turtles, and birds. The available studies on possible impacts are, however, limited (Minerals Management Service, 2007). In spite of the limited data available from existing studies, current results show limited negative direct impacts.

As with onshore wind farms, the collision of birds and bats with offshore wind turbine rotors is a major environmental and public concern. Radar studies at offshore Nysted wind farm in Denmark indicate that the

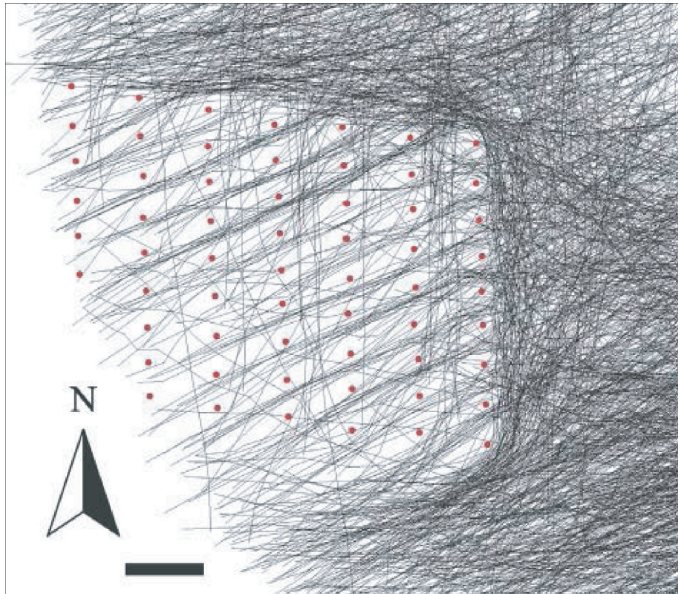

Figure 11.43 | Westerly orientated flight trajectories during the initial operation of the wind farm at Nysted off the southern coast of Denmark. Black lines show the trajectories of water bird flocks and the red dots are the wind turbine locations. The black bar is 1000 m. Source: Desholm and Kahlert, 2005.

diurnal percentage of flocks entering the wind farm area decrease significantly (by a factor of 4.5) from preconstruction to operational conditions (Desholm and Kahlert, 2005). At night about 14% of a flock entered the area of operating turbines, but only 6.5% of those flew within 50m of an operating turbine. During the day these numbers declined to 12.3% and 4.5% respectively. Radar trajectories of water bird flocks flying through the wind farm area are shown in Figure 11.43. It illustrates that water birds avoid wind farms, which reduces the risk of collisions.

11.5.7 Implementation Issues

11.5.7.1 Regional Deployment

The deployment of wind technology has historically been concentrated in Europe, North America, India, and China. High penetration scenarios such as GWEC's advanced scenario of about 2300 GW by 2030 require more diverse geographic deployment. In the advanced scenario, GWEC projects that regions other than Europe, North America, and China will account for 30% of cumulative wind capacity compared with 17% in the reference scenario (GWEC and Greenpeace, 2010a). Enabling the spread of the technology to other regions poses challenges and opportunities for the global industry.

11.5.7.2 Supply Chain Issues

Due to rapid increases in annual installations, from 2005 to 2008 the wind industry suffered acute shortages in the supply of gearboxes,

bearings, and skilled labor. In addition, the offshore industry supply chain experienced a shortage in specialized ports and installation vessels. These factors increased delivery time for turbines and installation time for offshore projects, and they generally drove costs upward. The industry has largely addressed these issues through investment in new manufacturing capacity, the globalization of the supply chain, and the widespread expansion of firms supplying the market. The supply chain does not appear to offer any insurmountable barriers despite the high level of annual installations required in high penetration scenarios.

11.5.7.3 Economics

Deployment will depend on the economic attractiveness of wind technologies balanced against competing technologies under prevailing market conditions. Onshore wind is competitive with conventional generation technologies in areas with strong wind resources. The cost of generating offshore wind power far exceeds market prices for electricity in most regions. While costs are expected to be reduced, near-term deployment of offshore wind technology will remain highly dependent upon policy. This presents a substantial barrier to achieving the high penetration scenarios that suggest that 18–32% of total capacity installed by 2050 may come from offshore (Lemming et al., 2009; IEA, 2010a).

11.5.7.4 Transmission and Integration

Studies have shown that electric systems can integrate 20% wind generation with relatively modest integration costs and without encountering insurmountable technical barriers (US DOE, 2008a; European Commission, 2010; IEA-Wind, 2010). System impacts for deployment above 20% are less well understood but could be addressed through structural changes in the electric market, including better forecasting techniques, increasing fidelity of dispatching procedures, flexible deployment of other generating plants, demand response measures, increased international coordination and interconnection (like the Supergrid and other proposals in Europe (FOSG, 2010; EEGI, 2010)), "smart grids," deployment of storage technologies (including electric transport system), and wind curtailment. (See Section 11.10.) The costs of integration and of maintaining electric system reliability will increase with higher levels of penetration and at some point are likely to constrain further deployment on economic terms. Substantial investments in transmission will be required to deliver power from both onshore and offshore wind plants to load centers. New transmission is required in even the low to moderate penetration scenarios and will limit wind energy deployment if not built.

11.5.7.5 Social and Environmental Concerns

Concerns about the social and environmental impacts of wind power plants – including bird and bat collision fatalities, habitat and ecosystem modifications, visibility, acoustics, competing uses, and radar interference – could limit the deployment of wind technology. These concerns

are likely to become more acute as wind technology reaches higher levels of penetration. The wind industry can limit concerns over social and environmental impacts by seeking to understand the nature and magnitude of these impacts, developing mitigation strategies, and educating the public on the results of these efforts (Wolsink, 2007; Minerals Management Survey, 2007). Advanced deployment scenarios might require that regulators adopt a more streamlined permitting process for wind projects.

11.5.7.6 Policies

In the last two decades, an increasing number of countries have developed and implemented policy measures to promote renewables, including wind (REN21, 2010). Financial support for R&D, establishment of generation or capacity targets based on Renewable Portfolio Standards (RPS) or Obligations, and FITs have been used successfully. Additional measures sometimes include tax incentives, regulation of GHG emissions, bidding overseen by government, appropriate administrative procedures for wind farm planning, priority access to transmission grids, and transmission grid expansion. (See section 11.12.)

11.6 Photovoltaic Solar Energy

11.6.1 Introduction

Photovoltaic solar energy is the direct conversion of sunlight into electricity. The basic building block of a PV system is the solar module, which consists of a number of solar cells. Solar cells and modules come in many different forms that vary greatly in performance and degree of maturity. Applications range from consumer products (milliwatts) and small-scale systems for rural use (tens or hundreds of watts) to building-integrated systems (kilowatts) and large-scale power plants (megawatts and soon up to gigawatts). The PV market – and hence, the PV industry – is developing rapidly as a result of market support programs in a number of countries. So far, self-sustained markets are modest in size, but this may well change during this decade.

11.6.2 Potential of PV Solar Energy

The theoretical potential of solar energy is huge, as expressed in the popular statement that the amount of sunlight hitting Earth in one hour equals the total annual primary energy use worldwide. (See also Chapter 7.) However, this impressive fact has little practical significance. Therefore, it is important to consider the technical and realizable potentials.

11.6.2.1 Technical and Economic Potentials

The technical potential of solar energy is estimated to be between 1600 and 50,000 exajoules (EJ) a year (UNDP et al., 2000), with the wide

range expressing the very different assumptions made in the analyses. Higher figures are mentioned too, however (see Chapter 7; also Figure 11.3). Even though the lower limit exceeds the current and estimated future worldwide energy use, there is no consensus on the economic potential of solar energy in general and of PV in particular because of the many technical, economic, and societal aspects at play.

11.6.2.2 PV Roadmaps and Scenarios

At the end of 2009, the installed solar PV capacity was 24–25 gigawatts peak (GWp), consisting of 21 GWp of grid-connected systems and 3–4 GWp of off-grid systems (REN21, 2010; IEA-PVPS, 2010; Jäger-Waldau, 2010). This generated 30–35 terawatt-hours (TWh) a year.⁶ In 2010, another 16–17 GWp were added (versus about 7 MW in 2009), bringing the total installed capacity worldwide to roughly 40 GWp, producing some 50 TWh a year (EPIA, 2011).

In the 2010 IEA *PV Technology Roadmap*, the share of PV in global electricity consumption in 2050 is estimated at 11% (4600 TWh/yr) and the installed capacity at 3.2 TWp. Higher projections of the installed capacities can also be found. In *Solar Generation 6*, Greenpeace and the European Photovoltaic Industry Association project up to 4.7 TWp (6800 TWh) for 2050 (Greenpeace and EPIA, 2010). A study on very large-scale use of PV and concentrating solar power (in combination with compressed air energy storage) in the United States suggests that the combined contribution to electricity consumption could be as high as 69% in 2050; this would correspond to 35% of primary energy use, a share that could increase to 90% in 2100 (Fthenakis et al., 2009).

Komoto et al. (2009) prepared a detailed analysis of the potential of large-scale PV systems in sunbelt (desert) regions of the world. For six major regions, they determined a total potential of 465 TWp, allowing 750,000 TWh of solar electricity generation per year (2700 EJ_e/yr). In an ambitious scenario, the total installed PV capacity could be 10 TWp in 2050 and 133 TWp in 2100, of which 2 TWp and then 67 TWp would be in the form of very large-scale systems (the remainder would be urban and rural systems).

11.6.2.3 Potential of PV in the Built Environment

Because PV is a highly modular technology and does not involve moving parts, it can be integrated into buildings (roofs and facades) and infrastructure objects such as noise barriers, railways, and roads. This makes PV a suitable technology for use in urban and industrial areas. A number of studies have shown that the potential expressed as the fraction of

⁶ Because about half of the installations are still in Germany, which has relatively low insolation, the ratio between electricity generated and power installed will increase as the market share of “sunny” countries increases (from 1.25 to at least 1.5 kWh/Wp per year).

solar electricity from roofs and facades to the total electricity consumption per country varies from 20% to 60%, mainly depending on the electricity consumption per capita and the insolation level (IEA-PVPS, 2002; Lehmann et al., 2003). This assumes a rather conservative 10% energy conversion efficiency of the PV system. Future generations of PV modules may well cover a significantly higher fraction of the demand.

11.6.3 Market Developments

The market for PV systems can be divided into two main categories and several subcategories:

- *Grid-connected PV systems* – can be building-integrated and building-adapted systems (distributed systems), ground-based systems (power plants), and others (such as systems on sound barriers).
- *Off-grid / stand-alone PV systems* – can be solar cells integrated in consumer products, professional systems (e.g., telecom), rural PV systems, mini-grid systems, and others.

The market can also be divided according to the type of ownership, such as households, housing corporations, industries, companies, utilities, and institutional investors.

11.6.3.1 PV Market Deployment

Figure 11.44 shows the evolution of grid-connected and off-grid PV systems from 1995 to 2009. The total cumulative installed capacity has increased by about 30% per year on average. For grid-connected systems alone, the average growth was 50% a year.

Table 11.25 presents the cumulative installed PV capacity by country at the end of 2010, showing the leading positions of Germany (50%), Spain (11%) and Japan (10%) (see also REN21, 2011). On a per capita basis, Italy also belongs to the lead. These leading positions have been achieved in various ways (see IEA-PVPS, 2010; 2011). Japan has been a pioneer in market development and saw steady market growth until 2005, after which the market stabilized for a few years as a result of changes in market incentives; in 2009, Japan caught up again. Spain only recently joined the leaders, with an explosive (and unsustainable) growth of the Spanish market by 500% in 2008; but in 2009, the market fell back to pre-2006 levels due to drastically reduced market incentives. Germany is the only country with a substantial and steadily growing market through 2010.

The global PV market depends at present on market support policies in a very small number of countries. For sustainable and yet rapid growth, it is essential that the global market relies on more countries. Thus it is noteworthy that the group of countries with significant PV markets is growing, with Italy, France, and the United States as important examples. A

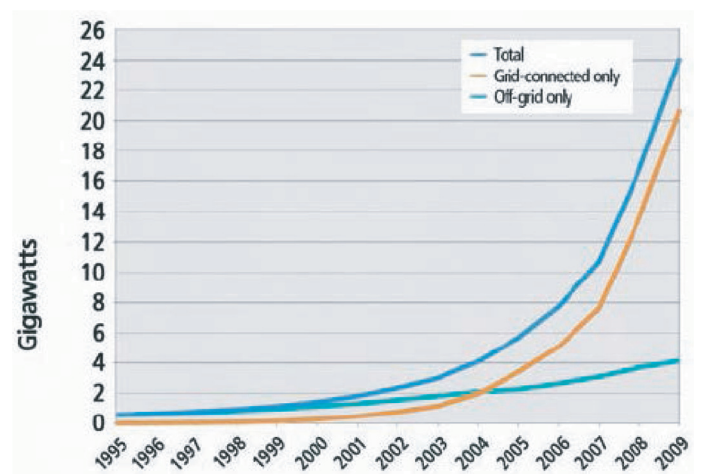

Figure 11.44 | Cumulative installed PV capacity, 1995–2009. In 2010 the total installed capacity was 40 GW (REN21, 2011). Source: REN21, 2010.

key question is how fast new markets will develop in, for example, China and India and countries in sunbelt regions, such as northern Africa.

Although currently the global market for PV systems depends heavily on various market support schemes, this situation is expected to change rapidly as system prices – and therefore, electricity generation costs – continue to decrease. In its *PV Roadmap*, the IEA distinguishes three levels of competitiveness (IEA, 2010). In the first level, the current situation, PV is only competitive in selected applications and regions of the world. In the second level, PV generation costs are lower than retail electricity prices. This is expected to happen between 2012 and 2030 almost everywhere. In the third level, PV electricity can compete with wholesale prices of electricity and, after that, with bulk power generation costs in a number of markets. This is expected to occur from 2020 onward. This scenario agrees with other major studies, such as the *Implementation Plan* of the European Photovoltaic Technology Platform (EPTP, 2009) and the Japanese *Roadmap PV2030+* of New Energy and Industrial Technology Development Organization (NEDO) (NEDO, 2009; Aratani, 2009).

11.6.3.2 Development of PV Industry

Figure 11.45 shows the growth of PV cell and module production in different regions. Manufacturers are located throughout the world, with recent rapid industry expansion in Asia. Table 11.26 shows the number of jobs in the PV sector, including R&D, as of the end of 2009. While the total number of PV-related jobs there is close to 200,000, China, Taiwan, and other Asian countries are not included in this list. So the real total is much higher (especially industry-related jobs, not deployment-related jobs).

The 2010 global turnover of the PV sector is roughly estimated to be US₂₀₁₀\$100 billion. This number includes the value of turnkey system installations as well as investments in new production capacity and R&D. Although turnkey system prices are decreasing, market expansion

Table 11.25 | Cumulative installed PV capacity by country and application type, by the end of 2010. (Only the countries participating in the International Energy Agency-Photovoltaic Power Systems Programme (IEA-PVPS) are shown)

Country	Cumulative off-grid PV capacity (MW)		Cumulative grid-connected PV capacity (MW)		Cumulative installed PV power (MW)	Cumulative installed per capita (W/capita)	PV power installed during 2010 (MW)	Grid connected PV power installed during 2010 (MW)
	Domestic	non-domestic	distributed	centralized				
Australia	44.2	43.6	479.3	3.8	570	25.19	383.3	379.5
Austria		3.8		91.7	95.5	11.36	42.9	42.7
Canada	22.9	37.2	37.7	193.3	291.1	8.43	196.6	171.7
Switzerland		4.2	104.1	2.6	110.9	14.1	37.3	37.1
China					800	0.6	500	
Germany	50		17320		17370	212.47	7411	7406
Denmark	0.2	0.5	6.4	0	7.1	1.28	2.4	2.3
Spain					3915	84.83	392	389
France	29.8		830.3	194.2	1054.3	16.02	719	716
United Kingdom					69.8	1.07	40.1	
Israel	3	0.3	66.6	-	69.9	9.02	45	45
Italy	4	9	1532	1957	3502	57.76	2321	2321
Japan	3.4	95.4	3496	23.3	3618.1	28.28	991	986.8
Korea	1	5	131.3	518.3	655.6	13.38	131.2	131.2
Mexico	19.1	6.3	4.2	1	30.6	0.27	5.6	3.9
Malaysia		11		1.6	12.6	0.46	1.5	0.5
Netherlands					88	5.27	21	
Norway	8.4	0.5	0.2	0	9.1	1.83	0.4	0.1
Portugal		3.1	33.1	94.6	130.8	12.3	28.6	28.5
Sweden	4.9	0.8	5.4	0.3	11.4	1.21	2.7	2.1
Turkey	1.2	4.2	0.6	0	6	0.08	1	0.1
USA		440	1727	367	2534	8.13	918	887
Estimated totals for IEA PVPS Countries (MW)		980	33973	367	34953		14192	14098

Source: IEA-PVPS, 2011.

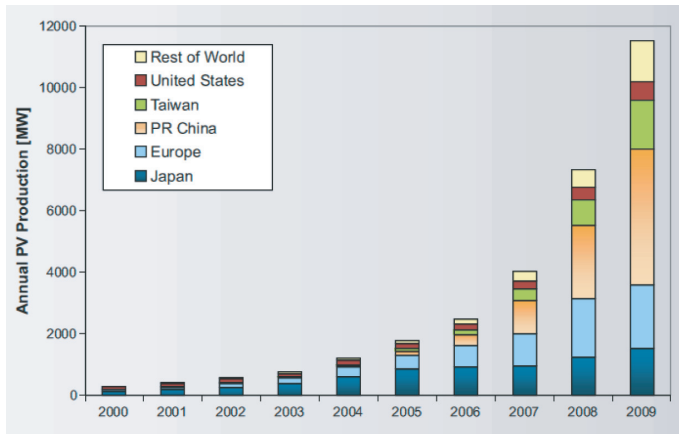

Figure 11.45 | Annual solar cell/module production by region. Source: Jäger-Waldau, 2010.

is so rapid that the related turnover is increasing rapidly. Investments in expansion of manufacturing capacity increase even more rapidly than market volumes, in view of expected PV market growth.

11.6.4 PV Technology Development

The discovery of the photovoltaic effect is usually attributed to Edmond Becquerel (Becquerel, 1839). Practical applications for power generation, however, have only come within reach after the successful development in the early 1950s of methods for well-controlled processing of semiconductor silicon, the material that most solar cells are still made of. The research group at Bell Laboratories in the United States played a key role in this development (Perlin, 1999). Many people immediately saw the great potential of PV for large-scale use, but the number and size of applications remained very modest until the 1980s. An exception was the use of PV to power satellites, which began successfully in 1958 and has remained their standard power source.

11.6.4.1 Basic Principles of Operation

The photovoltaic effect is based on a two-step process (see Figure 11.46), summarized by Sinke (2009) as follows:

- The absorption of light (consisting of light particles, or photons) in a suitable (usually semiconductor) material, by which negatively charged electrons are excited and mobilized. The excited electrons leave behind positively charged “missing electrons,” called holes, which can also move through the material.
- The spatial separation (collection) of generated electrons and holes at a selective interface, which leads to a buildup of negative charge on one side of the interface and positive charge on the other side. As a result of this charge separation, a voltage (an electrical potential difference)

builds up over the interface. In most solar cells, the selective interface (junction) is formed by stacking two different semiconductor layers—either different forms of the same semiconductor (in homojunction cells) or two different semiconductors (in heterojunction cells).

The key feature of a semiconductor junction is that it has a built-in electric field, which pushes/pulls electrons to one side and holes to the other side. When the two sides of the junction are contacted and an electrical circuit is formed, a current can flow (i.e., electrons can flow from one side of the device to the other). The combination of a voltage and a current represents electric power. When the solar cell is illuminated, electrons and holes are generated and collected continuously and the cell can thus generate power.

11.6.4.2 Features of Sunlight and Solar Cell Efficiency Limits

The total annual amount of solar energy per unit area (the insolation) varies over Earth’s surface and roughly ranges from 700 kWh/m² in polar regions to 2800 kWh/m² in selected dry desert areas for horizontal planes (Šúri, 2006).⁷ When comparing the insolation on optimally inclined surfaces, the range becomes smaller, with the lower values increasing to roughly 900 kWh/m². In other words, the global range of electricity production potentials per m² of fixed, optimally inclined surface area roughly spans a factor of three.

The maximum intensity of sunlight is about 1 kW/m² everywhere. The differences in insolation primarily result from varying time fractions with low light levels (seasonal, but also daily variations). Whereas daily variations are inherent to the use of sunlight, the magnitude of seasonal variations in the daily (or weekly or monthly) amount of solar energy received may have important implications for system design and implementation.

Sunlight consists of a wide range of colors (from infrared to ultraviolet) and corresponding photon energies that make up the solar spectrum. The shape of the spectrum and the total intensity of the light depend on the position of the observer with respect to the sun and on atmospheric conditions. When the sun is exactly overhead and the sky is clear, the spectrum is “Air Mass 1,” which means that the sunlight has passed through Earth’s atmosphere in the shortest possible path: it has crossed “1 air mass.”⁸ Upon passing through the atmosphere, some light is absorbed and some light is scattered, leading to characteristic features in the spectrum shape. When the sun is incident at another angle, the

⁷ High-quality, extensive information on insolation in Europe and Africa can be found at sunbird.jrc.it/pvgis/, which also gives links to databases covering other regions of the world. An excellent source of US information is rredc.nrel.gov/solar/old_data/nsrdb/redbook/atlas/.

⁸ Actually, definitions are much stricter than described here; see, e.g., rredc.nrel.gov/solar/spectra.

Table 11.26 | PV-related labor places, selected countries, 2009.

Country	R&D, manufacturing, and deployment labor places	Country	R&D, manufacturing, and deployment labor places
Australia	5,300	Mexico	119
Austria	2,870	Malaysia	3,172
Canada	2,700	Norway	1,485
Denmark	350	Sweden	630
France	8,470	South Korea	6,500
Germany	65,000	Switzerland	8,100
Great Britain	1,171	Turkey	300
Italy	8,250	USA	46,000
Japan	26,700		

Source: IEA-PVPS, 2010.

Air Mass number changes accordingly. For measurement purposes, Air Mass 1.5 is often taken as a reference, where the path of light is at an angle through 1.5 times the thickness of the atmosphere.

The efficiency (η) of solar cells is defined as the maximum power output of the cell ($P_{max,electrical}$) divided by the power input in the form of light (P_{light}). For reasons of easy and fair comparison, efficiency values are normally defined and measured under Standard Test Conditions (STC): Air Mass 1.5 spectrum (AM1.5), 1 kW/m² light intensity, and 25°C operating temperature, although other standardized conditions are also useful and necessary for certain types of cells and modules, especially concentrators.

The rated power of PV cells, modules, and systems is expressed in terms of watt-peak (Wp), which is the power produced at STC. The efficiency of cells, and hence, of modules and systems, depends in part on operating conditions. Therefore, the average efficiency over a year differs from the STC efficiency. In most cases, the average value is lower. In particular, higher operating temperatures, lower light intensities, and different light spectra lead to deviations from STC efficiency. To calculate the electricity yield, the rated power has to be multiplied by the equivalent number of hours of full sun (e.g., per year) and corrected for the effects of non-STC conditions.

Semiconductors can be characterized by their light absorption behavior. Each semiconductor has a specific threshold energy above which photons can be absorbed and below which the material is basically transparent. This threshold energy is the so-called bandgap energy, the minimum energy it takes to free an electron from its original position in the crystal lattice of the material.⁹ The bandgap energy varies

⁹ The bandgap energy and also photon energies are usually expressed in electron-volts (eV)—the energy an electron takes up when it passes through a 1-volt (V) potential difference: $1.6 \cdot 10^{-19}$ joule (J). The eV is a convenient unit in relation to the behavior of single electrons, such as light absorption. Bandgap energies are typically between a few tenths of an eV and a few eV. Solar photon energies are in the same range.

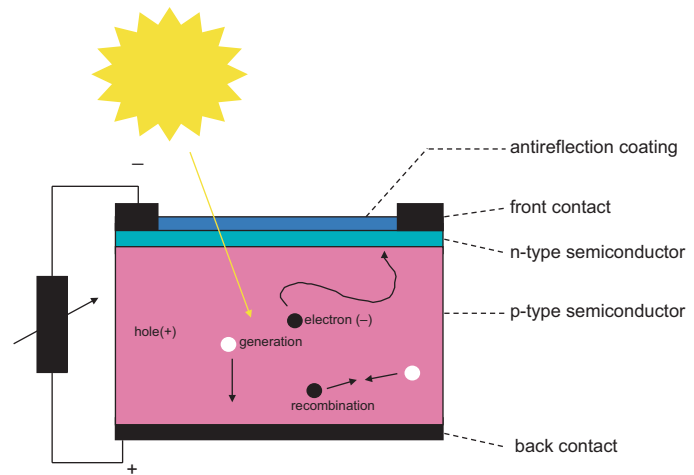

Figure 11.46 | Schematic cross-section of a solar cell.

substantially from one semiconductor to another and determines which part of the solar spectrum can be absorbed. Low-bandgap materials absorb more of the solar spectrum than high-bandgap materials and can thus, in principle, generate more current. However, the output voltage of a solar cell is also related to the bandgap: the higher the bandgap, the higher the voltage (at least for ideal devices). This implies that to achieve maximum efficiency, it is important to choose an optimum bandgap.

In any cell made of a single semiconductor (i.e., one bandgap), there are large spectral losses. Part of the spectrum cannot be absorbed at all and the rest can only be partially used. The combined spectral losses add to more than 50% even for the optimum bandgap and perfect material. In addition to the spectral losses, any cell suffers from some fundamental losses – for example, those related to electrons and holes recombining. For cells made from one type of material and operating under natural, unconcentrated sunlight, the efficiency is therefore limited to a maximum of about 30%. The best single-material solar cells made so far have an efficiency of 25–26% (Green et al., 2010), indicating that these devices are already close to perfect. Commercial solar cells and modules have significantly lower efficiencies, as discussed in the next sections.

Two common strategies to move the efficiency beyond the limit are to use multiple materials (bandgaps) for light absorption and to use concentrated sunlight. By stacking solar cells with different absorption characteristics, it is possible to achieve better coverage of the solar spectrum and to reduce the spectral losses. These are called multijunction, multigap, multilayer, or tandem solar cells. By using concentrated sunlight (up to 1000x), the effects of recombination of electrons and holes can be reduced and the output voltage can be increased. This requires a dedicated device design, because the currents generated by concentrated sunlight are large, and significant amounts of heat need to be extracted. The combination of these two approaches pushes the fundamental efficiency limit up to 75% (Green, 2003).

Table 11.27 | Overview of PV technologies, PV conversion concepts, and PV efficiency boosters.

State of Development	Category	Technology Type
Commercial	Flat-plate	Wafer-based crystalline silicon (mono-crystalline, cast multi-crystalline, ribbon)
		Thin-film silicon (amorphous, nano- and microcrystalline)
		Thin-film cadmium telluride (CdTe)
		Thin-film copper-indium/gallium-diselenide/sulfide (CIGSS)
	Concentrator	Silicon-based
		Compound (III-V) semiconductor-based
Emerging (typically advanced laboratory or pilot production)	Flat-plate	Polymer cells and modules
		Dye-sensitized cells and modules
		Alternative forms of inorganic thin films (e.g., printed CIGSS) and hybrid materials
	Concentrator (low concentration)	Luminescent concentrators using silicon or compound semiconductor cells
Novel concepts (laboratory only – research or proof-of-principle phase)	Not yet known	Intermediate-band semiconductors (“intrinsic multijunction materials”)
		Spectrum converters (“external efficiency boosters”)
		Various electronic and optical applications of quantum dots (e.g., “all-silicon tandems”)
		Plasmonic structures for light management
		Hot-carrier devices

Source: EPTP, 2007.

There is growing interest in achieving such efficiencies through “third-generation photovoltaics.” Some of these concepts offer fundamental efficiency limits of 75–85% (Green, 2003); however, they are all in a very early stage of development.

11.6.4.3 Practical Solar Cells and Modules

Solar modules are commonly divided into two categories:

- Flat-plate modules, in which the active cell area is roughly equal to the light-harvesting area.
- Concentrator modules, in which a small-area solar cell is illuminated by sunlight collected on a (much) larger area. These modules have a lens or mirror to focus sunlight onto the solar cell.

Concentrator modules need to track the sun because the light must come from a well-defined angle to produce a high-quality focus on the cell. For similar reasons, concentrator modules only use the direct (not the diffuse) part of the sunlight. Therefore, they work best in regions where the fraction of direct radiation is high, typically countries with an insolation of 1500 kWh/m²/yr or more. Low-concentration-factor modules that do not require tracking have also been developed; “flat-plate concentrators” or “luminescent concentrators” fall in this category (see, e.g., Currie et al., 2008).

For flat-plate modules, it has been calculated that the performance gain of two-axis tracking compared with using an optimal but fixed orientation ranges from 10% to more than 40%, depending on the geographical location (Huld et al., 2008; Komoto et al., 2009).

It is also common to categorize cell and module technologies according to the active material(s) – the semiconductors – used for the solar cells. At the highest level, the technologies can be divided into wafer-based technologies and thin-film technologies.

Although the term “wafer-based” usually refers to flat-plate technologies, concentrator cells may also be (and usually are) wafer-based. The wafer may be silicon, germanium, or gallium arsenide, although the latter two are only for concentrator applications. In the discussion here, “wafer-based” is used only regarding silicon technology. The individual cells produced from wafers are electrically connected before or on encapsulation in a module.

In the case of thin-film technologies, the cells are deposited on a substrate (glass or metal foil) or a superstrate (glass) in the form of a very thin layer. Typical thicknesses are on the order of 1 micrometer (10⁻⁶ meter).

In the framework of a Strategic Research Agenda (EPTP, 2007), the European Photovoltaic Technology Platform prepared an overview of the present state of the art and expected future developments in cell and module technologies. The technology categories and types are summarized in Table 11.27.

Figure 11.47 presents the historic development of record laboratory cell efficiencies for a selection of technologies and concepts mentioned in Table 11.27. The figure shows gradually increasing efficiencies for most technologies, with occasionally more rapid increases and a few cases of saturation (indicated by termination of trend lines).

While Figure 11.47 shows record efficiencies for small-area laboratory cells (typically 1 cm²), efficiencies for large-area commercial module

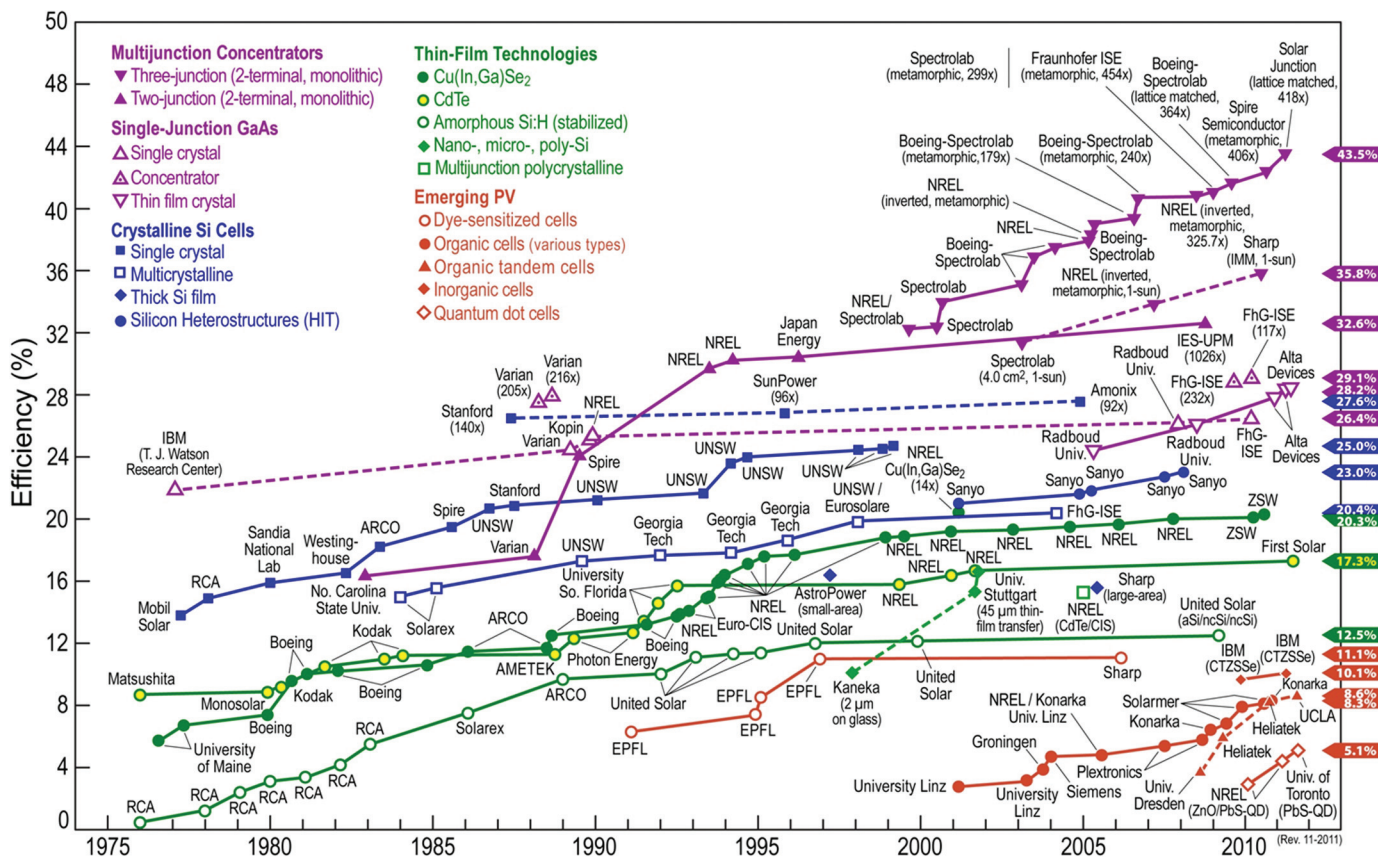

Figure 11.47 | Trends in conversion efficiencies for various laboratory solar cell technologies. Source: Kazmerski, 2011. Courtesy of NREL.

efficiencies (typically 1 m²) are significantly lower. Efficiencies of currently available most commercial modules and the possible efficiency evolution of improved, as well as new, technologies are presented in Figure 11.48. The figure shows a gradual but robust increase for all existing technologies and the emergence of new technologies (aimed at very high efficiencies or at very low manufacturing costs) in the course of this decade.

11.6.4.4 PV Systems and Systems Terminology

Complete PV systems consist of modules (also referred to as panels) that contain solar cells, and the so-called balance-of-systems (BOS). The BOS mainly comprises electronic components, cabling, support structures, and, if applicable, electricity storage, optics and sun trackers, and/or site preparation. The BOS costs also include labor costs for turnkey installation.

PV systems are often divided into grid-connected systems, whether integrated or ground-based, and stand-alone (or autonomous) systems. PV systems feeding into or connected to a mini-grid fall in between these categories.

Systems consist of modules that are electrically connected in series and/or in parallel. Modules connected in series are called a string. A number of strings connected in parallel are called an array or sub-array. A number of arrays that function together are called a system or subsystem. To be able to quantify the performance of grid-connected PV systems and to allow comparisons with other electricity-generating technologies, the following terms and definitions are helpful:

- **System power:** The nominal (nameplate, rated) power of PV cells, modules, and systems is expressed in watt-peak – the power produced under STC. The power of complete systems is often simply expressed as the sum of the powers of the individual modules that make up the systems, although the actual direct-current (DC) power of many modules connected in series and in parallel will never equal the sum of the individual powers.
- **Performance ratio:** The (dimensionless) Performance Ratio (PR) of a PV system is defined as the average alternating-current (AC) system efficiency divided by the STC module efficiency. The PR is usually taken as the average over a year. In the PR, the effects on efficiency of very different factors are taken together. Most important are module mismatch, cabling and inverter (DC/AC conversion) losses, and

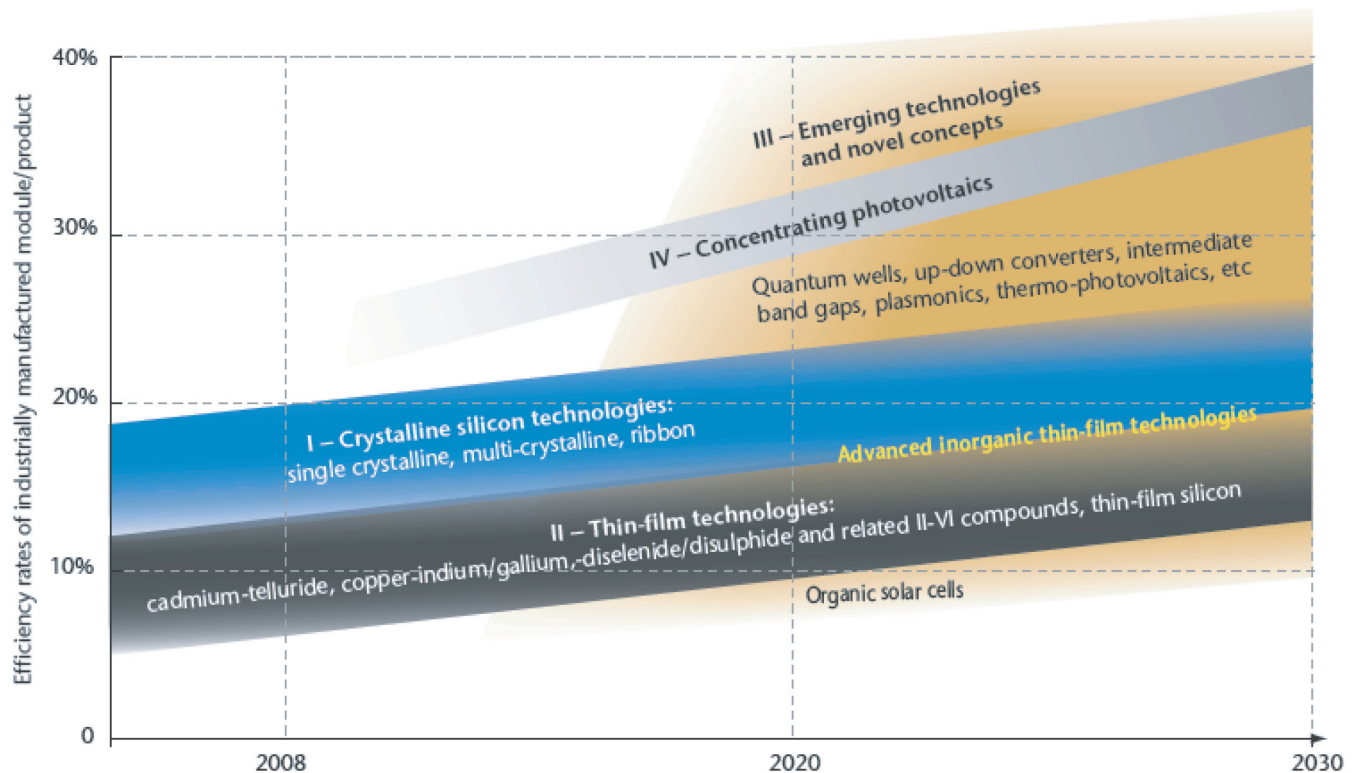

Figure 11.48 | State of the art and possible development of commercial PV module efficiencies. Source: IEA, 2010d. ©OECD/International Energy Agency 2011.

cell/module operating temperatures, as well as light intensities, light spectra, and angles of incidence that deviate from standard conditions. Also, system outages, if they occur, influence the PR. Typical PR values for recent well-functioning systems are in the range of 0.70–0.85 (IEA-PVPS, 2007). With improvements, the PR may have a modest upward potential to 0.9 ultimately.

- PV system performance in practice:** Extensive data on the performance of PV systems in different countries are collected in the framework of IEA-PVPS Task 2 (IEA-PVPS, 2007; Nordmann, 2008). From 1991 to 2005, the typical system PR improved significantly – from 0.64 to 0.74 – as a result of, among other reasons, higher inverter efficiencies and fewer and shorter system outages and more accurate module rating. This increase does not appear to be saturated yet. In 2005, the best systems had a PR in the range of 0.80 to 0.85.
- Capacity factor:** The (dimensionless) Capacity Factor (CF) of a PV system is determined by the insolation (in the plane of the modules) at the location of the system and the system PR. It is defined as $(N \times PR) / 8760$, in which 8760 is the number of hours in a year and N is the equivalent number of full-sun hours in a year. N is equivalent to the insolation (in kWh/m²/yr) divided by the intensity of full sun (1 kW/m²). It is noted that the numeric value of N is equal to the insolation, because on Earth, “full sun” can be defined as 1 kW/m². Taking the most relevant range of insolation values (in the plane of the modules) as 1000–2500 kWh/m²/yr and the range of PRs as 0.75–0.85, the global range of CFs becomes 0.08–0.21, with upward potential to 0.23. It is important to note that these values refer to systems without sun tracking. If tracking is applied, the CF of systems in high-insolation regions may ultimately reach values around 0.30. The CF is a particularly useful parameter when comparing different electricity generation technologies.
- Specific electricity yield:** The specific final AC electricity Yield (Y_f) of a system is defined as the annual AC electricity output of the system ($P \times N \times PR$) divided by the system power (P). The global range of Y_f values is 750 to 2100 kWh/kWp/yr, with upward potential to 2250 kWh/kWp/yr, excluding yield gains by sun tracking. With tracking, however, which is especially likely to be applied for all ground-based desert systems, Y_f could go up to almost 3000 kWh/kWp/yr.

Stand-alone systems (Luque, 2003) come in a wide variety of types and sizes (powers), ranging from mini systems integrated in consumer products with a typical power well below 1 Wp, through solar home systems for use in rural areas with a power in the order of 100 Wp, to larger systems for industrial use and village electrification above 1 kWp. They may also be combined with other electricity generators such as wind turbines in a hybrid system.

Although the market share of stand-alone systems is small and decreasing, their value for the user is often very high. This is because these systems are generally the user’s only source of electricity, and the

alternatives are either more expensive or less convenient. It is difficult to define a simple set of performance indicators as in the case of grid-connected systems. The performance of stand-alone systems, however, can also be measured in terms of their availability – that is, the fraction of time they are able to supply the electricity needed by the user.

11.6.5 Economic and Financial Aspects

Although PV modules are the most visible part of PV systems, the economics of PV obviously depends on the price and performance of complete, turnkey systems. The price of a turnkey PV system is the sum of the price of the modules and of the BOS; it also contains labor costs, such as those related to engineering and installation.

11.6.5.1 Module Price Development

The price evolution of PV modules can be described well by a price-experience or “learning” curve, in which the average selling price (ASP) is plotted on a double-logarithmic scale as a function of cumulative production (van Sark et al., 2008; Hoffmann et al., 2009). Figure 11.49 presents data for 1980–2008. The straight line indicates the price decrease as a fixed percentage for each doubling of the cumulative production (or shipments). The progress ratio is defined as 100% minus this percentage.

The figure shows that the ASP of crystalline silicon modules (the main technology in this period) decreased by about 20% for each doubling of the cumulatively shipped volume. The curve also shows the effect on prices of the temporary silicon feedstock shortage in the early 2000s, due to rapid market expansion. By 2010, prices had largely returned to the historic trend line, as the shortage had been solved. By December 2009, prices were falling below \$2/Wp in some instances (REN21, 2010). Note that the curve shows prices, not costs. The black dot in the figure shows that the price level for thin-film modules was comparable to that of crystalline silicon modules at its lowest point, albeit at a much lower cumulative production volume. This underscores the strength of thin-film technologies as low-cost options.

Although it is not possible to simply extrapolate the curve to higher cumulative production volumes (and thus, implicitly, into the future), the potential for further cost reductions by technology development and economies of scale is still substantial for both crystalline silicon (Sinke et al., 2009; Swanson, 2006) and thin-film technologies (Hoffmann et al., 2009).

11.6.5.2 Value of Higher Module Efficiency

Turnkey system prices of installed systems are a better indicator of the competitive position of PV than module prices as such. Because the BOS component of system prices consists of a power-related part (such as

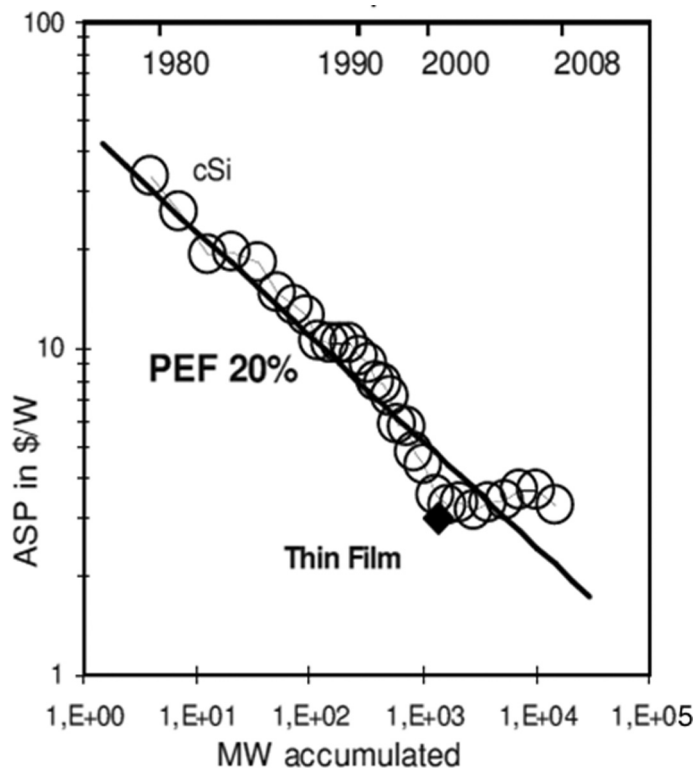

Figure 11.49 | PV module experience curves showing the average selling price (ASP) of modules in US₂₀₀₈\$ as a function of the cumulative module production. Note that the Progress Ratio (or PEF: Price Experience Factor) is about 20%. See text for further explanation of the curve. Source: Hoffmann et al., 2009.

the inverter) and an area-related part (such as the mounting or support structure), module efficiency has an influence on system price (US\$/Wp). This could be turned around to say that for an equal turnkey system price, higher efficiency modules are generally allowed to be somewhat more expensive than lower efficiency modules. For example, assume an area-related BOS price of US\$100/m² and a power-related BOS price of US\$0.50/Wp. Then a turnkey system price of US\$3/Wp may allow a module price of US\$1.50/Wp when the conversion efficiency of the module would be 10%, but US\$2/Wp when the module efficiency would be 20%. In this specific example, the “value” of 20% over 10% efficiency is thus US\$0.5/Wp.

11.6.5.3 PV System Price Development

System prices vary much more than module prices do because of the wide variety of system types and sizes, country-to-country differences in experience and installation practice, and other factors. For systems that can be compared, a European study has indicated that the BOS part of system prices may follow an experience curve with a progress ratio similar to that of modules, although the uncertainties are much larger (Schaeffer et al., 2004). Moreover, it is uncertain whether this trend can be maintained over the long term, because drastic possibilities for price reduction are perhaps less obvious for BOS than for modules. Therefore

Table 11.28 | Turnkey investment costs of PV systems and corresponding (rounded) levelized electricity generation costs for 2009, 2020, and 2050.

Typical Irradiation on Fixed Optimally Oriented Plane (kWh/m ² /yr)	Capacity Factor (and Corresponding Annual Yield in kWh/kWp)	Typical Turn-key Investment Costs (US ₂₀₀₅ \$/kWp)	Cost of Electricity (¢/kWh)	
			Discount rate	
			5%	10%
Current (2009)				
1000	9% (790)	4500 (typical range 3500–5000)	46.1	68.5
2000 / 1500 (without / with sun tracking)	18% (1580)		23.1	34.2
2300 (with sun tracking)	27% (2370)		15.4	22.8
2020				
1000	9% (790)	2000 (possible range < 1500–2500)	19.0	29.4
2000 / 1500 (without / with sun tracking)	18% (1580)		9.5	14.7
2300 (with sun tracking)	27% (2370)		6.3	9.8
Long-Term (2050)				
1000	9% (790)	900 (possible range ~ 700–1200)	8.6	13.2
2000 / 1500 (without / with sun tracking)	18% (1580)		4.3	6.6
2300 (with sun tracking)	27% (2370)		2.9	4.4

it has been argued that the progress ratio for BOS on the longer term may be 85% or 90%, rather than 80% as for modules.

The evolution of system prices is monitored by IEA-PVPS (see, e.g., IEA-PVPS, 2010). The 2009 turnkey system prices of larger grid-connected systems were roughly in the range of US₂₀₀₉\$3.5–7.5/Wp in major markets – with the lower end of the range being characteristic for systems installed in countries with a well-developed and competitive market. For off-grid systems this range was US₂₀₀₉\$7–22/Wp (IEA-PVPS, 2010).

Turnkey system price can be translated into electricity generation costs using the levelized cost of energy method. Although the calculation involved is rather straightforward (see, e.g., EPTP, 2010), it requires assumptions and estimates of parameters that may not be made in a straightforward manner. More precisely, in addition to the turnkey investment price, values are needed for the O&M costs (normally expressed as a percentage of the investment per year), system economic lifetime (depreciation/amortization period), cost of capital, and specific electricity yield (kWh per year per watt-peak of system power). However, it is difficult to “standardize” the parameters used in the calculation because they may vary substantially depending on, among other items, the type of technology and system, geographical location, and type of ownership.

Table 11.27 gives 2009 and (target) 2020 and long-term turnkey investment costs and corresponding levelized electricity generation costs.

Indicative turnkey investment costs (in mature markets), O&M costs, and depreciation times are taken from the IEA-PVPS *Trends Report* (IEA-PVPS, 2010) and IEA *PV Technology Roadmap* (IEA, 2010d). It is noted, however, that more aggressive cost reduction targets can also be found in the literature – see, for instance, the US DOE’s SunShot Initiative, which mentions a target of US\$1/Wp to be reached even before 2020 (US DOE, 2011b).

In Table 11.28, the capacity factor ranges indicated roughly correspond to low-, medium-, and high-insolation regions of the world, assuming a performance ratio of 80% and sun tracking for high-insolation regions. Gains of sun tracking are indicative and vary per region (see section 11.6.4.4 and Huld et al., 2008). In the calculations, annual O&M costs were assumed as 1% of the investment costs. The system lifetime assumed is 25 years in 2009, 30 years in 2020, and 40 years in 2050. Note that the table is primarily meant to show trends and typical numbers; in practice, other figures are found (IEA-PVPS, 2010).

11.6.5.4 Grid and Investment Parity

PV will gradually reach various levels of competitiveness (IEA, 2010d; Greenpeace and EPIA, 2008; Breyer, 2010). (See Figure 11.50.) For grid-connected systems, which compete with electricity from the grid, these levels are usually referred to as “grid parity” (e.g., with consumer

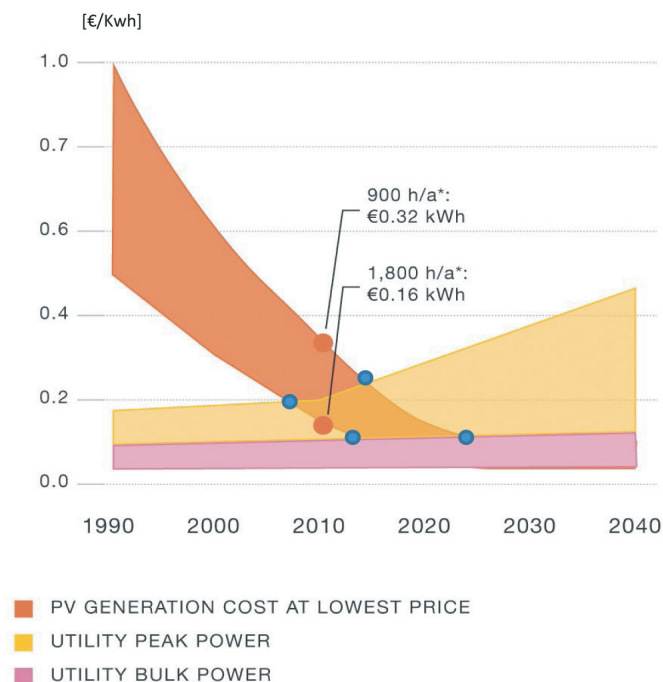

Figure 11.50 | Schematic representation of grid parity points (in blue, see text). *h/a: Hours of sun per annum, 900 h/a corresponds to northern countries of Europe. 1800 h/a corresponds to southern countries of Europe. Source: European Photovoltaic Industry Association/Greenpeace International, 2011.

prices and wholesale prices respectively). The concept of “grid parity” is based on a comparison of LCOE and electricity prices in a specific year. The concept of grid parity does not take into account the expected increase of conventional electricity prices; therefore “investment parity” or “dynamic grid parity” has been proposed (EPIA, 2009) as a more useful concept in relation to decision-making. In this case, the life-cycle costs of PV electricity generation are compared with the anticipated total value of avoided electricity purchase and revenues of sales over the relevant period (such as 15, 20, or 25 years).

Note that in the direct comparison between PV generation costs and electricity prices, other costs and benefits are not taken into account. Specifically, the comparison does not take into account costs for grid transport, backup power, or storage (even though these need not be attributed exclusively to PV). Nor does it take into account benefits such as avoided carbon dioxide emissions and (passive or active) grid support. Therefore, the point of grid parity is useful only as a rough indicator of the competitive position of PV.

11.6.6 Sustainability Issues

PV technology may inherently be renewable, but it is not automatically sustainable. The sustainability of PV systems depends on, among other considerations, equivalent CO₂ emissions, the use of hazardous and non-Earth-abundant elements and materials, and possibilities

for recycling. The equivalent CO₂ emissions are related to the energy needed for manufacturing and installation (often expressed in terms of the energy payback time) and the fuel mix for generation of electricity used in PV manufacturing.

To date, most attention has focused on the energy payback time of PV systems and the equivalent CO₂ emissions of PV electricity generation. Figure 11.51 shows the energy payback time of PV technologies (including recycling) when applied in reasonably sunny regions (in-plane irradiation of 1700 kWh/m²/yr) (De Wild-Scholten, 2010). Energy payback times are all well below 2 years and even below 1.5 years for thin-film technologies, which is to be compared with a service lifetime of PV systems of 25 years or more. The energy payback times are expected to decrease further substantially as the technology develops (EPTP, 2009).

The equivalent CO₂ emissions per kWh produced with PV electricity are 16 gCO₂-eq/kWh at an in-plane insolation of 1700 kWh/m²/yr for the best current PV systems (de Wild-Scholten, 2010). Based on a review of life-cycle analysis studies, Arvizu et al. (2011) conclude that “the majority of lifecycle GHG emission estimates cluster between about 30–80 gCO₂-eq/kWh.” It is expected that this value may be reduced to 10 g or less, along with shortening of the energy payback time and transformations in the energy system, decreasing the indirect emissions (Reich et al., 2011). These values refer to equivalent emissions directly related to the PV plants. High degrees of penetration of PV necessitate modifications on a system level (e.g., adding backup power, small- or large-scale storage, smart grids) to accommodate the power generated by PV. These modifications may lead to increased – or, in specific cases, decreased – overall emissions.

Recently, the rapidly increasing production volumes and high prices of a wide range of materials have drawn attention to the use of non-Earth-abundant elements such as silver, indium, and tellurium in PV cells and modules. Multi-gigawatt-scale or even terawatt-scale manufacturing of specific PV technologies is only possible at very low cost when materials constraint can be avoided. This has led to research on alternatives for active and passive parts of PV cells and modules. Examples are copper- and carbon-based conductors instead of silver in wafer-silicon cells and zinc-tin instead of indium in the light absorber of CIGS modules.

For many years, there has been a debate about the use of hazardous materials in PV modules, particularly Cadmium telluride (CdTe). CdTe is the biggest thin-film PV technology in the market today, and take-back and recycling systems have been developed and implemented. Moreover, CdTe is a very stable compound. Therefore, it has been argued that CdTe can be used in a safe and sustainable way (Raugei, 2010).

Companies in the PV sector joined forces in 2007 and founded the PV Cycle Association. It aims to “implement the photovoltaic industry’s commitment to set up a voluntary take back and recycling program for

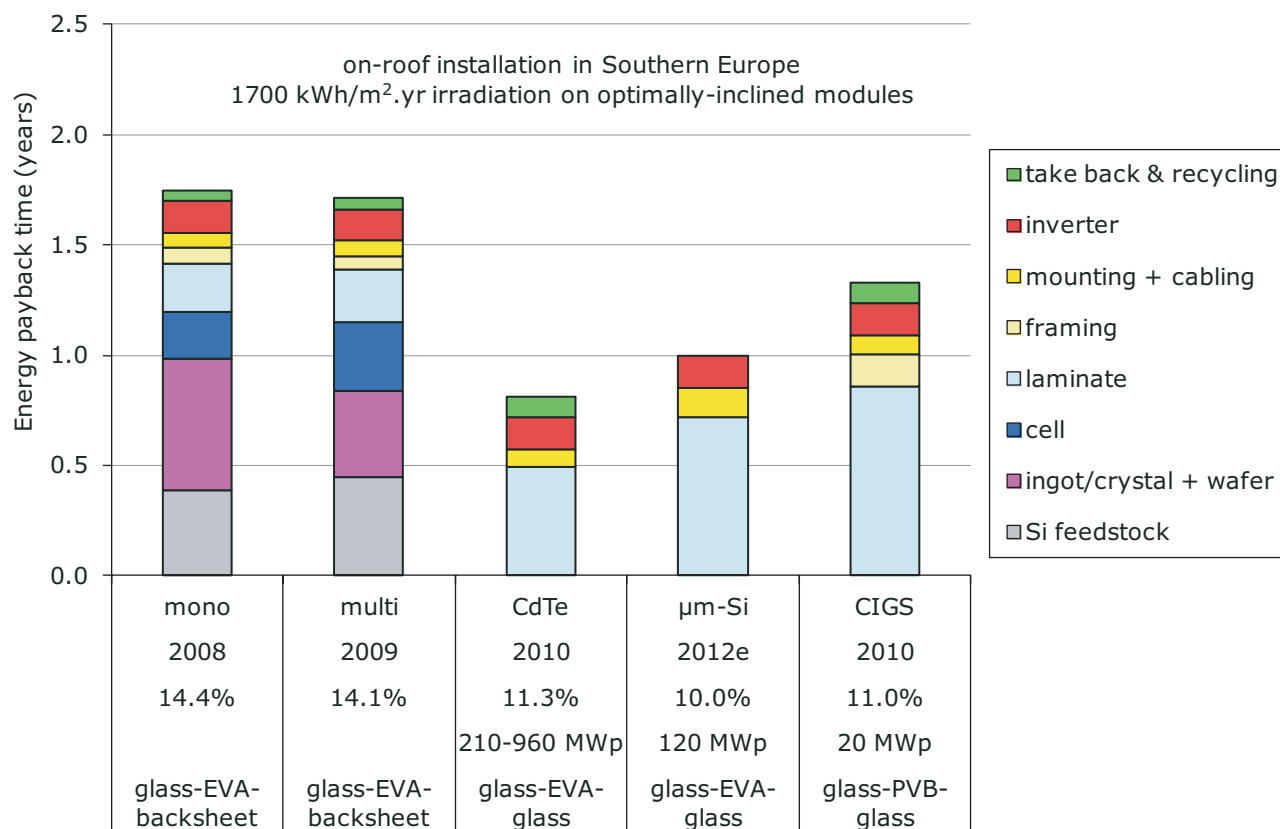

Figure 11.51 | Energy payback time (EPBT) of on-roof PV systems for an in-plane irradiation of 1700 kWh/m²/yr. Source: de Wild-Scholten, 2011.

end-of-life-modules and to take responsibility for PV modules throughout their entire value chain” (PV Cycle, undated). In 2010, there were about 40 full members.

11.6.7 Implementation Issues

The main issues to be addressed in relation to very large-scale deployment of PV are the cost of electricity generation and grid integration. In the long term, materials availability also needs to be considered. In addition, a range of less fundamental issues to be addressed include the development of dedicated products for building integration and standardization.

The cost of electricity is generally considered to be the key driver for PV deployment, but grid integration is certainly a key enabler (FVEE, 2010). Grid integration is not a problem today, with the exception of some local constraints. However, ambitious deployment scenarios may bring PV into the regime where grid adaptations are necessary (Braun, 2009). The framework of the Grand Solar Plan (Fthenakis et al., 2009) in the United States illustrates how very large volumes may be integrated into the electricity system by choosing a portfolio approach—in particular, by combining PV with concentrating solar power and compressed air energy storage.

Large-scale deployment of PV, and thus high levels of penetration into the grids, requires sufficient grid flexibility to enable integration of the varying output of PV systems and to provide the backup power needed when the sun does not shine. This can be achieved by introducing a proper portfolio approach – that is, combining PV with other generators such as wind energy, biomass, natural-gas-fired plants, and hydropower – and demand-side management (FVEE, 2010). In addition, storage will become important on small and large scales (including, for instance, the capacity available in electric vehicles) and for different time scales (day-night; summer-winter).

11.7 High-Temperature Solar Thermal Energy

11.7.1 Introduction

High-temperature solar thermal technologies, also referred to as concentrating solar thermal, use mirrors that reflect and concentrate sunlight onto receivers. The receivers convert the solar energy to thermal energy, which is used in a steam turbine or heat engine to drive an electric generator. These concentrating solar power (CSP) systems might also allow the production of chemical fuels for transportation, storage, and industrial processes (Meier and Steinfeld, 2010). CSP systems perform best in regions having a high direct-normal component of solar radiation.

Table 11.29 | Potential growth of cumulative CSP capacities until 2050

Name of Scenario and Year	Installed CSP Capacity [GW _e]				
	2000	2015	2020	2030	2050
CSP Global Outlook 2009 (Reference scenario)	0.35	4	7	13	18
CSP Global Outlook 2009 (Moderate Scenario)	0.35	24	69	231	831
CSP Global Outlook 2009 (Advanced Scenario)	0.35	29	84	342	1524
IEA Reference Scenario (2008)	0.35	N.A.	N.A.	< 10	N.A. (but competitive)
IEA ACT Map (2008)	0.35	N.A.	N.A.	250	380
IEA BLUE Map (2008)	0.35	N.A.	N.A.	250	630

Source: IEA, 2008; Greenpeace et al., 2009.

The primary advantage of CSP is its potential for integrating thermal storage, which would allow dispatchable power generation. Dispatchable CSP electricity can have a higher value than variable renewable energy technologies (Madaeni et al., 2011). The four main types of CSP systems are parabolic trough, power tower, dish/engine, and linear Fresnel reflector. Systems that use concentrators to focus sunlight onto high-efficiency solar cells for utility-scale electricity generation are discussed in section 11.6.

11.7.2 Potential of High-Temperature Solar Thermal Energy

CSP requires significant levels of direct-normal irradiance, which generally occurs in semiarid areas between 15° and 40° north or south latitude. Closer to the equator the humidity is generally too high, and at higher-latitude regions there is usually too much cloud cover. A threshold of 1800–2000 kWh/m²/yr is often considered suitable for CSP development. The regions with the best resource potential are the Mediterranean, North Africa, Middle East, South Africa, portions of southern Asia, Australia, Chile, the southwestern United States, and Mexico.

By the end of 2010, more than 1.1 GW of grid-connected CSP plants were installed worldwide, generating 2.9 TWh of electricity a year (REN21, 2011). The installed capacity in 2009 was 610 MW, generating 1.6 TWh a year.

The *Global CSP Outlook 2009* – developed jointly by SolarPACES, the European Solar Thermal Electricity Association, and Greenpeace International – used an advanced industry development scenario, with high levels of energy efficiency, to project future electricity demands. The study estimates that CSP could meet up to 7% of the world's power needs by 2030 and 25% by 2050. The global CSP capacity for 2050 could be 1500 GW with annual energy output of 7800 TWh. More moderate

assumptions for future market development put combined solar power capacity at around 830 GW by 2050, with annual deployments of 41 GW. This would meet 3.0–3.6% of global electricity demand in 2030 and 8.5–11.8% in 2050 (Greenpeace et al., 2009).

A recent analysis of CSP potential in the United States projects capacity of 11,000 GW in Arizona, California, Colorado, Nevada, New Mexico, Texas, and Utah by 2030 (Mehos et al., 2009). Another study projects up to 30 GW of parabolic trough systems with thermal storage could be deployed in this region by 2030 (Blair et al., 2006). Capacity in the Middle East and North Africa is projected to be 390 GW by 2050 by the German Aerospace Center. That study concludes that with the high capacity factors resulting from integration of CSP with thermal storage, this capacity could provide about half this region's electricity (German Aerospace Institute, 2005). The trends and potential for CSP capacities from recent studies are shown in Tables 11.29 and 11.30.

In 2010, IEA published a technology roadmap for CSP, which foresees a potential generation of 4000 TWh in 2050, contributing 10% to global electricity production (IEA, 2010e). CSP electricity production and consumption predicted in the roadmap is shown in Figure 11.52. The roadmap authors expect North America to be the largest producing region, followed by Africa, India, and the Middle East. Africa would be by far the largest exporter of electricity, and Europe the largest importer. The Middle East and North Africa considered together, however, would produce almost as much electricity as the United States and Mexico (IEA, 2010e).

11.7.3 Market Developments

The number of CSP plants built or planned each year has increased since 2004. The size of new plants has increased from several megawatts to hundreds of megawatts. By the close of 2010, CSP generation was able to meet intermediate-load demand, particularly in plants that have thermal energy storage. As the amount of storage increases, CSP could become cost-competitive in the base-load electricity market if the generation cost of conventional fossil base-load technologies includes a carbon cost.

Between 1985 and 1991, about 354 MW of solar parabolic trough technology were deployed in southern California, and most of these plants are still in commercial operation. CSP technology is most economically viable in large-scale installations. In the 1990s, world energy prices dropped and remained relatively low. Low prices and the lack of incentives discouraged additional large installations.

The emerging demand for cuts in GHG emissions, as well as the need to decrease dependence on fossil fuels, may improve the market outlook for CSP. Worldwide, interest in CSP is increasing in the United States, Spain, and the Middle East-North Africa. Figure 11.53 shows the development of CSP from 1985 to 2008 and the estimated CSP project pipeline, by country, for 2009–2014.

Table 11.30 | Potential growth of electricity generated by CSP until 2050.

Name of Scenario and Year	Electricity production by CSP [TWh/yr]				
	2000	2010	2020	2030	2050
IEA Reference Scenario (2008)	N.A.	N.A.	N.A.	< 15	25
IEA ACT Map (2008)	N.A.	N.A.	N.A.	625	890
IEA BLUE Map (2008)	N.A.	N.A.	N.A.	810	2080
Shell (Scramble)	N.A.	N.A.	110	1450	5220
Shell (Blueprints)	N.A.	56	390	1220	4110
Greenpeace Reference Scenario (2010)	0.63	5	38	121	254
Greenpeace Revolution Scenario (2010)	0.63	9	321	1447	5917
Greenpeace Advanced Scenario (2010)	0.63	9	689	2734	9012

Source: IEA, 2008; Shell, 2008; Greenpeace and EREC, 2007.

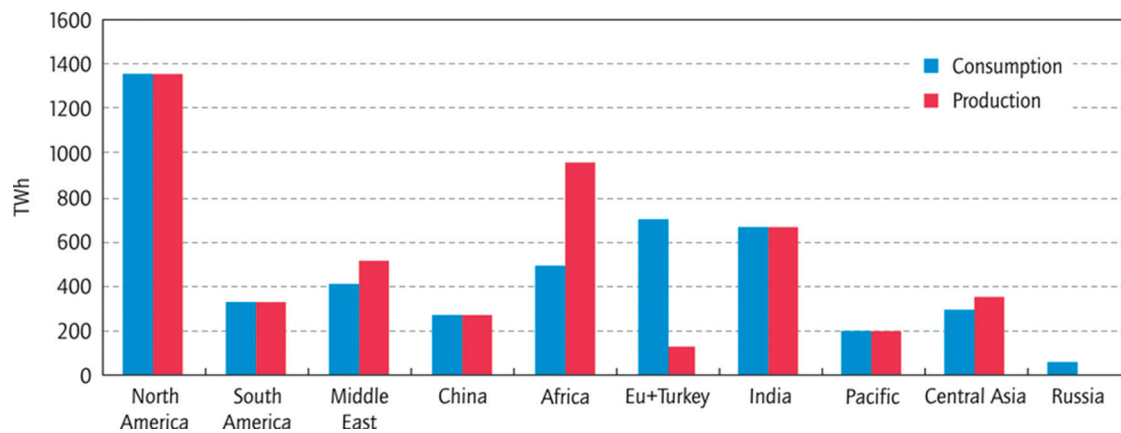

Figure 11.52 | Possible production and consumption of CSP electricity in 2050. Source: IEA, 2010e. ©OECD/International Energy Agency 2010.

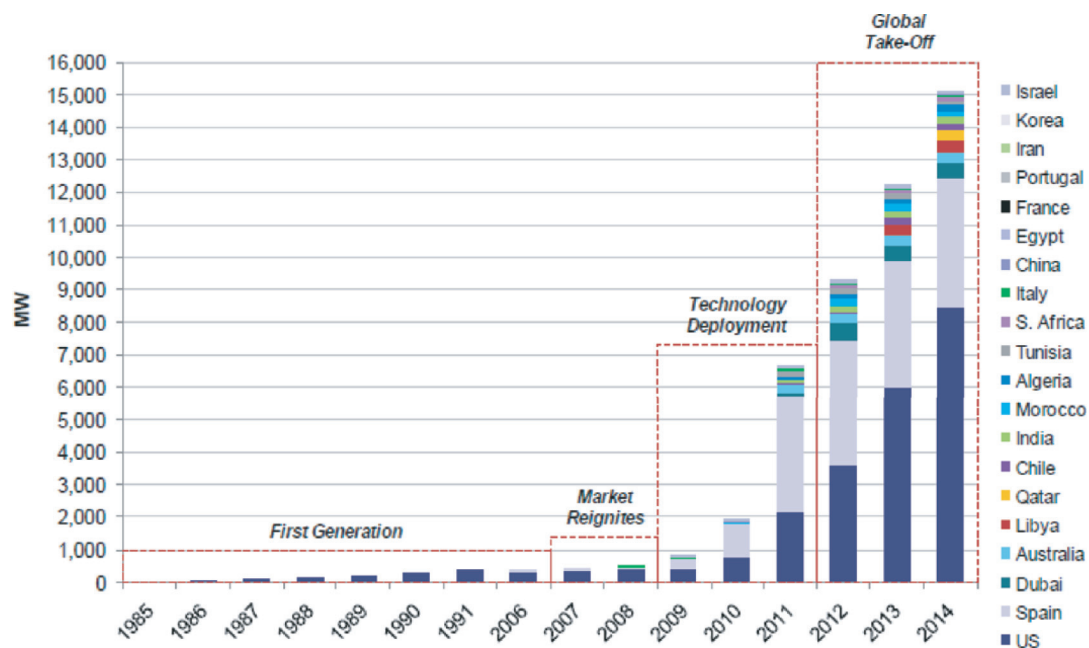

Figure 11.53 | CSP development, 1985–2008, project pipeline by country, 2009–2014. Source: IHS EER, 2009.

Table 11.31 | CSP plants in operation, under construction, and under development in the United States, end of 2010.

Technology	Capacity Operational		Capacity Under Construction		Capacity Under Development	
	MWe	# projects	MWe	# projects	MWe	# projects
Trough	496	14	5	1	5406	19
Tower	5	1	392	3	2545	10
Dish/engine	2	1			964	5
Linear Fresnel	5	1	2	1	231	3
Total	508	17	399	5	9146	37

Source: EIA, 2011.

Table 11.32 | CSP plants in operation, under construction, and under development in Europe, Asia, and North Africa, end of 2010.

Technology	Capacity Operational		Capacity Under Construction		Capacity Under Development	
	MWe	# projects	MWe	# projects	MWe	# projects
Trough	617	11	810	15	2911	60
Tower	34	4	2214	5	250	6
Dish/engine			986	2	181	9
Linear Fresnel	4	2	33	2	190	7
Total	655	17	4043	24	3532	82

Source: GTM Research, 2011.

At the end of 2010, most of the 1.1 GW of grid-connected CSP plants worldwide used parabolic trough technology (about 39 MW used power-tower technology). Tables 11.31 and 11.32 provide details about these plants in the United States, Europe, Asia, and North Africa. The tables also show that more than 100 CSP projects were in the planning phase at the close of 2010. Contracts specify when the projects must start delivering electricity between 2010 and 2014.

In the United States, 500 MW of CSP were in operation at the end of 2010, with more than 9 GW on hold with signed power purchase agreements. A 64 MW parabolic trough plant came online in 2007 in Nevada, and a 75 MW plant began operating in 2010 in Florida. A 5 MW power tower and a 5 MW Linear Fresnel project came online in 2009 in California. The US federal solar investment tax credit, which allows developers and utilities to offset 30% of plant costs, was extended through the end of 2016. Companies may use a 30% federal grant in lieu of the tax credit and can also apply for a federally backed loan guarantee. These policies are expected to stimulate plans for and construction of CSP plants in the United States in the next several years.

In Europe, Asia, and North Africa, about 655 MW were in operation at the end of 2010, and more than 7 GW of CSP capacity were under construction or are being developed over the next several years. In Spain, more than 400 MW of commercial CSP projects were operational, and about 2000 MW have provisional registration. Spanish Royal Decree 436/2004 (dated 12 March 2004) guaranteed a FIT of €0.27/kWh for 25 years. In the *Plan de Energías Renovables en España* (2005 to 2010), a total

capacity of 500 MW was foreseen. Royal Decree 661/2007 raised the cap to 500 MW and allowed the tariff to float, adjusting with the market price. In response, developers in Spain have identified projects well beyond the 500 MW cap, and the government must reassess the number of projects to support. Recent projects in Spain include the 11 MW PS10 power tower plant in 2007, the 20 MW PS20 tower in 2009, and the 50 MW parabolic trough system, with 7.5 hours of storage, in 2008. Several additional plants came online in 2009 and 2010.

Since 2000, the CSP industry grew from a negligible activity to one that has more than 1400 MW of generation commissioned or under construction in 2009 worldwide. In 2006, two or three companies were in a position to build for commercial-scale plants. In 2009, more than 10 companies were active in building or preparing for such plants. These companies range from large organizations with international construction and project management expertise who have acquired rights to specific technologies to start-up companies using their own technology (IHS EER, 2009; Arvizu et al, 2011).

The CSP industry provides employment in countries with growing capacities. About 50–60% of the cost of CSP projects is for equipment leading to manufacturing jobs (Stoddard et al., 2006). In the United States, the National Renewable Energy Laboratory (NREL) estimates that realizing 4000 MW of CSP would require domestic investment of US\$13 billion. Such an investment would create 145,000 jobs in construction and engineering and 3000 direct permanent jobs for operation and maintenance (Stoddard et al., 2006). Similar numbers would be likely in other regions of the world.

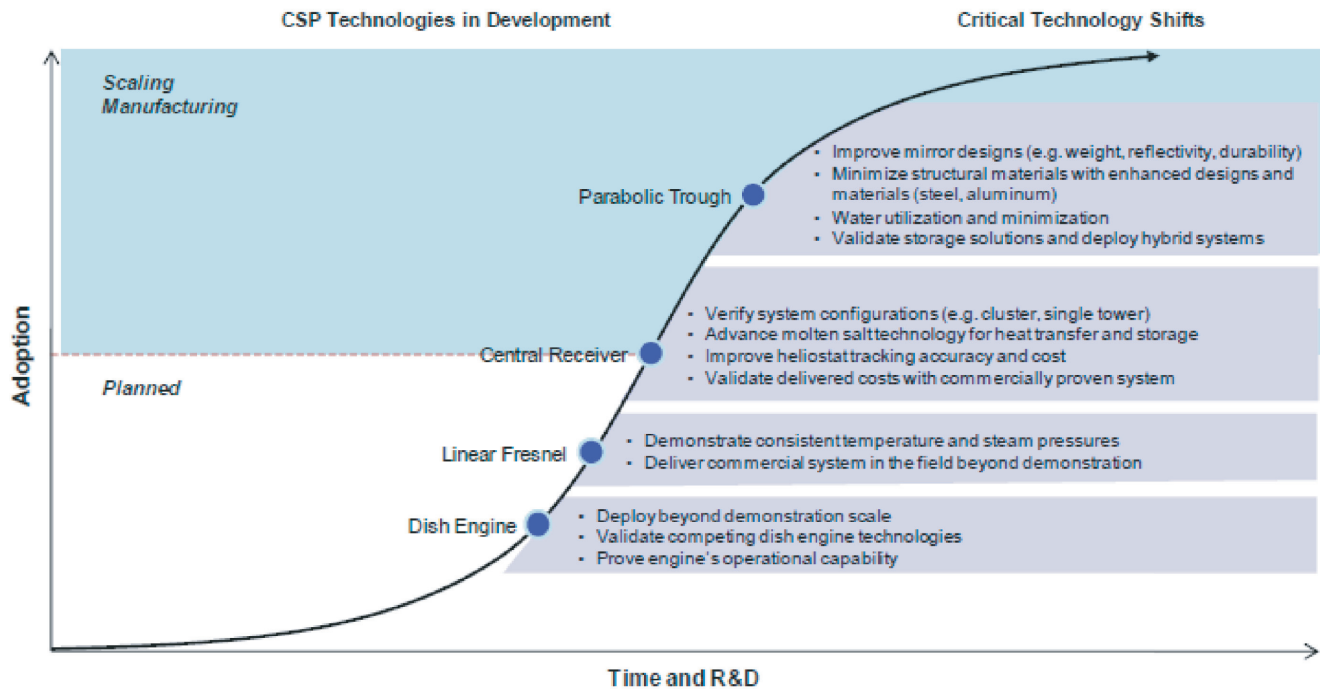

Figure 11.54 | CSP technology curve and evolutionary changes. Source: IHS EER, 2009.

11.7.4 CSP Technology Development

Four main CSP technologies, with different levels of maturity, are discussed in this section (Sargent and Lundy, 2009). (See Figure 11.54.)

11.7.4.1 Status of CSP technologies

A *parabolic trough system* has long parallel rows of trough-like reflectors – typically, glass mirrors. Controllers make the reflectors follow the sun as it moves from east to west by rotating them along their axes. Each trough focuses the sun's energy on a thermal receiver or heat-collection element located along its focal line. A heat-transfer fluid – typically oil at temperatures as high as 390°C – is circulated through the heat-collection element. Then the hot fluid is pumped to a central power-block area, where it passes through a series of heat exchangers. Superheated steam is created at 370°C and 100 bar. Once past the steam generator, parabolic trough plants behave just like conventional steam plants. The steam is used to drive a conventional steam-Rankine turbine generator, and the plant can store heat or use additional heat from fossil fuels to generate electricity when the sun is not shining. The annual solar-to-electric efficiency of parabolic trough plants is approximately 15%, a figure that includes losses due to non-normal solar incidence, part-load operation, and plant availability throughout the year.

The first commercial trough/oil CSP plants were installed and commissioned between 1985 and 1991 in the United States. Nine plants with a combined 354 MW capacity were built by Luz, and they continue

operation with new owners. In 2007, the next commercial plant was built and owned by Acciona. This 64 MW Nevada Solar One uses aluminum rather than steel troughs.

With the increasing interest in CSP construction, strong competition is emerging among companies in the supply chain for components and construction. However, in 2010 only Schott and Solel were capable of supplying several 100 MW/yr of the large evacuated tubes (heat-collection elements) designed specifically for use in trough/oil systems for power generation (Arvizu et al., 2011). The trough concentrator requires know-how in both structure and thermally sagged glass mirrors. Companies are offering new trough designs and considering alternatives to conventional rear-silvered glass (such as new polymer-based reflective films). But the essential technology remains unchanged (Arvizu et al., 2011).

Commercial systems today are limited by the maximum operating temperature of the heat-transfer fluid – synthetic oil with a maximum temperature of 390°C. Direct steam generation in troughs may allow trough systems to operate at higher temperatures, and this concept is being demonstrated. In other designs, molten salt has the potential advantage of operating at higher temperatures than steam systems and allows for integration with direct two-tank salt storage systems similar to those used for molten-salt tower configurations. In 2010, the Italian utility ENEA began operating a small prototype molten salt trough plant in Sicily. A disadvantage of this concept is the potential for the salt freezing in the solar field and the need to design a system to recover from such an event.



Figure 11.55 | PS10 and PS20 power towers in Spain (left) and a power tower solar thermal power plant in the California desert (right). Source: Left photo courtesy of Abengoa Solar.

In a *power tower system* (also called a central-receiver system), a field of two-axis tracking mirrors, called heliostats, reflect solar energy onto a receiver mounted on a central tower. (See Figure 11.55.) To maintain the beam of concentrated sunlight on the receiver at all times, each heliostat must track a position in the sky that is midway between the receiver and the sun. A heat-transfer fluid heated in the receiver is used to generate steam that runs a conventional turbine to generate electricity. Some power towers use water and steam directly as the heat transfer fluid. Central-receiver systems typically operate at higher temperatures than parabolic troughs, with superheated steam temperatures of 550°C for proposed steam and molten-salt systems. As with parabolic troughs, central-receiver systems can be integrated with thermal storage; the amount of storage available depends on the heat transfer fluid used in the receiver. Direct-steam receivers offer limited storage capacities, typically less than one hour, due to the high costs associated with storing high-temperature steam.

Power tower systems based on molten-salt receivers integrated with thermal storage have been demonstrated on the pilot scale. Because molten-salt receivers have superior heat-transfer and energy-storage capabilities, annual efficiencies are projected to be higher than for oil-based parabolic trough systems. In early 2011, a commercial unit was under construction in Spain, and several commercial units were under development in the United States.

Power tower systems are just entering the market on a commercial scale, and this should open the way for new industry participants and a diversity of system designs. Primary design choices include the heliostat (1m² to >100m²), receiver (cavity or external), and heat transfer fluid type (steam, molten salt, or air). The high concentration of solar energy associated with tower systems allows heat transfer fluid operating temperatures as high as 1000°C, as for example in the air heat-transfer fluids for solar Brayton cycles. So far, there is little consensus on the best

approach for achieving low cost, high performance, and high market value in power tower systems.

A *dish/engine system* tracks the sun and focuses solar energy into a cavity receiver; the receiver absorbs the energy and transfers it to the heat engine/generator that generates electric power. Dish/engine systems have demonstrated peak efficiencies greater than 30%, and the projected annual conversion efficiency is 24% (Arvizu et al., 2011). Effort is going into developing a commercial product using Stirling engines as the power-conversion device, although Brayton engines are also an alternative. The technology may be able to take advantage of existing know-how such as on the Stirling engine mass-produced through the automotive industry.

A *linear Fresnel reflector (LFR) system* uses a series of flat or shallow-curvature mirrors to focus light onto a linear receiver located at the focal point of the mirror array. Linear Fresnel systems could have lower capital cost than systems with parabolic mirrors because the mirrors are flat and located close to the ground. But they have also lower operating efficiencies than parabolic trough systems (Häberle et al., 2002). Because no large-scale commercial Fresnel-based systems are in operation at present, it is unclear whether the lower upfront capital cost will offset the efficiency problem.

Research on Linear Fresnel reflector systems has used steam as the heat-transfer fluid. A significant disadvantage of steam-based systems is their current incompatibility with long-term (>1 hour) thermal storage. The US DOE (US DOE 2008b) is supporting development of a linear Fresnel reflector system that uses molten salt as a heat-transfer fluid. As with parabolic troughs, the freezing of the salt in the field is still a primary concern. However, unlike parabolic trough systems, the linear Fresnel reflector receiver is stationary, so engineering freeze protection should be much more straightforward.



Figure 11.56 | Two-tank molten-salt indirect storage system at the 50 MW Andasol 1 parabolic trough plant in Spain. Source: Photo courtesy of Solar Millennium.

11.7.4.2 Thermal Storage

Thermal storage is an important attribute of CSP. Even 30 minutes to 1 hour of full-load storage can reduce the impact of thermal transients (such as clouds) on the plant and of electrical transients to the grid. Thermal storage can result in significantly higher energy and capacity value over equivalent systems without storage.

Spain is the first country to incorporate thermal storage into commercial installations. Parabolic trough plants such as Andasol 1 in Spain have been designed for 7.5 hours of full-load storage. This allows operation well into the evening, when peak demand can occur and tariffs are high. Several parabolic trough plants in Spain use molten-salt storage. (See Figure 11.56) Depending on the electricity market, storage can be increased up to 16 hours to allow 24-hour-a-day electricity generation.

Power towers operate at high temperatures and can charge and store molten salt more efficiently and less expensively than other CSP systems. The 17 MW GEMASOLAR power tower being developed in Spain is designed to operate 6500 hours a year – a 74% capacity factor. A 100 MW plant in Nevada in the southwest United States with 10 hours of molten-salt thermal storage has a signed power purchase agreement.

With thermal storage, the heat from the solar field is stored prior to reaching the turbine. Storage media include molten salt, steam accumulators (for short-term storage only), solid ceramic particles, high-temperature phase-change materials, graphite, and high-temperature concrete (Gil et al., 2010; Medrano et al., 2010). Figure 11.57 shows that thermal storage allows the CSP plant to dispatch power to meet demand after sunset.

Significant R&D is under way to develop thermal storage technologies that are compatible with the steam-based heat-transfer fluids for power tower, parabolic trough, and linear Fresnel systems. Storage systems

using phase-change materials are more thermodynamically compatible with the latent energy associated with evaporation and condensation of steam. The intrinsic nature of phase-change systems results in decreased storage volumes, thereby reducing materials costs.

11.7.4.3 Power Cycles

In general, thermodynamic cycles will perform more efficiently at higher temperatures. The solar collectors providing the thermal energy must perform efficiently at these higher temperatures. Development to optimize the linkage between solar collectors and higher-temperature thermodynamic cycles is under way (Arvizu et al., 2011). The most commonly used power block is the steam turbine (Rankine cycle), which is most efficient and cost-effective in large capacities. Parabolic trough plants using oil as the heat-transfer fluid limit steam-turbine temperatures to 370°C and turbine cycle efficiencies to around 37%. This leads to design-point solar-to-electric efficiencies of 24% and annual average efficiency of 15% (Arvizu et al., 2011). To increase efficiency, alternatives to using oil as the heat transfer fluid – such as producing steam directly in the receiver or using molten salts – are being developed for parabolic troughs. Power towers and dishes/engine systems can reach the upper limits of existing fluids (around 600°C for current molten salts) for advanced steam-turbine cycles. Power towers can also provide the temperatures needed for higher-efficiency cycles (Arvizu et al., 2011).

11.7.4.4 Solar Thermal Hydrogen Production

The global use of hydrogen, mainly as feedstock in industrial processes, was estimated to be around 5 EJ/yr in 2004 (IEA, 2005). In 2050, in a carbon-constrained world, the demand for hydrogen as an energy carrier might be as large as 11–44 EJ/yr (IEA, 2008b; European Commission, 2006). It would be used in the transport sector and for stationary applications. High-temperature solar thermal energy can be used in several ways to produce the hydrogen (see, for example, Pregger et al., 2009).

One commercially available route is splitting water molecules into hydrogen and oxygen using electricity from a CSP plant: $2\text{H}_2\text{O} \rightarrow 2\text{H}_2 + \text{O}_2$. Another approach, solar thermal high-temperature electrolysis, splits water into pure oxygen and hydrogen at about 700–1000°C. Splitting water is possible using very high temperature heat (2300–2600°C) produced by solar power towers. Yet another option is cracking methane using solar heat: $\text{CH}_4 \rightarrow \text{C} + 2\text{H}_2$. Solar heat (1200–2000°C) can also be used to assist in steam reforming methane: $\text{CH}_4 + \text{H}_2\text{O} \rightarrow \text{CO} + 3\text{H}_2$, followed by a water-gas shift reaction: $\text{CO} + \text{H}_2\text{O} \rightarrow \text{CO}_2 + \text{H}_2$. The hydrogen can be blended with natural gas in existing pipelines and distribution networks. Capture and storage of the CO_2 (see Chapter 13) can be applied to largely prevent its emission into the atmosphere. According to the IEA-CSP roadmap, this technology will be used in the Middle East, Central Asia, and the US Southwest starting in 2030 (IEA, 2010e).

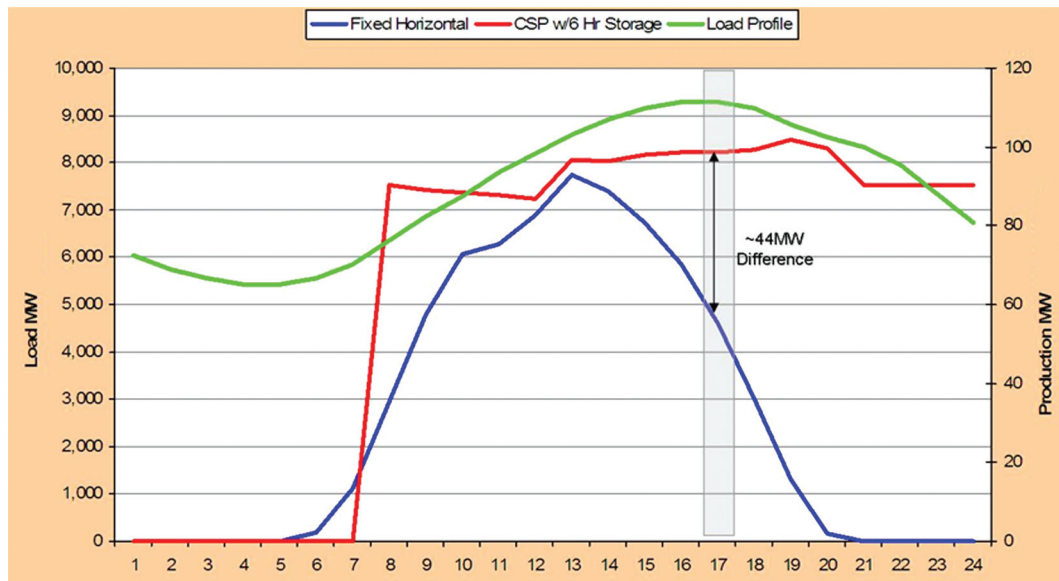

Figure 11.57 | Customer load profile (green) and power production profile of a CSP system with storage (red) and a non-tracking PV system (blue) over 24 hours. Source: Courtesy of Arizona Public Service.

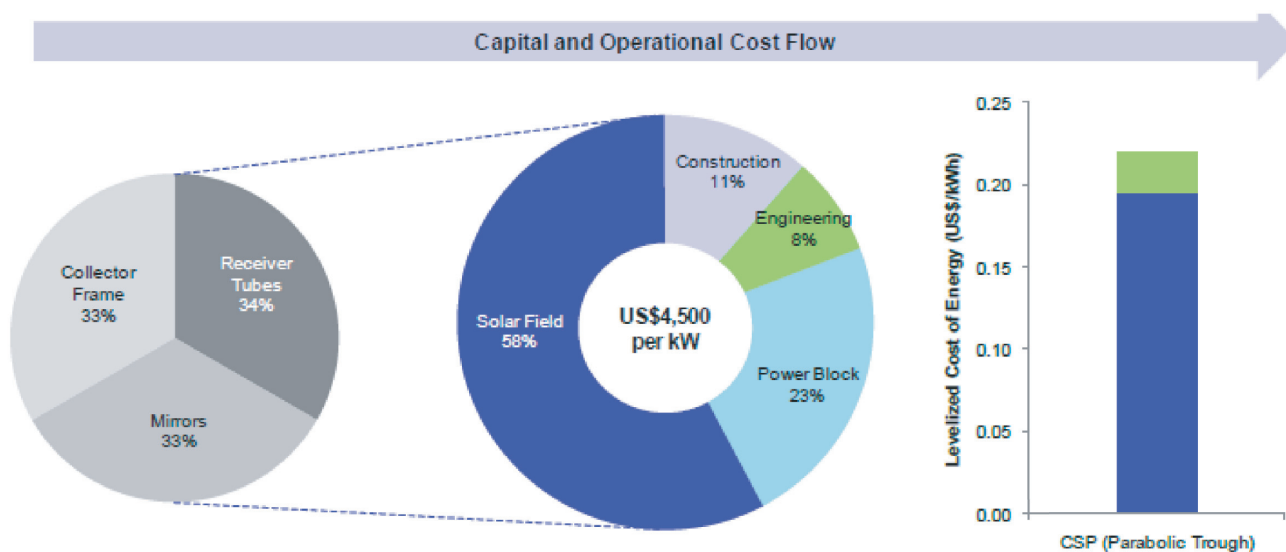

Figure 11.58 | Capital cost breakdown for parabolic trough plant. Source: IHS EER, 2009.

Thermo-chemical production of hydrogen is in the early development stages. An example is the Solzinc process, developed in Israel, using solar heat at a temperature above 1200°C to decompose zinc oxide. The zinc is subsequently combined with water and transformed back to zinc oxide, producing hydrogen: $Zn + H_2O \rightarrow ZnO + H_2$.

Because of the high costs involved and the current high conversion losses (cumulative up to 80–90%), R&D is needed to substantially improve the performance and competitiveness of solar hydrogen systems. Hydrogen production using fossil fuels is expected to remain the cheapest hydrogen source until at least 2030 (Pregger et al., 2009).

11.7.5 Economic and Financial Aspects

CSP must compete with electricity generation rates in utility markets rather than end-use electricity rates in residential or commercial markets. The levelized cost of energy for a CSP plant is calculated using the plant’s upfront capital costs and its projected operating and maintenance costs, annual generation of electricity, finances, and lifetime.

In 2007, the installed cost of the 64 MW Nevada Solar One plant was US\$260 million. The installed costs for parabolic trough CSP plants were US\$4200/kW for a 100 MW system without thermal storage and

US\$4900/kW for the same system with six hours of thermal storage. O&M fees for the system have been estimated at US¢1–3/kWh or more (US DOE, 2010a; IEA, 2010e).

An analysis by Lazard (2009) of CSP capital costs shows a range from US\$4500–6300/kW, with parabolic troughs representing the low end and power towers representing the high end. In the IEA's technology roadmap (IEA, 2010e), the estimated capital costs range from US\$4200–8400/kW. A breakdown of the estimated capital cost is presented in Figure 11.58. Land costs generally add less than 3%.

In 2010, the cost of installing a 100 MW CSP parabolic trough plant was estimated at US\$4900/kW for a system without thermal storage and US\$8400/kW for the same system with six hours of thermal storage (Turchi, 2010). The increased cost projected for current plants is primarily due to an increase in raw material costs (such as steel, concrete, and sodium/potassium nitrate salts) that occurred prior to the worldwide economic downturn at the end of 2007. Since 2008, costs have remained relatively steady, although a global recovery would likely put upward pressure on material costs.

The levelized cost of energy can be calculated from the estimated installation and O&M costs. The LCOE presented here assumes little or no storage, a capacity factor of 30–40%, a discount rate of 5% and 10%, an economic lifetime of 30 years, and average O&M costs of US¢2/kWh. The LCOE ranges from US¢10–20/kWh if total investment costs were US\$4500/kW and from US¢15–30/kWh for investments of US\$7000/kW. (See Table 11.33.) Similar LCOE figures were found for systems with 12-hour heat storage.

A recent analysis supported by the US DOE projected cost reductions for parabolic troughs based on advances in collector design, economies of scale for larger plants, and the use of molten salt as the heat transfer fluid. The capital cost for a trough system with 12 hours of storage is projected to be US\$6500/kW in 2020. The same study projected a capital cost for an advanced tower system with 12 hours of storage to be US\$5900/kW in 2025 (Turchi, 2010). The lowest energy cost in the long-term may be US¢5–7/kWh. This would result from technical learning, material improvements, and increased system performance (see, for example, IEA, 2010e).

11.7.6 Sustainability Issues

The environmental impacts of CSP considered here include land use, water use, and environmental emissions, and they depend on the technology used. Solar thermal power plants require relatively large areas of land – up to 8 km² for a 250 MW plant with six hours of storage. The acreage is often in desert regions, where plant construction and operation may affect sensitive habitats (Pregger et al., 2009).

CSP plants use a continuous supply of water for steam generation, cooling, and cleaning the solar mirrors. For Rankine cycle systems, a water

Table 11.33 | Cost of electricity as a function of capacity factor, turnkey investment costs, discount rate, and O&M costs. The O&M costs are assumed to be US¢2/kWh; the lifetime is assumed to be 30 years.

Capacity factor	Present turnkey investment costs per kW _e (without storage)	Discount rate	
		5%	10%
	US ₂₀₀₅ \$	US¢/kWh	
40%	4500	10.3	15.6
	7000	15.0	23.2
30%	4500	13.1	20.2
	7000	19.3	30.2
Capacity factor	Future turnkey investment costs per kW _e (with 12 hour storage)	Discount rate	
		5%	10%
	US ₂₀₀₅ \$	US¢/kWh	
65%	8000	11.2	16.9
	10,000	13.4	20.6
50%	8000	13.9	21.3
	10,000	16.8	26.2

source for cooling is desirable to achieve higher turbine efficiencies. Where water is limited, air cooling or a combination of wet/dry hybrid cooling can eliminate up to 90% of the water usage (Kutscher, 2009). Such approaches for steam-generating CSP plants reduce electricity produced by 2–10%, depending on geographic location, electricity pricing, and water costs. Dry cooling performs least efficiently during the summer months, when solar energy is most abundant and when the plants should have the greatest output to meet the higher electricity demand (WorleyParsons Group, 2009).

Most environmental emissions from CSP plants occur during the manufacturing of plant components that are produced with fossil fuels. Compared with the life-cycle emissions of fossil-fueled power plants, CSP power plants generate significantly lower levels of greenhouse gases and other emissions (Pehnt, 2006). Studies conducted by NREL concluded that a 4000 MW solar power plant could offset 300 tons of nitrogen oxide, 180 tons of carbon monoxide, and 7.6 million tons of carbon dioxide (Western Governors' Association, 2006; also cf. Greenpeace et al., 2009). Another study by NREL provides a life-cycle assessment indicating that a reference 100 MW parabolic trough plant with six hours of storage would generate GHG emissions estimated at 26 gCO₂-eq/kWh (Burkhardt et al., 2010). In life-cycle studies, several assumptions have to be made, such as the fuel mix in the power sector. Consequently, somewhat lower figures can be found in the literature. The indicated reference plant would also cumulatively demand 0.43 MJ/kWh of energy and consume 4.7 L/kWh of water.

According to the IPCC Special Report on *Renewable Energy Sources and Climate Change Mitigation*, most estimates of life-cycle GHG emissions fall between 14–32 gCO₂-eq/kWh for parabolic trough,

power tower, dish/engine, and linear Fresnel reflector systems, whereas the energy payback time of CSP systems can be as low as five months (Arvizu et al., 2011). According to the *CSP Global Outlook 2009* (Greenpeace et al., 2009) results presented in Table 11.29, the moderate scenario will provide annual savings of 148 million metric tonnes of CO₂ in 2020, rising to 2.1 gigatonnes (Gt) annually by 2050. The cumulative savings would account for about 0.6 GtCO₂ by 2020 and 28 Gt by 2050.

11.7.7 Implementation Issues

The barriers and challenges to implementation include issues related to cost, land access, water use, transmission of electricity, system integration, and policy development.

11.7.7.1 Land Access

Land generally represents a minor portion of the cost of the whole CSP plant. However, aesthetic and environmental issues may cause a “not in my backyard” response to news of potential CSP development. When seeking to acquire private or public lands, developers may encounter difficulties such as high costs and permitting delays.

A 100 MW CSP plant would require 200–400 hectares, depending on the technology and the degree of storage integrated into the plant. The land should ideally have less than a 1% grade and no more than a 2% grade, particularly for parabolic trough and linear Fresnel reflector systems. Land for development must be near transmission lines and roads and should not be in an environmentally sensitive area. Although the mirror area covers only 25–35% of the land, the arid nature of a solar plant site will mean it is not suitable for other agricultural pursuits (Arvizu et al., 2011).

11.7.7.2 Transmission

Utility-scale CSP plants (50–300 MW_e) must be linked to the transmission network, so developing the grid infrastructure is critical to the widespread implementation of CSP.

North European countries are studying the installation of long transmission lines to get power from CSP plants in Southern Europe and North Africa. The DESERTEC Foundation has proposed using solar thermal power plants throughout the Sahara Desert to send power to Europe via a super grid running from Iceland to the Arabian Peninsula and from the Baltic Sea to the west coast of Africa (DESERTEC Foundation, 2011). (See Figure 11.59.)

In the United States, the Energy Policy Act of 2005 directed DOE to analyze the state of transmission capacity across the country and to identify

areas requiring improvements. In the southwestern and western United States, many power lines operate at or near capacity, and bringing the power from remote locations to cities can be difficult. After conducting several studies to determine the impact of renewable on the US power transmission system, DOE concluded it was in the national interest to create an energy highway to allow power to travel more easily from the West Coast to the East Coast. In October 2007, DOE designated two national transmission corridors as the first step to a national power transmission system. The solar industry petitioned the Federal Energy Regulatory Commission (FERC) to clear any transmission bottlenecks to “greening the grid.” In late July 2008, FERC granted the California Independent System Operator Corporation (a nonprofit organization charged with managing the flow of electricity in California’s wholesale power grid) the ability to open the grid to renewable energy in California.

11.7.7.3 System Integration

CSP can be combined with fossil fuel or biomass plants in so-called integrated solar combined cycle plants to conserve fuel at relatively low cost. These plants are being built in Algeria, Australia, Egypt, Iran, Italy, and the United States (IEA, 2010e). Solar-augment of existing fossil power plants offers a lower-cost and lower-risk alternative to stand-alone CSP plant construction. A recent study found the potential in the southern half of the United States for over 11 GW_e of parabolic trough and over 21 GW_e of power tower capacity that could be added to coal-fired and natural gas combined-cycle plants whether existing, under construction, or planned (Turchi et al., 2011).

Combined with storage, CSP can enhance the reliability of power production and even offer base-load capacity. Consequently, CSP can contribute to grid flexibility and accommodate a larger share of variable energy sources in electricity systems. Losses in thermal storage cycles are much smaller than in other existing electricity storage technologies, such as pumped hydro and batteries (IEA, 2010e).

11.7.7.4 Policies

A number of countries are subsidizing R&D to increase the performance of CSP and reduce costs. Policy measures such as tax credits, emission trading schemes, and feed-in-tariffs help to create markets for CSP and achieve cost competitiveness. In recent years Spain has been the most active market in CSP development as a result of Royal Decrees enacted in 2004 and 2007 offering long-term and profitable FITs for solar thermal electricity. By contrast, the US market is driven primarily by Renewable Portfolio Standards, which require utilities to purchase a specified fraction of electricity generation from renewable energy facilities – sometimes with a specific “set-aside” requiring generation from solar. Combined with attractive federal tax incentives for solar installations, the United States represents a burgeoning near-term CSP market (see also Section 11.12).

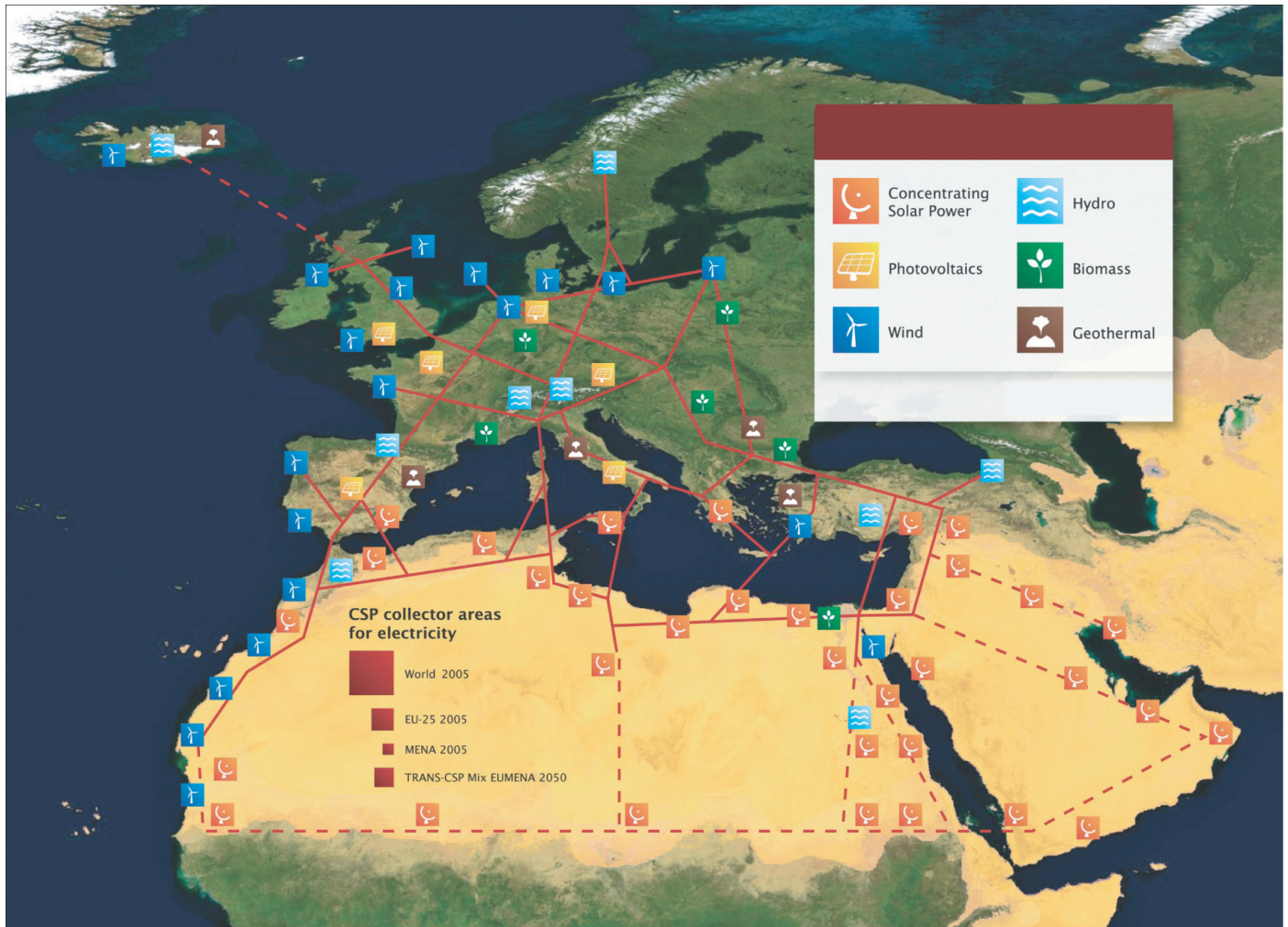

Figure 11.59 | Super grid envisioned by DESERTEC to bring power from the Middle East and North Africa to population centers throughout the region and in Europe. Source: DESERTEC Foundation, 2010.

11.8 Low-Temperature Solar Energy

11.8.1 Introduction

Low-temperature solar energy technologies, with operating temperatures up to 100° C, are perhaps the simplest way to use solar resources. These systems can be active or passive. In active conversion systems, heat from a solar collector is transported to the end process by a heat transfer system. In passive systems, no active components are needed to use the solar resource for heating or lighting (UNDP et al., 2000). This section is focused mainly on active systems that convert sunlight to thermal energy for water heating, space heating, space cooling, cooking, and crop drying.

11.8.2 Potential of Low-Temperature Solar Energy

Solar thermal energy use varies greatly by country and region depending on the maturity of the market, policy incentives, and available solar

resource. The total installed capacity has been estimated at 152 GW_{th} in 2008 and 180 GW_{th} in 2009 (Weiss and Mauthner, 2010; REN21, 2010). Table 11.34 provides a breakdown for different countries for 2008. China has the most capacity, with 87.5 GW_{th}, followed by Europe (28.5 GW_{th}), the United States and Canada (15.1 GW_{th}), and Japan (4.4 GW_{th}). The energy yield from solar collectors in 2008 worldwide was about 110 TWh_{th} (395 PJ) (Weiss and Mauthner, 2010), and in 2009 it was about 130 TWh_{th} (470 PJ) – saving about 0.5 EJ of primary fossil fuel consumption.

Figure 11.60 shows solar heating capacity in 2008 and the types of collectors used in the 10 leading countries. China, the world leader in total capacity, uses more evacuated tube liquid collectors than any other country. The United States uses a high percentage of unglazed liquid collectors (for solar pool heating). Australia also uses many unglazed collectors, whereas glazed liquid collectors are the leading technology in other countries.

IEA developed an energy scenario in which energy-related CO₂ emissions in 2050 are 50% below today's level. In this scenario, called BLUE MAP, world solar thermal capacity growth is 8%/yr (IEA, 2010a). This trend

Table 11.34 | Total low-temperature solar heating capacity in operation, end of 2008.

Region ^a	Water collector ^b (GW _{th})			Air collector ^c (GW _{th})		Total (GW _{th})
	Unglazed	Glazed	Evacuated tube	Unglazed	Glazed	
NAM	12.9	1.5	0.4	0.1	0.1	15.1
- United States	12.4	1.5	0.4	<0.05	0.1	14.4
- Canada	0.5	<0.05	<0.05	0.1	<0.05	0.7
WEU	1.6	24.4	1.1	0.6	<0.05	27.8
- Germany	0.5	6.5	0.7	-	<0.05	7.8
- Turkey	-	7.4	-	-	-	7.4
- Austria	0.4	2.3	<0.05	-	-	2.8
- Greece	-	2.7	-	-	-	2.7
- France	<0.05	1.2	<0.05	-	-	1.3
- Spain	<0.05	1.0	<0.05	-	-	1.1
- Switzerland	0.1	0.4	<0.05	0.6	-	1.1
- Cyprus	-	0.6	<0.05	-	-	0.6
- Netherlands	0.3	0.2	-	-	-	0.5
EEU	<0.05	0.6	<0.05	<0.05	<0.05	0.7
FSU	-	<0.05	-	-	-	<0.05
PAO	2.9	5.5	0.1	-	0.3	8.7
- Japan	-	4.0	0.1	-	0.3	4.4
- Australia	2.9	1.4	<0.05	-	-	4.3
CPA	-	7.2	80.3	-	-	87.5
- China	-	7.2	80.3	-	-	87.5
SAS	-	1.8	<0.05	-	<0.05	1.8
- India	-	1.8	<0.05	-	<0.05	1.8
PAS	<0.05	2.2	<0.05	-	-	2.2
- Taiwan	<0.05	1.2	<0.05	-	-	1.2
- Korea	-	1.0	-	-	-	1.0
MEA	<0.05	3.3	0.2	<0.05	-	3.5
- Israel	<0.05	2.6	-	<0.05	-	2.7
- Jordan	-	0.4	0.2	-	-	0.6
LAC	0.9	2.8	-	-	-	3.7
- Brazil	0.6	2.4	-	-	-	3.0
- Mexico	0.3	0.4	-	-	-	0.7
AFR	0.5	0.2	<0.05	-	-	0.7
- South Africa	0.5	0.2	<0.05	-	-	0.7
Total	18.8	49.5	82.3	0.7	0.5	151.9

^a Includes only countries with installed capacity of at least 0.5 GW_{th}.

^b If no data given, no reliable database is available.

^c Unglazed air collector in Switzerland is a simple site-built system for drying hay.

Source: based on data from Weiss and Mauthner, 2010.

would result in about 4000 GW_{th} installed capacity by 2050. Assuming an average capacity factor of 8%, solar thermal systems would yield 2800 TWh_{th} a year (10 EJ a year). Since 2004, the actual increase in capacity has been 19%/yr.

In the United States alone, the technical potential of solar water heating (SWH) has been estimated at 300 TWh_{th} (about 1 EJ) of primary energy savings per year, equivalent to an annual CO₂ emissions reduction of 50–75 million metric tons. For US consumers, this could save more than US\$8 billion per year in retail energy costs. Natural gas is used to heat a large fraction of hot water in the United States. It is used directly in gas water heaters or indirectly in electric water heaters,

where the electricity is generated using natural gas as the marginal fuel (Denholm, 2007).

In Europe, the European Solar Thermal Technology Platform formulated a target that in the long term 50% of the heating demand should be covered by solar thermal, while accounting for 100% of the heating and cooling demands in new buildings (ESTTP, 2008).

Low-temperature solar heat is also considered an excellent option for crop drying. Its low, even temperatures do not harm delicate foods and are as effective as fired heating methods. Solar crop drying can be used for coffee, tea, beans, rice, fruit, cocoa, spices, rubber, and timber.

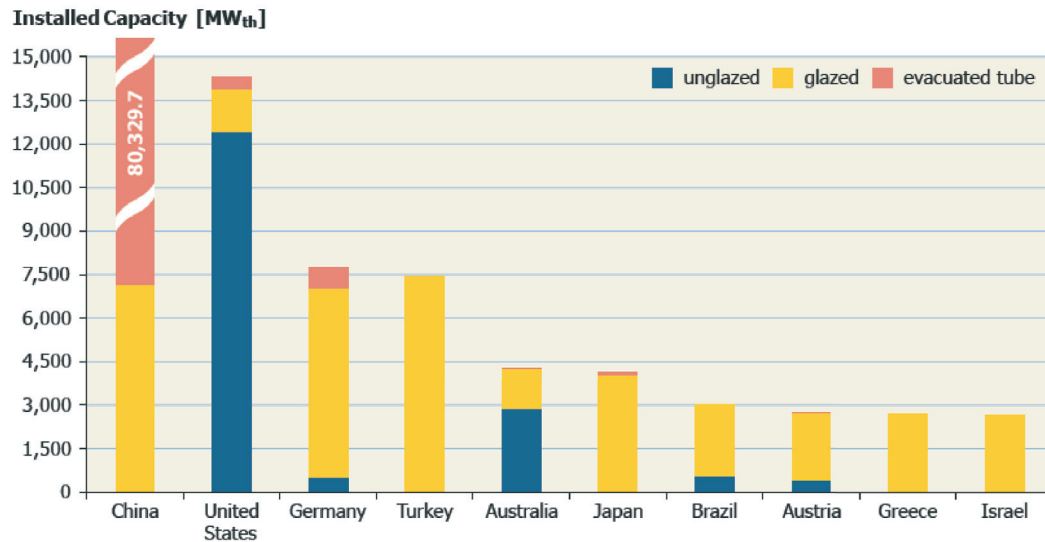

Figure 11.60 | Total capacity of solar collectors, 2008, in top 10 countries. Source: Weiss and Mauthner, 2010.

Expanding its use could displace between 300 and 900 PJ annually. This estimate is based on displacing fuel-fired dryers for crops operating at temperatures below 50°C. The use of solar energy for these markets is largely undeveloped (IEA-SHC, 2009).

In 2004, the organization Solar Cookers International ranked India, China, Pakistan, Ethiopia, and Nigeria as countries with the highest potential for solar cooking. The study considered annual solar radiation, the percentage of the country with forests, estimated populations in 2020, and the estimated share of the population within each country with both good solar insolation and fuel scarcity. In India, 80 concentrating systems of different capacities cover 25,000 m² of dish area. The world's largest system, at Shirdi, cooks food for 20,000 people every day (Solar Cookers International, 2009).

11.8.3 Market Developments

Since the early 1990s the solar thermal energy market has been growing. Installed capacity of flat plate and evacuated collectors increased by about a factor of four from 2000 to 2008. (See Figure 11.61.) China is the world's largest market today.

In 2008, 29 GW_{th} (41.5 million m²) of solar collectors were installed worldwide. The average annual increase between 2004 and 2008 was 19%, but between 2007 and 2008 the increase was 43%. Some markets for glazed collectors (flat-plate and evacuated tube collectors) in Europe had growth of 62% in one year. In the United States and Canada, growth was nearly 42%, and in Australia and New Zealand, nearly 40%. New installations in China increased in 2008 by about 35%.

By the end of 2008, nearly 217 million m² of collector area were in operation in the 53 countries tracked by the IEA (Weiss and Mauthner, 2010).

These countries represent about 61% of the world's population. The installed capacity in these countries represents an estimated 85–90% of the solar thermal market worldwide. Note that 217 million m² is equivalent to the installed capacity of 152 GW_{th} already mentioned, using an average conversion factor of 0.7 kW_{th}/m².

In China, Europe, and Japan, flat-plate and evacuated tube collectors are used mainly to provide hot water and space heating, while in the United States and Canada, swimming pool heating with unglazed polymer collectors is the dominant application.

Solar water heating offers the least-cost option in certain locales. This is the case in China, which is experiencing a boom in sales of these systems.

Figure 11.62 shows the regional distribution of glazed flat-plate and evacuated tube liquid low-temperature solar energy systems at the end of 2008. Most systems produce domestic hot water for single and multi-family houses. Only in Europe do combination systems for solar space heating and water heating account for a measureable number of low-temperature solar energy applications.

Although growing fast, especially in Europe, the market for solar cooling systems is still small. The IEA Solar Heating and Cooling Program has identified over 450 solar cooling systems in Europe and 30 in North America (Wiemken, 2009).

The most glazed flat-plate and evacuated tube collectors are found in Cyprus (527 kW_{th} per 1000 inhabitants), followed by Israel (371), Austria (285), Greece (253), Barbados (203) and Jordan (102) (Weiss und Mauthner, 2010). Currently, glazed flat-plate collector manufacturers are producing about 27 million m² of solar collectors per year (Epp, 2009).

Annually Installed Capacity [MW_{th}/a]

Figure 11.61 | Annual installed capacity of flat-plate and evacuated tube collectors, 2000–2008, total and per region. Source: Weiss and Mauthner, 2010.

The IEA Solar Heating and Cooling Programme has identified promising applications and sectors for solar heat in industrial processes as follows (Vannoni et al., 2008):

- cleaning, primarily in food processes, but also for process equipment and metal treatment plants (galvanizing, anodizing, and painting);
- commercial laundries;
- car washes;
- drying requirements after cleaning in both the food and chemical industries;
- pasteurization and sterilization for the food and biochemistry sectors; and
- preheating of boiler feed water.

Local sourcing, local jobs, and local sales are hallmarks of low-temperature solar technologies. According to detailed country reports for 2007, production, installation, and maintenance of solar thermal plants created 200,000 jobs worldwide (Weiss and Mauthner, 2010).

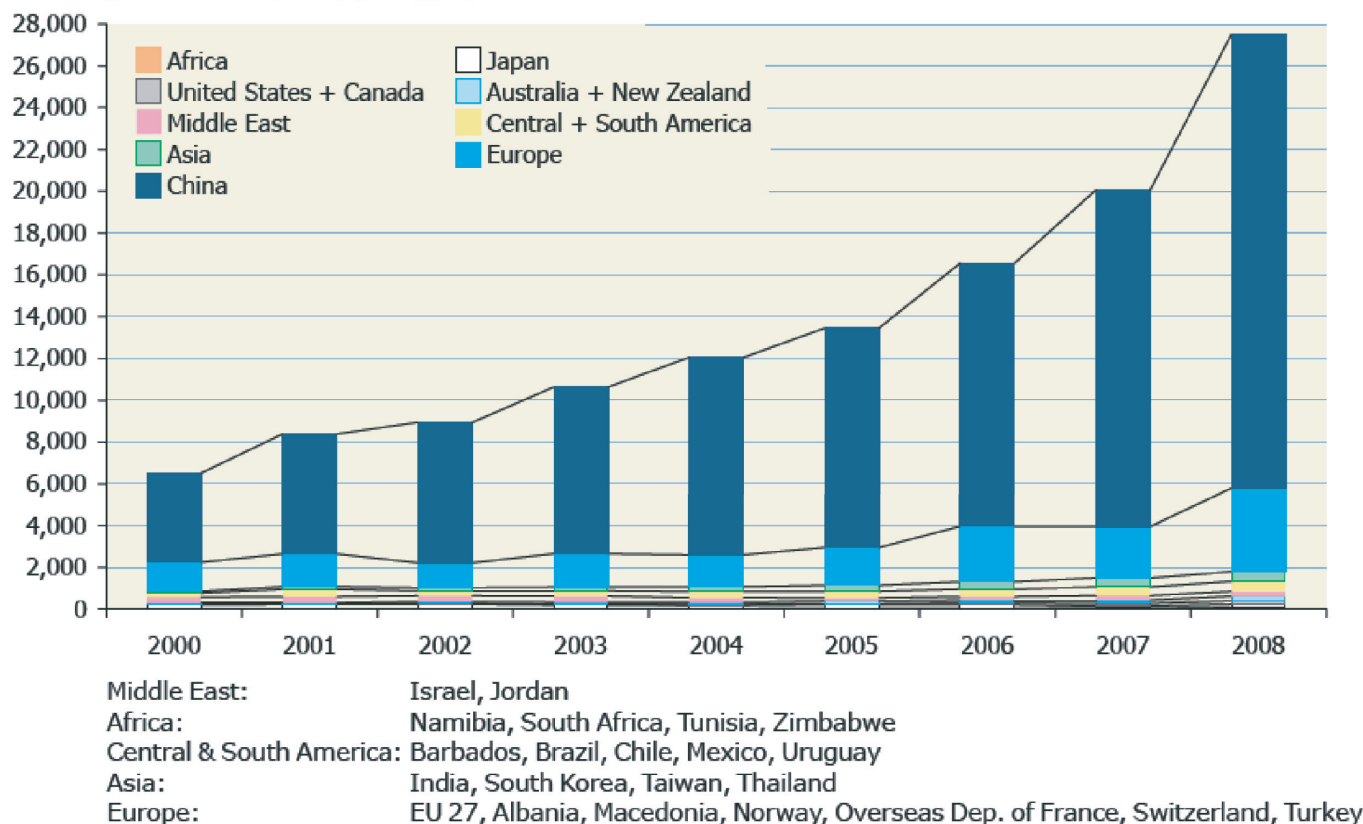
11.8.4 Low-temperature Solar Energy Technology Development

The working temperature ranges for the active solar thermal technologies used for water heating, space heating, space cooling, pool heating, crop drying, and cooking and the typical types of solar collectors used in these application are shown in Figure 11.63 (For concentrating technologies to generate high-temperature heat, see section 11.7.)

Most active solar energy technologies have four basic components:

- Solar thermal collector(s) – flat-plate and evacuated tube collectors are the most typical
- Storage system – in order to meet the thermal energy demand when solar radiation is not available
- Heat transfer system – piping and valves for liquids and ducts and dampers for air; pumps, fans, and heat exchangers, if necessary
- Control system – to manage the collection, storage, and distribution of thermal energy.

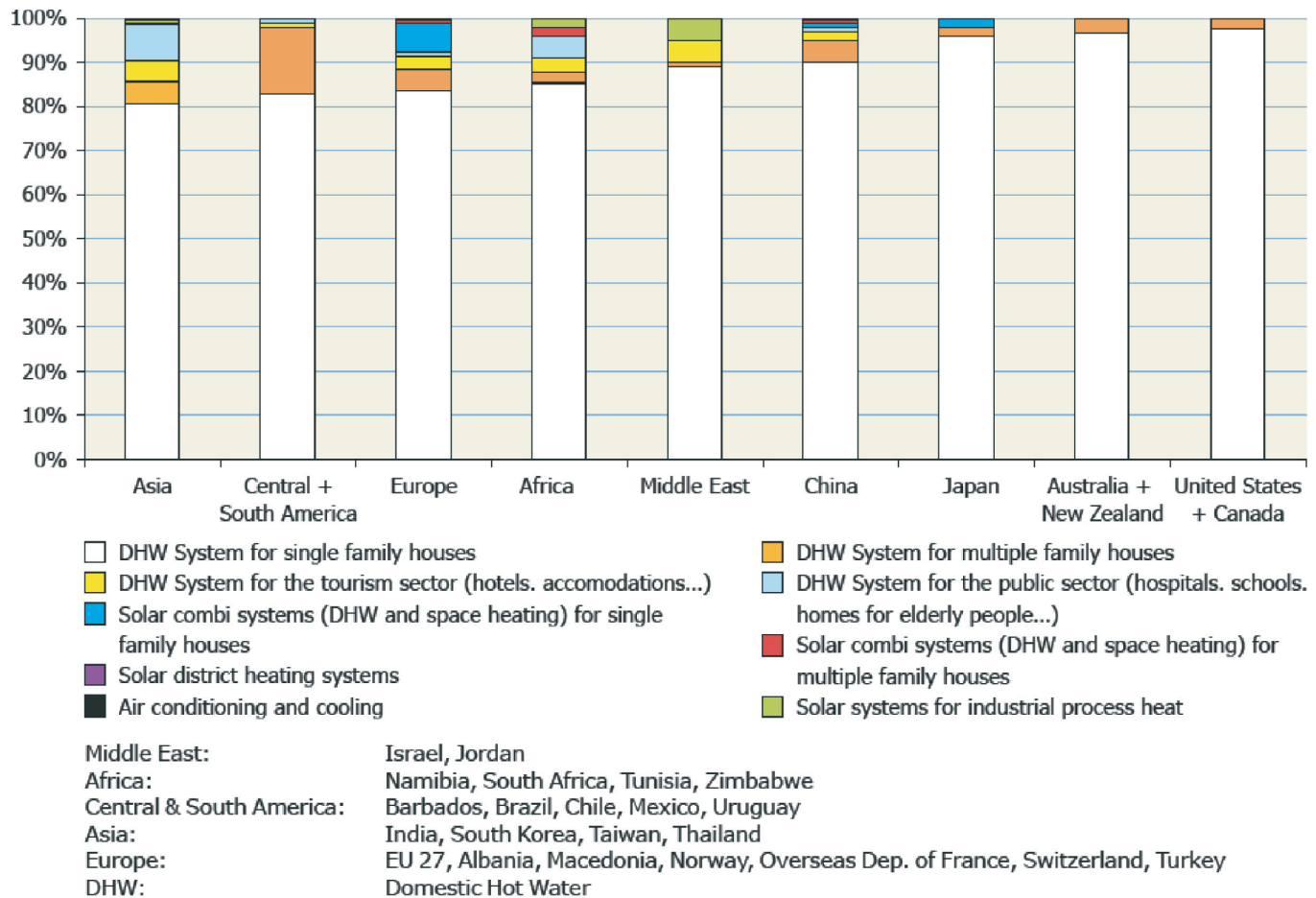

Figure 11.62 | Applications of glazed and evacuated tube collectors, by region, 2008. Source: Weiss and Mauthner, 2010.

11.8.4.1 Solar Water Heating

Solar water heating (SWH) is the most widely used application of low-temperature solar heat. Conventional collectors use either flat-plate and evacuated tube approaches. A flat-plate collector is an insulated metal box with a dark, heat-absorbing metal plate inside and a cover of glass or plastic. Sunlight passes through the cover and heats up the dark absorber plate. The heat is transferred to a liquid (usually water or propylene glycol) flowing through pipes inside the absorber plate. In areas with freezing temperatures, liquid collectors must contain anti-freeze or have a system to drain the water when the temperature drops. Evacuated tube systems have a row of glass tubes that contain small metal pipes with heat transfer fluid that act as heat absorbers. This type of collector has higher temperature differences between the ambient air and the collector fluid, leading to higher operating efficiency than flat-plate collectors at cold outdoor temperatures.

Active SWH systems use a circulating pump, sometimes powered by a small solar electric panel, to circulate fluid through the heating system. Passive systems rely on water pressure, the buoyancy of warm liquids,

and gravity to move the heat-transfer fluid through the system. (See Figure 11.64.) Tables 11.35 and 11.36 show characteristics of SWH systems and combination solar space heating and water heating systems for single-family and multi-family residences in three regions of the world.

SWH technologies have improved significantly in the last 20 years. Areas that can be improved further include the following:

- Increase durability and reliability while reducing costs. Identify and develop low-cost polymer materials, predict degradation from optical and mechanical processes, develop protective coatings, and improve active system components such as electronic sensors and controls.
- Improve freeze protection. Expand the geographic range of SWH markets from systems primarily made of low-cost polymers.
- Standardize SWH system components. Develop easy-to-assemble systems that incorporate standardized, packaged sets of subsystems and components (pumps, valves, controls, and tanks).

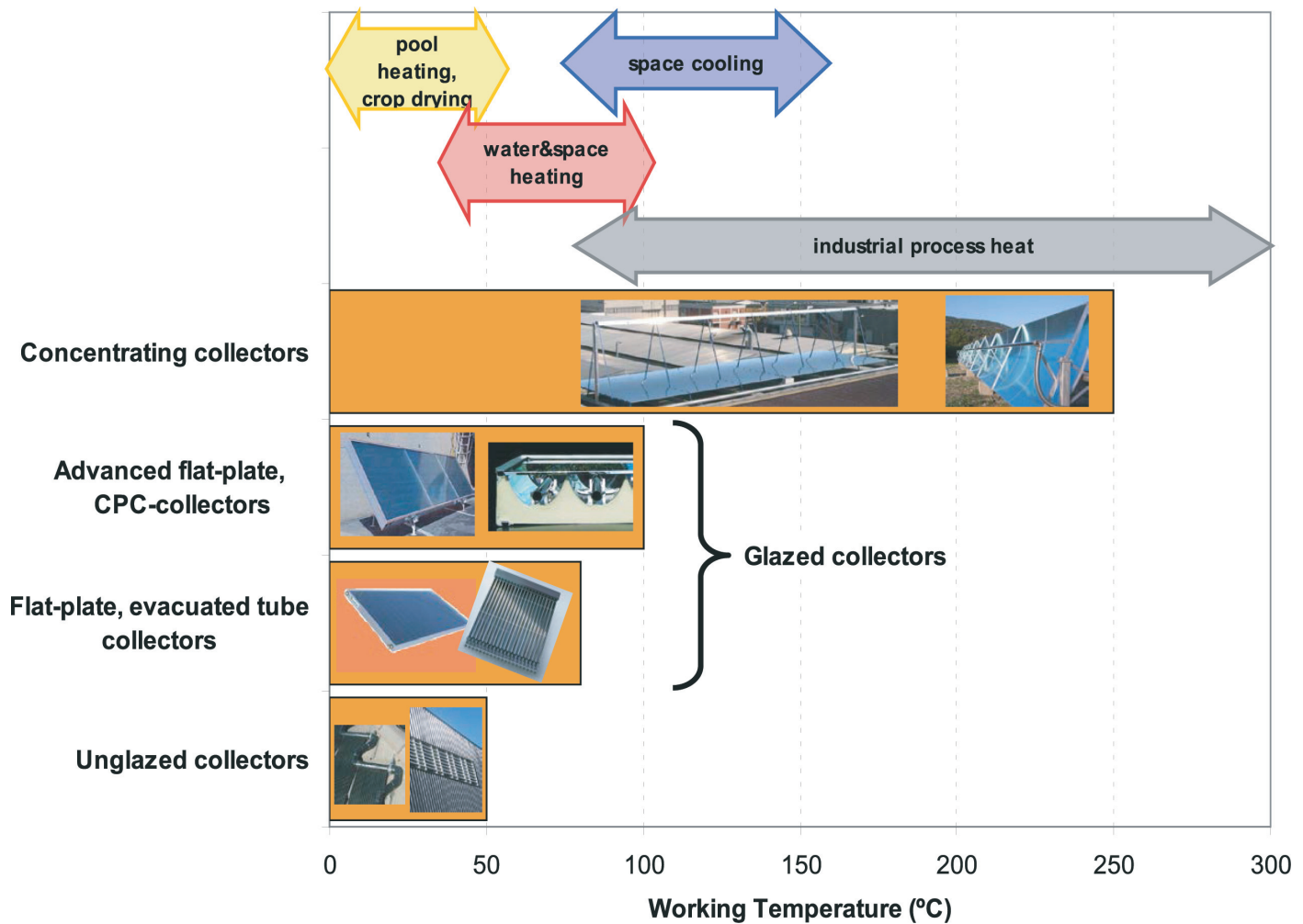

Figure 11.63 | Active solar thermal technologies, collectors, and working temperature ranges. Source: IEA-CERT, 2011. Courtesy of ORNL.

- Develop “combination” technologies and integrate SWH into buildings. Combine solar thermal technologies with other water-heating and building-system technologies.

11.8.4.2 Large Solar Water Heating Systems

Solar thermal systems can provide heat and hot water for direct use. They can also provide preheated water to boilers that generate steam. Large water heating systems can be used by hotels, hospitals, homes for the elderly, and public institutions such as correctional facilities. Other markets for large water heating systems are fertilizer and chemical factories, textile mills, dairies, and food-processing units. Large (MW-scale) solar thermal systems in the low temperature range are used for district heating and for cooling and low/medium temperature process heating.

11.8.4.3 Solar Space Heating

Active solar space heating systems for residential and commercial buildings use a solar collector to heat liquid or air. Thermal energy is

transferred directly to an interior space or to a storage area for later use. Liquid-based heating systems are used when storage is desired. Solar-heated air is typically used for ventilation air heating. For example, the transpired solar collector draws air through the perforations of a solar absorber, warming the air in the process. This heated air is used directly in the building, or it may serve as pre-warmed air for a conventional heating/ventilation system.

Space heating often uses liquid-based systems that heat ordinary water or an antifreeze solution such as glycol, depending on the climate. The hot liquid may be used in a fan coil, a hydronic system, or a radiant floor system. R&D activities are under way to improve the performance, cost, and reliability of solar collectors and associated thermal-storage systems.

Solar-assisted heat pump systems are being installed in Europe. Four main components interact in these combined solar and heat pump systems:

- solar collectors: glazed, evacuated, or unglazed;
- a heat pump: air source, water source, or ground source;

Table 11.35 | Characteristics of a typical single-family solar water heating system and combination solar space and water heating system, 2007.

	OECD Europe	OECD North America	OECD Pacific
Water heating: typical size (kW th)	2.8–4.2	2.6–4.2	2.1–4.2
Water heating: useful energy: (GJ/system/yr)	4.8–8.0	9.7–12.4	6.5–10.3
Combi systems: typical size (kW th)	8.4–10.5	8.4–10.5	7.0–10.0
Combi systems: useful energy (GJ/system/yr)	16.1–18.5	19.8–29.2	17.2–24.5
Installed cost: new build (US\$/kW th)	1140–1340	1200–2100	1100–2140
Installed cost: retrofit (US\$/kW th)	1530–1730	1530–2100	1300–2200

Source: data from IEA-CERT, 2011.

Table 11.36 | Characteristics of a typical multi-family solar water heating system and combination solar space and water heating system, 2007.

	OECD Europe	OECD North America	OECD Pacific
Water heating: typical size (kW th)	35	35	35
Water heating: useful energy (GJ/system/yr)	60–77	82–122	86
Combi systems: typical size (kW th)	70–130	70–105	70
Combi systems: useful energy (GJ/system/yr)	134–230	165–365	172
Installed cost: new build (US\$/kW th)	950–1050	950–1050	1100–1850
Installed cost: retrofit (US\$/kW th)	1140–1340	1140–1340	1850–2050

Source: data from IEA-CERT, 2011.

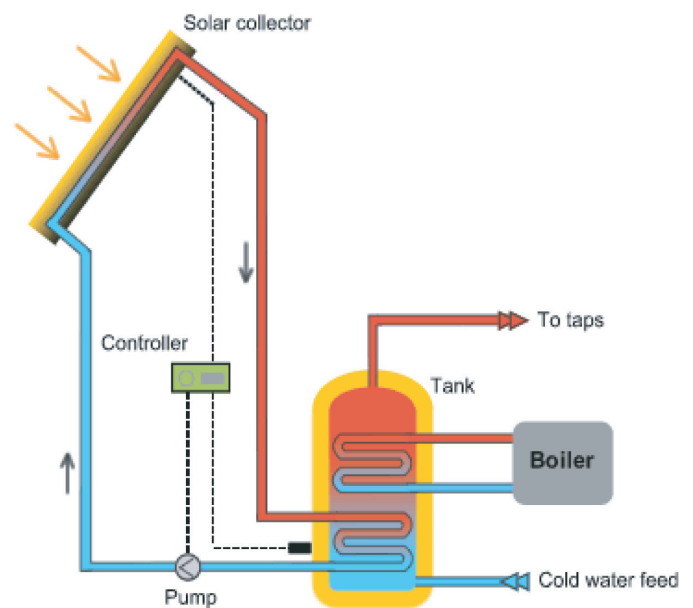
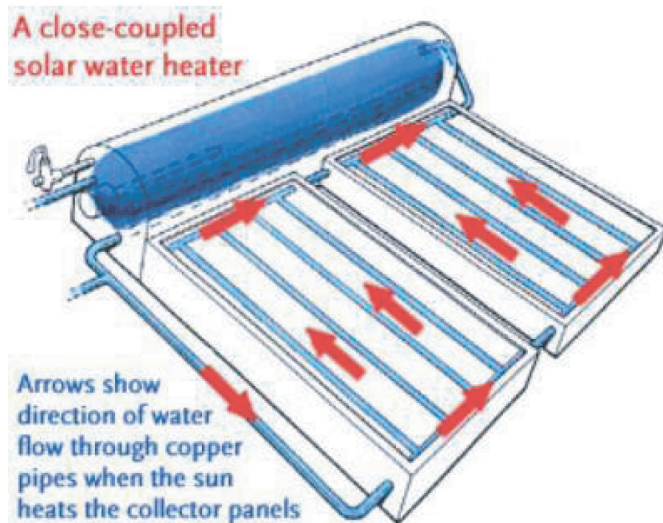

Figure 11.64 | A passive thermo syphon SWH system (left) and an active forced circulation SWH system (right).

- storage: a water tank, the building structure, the ground, phase change materials, or thermo chemical heat storage (IEA-CERT, 2011); and
- controls that determine how the other components interact.

11.8.4.4 Solar Space Cooling

Space cooling is the newest building application of solar thermal energy. Solar cooling systems can reduce summer peak demand on electricity grids. In addition to the four basic components of a typical solar thermal system, a space cooling system also requires a heat rejection system such as a wet cooling tower or a dry condenser.

Thermally driven cooling uses either a closed cycle for sensible cooling or an open sorption cycle for latent cooling. Closed cycles include absorption cooling, adsorption cooling, and ejector cooling. Absorption cooling systems use working fluids such as water paired with ammonia or solutions of certain salts such as lithium bromide. Closed adsorption cooling systems use solids such as silica gel paired with water. Absorption chillers that use thermal energy from natural gas or other fossil fuels provided the first space cooling before the advent of electric vapor compression cooling equipment. However, smaller-scale absorption chillers designed to operate at temperatures more suitable for solar thermal systems are now under development in Europe and China.

In hot, humid climates, removing moisture from the conditioned air is a key factor in space cooling. In an open sorption cooling cycle, solar

thermal energy can be used in the regeneration phase to dry either solid or liquid desiccant material that has absorbed moisture. Depending on the desiccant material, flat-plate or evacuated tube collectors can be used to provide the regeneration energy. Liquid desiccant systems that work well below 80°C are under development.

11.8.4.5 Solar Pool Heating

Solar pool heating for homes is the largest use of solar thermal energy in the United States. Hotels, municipal governments, and other commercial customers are also starting to adopt this technology. Solar pool heating systems use the pool-filtration system to pump water from the pool to a solar collector. The sun heats the water as it flows through the collector, and the heated water is returned directly to the pool. Solar pool heating collectors are usually unglazed, operate at a slightly warmer temperature than the surrounding air, and are in general made from polymers.

11.8.4.6 Solar Cooking

Solar cookers can cook food, boil water, and pasteurize food or water. Simple solar cookers use diffuse sunlight. Even a simple insulated box with a transparent lid can produce temperatures in the range of 50–100°C. More complex designs use reflectors in dish or trough concentrators to produce temperatures up to 300°C using direct sunlight. In countries where firewood is traditionally used for cooking, solar cookers can slow deforestation and decrease indoor and outdoor air pollution from wood smoke.

11.8.4.7 Solar Crop Drying

Drying agricultural products uses large quantities of low temperature heat usually supplied by burning firewood or fossil fuels, such as diesel and propane. In many cases, air-based solar collectors could provide the needed heat. In Finland, Norway, and Switzerland, this technology is used to dry hay.

The IEA Solar Heating and Cooling Programme (IEA-SHC, 2009) sponsored a project in India to demonstrate a solar air preheating system to help dry coir pith, a byproduct manufactured from coconut shells marketed as an absorbent substitute for potting soil. The coir pith is pressed to reduce moisture content and then final drying takes place in a fluidized bed burner. Solar energy is used to preheat air to the burner. Perforated transpired collector panels on the roof draw air through the small openings heating it to 20°C above ambient. The air is then ducted to the burner, where the temperature is raised to the required 105°C to feed the dryers. After three years of operation, the solar heating system displaced 14% of the heating fuel, which resulted in a two-year payback.

11.8.4.8 Passive Solar Energy

Applying passive solar design principles to new buildings can reduce energy demands for heating, cooling, ventilation, and lighting. A successful solar building design integrates individual building components to achieve optimal energy performance. Computer simulations can help designers understand and quantify the interactions among the various components and systems. It has been estimated that 13% of the heat demand of buildings could be met by passive solar energy use. For optimized buildings, this figure could reach 30% without major investments (Brouwer and Bosselaar, 1999).

The key to passive solar design is the building envelope – the interface between the interior of the building and the outdoor environment. Energy pathways through the building envelope include the roof, walls, windows, air infiltrations, thermal storage, and insulation. Numerous advances are being made within these various components (Kutscher, 2007; Walker et al., 2003):

- New roofing materials with pigments can reflect more heat than conventional materials. Preventing heat from entering a building through the roof can help to reduce the amount of energy needed to cool the interior space.
- New wall designs can help control heat loss by reducing the amount of framing and optimizing insulating materials, such as structural insulated panels and insulated concrete forms. When retrofitting existing buildings, new insulating fabrics can be hung or applied to interior walls to control indoor temperatures.
- High-quality windows address the three main energy paths: radiant energy, heat conduction through the frame, and air leakage around the window's components. Low-emissivity window coatings increase the window's R-value by reducing the flow of infrared energy out of the building; other low-emissivity coatings can block infrared energy from entering the window to reduce the cooling load.
- Passive daylighting is combined with very efficient lighting systems to meet additional lighting needs. In daylight design, windows provide adequate interior illumination while minimizing glare and controlling interior temperatures. Building designs can also include clerestory windows, skylights, light tubes, and light shelves to bring light into the deeper recesses of buildings. Energy use can be offset both directly by replacing artificial lighting or indirectly by reducing cooling loads.
- Sunshine can heat a space passively through direct solar gain, where the sun shines into a building and warms materials in the space such as bricks, concrete, or adobe. These materials store thermal energy as they are heated during the day and release their heat to warm the space at night. A Trombe wall, separated from the outdoors by a glass wall, is designed to absorb solar heat and release it into the interior

Table 11.37 | Cost of energy for a single-family solar thermal system as a function of capacity factor, turnkey investment costs, and discount rate. The O&M costs are assumed at US¢2/kWh for a capacity factor of 10–12% and US¢4/kWh for 5–6%. Lifetime is 20 years.

Capacity factor	Turnkey investment costs per kWh (water heating)	Discount rate	
		5%	10%
	US ₂₀₀₅ \$	US¢/kWh	
12%	1100	10.4	14.2
	2200	18.7	26.5
6%	1100	20.8	28.5
	2200	37.5	53.0

Capacity factor	Turnkey investment costs per kWh (space and water heating)	Discount rate	
		5%	10%
	US ₂₀₀₅ \$	US¢/kWh	
10%	1100	12.0	16.7
	2200	22.1	31.4
5%	1100	24.1	33.4
	2200	44.2	62.8

of a building. The future may see special phase-change materials used for thermal storage and molecular or nanocomposite materials. Ventilation takes place during periods of cool outside temperatures.

11.8.5 Economic and Financial Aspects

Active low-temperature solar technologies require an auxiliary energy source. In solar water heating systems, 20–70% of the demand is met by solar, and in combined solar water and space heating systems, the figure is 20–60% (IEA-CERT, 2011). However, when thermal energy storage is included, this percentage will increase.

Solar has a first cost to the user that must be amortized over the years of service. Based on the data in Tables 11.35 and 11.36, the levelized cost of energy for these systems can be calculated. This calculation assumes discount rates of 5% and 10%, an economic system lifetime of 20 years, and O&M costs ranging from US¢1–4/kWh_{th}, depending on the system and the capacity factor achieved. (See Tables 11.37 and 11.38) The energy costs range from US¢10–63/kWh_{th} for single-family systems and from US¢8–55/kWh_{th} for multi-family systems. In the long term, further improvements in the performance and investment costs may reduce the energy cost by a factor of two (ESTTP, 2008). Solar thermal systems in developing countries cost US¢2–3/kWh_{th} because they are simple thermosiphon systems and usually without freeze-protection (IEA-CERT, 2011).

11.8.6 Sustainability Issues

Low-temperature solar energy technologies have the potential to displace burning wood and fossil fuels. Solar water heating and solar

cooking technologies can conserve local biomass and reduce the burden of collecting firewood. They can purify water and mitigate the health impacts of cooking with wood, which creates smoky indoor environments. They can reduce costly diesel fuel use and pollution of the local environment. Low-cost solar crop drying added to the local infrastructure can produce feed for livestock and bring more protein into the diet.

Solar technologies emit no CO₂ while operating. The CO₂ emissions attributed to these technologies come mostly from the energy expended in producing the raw materials, fabricating the products, and transporting and installing them. Displacing combustion with solar thermal heat can offset considerable amounts of CO₂ (Arvizu, 2008), as the energy payback time of a thermosiphon type solar collector and storage system could be 1.3–4.0 years (Harvey, 2006). Worldwide, the energy yield of solar collectors in 2008 roughly translated to an oil equivalent of over 12 million metric tons and an annual CO₂ emissions reduction of 39 million metric tons (Weiss and Mauthner, 2010). Under the IEA BLUE Map scenario, the total installed worldwide solar thermal capacity in 2050 could reduce CO₂ emissions by roughly 450 million metric tons (IEA-CERT, 2011).

11.8.7 Implementation Issues

Barriers to the widespread use of solar thermal systems include initial costs, financing problems, policy uncertainty, and consumer and institutional ignorance (IEA-CERT, 2011). Key barriers to wider use of solar crop drying are lack of information about the cost-effectiveness of these systems, about their technical details, and about practical experience (IEA-SHC, 2009).

Table 11.38 | Cost of energy for a multi-family solar thermal system as a function of capacity factor, turnkey investment costs, and discount rate. The O&M costs are assumed at US¢1/kWh for a capacity factor of 10–12% and US¢2/kWh for 5–6%. Lifetime is 20 years.

Capacity factor	Turnkey investment costs per kWth (water heating)	Discount rate	
		5%	10%
	US ₂₀₀₅ \$	US¢/kWh	
12%	950	8.2	11.6
	2000	16.2	23.3
6%	950	16.5	23.2
	2000	32.5	46.6

Capacity factor	Turnkey investment costs per kWth (space and water heating)	Discount rate	
		5%	10%
	US ₂₀₀₅ \$	US¢/kWh	
10%	950	9.7	13.7
	2000	19.3	27.3
5%	950	19.4	27.4
	2000	38.5	55.4

Incentive programs and policies that include environmental mandates can help reduce economic and other barriers. These actions may be taken at the local, regional, national, or international level – from a desire for a city to be “green,” to a state or province mandating air quality levels, to a country striving to meet the guidelines of the Kyoto Protocol (Arvizu, 2008). Tax credits for companies and consumers, a carbon tax on fossil fuel use, and renewable energy portfolio mandates designed for utilities are a few examples of policies and practices that encourage use of solar technologies (Johansson and Turkenburg, 2004; REN21, 2010). (See also section 11.12.) Legislation can be very effective. For example, in 1980 the Israeli government required solar water heaters in all new homes (except tall buildings with insufficient roof area). In Israel, 85% of households now use solar thermal systems. Spain also introduced a national solar thermal obligation for new buildings in 2006 (ESTIF, 2007).

In the (draft) *Roadmap for Energy Efficiency in Buildings*, focusing on heating and cooling (IEA-CERT, 2011), the following areas are identified for policy support:

- Increased technology R&D, significant demonstration programs, and development beyond the present best available technologies;
- Improved information for consumers and robust metrics for analyzing the energy savings, CO₂ emission savings, and financial benefits of heating and cooling technologies;
- Market transformation policies to overcome the current low uptake of many low/zero carbon heating and cooling technologies;

- International cooperation to maximize the benefits of policy intervention as well as the transfer of technical knowledge between countries;
- The creation of strong partnerships for the promotion of efficient and low/zero carbon heating and cooling technologies.

11.9 Ocean Energy

11.9.1 Introduction

In principle, the oceans represent one of the largest renewable energy resources on earth. Energy is stored in the seas as kinetic energy from the motion of waves and currents and as thermal energy from the sun. Energy can be extracted from the mixing of fresh and salt water (“salinity gradient energy”) where rivers run into the sea. Ocean water can be used for cooling purposes, and oceans can be used to produce marine biomass for energy services (as discussed in section 11.2).

Most ocean energy resources are diffuse and far from where they are needed. Yet energy from the oceans can be captured for practical use (Turkenburg et al., 2000). Tidal energy can be extracted where extreme tidal ranges or currents exist. Wave energy can be exploited where a higher-than-average wave climate occurs. Ocean thermal energy conversion (OTEC) can be achieved where the temperature difference between surface waters and water near the seabed is sufficient. Using ocean water to cool power plants or buildings is feasible when the distance between source and end user is short. These requirements tend to

limit the use of the ocean resource to certain areas of coastline where the resource and a market for the energy are within reach.

Many techniques have been proposed to exploit this resource to generate electricity, produce fuels, provide cooling, and make potable water. Virtually all of them, however, are still at the early development or demonstration stage.

11.9.2 Potential of Ocean Energy Technologies

The main ocean energy resources considered here are tidal head energy, tidal current energy, ocean current energy, wave energy, ocean thermal energy, and salinity gradient energy.

Tidal head energy: Tidal head (or barrage) energy makes use of the potential energy from the difference in height between high and low tides. The output of a tidal head plant is entirely predictable. The largest tidal heads can be found in estuaries in Canada (Bay of Fundy), the United Kingdom (Severn Estuary), France (Baie du Mont Saint Michel), and India (Gulf of Cambay). The global potential of tidal head energy is estimated at 3 TW, with about 1 TW being available at comparable shallow waters (Charlier et al., 1993). The capacity factor for these plants varies from 22–29%. Consequently, the theoretical potential of tidal head energy can be estimated at about 2500 TWh/yr (9 EJ_e/yr). The technical potential is estimated at about 1,000 TWh/yr (3.6 EJ_e/yr) (see Chapter 7).

Tidal current and ocean current energy. Tidal current energy makes use of the kinetic energy of water in a tide. Ocean currents are generated by winds and by differences in water temperature and salinity. In most places, the movements of seawater are too slow to permit practical energy exploitation. Water velocity can be increased by a reduction in cross-section of the flow area. This happens in straits, around the ends of headlands, in estuaries, and in other narrowing topographical features (Turkenburg et al., 2000). As with wind energy, a cube law governs instantaneous power to fluid velocity. An average peak marine current of 2.5 mps (5 knots), which is not unusual, translates to a power flux of about 8 kW/m². Potential sites must have flows exceeding 1.5 mps for a reasonable period (Fraenkel, 1999; IT Power, 1996).

Estimates of the tidal current energy resource have been made for the European Union, Asia, the United Kingdom, and Canada (CEC, 1996; CEC, 1998; UK-DTI, 2004; Cornett, 2006). Sites have also been identified in Japan, New Zealand, and South America. In Europe, about 100 locations have been identified where power production from tidal current energy may become attractive, offering a potential electricity supply of 48 TWh/yr (compared with European electricity demand of about 5000 TWh/yr in 2010). Countries with promising sites include France, Greece, Ireland, Italy, and the United Kingdom (CEC, 1996). In China, 14 GW of tidal current power installations might be possible (Wang and Lu, 2009). This would translate to 50 TWh/yr, assuming a high capacity factor of about 40% (Harvey, 2010).

Assessments for open ocean current flows have also been made (see, e.g., Leaman et al., 1987). Potential locations have been identified in South Africa, East Asia, Australia, and North America, including the Florida current of the Gulf Stream, 15–30 km off the coast. Ocean currents offer the potential of a relatively high capacity factor of 70–80% (Boud, 2002). The theoretical potential of ocean current energy has been estimated at about 6000 TWh/yr (Sørensen and Weinstein, 2008). The technical potential could be 1000–2000 TWh/yr and maybe more, depending on assumptions made.

Wave energy: Wave energy is generated by friction transfers from wind energy passing over the ocean. The energy density of waves is substantial: a wave 1.5 m high has a capacity of about 10 kW/m of wave front. The greatest wave power densities occur off northwestern Europe, western Canada and Alaska, and southern South America and Australia (Harvey, 2010). Energy fluxes of up to 75 kW/m have been found off the coast of Ireland and Scotland (Clément et al., 2002).

The global theoretical potential of wave energy has been estimated at 8000–80,000 TWh/yr (Harvey, 2010). Another study has proposed approximately 30,000 TWh/yr (108 EJ_e/yr) (Mørk et al., 2010). In Chapter 7, the technical potential is estimated at about 20,000 TWh/yr (72 EJ_e/yr).

The wave energy potential that can be harnessed in practice has been estimated at 260 TWh/yr in the United States and at 120–200 TWh/yr in Europe (Boud, 2002; Harvey, 2010). Wave energy is variable in time, resulting in capacity factors of 25–35%, depending on the location. However, the available wave energy can be predicted accurately 24–48 hours in advance (Harvey, 2010).

Ocean thermal energy: Using some form of heat engine to exploit natural temperature differences in the ocean has been discussed and investigated for many decades (Boyle, 1996). To deliver a feasible system, technically and economically, as large a temperature difference as possible is required. A temperature difference of about 20°C is required for OTEC. A few tropical regions with very deep water (a depth of 1 km or so) have this characteristic. In a recent assessment, a global technical potential of about 40,000 TWh/yr (144 EJ_e/yr) was calculated (Nihous, 2007). However, in another study the technical potential was assessed at 10,000 TWh/yr (Harvey, 2010). An even earlier assessment presented an estimate of 30,000–90,000 TWh/yr (108–324 EJ_e/yr) (Charlier and Justus, 1999).

Deep water from the ocean can also be used to cool buildings in coastal areas, especially in the tropics (see, e.g., Makai Ocean Engineering, 2010). The technology is called seawater air conditioning (SWAC). No estimates could be found about the technical potential of this technology.

Salinity gradient energy: Mixing salt water and fresh water releases latent heat that can be converted to work when a river runs into the sea (Pattle, 1954). According to Norman (1976), cited by Post (2009), “the tremendous energy flux available in the natural salination of fresh water

is graphically illustrated if one imagines that every stream and river in the world is terminated at its mouth by a waterfall 225 meter high," which is the potential energy equivalent of the latent heat from mixing fresh water with seawater. In a recent study, the theoretical potential of this technology was calculated at 1.7 TW/yr, or about 50 EJ/yr (Post, 2009). For most continents, the theoretical potential is about 300 GW (nearly 10 EJ_e/yr); only Europe (94 GW, or 3 EJ_e/yr) and Australia (30 GW, or 1 EJ_e/yr) have significantly lower potentials.

The global technical potential of salinity gradient energy can be estimated at 1 TW (Post, 2009). Assuming a capacity factor of 80–90%, this would translate to about 7500 TWh/yr (27 EJ_e/yr). In another publication the technical potential was estimated at about 150–170 GW_e (van den Ende and Groeman, 2007); this capacity could generate about 1200 TWh/y (4.3 EJ_e/yr). However, citing Statkraft of Norway, Criscione (2010) suggests that by 2030 the deployment of this energy source could already be 1600–1700 TWh/yr.

11.9.3 Market Developments

The world is only beginning deployment of ocean energy conversion systems. Not many systems are operational and most activities are undertaken by research institutes and small and medium-size enterprises, mainly in Canada, Norway, the United Kingdom, and the United States (Kahn et al., 2009; Harvey, 2010). Other countries involved include Australia, China, Denmark, France, India, Ireland, Japan, the Netherlands, and Sweden. Most of these countries participate in the IEA Ocean Energy Systems Implementing Agreement (IEA-OES-IA).

The 2010 annual report of IEA-OES-IA (2011) indicates that at the end of that year the installed power, reported by member countries, was 2 MW for wave energy, 4 MW of tidal stream, and 259 MW of tidal barrage energy. Consequently, the total installed capacity for ocean energy in 2009 and 2010 was less than 300 MW, mainly tidal head capacity, generating about 0.5 TWh/yr.

Tidal head energy: Tidal head energy has been exploited on a small scale for centuries using water mills. In France, the 240 MW La Rance scheme, built in the 1960s, is a large modern version. It uses bulb turbines like those applied in river-based hydro-electric projects. These turbines can pump to increase storage and produce about 0.5 TWh/yr (Andre, 1976; Kerr, 2007). A 254 MW plant at Lake Sihwa on the western coast of South Korea was expected to become operational in 2011. In addition, a handful of smaller plants have been built in Canada, China, and Russia (Cavanagh et al., 1993; Strange et al., 1994; Kerr, 2007). About 43 GW of tidal range capacity is under investigation, with an estimated electricity production potential of 63 TWh/yr (Kerr, 2007).

Tidal and ocean current energy: Large-scale energy generation from currents requires a totally submerged turbine, which may look like a wind turbine, adapted for harsh marine conditions. It can have a horizontal or

a vertical axis. About a dozen devices are in the RD&D phase. A 1.2 MW grid-connected system, called SeaGen, has been built by Marine Current Turbines and has been in operation in Northern Ireland since 2008. It is accredited as an official UK power station. Marine Current Turbines's earlier Seaflow 200 kW prototype operated from 2003 to 2009 in the Bristol Channel at the Devon coast (Willis, 2010). Other devices include the Hammerfest Strøm 300 kW turbine in Norway, installed in 2004; the TGL 500 kW device of Rolls Royce in the United Kingdom, installed in 2010; and the Verdant Energy array of 6 x 35 kW (small) turbines in East River, New York, that operated between 2005 and 2008.

Wave energy: The development of wave energy through 2007 was supported by Australia, Canada, Chile, China, India, Ireland, Japan, New Zealand, Norway, Portugal, Russia, Sweden, the United Kingdom, and the United States. In the last 5–10 years, the wave energy converters introduced by several companies include the Limpet (operational in Scotland since 2000) of Voith Hydro Wavegen, the PowerBuoy of OPT, the Oyster of Aquamarine Power, the Wave Energy Converter of Pelamis Wave Power, the Archimedes Waveswing of AWS Ocean Energy, and the Wave Energy Converters of Oceanlinx.

Ocean thermal energy: The first OTEC plant (using a low-pressure turbine) was a 22 kW device built in 1940 in Cuba. Some later attempts off the coast of Brazil and the Ivory Coast were initiated but failed. OTEC technology has been developed in the United States since 1974 (Hawaii) and in Japan since 2004. In the United States, prototype plants with rated capacities of 50 kW up to 1 MW were tested around 1980. A 210 kW system was tested from 1993 to 1998. Several small-scale power plants, including a 30 kW hybrid OTEC prototype plant, have been built in Japan. Unfortunately, Pacific Ocean storms knocked out a number of pioneering installations. OTEC systems have a very long pipe extending to deep water, making the system vulnerable to damage from rough seas. This vulnerability and the high system costs may explain why in 2006 only one ongoing project could be identified. It was in operation near the coast of India and developed by the Institute of Ocean Energy in Japan. Almost all the major US OTEC experiments have taken place at the Natural Energy Laboratory of Hawaii Authority (NELHA). In 2010, a 1.2 MW demonstration plant was under construction (Harvey, 2010). About one-third of the capacity will be used to run the pumps and the system, which would result in a net production of 800 kilowatts.

In Hawaii, cold seawater is also being used to air-condition buildings. This technology is applied to cool buildings of NELHA, which saves the laboratory nearly \$4000 per month in electricity costs. The system requires much less maintenance than traditional compressor systems (State of Hawaii, 2010). Similar projects have been developed or are being developed in Sweden and elsewhere (IEA-DHC, 2002; IEA, 2009c; Makai Ocean Engineering, 2010).

Salinity gradient energy: Two technologies to extract energy from mixing fresh water and salt water, using quite different physical principles, are in the prototype stage. The Pressure Retarded Osmosis technology has

been under investigation by Statkraft of Norway since 1997 (Scråmestø et al., 2009). The Reversed Electro Dialysis technology has been investigated by Wetsus Institute of the Netherlands since about 2004 (Post, 2009).

Ocean energy in future energy scenario studies: Because of the early stage of development, ocean energy is projected to have a minor role in most energy scenarios for 2030–2050. Potential contributions in 2050 range from 25–600 TWh/yr. The European Renewable Energy Council and Greenpeace International, however, project a figure of 1900 TWh in 2050 (Krewitt et al., 2009; EREC & Greenpeace, 2010; IEA 2010a).

11.9.4 Ocean Energy Technology Developments

A recent study identified 135 ocean energy technologies that have been under development since the 1990s (Khan and Bhuyan, 2009). Within constrained funding environments, and due to the difficult operating environment and resource diversity, maturity of various ocean energy technologies has been relatively slow. (See Figure 11.65.)

Tidal head energy technology: Tidal head energy conversion technology uses similar technology to conventional low-head hydro-electric systems and therefore is considered mature. At present it is used in estuaries where a basin is created by means of a barrage. (See Figure 11.66) The high tide fills the basin and the impounded water is held behind the barrage until the receding tide creates a suitable head. The water is then released through the hydroelectric converter until the rising tide reduces the head to a minimum operating point. This sequence is repeated with the tides (Strange et al., 1994). In this approach, called “ebb generation,” power production on both ebb and flood is also possible. To obtain continuity of supply, plant configurations and operating routines of greater complexity are needed, including linked and paired basins (Strange et al., 1994). Single-basin plants deliver one or two intermittent pulses of energy per tide. The pulses recur at a period of 12 hours and 25 minutes. Consequently, the capacity (or load) factor of the plant is limited to 25–35%. Recent studies also investigated options to produce electricity using artificial basins offshore (called tidal lagoons). Increased output can be obtained by using the turbines as pumps using external power to increase the water level and therefore the generating head (Strange et al., 1994). Turbine and generator system configurations include the bulb, the Straflow, and the tubular turbine (Harvey, 2010).

Tidal and ocean current energy technology: Marine current energy machines work very much like underwater wind turbines; the physical principles of kinetic energy conversion are directly analogous in moving water or air. Currents are complicated by short-term variations in both velocity and direction, caused by turbulence and velocity shear effects. In particular, surface currents move much faster than the currents deeper down, to the extent that the majority of the energy in most locations with strong currents is in the upper half of the water column. Full understanding is needed about how variation in velocity combined

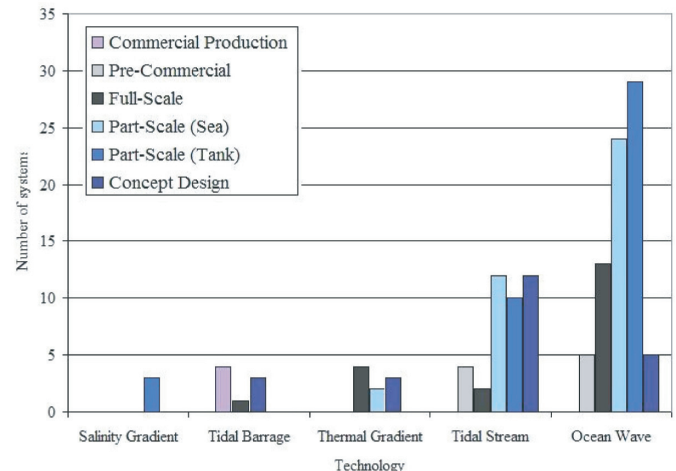

Figure 11.65 | Number of ocean energy conversion schemes and their maturity. Source: Kahn and Bhuyan, 2009.

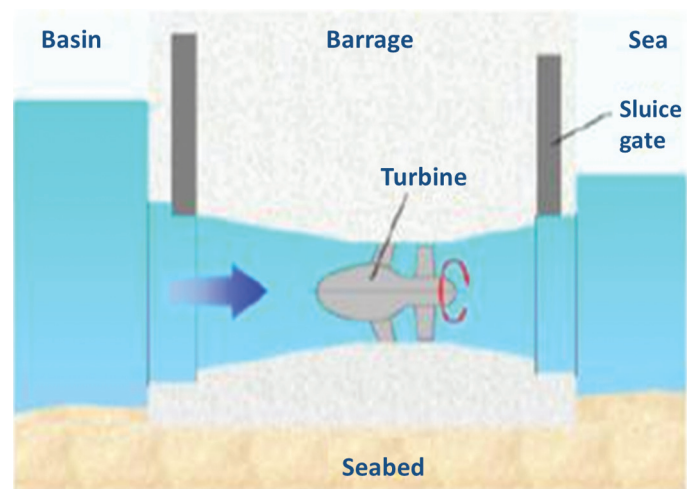

Figure 11.66 | Tidal barrage type of energy device. Source: Sørensen and Weinstein, 2008.

with waves from any direction will affect structural strength and power-conversion mechanisms (Salter et al., 2006).

The density of water is some 850 times higher than that of air at normal atmospheric pressure, so a water current turbine can be considerably smaller than an equivalent powered wind turbine. When applied to convert tidal current energy, which is a bi-directional flow, the turbine should be able to respond to reversing flow directions. This is not an issue when converting energy from ocean currents, which are generally unidirectional.

The biggest problem with underwater kinetic energy conversion systems stems from the very large forces generated by taking momentum from such a dense medium. Although the literature tends to focus on rotor

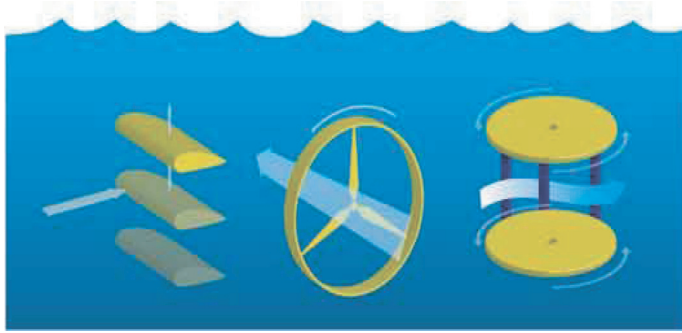

Figure 11.67 | Three technologies to convert ocean current energy: reciprocating hydrofoil (left), horizontal axis turbine (middle), vertical axis turbine (right). Source: DP Energy, 2010.

concepts, the overwhelming problem in engineering a large system to extract kinetic energy from moving water, whether it is waves or currents, is the strength needed both to react to very large forces and to be anchored securely to the seabed. Typically a tidal turbine experiences thrust forces amounting to around 100 tonnes per MW with a rated current of about 2.5m/s (typical), whereas a wind turbine will experience about one third of this force per MW.

Tidal turbine developers are following in the footsteps of wind turbine developers 30 years ago by experimenting with a variety of rotor types: axial-flow turbines, cross-flow turbines, and reciprocating devices. (See Figure 11.67.) When using axial-flow or cross-flow turbines, horizontal axis as well as vertical axis configurations can be applied and shrouds can be used to increase the flow velocity through the turbine. A reciprocating device uses the flow of water to produce the lift or drag of an oscillating part transverse to the flow direction. The mechanical energy from this oscillation can be used to generate electricity. It seems probable that the pros and cons of these different rotor types will be similar in water to those in air, notably that the open axial flow rotor is more efficient, more controllable, and more cost-effective than any other. This is why virtually 100% of commercial wind turbines (and the majority of low-head hydro turbines too) use pitch regulated axial flow rotors.

Although in an early stage of development, experiments have been conducted with prototypes in the open sea in the United Kingdom. At least one system (Marine Current Turbines's 1.2 MW SeaGen) has reached the commercial stage, is an accredited UK power station, and will be replicated in larger numbers in the near future.

Wave energy technology: At least 50 wave-energy devices are under development (US DOE, 2009; Khan and Bhuyan, 2009). One group is devices operating on the shoreline, near-shore, or offshore. Another group is installations located at the water surface versus installations located at a depth of about 5–15 m (Sørensen and Weinstein, 2008). In a third group, technologies are divided according to the mechanism applied: oscillating water column devices, surge devices, heaving float devices, heaving and pitching float devices, and pitching devices.

(See Figure 11.68.) Each mechanism reacts to the waves in a different way. For example, surge devices often have a flap that is pushed back and forth by the waves; heaving float devices move up and down as the wave passes and activate either a pump or a generator to extract energy; pitching devices rock usually fore and aft and generally react one floatation device against another, often compressing hydraulic fluid in the process to drive a generator.

To increase confidence in wave energy, demonstrations are needed that wave devices can survive the worst climate (wind, temperature) and ocean conditions (saltwater corrosion, fouling, heavy storms, seawater pollution) and perform as expected. Less expensive installation methods are needed, along with test platforms so that large numbers of components and subassemblies can be operated in parallel.

Ocean thermal energy technology: The three main concepts of OTEC are all based on the Rankine (steam/vapor) cycle: an open cycle system, a closed cycle system, and a combination of these two. The open cycle concept quickly evaporates warm seawater to vapor (at reduced pressure) and draws it through a turbine by condensing the vapor with cold seawater. The closed cycle system uses warm seawater to boil a low-temperature fluid, such as ammonia or propane. (See Figure 11.69.) That vapor is then drawn through a turbine by being condensed in a heat exchanger with cold seawater and recycled back to the boiler by a pump (Turkenburg et al., 2000). Closed cycle systems offer in principle a better conversion efficiency and a smaller turbine. The hybrid system flash evaporates warm seawater, and the generated steam is used as a heat source for a closed cycle.

Offshore OTEC is technically difficult because of the need to pipe large volumes of water from the sea bed to a floating system and the need for huge areas of heat exchanger. Other operational challenges include storm resistance, corrosion, maintenance of vacuum, and fouling. Transmitting power from a device floating in deep water to the shore is also an issue, because of the costs involved. As a result, OTEC technology has yet to mature to commercial and economic viability.

Seawater air-conditioning systems can be applied to produce chilled water. Such systems pipe cold water from the deep ocean to the shore. The cold (1–7°C) water, which is denser than warm water, is pumped from a depth of 600–1000 meters, and the return system water is 8–12°C (IEA-DHC, 2002; IEA, 2009c). Using a heat exchanger, the cold can be made available to air condition hotels, offices, and other buildings, reducing the energy use for air conditioning by 90% (Van Wijk, 2010). The cold can also be used to condense water vapor for irrigation purposes and to produce potable water. The capacity of a SWAC system can be many MW. Commercial production is feasible, especially in regions where a high capacity factor can be achieved.

Salinity gradient energy technology: In a Pressure Retarded Osmosis system – also called osmotic power system – a semi-permeable membrane is placed between a salt solution (seawater) and fresh water (Post,

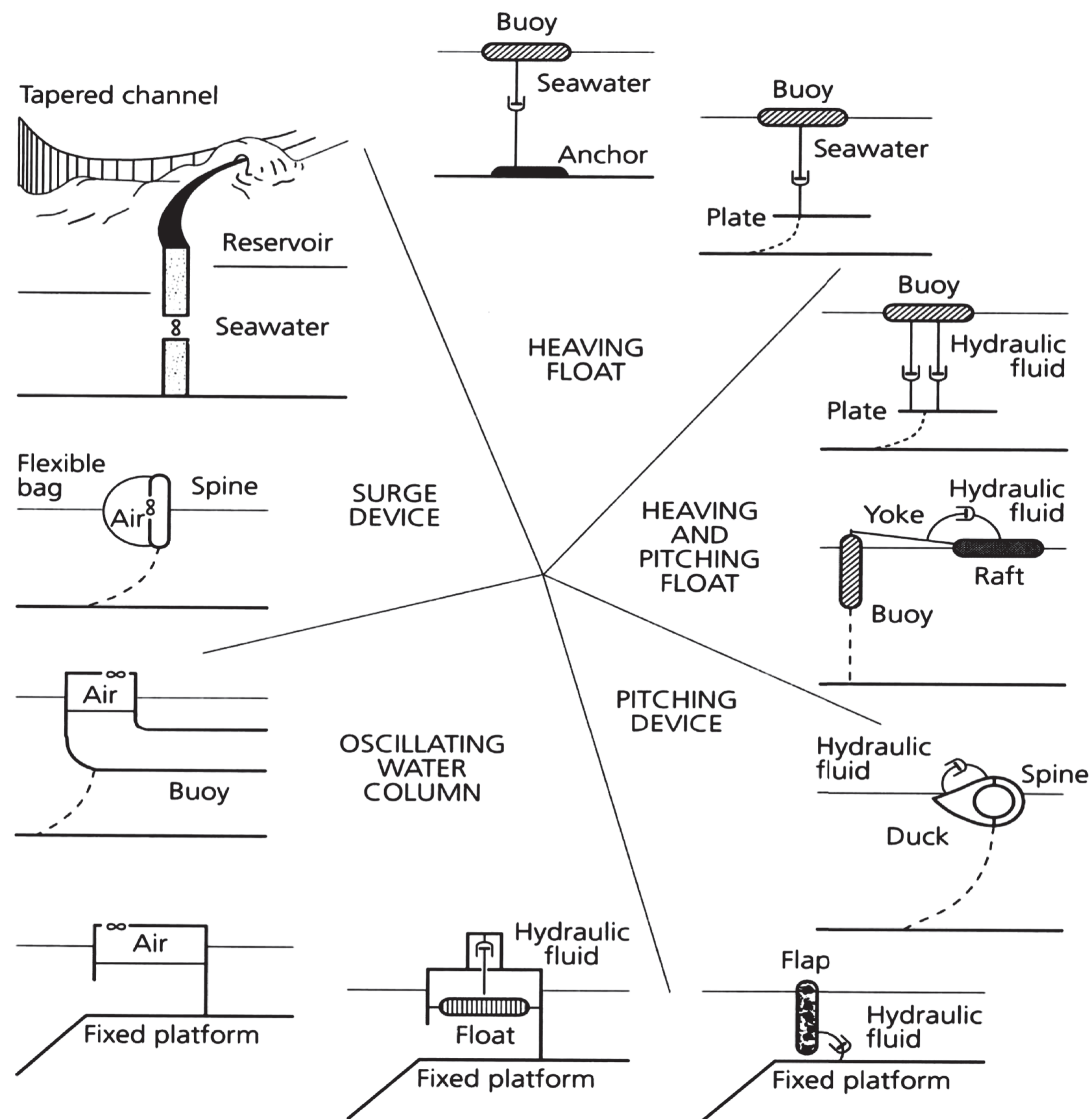

Figure 11.68 | Schematic representation of five mechanisms and 11 devices to use wave energy. Source: Cavanagh et al., 1993.

2009). The membrane allows the solvent (the water) to permeate, but it acts as a barrier to the dissolved salts. The chemical potential difference between the solutions causes transport of water from the diluted salt solution to the more concentrated salt solution. This transport results in a pressurization of the volume of transported water, which can be used to generate electricity in a turbine. The great difference in osmotic pressure (equal to a 240 m head) between fresh water and seawater is used. A first pilot plant based on this technology was commissioned by Statkraft in Norway in 2009 (Post, 2009).

A Reversed Electro Dialysis system is essentially a salt battery. A number of cation and anion-exchange membranes are stacked in an alternating pattern between a cathode and an anode to create an electrical battery. The compartments between the membranes are alternately filled with a concentrated salt solution and a diluted salt solution. The salinity gradient results in a potential difference (80 millivolt for sea water and

river water) over each membrane. The potential difference between the outer compartments of the membrane stack is the sum of the potential difference over each membrane. First prototypes of this technology have been tested at the Wetsus Institute in the Netherlands (Post, 2009).

These technologies are still at an early stage of experimentation, and at present it is unclear whether they can be made sufficiently efficient to become commercially and economically viable.

11.9.5 Economic and Financial Aspects

Most ocean energy technologies are in the RD&D phase. Their development is driven by governmental R&D funding and policy objectives. Consequently, only preliminary cost figures can be presented, with a high degree of uncertainty.

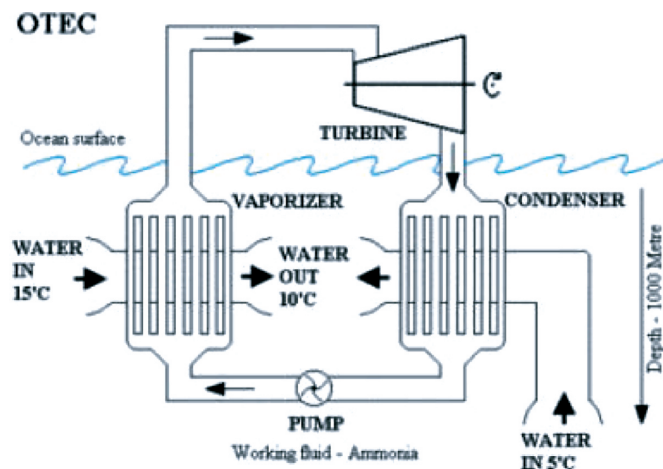

Figure 11.69 | A closed cycle OTEC power plant. Source: Sørensen and Weinstein, 2008.

When calculating the cost per kWh, the assumptions are a discount rate ranging from 5–10%, annual O&M costs equivalent to 1% of the initial investment costs, and an economic lifetime of the system ranging from 30–40 years (depending on the technology involved). It should be noted that if the technical lifetime of a system is much longer than the economic lifetime – as is the case with tidal barrage systems – the kWh production costs will in general be substantially lower in the long term. Due to anticipated technical learning, it can be expected that future electricity production costs will come down by a factor of two or more for most of these technologies. An overview of the kWh cost calculations is presented in Table 11.39.

It must be noted that corrosion issues and fouling can have a large impact on O&M costs and the capacity factor of the conversion system. Seawater is bad for electronic circuitry as well as for other parts of the system. Failure of the simplest, cheapest components can cause outage for long periods of time because bad weather, for example, can hinder and delay even minor repairs.

Tidal head electricity: Big barrage systems, have been estimated to have investment costs of US₂₀₀₅\$4000–6000/kW (Turkenburg et al., 2000; IEA-ETSAP, 2010) and a capacity factor of 25–30%, with resulting production costs of electricity of US¢10–31/kWh. The 254 MW Sihwa scheme under construction in South Korea is the only other large tidal barrage to be installed after the French La Rance scheme of the 1960s. The system is based on an existing barrage built primarily for flood control purposes, which thereby reduced its capital costs to the marginal cost of adding turbines and generating plant. Economic estimates, however, are not available. The Severn Barrage in the United Kingdom, which was assessed in 2010 for the UK government, would have been rated at 7000 MW and cost over US\$30 billion; it was rejected for governmental support primarily because it was evaluated to be uneconomical.

Tidal and ocean current electricity: Tidal and marine turbines are modular devices that may have individual power outputs in the 1–5 MW range and that are designed for build-out into arrays or “farms.” Therefore they can be built up incrementally into large projects eventually, allowing quicker start to the repayments compared with big barrage systems.

It is estimated that the initial investments for open ocean current energy systems may range from US₂₀₀₅\$7000–14,000/kW. Assuming a capacity factor of these systems of 70%, the initial kWh production costs would be US¢9–27/kWh. For tidal current systems, the initial investment costs will probably be lower, such as US\$5000–10,000/kW. However, the capacity factor will also be less: maybe about 35%. This would result in a kWh cost of US¢12–38/kWh. It should be noted that higher initial investment costs are mentioned in the literature than assumed here, up to US\$14,000/kW (Callaghan, 2006; IEA-ETSAP, 2010).

Wave power electricity: Wave power devices tend to be heavier than wind ones, because for a given power output they need to handle much larger forces, demanding more structural material. This gives wave energy a disadvantage if cost predictions are based on weight. Plants can run steadily for days, even weeks at a time. But because energy comes in pulses at twice the wave frequency, and wave amplitudes follow the Gaussian distribution, there are large power peaks – 10 or more times the mean values. Assuming present investment costs ranging from US₂₀₀₅\$6000–16,000/kW (Turkenburg et al., 2000; Callaghan, 2006; IEA-ETSAP, 2010) and a capacity factor of 25–35%, the initial electricity production cost could be US¢15–85/kWh. It is projected that energy generated by wave energy installations can reach an average price below about US¢13/kWh in the longer term (Sørensen and Weinstein, 2008). Harvey (2010) gives a longer term figure of US¢10–14/kWh.

OTEC electricity: Investment costs of initial commercial plants have been estimated at US\$6000–12,000/kW (see, e.g., Vega, 2002; Cooper et al., 2009). Assuming a capacity factor of 70%, this would result in production costs of US¢8–23/kWh.

Salient gradient electricity: No cost estimates have been completed for this technology, and thus no figures for the investment and kWh costs can be presented. It is estimated that the investment costs per kW will be substantially higher than for other mature renewable energy technologies, but this is compensated by the expected high capacity factor (80–90%).

It should be noted that the cost figures presented in Table 11.39 are higher than expected about 10 years ago, when the World Energy Assessment was published (Turkenburg et al., 2000). The main reasons are a steep increase in the overall investment costs and lack of technological learning, reflecting the relatively immature nature of these technologies.

Table 11.39 | Production cost of electricity as a function of capacity factor, turnkey investment costs, and discount rate. For all technologies, the annual O&M costs are assumed to be equivalent to 1% of the turnkey investment costs. The economic lifetime is assumed to be 40 years for tidal range, and 30 years for other systems.

Tidal head electricity (economic lifetime 40 years)			
Capacity factor	Turnkey investment costs (US ₂₀₀₅ \$)	Discount rate	
		5%	10%
30%	\$4000/kW	10.4¢/kWh	17.0¢/kWh
	\$6000/kW	15.5¢/kWh	25.6¢/kWh
25%	\$4000/kW	12.4¢/kWh	20.5¢/kWh
	\$6000/kW	18.6¢/kWh	30.7¢/kWh
Tidal current electricity (economic lifetime 30 years)			
Capacity factor	Turnkey investment costs (US ₂₀₀₅ \$)	Discount rate	
		5%	10%
35%	\$5000/kW	12.3¢/kWh	19.0¢/kWh
	\$10,000/kW	24.5¢/kWh	37.8¢/kWh
Ocean current electricity (economic lifetime 30 years)			
Capacity factor	Turnkey investment costs (US ₂₀₀₅ \$)	Discount rate	
		5%	10%
70%	\$7000/kW	8.6¢/kWh	13.2¢/kWh
	\$14,000/kW	17.1¢/kWh	26.5¢/kWh
Wave electricity (economic lifetime 30 years)			
Capacity factor	Turnkey investment costs (US ₂₀₀₅ \$)	Discount rate	
		5%	10%
35%	\$6,000/kW	14.6¢/kWh	22.7¢/kWh
	\$16,000/kW	39.1¢/kWh	60.5¢/kWh
25%	\$6000/kW	20.5¢/kWh	31.8¢/kWh
	\$16,000/kW	54.8¢/kWh	84.7¢/kWh
OTEC electricity (economic lifetime 30 years)			
Capacity factor	Turnkey investment costs (US ₂₀₀₅ \$)	Discount rate	
		5%	10%
70%	\$6000/kW	7.9¢/kWh	11.3¢/kWh
	\$12,000/kW	14.6¢/kWh	22.8¢/kWh

11.9.6 Sustainability Issues

All ocean energy technologies are able to support local energy supplies with almost no environmental emissions to the atmosphere during operation. Consequently, using ocean energy would contribute to reducing GHG emissions as well as acidification and other environmental problems associated with conventional energy use. Further development and deployment of these technologies can also contribute to regional and local economic development and employment. In coastal regions, the marine energy industry could create 10–20 jobs/MW (Sørensen and Weinstein, 2008).

Life-cycle assessments of tidal and wave energy conversion systems indicate GHG emissions ranging from about 15–50 gCO₂-eq/kWh and an energy payback time ranging from about 1–2.5 years (Raventós et al., 2010).

Locally ocean energy systems could also have some negative impacts that should be minimized. Tidal head energy systems, for example, when located in estuaries, will have an impact on currents and on sediment transport and deposits. Current subjects of investigation include the impacts of construction of the barrage on local biodiversity, of a large human-made seawater

lake behind the barrage, and of offshore tidal lagoon systems on fishing, fish, bird breeding, and feeding. Wave energy systems will have a visual impact when large arrays of floating devices are installed near shore.

Current energy devices are expected to have limited environmental impact. Underwater noise and vibrations can be a concern as well as impacts on fishing activities. To avoid accidents with surface vessels, these devices must be installed deep enough (resulting, however, in a lower energy yield) or be made to be surface-piercing and hence visible to shipping. For OTEC devices that use closed-circuit hydraulics, spills of working fluids or leakage is a subject for investigation.

The corrosive effects of seawater as well as debris and fouling are having an impact on the durability and performance of ocean energy systems and are issues of concern.

11.9.7 Implementation Issues

A major issue is the nascent stage of development of most ocean energy technologies, the high investments costs per kW, and the need to reduce these costs through R&D and learning by doing. Therefore government support is needed to bring promising technologies from the R&D phase to the stage of prototype and pilot plant developments. A drawback then could be the large diversity of technologies investigated. A barrier for early deployment can also be the remote location of most ocean energy systems, increasing installation costs but also the need to develop or adjust infrastructures to connect these systems to the grid. Yet some synergies may be found when also deploying wind turbines offshore. And the high predictability of energy supplies from these sources reduces system integration challenges. An advantage of tidal barrage systems can be the possible integration with energy storage (pumped hydro) to enlarge the flexibility in electricity supplies.

At a country level, high-quality resource assessment and inclusion of these technologies into energy development and planning portfolios is needed. Of the few countries that have completed these initial steps, the United Kingdom has set a target of 2 GW ocean capacity installed by 2020 (UKERC, 2008). Following this model, a strategy to commercialize and deploy ocean energy technologies should cover in principle all aspects of the innovation chain for emerging technologies, ranging from R&D and capacity building to, for example, the manufacturing of systems, the development of standards, and financial arrangements to facilitate high-volume deployment.

11.10 System Integration

11.10.1 Introduction

At present, only a handful of countries have non-traditional renewable penetration above 10% (with a few above 30%). A number of studies

suggest that this figure could steeply increase in the coming decades (see, e.g., Krewitt et al., 2009b; IEA, 2010a; ECF, 2010; Sims et al., 2011; see also Chapter 17). Because of the partly fluctuating nature of some renewable energy sources, ranging from minutes to annual seasons, a key challenge will be to match load and supply of energy properly.

Experience demonstrates that large shares of variable renewables are possible if appropriate measures are taken to support system integration. The common and historical use of hydroelectricity – in some countries providing more than 50% of the overall electricity supply – is an excellent example of how annual seasonal variation can be successfully managed. In 2007, about 20% of the Danish electricity demand was met by wind energy (IEA, 2008a), with instantaneous penetration levels exceeding 100% of electricity demand in the west. Only a few years earlier, such an achievement was considered impossible (IEA, 2008c).

The current energy supply system is capable of dealing with significant variability in demand by combining “base load,” “middle load,” and “peak load” power plants. With a growing contribution from renewable energies, the concept of base versus peak load power plants will become increasingly obsolete. The goal will be to guarantee firm capacity and supplies from a variety of energy technologies and sources such that a reliable and environmentally sound supply is achieved at competitive costs. Innovative ways to pool various decentralized renewable energy sources – such as energy storage options, advanced infrastructures (like “smart grids,” “virtual power plants,” and “microgrids”), and long-distance energy transport between supply and demand clusters (FOSG, 2010; ENTSO-E, 2010) – are required to integrate especially variable renewable energy sources into low-carbon energy supply systems (see, e.g., ECF, 2010; Sims et al., 2011).

A distinction can be made between renewables being dispatchable (having a high potential to deliver when needed) and variable (having a low potential to deliver on each moment). Hydropower, biomass energy, geothermal energy, and ocean energy options like OTEC are dispatchable renewables. Solar energy, wind energy, and ocean energy options like tidal range are variable renewables.

The integration of variable renewables into energy systems, which is most challenging, is the focus of this section, especially their integration into larger-scale electricity and thermal heating and cooling systems. Some aspects of integrating biofuels in liquid fuel transportation systems are discussed in Section 11.2. Integrating energy systems is discussed in Chapter 15.

11.10.2 Integration of Renewables into Electricity Supply Systems

Normally, electricity systems consist of a number of power plants (units) that generate electricity to fulfill load demands and a transmission and distribution system that can deliver the generated electricity

to customers. Two concepts are of special importance: unit commitment and load dispatch. When a unit is running, it is committed. It does not need to be generating power, but all the implications of its start-up have been accepted by the system operator. After carrying out the commitment procedure, the operator has to organize the dispatch of the load to all the running units. These procedures are essentially optimization problems. Solving these problems can be difficult, especially when high levels of renewable energy sources and energy storage are incorporated (Van Wijk and Turkenburg, 1992). The unit commitment problem can be defined as “commit the units in an order such that total fuel and start-up costs of the system are minimized;” the load dispatch problem is to “dispatch the load and the spinning reserve to all committed units, such that the total fuel costs are minimized.” Spinning reserve has to be available to cover power shortages caused by sudden outages of units or sudden sharp increases in the load (Van Wijk and Turkenburg, 1992).

Penetration of dispatchable renewables can take advantage of complementarity along the different periods of the year. In particular, biomass is harvested during part of the year to take advantage of its energy content and the better logistic facility. Harvesting time usually is coupled with bioenergy production, at least to reduce storage feedstock costs. On the other hand, hydroelectricity availability peaks during the rainy season and quite often at this time water supply exceeds demand or generation installed capacity. In some regions the harvest period for bioenergy feedstock occurs mainly during the low rain period, providing synergism of significant economic value, mainly when bioelectricity is one of the final energy forms obtained from biomass.

Deep penetration of variable renewables reduces the consumption of conventional fuels and the associated production of waste and emissions to the atmosphere. It also reduces somewhat the need for conventional power plants, because of the capacity credit of wind turbines and solar systems. However, it may also force dispatchable plants to contribute more to the spinning reserve and to operate in partial load, reducing conversion efficiencies and increasing fuel consumption. Enough backup power should be available to guarantee security of supply when solar or wind energy is not available. And there should be enough flexibility in the system to meet the variations in load and in availability of wind and solar resources. Finally, the transmission and distribution system should be able to cope with increases in distributed electricity generation associated with the use of renewables.

11.10.2.1 Distributed Electricity Generation

In conventional grid structures, electricity is fed into the grid at high voltage levels by relatively few large power stations and is brought to the customer via several intermediate grid levels. As generation becomes more widely distributed, the number of electricity sources increases and the direction of flow can be reversed. The distribution grids assume the function of transporting electricity in different (bidirectional) directions

and become service providers between generators and consumers. Central power stations will continue to exist, but in addition there will be a large number of smaller, distributed systems. This change requires investments in many high-voltage distribution lines when the supply comes from MW-size power plants and in coordination of the operation of a large number of systems in the electricity distribution and transportation networks, facilitated by adequate information and communication technologies (Degner et al., 2006). Current grids are not designed to allow major amounts of electricity to be fed into the distribution grid. However, several solutions are under development to solve this, including converter technologies that also provide ancillary services to the grid and control schemes that enable a high penetration of distributed generation. These approaches are integral to the development of so-called Smart Grids.

As defined by the European Technology Platform for Electricity Networks of the Future (also called Smart Grids ETP), “a Smart Grid is an electricity network that can intelligently integrate the actions of all users connected to it—generators, consumers and those that do both—in order to efficiently deliver sustainable, economic and secure electricity supplies.” A Smart Grid “employs innovative products and services together with intelligent monitoring, control, communication, and self-healing technologies to better facilitate the connection and operation of generators of all sizes and technologies, to allow consumers to play a part in optimizing the operation of the system, to provide consumers with greater information and choice of supply, to significantly reduce the environmental impact of the whole electricity supply system, and to deliver enhanced levels of reliability and security of supply” (Smart Grids ETP, 2010).

Quality of supply, power quality, grid control and stability, safety and protection, and standardization are considered the main challenges for a major deployment of decentralized generation. Scheepers et al. (2007) listed a number of ways to address these challenges:

- Active management of distribution systems to increase the accommodation of distributed generation (DG); typical examples are voltage control in rural systems and fault level control in urban systems through network switching;
- Development of intelligent networks where technological innovations on power equipment and information and communication technologies are combined to allow a more efficient use of distribution network capacities;
- Further development of the microgrid concept, based on the assumption that large numbers of micro-generators, connected to the network, can be used to reduce the requirement for transmission and high-voltage distribution assets;
- Pooling small (renewable energy) generators to create a virtual plant, either for the purpose of trading electrical energy or to provide system support services.

Microgrids are low-voltage or medium-voltage distribution systems with distributed generators, storage devices, and controllable loads. They are operated connected to the main power network or isolated from the main grid (Hatziaargyriou, et al., 2007; Hatziaargyriou, 2008; Microgrids, 2011). From the grid's point of view, a microgrid can be regarded as a controlled entity that can be operated as a single aggregated load or generator and, given attractive remuneration, as a small source of power.

Many system operators regard distributed generation as an additional complexity and thus fear additional costs (Scheepers et al., 2007). Nevertheless, distributed generation also offers potential benefits to electric system planning and operation. (See Table 11.40). However, the regulatory context is of key importance for deployment of distributed generation (Coll-Mayor et al., 2007).

11.10.2.2 Forecasting the Short-term Availability of Wind and Solar Energy

The availability of renewable energy resources, especially wind and solar, can vary dramatically (Holltinen et al., 2007). Technical options like load management, energy storage, and improved interconnection of grids help match supply and demand, but good information on the availability of renewable energy sources in space and time is required to apply these options optimally.

The challenge with variable renewable energy at present "is not so much its variability, but rather its predictability" (IEA, 2008). To facilitate system integration and to reduce related costs, it is necessary to predict the available variable power hours or days ahead as accurately as possible. Sophisticated wind forecasting tools are available today, and interest in forecasting solar radiation is rising in parallel to the market uptake of PV systems and concentrating solar thermal power plants. But predictability is not the only issue to be solved. Reliability is also important. Long periods of low wind or sun, even if predicted accurately, require the power system to meet demand by running other capacity or importing electricity from elsewhere, which imposes additional cost.

There are two main approaches for wind power prediction (Jursa and Rohrig, 2008). One uses physical models of wind farms to determine the relationship between weather data from a numerical weather prediction model and the power output of the wind farm. The other is a mathematical modeling approach, in which statistical or artificial intelligence methods, such as neural networks, are used to model the relationship between weather prediction data and power output from historical data sets. This is currently used by several transmission system operators in three European countries. Artificial neural networks provide a time series of the instantaneous and expected wind power for a control zone for up to 96 hours in advance (Rohrig and Lange, 2008). Use of this system in Germany to make predictions a day ahead resulted in errors of

Table 11.40 | Potential benefits of distributed generation.

Potential Benefit	Explanation
System reliability	DG can add to supply diversity. A distributed network of smaller sources may also provide a greater level of adequacy than a centralized system with fewer large sources. Reliability can also be enhanced if islanding is planned in case of faults.
Reduction in peak power requirements	Reduction in peak load can displace or defer capital investment, as the need for more expensive power plants is reduced.
Ancillary services	DG can provide ancillary services, particularly those that are needed locally, such as reactive power, voltage control, and local black start.
Power quality	DG can address power quality problems, particularly when the systems involve energy storage, power electronics, and power conditioning equipment. However, large-scale introduction of DG may also lead to instability of the voltage profile.
T&D capacity	DG can reduce transmission and distribution requirements and can contribute to reduced grid losses. On-site production of energy carriers can result in savings in T&D costs.

Source: based on US DOE, 2007; Pepermans et al., 2005; Rawson, 2004.

around 5% (root mean square error, in percent of the installed capacity) for the entire German system. In addition, short-term (15 minutes to 8 hours ahead) high-resolution forecasts of wind power generation are generated, taking into account data from online wind power measurements of representative sites. A number of short-term prediction tools, both physical and statistical, are currently in use in Denmark, Germany, United States, Spain, Ireland, and Greece (Costa et al., 2008).

The difference between the forecasted and instantaneous wind power production can be minimized with advanced control strategies of wind farms. Pooling of geographically distributed large wind farms in a portfolio of one supplier allows optimized control of variable generation. This minimizes imbalance penalties.

Solar forecasting is not yet as mature as wind forecasting, but several models are under development. In general there are two approaches: short-term forecasting (a few hours ahead) and medium-term forecasting (up to two days ahead) (Heinemann et al., 2006). Short-term forecasting can be based on satellite data about solar irradiation and an algorithm calculating the motion of clouds. This approach improves considerably the prediction accuracy with respect to assuming persistency (that is, irradiation at hour h is identical to that at hour $h-1$). When forecasting one hour ahead, a relative root mean square error of about 30% can be obtained for an area of 31×45 km², while for a six-hour forecast this error increases to 40–50% (Heinemann et al., 2006). Medium-term forecasting can be performed using weather forecasts, with a three-hour temporal and a $0.25^\circ \times 0.25^\circ$ spatial resolution. Lorenz et al. (2009) have shown that the relative root mean square error could be 36% for a single location in Germany for a one-day-ahead forecast. Taking the whole of Germany, this error would reduce to 13%.

Table 11.41 | Storage options in electricity systems.

Scale	Response time	Typical discharge times	Storage technologies	Applications
Very large scale	> 15 min	days to weeks	Hydrogen storage systems	Reserve power compensating for long-lasting unavailability of wind energy
Large scale	< 15 min	hours to days	Compressed air storage Hydrogen storage systems Pumped hydro	Secondary reserve Minute reserve Load leveling
Medium scale	1–30 sec ^a 15 min ^b	minutes to hours	Batteries (Li-ion, lead-acid, NiCd) High-temperature batteries Zinc-bromine batteries Redox-flow batteries	Load leveling Peak shaving

^a Primary reserve.

^b Secondary and minute reserve.

Source: Kleimaier et al., 2008; Leonard et al., 2008; Weimes, 2009.

11.10.2.3 Energy Storage Options

Energy storage in an electricity system allows generation to be decoupled from demand. Storage can also improve the economic efficiency and use of the entire system (Ummels et al., 2008). The broad range of available electricity storage technologies differ with respect to capacity, duty cycle, response time to full power, and load following capability.

Managing seasonal variation on electricity supply from hydro sources uses well-known storage procedures based in large water reservoirs able to keep above the average river flows due to either the rainy season or ice melting annual period, mainly in countries/regions with large penetration of this renewable source. Table 11.41 provides a summary of storage technologies appropriate for short periods compared with annual seasons and their typical applications.

Recent developments in electricity storage (see, e.g., Chen et al., 2009; Ibrahim et al., 2008; Meiwes, 2009) include the following:

- Adiabatic compressed air energy storage (CAES) incorporates compression heat into the expansion process and thus does not need additional fuel. The efficiency for adiabatic CAES is up to 70%.
- Lithium-ion batteries, with an efficiency of 90–95%, have become an important storage technology in portable applications.
- Redox-flow batteries allow the electrolyte to be stored in large tanks, making redox-flow batteries well-suited for large-scale applications. The system efficiency is in the range of 60–75%.

Hydrogen is considered a suitable storage option for fluctuating renewable electricity. The achievable energy density of compressed hydrogen is more than one order of magnitude higher than the one of compressed air. The storage of compressed hydrogen in salt caverns

is currently the only technology with a technical potential for single storage systems in the 100 GWh range (Kleimaier et al., 2008) and for long (seasonal) storage periods. Different electrolyser technologies are under development to produce hydrogen from electricity. The most efficient conversion back to electricity can be achieved in combined-cycle power plants or in fuel cells. Round-trip efficiencies are expected to be in the range of 35–40% (Kleimaier et al., 2008), but a demonstration project in Norway shows 10–20% (Ulleberg et al., 2010).

The economic performance of a storage system depends on operating conditions and system costs, which can vary depending on required volume, conversion and generation capacities, and response times.

Figure 11.70 shows life-cycle costs for two storage applications: longer-term storage (500 MW, 100 GWh, 200 hour full load, ~1.5 cycle/month) and load-leveling (1 GW, 8 GWh, 8 hour full load, 1 cycle/day) (Kleimaier et al., 2008; Meiwes, 2009). For each storage option, Figure 11.70 shows a range of costs that spans from a low value representing “achievable costs expected within 10 years” to a high value of present (2008) costs. The life-cycle costs have been calculated assuming 8% interest rate and investment cost for the storage system, including necessary auxiliary units, power converters, and interfaces to the grid (Leonard et al., 2008). Component replacement has also been included, as well as the electricity price needed to cover losses. In both storage applications, pumped hydro systems are reported to be the most economic option, assuming appropriate geographic conditions. For long-term storage, hydrogen benefits from low volume-related costs due to its high energy density compared with adiabatic CAES. For load leveling, however, compressed air appears viable.

Battery technologies also can be used for load leveling, but costs are in the range of US₂₀₀₈€6.5–10/kWh up to more than US₂₀₀₈€30/kWh, depending on the technology used, and thus are well above the costs shown in Figure 11.70.

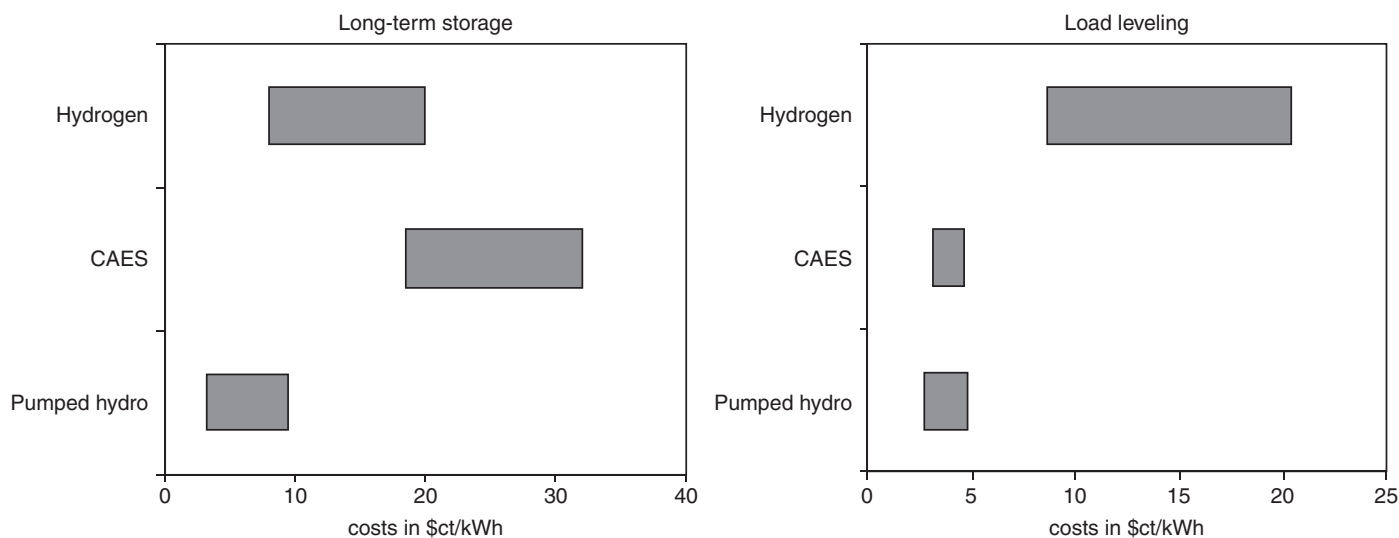

Figure 11.70 | Electricity storage costs for different storage options (US₂₀₀₈ \$/kWh). Source: Kleimaier et al., 2008; Leonard et al., 2008; Meiwes, 2009.

11.10.2.4 Vehicle-to-Grid Options

Because of the partly complementary nature of the electric power system and the light vehicle fleet, “vehicle-to-grid” (V2G) technologies may improve the ability of the electricity grid and the transportation system to integrate larger proportions of fluctuating renewables. The basic concept of vehicle-to-grid power is that electric vehicles (EVs) – including battery electric vehicles, fuel cell vehicles, and plug-in hybrids – can not only be charged by the grid but also can provide electricity and other services to the grid while parked. Each vehicle must have a connection to the grid for electrical energy flow, options for communication with the grid operators, and on-board control and metering devices. Figure 11.71 schematically illustrates the integration of electric vehicles and solar and wind technologies into an electricity supply system (Kempton and Tomić, 2005a).

Lund and Kempton (2008) show that wind electricity shares of more than 50% in the Danish power system lead to substantial excess wind power production, which reduces the revenues from wind electricity generation. The introduction of electric vehicles can reduce excess production. It can also improve the ability of power systems to integrate large proportions of wind power.

While the capital costs of power plants are high and thus motivate high use, personal vehicles are cheap per unit of power and are used only about 5% of the time for transportation, making them potentially available 95% of time for a secondary function (Kempton and Tomić, 2005a). Because vehicles have limited storage capacity and higher per kWh cost of energy than power plants, the generation of bulk power will not be the main business case for V2G concepts. V2G systems can, however, be competitive in providing spinning reserve and regulation capacity (Kempton and Tomić, 2005b; Dallinger, 2009).

11.10.2.5 Long-distance Electricity Transmission

While energy storage decouples supply and demand in time, transmission can decouple supply and demand in space. Transmission allows the pooling of different renewable energy sources, even on a transcontinental level (DESERTEC Foundation, 2011). Transmission distances have been limited because conventional alternating current transmission technology is suited to transmitting electricity only about 500 km. However, newer high voltage direct current (HVDC) technology can be used to link areas with large renewable resources to demand centers, thus facilitating the provision of dispatchable renewable bulk electricity over a larger distance (see Figures 11.71 and 11.72).

One of the advantages of HVDC is the low cost – in the range of US₂₀₀₅ \$0.7–2/kWh (for 700 TWh, 150 GW, 3000 km) – for transmission of very high power over very long distances (Asplund, 2007; Trieb and Müller-Steinhagen, 2007). The total losses for point-to-point transfer of power over 3000 km may be on the order of 5%. The loss rate increases with each injection/extraction point along the line (Klimstra and Hotakainen, 2011). Today’s HVDC schemes have a maximum power of 3000 MW and a transmission distance of around 1000 km. Unlike with alternating current cables, there are no physical limitations on the distance or power level for underground or submarine HVDC cables. HVDC can be used to transfer power from wind parks offshore and to strengthen the electricity grid in areas where overhead lines are not feasible. Maximizing implementation of HVDC, however, will require international coordination and cooperation on a master plan for developing and optimizing super-grids for long-distance transmission. Technical limitations exist that need to be addressed, as well as some regulatory obstacles and economic concerns (Van Hertem and Ghandhari, 2010).

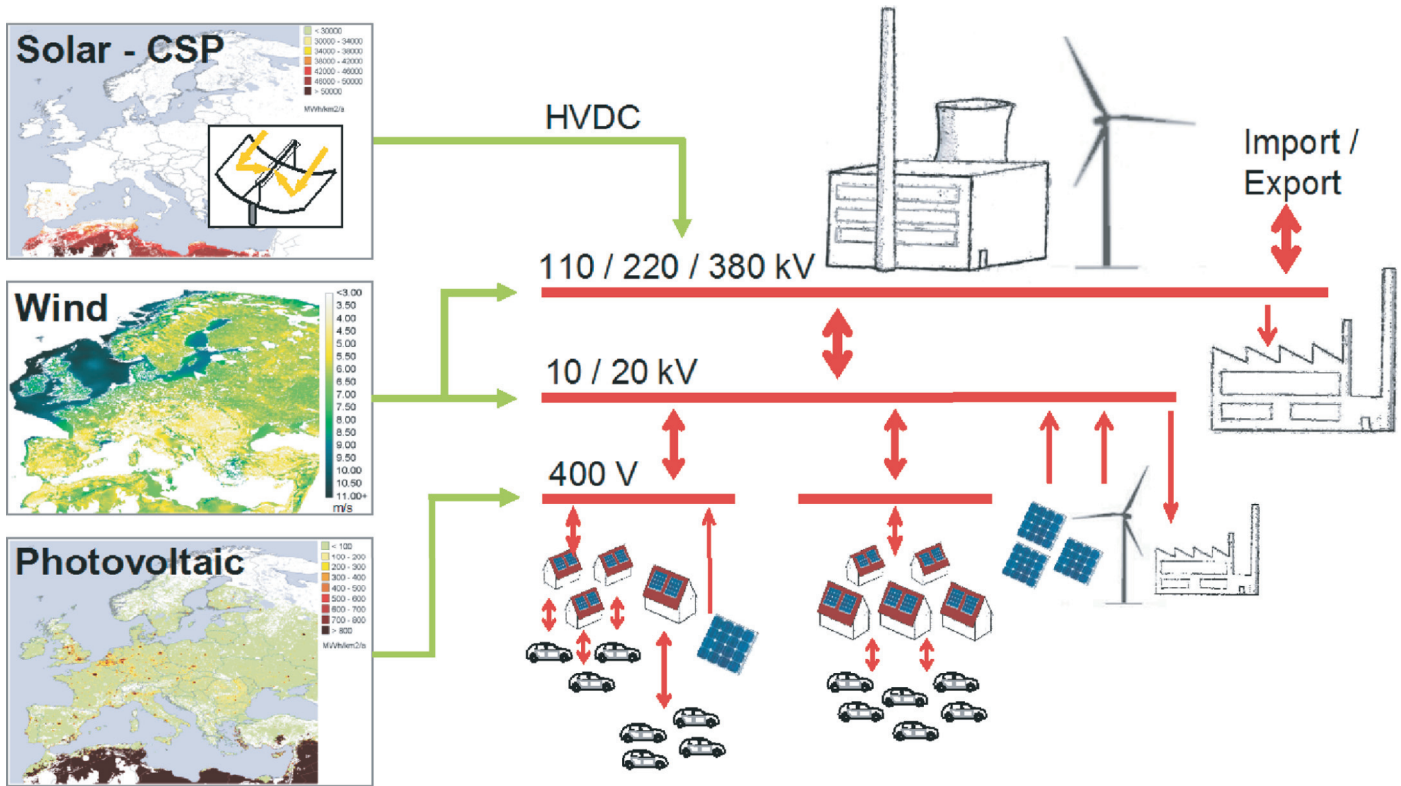

Figure 11.71 | Integration of renewables and electric vehicles into a supply system. Source: Sketch provided by Yvonne Scholz, German Aerospace Centre, 2011.

11.10.2.6 German Renewable Energy Combined Power Plant Demonstration Project

Following a 2006 German energy summit, leading German manufacturers of renewable energy technologies announced that they would prove the feasibility of a secure and constant provision of power using renewable energies only. The goal of the project was to demonstrate that the demand for electric power can be met fully by combining different forms of renewable electricity generation.

The so-called renewable energy Combined Power Plant (Combi-Plant) links and controls 36 wind (12.6 MW), solar PV (5.5 MW), biogas CHP (4 MW), and pumped hydro (1 MW) installations throughout Germany (Mackensen et al., 2008). (See Figure 11.73.) The plant is scaled to meet 1/10,000 of the electricity demand in Germany. This corresponds to the annual electricity requirements of a small town with around 12,000 households.

A central control unit is the core of the Combi-Plant. A control algorithm determines the optimum energy mix at any given point in time. Biogas and hydropower are used to balance fluctuations in wind and solar resources.

The Combi-Plant has been in operation since July 2007, and several months of real world operation were used to calibrate tools that control

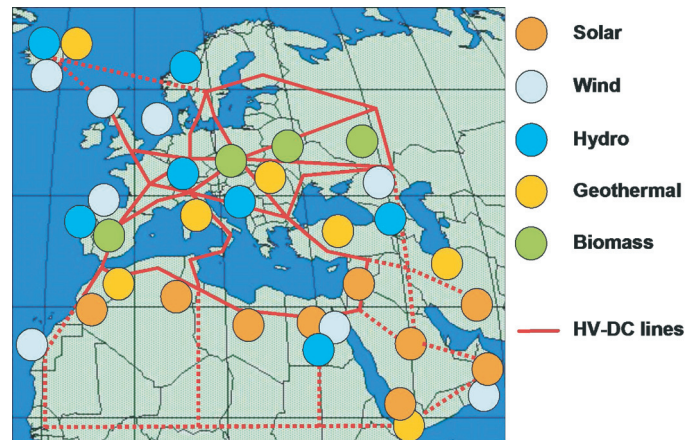

Figure 11.72 | Concept of a HVDC-based transcontinental "super-grid." Source: modified from Trieb and Müller-Steinhagen, 2007.

the plant. Figure 11.74 shows the simulated generation mix based on electricity demand data for 2006. Mackensen et al. (2008) conclude that the Combi-Plant is able to meet electricity demand entirely from renewable energy sources. The use of biogas, in particular, plays a central role in controlling the Combi-Plant by covering peak loads and balancing the natural fluctuations in wind and solar energy (Mackensen et al., 2008).

Combined Power Plant

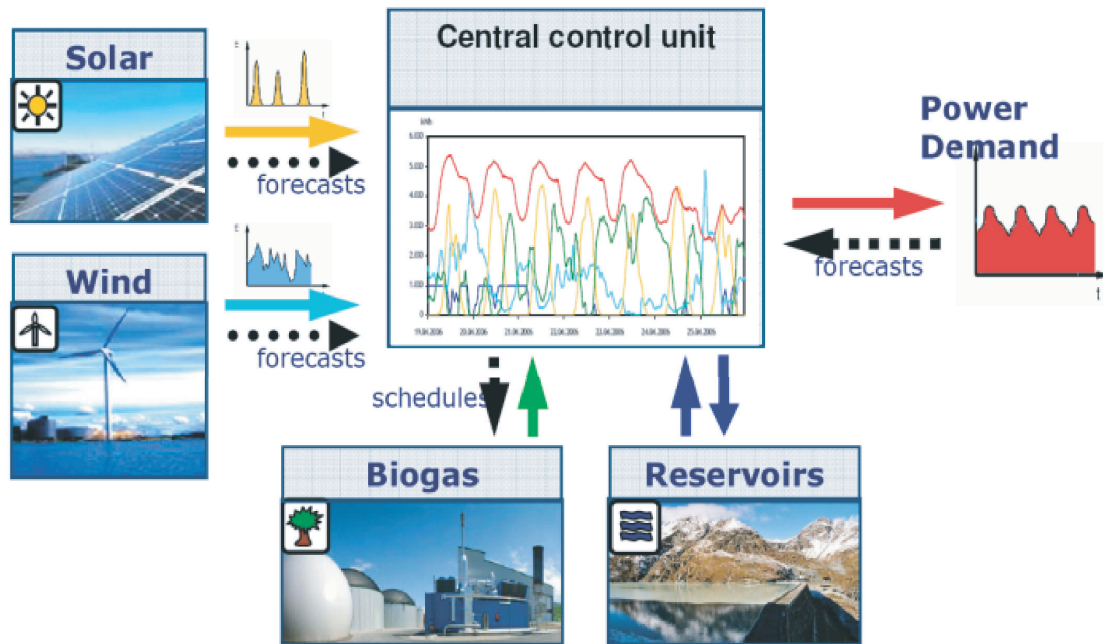

Figure 11.73 | The Renewable Combi-Plant. Source: Mackensen et al., 2008.

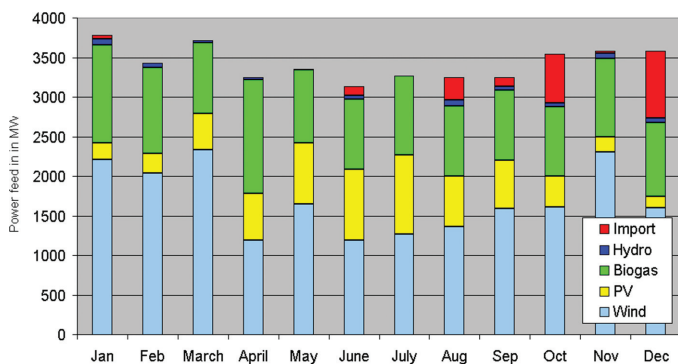

Figure 11.74 | Renewable energy mix of the Combi-Plant: simulation for 2006. Source: Mackensen et al., 2008.

11.10.3 Renewables in Heating and Cooling

Heating and cooling demands from the industrial, commercial, and domestic sectors constitute around 40–50% of global final energy demand (IEA, 2007). Although there is a large potential for renewables in this sector, the use of renewables for heating and cooling generally receives less attention than electricity generation or the production of biofuels for transportation.

Solar thermal, biomass energy, and geothermal heat can provide various categories and scales of heating and cooling services. (See Table 11.42.)

A key challenge is to match seasonal variations in demand and supply. The increasing use of renewable energies for heating and cooling – but also the intensified use of waste heat from industrial processes, the expansion of combined heat and power generation, and the growing demand for air conditioning – calls for more sophisticated interaction between energy demand and supply options.

A fully autonomous energy supply for buildings using locally available sources is feasible. In most regions, however, an independent off-grid supply system causes oversizing of the capacity to produce energy carriers from renewables, in order to overcome the seasonal mismatch of demand and supply. In areas with an existing infrastructure, bringing together a variety of demand and supply options may facilitate the cost-effective integration of renewables, as complementary supply and demand patterns can help reduce system requirements.

The design, costs, and operation strategies of integrated renewable heating and cooling systems depend on local conditions – that is, the availability of renewable resources and the demand for heating and cooling services as a function of time.

11.10.3.1 Renewables in District Heating and Cooling Systems

The potential of renewable heating can be fully exploited primarily in settlement areas having a district heating system, in which centralized

Table 11.42 | Suitability of renewable energy resources for various categories and scales of heating and cooling.

Sector	Solar thermal	Solid biomass	Biogas	Biomass from waste	Shallow geothermal	Deep geothermal
Dwellings	✓	✓	(✓)		✓	
Settlements (district heat)	✓	✓	✓	✓	✓	✓
Commerce and services	✓	✓	✓		✓	
Agriculture	✓	✓	✓	✓	✓	✓
Industry	✓	✓	✓	✓		✓

Source: IEA, 2007.

plants create and distribute heat to residential and commercial customers. These systems are considered more efficient than distributed systems, such as boiler systems. Temperatures provided by them are typically 80–90°C, with about 45–60°C in the return system.

Figure 11.75 shows that world district heating supplies are about 10–11 EJ a year. District heating meets much of the heat demand of the residential, service, and other sectors in Iceland (94%), Russia (63%), Sweden (55%), Lithuania (50%), Finland (49%), and Poland (47%) (Euroheat & Power, 2007). The energy source can be fossil fuels, waste heat, biomass, geothermal energy, and (partly) solar thermal energy.

In the case of deep geothermal heat, a large demand is required to compensate for high drilling costs. In most cases, such a demand is only present in district heating networks. Selling waste heat might be crucial for the economic performance of geothermal electricity production, and that is possible only if large consumers or networks of consumers are available. It should be noted, however, that heating and cooling of buildings can also be achieved by applying heat pumps and using near-surface geothermal energy (see Section 11.4). Moreover, improving the building envelope to reduce heating and cooling needs will influence the competitiveness of district heating systems.

As with deep geothermal heat sources, the scale provided by district heating systems is a prerequisite for the economical integration of large-scale solar thermal systems with seasonal storage. In this case, large scale assumes solar meets 50% or more of the total heat demand. The energy gained by the solar collectors can be delivered via a collecting network to the heating central (see, e.g., Bodmann et al., 2005). From there, heat either can be supplied directly to the consumer or, in summer, stored for use in autumn and winter. A gas or biomass boiler can cover the remaining heat demand. A key component in such a system is the seasonal heat storage.

A district cooling system distributes cold from a central source to multiple buildings through a network of underground pipes. The distribution medium in this case is usually chilled water, which is typically generated by compressor-driven chillers, absorption chillers, or other sources like ambient cooling or “free cooling” from deep lakes, rivers, aquifers, or oceans. The temperature of the supply system is normally 1–7°C, while

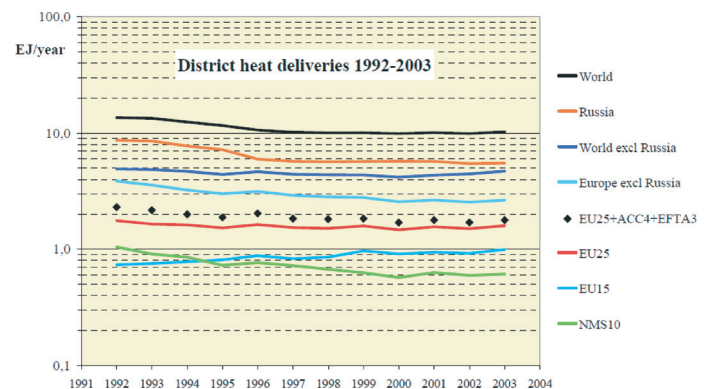

Figure 11.75 | Development of district heat in various parts of the world, 1992–2003. Source: Ecoheatcool, 2005–2006.

the return system is at 8–12°C (IEA-DHC, 2002; IEA, 2009). Cold water from the sea or a lake is applied in a number of projects in Sweden and other countries (see Section 11.9).

11.10.3.2 Thermal Energy Storage Options

The capacity of thermal storage systems ranges from a few kWh up to a GWh, the storage time from minutes to months, and the temperature from –20°C up to 1000°C. Capacity depends in part on the storage materials – solid, water, oil, salt, air – each of which has its own mechanism to store thermal energy. In household applications, water is almost exclusively the medium to store heat.

Storage systems may also rely on sorptive heat storage or latent heat storage (using so-called phase change materials). Both of these options allow thermal storage for an almost unlimited period of time but are at present in early development (Sharma et al., 2009).

The development of very large systems for seasonal heat storage has shown considerable progress in the last few decades. Various demonstration plants have been built. Four different storage types have been developed (Bauer et al., 2007, 2010; Mangold, 2007):

- *Hot water heat storage* has the widest range of possibilities, as it is independent of geological conditions and can be used in small

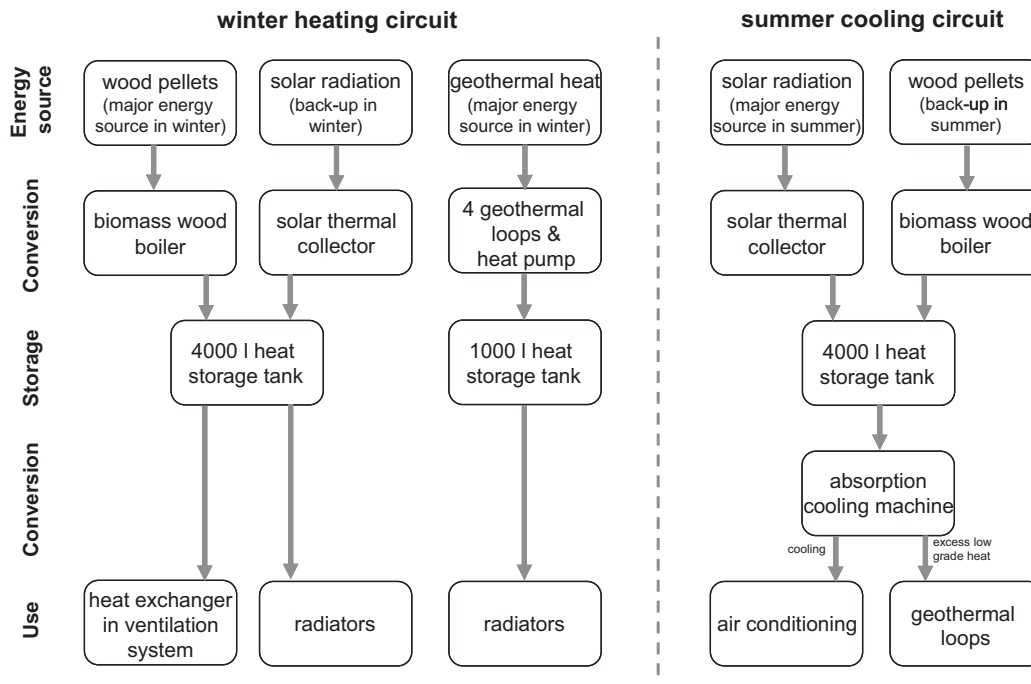

Figure 11.76 | Renewable heating and cooling system in the Renewable Energy House, Brussels, Belgium. Source: adopted from EREC, 2008.

amounts, such as heat storage for a period of days. It consists of a water-filled containment of steel-enforced concrete, which is partly submerged into the ground.

- *Gravel/water heat storage* consists of a pit sealed with a water-proof synthetic foil, filled by a storage medium of gravel and water.
- Using *borehole thermal energy storage*, heat is conducted via U-tube probes directly into water-saturated soil. These polybutane tubes are inserted into bore holes with a diameter of 10–20cm, which are 20–100m deep. The operational behavior is slow, as heat transport within the store occurs mainly by conduction.
- *Aquifer heat storage* uses natural layers of underground water to store heat. Water is taken out of the aquifer through well boreholes, heated, and then pumped back into the store through another borehole.

The suitability of a storage system depends on local geological and hydro-geological conditions.

Both ice and chilled water storage are used in district cooling plants. Chilled water storage systems are generally limited to a temperature of 4°C due to density considerations. Ice-based storage systems can achieve temperatures of 0.5–1°C. The cool storage is most commonly sized to shift part of the cooling load, which allows the chillers to be sized closer to the average than the peak load (IEA-DHC, 2002). An alternative can be to store cold underground or in aquifers. In Europe, this technology is most widely applied in Sweden (Norden, 2006).

11.10.3.3 Two System Integration Case Studies

The Renewable Energy House in central Brussels is an office building with meeting facilities of approximately 2.800 m². The plan for refurbishing the 140-year-old building was designed to reduce the annual energy use for heating, ventilation, and air conditioning by 50% compared with a reference building and to cover energy demand for heating and cooling with 100% renewable energy sources (EREC, 2008). Key elements of the system, illustrated in Figure 11.76, are two biomass wood pellet boilers (85 kW + 15 kW), 60 m² solar thermal collectors (30 m² evacuated tube collectors, 30 m² flat plate collectors), four geothermal energy loops (115m deep) exploited by a 24 kW ground source heat pump in winter and used as a “cooling tower” by the thermally driven cooling machine in summer, and a thermally driven absorption cooling machine (35 kW cooling capacity at 7–12°C).

In winter, the heating system mainly relies on the biomass pellet boilers and the geothermal system. The solar system and the biomass boilers heat the same storage tank, while the geothermal system operates on a separate circuit. The core of the cooling system is the thermally driven absorption cooling machine, which is powered from relatively low temperature solar heat (85°C) and a small amount of electrical power for the control and pumping circuits. Because solar radiation and cooling demands coincide, the solar thermal system provides most of the heat required for cooling. The solar system is backed up on cloudy days by the biomass boiler. The geothermal borehole loops absorb the low-grade excess heat from the cooling machine, thus serving as a seasonal heat storage system in the winter.

In Crailsheim, Germany, a former military area is currently being transferred into a new residential area in which more than half of the total heat demand will be covered by solar energy. A prerequisite for achieving such high solar shares is the use of a seasonal heat storage facility. The new residential area consists of former military barracks, a school and a sports hall equipped with 700 m² of solar collectors, and new single-family buildings. The residential area is separated from a commercial area by a noise protection wall, which houses the main part of the solar collectors. The first phase of the project focuses on 260 housing units with an expected total annual heat demand of 4100 MWh. The total solar collector area is 7300 m². A borehole thermal energy storage system with 80 boreholes at a depth of 55m provides seasonal storage. In a second phase, the residential area is extended by 210 housing units. The total collector area will then be around 10,000 m², and the seasonal storage system will consist of 160 boreholes. The solar system is separated into diurnal and seasonal parts. Solar heat costs are estimated to be around US₂₀₀₅¢15/kWh (Mangold and Schmidt, 2006; Mangold 2007).

11.10.4 The Way Forward

Various studies on the integration of renewables into electricity grids focus on the challenges it poses and inform strategies on how to proceed. A number of studies have assessed the impacts of up to 35% renewables in the western and eastern grid areas of the United States (EnerNex, 2010; IEEE, 2009; Pivko et al., 2010). The main findings were that renewable energy represents a near-term, leveragable opportunity, provided that issues like siting, access to transmission, and systems operations are well addressed (Pivko et al., 2010). Renewable energy penetration on the order of 30–35% (30% wind, 5% solar) is operationally feasible, assuming significant changes to current operating practice (NERC, 2008; Arent, 2010). NERC (2008) made several specific recommendations:

- Diversify supply technologies across a large geographical region to leverage resource diversity.
- Use advanced control technology to address ramping, supply surplus, and voltage control.
- Ensure access to and the installation of new transmission lines.
- Add flexible resources, such as demand response, V2G systems, and storage capacity.
- Improve the measurement and forecasting of variable generation.
- Use more-comprehensive system-level planning.
- Enlarge balancing areas to increase access to larger pools of generation and demand options.

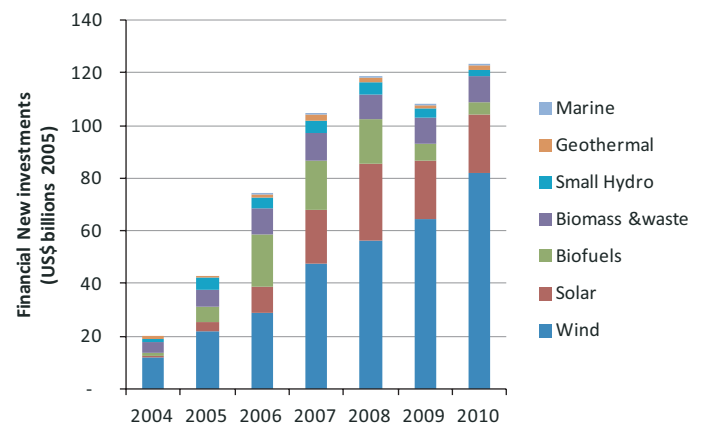

Figure 11.77 | Financial New Investments in New Renewable Energy, 2004–2010 (US₂₀₀₅\$ bn). Note that investments in larger-scale hydropower (>50MW) are excluded. Source: UNEP and BNEF, 2011.

Recent investigations are focusing on system-level solutions, in which information technology-enabled power management, advanced forecasting, adaptive and shiftable loads, and advances in energy storage go hand in hand in moving toward power systems with a larger share, possibly a majority, of renewable generation (Denholm et al., 2010; US DOE, 2010b; Krewitt et al., 2009a; Sterner, 2009).

Another important development is the European Electricity Grid Initiative, which is aiming in vision and strategy to enable high penetration rates of renewables (EEGI, 2010) through the integration of national networks into a market-based pan-European network.

11.11 Financial and Investment Issues

11.11.1 Introduction

This section provides information on developments in financing renewable energy for the period 2004–2010. A breakdown of global transactions in non-hydro renewables in 2010 is also shown. The section then describes trends in public policies and public finance mechanisms that aim to stimulate private investments in renewables. From the results, it is clear that – in terms of investments – renewables have become a mainstream energy option.

11.11.2 Commercial Financing

The renewable energy sector has mostly seen increasing levels of financing in the past 10 years. Figure 11.77 shows the trend for financial new investments in new renewables (excluding large hydropower, governmental and corporate R&D, small projects, and solar water heaters) for the period 2004–2010, with a breakdown for different technologies. Between 2004 and 2010 financial new investment increased six-fold to

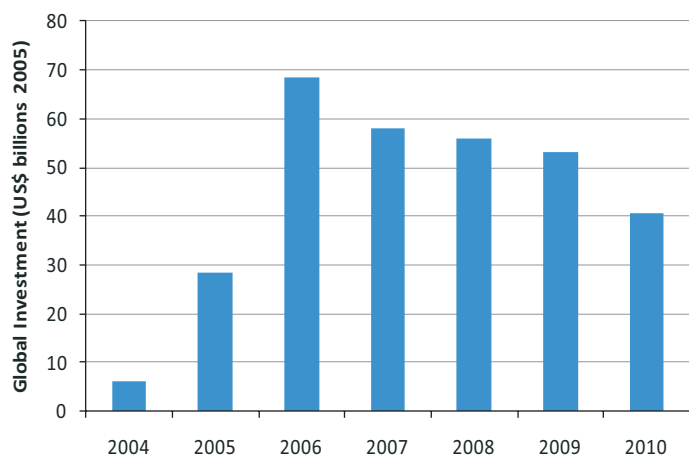

Figure 11.78 | Investments in larger-scale hydropower, 2004–2010 (US₂₀₀₅\$ bn). Source: based on International Journal of Hydropower and Dams Annual Directory, 2004; 2005; 2006; 2007; 2008; 2009, estimating US\$1500/MW average cost of new plant and UNEP and BNEF (2011) for the 2010 value.

US₂₀₀₅\$123 billion, indicating a compound annual growth rate of 36% (UNEP and BNEF, 2011).¹⁰

Figure 11.78 shows similar investment data for larger-scale hydroelectricity generating capacity for the period 2004–2010. Reporting investment figures in hydropower on a year by year basis is not easy due to the relatively long building time of hydro developments. Generating capacity can also be added at established dams, and progress on both activities is rarely reported annually.

Government and corporate R&D and small projects totaled US₂₀₀₅\$59 billion in 2010, while investments in solar water heater were estimated at US₂₀₀₅\$9 billion (UNEP and BNEF, 2011). Including estimated new investments in larger-scale hydropower of US₂₀₀₅\$40 billion, the total new investment in renewables in 2010 was about US₂₀₀₅\$230 billion.

A regional breakdown of financial new investments in renewables for the period 2004–2010 is presented in Figure 11.79. It shows strong increases in total investments in Asia and Oceania but stagnation in 2008–2010 in North America, Europe, and South America.

Figure 11.80 provides a breakdown of the total investment of US₂₀₀₅\$182 billion in 2010 by different financing type: venture capital investments (\$2 billion), corporate and governmental R&D support (\$3 billion and \$5 billion, respectively), private equity investments (\$3 billion), public equity investments (\$13 billion), asset finance (\$110 billion), and investment in small distributed capacity (\$52 billion).

¹⁰ For conversion of current value US\$ to US₂₀₀₅\$ throughout this section the international time series of USDA www.ers.usda.gov/Data/Macroeconomics/ was used (downloaded in August 2011). In US₂₀₁₀\$ Financial new investment was \$143bn, plus \$68bn in Governmental and corporate R&D and Small projects and an estimated 10bn\$ decentralized and small scale investment in solar water heater.

Different forms of financing are used for technology development and commercialization, equipment manufacture and scale-up, project construction, and re-financing and sale of companies (mergers and acquisitions, or M&A). This last category is not shown in the Figures since it does not represent new investment in the sector but rather a recycling of funds between early investors and those that later buy them out. The trends in financing along this continuum represent successive steps in the innovation process and provide indicators of the sector's current and expected growth as follows (see also Mitchell et al, 2011):

- Trends in technology investment indicate the mid- to long-term expectations for the sector – investments are being made in new technology developments that will only begin to pay off several years down the road.
- Trends in manufacturing investment indicate near-term expectations for the sector – essentially, that market demand will be sufficient to justify new manufacturing capacity.
- Trends in new project investment indicate current sector activity – that is, the number of new renewable energy plants being constructed.
- Trends in industry mergers and acquisitions indicate the overall maturity of the sector, since increasing refinancing activity over time shows that larger, more conventional investors are entering the sector, buying up successful early investments from first movers.

Each of these trends is discussed in the following sections.

Table 11.43 provides information about the variety of financing types, arranged by phase of technology development. An important catalyst that will influence these trends is the price of fossil fuels, particularly oil and gas. As “easy oil” becomes scarce, the dependence on fossil fuel imports increases and environmental emissions decrease; renewable energy investments in all four dimensions are also expected to increase (see, e.g., REN21, 2010). However, the availability and pricing of natural gas present competitive challenges to the attractiveness of investing in renewable energy technologies.

11.11.2.1 Financing Technology Development and Commercialization

While governments fund most of the basic R&D, and large corporations fund applied or “lab-bench” R&D, venture capitalists begin to play a role once technologies are ready to move from the lab-bench to the early market deployment phase (Mitchell et al., 2011). According to Moore and Wüstenhagen (2004), venture capitalists have initially been slow to pick up on the emerging opportunities in the energy technology sector, with renewable energies accounting for only 1–3% of venture capital investment in most countries in the early 2000s. Since 2002, however, venture

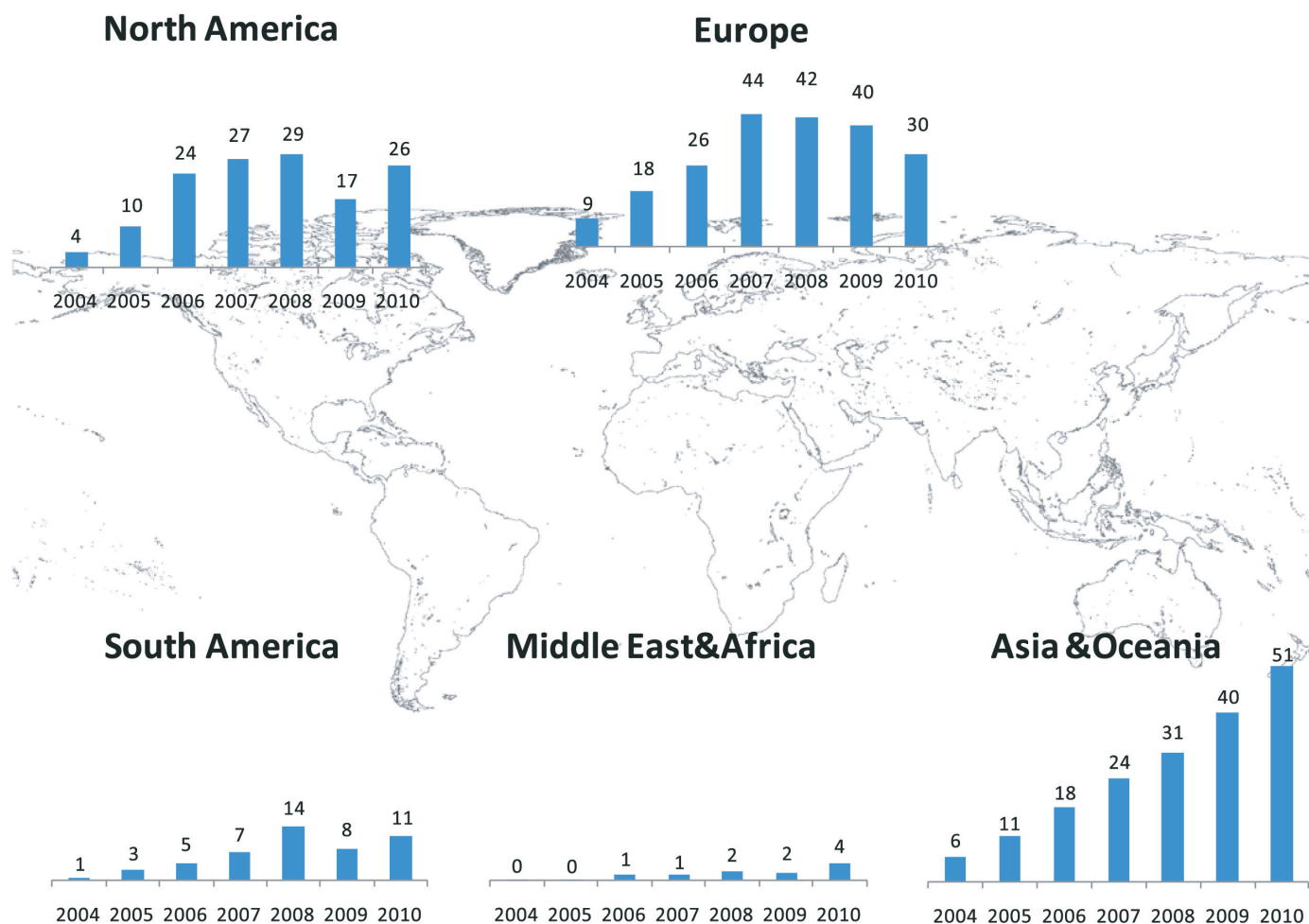

Figure 11.79 | New financial investments in renewable energy, by region, 2004–2010 (US\$₂₀₀₅bn). New investment volume adjusts for reinvested equity; total values include estimates for undisclosed deals. This comparison does not include small-scale distributed energy projects or larger-scale hydropower investments. Source: UNEP and BNEF, 2011.

capital investment in RE technology firms has increased markedly. Venture capital into RE companies grew from about US₂₀₀₅\$400 million in 2004 to US₂₀₀₅\$2.2 billion in 2010, representing a compound annual growth rate of 33% (UNEP and BNEF, 2011). This growth trend in technology investment has been an indicator that the finance community expects continued growth in the RE sector. Downturns such as those experienced in 2008/2009 may slow or reverse the trend in the short term, but in the longer term an increasing engagement of financial investors is foreseen in RE technology development (UNEP and BNEF, 2010; 2011).

11.11.2.2 Financing Equipment Manufacturing and Scale-up

Once a technology has passed the demonstration phase, the capital needed to set up manufacturing facilities will usually come initially from private equity investors (those financing un-listed companies) and subsequently from public equity investors buying shares of companies listed on public stock markets (Mitchell et al., 2011). Private and public equity investment in RE grew from about US\$1 billion in 2004 to US\$16

billion in 2010, representing a compound annual growth rate of 68% (UNEP and BNEF, 2011).

As discussed in Mitchell et al. (2011), in 2008 and 2009 the trading prices of shares in publicly listed companies on the global stock markets in general dropped sharply from the peaks of 2007, but RE shares fared worse due to the initial energy price collapse and the fact that investors shunned stocks with any sort of technology or execution risk, particularly those with high capital requirements (UNEP and BNEF, 2010). By 2010, even with the overall financing picture for renewables much improved, the prices of publicly traded stocks remained depressed largely due to concerns over changes in subsidy regimes and the lower profit margins that manufacturers were earning in many countries (UNEP and BNEF, 2010).

11.11.2.3 Financing Project Construction

Financing construction of renewable energy generating facilities involves a mix of equity investment from the owners and loans from the banks

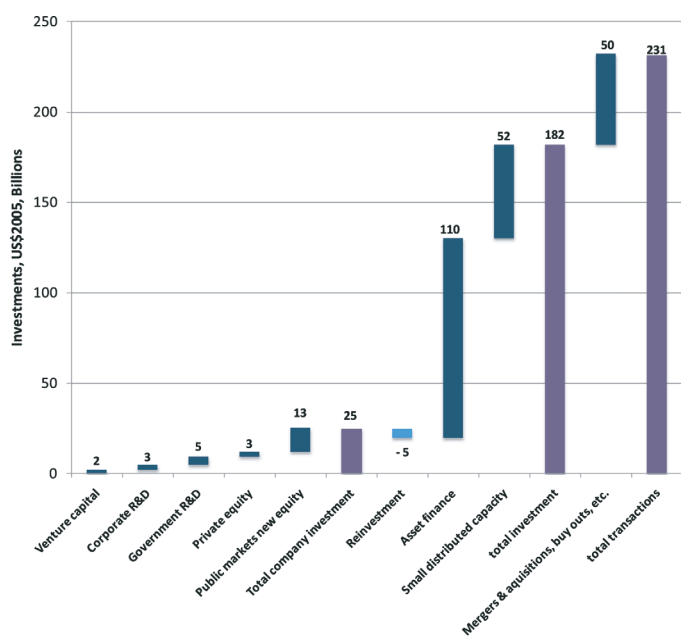

Figure 11.80 | Global Transactions in Renewable Energy in 2010 (US₂₀₀₅\$ bn). Includes all investments as well as acquisition. Source: UNEP and BNEF, 2011.

(private debt) or capital markets (public debt raised through bond offerings). The share of equity and debt in a project typically ranges from 20/80 to 50/50, depending on the project context and the overall market conditions. Both types of finance are combined into the term “asset finance,” which represents all forms of financing secured for renewable energy projects (Mitchell et al., 2011).

Asset financing to this sector grew from US₂₀₀₅\$18 billion in 2004 to US₂₀₀₅\$110 billion in 2010, representing a compound annual growth rate of 35% (UNEP and BNEF, 2011). In recent years capital flows available to RE projects have become more mainstream and have broadened, meaning that the industry has access to a far wider range of financial sources and products than it did around 2004/2005 (UNEP and BNEF, 2011). For instance the largest component of total renewable energy capital flows today is through project finance investment (Deutsche Bank, 2010a,b), an approach that mobilizes large flows of private-sector investment in infrastructure (Mitchell et al., 2011).

11.11.2.4 Financing Small-scale Technology Deployment

Consumer loans, micro-finance, and leasing are some of the instruments that banks offer to households and other end-users to finance the purchase of small-scale technologies. (See Box 11.3) But most investment in such systems comes from the end-user themselves, usually through purchases made on a cash basis. UNEP and BNEF (2011) estimates that US₂₀₀₅\$52 billion was invested in 2010 in small-scale RE projects (“small distributed capacity”), up from US₂₀₀₅\$9 billion in 2004, representing a compound growth rate of 34%.

Table 11.43 | Overview of financing types arranged by phase of technology development.

Development Phase	Financing Types
R&D	Public and corporate R&D support to (further) develop technology is provided through a range of funding instruments.
Technology Commercialization	Venture capital is a type of private equity capital typically provided for early-stage, high-potential technology companies in the interest of generating a return on investment through a trade sale of the company or an eventual listing on a public stock exchange.
Equipment Manufacturing and Scale-up	Private equity investment is capital provided by investors and funds directly into private companies often for setting up a manufacturing operation or other business activity. (This can also apply to project construction.) Public equity investment is capital provided by investors into publicly listed companies most commonly for expanding manufacturing operations or other business activities, or to construct projects. (This can also apply to project construction.)
Project Construction	Asset finance is a consolidated term that describes all money invested in generation projects, whether from internal company balance sheets, from debt finance, or from equity finance. Project finance is debt obligations (loans) provided by banks to distinct, single-purpose companies, whose energy sales are usually guaranteed by power off-take agreements. Often known as off-balance sheet or non-recourse finance, since the financiers rely mostly on the certainty of project cash flows to pay back the loan. Corporate finance is debt obligations provided by banks to companies using “on-balance sheet” assets as collateral. Most mature companies have access to corporate finance but have constraints on their debt ratio and therefore must rationalize each additional loan with other capital needs. Bonds are debt obligations issued by corporations directly to the capital markets to raise financing for expanding a business or to finance one or several projects.
Small-scale Technology Deployment	Small and medium-size enterprise finance is realized in different forms – such as consumer loans, micro-finance, and leasing – and is generally provided to help companies set up the required sales and service infrastructure.
Carbon Mitigation	Carbon finance can be in the form of loans or investment obtained from some banks or investors in return for future carbon revenue streams. Examples include the CDM and JI under the Kyoto Protocol.
Refinancing and Sale of Companies	Mergers & acquisitions involve the sale and refinancing of existing companies and projects by new corporate buyers.

Source: adapted from Sonntag-O’Brien and Usher, 2004.

An interesting development, especially with decentralized solar technologies, is the advent of new small-scale financing approaches. In industrial countries, solar equipment manufacturers in the United States have led the way, realizing that they could help overcome capital-cost barriers by acting as financial intermediaries. One of the main financing tools used is the third-party power purchase agreement, which by some estimates drove 60% of the solar capacity installed in California in 2007 (Deutsche Bank, 2010a). Under a third-party power purchase agreement, a third party designs, builds, owns, operates, and maintains

Box 11.3 | End-user Financing for Small-scale Renewables

Many developing countries have rural electrification programs today, and an increasing number of these rely on renewables and distributed financing models to provide access in off-grid areas. Besides electrification, many other clean energy systems and services are being installed with a range of end-user finance approaches.

For example, in Tunisia UNEP has jointly run the Prosol Solar Water Heating Programme with the energy agency and electric utility, helping realize over 95,000 household installations through bank financing made via customer utility bills. UNEP has also run a loan program with two of India's largest banking groups, Canara Bank and Syndicate Bank, helping to kick-start the consumer credit market there for solar home system financing. More than 19,000 homes were financed over three years, and the market continues to grow, with other banks now beginning to lend. Today UNEP has 20 such small-scale end-user finance programs operating in the developing world.

Source: Haselip et al; 2011

the solar systems and sells back solar-generated electricity to the end-user. This model removes the burden of significant upfront costs from the end-user and also allows the solar contractor, who has significantly greater expertise than the end-user, to assume the responsibility for system installation and maintenance (UNEP, 2008).

11.11.2.5 Financing Carbon Mitigation

The carbon markets include a range of instruments used to monetize the CO₂ offset value of climate mitigation projects. According to the World Bank (2009), the primary carbon markets associated with actual emission reductions – the CDM, joint implementation (JI), and voluntary transactions – decreased from US\$8.2 billion in 2007 to US\$7.2 billion in 2008.

According to the UNEP Risø CDM Pipeline Analysis (UNEP Risø, 2011), renewable energy projects now account for the majority of CDM projects, with 60% of all validated and registered CDM projects, 35% of expected certified emissions reductions (CERs) by 2012, and 13% of CERs issued to date. The low share of CERs issued is mostly due to the very large industrial gas mitigation projects that have been small in number but quick to build, accounting for 75% of CERs issued to date.

The Risø CDM Pipeline Analysis has also calculated the total underlying investment associated with building the proposed 4968 carbon mitigation projects that have reached at least the CDM validation stage in 2010. Of the US\$60 billion of total projected investment, US\$39 billion (65%) is for renewable energy projects.

11.11.2.6 Refinancing and the Sale of Companies

In 2010, about US₂₀₀₅\$50 billion worth of mergers and acquisitions took place involving the refinancing and sale of renewable energy companies

and projects, up from about US₂₀₀₅\$6.5 billion in 2004, for 41% compound annual growth (UNEP and BNEF, 2011). M&A transactions usually involve the sale of generating assets or project pipelines or of companies that develop or manufacture technologies and services. Increasing M&A activity in the short term is a sign of industry consolidation, as larger companies buy out smaller, less well capitalized competitors. In the longer term, growing M&A activity indicates the increasing mainstreaming of the sector, as larger entrants prefer to buy their way in rather than developing businesses from the ground up (Mitchell et al., 2011).

11.11.3 Linking Policy and Investments

Policies and their design play an important role in improving the economics of renewable energy systems, and as such they can be central to catalyzing private finance and influencing longer-term investment flows. Stern (2009) has proposed that governments have a role to play in reducing the cost of capital and improving access to it by mitigating the key risks associated with renewable energy investments, particularly non-commercial risks that cannot be directly controlled by the private sector. FITs, for instance, have been found to be particularly effective for mobilizing commercial investment (REN21, 2010). They enhance the possibility of project financing, as the guaranteed cash flow increases the willingness of banks to lend money (Deutsche Bank, 2010a; Couture 2010).

Private-sector investment decisions are underpinned by an assessment of risk and return. Financiers want to make a return proportional to the risk they undertake; the greater the risk, the higher the expected return (Justice, 2009). Expectations about the level of risk that will be taken, and the returns required, vary with different financial institutions. A policy framework to induce investment will need to be designed to reduce risks and enable attractive returns and to be stable over a time frame relevant to the investment. To be fully effective, or "investment grade,"

a policy needs to cover all the factors that are relevant to a particular investment or project (Hamilton, 2009).

11.11.4 Public Financing

The most important role of governments may be to create an enabling environment (a “policy framework”) to achieve accepted policy objectives. For many countries, however, creating enabling policies on their own may be insufficient to mobilize the many types of investment needed to move a technology from innovation to deployment to market transformation. Public funding and related interventions may therefore be needed to bring down market barriers, bridge gaps, and share risks with the private sector (UNEP, 2008a).

Public finance mechanisms (PFMs) have a twofold objective: to directly mobilize or leverage commercial investment into renewable energy projects and to indirectly create scaled-up and commercially sustainable markets for these technologies. To make the best use of public funding, it is essential that both these outcomes are sought when designing and implementing such mechanisms. For example, direct short-term benefits should not create market distortions that indirectly hinder the growth of sustainable long-term markets (UNEP, 2008a).

There is a growing body of experience with the use of PFMs for promoting investments in renewable energy deployment. Their role is to help commercial financiers act within a national policy framework, filling gaps and sharing risks where the private sector is initially unwilling or unable to act on its own (UNEP, 2008a).

According to UNEP (2008a), the following are the most common types of PFMs used to mobilize investment in climate change mitigation broadly, all of which are relevant to the renewable energy sector:

- credit lines to local commercial financial institutions for providing debt financing (loans) to projects;
- guarantees to share with local commercial financial institutions and sponsors the risks of providing financing to projects and companies;
- debt financing provided directly to projects;
- loan softening programs, to mobilize domestic sources of capital;
- financing of private equity funds that invest risk capital in companies and projects;
- equity financing provided directly to companies and projects; and
- grants and contingent grants to share elevated project development, transaction, or capital costs.

Using these mechanisms to facilitate access to finance is necessary, but access alone is seldom sufficient for getting clean energy or other low-carbon technologies deployed and scaled up (UNEP, 2008a). Successful mechanisms typically combine access to finance with technical assistance programs designed to help prepare projects for investment and build capacity.

Many finance facilities were created but did not disburse funds because they failed to find and generate sufficient demand for the financing (UNEP, 2008a). Successful public funding mechanisms actively reach back into the project development cycle to find and prepare projects for investment; that is, they work on both the supply and the demand sides of the financing equation. Strategies to generate a flow of well-prepared projects for financing can involve partnerships with many market actors, such as utilities, equipment suppliers and project developers, end-user associations, and government authorities (UNEP, 2008a).

11.11.5 Renewables as a Mainstream Energy Option

Whether renewables can now be considered a mainstream energy option can be best seen by examining the power sector (Usher, 2008). In total, and excluding large-scale hydropower (above 50 MW), about US₂₀₀₅\$170 billion was invested in new renewable power generation plants in 2010, compared with about US₂₀₀₅\$200 billion for fossil-fueled power plants (UNEP and BNEF, 2011). This is about the same as more than half of Spain’s total electricity generating capacity. So this is not only about success in Germany, Spain, Denmark, and a few other countries; it is becoming a global phenomenon.

As shown in Figure 11.1, new renewables still represented only about 8% of global power capacity and about 4.5% of global electricity generation in 2010. According to UNEP and BNEF (2011), new renewables accounted for about one-third (about 60 GW) of total global electricity capacity installed in 2010, whereas all renewables accounted for about 47% (84 GW) of net power additions worldwide. REN21 (2011), however, estimates the net power additions worldwide at 194 GW in 2010, with renewables accounting for approximately half (about 96 GW).

More will be needed to meet the challenges ahead. In August 2007, the Secretariat of the United Nations Framework Convention on Climate Change published *Investment and Financial Flows to Address Climate Change*, which estimated that US\$200–210 billion in additional investment will be required annually by 2030 to meet global GHG emissions reduction targets (UNFCCC, 2007). The technical paper concluded that although the lion’s share of this investment will need to come from the private sector, substantial public funding will be required to mobilize and leverage the needed private capital (UNEP, 2008a).

11.12 Policy Instruments and Measures

11.12.1 Introduction

Increased use of renewable energy technologies (RETs) can address a broad range of goals, including energy security, economic development, and emission reductions. For this to occur, policy measures have been used to overcome the barriers within the current energy system that prevent wider uptake of renewables. In addition to continued R&D aimed at performance improvements, cost reductions, and system integration, a key issue is how to accelerate the deployment of renewable energy so that deep penetration of renewables into the energy system can be achieved quickly.

This section considers some of the key market failures in developing and deploying renewable energy, the policies in place to overcome them, the need to encourage technological and social innovation, and the appropriate frameworks for investment. It also explores positive links between renewable energy and other policies, such as climate change policies and water policies. (Chapters 22 to 25 provide more in-depth analysis of energy policies in general.)

11.12.2 Need for Policy Intervention and Policy Frameworks

The overall supply and use of energy within the global marketplace does not currently reflect the importance of energy's role in relation to economic, social, and environmental goals. Brown and Chandler (2008) evaluated more than 300 policies and measures grouped into nine categories of "deployment activities": tax policy and other financial incentives; technology demonstrations; codes and standards; coalitions and partnerships; international cooperation; market conditioning, including government procurement; education, labeling, and information dissemination; legislative act of regulation; and risk mitigation. The comprehensive taxonomy underscores how many different policies can affect the innovation value chain related to the reduction of GHGs (and many specific to renewable energy) and the importance of choosing policies that will have the intended impacts (Mitchell et al., 2011).

Given the enormous size and momentum of the current global energy system, in combination with capital intensity and technology lock-in, new technologies such as renewables face significant market barriers. To address these, policy measures should ideally enable not just a level playing field where renewables can compete fairly with other forms of energy; they should also support RE development so that they can overcome the additional hurdles to their deployment that result from inertia to change the incumbent socioeconomic-technical system (see, e.g., Hughes, 1983).

11.12.2.1 Market Failures

While competitive markets operate effectively for many goods and services, a number of failures need to be addressed in relation to energy. A central concern is the way that markets currently favor conventional forms of energy by not fully incorporating the externalities they are responsible for and by continuing to subsidize them, thereby making it harder to incorporate new technologies, new entrants, and new services in the energy system. This both distorts the market and creates barriers for RE (Johansson and Turkenburg, 2004; Mitchell, 2008).

The negative externalities of using fossil fuels include impacts on the environment, health, safety, and security (Johansson and Turkenburg, 2004; Bosello et al., 2006). Similarly, the potential benefits that renewables can offer – such as increased energy security, access to energy, reduced economic impact volatility, climate change mitigation, and new manufacturing and employment opportunities – are also often not accounted for when evaluating the return on investment.

These issues are exacerbated by ongoing subsidies for fossil fuels. Global fossil fuel subsidy levels have been estimated at between US₂₀₀₅\$170–317 billion – and even as high as US₂₀₀₅\$516 billion (IEA, 2010f), compared with US₂₀₀₅\$15.5 billion for renewable energy (UNEP and BNEF, 2008).

11.12.2.2 Failures in the Innovation System

Innovation is central to the development and deployment of new and existing energy technologies. Innovation can be considered as a chain in which technologies move through a number of stages from basic R&D to full commercialization, as well as encouragement for social innovation. (Social innovation concerns the ability of people and institutions to be able to change the way they do things so as to adapt and support the emergence and deployment of RE technologies; Kok et al., 2002). Technologically, this comprises both a supply push from the R&D side of the chain and a demand pull from the market as a technology approaches commercialization.

As technologies advance through these stages, there are both performance improvements and cost reductions (Grubb, 2004). At each stage of the chain, policy instruments may enable (or deter) the appropriate funding to be available – through either public or private means. Figure 11.81 provides an overview of the innovation chain. It shows the need for a seamless linking of policies to provide basic and applied R&D funds early on through to market expansion-type policies later on.

As discussed in Chapter 24, however, innovation is a complex, non-linear process that involves dynamic feedback among the actors, organizations, and networks that include market mechanisms and the flow of knowledge (see also Foxon et al., 2007). As Grubb (2004) describes, the playing field is not level in terms of the introduction of new technologies

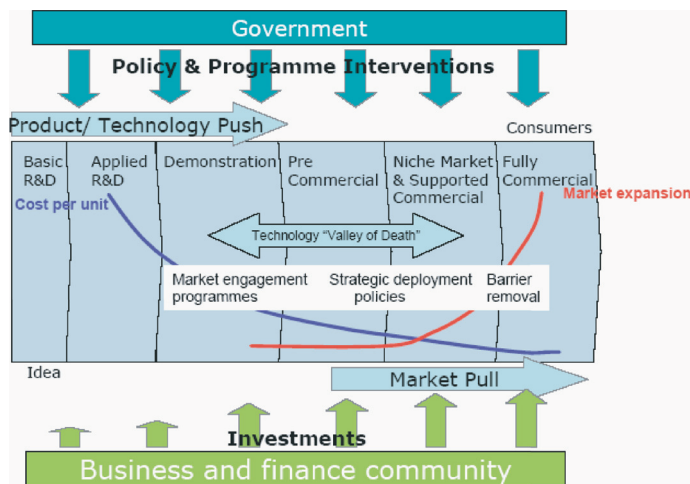

Figure 11.81 | Overview of Innovation System. Source: Grubb, 2004.

due to the nature of large energy systems, which are capital-intensive with long life spans that therefore do not encourage innovation and rapid technology turnover.

Incumbent energy technologies are also mature in terms of their cost and the infrastructure, skills, and knowledge that accompany them (Johansson and Turkenburg, 2004). This results in “lock-in” of technologies and institutions, which favors the energy incumbents and creates a range of barriers for RETs. Some technologies can become stuck along the way. This occurs from a range of risks that relate to the technology itself not performing, market uncertainty, concerns of regulation, and the issues with the system itself, such as lock-in (Turkenburg, 2002). These risks and uncertainties can make it difficult to secure the necessary investment to get a technology through the technology “valley of death.”

Policies to address these risks and market failures can also encourage a balanced approach to funding across the innovation chain: one that focuses on research, development, and demonstration as well as deployment phases and that helps reduce the risk that technologies will become stuck (Turkenburg, 2002; Watson, 2008; Foxon et al., 2007).

11.12.2.3 Failures Related to Investment

It is clear that RETs face a number of factors that make it harder for them to compete based solely on costs:

- capital intensity, scale, and resource risk;
- a discounted value to traditional utility operators;
- real or perceived technology risk;
- the absence of full-cost accounting for environmental impacts on a level playing field; and

- a lack of recognition of the long-term value owing to reduced variable fuel cost exposure.

These issues have a negative impact on attractiveness for investors by extending the time frame for returns or by increasing risk and expected rate of return. These risks can be reduced by using public-sector financial or market instruments such as guarantees in terms of market access, market size, and price security (Johansson and Turkenburg, 2004; Mitchell, 2008; Baker et al., 2009).

Support for technological innovation can help create a positive environment for development, demonstration, and commercial deployment investment (Foxon et al., 2007). In contrast, there are many examples of the impact of inconsistent and unsustainable policies on renewable energy in terms of creating uncertainty, damaging commercial interest, preventing manufacturing, and creating boom-and-bust markets (Sawin, 2004b). The result is market instability, an increasing perception of risk, and a loss of investor confidence, which can affect development of individual technologies.

11.12.3 Policy Approaches for Renewable Energy

A wide range of regulatory, fiscal, and voluntary policies have been introduced globally to promote renewable energy. These serve a range of technology-specific objectives, including innovation, early-stage development and commercialization, manufacturing, and market deployment, as well as wider political goals such as new manufacturing bases for a technology, local and global environmental stewardship, and economic prosperity. These policies all help to reduce risk and encourage RET development and are generally used in combination. (See Table 11.44).

Using a portfolio of policies helps to control total costs and increase successful innovation and commercialization, providing the policies complement each other (Foxon et al., 2007). The means of using financial instruments are described in section 11.11. To get renewable technologies through the “valley of death,” it is important to note that (IEA, 2008b):

- market growth results from the use of combinations of policies;
- long-term, predictable policies are important;
- multi-level involvement and support from national to local actors is important; and
- each policy mechanism evolves as experience with it increases.

Policy approaches for RE intend to address the innovation chain both technologically and socially, to pull technologies to the marketplace and

Table 11.44 | Summary of renewable energy policies.

Policy	Definition	End-use Sector		
		Electricity	Heat/Cooling	Transport
Regulatory Policies				
Targets	A voluntary or mandated amount of RE, usually a percentage of total energy supply	X	X	X
Access-related Policies				
Net metering	Allows a two-way flow of electricity between generator and distribution company and also payment for the electricity supplied to the grid	X		
Priority access to network	Allows RE supplies unhindered access to network for remuneration	X	X	
Priority dispatch	Ensures RE is integrated into energy system before supplies from other sources	X	X	
Quota-driven Policies				
Obligation, mandates, Renewable Portfolio Standards	Set a minimum percentage of energy to be provided by RE sources	X	X	X
Tendering/bidding	Public authorities organize tenders for a given quota of RE supplies and ensure payment	X		
Tradable certificates	A tool for trading and meeting RE obligations	X	X	
Price-driven Policies				
Feed-in tariff (FIT)	Guarantees RE supplies with priority access, dispatch, and a fixed price per unit payment (sometimes declining) delivered for a fixed number of years	X	X	X
Premium payment	Guarantees RE supplies an additional payment on top of their energy market price or end-use value	X	X	
Quality-driven Policies				
Green energy purchasing		X	X	
Green labeling	Usually government-sponsored labeling that guarantees that energy products meet certain criteria to facilitate voluntary green energy purchasing	X	X	X
Fiscal Policies				
Accelerated depreciation	Allows for reduction in tax burden	X	X	X
Investment grants, subsidies, and rebates	One-time direct payments usually from government but also from other actors, such as utilities	X	X	X
Renewable energy conversion payments	Direct payment by government per unit of energy extracted from RE sources	X	X	
Investment tax credit	Provides investor/owner with an annual tax credit related to investment amount	X	X	X
Other Public Policies				
Research and development	Funds for early innovation	X	X	X
Public procurement	Public entities preferentially purchasing RE or RE equipment	X	X	X
Information Dissemination and Capacity Building	Communications campaigns, training, and certification	X	X	X

commercialize them, and to improve the financial attractiveness and investment opportunities of RE.

Of the market pull policies, two are most common: policies that set a price to be paid for RE and that ensure connection to the grid and offtake (i.e., FITs) and policies that set an obligation to buy but not necessarily an obligation on price (often known as a quota or obligation mechanism but also referred to as a Renewable Portfolio Standard or Renewable Fuel

Standard (RFS) and sometimes as a Renewable Electricity Standard). So far, FITs have been for electricity only, although some countries, such as the United Kingdom, are now considering how to provide them for heat (DECC, 2009). Quotas have so far been used for electricity, heat, and transport. Biofuel mandates are now a common occurrence globally.

Table 11.45 indicates the number of countries that have introduced policies to promote renewable, which is increasing nearly across the board.

Table 11.45 | Recent development of the implementation of Renewable Energy policy instruments.

Policy instrument	End 2005	End 2007	End 2009	End 2010
Countries with policy targets	55	66	80	96
States / provinces / countries with FITs	41	56	80	87
States / provinces / countries with RPS policies	38	44	51	63
States / provinces / countries with biofuels mandates	38	53	64	60

Source: REN21, 2008; 2010; 2011.

11.12.3.1 Innovation-driven

R&D is the policy instrument intended to meet the early requirements of the innovation chain. However, support needs to be balanced across this innovation chain (IEA, 2008b) because learning through doing or utilization can focus R&D beneficially (Neij, 2008; Junginger et al., 2010).

Research and development is generally targeted to both increase performance and reduce costs of newer technologies. New forms of collaboration between researchers, such as joint road mapping (NEDO, 2009) or the Scholarships for Excellence program (BIS, 2010), may also lead to increased and targeted innovation. Investments in energy R&D are low within total national R&D budgets (UNEP, 2008b), and only a small part of those budgets is directed toward renewables (IEA, 2010g).

Changing energy behaviors is not simple, but it is critical to reduce overall energy use and enable the widespread adoption and application of renewable energy. There is often a gap between support for RE in opinion polls and buying, investing, or enabling RE projects to gain planning permission (Devine-Wright, 2005). Increasingly, policies are being implemented that are intended to support RE but also to change people's attitudes and behaviors. For example, the United Kingdom has a Low Carbon Challenge program that has supported 25 communities implementing RE but that also has used the process to educate communities and individuals about reducing GHG emissions (DECC, 2010).

11.12.3.2 Price-driven

The most widely used price-based policy is the FIT. Other RE price policies are premium payments, which are often set as a percentage or an amount over an electricity price (for example, Spain offers the choice between an amount over the retail price (Lucas Porta, 2009). While beneficial, premium payment structures are more risky because the price of electricity moves up and down, so investors may not be sure about the payment they will receive.

FITs guarantee a price for the sale of qualified (such as renewably generated) electricity and allow the supply of investment to determine the resulting volume or capacity. FIT rules differ by country, but a "standard" electricity FIT includes an obligation to connect the renewable project to the grid, its priority dispatch (see section 11.10), and the purchase of any

electricity generated at a fixed minimum price (which is generally above the market level for a set time period). In addition, the payment usually declines over time according to a rate known at the time of initial contracting, to take account of technological learning and maturity (Couture et al., 2010). This approach minimizes the risk of investment and, if designed appropriately, should provide attractive risk-adjusted returns on investment.

FITs were first introduced in the United States in the late 1970s and since then have become the most widely adopted class of promotional policy globally. Much of the growth in their use has been within the last decade as some countries enact new policies and others adjust and refine existing tariffs. Their popularity is linked to their ability (if well designed and implemented) to offer sufficient rates of return over the economic life of the technology at low risk (Klessman et al., 2010). To date, FITs have had a large impact on the development and deployment of wind, PV, biomass, and small hydro (REN21, 2010). The transaction costs involved with FITs are lower than those of quotas (Mitchell et al., 2006). This means that the number and diversity of actors taking up the opportunity of an FIT are far greater than with quota mechanisms, which in turn has a number of other positive benefits, such as new market entrants and reduced excess profits (Jacobsson et al., 2009). However, the payment and cost structure for FITs, as exemplified by recent restructuring in Germany and Spain, have raised concerns over FIT design and best practices (Kreycik et al., 2011, Coture et al., 2010).

11.12.3.3 Quantity-driven

Renewable Portfolio Standards set an obligation for renewable capacity or volume such as a percent of electricity or share of fuels, and the market determines the price at which this is achieved. This obligation often increases over time toward a set total or date, and the requirement to meet it can be placed on producers, distributors, or consumers (Sawin, 2004a,b). Most RPS policies require a renewable power share of 5–20% by a set date, generally 10–20 years ahead. Such targets translate into expected future investments, but the means of achieving it are often flexible (REN21, 2008).

For electricity generation, quota systems can be based on obligation or certificate mechanisms in which investors, generators, or utilities have to achieve specific targets and are penalized if they do not. Credits are created through the generation of renewable electricity such as green

certificates, green labels, or renewable energy credits. To meet the obligation, it is possible to generate renewable electricity, enter into a contract with others to do so, or buy a valid credit in the marketplace. Quotas or obligations can be more complicated to administer than FITs (Mitchell et al., 2006). Moreover, like the UK mechanism, they can do little to minimize the risk of investment if their obligation is only for purchasing rather than including a minimum price or a minimum contract length. But they have the benefit of letting government know the maximum cost per year (Mitchell et al., 2006).

An alternative approach within quotas can involve tendering systems in which both the total share of electricity and a maximum price per kilowatt-hour are set. Developers then submit prices for contracts in a one-off bidding round to compete for funds and contracts (Sawin, 2004).

11.12.3.4 Quality-driven

Quality-driven RE policies aim to ensure energy that says it is renewable actually is RE (and produced sustainably), in the hope that this will encourage greater voluntary RE purchasing. For example, green labeling ensures that the consumer buys RE that is generated and verified as original source. The European Union's requirement for a guarantee of origin on all RE generated within Europe enables trading but also ensures that each unit of energy can only be used once. The US voluntary green power market has similar quality assurance standards and has been growing strongly for many years (Bird et al., 2009).

Voluntary green energy purchasing can include utility pricing programs, retail sales in liberalized markets, and voluntary trading of renewable energy certificates (used in some countries within quota-based systems). Within these schemes, consumers pay a premium price for the green power, which helps to encourage investment in RETs, although the level of premiums may be declining. It is estimated that in 2009 there were over 6 million green power customers in Australia, Canada, Europe, Japan, and the United States (REN21, 2010).

11.12.3.5 Financial Incentives

A range of financial incentives are also in use globally to support RETs, such as policies that use taxes, rebates, grants, payments, and subsidies. (See also section 11.11.) They are used to help "level the playing field" either by lowering the cost of RETs relative to conventional energies or by increasing the value of the RE sold to make it easier for the technologies to compete in the market (Sawin, 2004). They can be linked to a price per kilowatt-hour or to an installed capacity.

Tax incentives are commonly used to provide financial support, through either a production tax credit or an investment tax credit, both of which encourage the investment and build-out of a RET. Production tax credits in the United States provide a financial benefit based on the generated

amount of energy from renewable energy sources, which helps reduce the payback period and therefore increase the rate of return, making investment more attractive. As the reward is based in the amount of energy generated, these credits can encourage technologies and installations that are reliable and continuously improving. Other forms of tax relief can reduce the cost of investing in renewables, such as accelerated depreciation, value added tax exemptions, or the removal of import duties (Sawin, 2004).

In 2010, at least 52 countries had some sort of direct capital investment policy in place (REN21, 2011), from national to local levels, offering typically 30–50% of installed cost (mostly for smaller-scale distributed systems such as solar PV). These have been tied to certain technologies in many countries, with PV in particular receiving widespread support that has led to its rapid market growth; in other countries financial support has been offered for a wider range of renewables (REN21, 2010). There is debate about whether a payment should be made upfront on the "capital" outlay or on the output (the energy). Early US experiences shaped global RE policy perceptions that payment on outputs was more efficient (Karnoe, 1993). Yet both instruments, or options among them, may be used. In some cases grants may also be used, either when tax-related policies are deemed ineffective (Bolinger et al., 2009) or when the goal is to encourage small-scale investors (DECC, 2009).

Another means of providing increased revenue (and thus a better rate of return) to investors is net metering, which allows grid-connected generators to sell excess power into the grid, with an obligation for utilities to purchase the excess. (See, for example, US DOE, 2011c). The reimbursement or rebate may be based on retail or wholesale prices and may include a time-of-day value as well. Net metering laws now exist in at least 14 countries and nearly all US states (REN21, 2011).

11.12.4 Other Enabling RE Policies

11.12.4.1 Targets

Targets provide a marker by which all actors involved can assess the situation and act in their own best interests. Establishment of a goal or target may increase investor and developer confidence and may also provide a basis for possible future policy or regulation direction, but it does not set a legal obligation.

Targets have been steadily developing over the last three decades, but the rate of growth and their geographic spread have increased significantly only recently. At the end of 2010, an estimated 96 countries worldwide had policy targets for renewable energy (see Table 11.45), with further targets existing in individual states, provinces, municipalities, and individual cities.

The approach taken for renewable energy targets varies by country and can include a percent share of electricity production, a share of

total primary/final energy supply, an installed capacity target, or total amounts of energy extracted from renewable sources. In addition, the time frame for targets varies from 2010–2012 to 2020–2025 and beyond. Some countries have technology-specific goals, and many also have targets for biofuels or blending requirements.

In the European Union, policies adopted in late 2008 as part of the energy and climate package included agreement on a 20% final energy from renewables target and a 10% target for transport fuels, with sustainability criteria. The legally binding targets are spread across all 27 member states and build on earlier EU-wide targets for 2010 (European Parliament, 2009). China has adopted a national target of 15% of primary energy from renewable by 2020, while India has a range of long-term goals to 2032 that include 15% of power capacity and 10% of transport fuels from renewable energy (REN21, 2010).

11.12.4.2 Economic Regulation

As already highlighted, fossil fuels and nuclear power continue to receive significant subsidies globally, and there can be hidden barriers to RE in economic regulatory approaches. For example, obligations to purchase RE, public investment in distribution networks, and access rules to transmission networks may all favor incumbents and create a market barrier to new entrants (Baker et al., 2009). Exemptions from risks or liabilities and the structure of energy markets may also unfairly penalize intermittent forms of generation (Sawin, 2004; Mitchell, 2008; Morthorst et al., 2007). Removal of these barriers addresses the cost competitiveness of renewables against conventional energies and it may enable the energy system to be more efficient and secure (Gottstein, 2010). For example, the United States has recently developed transmission policies to take account of the difficulties in predicting output for some renewables, giving them a fairer chance in a system designed for conventional generation (REN21, 2008). Allowing electricity markets to include wind forecasts that are nearer market closure is also helpful (Jónsson et al., 2010).

11.12.4.3 Planning and Permitting

Almost all surface areas of the globe are now influenced by ownership, conservation, traditional use, or commercial interests. As a result, the growing deployment of RE technologies may create tensions. Policymakers therefore attempt to balance a planning regime that broadly supports RE use and deployment while at the same time establishing processes that ensure public insight and environmental protection.

Obtaining planning permission for an RE (or any other) project is a social process when different actors and stakeholders are able to become involved and share their views. There is clearly a positive side to this (Ellis et al., 2009). On the other hand, lengthy permitting processes, high application costs, lack of local or regional capacity to

deal with RE applications, and (sometimes) local opposition can make the permitting process expensive and time-consuming (Breuker and Wolsink, 2007).

Social acceptance and a commitment to effective planning and permitting help reduce risk and the cost of deployment of RE solutions. Codifying the framework into a set of legal, formal rules and procedures to address the differences and mediate conflicting interests and values is a long-term transition process; the planning and policy process is only one part of that (Agterbosch et al., 2009). Streamlining application processes, adopting benefit-sharing schemes, simplifying legal documents, and so forth are all helpful to permitting for RE (Ellis et al., 2009). However, speeding up the planning process may mean that local participation is inherently reduced.

11.12.5 Heating and Cooling and Transport

11.12.5.1 RE Heating and Cooling

Relative to electricity or liquids for RE fuel, renewable heat has had very little policy support, and RE for cooling has been the subject of even fewer mechanisms. The use of renewable heat is widespread. (See sections 11.2, 11.4, and 11.8.) Examples include solar water heating in China, geothermal heating in Iceland, and biomass CHP in Sweden, although these have resulted from a confluence of factors rather than a specific RE support policy. Policy mechanisms in place are similar to those for electricity, although they have different names: bonus mechanisms (similar to the FIT for electricity) in the United Kingdom; a “use” obligation, where building regulations can compel the adoption of renewable heat technologies (in Germany); standards and building regulations to ensure a minimum quality of hardware and installation alongside the “use” obligations; and fiscal instruments such as tax credits, capital grants, and soft loans (Seyboth et al., 2008).

11.12.5.2 RE Transport

Currently, 95% of the world’s transport relies on petroleum, and there is evidence of this increasing annually (IPCC, 2007a; IEA, 2010b). Considerable attention is being given to increasing the share of transport services provided by renewables directly through liquid and gaseous fuels and indirectly via electricity.

Again, policies for renewable transport are similar to those for RE electricity and heat. Policies in Europe and North America that promote the use of RE in transport applications include renewable/low carbon fuel standards, tax incentives, R&D, RFSs, GHG emission standards, preferential government purchasing, and regulation standards and licenses for production and sale of renewable energy carriers (Altenburg et al., 2008; Felix-Saul, 2008).

Care is needed to ensure that the increased use of biofuels (and biomass more generally) does not have negative sustainability impacts and that bio-resource policies account for the wider context of energy policy, as biofuel production may reduce options for other forms of biomass, for food production, and for other uses or destinations. (See also Chapter 20.)

11.12.6 Links with Other Policies

Supporting renewable energy may have other benefits, such as climate change mitigation, poverty eradication, rural development, protection of water resources, energy security, infrastructure development, employment, and demand reduction through energy efficiency.

11.12.6.1 GHG Reduction and Local Environmental Improvements

One of the most obvious and strategic policy links is with climate change, as the supply and use of energy is the main driver of GHG emissions globally (IPCC, 2007b; IPCC, 2011). As a result, there are significant RE policies around the globe to reduce GHG emissions (REN21, 2010). In addition, there are other environmental benefits in relation to air quality and pollution. This includes the reduction of particulates, low-level ozone, sulfur, and nitrogen oxides everywhere (IPCC, 2007a). One exception to this general assumption, however, is the traditional use of biomass, particularly in developing countries, where poor combustion for heat and cooking lowers indoor air quality and has serious health impacts. In these circumstances, access to better technology and cleaner fuels, including fossil fuels, can dramatically improve air quality and health. (See Chapter 4.)

11.12.6.2 Poverty Eradication

The opportunities for renewable energy to help with poverty eradication and the broader Millennium Development Goals are significant, as energy services have been shown to be essential to achieving these. This requires policies to increase both the quality and the quantity of affordable energy services in the world's poorest countries (Modi et al., 2006). The UN has emphasized the close links between energy use and the eight MDGs (UN, 2009). The IEA estimates that 22% of the global population was without access to electricity in 2008 – around 1.5 billion people, 85% of whom live in rural areas. The organization estimated that this figure had fallen by 500 million since 2002. The extent to which this related to the deployment of renewables is less clear. But several programs have focused on this; for example, China has introduced an RE program, including the Riding the Wind Plan and the Brightness Project on solar energy to provide electricity to people in remote areas not been served by small hydropower efforts (World Bank, 2010; see also Chapter 19).

11.12.6.3 Invigorating Agriculture and Rural Areas

Efforts are increasingly being made to replace fossil fuels with biofuels and with biomass from agriculture in order to reduce GHG emissions (IPCC, 2007a) and fossil fuel imports. This can include the use of crops, crop residues, wood, and animal wastes, and additional resources are available from forestry and waste streams. Linking agricultural and renewable policies more closely could help maximize this resource potential while supporting rural development, creating jobs, increasing local energy availability, and yielding other social and environmental benefits (WIREC, 2008). But a range of issues need to be addressed to ensure that these benefits do not have negative impacts on food production, biodiversity, sustainable management of soil and water, and other sustainability criteria. (See Chapter 20.) Increasing the scale of bioenergy deployment globally will also need to take careful account of the socioeconomic-political conditions within a country as well as local resources and assets (WIREC, 2008).

11.12.6.4 Provision and Protection of Water Resources

There are a number of direct links between energy and water policy, including the possible massive reduction of water needs for thermal power plant cooling and the use of RETs to replace expensive diesel for water pumping, desalination, and purification (Bates et al., 2008). These applications, often at small scale, can directly support the MDGs, as they can provide local reliable and clean water while reducing the time it takes to gather water in many developing countries (UN, 2009). Water is also a key global resource for generating power, particularly the large-scale hydro that provides a large amount of electricity in developing and industrial countries. At the same time, biomass-based renewables and concentrated solar power in desert areas may introduce new demands for water. (See Chapter 20.) The substitution of RE for other energy sources may also have a beneficial impact on water usage and quality, such as mining for coal.

11.12.6.5 Energy Security

Energy security policies, while not uniformly framed across countries, have begun to link the development and support of RETs to the reduction in risk of supply and economic volatility of fossil fuels (see, e.g., University of Exeter and University of Sussex, undated). RE can improve the security of energy supply in a variety of ways, including reducing dependence on imported fuels, helping to diversify supply, enhancing the national balance of trade, and reducing vulnerability to price fluctuations (Mitchell et al., 2011).

These various benefits are driving a number of governments to adopt policies to promote RE. In the United States, for example, development and extension of the national Renewable Fuel Standard were framed within the context of reducing imported oil (Arent et al., 2009). In Japan,

with few domestic energy resources, solar energy allows the domestic generation of electricity, with associated policies to support R&D and market deployment. For the last 30 years Brazil has promoted ethanol from sugarcane as an alternative to fossil transport fuels in order to decrease dependency on imported fuels (Solomon et al., 2007). China established its 2005 Renewable Energy Law in part to diversify energy supplies and safeguard energy security. A number of municipalities and local communities are also adopting RE plans to become more energy self-sufficient (St. Denis and Parker, 2009; Mitchell et al., 2011).

11.12.6.6 Infrastructure Development

As discussed in section 11.10, expanded use of renewables will require infrastructure developments that allow distribution of energy for heat, power, and transport applications. Heat tends to be used close to the point of production, often through local heat distribution networks. Changes to transport infrastructure depend on the type of renewable energy that may be exploited, but a significant switch to hydrogen or battery vehicles, for example, may require considerable new up-front planning and infrastructure (Lund and Clark, 2008). An integrated, holistic planning approach may also benefit changes in electricity infrastructure to accommodate more renewables (Baker et al., 2009; Arent, 2010).

The existing infrastructure in many countries was originally designed around large fossil fuel and nuclear generating plants. As such, the operational mindset may be focused on the original intent, so quick change can be difficult. To date, this has not been a major problem in many countries, as grid infrastructure has been designed to meet peak load requirements, meaning most countries have been able to accommodate increasing amounts of renewables while maintaining supply security and reliability. This is likely to become an increasing challenge, however, as the contribution from renewables increases, since some (like wind and solar) are variable resources.

Needed changes can be achieved through planned upgrades and pre-investment in preparation for future renewables or through making the grid infrastructure more active. Linked to the latter approach is the increasing interest in more-intelligent smart or micro grids, demand response, storage, and load shifting. These are based on clusters of connected, distributed generation that are collectively controlled to manage output (Battaglini et al., 2009). Both the European Union and the United States are developing such grids to improve reliability and lower costs (Coll-Mayor et al., 2007). Another approach being considered is “supergrids,” which are based on large-scale transmission of renewable electricity over very long distances (Battaglini et al., 2009; FOSG, 2010; DESERTEC Foundation, 2011). This can include connections between existing national grids to balance power, as well as the much more strategic construction of new high-voltage distribution lines to bring in larger areas of supply potential. There are also opportunities to combine approaches to create a “supersmart” grid (Battaglini et al., 2009).

11.12.6.7 Improving Economic Development and Employment

The global financial crisis in 2008 spawned an unprecedented policy response, totaling US₂₀₀₅\$2.65 trillion in stimulus spending by March 2009 (UNEP, 2009). The UNEP 2010 Sustainable Energy Finance Initiative report stated that 9% of the US₂₀₀₅\$165 billion in global green stimulus packages had been spent by the end of 2009, with greater shares expected in 2010 and 2011 (UNEP and BNEF, 2010). Broadly, these “global green stimulus packages” refer to direct and indirect expenditures on a broad suite of energy solutions, including RETs, energy efficiency, advanced materials, and “smart grids.”

There are considerable employment opportunities within the renewable energy sector. UNEP (2009) estimated that approximately 2.3 million people found employment in renewables in recent years; REN21 reports that around 3.5 million direct jobs had been created by 2010 (REN21, 2011). UNEP also stated that projected investments to 2030 – not taking into account the full impacts of the financial and economic crisis – could result in at least 20 million additional jobs globally. These figures mask the complexity involved, as any major international switch to renewables is likely to be accompanied by job losses in the fossil-fuel-based energy sectors.

Frankhauser et al. (2008) provide a useful analysis of employment over time. They highlight the work of Kammen et al. (2006) that compared 13 studies within the European Union and the United States. The more labor-intensive nature of new renewables resulted in net increases in employment over the short term. In the medium term there are economy-wide effects that reinforce overall employment gains. Research in Germany from BMU (2006) showed that just over 50% of 157,000 renewable energy-related jobs were directly related to manufacture and operation, with the rest in related industries. The biggest effects will be felt in the long term, as technical change and innovation create a dynamic impact that results in job creation, productivity improvement, and growth. Although jobs are lost in conventional energy industries, the authors suggest that overall employment may increase on a net level. A more recent EU report (EU, 2009) generally supports this. Additional research is required, however, to better capture the employment and macroeconomic impacts of renewable energy at the local, regional, and global level.

Relative to conventional energy, the renewable market is still small, with a few countries accounting for the bulk of installations. For example, the top five countries for wind power have 72% of global installed capacity. Many of these top countries also have the manufacturing capabilities for RETs and their associated jobs. Some have made specific policy decisions to link renewables to their national economic strategies. Germany’s support for renewable energy, for instance, resulted in a competitive export industry (Frankhauser et al., 2008), enabling it to obtain a global share of the market, particularly in wind and PV (UNEP, 2008b). This is true for other countries too: China has become a major global player in many RETs in a short time and is capturing a growing part of the global market for, among other technologies, solar hot water. However, this pattern

also suggests that although competitive advantages can be gained by being an early mover, over time such advantages may balance out as other countries – currently China and India – develop their own manufacturing and export capabilities for RETs (UNEP, 2008b).

11.12.7 Development Cooperation

Technology transfer between countries is a prominent area of discussion in international meetings and summits (Brewer, 2008), but it has been a sticking point at many negotiations between industrial and developed countries (Ockwell et al., 2008). As this topic is discussed in Chapters 22–25, this section is limited to a discussion of cooperation on renewable energy.

11.12.7.1 National Systems of Innovation

National Systems of Innovation play an important role in technology development and its potential for wider distribution within the market. (See Chapter 24.) Foxen et al. (2005) describe the concept of national systems in innovation used by the OECD, which characterizes the innovation system in terms of complex flows of knowledge, influence, and market transactions between a wide range of actors and institutions. These processes vary between countries, but they set the framework for innovation at a national level and help shape the process of technology development.

In the case of renewables, innovation is influenced by national policy intervention, targets, and wider policies relating to R&D and infrastructure development. This should result in a reduction in the cost of RETs and should increase their commercial uptake (Ockwell et al., 2008), assuming that the policies are well designed and implemented. National systems of innovation are therefore important in helping to develop new, commercial renewables for deployment within both industrial and developing countries.

11.12.7.2 Capacity Building

A central part of cooperation between nations involves building capacity within developing countries. (See Chapter 25.) As Ockwell et al. (2008) highlight, the transfer of technology in itself may not have a sustained impact on the uptake and development of low-carbon technologies unless it is accompanied by a transfer of knowledge and expertise, such as information on installing, operating, and repairing the equipment. These broader educational aspects help increase the capacity of companies and therefore the likelihood of effective deployment.

Article 4.5 of the UN Framework Convention on Climate Change (UNFCCC) obliges Annex I countries to ensure the availability of affordable clean technologies to non-Annex I countries. Parties to the

convention have agreed on a technology transfer framework (UNFCCC, 2007) that includes five areas for action: technology needs and needs assessments, technology information, enabling environments, capacity building, and mechanisms for technology transfer.

As discussed in Mitchell et al. (2011), perhaps the most important insight in the evolution of technology and innovation in the past 30 years is the recognition that technology transfer is not an end in itself but a means to achieving a greater strategy of technological capacity building (Mytelka, 2007). Technology transfer mostly takes place between firms via the market – through the use of products or services that incorporate a specific technology or through licensing the capability to produce such products, either by an indigenous firm or through a joint venture arrangement or foreign direct investment (Kim, 1991, 1997; UNCTAD, 2010). Its sustainability relies crucially on the successful learning of one party from another and the effective application of that information and knowledge in generating marketable products and services.

11.12.7.3 Impact of the Clean Development Mechanism

The CDM enables Annex I countries to support the development of projects to reduce GHG emissions within developing countries. As of August 2011, a total of 3392 projects were registered, and more than 50% of these were for renewable projects (cdm.unfccc.int). In assessing the contribution of CDM to technology transfer, Schneider et al. (2008) suggest that although the program was not designed for this, it does contribute to the process, as developing countries can gain access to technologies that may not have been available previously. The literature, they suggest, shows that the CDM contributes to the transfer of equipment and capacity building by lowering several existing barriers and by increasing the quality of transfers. They suggest that it is currently the strongest mechanism that the UNFCCC has for technology transfer of RE, although its effectiveness varies considerably with geography, technology, and project size.

11.12.7.4 Role of International Institutions, Arrangements, and Partnerships

Given the nature of development cooperation today and the potential benefits that renewables can offer, a number of initiatives are in place to encourage the transfer of technologies. This includes the work of specific bodies that support countries on climate change, development, and sustainability, including bodies like the UN Development Programme and the UN Industrial Development Organization.

There is an ongoing interest in technology transfer under the mechanisms agreed as part of the UNFCCC:

- Article 4 includes promotion and cooperation on development, application, and diffusion, including the transfer of technologies that

help to mitigate emissions. It also calls for practical steps that promote, facilitate and finance the transfer of environmentally sound technologies.

- The Marrakesh Accords include agreement on the framework of the five themes for technology transfer activities. A summary on the actions being taken under these themes, including the UN bodies involved, shows how many of these can link to energy and renewables (UN, 2008).
- The seventh Conference of the Parties also established the Expert Group on Technology Transfer to analyze and identify ways to facilitate and advance technology transfer.
- The Bali Road Map agreed to at the thirteenth Conference of Parties to the UN-FCCC called for enhanced action on technology development and transfer to support action on climate mitigation and adaptation.

Additional initiatives include the Global Environment Facility (GEF) that supports developing countries. GEF is managed by the World Bank and aims to make the economics of low-impact technologies, such as renewables, more favorable. The 2006–2010 fund amounts to US₂₀₀₅\$2.67 billion, of which nearly 12% is earmarked for renewable energy (REN21, 2007; 2008; 2010). However, irregular voluntary funding to GEF has created major obstacles to its effective functioning (REN21, 2007). Schneider et al. (2008) suggest that the investment that takes place through the CDM is more significant for technology transfer than the GEF.

The IEA Technology (or Implementing) Agreements encourage cooperation between member and non-member governments and organizations to meet the challenges of energy security, competitiveness, and climate change through technological solutions. They provide a legal contract with standard rules and regulations for a range of technologies that allow the pooling of resources, research, deployment, and development. Currently the renewable-related agreements include bioenergy, geothermal, hydrogen, hydropower, ocean energy systems, PV, solar heating and cooling, concentrating solar power, wind, and RET deployment. Examples of agreements that can support technology transfer include the Networks of Expertise in Energy Technology that works to foster better international cooperation, particularly with non-IEA countries, and the Climate Technology Initiative, which aims to foster international cooperation to accelerate development and diffusion of environmentally sound technologies and practices (IEA, 2009d).

Other examples of international partnerships that include agreements and principles on energy, renewables, and technology transfer, include the following:

- Asia-Pacific Partnership on Clean Development and Climate Change, which includes cooperation on technology transfer and development.

- Johannesburg Renewable Energy Coalition, which focuses on political initiatives to help promote renewable energy at national, regional, and international levels.
- Mediterranean Renewable Energy Program, which includes the objectives to provide modern energy services to rural populations and contribute to climate change mitigation by increasing the share of renewable energy technologies in the region.
- New Partnership for Africa's Development, which includes objectives to tackle poverty and place African countries on a path of sustainable growth and development.
- Small Island Developing States, which aims to support the sustainable development of these countries, including initiatives on renewable energy and climate change.

11.12.7.5 Role of Dedicated Renewable Energy Partnerships

A wide range of renewable energy partnerships also have a role within development cooperation and the wider support of renewable energy. As Suding and Lempp (2007) describe, these include federations, business associations and societies for renewables and specific technologies that include conventional organizations and structures, and numerous much more diverse partnerships and networks. They help to bring like-minded partners together to pool skills and resources to work toward common goals. Examples of these in terms of development cooperation include:

- Global Network on Energy for Sustainable Development
- Global Bioenergy Partnership
- Global Village Energy Partnership
- International Science Panel on Renewable Energies
- International Solar Energy Society
- International Renewable Energy Agency (IRENA)
- Renewable Energy and Energy Efficiency Partnership
- Renewable Energy Policy Network for the 21st Century
- World Council for Renewable Energy.

Of these, IRENA has the most ambitious goals. It was founded in 2009, and as of August 2011, a total of 148 countries and the European Union had signed the agency's statute. IRENA is to provide advice and support to governments on RE policy, capacity building, and technology transfer.

Table 11.46 | Elements in the UN-FCCC/Kyoto Protocol relevant to Renewable Energy.

Element	Current impact on RE	Potential future impact on RE
Long-term goal (UNFCCC, esp. Article 2)	Limited, as not broken down into technology-specific goals	If defined as GHG emissions or concentration, only an indirect signal. If long-term goals were established for global technology shares, then their effect on RE could be significant.
Emission reduction targets (Kyoto Protocol Annex B)	Fair impact, but countries aim to reach the short-term targets with today's low-cost mitigation options, often not RE	Future emission targets will provide an indirect long-term signal. Depends on the stringency of required reductions and the number of countries participating.
Joint Implementation (Kyoto Protocol Article 6)	Limited, as JI volume is small	Limited, as large JI volumes are unlikely.
Clean Development Mechanism (Kyoto Protocol Article 12)	Fair impact, but other reduction options are often more cost-effective	Growing fast, but the number of host countries will decrease. The level is driven by stringency of emission reduction targets of industrial countries. Additionality criterion may be an obstacle to comprehensive national frameworks for RE.
Technology transfer and financial mechanisms (Kyoto Protocol, esp. Article 11; UNFCCC, esp. Article 4)	Limited, as the funds are small	Larger only if there is an automatic flow of resources into the funds.

Source: REN21, 2007.

It is to improve the flow of financing and to collaborate with existing RE institutions. Its goal is to increase the share of RE worldwide.

11.12.8 International Policy Initiatives to Stimulate Renewable Energy

11.12.8.1 UN Programs and Initiatives

International policy processes from the UN include programs, summits, and initiatives that link directly and indirectly to renewable energy. By providing an arena for countries and other stakeholders, the UN processes are important for working toward common goals or agreements that translate into national renewable policies (Suding and Lempp, 2007). UN World Summits, such as the 1992 UN Conference on Environment and Development in Rio, initiated many of the processes that continue today. The transition to different energy sources and the promotion of renewable energy were included within Agenda 21 that was approved at that conference. Governments in Rio also adopted the UN-FCCC, approved development of the GEF, and created the Commission on Sustainable Development.

The IPCC was created in 1988 to assess the science, impacts, and possible responses to climate change. To date the IPCC has produced four comprehensive assessments and a number of special and technical reports on climate change; the fifth assessment report is being prepared, and a Special Report on Renewable Energy Sources and Climate Change Mitigation was published in 2011.

The UN-FCCC was the political response to concerns raised by the IPCC. Several of the elements of the UN-FCCC are relevant to renewable energy, including the binding targets agreed under the Kyoto Protocol. (See Table 11.46.)

11.12.8.2 The Group of 8 (G8)

Renewable energy has been featured in several G8 summits:

- The 2005 Gleneagles Summit included a focus on the urgent need for action on climate change. The Gleneagles Plan of Action included a statement to continue development and commercialization of renewable energy, building on the commitments made at a renewables conference in Bonn. The meeting also pledged to work with the IEA on integrating renewables into electricity grids.
- The Russian summit in 2006 agreed to the St. Petersburg Plan of Action on Global Energy Security, which included recognition of the role of renewable energy in creating a secure energy mix.
- The Heiligendamm Summit in Germany in 2007 included a declaration on energy cooperation, in which renewable energy was specified.
- The 2008 G8 Summit in Japan included a reaffirmation of the aim to tackle climate change through the UN-FCCC process. There was a recognition of the important role that renewables have in reducing emissions and improving energy security and commitments to increase investment in R&D.

11.12.8.3 International Renewable Energy Action Plans and Declarations

In addition to the UN world summits, a set of Action Plans and Declarations have been agreed to in order to create additional momentum to advance renewable energy policies and technologies. Following an initial meeting in Bonn, these have been organized and monitored by REN21:

- Bonn 2004 – Numerous Action Plans were developed to maintain momentum developed at the 2002 World Summit on Sustainable Development in Johannesburg; several key outcomes were adopted:
 - an International Action Program that included around 200 actions and commitments from a wide range of stakeholders to develop renewable energy (follow-up on these in 2006 by REN21 suggested 79% were being implemented, resulting in significant annual carbon savings); and
 - a political declaration to create and work within a global policy network, which led to the creation of REN21.
- Beijing 2005 – The Beijing Declaration signed by 78 countries reaffirmed the commitments made under previous UN summits to “substantially increase – with a sense of urgency – the global share of renewable energy in the total energy supply.” This included recognition of the need for finance and investment in renewables and a call for greater international cooperation for capacity building in developing countries.
- Washington 2008 – The Washington International Action Program collected pledges on specific and measurable renewable initiatives, including policy commitments, targets, and programs from a wide range of stakeholders. Progress on these pledges will be monitored by REN21 (WIREC, 2008).
- Delhi 2010 – The Delhi International Action Program was announced to encourage governments, international organizations, private companies, industry associations, and civil society organizations to take voluntary action to scale up renewable energy within their jurisdictions or spheres of responsibility.

References

- 3 Tier, 2011:** *Renewable Energy Risk Analysis*. <http://www.3tier.com/en/> (accessed 12 May 2011).
- Aartsma, T., E.-M. Aro, J. Barber, D. Bassani, R. Cogdell, T. Flüeler, H. de Groot, A. Holzwarth, O. Kruse, and A. W. Rutherford, 2008:** *Harnessing Solar Energy for the Production of Clean Fuel*, European Science Foundation Policy Briefing 34. Strasbourg, France.
- Aden, A., M. Ruth, K. Ibsen, J. Jechura, K. Neeves, J. Sheehan, B. Wallace, L. Montague, A. Slayton, and J. Lukas, 2002:** *Lignocellulosic Biomass to Ethanol Process Design and Economics Utilizing Co-current Dilute Acid Prehydrolysis and Enzymatic Hydrolysis for Corn Stover*. National Renewable Energy Laboratory, Golden, CO, USA.
- Agterbosch, S., R. M. Meertens, and W. J. V. Vermeulen, 2009:** The relative importance of social and institutional conditions in the planning of wind projects. *Renewable and Sustainable Energy Reviews* **13**(2): 393–405.
- Al-Dabbas, M. A. A., 2009.** The Economical, Environmental and Technological Evaluation of Using Geothermal Energy. *European Journal of Scientific Research* **38**(4): 626–642.
- Altenburg, T., H. Schmitz, and A. Stamm, 2008:** Breakthrough? China's and India's transition from production to innovation. *World Development* **36**(2): 325–344.
- Andre, H., 1976:** Operating experience with bulb units at the Rance tidal power plant and other French hydropower sites. *IEEE Transactions on Power Apparatus and Systems* **95**: 1038–1044.
- Aratani, F., 2009:** *Accelerated and Extended Japanese PV Technology Roadmap PV2030+*. New Energy and Industrial Technology Development Organization and Ministry of Economy, Trade and Industry, Tokyo.
- Arent, D., F. Verrastro, E. Peterson, and J. Bovair, 2009:** *Alternative Fuel and Vehicle Technology, Challenges and Opportunities*. Center for Strategic and International Studies, Washington, DC, USA.
- Arent, D. J., 2010:** The role of renewable energy technologies in limiting climate change. *The Bridge* **40**: 31–39.
- Arvizu, D., 2008:** Potential role and contribution of direct solar energy to the mitigation of climate change. In *Proceedings Intergovernmental Panel on Climate Change (IPCC) Scoping Meeting on Renewable Energy Sources*, 20–25 January, Lübeck, Germany, pp.33–58.
- Arvizu, D., P. Balaya, L. Cabeza, T. Hollands, A. Jäger-Waldau, M. Kondo, C. Konseibo, V. Meleshko, W. Stein, Y. Tamaura, H. Xu, and R. Zilles, 2011:** Direct Solar Energy. In *IPCC Special Report on Renewable Energy Sources and Climate Change Mitigation*, O. Edenhofer et al. (eds.), Cambridge University Press, Cambridge, UK and New York, NY, USA.
- Asplund, G., 2007:** *Transmission – The Missing Links towards a Sustainable Climate*. ABB Power systems, Ludvika, Sweden.
- AWEA, 2009:** *AWEA Small Wind Turbine Global Market Study: Year Ending 2008*. American Wind Energy Association, Washington, DC, USA.
- Axelsson, G., V. Stefansson, and G. Björnsson, 2005:** Sustainable utilization of geothermal resources for 100–300 years. In *Proceedings of World Geothermal Congress 2005*, 24–29 April, Antalya, Turkey.
- Axelsson, G., V. Stefansson, and Y. Xu, 2002:** Sustainable management of geothermal resources. In *Proceedings of 2002 Beijing International Geothermal Symposium*. Liu Jiurong (ed.), 29–31 October, Beijing, China, pp.277–283.
- Baker, P., C. Mitchell, and B. Woodman, 2009:** *The Extent to Which Economic Regulation Undermines the Move to a Sustainable Electricity System*. UK Energy Research Centre, London, UK.
- Barnett, P., and P. Quinlivan, 2009:** *Assessment of Current Costs of Geothermal Power Generation in New Zealand (2007 Basis)*, SKM report for New Zealand Geothermal Association.
- Bates, B. C., Z. W. Kundzewicz, S. Wu, and J.P. Palutikof (eds.), 2008:** *Climate Change and Water. Technical Paper of the Intergovernmental Panel on Climate Change*. IPCC Secretariat, Geneva, Switzerland.
- Battaglini, A., J. Lilliestam, A. Haas, and A. Patt, 2009:** Development of SuperSmart Grids for a more efficient utilisation of electricity from renewable sources. *Journal of Cleaner Production* **17**: 911–918.
- Bauen, A., B. Göran, M. Junginger, M. Londo, and F. Vuille, 2009:** *Bioenergy – A Sustainable and Reliable Energy Source*. IEA Bioenergy, Rotorua, New Zealand.
- Bauer, D., W. Heidemann, and H. Müller-Steinhagen, 2007:** Central solar heating plants with seasonal heat storage. In *Proceedings CISBAT 2007, International Conference On Renewable in a changing climate – Innovation in the Built Environment*, 4–5 September, Lausanne, Switzerland.
- Bauer, D., R. Marx, J. Nußbicker-Lux, F. Ochs, W. Heidemann, and H. Müller-Steinhagen, 2010:** German central solar heating plants with seasonal heat storage. *Solar Energy* **84**(4): 612–623.
- Baumgärtner, J., H. Menzel, and P. Hauße, 2007:** The Geox GmbH project in Landau – The first geothermal power project in Palatinate / Upper Rhine Valley. In *Proceedings of First European Geothermal Review, Geothermal Energy for Electric Power Production*, 29–31 October, Mainz, Germany.
- Beardmore, G., 2007:** The burgeoning Australian geothermal industry. *Quarterly Bulletin* **28**(3): 20–26.
- Beccquerel, E., 1839:** Mémoire sur les Effets Électriques Produits sous l'Influence des Rayons Solaires. *Comptes Rendues* **6**: 561–567.
- Bergman, P. C. A., S. V. B. van Paasen, and H. Boerrigter, 2002:** The novel "OLGA" technology for complete tar removal from biomass producer gas. *Pyrolysis and Gasification of Biomass and Wastes Expert Meeting*, 30 September-1 October, Strasbourg, France.
- Bertani, R., 2009:** *Long-Term Projections of Geothermal-Electric Development in the World*. ENEL Green Power, Rome, Italy.
- Bertani, R., 2010:** Geothermal Power Generation in the World: 2005–2010 Update Report. In *Proceedings of World Geothermal Congress 2010*, 25–30 April, Bali, Indonesia.
- Bertani, R., and I. Thain, 2002:** Geothermal power generating plant CO₂ emission survey. *IGA News* **49**: 1–3.
- Bird, L., C. Creycik, and B. Friedman, 2009:** *Green Power Marketing in the United States: A Status Report*. National Renewable Energy Laboratory, Golden, CO, USA.
- BIS, 2010:** *UK-China Scholarships for Excellence*. UK Department for Business Innovation & Skills (BIS). www.bis.gov.uk/policies/higher-education/international-education/china/scholarships-for-excellence (accessed 20 April 2010).
- Blair, N., W. Short, M. Mehos, and D. Heimiller, 2006:** Concentrating solar deployment systems (CSDS) – A new model for estimating U.S. concentrating solar power market potential. *ASES Solar 2006 Conference*, 8–13 June.
- Bloomfield, K. K., J. N. Moore, and R. N. Nelson, 2003:** Geothermal energy reduces greenhouse gases. *Bulletin* **32**: 77–79.

- Bloomquist, R. G., 2004:** Elko Heat Company district heating system – A case study. *Quarterly Bulletin* 25(2): 7–10.
- Bloomquist, R. G., J. T. Nimmons, and K. Rafferty, 1987:** *District Heating Development Guide – Legal, Institutional and Marketing Issues, Vol. 1.* Washington State Energy Office, Olympia, WA.
- BMU, 2006:** *Erneuerbare Energien: Arbeitsplatzeffekte, Wirkungen des Ausbaus erneuerbarer Energien auf den deutschen Arbeitsmarkt.* Federal Environment Ministry (BMU), Berlin, Germany.
- Bodmann, M., D. Mangold, J. Nußbicker, S. Raab, A. Schenke, and T. Schmidt, 2005:** *Solar unterstützte Nahwärme und Langzeit-Wärmespeicher (Februar 2003 bis Mai 2005).* Forschungsbericht zum BMWA/BMU-Vorhaben, Stuttgart, Germany.
- Bolhar-Nordenkamp, M., R. Rauch, and H. Hofbauer, 2003:** Biomass CHP plant Güssing – Using gasification for power generation. In *Proceedings of the 2nd RCETCE Conference*, 12–14 February, Phuket, Thailand, pp.567–572.
- Bolinger, M., R. Wiser, K. Cory, and T. James, 2009:** *PTC, ITC, or Cash Grant? An Analysis of the Choice Facing Renewable Power Projects in the United States.* National Renewable Energy Laboratory, Golden, CO, USA.
- Bosello, F., R. Roson, and R. S. J. Tol, 2006:** Economy-wide estimates of the implications of climate change: Human health. *Ecological Economics* 58(3): 579–591.
- Boud, R., 2002:** Status and Research and Development Priorities 2003 – Wave and Marine Current Energy. IEA Implementing Agreement on Ocean Energy Systems. www.iea-oceans.org (accessed 2 June 2010).
- Boyle G. (ed.), 1996:** *Renewable Energy, Power for a Sustainable Future.* Oxford University Press, Oxford, UK.
- BP, 2009:** *Statistical Review of World Energy 2009.* BP, London, UK. www.bp.com/sectiongenericarticle.do?categoryId=9023791&contentId=7044194 (accessed 19 March 2011).
- BP, 2011:** *Statistical Review of World Energy June 2011.* BP, London, UK. www.bp.com/statisticalreview (accessed 19 March 2011).
- Braun, M., 2009:** *Grid Integration of Gigawatts of Photovoltaics. CrystalClear Final Event*, 29 May, Munich, Germany.
- Brennan, L., and P. Owende, 2010:** Biofuels from microalgae – A review of technologies for production, processing, and extractions of biofuels and co-products. *Renewable and Sustainable Energy Reviews* 14(2): 557–577.
- Breuker, S., and M. Wolsink, 2007:** Wind power implementation in changing institutional landscapes: An international comparison. *Energy Policy* 35: 2737–2750.
- Brewer, T. L., 2008:** International Energy Technology Transfers for Climate Change Mitigation. Paper prepared for *CESifo Summer Institute Workshop Europe and Global Environmental Issues*, Venice, Italy, 14–15 July 2008.
- Breyer, Ch., Gerlach, A., 2010:** Global overview on grid parity event dynamics. In *Proceedings of the 25th European PV Solar Energy Conference and Exhibition*, 6–10 September, Valencia, Spain, pp.5283–5304.
- Bridgwater, A. V., and G. V. C. Peacocke, 2000:** Fast pyrolysis processes for biomass. *Renewable and Sustainable Energy Reviews* 4(1): 1–73.
- Bringezu, S., H. Schütz, M. O'Brien, L. Kauppi, R. W. Howarth, and J. McNeely, 2009:** *Towards Sustainable Production and Use of Resources: Assessing Biofuels.* United Nations Environment Programme, Nairobi, Kenya.
- Bromley, C. J., M. A. Mongillo, B. Goldstein, G. Hiriart, R. Bertani, E. Huenges, H. Maraoka, A. Ragnarsson, J. Tester, and V. Zui, 2010:** IPCC renewable energy report – The potential contribution of geothermal energy to climate change mitigation. In *Proceedings of World Geothermal Congress 2010*, 25–30 April, Bali, Indonesia.
- Brouwer, L. C., and L. Bosselaar, 1999:** Policy for stimulating passive solar energy in the Netherlands. In *Proceedings of the Northsun 1999 Conference*, Edmonton, Canada.
- Brown, M. A., and S. J. Chandler, 2008:** Governing confusion: How statutes, fiscal policy, and regulations impede clean energy technologies. *Stanford Law and Policy Review* 19(3): 472–509.
- BTM Consult, 2010:** *International Wind Energy Development: World Market Update (2009).* Ringkøbing, Denmark.
- Burkhardt, J., G. Heath, and C. Turch, 2010:** Life Cycle Assessment of a Model Parabolic Trough Concentrating Solar Power Plant with Thermal Energy Storage. In *Proceedings of ASME 2010 4th International Conference on Energy Sustainability*, 17–22 May, Phoenix, Arizona, USA.
- Burton T., D. Sharpe, N. Jenkins, and E. Bossanyi, 2001:** *Wind Energy: Handbook.* J. Wiley, New York, NY, USA.
- Callaghan, J., 2006:** *Future Marine Energy; Results of the Marine Energy Challenge – Cost competitiveness and growth of wave and tidal stream energy.* Research Report, Carbon Trust, London, UK
- Cappetti, G. 2009:** *Larderello: a case history of production sustainability.* CEGL Workshop on Geothermal Energy: Opportunities and Challenges, Pomarance, Tuscan, Italy, 3–4 September 2009.
- Cavanagh, J. E., J. H. Clarke, and R. Price, 1993:** Ocean Energy Systems. In *Renewable Energy: Sources for Fuels and Electricity.* T. B. Johansson et al. (eds.), Island Press, Washington, pp.513–547.
- Cazzola, P., 2009:** *Algae for biofuel production: process description, life cycle assessment and some information on cost.* IEA Bioenergy Executive Committee 64, Liege, Belgium, 1 October.
- CEC, 1996:** *Wave Energy Project Results: The Exploitation of Tidal Marine Currents.* Commission of the European Communities (CEC), DGXII, Brussels, Belgium.
- CEC, 1998:** *Promotion of New Energy Sources in the Zhejiang Province, China – Final Report.* Program SYNERGY, Commission of the European Communities (CEC), DGXVII, Brussels, Belgium.
- Chad, A., J. W. Tester, B. J. Anderson, S. Petty, and B. Livesay, 2006:** A comparison of geothermal with oil and gas well drilling costs. *Thirty-first Workshop on Geothermal Reservoir Engineering, January 30-February 1*, Stanford University, Stanford, CA, USA.
- Charlier, R. H. and J. R. Justus, 1993,** *Ocean Energies: Environmental, Economic and Technological Aspects of Alternative Power Sources.* Elsevier Oceanography Series, Elsevier, Amsterdam, Netherlands.
- Chen, H., T. N. Cong, W. Yang, C. Tan, Y. Li, and Y. Ding, 2009:** Progress in electrical energy storage system: a critical review. *Progress in Natural Science* 19: 291–312.
- Chen, Y., G. Yang, S. Sweeney, and Y. Feng, 2010:** Household biogas use in rural China: A study of opportunities and constraints, *Renewable and Sustainable Energy Reviews* 14(1): 545–549.
- Chum, H., A. Faaij, J. Moreira, G. Berndes, P. Dhamija, H. Dong, B. Gabrielle, A. Goss-Eng, W. Lucht, M. Mapako, O. Masera, T. McIntyre, T. Minowa, and K. Pingoud, 2011:** Bioenergy. In *IPCC Special Report on Renewable Energy Sources and Climate Change Mitigation.* O. Edenhofer et al. (eds), Cambridge University Press, Cambridge, UK and New York, NY, USA.
- Clément, A., P. McCullen, A. Falcão, A. Fiorentino, F. Gardner, K. Hammarlund, G. Lemonis, T. Lewis, K. Nielsen, S. Petroncini, M.T. Pontes, P. Schild, B.O. Sjöström, H. C. Sørensen, and T. Thorpe, 2002:** Wave Energy in Europe:

- current status and perspectives. *Renewable and Sustainable Energy Reviews* 6(5): 405–431.
- Coll-Mayor, D., M. Paget, and E. Lightner, 2007:** Future intelligent power grids: Analysis of the vision on the European Union and the United States. *Energy Policy* 35: 2453–2465.
- CONCAWE, EUCAR, and JRC, 2007:** *Well-to-Wheels Analysis of Future Automotive Fuels and Powertrains in the European Context: Well-to-Tank Report*, version 2c. Conservation of Clean Air and Water in Europe (CONCAWE), European Council for Automotive R&D (EUCAR), and Joint Research Centre, European Commission (JRC).
- CONCAWE, EUCAR, and JRC, 2008:** *Well-to-Wheels Analysis of Future Automotive Fuels and Powertrains in the European Context*, Well-to-tank report version 3.0, Appendix 2: Description and detailed energy and GHG balance of individual pathways. Conservation of Clean Air and Water in Europe (CONCAWE), European Council for Automotive R&D (EUCAR), and Joint Research Centre, European Commission (JRC).
- Cooper, D. J., L. J. Meyer, and R. J. Varley, 2009:** OTEC Commercialization Challenges. In *Proceedings Offshore Technology Conference*, 4–7 May 2009, Houston, Texas, USA.
- Cornett, A. M., 2006:** *Inventory of Canada's Marine Renewable Energy Resources*. Canadian Hydraulics Centre, Natural Research Council Canada, Ottawa, Canada, CHC-TR-041.
- Costa, A., A. Crespo, J. Navarro, G. Lizcano, H. Madsen, and E. Feitosa, 2008:** A review on the young history of the wind power short-term prediction. *Renewable and Sustainable Energy Reviews* 12: 1725–1744.
- Couture, T. D., K. Cory, C. Kreycik, E. Williams, 2010:** Policymaker's Guide to Feed-in Tariff Policy Design, NREL Report No. TP-6A2–44849, 144pp.
- Criscione, V., 2010:** Norway's pioneering role in osmotic power. *Nortrade.com* 16 September 2010.
- Currie, M. J., J. K. Mapel, T. D. Heidel, S. Goffri, and M. A. Baldo, 2008:** High-efficiency organic solar concentrators for photovoltaics. *Science* 321: 226–228.
- Curtis, R., J. Lund, B. Sanner, L. Rybach, and G. Hellström, 2005:** Ground source heat pumps – Geothermal energy for anyone, anywhere: Current worldwide activity. In *Proceedings of World Geothermal Congress 2005*, 24–29 April 2005, Antalya, Turkey.
- Dallinger, D. 2009:** Analysis of possible vehicle-to-grid benefits to battery vehicle owners. *Technical Conference on Advanced Battery Technologies for Automobiles and their Electric Power Grid Integration*, 20–21 January. Haus der Technik, Essen, Germany.
- Dayton, D., 2002:** *A Review of the Literature on Catalytic Biomass Tar Destruction*. Milestone Completion Report. National Renewable Energy Laboratory, Golden, CO, USA.
- de Wild-Scholten, M., 2010:** *Life Cycle Assessment of Photovoltaics: from cradle to cradle*. First International Conference on PV Module Recycling, 26 January 2010, Berlin, Germany. www.epia.org/events/past-events/epia-events-within-the-last-year/1st-international-conference-on-pv-module-recycling.html (accessed 6 June 2011).
- de Wild-Scholten, M., 2011:** *Environmental profile of PV mass production: globalization*, 26th European Photovoltaic Solar Energy Conference, 5–9 September 2011, Hamburg, Germany.
- DECC, 2009:** *The UK Renewable Energy Strategy*. UK Department of Energy & Climate Change (DECC), London, UK.
- DECC, 2010:** *Low Carbon Communities Challenge*. UK Department of Energy & Climate Change (DECC), London, UK.
- Degner, T., J. Schmid, and P. Strauss (eds.), 2006:** *DISPOWER-Distributed Generation with High Penetration of Renewable Energy Sources*. Final Public Report, ISET 5–2006, Kassel, Germany.
- DeLong, M. M., 1995:** *Economic Development Through Biomass System Integration: Summary Report*. National Renewable Energy Laboratory, Golden, CO, USA.
- Denholm, P., 2007:** *The Technical Potential of Solar Water Heating to Reduce Fossil Fuel Use and Greenhouse Gas Emissions in the United States*. National Renewable Energy Laboratory, Golden, CO, USA.
- Denholm, P., E. Ela, B. Kirby, and M. Milligan, 2010:** *The Role of Energy Storage with Renewable Electricity Generation*. National Renewable Energy Laboratory, Golden, CO, USA.
- DESERTEC Foundation, 2010:** DESERTEC in EU-MENA. Available at www.desertec.org/press/#c1413 (accessed 14 November 2011).
- DESERTEC Foundation, 2011:** *Red Paper: An Overview of the DESERTEC Concept*. Hamburg, Germany.
- Desholm, M., and J. Kahlert, 2005:** Avian collision risk at an offshore wind farm. *Biology Letters* 1(3): 296–298. (p297, Figure 1. "The westerly oriented flight trajectories during the initial operation of the wind turbines. Black lines indicate migrating waterbird flocks, red dots the wind turbines" used as Figure 11.43).
- Deutsche Bank, 2010a:** *GET FIT Program – Global Energy Transfer Feed-In Tariffs for Developing Countries*. New York, NY, USA.
- Deutsche Bank, 2010b:** *Investing in Climate Change 2010 – A Strategic Asset Allocation Perspective*. New York, NY, USA.
- Devine-Wright, P, 2005:** Beyond Nimbyism: Towards an integrated framework for understanding public perceptions of wind energy. *Wind Energy* 8(2): 125–139.
- DP Energy, 2010:** Tidal Energy. www.dpenergy.com/information/tidal.html (accessed 06 Dec 2011).
- ECF, 2010:** *Roadmap 2050 – A Practical Guide to a Prosperous, Low Carbon Europe*. European Climate Foundation (ECF), The Hague, Netherlands. www.roadmap2050.eu/ (accessed 17 May 2011).
- Ecoheatcool, 2005–2006:** *Possibilities with More District Heating in Europe*. Ecoheatcool Work package 4, Final Report. Ecoheatcool and Ecoheat & Power, Brussels, Belgium.
- EEGI, 2010:** *The European Electricity Grid Initiative – Roadmap 2010–2018 and Detailed Implementation Plan 2010–12*. European Network of Transmission System Operators for Electricity (ENTSO-E) and European Distribution System Operators for Smart Grids (EDSO-SG). European Electricity Grid Initiative (EEGI), Brussels, Belgium.
- Electricité de France and Observ'ER, 2010:** *Worldwide Electricity Production from Renewable Energy Sources, 12th inventory*. Paris, France. energies-renouvelables.org/observ-er/html/inventaire/Eng/methode.asp (accessed 6 June 2010).
- Ellis, G., R. Cowell, C. Warren, P. Strachan, J. Szarka, R. Hadwin, P. Miner, M. Wolsink, and A. Nádai, 2009:** Wind Power: Is There A 'Planning Problem'? *Journal of Planning Theory and Practice* 10(4): 521–547.
- EnerNex, 2010:** *Eastern Wind Integration and Transmission Study*. Prepared for the National Renewable Energy Laboratory, EnerNex Corporation, Golden, CO, USA.
- Engstrom, S., N. Lindman, E. Rensfelt, and L. Waldheim, 1981:** A new synthesis gas process for biomass and peat. *Energy from Biomass and Wastes V*. Institute of Gas Technology, Chicago, IL, USA.

- ENTSO-E, 2010:** *Ten-Year Network Development Plan 2010–2020*. European Network of Transmission System Operators for Electricity (ENTSO-E), Brussels, Belgium.
- EPE, 2008:** *PLANO DECENAL DE EXPANSÃO DE ENERGIA 2008–2017*. Prepared for the Ministry of Mines and Energy, Secretariat of Planning and Energy Development, Empresa de Planejamento Energético (EPE), Brasília, Brazil.
- EPIA, 2009:** *SET for 2020 (Executive Summary)*. European Photovoltaic Industry Association (EPIA), Brussels, Belgium.
- EPIA, 2011:** *Global Market Outlook for Photovoltaics until 2015*, European Photovoltaic Industry Association (EPIA), Brussels, Belgium.
- Epp, B., 2009:** World map of flat plate collector manufacturers 2009, In *Sun & Wind Energy* December, Solrico, Bielefeld, Germany.
- EPTP, 2007:** *A Strategic Research Agenda for Photovoltaic Solar Energy Technology*. European Photovoltaic Technology Platform (EPTP), Office for Official Publications of the European Communities, Luxembourg.
- EPTP, 2009:** *Today's Actions for Tomorrow's PV Technology; An Implementation Plan for the Strategic Research Agenda of the European Photovoltaic Technology Platform*. European Photovoltaic Technology Platform (EPTP), Office for Official Publications of the European Communities, Luxembourg.
- EPTP, 2010:** *Calculation tool*. European Photovoltaic Technology Platform (EPTP), www.eupvplatform.org/pv-development/tools.html (accessed 18 May 2011).
- EREC, 2008:** *The Renewable Energy House – Europe's Headquarters for Renewable Energy*. European Renewable Energy Council (EREC), Brussels, Belgium.
- EREC and Greenpeace, 2010:** *Energy [R]evolution – a Sustainable World Energy Outlook*. European Renewable Energy Council (EREC), Brussels, Belgium and Greenpeace International, Amsterdam, Netherlands.
- ERS, undated:** *Crops, U.S. Department of Agriculture*. Economic Research Service (ERS), Washington, DC. www.ers.usda.gov/Browse/view.aspx?subject=Crops (accessed 15 October 2010).
- ESRU, undated:** *Biofuels, University of Strathclyde*. Energy Systems Research Unit (ESRU), Glasgow, Scotland. www.esru.strath.ac.uk/EandE/Web_sites/02-03/biofuels/quant_biodiesel.htm (accessed 7 July 2010).
- ESTIF, 2007:** *Solar Thermal Markets in Europe 2006*. European Solar Thermal Industry Federation (ESTIF), Brussels, Belgium.
- ESTTP, 2008:** *Solar Heating and Cooling for a Sustainable Energy Future in Europe – Strategic Research Agenda*. European Solar Thermal Technology Platform (ESTTP), Brussels, Belgium.
- EU, 2009:** *The Impact of RE policy on economic growth and employment in the EU*. European Union (EU), Brussels, Belgium.
- Eugster, W. J. and L. Rybach, 2000:** Sustainable production from borehole heat exchanger systems. In *Proceedings of World Geothermal Congress 2000*, 28 May–10 June, Kyushu-Tohoku, Japan, pp.825–830.
- EurObserv'ER, 2010:** Solid Biomass Barometer. *Systemes Solaires, le Journal des Energies Renouvelables* 200 (November).
- Euroheat & Power, 2007:** *District Heating and Cooling – 2007 Statistics*. www.euroheat.org/Statistics-69.aspx (accessed 23 May 2010).
- European Commission, 2006:** *World Energy Technology Outlook – 2050*. Brussels, Belgium.
- European Commission, 2010:** *European Wind Integration Study*. Sixth Framework Programme, Brussels, Belgium.
- European Parliament, 2009:** *Directive of the European Parliament and the Council on the promotion of the use of energy from renewable sources amending and subsequently repealing, Directives 2001/77/EC and 2003/30/EC*. Brussels, Belgium.
- European Photovoltaic Industry Association/Greenpeace International, 2011:** *Solar Generation 6*. Brussels, Belgium.
- Evans, R. J., R. A. Knight, M. Onischak, and S. P. Babu, 1987:** Process performance and environmental assessment of the renugas process. In *Energy from Biomass and Wastes X*, D. L. Klass (ed.), Elsevier Applied Science, London, UK and Institute of Gas Technology, Chicago, IL, USA, pp.677–694.
- EWEA, 2009:** *The Economics of Wind Energy*. European Wind Energy Association (EWEA), Brussels, Belgium.
- EWEA, 2010:** *European Offshore Wind Industry – Key Trends and Statistics*. European Wind Energy Association (EWEA), Brussels, Belgium.
- EWEA, 2011:** *European Offshore Wind Industry – Key Trends and Statistics 2010*. European Wind Energy Association (EWEA), Brussels, Belgium.
- ExternE, 1995:** *Externalities of Energy – Volume 6, Wind and Hydro*. European Commission, Directorate General XII, Science, Research and Development, Brussels, Belgium.
- Faaij, A., 2006:** Modern biomass conversion technologies. *Mitigation and Adaptation Strategies for Global Change* 11(2): 335–367.
- FAO, 2008:** *The State of Food and Agriculture: Biofuels Prospects, Risks, and Opportunities*. Food and Agriculture Organization (FAO), Rome, Italy.
- FAPRI, undated:** *Biofuel Conversion Factors*. Food and Agricultural Policy Research Institute (FAPRI), Ames, IA, USA.
- Farrell, A. E., R. J. Plevin, B. T. Turner, A. D. Jones, M. O'Hare, and D. M. Kammen, 2006:** Ethanol Can Contribute to Energy and Environmental Goals. *Science* 311(5760): 506–508.
- FAS, undated:** *EU Rapeseed Yield*. Foreign Agricultural Service (FAS), US Department of Agriculture, Washington, DC, USA. www.pecad.fas.usda.gov/highlights/2007/05/EU_21May07/EURapeseedYield.htm (accessed 17 February 2011).
- Felix-Soul, R, 2008:** Assessing the impact of Mexico's Biofuels Law. *Biomass Power and Thermal*. June 2008.
- Florentinus, A., 2009:** *Worldwide potential of aquatic biomass: algae as the new sustainable bio-energy resource*. World Bio Energy – Clean Vehicles and Fuels, Stockholm, Sweden.
- Florentinus, A., C. Hamelinck, S. de Lint, and S. van Iersel, 2008:** *Worldwide Potential of Aquatic Biomass*, Ecofys, Utrecht, The Netherlands.
- FOSG, 2010:** *Position paper on the EC Communication for a European Infrastructure Package*. Friends of the Supergrid (FOSG), Brussels, Belgium.
- Foxon, T., R. Gross, P. Heptonstall, P. Pearson, and D. Anderson, 2007:** *Energy Technology Innovation: A Systems Perspective – Report for the Garnaut Climate Change Review*. Sustainability Research Institute, University of Leeds and ICEPT Centre for Environmental Policy, Imperial College, London, UK.
- Fraenkel, P. L., 1999:** New Developments in Tidal and Wavepower Technologies. In *Proceedings of the Silver Jubilee Conference 'Towards a Renewable Future,'* Solar Energy Society, 13–15 May, 1989, Brighton, UK.
- Frankhauser, S., F. Sehlleier, and N. Stern, 2008:** Climate change, innovation and jobs. *Climate Policy* 8: 421–429.
- Fridleifsson, G. O., A. Albertsson, B. Stefansson, E. Gunnlaugsson, and H. Adalsteinsson, 2007:** Deep unconventional geothermal resources: A major opportunity to harness new sources of sustainable energy. In *Proceedings of 20th World Energy Conference*, 12–15 November, Rome, Italy.

- Fridleifsson, I. B., R. Bertani, E. Huenges, J. W. Lund, A. Ragnarsson, and L. Rybach, 2008:** The possible role and contribution of geothermal energy to the mitigation of climate change. *IPCC Geothermal Report*, presented at Potsdam, Germany, 11 February, 2008.
- Fthenakis, V., J. E. Mason, and K. Zweibel, 2009:** The technical, geographical, and economic feasibility for solar energy to supply the energy needs of the US. *Energy Policy* 37(2): 387–399.
- FVEE, 2010:** *Energiekonzept: Eine Vision für ein nachhaltiges Energiekonzept auf Basis von Energieeffizienz und 100% erneuerbaren Energien (A Vision for a Sustainable Energy Concept Based on Energy Efficiency and Renewable Energies)*. ForschungsVerbund Erneuerbare Energien (FVEE), Berlin, Germany.
- Garrison, T., 2008:** *Essentials of Oceanography*. Brooks Cole, Pacific Grove, CA, USA.
- Geo-Heat Center, 1998:** *Geo-Heat Center Quarterly Bulletin* 19(1): March.
- Geo-Heat Center, 2003:** *Geo-Heat Center Quarterly Bulletin* 24(3): September.
- Geo-Heat Center, 2005:** Combined geothermal heat & power plants, *Geo-Heat Center Quarterly Bulletin* 26(2).
- Geo-Heat Center, 2006:** *Feasibility Study for the Direct Use of Geothermal Energy for Onion Dehydration in Vale/Ontario Area, Oregon*. Oregon Institute of Technology, Klamath Falls, OR, USA.
- Geothermal Task Force Report, 2006:** Clean and Diversified Energy Initiative, Western Governors' Association, Geothermal Energy Association, Washington, DC.
- German Aerospace Institute, 2005:** Concentrating Solar Power for the Mediterranean Region (MED-CSP). www.dlr.de/tt/desktopdefault.aspx/tabid-2885/4422_read-6575/ (accessed 9 March 2011).
- Gil, A., M. Medrano, I. Martorell, A. Lázaro, P. Dolado, B. Zalba, and L. F. Cabeza, 2010:** State of the art on high-temperature thermal energy storage for power generation. Part 1 – Concepts, materials and modellization. *Renewable and Sustainable Energy Reviews* 14: 31–55.
- Gill, A. B., 2005:** Offshore renewable energy: Ecological implications of generating electricity in the coastal zone. *Journal of Applied Ecology* 42: 605–615.
- Global Bioenergy Partnership, 2007:** *A Review of the Current State of Bioenergy Development in G8+5 Countries*. Food and Agriculture Organization (FAO), Rome, Italy.
- Goldemberg, J., S.T. Coelho, P. M. Nastari, and L. O., 2004:** Ethanol learning curve – the Brazilian experience. *Biomass and Bioenergy* 26: 301–304.
- Goldenfum, J. A., 2011:** Tool of the trade: details on the UNESCO/IHA GHG Measurement Guidelines for Fresh Water Reservoirs, *International Water Power & Dam Construction* January 2011. www.waterpowermagazine.com/storyprint.asp?sc=2058692 (accessed 7 February 2011).
- Goldstein, B., G. Hiriart, R. Bertani, C. Bromley, L. Gutiérrez-Negrín, E. Huenges, H. Muraoka, A. Ragnarsson, J. Tester, V. Zui, 2011:** Geothermal Energy. In *IPCC Special Report on Renewable Energy Sources and Climate Change Mitigation*, O. Edenhofer et al. (eds.), Cambridge University Press, Cambridge, UK and New York, NY, USA.
- Gottstein, M. and L. Schwartz, 2010:** *The Role of Forward Capacity Markets in Increasing Demand-side and Other Low-carbon Resources: Experience and Prospects*. Regulatory Assistance Project, Montpelier, VT, USA.
- Goudriaan, F., and J. E. Naber, 2008:** HTU diesel: From wet waste streams. In *Symposium New Biofuels*, May 2008, Berlin, Germany.
- Goyal, M., 2010:** Repowering – The next big thing in India. *Renewable and Sustainable Energy Reviews* 14: 1400–1409.
- Green, M.A., 2003:** *Third Generation Photovoltaics; Advanced Solar Energy Conversion*. Springer-Verlag, Berlin, Germany.
- Green, M. A., K. Emery, Y. Hishikawa, and W. Warta, 2010:** Solar cell efficiency tables (version 37). *Progress in Photovoltaics: Research Applications* 19: 84–92.
- Greenpeace and EPIA, 2008:** *Solar Generation V*. Greenpeace International, Amsterdam, Netherlands and European Photovoltaic Industry Association (EPIA), Brussels, Belgium.
- Greenpeace and EPIA, 2010:** *Solar Generation 6 (Executive Summary)*. Greenpeace International, Amsterdam, Netherlands and European Photovoltaic Industry Association (EPIA), Brussels, Belgium.
- Greenpeace and EREC, 2007:** *Energy [R]evolution – A Sustainable World Energy Outlook*. Greenpeace International, Amsterdam, Netherlands and European Renewable Energy Council (EREC), Brussels, Belgium.
- Greenpeace and EREC, 2010:** *Energy [R]evolution – Towards a Fully Renewable Energy Supply in the EU-27*. Greenpeace International, Amsterdam, Netherlands and European Renewable Energy Council (EREC), Brussels, Belgium.
- Greenpeace, ESTELA, and SolarPACES, 2009:** *Concentrating Solar Power: Global Outlook 2009 – Why Renewable Energy Is Hot*. Greenpeace International, Amsterdam, Netherlands, European Solar Thermal Electricity Association (ESTELA), Brussels, Belgium, and Solar PACES, Tabernas, Spain.
- Gross, R. and P. Hepponstall, 2008:** The costs and impacts of intermittency: an ongoing debate. *Energy Policy* 36: 4005–4007.
- Grubb, M., 2004:** Technological innovation and climate change policy: An overview of issues and options. *Keio Economic Studies* 41(2): 103–132.
- GTM Research, 2011:** *Concentrating Solar Power 2011: Technology, Costs and Markets*. www.gtmresearch.com/report/concentrating-solar-power-2011-technology-costs-and-markets (accessed 9 November 2010).
- Gunnlaugsson, E. and G. Gislason, 2003:** Reykjavik energy – District heating in Reykjavik and electrical production using geothermal energy. In *Lectures on the Sustainable Use and Operating Policy for Geothermal Resources*. I. B. Fridleifsson and M. V. Gunnarsson (eds.), United Nations University Geothermal Training Programme, pp.67–78.
- Gunnlaugsson, E., 2007:** *Personal Communication, Reykjavik District Heat System*, Reykjavik, Iceland.
- GWEC and Greenpeace, 2010a:** *Global Wind Energy Outlook 2010*. Global Wind Energy Council (GWEC), Brussels, Belgium and Greenpeace International, Amsterdam, Netherlands.
- GWEC and Greenpeace, 2010b:** *Global Wind 2009 Report*. Global Wind Energy Council (GWEC), Brussels, Belgium and Greenpeace International, Amsterdam, Netherlands.
- Häberle, A., C. Zahler, H. Lerchenmüller, M. Mertins, C. Wittwer, F. Trieb, and J. Dersch, 2002:** The Solarmundo line focussing Fresnel collector. Optical and thermal performance and cost calculations, In *Proceedings of the 11th International Solar Paces Conference*, September 2002, Zürich, Switzerland.
- Hamelinck, C. N., and A. P. C. Faaij, 2006:** Production of advanced biofuels. *International Sugar Journal* 108(1287): 168–175.
- Hamilton, K., 2009:** *Unlocking Finance for Clean Energy: The Need for 'Investment Grade' Policy*. Chatham House, London, UK.
- Hamududu, B. and Å. Killingtveit, 2010:** Estimating Effects of Climate Change on Global Hydropower Production, In *Hydropower10: 6th International Conference on Hydropower*, Tromsø, Norway, 1–3 February 2010.

- Hance, C. N., 2005:** *Factors Affecting Costs of Geothermal Power Development*. Geothermal Energy Association, Washington, DC.
- Harvey, L. D., 2006:** *A handbook on Low-Energy Building and District-Energy Systems: Fundamentals, Techniques and Examples*. Earthscan, Sterling, VA, USA.
- Harvey, L. D., 2010:** *Carbon-Free Energy Supply*. Earthscan, London, UK, pp. 311–324.
- Haselip, J., Nygaard, I., Hansen, U., Ackom, E. (eds.), 2010:** Diffusion of renewable energy technologies: case studies of enabling frameworks in developing countries. Technology Transfer Perspectives Series, UNEP Riso Centre, Denmark, pp 3–32.
- Hassuani, S. J., 2009:** *Personal communication*. Sugarcane Technology Center, Piracicaba, Brazil, 18 December.
- Hatzigaryiou, N., H. Asano, R. Iravani, and C. Marnay, 2007:** Microgrids. *IEEE Power & Energy Magazine* 5(4): 78–94.
- Hatzigaryiou, N., 2008:** Microgrids, the key to unlock distributed energy resources? *IEEE Power & Energy Magazine* 6(3): 26–30.
- Heinemann, D., E. Lorenz, and M. Girodo, 2006:** Forecasting of solar radiation. In *Solar Energy Resource Management for Electricity Generation From Local Level to Global Scale*. E. D. Dunlop, L. Wald, and M. Šúri (eds.), Nova Science Publishers, Hauppauge, NY, pp.83–94.
- Hettinga, W. G., H. M. Junginger, S. C. Dekker, M. Hoogwijk, A. J. McAloon, and K. B. Hicks, 2009:** Understanding the reductions in US corn ethanol production costs: An experience curve approach. *Energy Policy* 37(1): 190–203.
- Hjuler Jensen, P., 2007:** UpWind: Wind energy research project under the 6th Framework Programme. In *Proceedings of International Energy Conference 2007 on Energy Solutions for Sustainable Development*, 22–24 May, Risø, Denmark. L. Sønderberg Petersen and H. Larsen (eds.), Risø National Laboratory, pp.135–139.
- Hoffmann, W., S. Wieder, and T. Pellkofer, 2009:** Differentiated price experience curves as evaluation tool for judging the further development of crystalline silicon and thin film solar electricity. In *Proceedings of the 24th European PV Solar Energy Conference*, 21–25 September 2009, Hamburg, pp.4387–4394.
- Holttinen, H., B. Lemström, P. Meibom, H. Bindner, A. Orths, F. Van Hulle, C. Ensslin, A. Tiedemann, L. Hofmann, W. Winter, A. Tuohy, M. O'Malley, P. Smith, J. Pierik, J. O. Tande, A. Estanqueiro, E. Gomez, L. Söder, G. Strbac, A. Shakoob, J. C. Smith, P. Parsons, M. Milligan, and Y. Wan, 2007:** *Design and Operation of Power Systems with Large Amounts of Wind Power – State-of-the-Art Report*. VTT Technical Research Centre of Finland, Espoo, Finland.
- Hoogwijk, M., B. de Vries, and W. Turkenburg, 2004:** Assessment of the global and regional geographical, technical, and economic potential of onshore wind energy, *Energy Economics* 26: 889–919.
- Huber, G. W., S. Iborra, and A. Corma, 2006:** Synthesis of transportation fuels from biomass: Chemistry, catalysts, and engineering. *Chemical Reviews* 106: 4044–4098.
- Huenges, D., L. Moeck, A. Saadat, W. Brand, A. Schulz, H. Holl, D. Bruhn, G. Zimmerman, G. Blöcher, and L. Wohlgemuth, 2007:** Geothermal research well in a deep sedimentary reservoir. *Geothermal Resources Council Bulletin* 36. Geothermal Resources council (GRC), Davis, CA, USA.
- Hughes, T., 1983:** *Networks of Power: Electrification in Western Society 1880–1930*. John Hopkins University Press, Baltimore, MD, USA.
- Huld, T., M. Šúri, and E. D. Dunlop, 2008:** Comparison of potential solar electricity output from fixed-inclined and two-axis tracking photovoltaic modules in Europe. *Progress in Photovoltaics: Research Applications* 16: 47–59.
- Ibrahim, H., A. Ilinca, and J. Perron, 2008:** Energy storage systems – characteristics and comparisons. *Renewable and Sustainable Energy Reviews* 12: 1221–1250.
- IEA, 2000:** *Hydropower and the Environment: Present Context and Guidelines for Future Action*. Vol. II: *Main Report*, Chapter 3: “Comparative Environmental Analysis of Power Generation Options.” International Energy Agency (IEA), Paris, France.
- IEA, 2005:** *Prospects for Hydrogen and Fuel Cells*. International Energy Agency (IEA), Paris, France.
- IEA, 2007:** *Renewables for Heating and Cooling*. International Energy Agency (IEA), Paris, France.
- IEA, 2008a:** *World Energy Outlook 2008*. International Energy Agency (IEA), Paris, France.
- IEA, 2008b:** *Energy Technology Perspectives 2008 – Scenarios and Strategies to 2050*. International Energy Agency (IEA), Paris, France.
- IEA, 2008c:** *Empowering Variable Renewables – Options for Flexible Electricity Systems*. International Energy Agency (IEA), Paris, France.
- IEA, 2008d:** *Deploying Renewables: Principles for Effective Policies*. International Energy Agency (IEA), Paris, France.
- IEA, 2009a:** *World Energy Outlook 2009*. International Energy Agency (IEA), Paris, France.
- IEA, 2009b:** *Technology Roadmap – Wind Energy*. International Energy Agency (IEA), Paris, France.
- IEA, 2009c:** *Cities, Towns & Renewable Energy – Yes in My Front Yard*. International Energy Agency (IEA), Paris, France.
- IEA, 2009d:** *Multilateral Technology Initiatives (Implementing Agreements)*. International Energy Agency (IEA), Paris, France. www.iea.org/Textbase/technol/index.asp (accessed 22 April 2009).
- IEA, 2010a:** *Energy Technology Perspectives 2010 – Scenarios and Strategies to 2050*. International Energy Agency (IEA), Paris, France.
- IEA, 2010b:** *World Energy Outlook 2010*. International Energy Agency (IEA), Paris, France.
- IEA, 2010c:** *Algae – The Future for Bioenergy?* International Energy Agency (IEA), Paris, France.
- IEA, 2010d:** *Technology Roadmap: Solar Photovoltaic Energy*. International Energy Agency (IEA), Paris, France.
- IEA, 2010e:** *Technology Roadmap – Concentrating Solar Power*. International Energy Agency (IEA), Paris, France.
- IEA, 2010f:** *Energy Subsidies: Getting the Prices Right*. International Energy Agency (IEA), Paris, France.
- IEA, 2010g:** *Key World Energy Statistics*. International Energy Agency (IEA), Paris, France.
- IEA, 2011:** *Energy Balances of Non-OECD Countries 2011*. International Energy Agency (IEA), Paris, France.
- IEA Bioenergy Task 39, undated:** *Commercializing 1st and 2nd Generation Liquid Fuels from Biomass*. biofuels.abc-energy.at/demoplants/projects/mapindex (accessed 2 February 2011).
- IEA-CERT, 2011:** *Energy Efficiency in Buildings – Heating and Cooling: Technology Roadmap (Draft 28 January 2011)*. International Energy Agency (IEA)-Committee on Energy Research and Technology (CERT), Paris, France.
- IEA-DHC, 2002:** *District Heating and Cooling Connection Handbook*. IEA District Heating and Cooling (IEA-DHC), Paris, France.
- IEA-ETSAP, 2010:** *Marine Energy. Technology Brief 13*. IEA Energy Technology Systems Analysis Program (IEA-ETSAP), Paris, France.

- IEA-OES-IA, 2011:** *Implementing Agreement on Ocean Energy Systems – Annual Report 2010*. IEA Ocean Energy Systems Implementing Agreement OES-IA (IEA-OES-IA), Wave Energy Centre, Lisbon, Portugal.
- IEA-PVPS, 2002:** *Potential for Building Integrated Photovoltaics*. International Energy Agency-Photovoltaic Power Systems Programme (IEA-PVPS), Paris, France.
- IEA-PVPS, 2007:** *Cost and Performance Trends in Grid-connected Photovoltaic Systems and Case Studies*. International Energy Agency-Photovoltaic Power Systems Programme (IEA-PVPS), Paris, France.
- IEA-PVPS, 2010:** *Trends in Photovoltaic Applications 1992–2009*. International Energy Agency-Photovoltaic Power Systems Programme (IEA-PVPS), Paris, France.
- IEA-PVPS, 2011:** *Trends in Photovoltaic Applications 1992–2010*. International Energy Agency-Photovoltaic Power Systems Programme (IEA-PVPS), Paris, France.
- IEA-SHC, 2009:** *Solar Crop Drying*. International Energy Agency – Solar Heating & Cooling Programme (IEA-SHC). www.iea-shc.org/task29/index.html (accessed 21 January 2009).
- IEA-Wind, 2010:** *IEA Wind Energy Annual Report 2009*. Executive Committee for the Implementing Agreement for Co-operation in the Research, Development and Deployment of Wind Energy Systems of the International Energy Agency, Paris, France.
- IEC, 2010:** *Various Electrical Standards*. International Electrotechnical Commission (IEC). www.iec.ch/ (accessed 12 May 2010).
- IEEE, 2009:** Wind and the grid: The challenges of wind integration. Institute of Electrical and Electronics Engineers (IEEE). *IEEE Power and Energy Magazine* 7.
- IHA, 2005:** Andhikhola Rural Development. International Hydropower Association (IHA). www.hydropower.org/iha_blue_planet_prize/information.html (accessed 3 April 2010).
- IHA, 2010a:** *2010 Activity Report: Status of the Hydropower Sector*. International Hydropower Association (IHA), London, UK. p.5.
- IHA, 2010b:** *Background Document – Hydropower Sustainability Assessment Protocol 2010*. International Hydropower Association (IHA), London, UK. pp.7, 9.
- IHS EER, 2009:** *Global Concentrated Solar Power Markets and Strategies, 2009–2020*. IHS Emerging Energy Research (EER), Cambridge, MA, USA and Barcelona, Spain.
- Ingram, E. A., 2009:** Pumped storage – development activity snapshots. *Hydro Review Worldwide* 17(6): 13–25.
- International Journal of Hydropower and Dams, Annual Directory 2004**, *Aqua-Media International*, Surrey, UK.
- International Journal of Hydropower and Dams, Annual Directory 2005**, *Aqua-Media International*, Surrey, UK.
- International Journal of Hydropower and Dams, Annual Directory 2006**, *Aqua-Media International*, Surrey, UK.
- International Journal of Hydropower and Dams, Annual Directory 2007**, *Aqua-Media International*, Surrey, UK.
- International Journal of Hydropower and Dams, Annual Directory 2008**, *Aqua-Media International*, Surrey, UK.
- International Journal of Hydropower and Dams, Annual Directory 2009**, *Aqua-Media International*, Surrey, UK.
- IPCC, 2000:** *Special Report on Emission Scenarios*. Intergovernmental Panel on Climate Change (IPCC), Cambridge University Press, Cambridge, UK.
- IPCC, 2007a:** *Climate Change 2007: Mitigation of Climate Change, Contribution of Working Group III to the Fourth Assessment Report of the Intergovernmental Panel on Climate Change*. Intergovernmental Panel on Climate Change (IPCC), Cambridge University Press, Cambridge, UK.
- IPCC, 2007b:** *Fourth Assessment Report of the Intergovernmental Panel on Climate Change*. Intergovernmental Panel on Climate Change (IPCC), Cambridge University Press, Cambridge, UK.
- IPCC, 2007c:** *Climate Change 2007: The Physical Science Basis*. Contribution of Working Group I to the Fourth Assessment Report, Intergovernmental Panel on Climate Change (IPCC), Cambridge University Press, Cambridge, UK.
- IPCC, 2011:** *Special Report on Renewable Energy Sources and Climate Change Mitigation*. O. Edenhofer et al. (eds.), Intergovernmental Panel on Climate Change (IPCC), Cambridge University Press, Cambridge, UK, and New York, NY, USA.
- ISEO, 2010:** *Environmental Benefits of Heat Pumps*. International Sustainable Energy Organisation for Renewable Energy and Energy Efficiency (ISEO), Geneva.
- IT Power Ltd., 1996:** *The exploitation of Tidal and Marine Currents*. Tecnomare SpA, Report EUR 16683 EN, Office for Official Publications of the European Communities, Luxembourg.
- Jacobsson, S., A. Bergek, D. Finon, V. Lauber, C. Mitchell, D. Toke, and A. Verbruggen, 2009:** EU Renewable Energy Support Policy: Faith or Facts? *Energy Policy* 37(6): 2143–2146.
- Jäger-Waldau, A., 2010:** *PV Status Report 2010*. Office for Official Publications of the European Communities, Luxembourg.
- Jeffries, T. W., 2006:** Engineering yeasts for xylose metabolism. *Current Opinion in Biotechnology* 17(3): 320–326.
- Johansson, T. B., K. McCormick, L. Neij, and W. C. Turkenburg, 2006:** The potentials of Renewable Energy. In *Renewable Energy: A Global Review of Technologies, Policies and Markets*. D. Assmann et al. (eds.), Earthscan, London, pp.15–47.
- Johansson, T. B., and W. C. Turkenburg, 2004:** Policies for renewable energy in the European Union and its member states: An overview. *Energy for Sustainable Development* 8(1): 5–24.
- Jónsson, T., P. Pinson, and H. Madsen, 2010:** On the market power of wind energy forecasts. *Energy Economics* 32(2): 313–320.
- Junginger, M., A. Faaij, R. Björheden, and W. C. Turkenburg, 2005:** Technological learning and cost reductions in wood fuel supply chains in Sweden. *Biomass and Bioenergy* 29(6): 399–418.
- Junginger, M., E. de Visser, K. Hjort-Gregersen, J. Koornneef, R. Raven, A. Faaij, and W. Turkenburg, 2006:** Technological learning in bioenergy systems. *Energy Policy* 34(18): 4024–4041.
- Junginger, M., W. van Sark, and A. Faaij (eds.), 2010:** *Technological Learning in the Energy Sector – Lessons for Policy, Industry and Science*, Edward Edgar, Cheltenham, UK.
- Junginger, M., J. van Dam, S. Zarrilli, F. A. Mohammed, D. Marchal, and A. Faaij, 2011:** Opportunities and barriers for international bioenergy trade. *Energy Policy*, 39(4): 2028–2042.
- Jursa, R. and K. Rohrig, 2008:** Short-term wind power forecasting using evolutionary algorithms for the automated specification of artificial intelligence models. *International Journal of Forecasting* 24(4): 694–709.
- Justice, S., 2009:** *Private Financing of Renewable Energy: A Guide for Policymakers*. Chatham House, UN Environment Programme, and Bloomberg New Energy Finance. London, UK.
- Kagel, A., 2006:** *A Handbook on the Externalities, Employment and Economics of Geothermal Energy*. Geothermal Energy Association, Washington, DC.
- Kaltschmitt, M., 2000:** Environmental effects of heat provision from geothermal energy in comparison to other resources of energy. In *Proceedings of World Geothermal Congress 2000*, 28 May–10 June, Kyushu-Tohoku, Japan, pp.803–808.

- Kamm, B., P. R. Gruber, and M. Kamm, 2006:** *Biorefineries – Industrial Processes and Products: Status Quo and Future Directions*, Volumes 1 and 2. WILEY-VCH, Weinheim, Germany.
- Kammen, D., K. Kapadia, and M. Fripp, 2006:** *Putting Renewables to Work: How Many Jobs Can the Clean Energy Industry Generate?* Renewable and Appropriate Energy Laboratory, University of California, Berkeley, April 2004 (corrected January 2006).
- Karakezi, S., K. Lata, and S. T. Coelho, 2004:** *Traditional Biomass Energy: Improving its Use and Moving to Modern Energy Use*. Thematic background paper for International Conference for Renewable Energies, Bonn, Germany.
- Karnoe, P., 1993:** *Approaches to Innovation in Modern Wind Energy Technology: Technology Practices, Science, Engineers and Craft Traditions*, Centre for Economic Policy Research, Stanford, CA, USA.
- Kazmerski, L., 2010:** *Compilation of Best Research Solar Cell Efficiencies (Revision Sept. 2010)*. National Renewable Energy Laboratory, Golden, CO, USA.
- Kazmerski, L., 2011:** *Best Research Solar Cell Efficiencies, 1976–2011*, compiled by L. L. Kazmerski, National Renewable Energy Laboratory, Golden, CO, USA.
- Kempton, W., and J. Tomić, 2005a:** Vehicle-to-grid power fundamentals: Calculating capacity and net revenue. *Journal of Power Sources* **144**: 268–279.
- Kempton, W., and J. Tomić, 2005b:** Vehicle-to-grid power implementation: From stabilizing the grid to supporting large-scale renewable energy. *Journal of Power Sources* **144**: 280–294.
- Kerr, D., 2007:** Marine Energy. *Phil. Trans. R. Soc. A* **365**: 971–992.
- Khan, J., and G. S. Bhuyan, 2009:** *Ocean Energy: Global Technology Development Status*, Report prepared by Powertech Labs for the IEA-OES.
- Kim, L., 1991:** Pros and cons of international technology transfer: A developing country view. In *Technology Transfer in International Business*. Oxford University Press, New York, NY, USA.
- Kim, L., 1997:** *Imitation to Innovation: The Dynamics of Korea's Technological Learning*. Harvard Business School Press, Boston, MA, USA.
- Kleimaier, M., U. Buenger, F. Crotochino, C. Gatzen, W. Glaunsinger, S. Huebner, M. Koenemund, H. Landinger, T. Lebioda, W. Leonhard, D. U. Sauer, H. Weber, A. Wenzel, E. Wolf, W. Woyke, and S. Zunft, 2008:** *Energy storage for improved operation of future energy supply systems*. Paper presented at CIGRE 42nd Biennial Session, Paris, France, 24–28 August.
- Klessmann, C., P. Lamers, M. Ragwitz, and G. Resch, 2010:** Design options for cooperation mechanisms under the new European renewable energy directive. *Energy Policy* **38**(8): 4679–4691.
- Klimstra, J., and M. Hotakainen, 2011:** *Smart Power Generation – The Future of Electricity Production*. Avain Publishers, Helsinki, Finland.
- Kok, M., W. Vermeulen, A. Faaij, and D. de Jager (eds.), 2002:** *Global Warming and Social Innovation*. Earthscan, London, UK.
- Komoto, K., M. Ito, P. van der Vleuten, D. Faiman, and K. Kurokawa (eds.), 2009:** *Energy from the Desert: Very Large Scale Photovoltaic Systems – Socio-economic, Financial, Technical and Environmental Aspects*. Earthscan, London, UK.
- Kosowski, G. M., M. Onischak, and S. P. Babu, 1984:** Development of biomass gasification to produce substitute fuels. In *Proceedings of the 16th Biomass Thermochemical Conversion Contractors' Meeting*, 8–9 May, Pacific Northwest Laboratory, Richland, WA, USA, pp.39–59.
- Kramer, G. J. and M. Haigh, 2009:** No quick switch to low-carbon energy, *Nature* **462**: 568–569.
- Kreutz, T. G., 2011:** Prospects for producing low carbon transportation fuels from captured CO₂ in a climate constrained world. In *Proceedings of the 10th International Greenhouse Gas Control Technologies Conference (GHGT-10)*, September, Amsterdam, Netherlands.
- Krewitt, W., K. Nienhaus, C. Klessmann, C. Capone, E. Sticker, W. Graus, M. Hoogwijk, N. Supersberger, U. Von Winterfeld, and S. Samadi, 2009a:** *Roles and Potential of Renewable Energy and Energy Efficiency for Global Energy Supply*. Federal Environment Agency (Umweltbundesamt), Germany.
- Krewitt, W., S. Teske, S. Simon, T. Pregger, W. Graus, E. Blomen, S. Schmid, and O. Schäfer, 2009b:** Energy [r]evolution 2008 – A sustainable world energy perspective. *Energy Policy* **37**: 5764–5775.
- Kreycik, C., T. D. Couture, K. S. Cory, 2011:** Innovative Feed-In Tariff Designs that Limit Policy Costs, NREL Report No. TP-6A20–50225, 48 pp.
- Kumar, A., T. Schei, A. Ahenkorah, R. Caceres Rodriguez, J.-M. Devernay, M. Freitas, D. Hall, Å. Killingtveit, Z. Liu, 2011:** Hydropower. In *IPCC Special Report on Renewable Energy Sources and Climate Change Mitigation*, O. Edenhofer et al. (eds.), Cambridge University Press, Cambridge, UK, and New York, NY, USA.
- Kurkela, E., 2008:** *Biomass gasification technologies for advanced power systems and synfuels: Status and present R&D activities at VTT*. National Flame Days, Tampere, Finland, 23 January.
- Kutscher, C. F. (ed.), 2007:** *Tackling Climate Change in the U.S.—Potential Carbon Emission Reductions from Energy Efficiency and Renewable Energy by 2030*. American Solar Energy Society, Boulder, CO, USA.
- Kutscher, C., 2009:** *Concentrating Solar Power Commercial Application Study: Reducing Water Consumption of Concentrating Solar Power Electricity Generation*, Report to Congress, US Department of Energy, Washington, DC.
- Lardon, L., A. Helia, B. Sialve, J.-P. Steyer, and O. Bernard, 2009:** Life-cycle assessment of biodiesel production from microalgae. *Environmental Science and Technology* **43**(17): 6475–6481.
- Larson, E. D., R. H. Williams, and M. R. L. V. Leal, 2001:** A review of biomass integrated-gasifier/gas turbine combined cycle technology and its application in sugarcane industries, with an analysis for Cuba. *Energy for Sustainable Development* **5**(1): 54–76.
- Larson, E. D., G. Fiorese, G. Liu, R. H. Williams, T. G. Kreutz, and S. Consonni, 2010:** Co-production of decarbonized synfuels and electricity from coal and biomass with CO₂ capture and storage: An Illinois case study. *Energy and Environmental Science* **3**(1): 28–42.
- Lau, F. S., D. A. Bowen, R. Dihu, S. Doong, E. E. Hughes, R. Remick, R. Slimane, S. Q. Turn, and R. Zabransky, 2003:** *Techno-economic Analysis of Hydrogen Production by Gasification of Biomass*. Final technical report for the period 15 September 2001–14 September 2002, US Department of Energy, Gas Technology Institute, Des Plaines, IL, USA.
- Lau, F., 2005:** *Integrated gasification combined cycles and other advanced concepts for biomass power generation*. 2nd Annual California Biomass Collaborative Forum, Sacramento, California, USA, 1 March.
- Lazard, 2009:** *Levelized Cost of Energy Analysis – Version 3.0 (February 2009)*. Lazard, New York, NY, USA.
- Leaman, K. D., R. Molinari, and P. S. Vertes, 1987:** Structure and Variability of the Florida Current at 27°N. *Journal of Physical Oceanography* **17**(5): 565–583.
- Ledru, P., D. Bruhn, P. Calcagno, A. Genter, E. Huenges, M. Kaltschmitt, C. Karytsas, T. Kohl, L. Le Bel, A. Lokhorst, A. Manzella, and S. Thorhalsson,**

- 2007: Enhanced geothermal innovative network for Europe: The state-of-the-art. *Geothermal Resources Council Bulletin*.
- Lee, S. K., H. Chou, T. S. Ham, T. S. Lee, and J. D. Keasling, 2008:** Metabolic engineering of microorganisms for biofuels production: from bugs to synthetic biology to fuels. *Current Opinion in Biotechnology* **19**: 556–563.
- Lehmann, H., and S. Peter, 2003:** *Assessment of Roof & Façade Potentials for Solar Use in Europe*. Institute for Sustainable Solutions and Innovations, Aachen, Germany.
- Lemming J. K., P. E. Morthorst, N. E. Clausen, and P. Hjuler Jensen, 2009:** *Contribution to the Chapter on Wind Power in Energy Technology Perspectives 2008*, IEA. Risø National Laboratory, Roskilde, Denmark.
- Leonard, W., U. Buenger, F. Crotagino, C. Gatzen, W. Glaunsinger, S. Huebner, M. Kleimaier, M. Koenemund, H. Landinger, T. Lebioda, D. U. Sauer, H. Weber, A. Wenzel, W. Wolf, W. Woyke, and S. Zunft, 2008:** *Energy Storage in Power Supply Systems with a High Share of Renewable Energy Sources, Significance, State of the Art, Need for Action*. ETG Energy Storage Task Force, VDE Association for Electrical, Electronic, and Information Technologies, Frankfurt am Main, Germany.
- Li, J., 2010:** Decarbonizing power generation in China – is the answer blowing in the wind? *Renewable and Sustainable Energy Reviews* **14**: 1154–1171.
- Li, J., and L. Ma, 2009:** *Background Paper: Chinese Renewables Status Report*. REN21, Paris, France.
- Liu, G., E. D. Larson, R. H. Williams, T. G. Kreutz, and X. Guo, 2011:** Making Fischer-Tropsch fuels and electricity from coal and biomass: Performance and cost analysis. *Energy & Fuels* **25**(1): 415–437.
- Lorenz, E., J. Hurka, D. Heinemann, and H.-G. Beyer, 2009:** Irradiance Forecasting for the Power Prediction of Grid-Connected Photovoltaic Systems. *IEEE Journal of Selected Topics in Applied Earth Observations and Remote Sensing* **2**: 2–10.
- Lorenz, E., J. Hurka, D. Heinemann, and H.-G. Beyer, 2009:** *Los Angeles Times*, 2009: China, green? In the case of solar water heating, yes. 6 September.
- Lucas Porta, H., 2009:** *International Feed-in Cooperation – Mitigation through Renewable*, IDAE, Spain, presented at Side Event, Conference of the Parties, Copenhagen, Denmark.
- Lund, H., and W. Clark, 2008:** Sustainable energy and transportation systems introduction and overview. *Utilities Policy* **16**(2): 59–62.
- Lund, H., and W. Kempton, 2008:** Integration of renewable energy into the transport and electricity sectors through V2G. *Energy Policy* **36**: 3578–3587.
- Lund, J. W., 2007:** Characteristics, Development and Utilization of Geothermal Resources. *GHC Bulletin*, Geo-Heat Center, Oregon Institute of Technology, June 2007.
- Lund, J. W. (ed.), 2005:** Hitaveita Reykjavikur and the Nesjavellir geothermal co-generation power plant. *Quarterly Bulletin* **26**(3): 19–24.
- Lund, J. W. and T. Boyd, 2009:** Oregon Institute of Technology geothermal uses and projects – Past, present and future. In *Proceedings of the Thirty-Fourth Workshop on Geothermal Reservoir Engineering*, 9–11 February, Stanford University, Stanford, CA, USA.
- Lund, J. W., B. Sanner, L. Rybach, R. Curtis, and G. Hellström, 2003:** Ground-source heat pumps – A world overview. *Renewable Energy World* **6**(4): 218–227.
- Lund, J. W., D. H. Freeston, and T. L. Boyd, 2010:** Direct utilization of geothermal energy 2010 worldwide review. In *Proceedings of World Geothermal Congress 2010*, 25–30 April, Bali, Indonesia.
- Lund, J. W., and R. Bertani, 2010:** Worldwide Geothermal Utilization 2010, In *Proceedings of the Geothermal Resources Council Annual Meeting*, Davis, CA, USA (CD-ROM).
- Luque, A., and S. Hegedus, 2003:** *Handbook of Photovoltaic Science and Engineering*. John Wiley & Sons, Ltd., Chichester, UK.
- Macedo, I. C., J. E. A. Seabra, and E. A. R. Silva, 2008:** Greenhouse gases emissions in the production and use of ethanol from sugarcane in Brazil: The 2005/2006 averages and a prediction for 2020. *Biomass and Bioenergy* **32**(7): 582–595.
- Mackensen, R., K. Rohrig, and H. Emanuel, 2008:** *Das regenerative Kombikraftwerk*. Abschlussbericht. ISET Kassel, Schmack Biogas AG.
- Madaeni, S., R. Sioshansi, and P. Denholm, 2011:** How thermal energy storage enhances the economic viability of concentrating solar power, submitted to *Proceedings of the IEEE*.
- Makai Ocean Engineering, 2010:** *SWAC – SeaWater Air Conditioning*, www.makai.com/e-swac.htm (accessed 7 November 2010).
- Mangold, D., and T. Schmidt, 2006:** The new central solar heating plants with seasonal storage in Germany, In *Proceedings of Eurosun 2006*, June 27–30, Glasgow, UK.
- Mangold, D., 2007:** Seasonal storage – A German success story. *Sun & Wind Energy* **1**(2007): 48–58.
- Matsuoka, S., J. Ferro, and P. Arruda, 2009:** The Brazilian experience of sugarcane ethanol industry. *In Vitro Cellular & Developmental Biology – Plant* **45**: 372–381.
- McCall, M. J., A. Anumakonda, A. Bhattacharyya, and J. Kocal, 2008:** Feed-flexible processing of oil-rich crops to jet fuel. In *2008 AIChE Spring National Meeting*, New Orleans, LA, USA, 6–10 April.
- Medrano, M., A. Gil, I. Martorell, X. Potau, and L. F. Cabeza, 2010:** State of the art on high-temperature thermal energy storage for power generation. Part 2 – Case studies. *Renewable and Sustainable Energy Reviews* **14**: 56–72.
- Mehos, M., D. Kabel, and P. Smithers, 2009:** Planting the seed – Greening the grid with concentrating solar power. *IEEE Power & Energy* **7**(3): 55–62.
- Meier, A., and A. Steinfeld, 2010:** Solar thermal production of fuels. *Advances in Science and Technology* **74**: 303–312.
- Meiwes, H., 2009:** Technical and Economic Assessment of Storage Technologies for Power-Supply Grids, *Acta Polytechnica* **49**(2–3): 34–30.
- Microgrids, 2011:** The EU projects ‘Microgrids’ and ‘More Microgrids,’ European Research Project Cluster “Integration of RES + DG.” Brussels, Belgium. www.microgrids.eu (accessed 8 May 2010).
- Milborrow, D., 2010:** Annual power cost comparison: what a difference a year can make. *Windpower Monthly* **26**: 41–47.
- Minerals Management Service, 2007:** *Worldwide Synthesis and Analysis of Existing Information Regarding Environmental Effects of Alternative Energy on the Outer Continental Shelf*. US Department of the Interior, Report MMS 2007–038. www.mms.gov/offshore/AlternativeEnergy/Studies.htm (accessed 8 November 2010).
- Mitchell, C., 2008:** *The Political Economy of Sustainable Energy*. Palgrave MacMillan, Basingstoke, UK.
- Mitchell, C., D. Bauknecht, and P. M. Connor, 2006:** Effectiveness through risk reduction: A comparison of the renewable obligation in England and Wales and the feed-in system in Germany, *Energy Policy* **34**(3): 297–305.
- Mitchell, C., J. Sawin, G.R. Pokharel, D. Kammen, Z. Wang, S. Fifita, M. Jaccard, O. Langniss, H. Lucas, A. Nadai, R. Trujillo Blanco, E. Usher, A. Verbruggen, R. Wüstenhagen, and K. Yamaguchi, 2011:** Policy, Financing and Implementation. In *IPCC Special Report on Renewable Energy Sources and Climate Change Mitigation*, O. Edenhofer et al. (eds.), Cambridge University Press, Cambridge, UK, and New York, NY, USA.

- Modi, V., S. McDade, D. Lallement, and J. Saghir, 2006:** *Energy and the Millennium Development Goals*. Energy Sector Management Assistance Programme, United Nations Development Programme, UN Millennium Project, and World Bank, New York, NY, USA.
- Moore, B., and R. Wüstenhagen, 2004:** Innovative and sustainable energy technologies: The role of venture capital. *Business Strategy and the Environment* 13: 235–245.
- Mørk, G., S. Barstow, A. Kabuth, and M.T. Pontes, 2010:** Assessing the global wave energy potential. In *Proceedings of the OMAE-2010*, 6–11 June 2010, Shanghai, China.
- Morthorst, P. E. (ed.), 2007:** Detailed Investigation of Electricity Market Rules. In *Further Developing Europe's Power Market for Large Scale Integration of Wind Power*. Tradewind Project, Intelligent Energy-Europe, Brussels, Belgium.
- Mott MacDonald, 2010:** *U.K. Electricity Generation Costs Update*. Commissioned by the U.K. Department of Energy and Climate Change, London, UK.
- Musial, W. and B. Ram, 2010:** *Large-Scale Offshore Wind Power in the United States – Assessment of Opportunities and Barriers*. National Renewable Energy Laboratory, Golden, CO, USA.
- Mytelka, L. and P. Teixeira de Sousa, Jr., forthcoming:** Ethanol in Brazil. In *Energy Technology Innovation: Learning from Success and Failure: 20 Case Studies of Energy Technology Innovation*. A. Grubler and C. Wilson (eds.), Cambridge University Press, Forthcoming.
- NAS, 2009:** *Liquid Transportation Fuels from Coal and Biomass: Technological Status, Costs, and Environmental Impacts*. America's Energy Future Panel on Alternative Liquid Transportation Fuels, National Academy of Sciences (NAS), Washington, DC, USA.
- NEAA, 2009:** *Meeting the 2 °C Target – From Climate Objective to Emission Reduction Measures*. Netherlands Environmental Assessment Agency (NEAA), Bilthoven, Netherlands.
- NEDO, 2009:** *Outline of the Roadmap PV2030+*. New Energy and Industrial Technology Development Organization (NEDO), Tokyo, Japan.
- Neij, L., 2008:** Cost development of future technologies for power generation – A study based on experience curves and complementary bottom-up assessments. *Energy Policy* 36(6): 2200–2211.
- NERC, 2008:** *Accommodating High Levels of Variable Generation*. North American Electric Reliability Corporation (NERC), Princeton, NJ, USA.
- Nielson, P., J. K. Lemming, P. E. Morthorst, H. Lawetz, E. A. James-Smith, N. E. Clausen, S. Strøm, J. Larsen, N. C. Bang, and H. H. Lindboe, 2010:** *The Economics of Wind Turbines*. EMD International, Aalborg, Denmark.
- Nihous, G. C., 2007:** A Preliminary Assessment of Ocean Thermal Energy Conversion Resources. *Journal of Energy Resources Technology* 129: 10–17.
- Nikolaisen, L., C. Nielsen, M. G. Larsen, V. Nielsen, U. Zielke, J. K. Kristensen, and B. Holm-Christensen, 1998:** *Straw for Energy Production*. Centre for Biomass Technology, Soeborg, Denmark.
- Norden, 2006:** *Underground Cold Storage in Buildings Can Save Energy*. Nordic Energy Research (Norden), Oslo, Norway.
- Nordmann, T. and L. Clavadetscher, 2008:** Reliability of grid-connected photovoltaic systems – the learning curve in yield and system cost. In *Proceedings of 23rd EU PV Solar Energy Conference*, Valencia, Spain, pp.3217–3221.
- Norman, R. S., 1976:** Water Salination – Source of Energy. *Science* 186(4161): 350–352.
- NRC, 2007:** *Environmental Assessment of Wind-Energy Projects*. National Research Council (NRC), National Academy Press, Washington, DC.
- NWCC, 2006:** *Issue Forum Brief: Wind Power and Radar*. National Wind Coordinating Collaborative (NWCC), Washington, DC, USA.
- Ockwell, D. G., J. Watson, G. MacKerron, P. Pal, and F. Yamin, 2008:** Key policy considerations for facilitating low carbon technology transfer to developing countries. *Energy Policy* 36(11): 4104–4155.
- Owens, B., 2002:** *An Economic Evaluation of a Geothermal Production Tax Credit*. Technical Report, National Renewable Energy Laboratory, Golden, CO, USA.
- Pattle, R. E., 1954:** Production of Electric Power by Mixing Fresh and Salt Water in the Hydroelectric Pile. *Nature* 174(4431): 660.
- Pehnt, M., 2006:** Dynamic life-cycle assessment (LCA) of renewable energy technologies. *Renewable Energy* 31: 55–71.
- Pepermans, G., J. Driesen, D. Haeseldonckx, R. Belmans, and W. D'haeseleer, 2005:** Distributed generation: definition, benefits and issues. *Energy Policy* 33: 787–798.
- Perlin, J., 1999:** *From Space to Earth: The Story of Solar Electricity*. Aatec publications, Ann Arbor, MI, USA.
- Pfeifer, C., and H. Hofbauer, 2008:** Development of catalytic tar decomposition downstream from a dual fluidized bed biomass steam gasifier. *Powder Technology* 180(1–2): 9–16.
- Pienkos, P. T., 2009:** Algal biofuels: Ponds and promises. In *13th Annual Symposium on Industrial and Fermentation Microbiology*, Lacrosse, WI, USA, 1 May.
- Pimentel, D. and T. Patzek, 2005:** Ethanol Production Using Corn, Switchgrass, and Wood; Biodiesel Production Using Soybean and Sunflower. *Natural Resources Research* 14(1): 65–76.
- Piwko, R., D. Clark, L. Freeman, G. Jordan, and N. Miller, 2010:** *Western Wind and Solar Integration Study: Executive Summary*. National Renewable Energy Laboratory, Golden, CO, USA.
- Post, J. W., 2009:** *Blue Energy – Electricity Production from Salinity Gradients by Reverse Electro Dialysis*. PhD Thesis, Wageningen University, Netherlands.
- Pradhan, A., D. S. Shrestha, A. McAloon, W. Yee, M. Haas, J. A. Duffield, and H. Shapouri, 2009:** *Energy Lifecycle Assessment of Soybean Biodiesel*. Agricultural Economics Report 845, U.S. Department of Agriculture, Washington, DC, USA.
- Pregger, T., D. Graf, W. Krewitt, C. Sattler, M. Roeb, and S. Moller, 2009:** Prospects of solar thermal hydrogen production processes. *International Journal of Hydrogen Energy* 34(10): 4256–4267.
- Putsche, V., 1999:** *Complete Process and Economic Model of Syngas Fermentation to Ethanol*. C Milestone Completion Report, National Renewable Energy Laboratory, Golden, CO, USA.
- PV Cycle, undated:** *Making Photovoltaics "Double Green."* www.pvcycle.org/index.php?id=4 (accessed 9 April 2011).
- Rafferty, K., 2008:** *An Information Survival Kit for the Prospective Geothermal Heat Pump Owner*. HeatSpring Energy, Cambridge, MA.
- Ragnarsson, A., 2010:** Geothermal development in Iceland 2005–2009. In *Proceedings of World Geothermal Congress 2010*, 25–30 April, Bali, Indonesia.
- Raugei M., and V. M. Fthenakis, 2010:** Cadmium flows and emissions from CdTe PV: Future expectations. *Energy Policy* 38: 5223–5228.
- Raventós, A., T. Simas, A. Moura, G. Harrison, C. Thomson, J.-D. Dhedin, 2010:** *Life Cycle Assessment for Marine Renewables*. Wave Energy Centre, The University of Edinburgh, UK and European Development Fund (EDF), Commission of the European Communities, Brussels, Belgium.

- Rawson, M., 2004:** *Distributed Generation Costs and Benefits Issue Paper*. Staff paper 500–04–048. Public Interest Energy Research, California Energy Commission, Sacramento, CA, USA.
- Ray, R. W., 2009:** A review of the hot hydro market in Latin America. *Hydro Review Worldwide* 17(6): 26.
- Reich, N. H., E. A. Alsema, W. G. J. H. M. van Sark, and W. C. Turkenburg, 2011:** Greenhouse gas emissions associated with photovoltaic electricity from crystalline silicon modules under various energy supply options. *Progress in Photovoltaics: Research Applications* 19(3): 603–613.
- Reif, T., 2008:** *Economic Aspects of Geothermal District Heating and Power Generation. German Experience Transferable?* Presented at Innovaatilised Lahendusud Energeetikas: Maasoojusenergia at Tallinn University of Technology, Tallinn, Estonia, 17 April 2009.
- REN21, 2005:** *Renewables Global Status Report – 2005*. Paris, France.
- REN21, 2007:** *Renewable Energy and the Climate Change Regime – Considerations from REN21 ahead of Bali COP13*. REN21 Secretariat, Paris, France.
- REN21, 2008:** *Renewables 2007 Global Status Report*. REN21 Secretariat and Worldwatch Institute. Paris, France and Washington, DC, USA.
- REN21, 2009:** *Renewables Global Status Report – 2009 Update*. REN21 Secretariat, Paris, France.
- REN21, 2010:** *Renewables 2010 – Global Status Report*. REN21 Secretariat, Paris, France.
- REN21, 2011:** *Renewables 2011 – Global Status Report*. REN21 Secretariat, Paris, France.
- RFA, undated:** *Ethanol Industry Statistics*. U.S. Renewable Fuel Association (RFA). www.ethanolrfa.org/pages/statistics (accessed 13 June 2010).
- Rohrig, K., and B. Lange, 2008:** Improving security of power system operation applying DG production forecasting tools. *IEEE PES General Meeting 2008*, Pittsburgh, PA, USA.
- Rybach, L., 2010:** Legal and regulatory environment favourable for geothermal development investors. In *Proceedings of the World Geothermal Congress 2010*, Bali, Indonesia, 25–30 April 2010.
- Rybach, L., and M. Mongillo, 2006:** Geothermal sustainability – A review with identified research needs. *Geothermal Resources Council Transactions*, 30: 1083–1090.
- Salo, K., 2009:** *Applications of bubbling fluidized bed gasification*. Centro de Investigaciones Energéticas Medioambientales y Tecnológicas (CIEMAT), Madrid, Spain, 12–13 November.
- Salter, S. K. MacGregor, and C. Jones, 2006:** *Scottish Energy Review – Scotland's Opportunity, Scotland's Challenge*, SNP, Scotland.
- Sargent & Lundy, LLC, 2009:** *Assessment of Parabolic Trough, Power Tower, and Dish Solar Technology Cost and Performance Forecast 2008*. Chicago, IL, USA.
- Sawin, J., 2004a:** *Mainstreaming Renewable Energy in the 21st Century*. Worldwatch Institute, Washington, DC, USA.
- Sawin, J., 2004b:** *National Policy Instruments – Policy Lessons for the Advancement & Diffusion of Renewable Energy Technologies Around the World*. Thematic Background Paper for Conference for Renewable Energies, Bonn, Germany.
- Schaeffer, G. J., E. Alsema, A. Seebregts, L. W. M. Beurskens, H. H. C. de Moor, W. G. J. H. M. van Sark, M. Durstewitz, M. Perrin, P. Boulanger, H. Laukamp, and C. Zuccaro, 2004:** *Learning from the Sun – Analysis of the Use of Experience Curves for Energy Policy Purposes: The Case of Photovoltaic Power. Final report of the Photex project*. ECN-C – 04–035, Energy Research Centre of the Netherlands, Petten, Netherlands.
- Scheepers, M., D. Bauknecht, J. Jansen, J. de Joode, T. Gómez, D. Pudjianto, S. Ropenus, and G. Strbac, 2007:** *Regulatory Improvements for Effective Integration of Distributed Generation into Electricity Distribution Networks – Summary of the DG-GRID project results*. Energy Research Centre of the Netherlands, Petten, Netherlands.
- Schneider, M., A. Holzer, and V.H. Hoffmann, 2008:** Understanding the CDM's contribution to technology transfer. *Energy Policy* 36(8): 2920–2928.
- Scråmesto O.S., S.E. Skilhagen, and W.K. Nielsen, 2009:** Power production based on Osmotic Pressure, *Waterpower* 16 (July): 10pp.
- SEIA, 2011:** *Utility-Scale Solar Projects in the United States Operational, Under Construction, and Under Development – Updated February 8, 2011*. Solar Energy Industries Association (SEIA), Washington, DC, and Cambridge, MA.
- Seyboth, K., L. Beurskens, O. Langniss, and R. E. H. Sims, 2008:** Recognising the potential for renewable energy heating and cooling. *Energy Policy* 36(7): 2460–2463.
- Shapouri, H., J. A. Duffield, and M. Wang, 2002:** *The Energy Balance of Corn-Ethanol, An Update*. Agricultural Economic Report 813. Office of Energy Policy and New Uses, U.S. Department of Agriculture, Washington, DC, USA.
- Sharma, A., V. V. Tyagi, C. R. Chen, and D. Buddhi, 2009:** Review on Thermal Energy Storage with Phase Change Materials and Application. *Renewable and Sustainable Energy Reviews* 13: 318–345.
- Sheehan, J., T. Dunahay, J. Benemann, and P. Roessler, 1998a:** *A Look Back at the U.S. Department of Energy's Aquatic Species Program – Biodiesel from Algae*. National Renewable Energy Laboratory, Golden, CO, USA.
- Sheehan, J., V. Camobreco, J. Duffield, M. Graboski, and H. Shapouri, 1998b:** *Life Cycle Inventory of Biodiesel and Petroleum Diesel for Use in an Urban Bus*. National Renewable Energy Laboratory, Golden, CO, USA.
- Shell, 2008:** *Shell Energy Scenarios to 2050*. Shell International BV, The Hague, Netherlands.
- Shell, 2011:** *Signals and Signposts – Shell Energy Scenarios to 2050*. Shell International BV, The Hague, Netherlands.
- Sims, R. E. H., W. Mabee, J. N. Saddler, and M. Taylor, 2010:** An Overview of Second Generation Biofuel Technologies. *Bioresource Technology* 101: 1570–1580.
- Sims, R., P. Mercado, W. Krewitt, G. Bhuyan, D. Flynn, H. Holttinen, G. Jannuzzi, S. Khennas, Y. Liu, M. O'Malley, L. J. Nilsson, J. Ogden, K. Ogimoto, H. Outhred, Ø. Ulleberg, F. Van Hulle, 2011:** Integration of Renewable Energy into Present and Future Energy Systems. In *IPCC Special Report on Renewable Energy Sources and Climate Change Mitigation*, O. Edenhofer et al. (eds.), Cambridge University Press, Cambridge, UK and New York, NY, USA.
- Sinke, W. C., W. van Hooff, G. Coletti, B. Ehlen, G. Hahn, S. Reber, G. Beaucarne, J. John, E. van Kerschaver, M. de Wild-Scholten, and A. Metz, 2009:** Wafer-based crystalline silicon PV modules at 1 € per watt-peak: Final results from the CrystalClear Integrated Project. In *Proceedings of the 24th European PV Solar Energy Conference*, Hamburg, 21–25 September, pp.845–856.
- Sinke, W. C., 2009:** Design Guidelines – Basics of Photovoltaics. In *Photovoltaics in the Urban Environment*. B. Gaiddon, H. Kaan and D. Munro (eds.), Earthscan, London, UK.
- Sipila, K. and M. Rossi (eds.), 2002:** Power Production from Waste and Biomass IV: Advanced Concepts and Technologies. In *Proceedings of VTT Symposium 222*, Technical Research Center of Finland, Espoo, Finland.
- Smart Grids ETP, 2010:** *Strategic Deployment Document for Europe's Electricity Networks of the Future*. European Technology Platform for the Electricity

- Networks of the Future (ETP), Brussels, Belgium. www.smartgrids.eu (accessed 20 February 2011).
- Solar Cookers International, 2009:** <http://www.solarcookers.org> (accessed 21 January 2009 and 18 February 2011).
- Solomon, B. D., J. R. Barnes, and K. E. Halvorsen, 2007:** Grain and cellulosic ethanol: History, economics and energy policy. *Biomass and Bioenergy* **31**(6): 416–425.
- Sonntag-O'Brien, V. and E. Usher, 2004:** *Mobilising Finance for Renewable Energies*. Secretariat of the International Conference for Renewable Energies, Bonn, Germany.
- Sorensen, H. C., and A. Weinstein, 2008:** Ocean Energy – Position Paper for IPCC. In *Proceedings IPCC Scoping Conference on Renewable Energy*, Lübeck, Germany, 20–25 January, 8pp.
- Spath, P. L., and D. C. Dayton, 2003:** *Preliminary Screening Technical and Economic Assessment of Synthesis Gas to Fuels and Chemicals with Emphasis on the Potential for Biomass-derived Syngas*. National Renewable Energy Laboratory, Golden, CO, USA.
- St. Denis, G., and P. Parker, 2009:** Community energy planning in Canada: The role of renewable energy. *Renewable and Sustainable Energy Reviews* **13**(8): 2088–2095.
- State of Hawaii, 2010:** *Ocean Thermal Energy*. hawaii.gov/dbedt/info/energy/renewable/otec (accessed 15 January 2010).
- Stefansson, V., 2000:** The renewability of geothermal energy. In *Proceedings of the World Geothermal Congress 2000*, Kyushu-Tohoku, Japan, pp.883–888.
- Stefansson, V., 2005:** World geothermal assessment. In *Proceedings of the World Geothermal Congress 2005*, Antalya, Turkey, 24–29 April 2005.
- Stern, N., 2009:** *Meeting the Climate Challenge: Using Public Funds to Leverage Private Investment in Developing Countries*. Grantham Institute for Climate Change and the Environment, London School of Economics. London, UK.
- Sterner, M., 2009:** *Bioenergy and Renewable Power Methane in Integrated 100% Renewable Energy Systems*. Kassel University Press, Kassel, Germany.
- Stoddard, L., J. Abiecunas, and R. O'Connell, 2006:** *Economic, Energy, and Environmental Benefits of Concentrating Solar Power in California*. National Renewable Energy Laboratory, Golden, CO, USA.
- Strange, D. L. P., T. P. Tung, G. W. Mills, A. Bartle, K. Goldsmith, F. Jenkin, L. P. Mikhailov, and A. A. Zolotov, 1994:** Ocean Energy. In *New Renewable Energy Resources*. E. P. Volkov et al. (eds.), World Energy Council, Kogan Page Limited, London, UK, pp.321–358.
- Strom, E., L. Liinanki, K. Sjostrom, E. Rensfelt, L. Waldheim, and W. Blackadder, 1984:** Gasification of biomass in the MINO-process. *Bioenergy* **84**, Vol. III (*Biomass Conversion*), H. Egneus and A. Ellegard (eds.), Elsevier Applied Science Publishers, London, UK, pp.57–64.
- Suding, P. and P. Lempp, 2007:** The multifaceted institutional landscape and processes of international renewable energy policy. *IAEE Energy Forum, Second Quarter*: 4–9.
- Šuri, M., 2006:** Solar resource data and tools for an assessment of photovoltaic systems. In *PV Status Report 2006*. A. Jäger-Waldau (ed.), Office for Official Publications of the European Communities, Luxembourg.
- Swanson, R. M., 2006:** A vision for crystalline silicon photovoltaics. *Progress in Photovoltaics: Research Applications* **14**(5): 443–453.
- Swedish Energy Agency, 2008:** *Chrisgas: Fuels from Biomass*. Intermediate Project Report. www.chrisgas.com (accessed 18 May 2010).
- Sydskraft, Elforsk, and Nutek, 1998:** *Varnamo Demonstration Plant: Construction and Commissioning, 1991–1996*. Skogs Satterli AB, Trelleborg, Sweden.
- Sydskraft, Elforsk, and Nutek, 2001:** *Varnamo Demonstration Plant: The Demonstration Program, 1996–2000*. Berlings Skogs, Trelleborg, Sweden.
- Taylor, R. M., 2008:** The possible role and contribution of hydropower to the mitigation of climate change. *IPCC Scoping Meeting on Renewable Energy Sources Proceedings*, Lubeck, Germany, p.85.
- Taylor, R. M., 2010:** *Hydropower*. In *Survey of Energy Resources*. World Energy Council, London, UK, pp.287–290.
- Tester, J. W., E. M. Drake, M. J. Driscoll, M. W. Golay, and W. A. Peters, 2005:** *Sustainable Energy: Choosing Among Options*. The MIT Press, Cambridge, MA, USA.
- Tester, J., and Panel Members, 2006:** *The Future of Geothermal Energy – Impact of Enhanced Geothermal Systems (EGS) on the United States in the 21st Century*. Massachusetts Institute of Technology, Cambridge, MA, USA.
- Thresher, R., M. Robinson, and P. Veers, 2008a:** *Wind energy status and future wind engineering challenges*. National Renewable Energy Laboratory, Golden, CO, USA.
- Thresher, R., M. Robinson, and P. Veers, 2008b:** *Wind Energy Technology: Current Status and R&D Future*. National Renewable Energy Laboratory, Golden, CO, USA.
- Tomić, J. and W. Kempton, 2007:** Using fleets of electric-drive vehicles for grid support. *Journal of Power Sources* **168**: 459–468.
- TPWind, 2008:** *Strategic Research Agenda—Market Deployment Strategy from 2008 to 2030, Synopsis—Preliminary Discussion Document*, European Technology Platform for Wind Energy, TPWind Secretariat Brussels, Belgium.
- Trieb, F. and H. Müller-Steinhagen, 2007:** Europe-Middle East-North Africa cooperation for sustainable electricity and water. *Sustainability Science* **2**: 205–219.
- Trouille, B. and C. R. Head, 2008:** Introduction. *Hydro Finance Handbook*, HCI Publications, Kansas City, MO, USA, pp.3–4.
- Turchi, C., 2010:** *Parabolic Trough Reference Plant for Cost Modeling with the Solar Advisor Model (SAM)*, Technical Report. National Renewable Energy Laboratory, Golden, CO, USA.
- Turchi, C., N. Langle, R. Bedilion, and C. Libby, 2011:** *Solar-Augment Potential of U.S. Fossil-Fired Power Plants*, Technical Report. National Renewable Energy Laboratory, Golden, CO, USA.
- Turkenburg, W. C., 2002:** The innovation chain: Policies to promote energy innovations. In *Energy for Sustainable Development: A Policy Agenda*. T. B. Johansson and J. Goldemberg (eds.), UN Development Programme, New York, NY, USA, pp.137–172.
- Turkenburg, W. C., J. Beurskens, A. Faaij, P. Fraenkel, I. Fridleifsson, E. Lysen, D. Mills, J. R. Moreira, L. J. Nilsson, A. Schaap, and W. C. Sinke, 2000:** Renewable Energy Technologies. In *World Energy Assessment – Energy and the Challenge of Sustainability*. J. Goldemberg (ed.), UNDP and UN-DESA, New York, NY, USA, WEC, London, UK, pp.219–272.
- UK-DTI, 2004 :** *The World Offshore Renewable Energy Report 2004–2008*. UK Department of Trade and Industry (UK-DTI), London, UK.
- UKERC, 2008:** *UKERC Marine (Wave and Tidal Current) Renewable Energy Technology Roadmap*, UK Energy Research Centre (UKERC), London, UK and University of Edinburgh, Edinburgh, UK.
- UKERC, 2010:** *Great Expectations: The Costs of Offshore Wind in UK Wales – Understanding the Past and Projecting the Future*. UK Energy Research Centre (UKERC), London, UK.

- Ulleberg, Ø., T. Nakken, and A. Eté, 2010:** The wind/hydrogen demonstration system at Utsira in Norway: Evaluation of system performance using operational data and updated hydrogen energy system modeling tools. *International Journal of Hydrogen Energy* 35(5): 1841–1852.
- Ummels, B. C., E. Pelgrum, and W. L. Kling, 2008:** Integration of large-scale wind power and use of energy storage in the Netherlands. *IET Renewable Power Generation* 2(1): 34–46.
- UN, 2008:** *Acting on Climate Change: the UN System Delivering as One*. United Nations (UN), New York, NY, USA.
- UN, 2009:** *The Millennium Development Goals Report*. United Nations (UN), New York, NY, USA.
- UNCTAD, 2008:** *Biofuel Production Technologies: status, prospects and implications for trade and development*, prepared by E. D. Larson. United Nations Conference on Trade and Development (UNCTAD), Geneva, Switzerland.
- UNCTAD, 2010:** *World Investment Report*. United Nations Conference on Trade and Development (UNCTAD), Geneva, Switzerland.
- UNDP, UN-DESA, and WEC, 2000:** *World Energy Assessment – Energy and the Challenge of Sustainability*. United Nations Development Programme (UNDP) and United Nations Department of Economic and Social Affairs (UN-DESA), NY, New York, USA, and World Energy Council, London, UK.
- UNDP, UN-DESA, and WEC, 2004:** *World Energy Assessment – Energy and the Challenge of Sustainability: 2004 update*. United Nations Development Programme (UNDP) and United Nations Department of Economic and Social Affairs (UN-DESA), NY, New York, USA, and World Energy Council, London, UK.
- UNEP, 2008a:** *Public Finance Mechanisms to Mobilise Investment in Climate Change Mitigation*. United Nations Environment Programme (UNEP), Nairobi, Kenya.
- UNEP, 2008b:** *Green Jobs: Towards Decent Work in a Sustainable, Low-Carbon World*. United Nations Environment Programme (UNEP), Nairobi, Kenya.
- UNEP, 2009:** *Global Green New Deal – A Policy Brief*. United Nations Environment Programme (UNEP), Nairobi, Kenya.
- UNEP, Undated:** *Solar Water Heating Loan Facility in Tunisia and Indian Solar Loan Programme*. Energy Branch, Division of Technology, Industry, and Economics, United Nations Environment Programme (UNEP), Nairobi, Kenya. www.unep.fr/energy/activities/medrep/tunisia.htm and www.uneptie.org/energy/activities/islp (accessed 18 November 2010).
- UNEP and BNEF, 2010:** *Global Trends in Sustainable Energy Investment 2010: Analysis of Trends and Issues in the Financing of Renewable Energy and Energy Efficiency*. United Nations Environment Programme (UNEP), Nairobi, Kenya and Bloomberg New Energy Finance (BNEF), London, UK.
- UNEP and BNEF, 2011:** *Global Trends in Renewable Energy Investment 2011: Analysis of Trends and Issues in the Financing of Renewable Energy*. United Nations Environment Programme (UNEP), Nairobi, Kenya and Bloomberg New Energy Finance (BNEF), London, UK.
- UNEP Risø, 2008:** *Year end snapshot of the CDM*. CDM Pipeline. UNEP Risø Centre on Energy, Climate and Sustainable Development (URC), Roskilde, Denmark.
- UNEP Risø, 2011:** CDM/JI Pipeline Analysis and Database. UNEP Risø Centre on Energy, Climate and Sustainable Development (URC), Roskilde, Denmark. cdm-pipeline.org/ (accessed 4 March 2011).
- UNFCCC, 2007:** *Investment and Financial Flows Relevant to the Development of an Effective and Appropriate International Response to Climate Change*. United Nations Framework Convention on Climate Change (UNFCCC), Bonn, Germany.
- UNICA, undated:** *Quotes and Stats*. Brazilian Sugarcane Industry Association (UNICA), english.unica.com.br/dadosCotacao/estatistica (accessed 8 August 2009).
- University of Exeter and University of Sussex, undated:** *Welcome to Energy Security in a Multipolar World*. www.exeter.ac.uk/energysecurity (accessed 8 November 2010).
- US DOE, 2004:** *Annual Energy Review 2003*. US Department of Energy (US DOE), Washington, DC, USA.
- US DOE, 2007:** *The potential Benefits of Distributed Generation and Rate-released Issues That May Impede their Expansion*. US Department of Energy (US DOE), Washington, DC, USA.
- US DOE, 2008a:** *20% Wind Energy by 2030: Increasing Wind Energy's Contribution to the U.S. Electricity Supply*. US Department of Energy (US DOE), Washington, DC, USA.
- US DOE, 2008b:** *Solar Energy Technologies Program Multi-Year Program Plan 2008–2012*. US Department of Energy (US DOE), Washington, DC, USA.
- US DOE, 2009:** *Marine & Hydrokinetic Technologies*. Office of Energy Efficiency and Renewable Energy, US Department of Energy (US DOE), Washington, DC, USA.
- US DOE, 2010a:** *Renewable Energy Annual, 2008 Edition*. Energy Information Administration, US Department of Energy (US DOE), Washington, DC, USA.
- US DOE, 2010b:** *Renewable Energy Futures Study*. US Department of Energy (US DOE), Washington, DC, USA.
- US DOE, 2010c:** *Biofuels, Biopower, and Bioproducts: Integrated Biorefineries*. Office of Energy Efficiency and Renewable Energy, US Department of Energy (US DOE), Washington, DC, USA.
- US DOE, 2011a:** *A National Offshore Wind Strategy: Creating an Offshore Wind Energy Industry in the United States*. Office of Energy Efficiency and Renewable Energy, US Department of Energy (US DOE) and the Bureau of Ocean Energy Management, Regulation, and Enforcement, US Department of the Interior, Washington, DC, USA.
- US DOE, 2011b:** *SunShot Initiative*. US Department of Energy (US DOE), Washington, DC, USA.
- US DOE, 2011c:** *Metering and Rate Arrangements for Grid-Connected Systems*. US Department of Energy (US DOE), Washington, DC, USA. www.energysavers.gov/your_home/electricity/index.cfm/mytopic=10600 (accessed 14 May 2011).
- US EIA, 2011:** *International Energy Statistics*. US Energy Information Administration (US EIA). tonto.eia.doe.gov/cfapps/ipdbproject/IEDIndex3.cfm# (accessed 22 March 2011).
- Usher, E., 2008:** *Decarbonizing Energy: Are Financial Markets Taking the Lead? Cogeneration & On Site Power Production*. 1 July. www.cospp.com/articles/print/volume-9/issue-4/perspective/decarbonizing-energy-are-financial-markets-taking-the-lead.html (accessed 9 February 2010).
- Van den Ende, K., and F. Groeman, 2007:** *Blue Energy*. KEMA, Arnhem, Netherlands. www.leonardo-energy.org/drupal/book/export/html/2243 (accessed 19 February 2010).
- van den Wall Bake, J. D., M. Junginger, A. Faaij, T. Poot, and A. Walter, 2009:** Explaining the experience curve: Cost reductions of Brazilian ethanol from sugarcane. *Biomass and Bioenergy* 33: 644–658.
- van der Linden, N. C., M. A. Uyterlinde, C. Vrolijk, L. J. Nilsson, J. Khan, K. Åstrand, K. Erisson, and R. Wiser, 2005:** *Review of International Experience with Renewable Energy Obligation Support Mechanisms*. Energy Research Centre of the Netherlands, Petten, Netherlands.

- Van Hertem, D., and M. Ghandhari, 2010:** Multi-terminal VSC HVDC for the European supergrid: Obstacles. *Renewable and Sustainable Energy Reviews* 14(9): 3156–3163.
- Van Iersel, S., L. Gamba, A. Rossi, S. Alberici, B. Dehue, J. van de Staaij, and A. Flammini, 2009:** *Algae-Based Biofuels: A Review of Challenges and Opportunities for Developing Countries*. Food and Agriculture Organization (FAO), Rome, Italy.
- van Loo, S. and J. Koppjan (eds.), 2002:** *Handbook Biomass Combustion and Co-firing*. Twente University Press, Enschede, Netherlands.
- van Sark, W. G. J. H. M., E. A. Alsema, H. M. Junginger, H. H. C. de Moor, and G. J. Schaeffer, 2008:** Accuracy of progress ratios determined from experience curves: the case of crystalline silicon photovoltaic module technology development. *Progress in Photovoltaics: Research Applications* 16(5): 441–453.
- van Vliet, O. P. R., A. P. C. Faaij, and W. C. Turkenburg, 2009:** Fischer-Tropsch diesel production in a well-to-wheel perspective: A carbon, energy flow and cost analysis. *Energy Conversion and Management* 54(4): 855–876.
- van Wijk, A. J. M., and W. C. Turkenburg, 1992:** Costs avoided by the use of wind energy in the Netherlands. *Electric Power Systems Research* 23: 201–216.
- Van Wijk, A., 2010:** *Hoe kook ik een ei – een frisse kijk op duurzame energie voor iedereen*. MGMC, the Netherlands, pp.39–41.
- Vannoni, C., R. Battisti, and S. Drigo, 2008:** *Potential for Solar Heat in Industrial Processes*. Solar Heating & Cooling Programme, International Energy Agency, Paris, France.
- Vega, L. A., 2002:** Ocean Thermal Energy Conversion Primer. *Marine Technology Society Journal* 6(4): 25–35.
- Verbruggen, A., W. Moomaw, J. Nyboer, 2011:** Annex I: Glossary, Acronyms, Chemical Symbols and Prefixes. In: *IPCC Special Report on Renewable Energy Sources and Climate Change Mitigation*. O. Edenhofer et al. (eds.), Cambridge University Press, Cambridge, UK, and New York, NY, USA.
- Walker, A., D. Renne, S. Bilo, C. Kutscher, J. Burch, D. Balcomb, R. Judkoff, C. Warner, R.J. King, and P. Eiffert, 2003:** Advances in solar buildings. *Transactions of the ASME* 125: 236–244.
- Wang C. K., and W. Lu, 2009:** *Analysis Methods and Reserves Evaluation of Ocean Energy Resources*. Ocean Publication, Beijing, China.
- Watson, J., 2008:** *Setting Priorities in Energy Innovation Policy: Lessons for the UK*. Discussion paper 2008–08. Belfer Center for Science and International Affairs, Cambridge, MA, USA.
- WBGU, 2003:** *World in Transition – Towards Sustainable Energy Systems*. German Advisory Council on Global Change (WBGU), Earthscan, London, UK.
- WEC, 1994:** *New Renewable Energy Resources: A Guide to the Future*. World Energy Council (WEC), Kogan Page, London, UK.
- WEC, 2010:** *2010 Survey of Energy Resources*. World Energy Council (WEC), London, UK.
- Weiss, W. and F. Mauthner, 2010:** *Solar Heat Worldwide – Markets and Contribution to the Energy Supply 2008*, 2010 edition. Solar Heating & Cooling Programme, International Energy Agency (IEA-SHC), Paris, France.
- Western Governors' Association, 2006:** *Solar Task Force Report*. Clean and Diversified Energy Initiative, Washington, DC, USA.
- Weyer, K. M., D. R. Bush, A. Darzins, and B. D. Wilson, 2010:** Theoretical Maximum Algal Oil Production. *BioEnergy Research* 3: 204–213.
- Wiemken, E., 2009:** *Market Review and Analysis of Small and Medium Sized Solar Air Conditioning Applications: Survey of Available Technical Solutions and Successful Running Systems – Cross Country Analysis*. Fraunhofer ISE, Munich, Germany.
- Wildlife Society, 2007:** *Impacts of Wind Energy Facilities on Wildlife and Wildlife Habitat*, Technical Review 07–2. Bethesda, MD, USA.
- Williams, R. B., 2004:** *Technology Assessment for Biomass Power Generation*. Draft final report. Department of Biological and Agricultural Engineering, University of California, Davis, CA, USA.
- Willis, M., I. Masters, S. Thomas, R. Gallie, J. Loman, A. Cook, R. Ahmadian, R. Falconer, Binliang Lin, Guanghai Gao, M. Cross, N. Croft, A. Williams, M. Muhasilovic, I. Horsfall, R. Fidler, C. Wooldridge, I. Fryett, P. Evans, T. O'Doherty, D. O'Doherty, and A. Mason-Jones, 2010:** Tidal turbine deployment in the Bristol Channel: a case study. *Energy* 163(3): 93–105.
- WindPACT, 1999:** *The Wind Partnerships for Advanced Component Technology: Various Projects on Advanced Wind Technology*. www.nrel.gov/wind/advanced_technology.html (accessed 2 July 2010).
- WIREC, 2008:** *Conference Report 2008*. Washington International Renewable Energy Conference (WIREC), Washington, DC, USA.
- Wiser, R. and M. Bolinger, 2010:** *2009 Wind Technologies Market Report*. Energy Efficiency and Renewable Energy, US Department of Energy (US DOE), Washington, DC, USA.
- Wiser, R., Z. Yang, M. Hand, O. Hohmeyer, D. Infield, P.H.Jensen, V. Nikolaev, M. O'Malley, G. Sinden, and A. Zervos, 2011:** Wind Energy. In *IPCC Special Report on Renewable Energy Sources and Climate Change Mitigation*. O. Edenhofer et al. (eds.), Cambridge University Press, Cambridge, UK and New York, NY, USA.
- Wolsink, M., 2007:** Planning of renewables schemes: Deliberative and fair decision-making on landscape issues instead of reproachful accusations of non-cooperation. *Energy Policy* 35: 2692–2704.
- World Bank, 2009:** *State and Trends of the Carbon Market 2009*. Washington, DC, USA.
- World Bank, 2010:** *Annual Report 2010*. Washington, DC, USA.
- Worldwatch Institute, 2006:** *Biofuels for Transportation – Global Potential and Implications for Sustainable Agriculture and Energy in the 21st Century*. Washington, DC, USA.
- WorleyParsons Group, 2009:** *Dry Cooling Option: Addendum to CSP Parabolic Trough Plant Cost Assessment*. National Renewable Energy Laboratory, Golden, CO, USA.
- WWF and Ecofys, 2011:** *The Energy Report – 100% Renewables by 2050*. Gland, Switzerland.
- Zemke-White, L., and M. Ohno, 1999:** World seaweed utilisation: An end-of-century summary. *Journal of Applied Phycology* 11: 369–376.
- Zhang, Y-H. P., and L. R. Lynd, 2005:** Cellulose utilization by clostridium thermocellum: bioenergetics and hydrolysis product assimilation. *Proceedings of the National Academy of Sciences* 102(20): 7321–7325.