

Nonlinear PID-based analog neural network control for a two link rigid robot manipulator and determining the maximum load carrying capacity

Hadi Razmi, Atabak Mashhadi Kashtiban

Abstract— An adaptive controller of nonlinear PID-based analog neural networks is developed for the point to point and orientation-tracking control of a two link rigid robot manipulator. In each case, the maximum load carrying capacity of robot manipulator subject to accuracy and actuators constraints is obtained. In comparison with conventional PID method, the use of neural network controller can increase maximum load carrying capacity of robot manipulators. A superb mixture of a conventional PID controller and a neural network, which has powerful capability of continuously online learning, adaptation and tackling nonlinearity, brings us the novel nonlinear PID-based analog neural network controller. Computer simulations were carried out in two axes manipulator and the effectiveness of the proposed control algorithm was demonstrated through the experiments, which suggests its superior performance and increasing the maximum load carrying capacity of this manipulator.

Index Terms—Analog neural network, Adaptive control, Maximum load carrying capacity, Nonlinear PID control.

I. INTRODUCTION

Since the dynamics of robot manipulators are highly nonlinear and may contain uncertain elements such as friction, many efforts have been made in developing control schemes to achieve the precise tracking control of robot manipulators. Conventionally, many control techniques for robot manipulators rely on proportional-integral-derivative (PID)-type controllers in industrial operations due to their simple control structure, ease of design, and low cost [1]–[3]. However, robot manipulators have to face various uncertainties in practical applications, such as payload parameter, internal friction, and external disturbance [4]–[6]. All the uncertain or time-varying factors could affect the system control performance seriously. Many control techniques have been investigated as viable means to improve the shortcomings of the conventional PID-type controllers [7]–[10]. Sun and Mills [9] proposed an adaptive-learning control scheme to improve trajectory performance and could guarantee convergence in single and repetitive operational modes. But the control scheme requires the system dynamics

in detail. A model-based PID controller was presented by Li et al. [10] to achieve the time-varying tracking control of a robot manipulator. However, it is difficult to establish an appropriate mathematical model for the design of a model-based control system. Thus, the general claim of traditional intelligent control approaches is that they can attenuate the effects of structured parametric uncertainty and unstructured disturbance using their powerful learning ability without prior knowledge of the controlled plant in the design processes.

In the past decade, the applications of intelligent control techniques (fuzzy control or neural-network control) to the motion control for robot manipulators have received considerable attention [11]–[23]. A control system, which comprises PID control and neural network control, was presented by Chen et al. [11] for improving the control performance of the system in real time. Clifton et al. [12] and Misir et al. [17] designed fuzzy–PID controllers which were applied to the position control of robot manipulators. Huang and Lee [14] suggested a stable self-organizing fuzzy controller for robot motion control. This approach has a learning ability for responding to the time-varying characteristic of a robot manipulator. However, the fuzzy rule learning scheme has a latent stability problem. Yoo and Ham [19] presented two kinds of adaptive control schemes for robot manipulator via fuzzy compensator in order to confront the unpredictable uncertainties. Though the stability of the whole control system can be guaranteed, some strict constrained conditions and prior system knowledge are required in the control process. On the other hand, Kim and Lewis [15] dealt with the application of quadratic optimization for motion control of robotic systems using cerebellar model arithmetic computer neural networks. Lewis et al. [16] developed a multilayer neural-net controller for a general serial-link rigid robot to guarantee the tracking performance. Both system-tracking stability and error convergence can be guaranteed in these neural-based-control systems [15], [16]. However, the functional reconstructed error, the neural tuning weights and the high-order term in Taylor series are assumed to be known bounded functions, and some inherent properties of robot manipulator are required in the design process (e.g., skew-symmetry property, bounded system parameters and disturbances). Barambones and Etxebarria [20] proposed a neural scheme with adaptive switching gain. Here two different NN architectures are proposed to estimate the elements of the unknown nonlinear function and the elements of inertia matrix. Behera et al. [21]

Manuscript received February 18, 2012.

Hadi Razmi, Department of Engineering, East Tehran Branch, Islamic Azad University, Tehran, Iran, Tel.: (+98) 21- 33594950, (e-mail: razmi72180@yahoo.com).

Atabak Mashhadi Kashtiban, Department of Engineering, Khameneh Branch, Islamic Azad University, Tabriz, Iran, Tel.: (+98) 472- 2344151, (e-mail: akeshitban@gmail.com).

proposed a neuro adaptive hybrid controller for robot manipulator tracking control where three multilayer neural networks are used to learn the inertia matrix, Coriolis vector and the gravitational torque vector respectively. It however, suffers from computational complexity. Ertugrul and Kaynak [22] utilized two NNs to realize the objective of trajectory tracking based on sliding mode control methodology. The equivalent control and the switching control terms are the outputs of the two NNs. In [23], Wai presented a sliding mode neural network control system for position control of robotic manipulators.

For many industrial applications, current robotic manipulators with joint elasticity are relatively slow even when they are not fully loaded. Their speed, load carrying capacity and, hence, their productivity are limited by the deflection of the end-effector and the capability of their actuators. Increasing actuator size and power is largely self-defeating, because of increased cost and power consumption of the larger actuators as well as increased inertia of the actuators themselves. A more successful approach should maximize the load carrying capacity of the flexible manipulator, subject to the constraints imposed by actuator capacity and allowable end-effector deviation for a given dynamic trajectory. Thomas et al. [24] used the load capacity as a criterion for sizing the actuators at the design stage. In their work, piecewise rigid links and joints were assumed. If one removes the rigid body assumption, the Dynamic Load Carrying Capacity (DLCC) determined using the actuator constraint alone [25] would normally be too large. The DLCC for a two-link planar flexible arm is dealt with for only a single dynamic trajectory [26]. In [27], a new method for determining the DLCC for flexible joint manipulators, subject to both actuator and end-effector deflection constraints, is introduced.

An adaptive controller of nonlinear PID-based analog neural networks is developed for the point to point and orientation-tracking control of a two link rigid robot manipulator. In each case, the maximum load carrying capacity of robot manipulator subject to accuracy and actuators constraints is obtained. In comparison with conventional PID method, the use of neural network controller can increase maximum load carrying capacity of robot manipulators.

A superb mixture of a conventional PID controller and a neural network, which has powerful capability of continuously online learning, adaptation and tackling nonlinearity, brings us the novel nonlinear PID-based analog neural network controller.

The aims of this research work are reducing the difficulties of nonlinear dynamics, fast motion control of robot manipulators and comparing the performances of the nonlinear PID-based analog neural network and the conventional PID methods.

The paper is organized as follows:

The dynamic models of robot manipulators are described in Section 2. The neural network model for estimation of the appropriate PID gains and adaptive control system are presented in Section 3. Section 4 presents the simulation results obtained by determining the maximum load carrying capacity and the point to point and the tracking control of a

two rigid-link robot manipulator in various operating conditions, and compares the performance of the neural network based method with that of conventional PID method. Section 5 concludes the paper.

II. ROBOT DYNAMICS

Using the Euler–Lagrangian formulation, the dynamics of robot manipulators with rigid links can be written as [28]:

$$M(q)\ddot{q} + C(q, \dot{q})\dot{q} + G(q) + \tau_{dis} = \tau \quad (1)$$

Where $q \in \mathfrak{R}^n$ denotes the vector of generalized displacements, $\tau \in \mathfrak{R}^n$ denotes the vector of generalized control input forces, $M(q) \in \mathfrak{R}^{n \times n}$ is the inertia matrix, $C(q, \dot{q}) \in \mathfrak{R}^{n \times n}$ is the Coriolis matrix, $G(q) \in \mathfrak{R}^n$ is the gravity vector, and $\tau_{dis} \in \mathfrak{R}^n$ represents disturbances which are bounded.

For the robot dynamic model given by (1), the following assumptions are made.

- 1) The maximum allowable torques for each joint, τ_i^{\max} for $i = 1, 2, \dots, n$ are known.
- 2) The desired joint trajectory $q_{di}(t)$ and the higher order derivatives of $q_{di}(t)$ are bounded i.e. $q_{di}, \dot{q}_{di}, \ddot{q}_{di} \in L_\infty$.
- 3) The disturbances are bounded so that $\|\tau_{dis}\| \leq d_B$.

The control objective can be stated as follows: given desired trajectories $q_d(t) = [q_{d1}(t), \dots, q_{dn}(t)]^T$ determine a control law $\tau(t) \in \mathfrak{R}^n$ which is a function of position only and achieves desirable tracking performance in the presence of uncertainties and actuator constraints which are given by $|\tau_i(t)| \leq \tau_i^{\max}, \forall t \geq 0, i = 1, \dots, n$.

III. ADAPTIVE CONTROL SYSTEM

The strategy of PID control has been one of most sophisticated and most frequently used methods in industry. This is because the PID controller has a simple form and strong robustness in broad operating condition. However, the requirement of control precision becomes higher and higher in accordance with the complexity of plants. The conventional PID controller with fixed parameters may usually deteriorate the control performance. Various types of modified PID controllers have been developed in the existing literature. However, if severe nonlinearity is involved in the controlled process, a nonlinear control scheme will be more useful, particularly in the case of high nonlinearity of n-links robot manipulators. Nowadays, neural networks have been proved to be a promising approach to solve complex nonlinear control problems and there are two kinds of neural networks for control applications, i.e., digital and analog neural networks.

Many digital neural networks, which are discrete learning algorithms, have been presented owing to the fact that they offer several advantages such as predictable accuracy, high noise-immunity, ease of multiplexing communication and computation, availability of well-established tools for digital design and ease of interfacing with other digital systems.

On the other hand, analog neural networks, which are continuously learning algorithms, have many advantages such as high speed, small size, low cost, low power and straightforward interfacing with the outside world that is analog by nature, when analog neural circuits are made of electronic elements or chips.

Control systems have to respond in real time and, therefore, demand fast computation. Currently, many promising developments in robotics and automation are impractical because of the large size, cost and power consumption of the required control systems. Hence, it motivates us to combine an analog neural network with PID control.

The combination proposed here will take advantage of the simplicity of PID control and the analog neural network's powerful capability of continuous online learning, adaptability and tackling nonlinearity. However, there is a linear PID controller tuned using ANN in literature, but it may usually deteriorate the control performance [8] if severe nonlinearity is involved in the controlled process. Therefore, the nonlinear PID controller tuned using ANN is proposed in this paper and it can improve the control performance of the nonlinear systems.

The structure of the newly proposed control algorithm of nonlinear PID-based analog neural networks is shown in Fig. 1. This control algorithm has the characteristics such as simple structure, little computation time, and continuous auto-tuning method of the neural network controller. Two direct controllers of the PID-based analog neural networks are composed of the orientation control of the two link robot manipulator. Robot motion can be controlled by its orientation angles θ_1 and θ_2 .

Here, the control goal is to design two ANN controllers that force the tracking error $e = [e_{p1}, e_{p2}]^T$ to zero, where $e_{p1} = \theta_{d1} - \theta_1$, $e_{p2} = \theta_{d2} - \theta_2$, and θ_{d1} and θ_{d2} are the desired orientation angles 1 and 2, respectively.

τ_1 and τ_2 are the outputs of the ANN1 and the ANN2, respectively. The network structure with a three layer neuron is shown in Fig. 2.

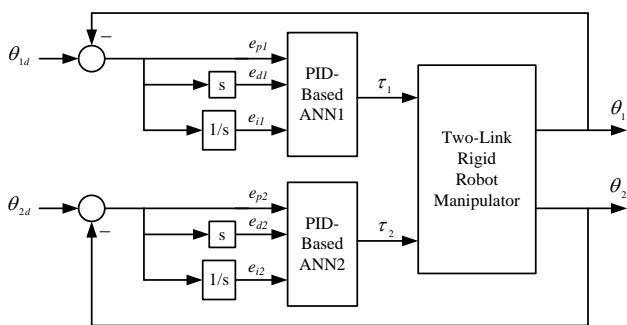

Fig 1. Block diagram of the two rigid-link robot manipulator control system.

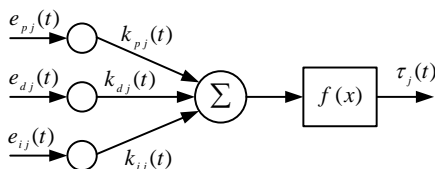

Fig 2. Block diagram of a nonlinear PID-based neural network.

Here, k_{pj} , k_{ij} , and k_{dj} ($j=1,2$) are the proportional, integral and derivative gains, respectively; e_{pj} , e_{ij} , and e_{dj} ($j=1,2$) that are three inputs of the neural network are the system errors between the desired output and motion output of the mobile robot, integral of the system error, and difference of the system error, respectively. A controller output τ_j can be obtained from the following equation:

$$\tau_j = f(x), \quad j=1,2, \quad (2)$$

where x is the input of sigmoid function $f(\cdot)$ that has a nonlinear relationship as presented in the following function

$$f(x) = \frac{2(1 - e^{-ax})}{a(1 + e^{-ax})}, \quad (3)$$

where a is a parameter, which determines the shape of sigmoid function. The input signal of the sigmoid function in the output layer becomes

$$x(t) = k_{pj}(t)e_{pj}(t) + k_{ij}(t)e_{ij}(t) + k_{dj}(t)e_{dj}(t), \quad j=1,2, \quad (4)$$

where

$$e_{p1}(t) = \theta_{d1}(t) - \theta_1(t), \quad e_{i1}(t) = \int_0^t e_{p1}(t) dt, \quad e_{d1}(t) = \frac{de_{p1}(t)}{dt},$$

$$e_{p2}(t) = \theta_{d2}(t) - \theta_2(t), \quad e_{i2}(t) = \int_0^t e_{p2}(t) dt, \quad e_{d2}(t) = \frac{de_{p2}(t)}{dt},$$

The Neural networks are trained by the conventional back propagation algorithm to minimize the system error between the output of the mobile robot and desired output defined by the following equation:

$$E_j(t) = \frac{1}{2} (e_{pj}(t))^2, \quad j=1,2, \quad (5)$$

From the discrete algorithm using the steepest descent method [29], the following equations can be derived:

$$\begin{cases} k_{pj}(t) = k_{pj}(0) - \eta_{pj} \int_0^t \frac{\partial E_j(t)}{\partial k_{pj}} dt, \\ k_{ij}(t) = k_{ij}(0) - \eta_{ij} \int_0^t \frac{\partial E_j(t)}{\partial k_{ij}} dt, \quad j=1,2, \\ k_{dj}(t) = k_{dj}(0) - \eta_{dj} \int_0^t \frac{\partial E_j(t)}{\partial k_{dj}} dt, \end{cases} \quad (6)$$

where η_{pj} , η_{ij} , and η_{dj} ($j=1,2$) are learning rates determining the convergence speed. From (5), using the chain rule, the following equations are derived:

$$\begin{cases} \frac{\partial E_j(t)}{\partial k_{pj}} = \frac{\partial E_j(t)}{\partial \theta_j} \cdot \frac{\partial \theta_j}{\partial \tau_j} \cdot \frac{\partial \tau_j(t)}{\partial x} \cdot \frac{\partial x(t)}{\partial k_{pj}} = -e_{pj}(t) \frac{\partial \theta_j}{\partial \tau_j} f'(x(t)) e_{pj}(t), \\ \frac{\partial E_j(t)}{\partial k_{ij}} = \frac{\partial E_j(t)}{\partial \theta_j} \cdot \frac{\partial \theta_j}{\partial \tau_j} \cdot \frac{\partial \tau_j(t)}{\partial x} \cdot \frac{\partial x(t)}{\partial k_{ij}} = -e_{pj}(t) \frac{\partial \theta_j}{\partial \tau_j} f'(x(t)) e_{ij}(t), \quad j=1,2, \\ \frac{\partial E_j(t)}{\partial k_{dj}} = \frac{\partial E_j(t)}{\partial \theta_j} \cdot \frac{\partial \theta_j}{\partial \tau_j} \cdot \frac{\partial \tau_j(t)}{\partial x} \cdot \frac{\partial x(t)}{\partial k_{dj}} = -e_{pj}(t) \frac{\partial \theta_j}{\partial \tau_j} f'(x(t)) e_{dj}(t), \end{cases} \quad (7)$$

And the following expression can be derived from Eq. (3):

$$f'(x) = 4 \frac{e^{-ax}}{(1 + e^{-ax})^2}, \quad (8)$$

As done by Thanh and Ahn [29], for convenience we assume $\partial \theta_j / \partial \tau_j = 1$ ($j=1,2$). Then (6) is expressed as follows:

$$\begin{cases} k_{pj}(t) = k_{pj}(0) - \eta_{pj} \int_0^t e_{pj}(t) e_{pj}(t) 4 \frac{e^{-ax}}{(1 + e^{-ax})^2} dt, \\ k_{ij}(t) = k_{ij}(0) - \eta_{ij} \int_0^t e_{pj}(t) e_{ij}(t) 4 \frac{e^{-ax}}{(1 + e^{-ax})^2} dt, \quad j=1,2, \\ k_{dj}(t) = k_{dj}(0) - \eta_{dj} \int_0^t e_{pj}(t) e_{dj}(t) 4 \frac{e^{-ax}}{(1 + e^{-ax})^2} dt, \end{cases} \quad (9)$$

The effectiveness of the proposed PID-based ANN control will be demonstrated through simulations of the motion control of the two link robot manipulator.

IV. SIMULATION RESULTS

For simplicity, a two rigid-link robot manipulator is utilized in this study to verify the effectiveness of the proposed control scheme. The dynamic model of the adopted robot system can be described in the form of (1) as

$$\begin{aligned}
 q &= (\theta_1 \ \theta_2)^T, \dot{q} = (\dot{\theta}_1 \ \dot{\theta}_2)^T, \tau_{dis} = (0 \ 0)^T, \\
 c_1 &= \cos(\theta_1), c_2 = \cos(\theta_2), c_{12} = \cos(\theta_1 + \theta_2), s_2 = \sin(\theta_2), \\
 M(q) &= \begin{pmatrix} M_{11} & M_{12} \\ M_{21} & M_{22} \end{pmatrix}, G(q) = \begin{pmatrix} G_1 \\ G_2 \end{pmatrix}, C(q, \dot{q})\dot{q} = \begin{pmatrix} A_1 \\ A_2 \end{pmatrix}, \\
 M_{11} &= \left(\frac{m_1}{3} + m_2 + m_L\right)a_1^2 + \left(\frac{m_2}{3} + m_L\right)a_2^2 \\
 &\quad + (m_2 + 2m_L)a_1a_2c_2, \\
 M_{12} = M_{21} &= \left(\frac{m_2}{3} + m_L\right)a_2^2 + \left(\frac{m_2}{2} + m_L\right)a_1a_2c_2, \\
 M_{22} &= \left(\frac{m_2}{3} + m_L\right)a_2^2, \\
 G_1 &= g\left(\frac{m_1}{2} + m_2 + m_{load}\right)a_1c_1 + g\left(\frac{m_2}{2} + m_{load}\right)a_2c_{12}, \\
 G_2 &= g\left(\frac{m_2}{2} + m_L\right)a_2c_{12}, \\
 A_1 &= -(m_2 + 2m_L)a_1a_2s_2\dot{\theta}_1\dot{\theta}_2 - \left(\frac{m_2}{2} + m_L\right)a_1a_2s_2\dot{\theta}_2^2, \\
 A_2 &= \left(\frac{m_2}{2} + m_L\right)a_1a_2s_2\dot{\theta}_1^2,
 \end{aligned} \tag{10}$$

Where θ_1 and θ_2 are the angle of joints 1 and 2; m_1 and m_2 are the mass of links 1 and 2; a_1 and a_2 are the length of links 1 and 2; m_L (m_{load}) is the mass of end-effector load; and g is the gravity acceleration.

Moreover, the system parameters of the two rigid-link robot manipulator are selected as:

$$a_1 = 1^m, a_2 = 1^m, m_1 = 2^{kg}, m_2 = 0.5^{kg}, g = 9.8^{m/sec^2}$$

The proposed neural network control is verified with computer simulation using MATLAB/SIMULINK. Here, the simulation results obtained by determining the maximum load carrying capacity and the point to point and the tracking control of a two rigid-link robot manipulator in various operating conditions, and comparing the performance of the neural network based method with that of conventional PID method.

The maximum allowable torques for each joint is considered as, $|\tau_j^{max}| \leq 100^{N.m}$ ($j=1,2$) and the initial conditions are taken as, $q(0) = (0 \ 0)^T$ and $\dot{q}(0) = (0 \ 0)^T$.

A. Tracking Control

For the simulation purpose, the desired orientation angles are taken as $\theta_{1d}(t) = 20\sin(2\pi ft)^\circ$ and $\theta_{2d}(t) = 15\cos(2\pi ft)^\circ$ (frequency of reference input $f = 0.1^{Hz}$) [29]

Fig. 3 shows the results of comparison between conventional PID controller and nonlinear PID controller using neural network in determining of maximum load carrying capacity of two rigid-link robot manipulator. For a prescribed trajectory, the maximum load carrying capacity of a joint manipulator is defined as the maximum load that the

manipulator can carry in executing the trajectory with an acceptable tracking accuracy. The main constraints, which bound the maximum load carrying capacity of manipulators, are actuators and accuracy constraints. In this paper, the average of tracking error is considered as 0.025 radian or 1.432 degree in the settling time of 20 sec.

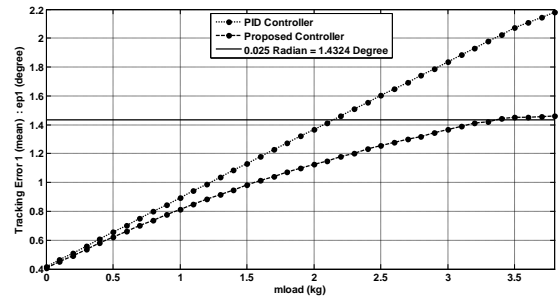

Fig 3. Comparison between conventional PID controller and proposed controller in determining of maximum load carrying capacity (tracking control case).

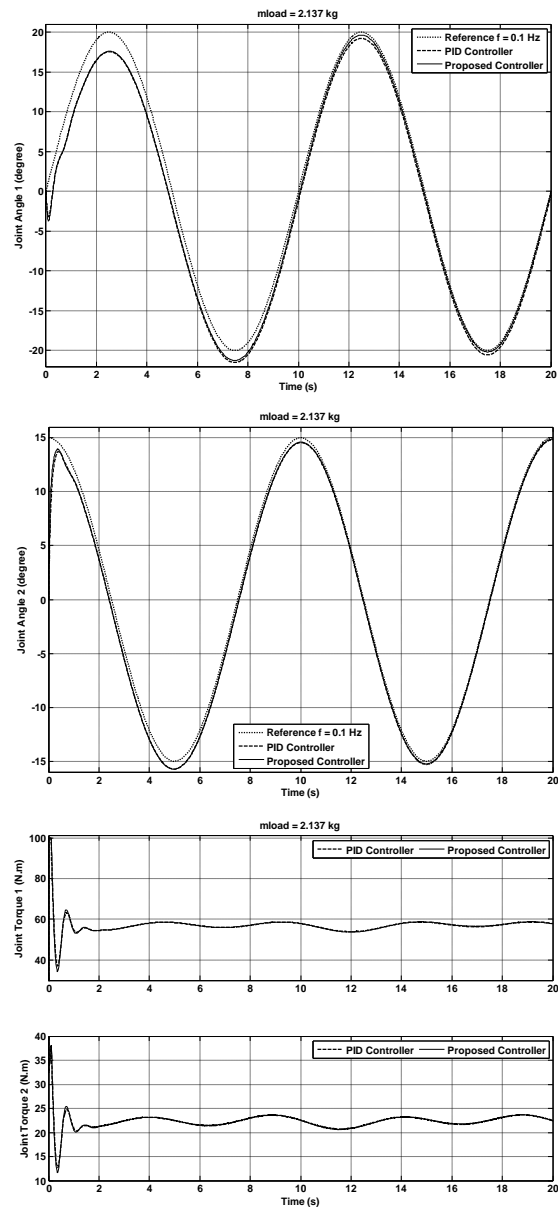

Fig 4. Comparison between conventional PID controller and nonlinear PID controller using neural network (frequency of reference $f = 0.1^{Hz}$ and $m_{load} = 2.137^{kg}$).

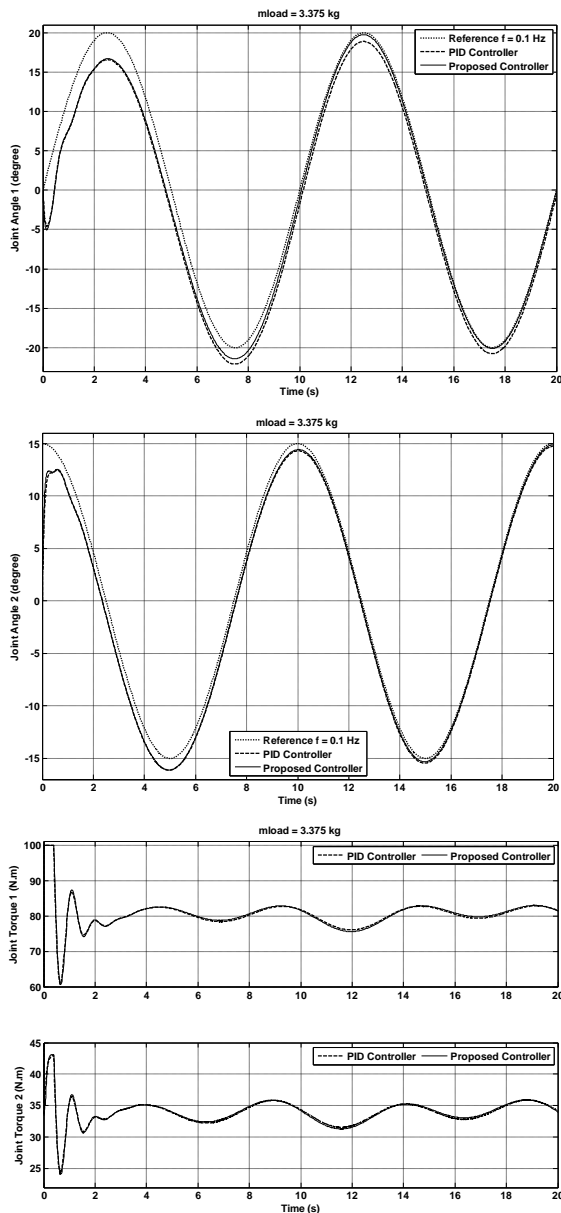

Fig 5. Comparison between conventional PID controller and nonlinear PID controller using neural network (frequency of reference $f = 0.1\text{Hz}$ and $m_{load} = 3.375\text{kg}$).

The parameters of two PID controllers were set to be $k_{pj} = 1000$, $k_{ij} = 100$, and $k_{dj} = 75$ ($j = 1, 2$). In the experiments of the two proposed nonlinear PID controllers, the initial values of $k_{pj}(0)$, $k_{ij}(0)$, and $k_{dj}(0)$ ($j = 1, 2$) are set to be the same as that of conventional PID controller. The parameters of two ANN controllers are chosen as, $\eta_{p1} = 600$, $\eta_{i1} = 500$, $\eta_{d1} = 800$, $\eta_{p2} = 800$, $\eta_{i2} = 600$, $\eta_{d2} = 800$, and $a = 0.001$. The parameters of these controllers were obtained by trial-and-error through experiments. The maximum load carrying capacity of the robot is obtained from 2.137kg and 3.375kg in PID controller and proposed controller, respectively. In comparison with conventional PID method, the use of neural network controller increases maximum load carrying capacity of robot manipulator (1.238kg). First, the experiments were carried out to verify the effectiveness of the proposed nonlinear PID controller using neural network when the frequency of reference input was 0.1Hz in full load status (2.137kg and 3.375kg).

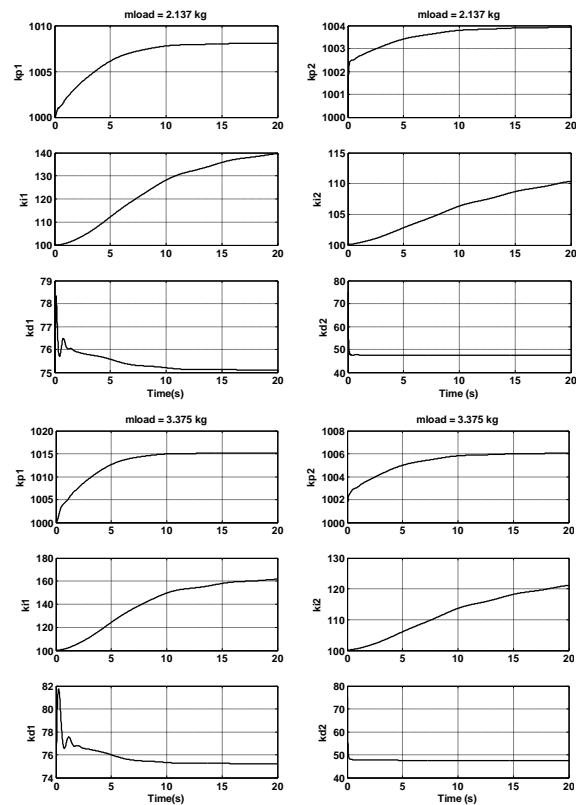

Fig 6. Updating of each control parameter (k_p , k_i and k_d).

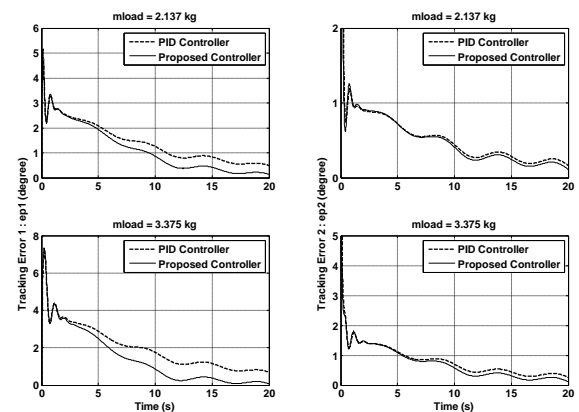

Fig 7. Comparison tracking error between conventional PID controller and proposed controller.

Figs. 4 and 5 show the experimental results between the conventional PID controller and the proposed nonlinear PID controller with respect to Joints 1 and 2, and the updating of each control parameter (k_p , k_i , and k_d) and the tracking error were shown in Figs. 6 and 7, respectively.

The purpose of the experiment is to show the effectiveness of the adaptability of the proposed nonlinear PID controller. From Figs. 4, 5 and 7, it was understood that the system response of the proposed controller was in good agreement with that of reference input and it was demonstrated that the proposed algorithm was effective in tracking problem.

B. Point to Point Control

In this section firstly maximum load capacity of nonlinear PID controller using neural network and conventional PID controller are compared to reach $(\theta_d \theta_{2d}) = (\pi/6 \pi/3)$ or $(x y) = (0.866^m \ 1.5^m)$ point in 2s settling time (Fig 8). Maximum load capacity is determined considering that final

point error should be less than 2cm. Because of approximately similar results of two controllers in point to point move, so only the results of nonlinear PID controller using neural network are shown. Two different simulations are done using nonlinear PID controller using neural network in two no load and maximum load ($m_{load} = 1.8^{kg}$) cases. Fig 9 shows the simulations results.

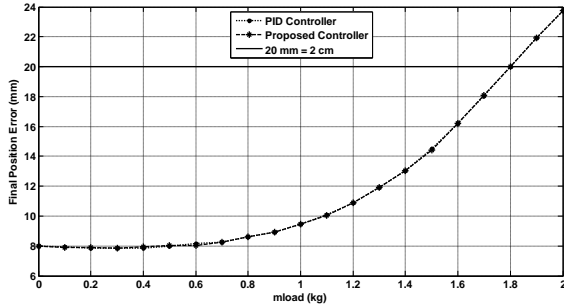

Fig 8. Comparison between conventional PID controller and proposed controller in determining of maximum load carrying capacity (point to point control case).

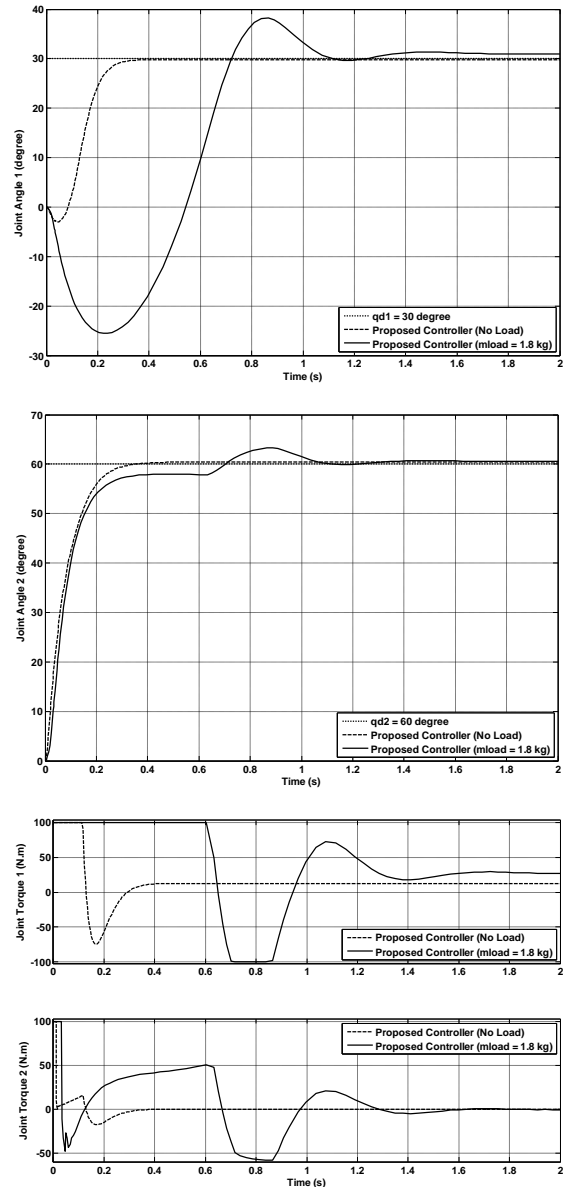

Fig 9. Results of proposed nonlinear PID controller using neural network in two no load and maximum load ($m_{load} = 1.8^{kg}$) cases.

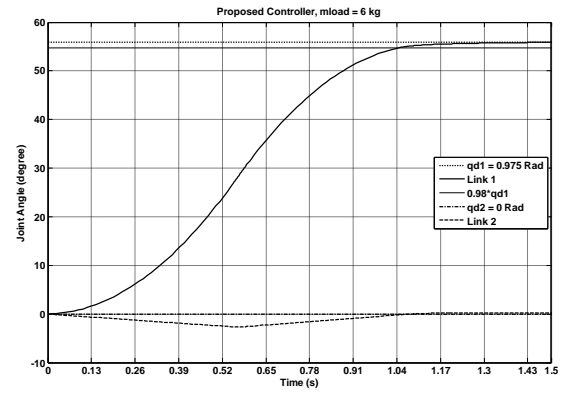

Fig 10. Links position.

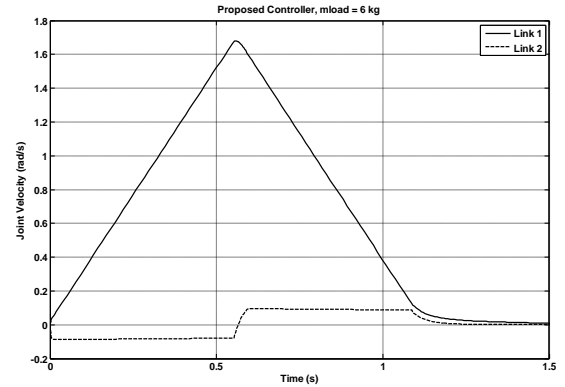

Fig 11. Links velocity.

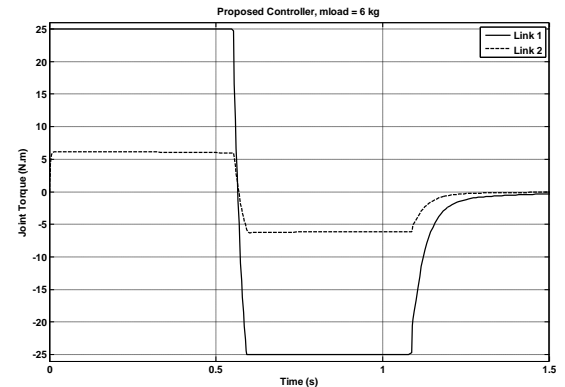

Fig 12. Motors torque.

In this section initial conditions are chosen similar to previous section, but learning coefficients values are chosen as $\eta_{p1} = 0.006$, $\eta_{i1} = 0.005$, $\eta_{d1} = 0.008$, $\eta_{p2} = 0.008$, $\eta_{i2} = 0.006$, and $\eta_{d2} = 0.008$. These values are chosen with trial-and-error.

Other simulations are done in a point to point move on a two link robot manipulator with these parameters:

$$a_1 = 0.4^m, a_2 = 0.25^m, m_1 = 29.58^{kg}, m_2 = 15^{kg}, g = 0^{m/sec^2}$$

Mechanical manipulator move is done on a horizontal surface, so the gravity acceleration assumed to be zero.

Limited span of motor torques are as below: $|\tau_1^{max}| \leq 25^{N.m}$ and

$$|\tau_2^{max}| \leq 9^{N.m}$$

Initial conditions are assumed as $q(0) = (0 \ 0)^T$ and $\dot{q}(0) = (0 \ 0)^T$. Our desired is to reach to

$$(\theta_{1d} \ \theta_{2d}) = (0.975 \ 0)^{Rad}$$

point in 1.04s settling time. Maximum load capacity is calculated as 6kg in this case considering that final point error is less than 2cm. Links position and velocity

in maximum load case are shown in Figs 10 and 11. Motors torque are shown in Fig 12. In this case initial values of selected PID parameters are: $k_{p1}(0)=1000$, $k_{i1}(0)=5$, $k_{d1}(0)=290$, $k_{p2}(0)=10$, $k_{i2}(0)=1$, and $k_{d2}(0)=70$.

Learning coefficient and determining parameter of sigmoid function are considered to be similar to previous case values.

V. CONCLUSION

In this paper an adaptive controller of a nonlinear PID-based analog neural network is proposed for the point to point and orientation tracking control of a two rigid link robot manipulator and the comparisons of control performance between the conventional PID and the proposed nonlinear PID controller are performed. A superb mixture of a conventional PID controller and a neural network, which has powerful capability of continuously online learning, adaptation, tackling nonlinearity and increasing the maximum load carrying capacity of robot manipulator, brings us the novel nonlinear PID-based analog neural network controller. Simulation results demonstrate the effectiveness of the proposed control algorithm, better dynamic property, and strong robustness, and it was suitable for the control of a two rigid link robot manipulator. Actually, the proposed neural controller does not require the dynamics model of robot manipulators, which is needed only in the simulation for this paper. In comparison with conventional PID method, the use of neural network controller can increase maximum load carrying capacity of robot manipulator.

ACKNOWLEDGMENT

This research work has been financially supported by East Tehran Branch, Islamic Azad University, Tehran, Iran.

REFERENCES

- [1] K.J. Astrom, and T. Hagglund, "Automatic tuning of simple regulators with specification on phase and amplitude margins," *Automatica*, vol. 20, 1984, pp. 645–651.
- [2] K.J. Astrom, and T. Hagglund, *PID Controller: Theory, Design, and Tuning*. Research Triangle Park, NC, USA, 1995.
- [3] C.C. Hang, K.J. Astrom, and W.K. Ho, "Refinements of the Ziegler-Nichols tuning formula," *IEE Proc. Control Theory Appl.*, vol. 138, 1991, pp. 111–118.
- [4] A.J. Koivo, *Fundamentals for Control of Robotic Manipulators*. Wiley, New York, 1989.
- [5] F.L. Lewis, C.T. Abdallah, and D.M. Dawson, *Control of Robot Manipulators*. Macmillan, New York, 1993.
- [6] R.J. Schilling, *Fundamentals of Robotics: Analysis and Control*. Prentice-Hall, EnglewoodCliffs, NJ, 1998.
- [7] I. Cha, and C. Han, "The auto-tuning PID controller using the parameter estimation," *IEEE/RSJ International Conference on Intelligent Robots and Systems* South Korea, 1999, p. 46.
- [8] T.Y. Kuc, and W.G. Han, "Adaptive PID learning of periodic robot motion," *37th IEEE Conference on Decision and Control* USA, 1998, p. 186.
- [9] D. Sun, and J.K. Mills, "High-accuracy trajectory tracking of industrial robot manipulator using adaptive-learning schemes," *American Control Conference* USA, 1999, p. 1935.
- [10] Y. Li, Y.K. Ho, and C.S. Chua, "Model-based PID control of constrained robot in a dynamic environment with uncertainty," *IEEE International Conference on Control Applications* USA, 2000, p. 74.
- [11] P.C.Y. Chen, J.K. Mills, and G. Vukovich, "Neural network learning and generalization for performance improvement of industrial robots," *Canadian Conference on Electrical and Computer Engineering* Canada, 1996, p. 566.

- [12] C. Clifton, A. Homaifar, and M. Bikdash, "Design of generalized Sugeno controllers by approximating hybrid fuzzy-PID controllers," *IEEE International Conference on Fuzzy Systems* USA, 1996, p. 1906.
- [13] L.B. Gutierrez, F.L. Lewis, and J.A. Lowe, "Implementation of a neural network tracking controller for a single flexible link: comparison with PD and PID controller," *IEEE Trans. Ind. Electron.*, Vol. 45, 1998, pp. 307–318.
- [14] S.J. Huang, and J.S. Lee, "A stable self-organizing fuzzy controller for robotic motion control," *IEEE Trans. Ind. Electron.*, vol. 47, 2000, pp. 421–428.
- [15] Y.H. Kim, and F.L. Lewis, "Optimal design of CMAC neural-network controller for robot manipulators," *IEEE Trans. Systems Man Cybernet.*, vol. 30, 2000, pp. 22–31.
- [16] F.L. Lewis, A. Yesildirek, and K. Liu, "Multilayer neural-net robot controller with guaranteed tracking performance," *IEEE Trans. Neural Networks*, vol. 7, 1996, pp. 388–399.
- [17] D. Misir, H.A. Malki, and G. Chen, "Graphical stability analysis for a fuzzy PID controlled robot arm model," *IEEE International Conference on Fuzzy Systems* USA, 1998, p. 451.
- [18] A.T. Vemuri, and M.M. Polycarpou, "Neural-network-based robust fault diagnosis in robotic systems," *IEEE Trans. Neural Networks*, vol. 8, 1997, pp. 1410–1420.
- [19] B.K. Yoo, and W.C. Ham, "Adaptive control of robot manipulator using fuzzy compensator," *IEEE Trans. Fuzzy Systems*, vol. 8, 2000, pp. 186–199.
- [20] O. Barambones, and V. Etxebarria, "Robust neural control for robotic manipulators," *Automatica*, vol. 38, 2002, pp. 235–242.
- [21] L. Behera, S. Chaudhury, and M. Gopal, "Neuro adaptive hybrid controller for robot manipulator tracking control," *IEE Proceedings D, Control Theory and its Applications*, vol. 143, 1996, pp. 270–275.
- [22] M. Ertugrul, and O. Kaynak, "Neuro sliding mode control of robotic manipulators," *Mechatronics*, vol. 10, 2000, pp. 239–263.
- [23] R. J. Wai, "Tracking control based on neural network strategy for robot manipulators," *Neurocomputing*, vol. 51, 2003, pp. 425–445.
- [24] M. Thomas, H.C. Yuan-Chou, and D. Tesar, "Optimal actuator sizing for robotic manipulator based on local dynamic criteria," *ASME Journal of Mechanisms, Transactions and Automation*, vol. 107, 1985, pp. 163-169.
- [25] L.T. Wang, and B. Ravani, "Dynamic load carrying capacity of mechanical manipulators-part I: problem formulation," *Transactions of ASME, Journal of dynamic system, Measurement and control*, vol. 110, 1988, pp. 46-52.
- [26] M.H. Korayem, Y. Yao, and A. Basu, "Load carrying capacity for a two-link planar flexible arm," *Proc. Thirteenth Canadian Congress of Applied Mechanics*, vol. 2, June 1991.
- [27] M.H. Korayem, and A. Basu, "Dynamic load carrying capacity of robotic manipulators with joint elasticity imposing accuracy constraints," *Robotics and Autonomous Systems*, vol. 13, 1994, pp. 219-229.
- [28] J. J. Slotine, and W. Li, "On the adaptive control of robots manipulators," *International Journal of Robotics Research*, vol. 6, 1987, pp. 49–59.
- [29] T.D.C. Thanh, and K.K. Ahn, "Nonlinear PID control to improve the control performance of 2 axes pneumatic artificial muscle manipulator using neural network," *Mechatronics*, vol. 16, 2006, pp. 577–587.

Hadi Razmi was born in Tehran, Iran, in 1980. He received the M.S. degree in control engineering from University of Tabriz, Tabriz, Iran, in 2005. He is currently a Ph.D. student at the Science and Research Branch, Islamic Azad University, Tehran, Iran. He is an Academic Staff of Control Engineering at East Tehran Branch, Islamic Azad University, Tehran, Iran. His research interests include power system optimization and control, security analysis, and neural networks and fuzzy systems applications.

Atabak Mashhadi kashtiban was born in Orumiyeh, Iran, in 1980. He received the M.S. degree in control engineering from University of Tabriz, Tabriz, Iran, in 2005. He is currently a Ph.D. student at the Science and Research Branch, Islamic Azad University, Tehran, Iran. He is an Academic Staff of Control Engineering at Khameneh Branch, Islamic Azad University, Tabriz, Iran. His research interests include power system optimization and control, security analysis, and neural networks and fuzzy systems applications.