

Hyper-Threading Technology Architecture and Microarchitecture

Deborah T. Marr, Desktop Products Group, Intel Corp.

Frank Binns, Desktop Products Group, Intel Corp.

David L. Hill, Desktop Products Group, Intel Corp.

Glenn Hinton, Desktop Products Group, Intel Corp.

David A. Koufaty, Desktop Products Group, Intel Corp.

J. Alan Miller, Desktop Products Group, Intel Corp.

Michael Upton, CPU Architecture, Desktop Products Group, Intel Corp.

Index words: architecture, microarchitecture, Hyper-Threading Technology, simultaneous multi-threading, multiprocessor

ABSTRACT

Intel's Hyper-Threading Technology brings the concept of simultaneous multi-threading to the Intel Architecture. Hyper-Threading Technology makes a single physical processor appear as two logical processors; the physical execution resources are shared and the architecture state is duplicated for the two logical processors. From a software or architecture perspective, this means operating systems and user programs can schedule processes or threads to logical processors as they would on multiple physical processors. From a microarchitecture perspective, this means that instructions from both logical processors will persist and execute simultaneously on shared execution resources.

This paper describes the Hyper-Threading Technology architecture, and discusses the microarchitecture details of Intel's first implementation on the Intel® Xeon™ processor family. Hyper-Threading Technology is an important addition to Intel's enterprise product line and will be integrated into a wide variety of products.

®Intel is a registered trademark of Intel Corporation or its subsidiaries in the United States and other countries.

™Xeon is a trademark of Intel Corporation or its subsidiaries in the United States and other countries.

INTRODUCTION

The amazing growth of the Internet and telecommunications is powered by ever-faster systems demanding increasingly higher levels of processor performance. To keep up with this demand we cannot rely entirely on traditional approaches to processor design. Microarchitecture techniques used to achieve past processor performance improvement—super-pipelining, branch prediction, super-scalar execution, out-of-order execution, caches—have made microprocessors increasingly more complex, have more transistors, and consume more power. In fact, transistor counts and power are increasing at rates greater than processor performance. Processor architects are therefore looking for ways to improve performance at a greater rate than transistor counts and power dissipation. Intel's Hyper-Threading Technology is one solution.

Processor Microarchitecture

Traditional approaches to processor design have focused on higher clock speeds, instruction-level parallelism (ILP), and caches. Techniques to achieve higher clock speeds involve pipelining the microarchitecture to finer granularities, also called super-pipelining. Higher clock frequencies can greatly improve performance by increasing the number of instructions that can be executed each second. Because there will be far more instructions in-flight in a super-pipelined microarchitecture, handling of events that disrupt the pipeline, e.g., cache misses, interrupts and branch mispredictions, can be costly.

ILP refers to techniques to increase the number of instructions executed each clock cycle. For example, a super-scalar processor has multiple parallel execution units that can process instructions simultaneously. With super-scalar execution, several instructions can be executed each clock cycle. However, with simple in-order execution, it is not enough to simply have multiple execution units. The challenge is to find enough instructions to execute. One technique is out-of-order execution where a large window of instructions is simultaneously evaluated and sent to execution units, based on instruction dependencies rather than program order.

Accesses to DRAM memory are slow compared to execution speeds of the processor. One technique to reduce this latency is to add fast caches close to the processor. Caches can provide fast memory access to frequently accessed data or instructions. However, caches can only be fast when they are small. For this reason, processors often are designed with a cache hierarchy in which fast, small caches are located and operated at access latencies very close to that of the processor core, and progressively larger caches, which handle less frequently accessed data or instructions, are implemented with longer access latencies. However, there will always be times when the data needed will not be in any processor cache. Handling such cache misses requires accessing memory, and the processor is likely to quickly run out of instructions to execute before stalling on the cache miss.

The vast majority of techniques to improve processor performance from one generation to the next is complex and often adds significant die-size and power costs. These techniques increase performance but not with 100% efficiency; i.e., doubling the number of execution units in a processor does not double the performance of the processor, due to limited parallelism in instruction flows. Similarly, simply doubling the clock rate does not double the performance due to the number of processor cycles lost to branch mispredictions.

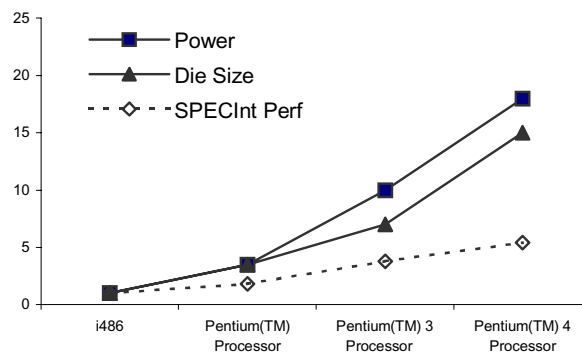

Figure 1: Single-stream performance vs. cost

Figure 1 shows the relative increase in performance and the costs, such as die size and power, over the last ten years on Intel processors¹. In order to isolate the microarchitecture impact, this comparison assumes that the four generations of processors are on the same silicon process technology and that the speed-ups are normalized to the performance of an Intel486™ processor. Although we use Intel's processor history in this example, other high-performance processor manufacturers during this time period would have similar trends. Intel's processor performance, due to microarchitecture advances alone, has improved integer performance five- or six-fold¹. Most integer applications have limited ILP and the instruction flow can be hard to predict.

Over the same period, the relative die size has gone up fifteen-fold, a three-times-higher rate than the gains in integer performance. Fortunately, advances in silicon process technology allow more transistors to be packed into a given amount of die area so that the actual measured die size of each generation microarchitecture has not increased significantly.

The relative power increased almost eighteen-fold during this period¹. Fortunately, there exist a number of known techniques to significantly reduce power consumption on processors and there is much on-going research in this area. However, current processor power dissipation is at the limit of what can be easily dealt with in desktop platforms and we must put greater emphasis on improving performance in conjunction with new technology, specifically to control power.

¹ These data are approximate and are intended only to show trends, not actual performance.

™ Intel486 is a trademark of Intel Corporation or its subsidiaries in the United States and other countries.

Thread-Level Parallelism

A look at today's software trends reveals that server applications consist of multiple threads or processes that can be executed in parallel. On-line transaction processing and Web services have an abundance of software threads that can be executed simultaneously for faster performance. Even desktop applications are becoming increasingly parallel. Intel architects have been trying to leverage this so-called thread-level parallelism (TLP) to gain a better performance vs. transistor count and power ratio.

In both the high-end and mid-range server markets, multiprocessors have been commonly used to get more performance from the system. By adding more processors, applications potentially get substantial performance improvement by executing multiple threads on multiple processors at the same time. These threads might be from the same application, from different applications running simultaneously, from operating system services, or from operating system threads doing background maintenance. Multiprocessor systems have been used for many years, and high-end programmers are familiar with the techniques to exploit multiprocessors for higher performance levels.

In recent years a number of other techniques to further exploit TLP have been discussed and some products have been announced. One of these techniques is chip multiprocessing (CMP), where two processors are put on a single die. The two processors each have a full set of execution and architectural resources. The processors may or may not share a large on-chip cache. CMP is largely orthogonal to conventional multiprocessor systems, as you can have multiple CMP processors in a multiprocessor configuration. Recently announced processors incorporate two processors on each die. However, a CMP chip is significantly larger than the size of a single-core chip and therefore more expensive to manufacture; moreover, it does not begin to address the die size and power considerations.

Another approach is to allow a single processor to execute multiple threads by switching between them. Time-slice multithreading is where the processor switches between software threads after a fixed time period. Time-slice multithreading can result in wasted execution slots but can effectively minimize the effects of long latencies to memory. Switch-on-event multithreading would switch threads on long latency events such as cache misses. This approach can work well for server applications that have large numbers of cache misses and where the two threads are executing similar tasks. However, both the time-slice and the switch-on-

event multi-threading techniques do not achieve optimal overlap of many sources of inefficient resource usage, such as branch mispredictions, instruction dependencies, etc.

Finally, there is simultaneous multi-threading, where multiple threads can execute on a single processor without switching. The threads execute simultaneously and make much better use of the resources. This approach makes the most effective use of processor resources: it maximizes the performance vs. transistor count and power consumption.

Hyper-Threading Technology brings the simultaneous multi-threading approach to the Intel architecture. In this paper we discuss the architecture and the first implementation of Hyper-Threading Technology on the Intel® Xeon™ processor family.

HYPER-THREADING TECHNOLOGY ARCHITECTURE

Hyper-Threading Technology makes a single physical processor appear as multiple logical processors [11, 12]. To do this, there is one copy of the architecture state for each logical processor, and the logical processors share a single set of physical execution resources. From a software or architecture perspective, this means operating systems and user programs can schedule processes or threads to logical processors as they would on conventional physical processors in a multiprocessor system. From a microarchitecture perspective, this means that instructions from logical processors will persist and execute simultaneously on shared execution resources.

Figure 2: Processors without Hyper-Threading Tech

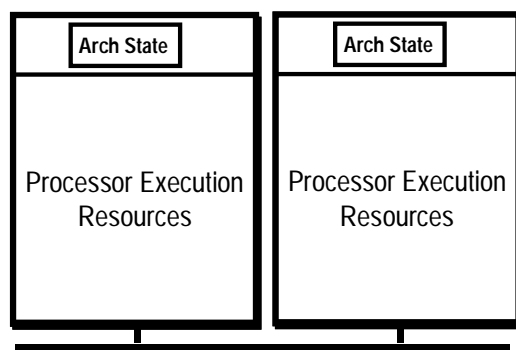

®Intel is a registered trademark of Intel Corporation or its subsidiaries in the United States and other countries.

™Xeon is a trademark of Intel Corporation or its subsidiaries in the United States and other countries.

As an example, Figure 2 shows a multiprocessor system with two physical processors that are not Hyper-Threading Technology-capable. Figure 3 shows a multiprocessor system with two physical processors that are Hyper-Threading Technology-capable. With two copies of the architectural state on each physical processor, the system appears to have four logical processors.

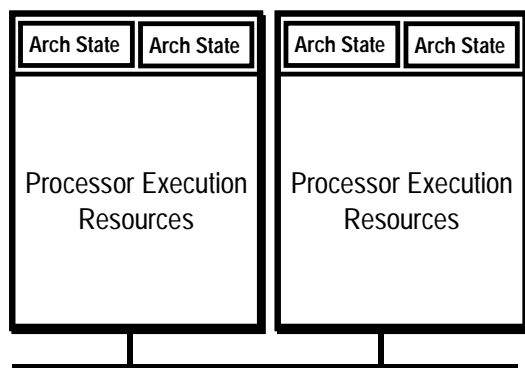

Figure 3: Processors with Hyper-Threading Technology

The first implementation of Hyper-Threading Technology is being made available on the Intel[®] Xeon[™] processor family for dual and multiprocessor servers, with two logical processors per physical processor. By more efficiently using existing processor resources, the Intel Xeon processor family can significantly improve performance at virtually the same system cost. This implementation of Hyper-Threading Technology added less than 5% to the relative chip size and maximum power requirements, but can provide performance benefits much greater than that.

Each logical processor maintains a complete set of the architecture state. The architecture state consists of registers including the general-purpose registers, the control registers, the advanced programmable interrupt controller (APIC) registers, and some machine state registers. From a software perspective, once the architecture state is duplicated, the processor appears to be two processors. The number of transistors to store the architecture state is an extremely small fraction of the total. Logical processors share nearly all other resources on the physical processor, such as caches,

[®] Intel is a registered trademark of Intel Corporation or its subsidiaries in the United States and other countries.

[™] Xeon is a trademark of Intel Corporation or its subsidiaries in the United States and other countries.

execution units, branch predictors, control logic, and buses.

Each logical processor has its own interrupt controller or APIC. Interrupts sent to a specific logical processor are handled only by that logical processor.

FIRST IMPLEMENTATION ON THE INTEL XEON PROCESSOR FAMILY

Several goals were at the heart of the microarchitecture design choices made for the Intel[®] Xeon[™] processor MP implementation of Hyper-Threading Technology. One goal was to minimize the die area cost of implementing Hyper-Threading Technology. Since the logical processors share the vast majority of microarchitecture resources and only a few small structures were replicated, the die area cost of the first implementation was less than 5% of the total die area.

A second goal was to ensure that when one logical processor is stalled the other logical processor could continue to make forward progress. A logical processor may be temporarily stalled for a variety of reasons, including servicing cache misses, handling branch mispredictions, or waiting for the results of previous instructions. Independent forward progress was ensured by managing buffering queues such that no logical processor can use all the entries when two active software threads² were executing. This is accomplished by either partitioning or limiting the number of active entries each thread can have.

A third goal was to allow a processor running only one active software thread to run at the same speed on a processor with Hyper-Threading Technology as on a processor without this capability. This means that partitioned resources should be recombined when only one software thread is active. A high-level view of the microarchitecture pipeline is shown in Figure 4. As shown, buffering queues separate major pipeline logic blocks. The buffering queues are either partitioned or duplicated to ensure independent forward progress through each logic block.

[®] Intel is a registered trademark of Intel Corporation or its subsidiaries in the United States and other countries.

[™] Xeon is a trademark of Intel Corporation or its subsidiaries in the United States and other countries.

² Active software threads include the operating system idle loop because it runs a sequence of code that continuously checks the work queue(s). The operating system idle loop can consume considerable execution resources.

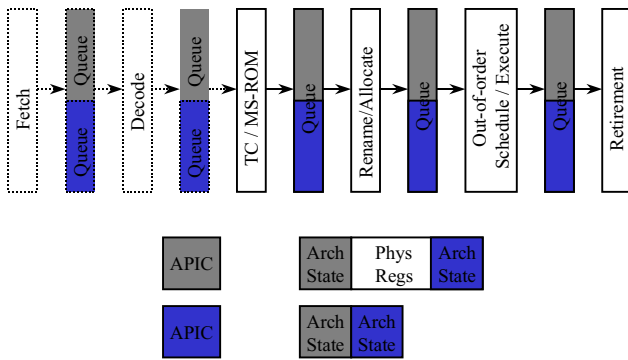

Figure 4 Intel® Xeon™ processor pipeline

In the following sections we will walk through the pipeline, discuss the implementation of major functions, and detail several ways resources are shared or replicated.

FRONT END

The front end of the pipeline is responsible for delivering instructions to the later pipe stages. As shown in Figure 5a, instructions generally come from the Execution Trace Cache (TC), which is the primary or Level 1 (L1) instruction cache. Figure 5b shows that only when there is a TC miss does the machine fetch and decode instructions from the integrated Level 2 (L2) cache. Near the TC is the Microcode ROM, which stores decoded instructions for the longer and more complex IA-32 instructions.

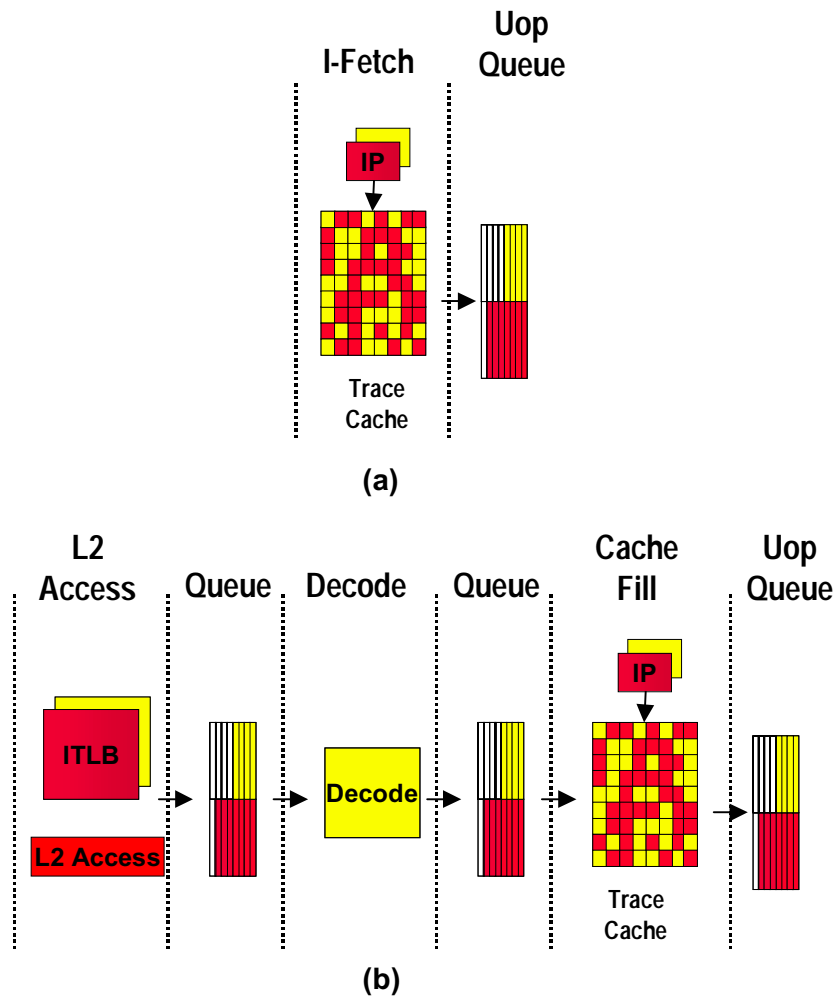

Figure 5: Front-end detailed pipeline (a) Trace Cache Hit (b) Trace Cache Miss

Execution Trace Cache (TC)

The TC stores decoded instructions, called micro-operations or “uops.” Most instructions in a program are fetched and executed from the TC. Two sets of next-instruction-pointers independently track the progress of the two software threads executing. The two logical processors arbitrate access to the TC every clock cycle. If both logical processors want access to the TC at the same time, access is granted to one then the other in alternating clock cycles. For example, if one cycle is used to fetch a line for one logical processor, the next cycle would be used to fetch a line for the other logical processor, provided that both logical processors requested access to the trace cache. If one logical processor is stalled or is unable to use the TC, the other logical processor can use the full bandwidth of the trace cache, every cycle.

The TC entries are tagged with thread information and are dynamically allocated as needed. The TC is 8-way set associative, and entries are replaced based on a least-recently-used (LRU) algorithm that is based on the full 8 ways. The shared nature of the TC allows one logical processor to have more entries than the other if needed.

Microcode ROM

When a complex instruction is encountered, the TC sends a microcode-instruction pointer to the Microcode ROM. The Microcode ROM controller then fetches the uops needed and returns control to the TC. Two microcode instruction pointers are used to control the flows independently if both logical processors are executing complex IA-32 instructions.

Both logical processors share the Microcode ROM entries. Access to the Microcode ROM alternates between logical processors just as in the TC.

ITLB and Branch Prediction

If there is a TC miss, then instruction bytes need to be fetched from the L2 cache and decoded into uops to be placed in the TC. The Instruction Translation Lookaside Buffer (ITLB) receives the request from the TC to deliver new instructions, and it translates the next-instruction pointer address to a physical address. A request is sent to the L2 cache, and instruction bytes are returned. These bytes are placed into streaming buffers, which hold the bytes until they can be decoded.

The ITLBs are duplicated. Each logical processor has its own ITLB and its own set of instruction pointers to track the progress of instruction fetch for the two logical processors. The instruction fetch logic in charge of sending requests to the L2 cache arbitrates on a first-

come first-served basis, while always reserving at least one request slot for each logical processor. In this way, both logical processors can have fetches pending simultaneously.

Each logical processor has its own set of two 64-byte streaming buffers to hold instruction bytes in preparation for the instruction decode stage. The ITLBs and the streaming buffers are small structures, so the die size cost of duplicating these structures is very low.

The branch prediction structures are either duplicated or shared. The return stack buffer, which predicts the target of return instructions, is duplicated because it is a very small structure and the call/return pairs are better predicted for software threads independently. The branch history buffer used to look up the global history array is also tracked independently for each logical processor. However, the large global history array is a shared structure with entries that are tagged with a logical processor ID.

IA-32 Instruction Decode

IA-32 instructions are cumbersome to decode because the instructions have a variable number of bytes and have many different options. A significant amount of logic and intermediate state is needed to decode these instructions. Fortunately, the TC provides most of the uops, and decoding is only needed for instructions that miss the TC.

The decode logic takes instruction bytes from the streaming buffers and decodes them into uops. When both threads are decoding instructions simultaneously, the streaming buffers alternate between threads so that both threads share the same decoder logic. The decode logic has to keep two copies of all the state needed to decode IA-32 instructions for the two logical processors even though it only decodes instructions for one logical processor at a time. In general, several instructions are decoded for one logical processor before switching to the other logical processor. The decision to do a coarser level of granularity in switching between logical processors was made in the interest of die size and to reduce complexity. Of course, if only one logical processor needs the decode logic, the full decode bandwidth is dedicated to that logical processor. The decoded instructions are written into the TC and forwarded to the uop queue.

Uop Queue

After uops are fetched from the trace cache or the Microcode ROM, or forwarded from the instruction decode logic, they are placed in a “uop queue.” This queue decouples the Front End from the Out-of-order

Execution Engine in the pipeline flow. The uop queue is partitioned such that each logical processor has half the entries. This partitioning allows both logical processors to make independent forward progress regardless of front-end stalls (e.g., TC miss) or execution stalls.

OUT-OF-ORDER EXECUTION ENGINE

The out-of-order execution engine consists of the allocation, register renaming, scheduling, and execution functions, as shown in Figure 6. This part of the machine re-orders instructions and executes them as

quickly as their inputs are ready, without regard to the original program order.

Allocator

The out-of-order execution engine has several buffers to perform its re-ordering, tracing, and sequencing operations. The allocator logic takes uops from the uop queue and allocates many of the key machine buffers needed to execute each uop, including the 126 re-order buffer entries, 128 integer and 128 floating-point physical registers, 48 load and 24 store buffer entries. Some of these key buffers are partitioned such that each logical processor can use at most half the entries.

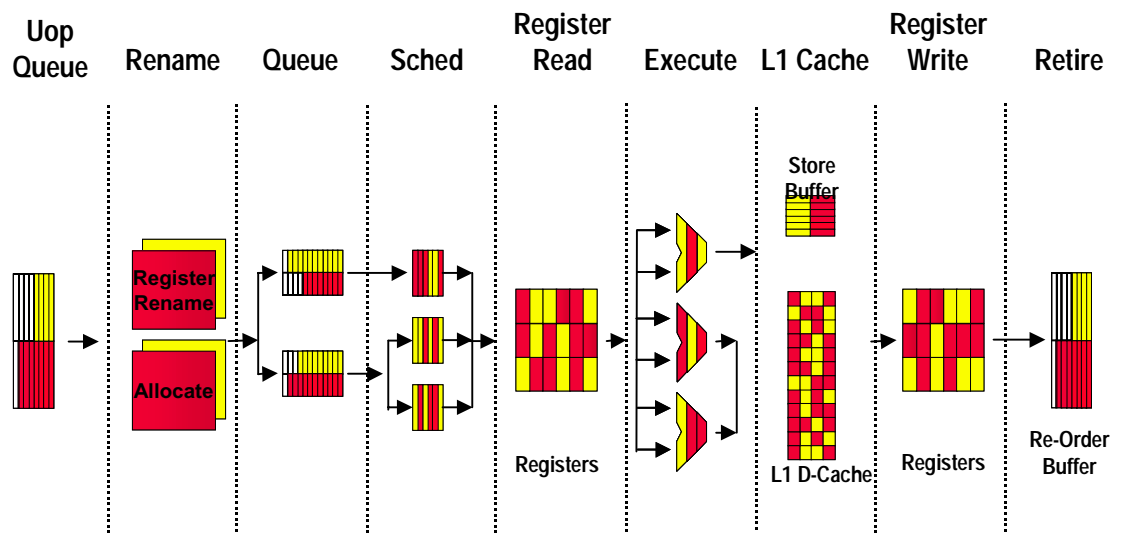

Figure 6: Out-of-order execution engine detailed pipeline

Specifically, each logical processor can use up to a maximum of 63 re-order buffer entries, 24 load buffers, and 12 store buffer entries.

If there are uops for both logical processors in the uop queue, the allocator will alternate selecting uops from the logical processors every clock cycle to assign resources. If a logical processor has used its limit of a needed resource, such as store buffer entries, the allocator will signal “stall” for that logical processor and continue to assign resources for the other logical processor. In addition, if the uop queue only contains uops for one logical processor, the allocator will try to assign resources for that logical processor every cycle to optimize allocation bandwidth, though the resource limits would still be enforced.

By limiting the maximum resource usage of key buffers, the machine helps enforce fairness and prevents deadlocks.

Register Rename

The register rename logic renames the architectural IA-32 registers onto the machine’s physical registers. This allows the 8 general-use IA-32 integer registers to be dynamically expanded to use the available 128 physical registers. The renaming logic uses a Register Alias Table (RAT) to track the latest version of each architectural register to tell the next instruction(s) where to get its input operands.

Since each logical processor must maintain and track its own complete architecture state, there are two RATs, one for each logical processor. The register renaming process is done in parallel to the allocator logic described above, so the register rename logic works on the same uops to which the allocator is assigning resources.

Once uops have completed the allocation and register rename processes, they are placed into two sets of

queues, one for memory operations (loads and stores) and another for all other operations. The two sets of queues are called the memory instruction queue and the general instruction queue, respectively. The two sets of queues are also partitioned such that uops from each logical processor can use at most half the entries.

Instruction Scheduling

The schedulers are at the heart of the out-of-order execution engine. Five uop schedulers are used to schedule different types of uops for the various execution units. Collectively, they can dispatch up to six uops each clock cycle. The schedulers determine when uops are ready to execute based on the readiness of their dependent input register operands and the availability of the execution unit resources.

The memory instruction queue and general instruction queues send uops to the five scheduler queues as fast as they can, alternating between uops for the two logical processors every clock cycle, as needed.

Each scheduler has its own scheduler queue of eight to twelve entries from which it selects uops to send to the execution units. The schedulers choose uops regardless of whether they belong to one logical processor or the other. The schedulers are effectively oblivious to logical processor distinctions. The uops are simply evaluated based on dependent inputs and availability of execution resources. For example, the schedulers could dispatch two uops from one logical processor and two uops from the other logical processor in the same clock cycle. To avoid deadlock and ensure fairness, there is a limit on the number of active entries that a logical processor can have in each scheduler's queue. This limit is dependent on the size of the scheduler queue.

Execution Units

The execution core and memory hierarchy are also largely oblivious to logical processors. Since the source and destination registers were renamed earlier to physical registers in a shared physical register pool, uops merely access the physical register file to get their destinations, and they write results back to the physical register file. Comparing physical register numbers enables the forwarding logic to forward results to other executing uops without having to understand logical processors.

After execution, the uops are placed in the re-order buffer. The re-order buffer decouples the execution stage from the retirement stage. The re-order buffer is partitioned such that each logical processor can use half the entries.

Retirement

Uop retirement logic commits the architecture state in program order. The retirement logic tracks when uops from the two logical processors are ready to be retired, then retires the uops in program order for each logical processor by alternating between the two logical processors. Retirement logic will retire uops for one logical processor, then the other, alternating back and forth. If one logical processor is not ready to retire any uops then all retirement bandwidth is dedicated to the other logical processor.

Once stores have retired, the store data needs to be written into the level-one data cache. Selection logic alternates between the two logical processors to commit store data to the cache.

MEMORY SUBSYSTEM

The memory subsystem includes the DTLB, the low-latency Level 1 (L1) data cache, the Level 2 (L2) unified cache, and the Level 3 unified cache (the Level 3 cache is only available on the Intel® Xeon™ processor MP). Access to the memory subsystem is also largely oblivious to logical processors. The schedulers send load or store uops without regard to logical processors and the memory subsystem handles them as they come.

DTLB

The DTLB translates addresses to physical addresses. It has 64 fully associative entries; each entry can map either a 4K or a 4MB page. Although the DTLB is a shared structure between the two logical processors, each entry includes a logical processor ID tag. Each logical processor also has a reservation register to ensure fairness and forward progress in processing DTLB misses.

L1 Data Cache, L2 Cache, L3 Cache

The L1 data cache is 4-way set associative with 64-byte lines. It is a write-through cache, meaning that writes are always copied to the L2 cache. The L1 data cache is virtually addressed and physically tagged.

The L2 and L3 caches are 8-way set associative with 128-byte lines. The L2 and L3 caches are physically addressed. Both logical processors, without regard to which logical processor's uops may have initially

®Intel is a registered trademark of Intel Corporation or its subsidiaries in the United States and other countries.

™Xeon is a trademark of Intel Corporation or its subsidiaries in the United States and other countries.

brought the data into the cache, can share all entries in all three levels of cache.

Because logical processors can share data in the cache, there is the potential for cache conflicts, which can result in lower observed performance. However, there is also the possibility for sharing data in the cache. For example, one logical processor may prefetch instructions or data, needed by the other, into the cache; this is common in server application code. In a producer-consumer usage model, one logical processor may produce data that the other logical processor wants to use. In such cases, there is the potential for good performance benefits.

BUS

Logical processor memory requests not satisfied by the cache hierarchy are serviced by the bus logic. The bus logic includes the local APIC interrupt controller, as well as off-chip system memory and I/O space. Bus logic also deals with cacheable address coherency (snooping) of requests originated by other external bus agents, plus incoming interrupt request delivery via the local APICs.

From a service perspective, requests from the logical processors are treated on a first-come basis, with queue and buffering space appearing shared. Priority is not given to one logical processor above the other.

Distinctions between requests from the logical processors are reliably maintained in the bus queues nonetheless. Requests to the local APIC and interrupt delivery resources are unique and separate per logical processor. Bus logic also carries out portions of barrier fence and memory ordering operations, which are applied to the bus request queues on a per logical processor basis.

For debug purposes, and as an aid to forward progress mechanisms in clustered multiprocessor implementations, the logical processor ID is visibly sent onto the processor external bus in the request phase portion of a transaction. Other bus transactions, such as cache line eviction or prefetch transactions, inherit the logical processor ID of the request that generated the transaction.

SINGLE-TASK AND MULTI-TASK MODES

To optimize performance when there is one software thread to execute, there are two modes of operation referred to as single-task (ST) or multi-task (MT). In MT-mode, there are two active logical processors and some of the resources are partitioned as described

earlier. There are two flavors of ST-mode: single-task logical processor 0 (ST0) and single-task logical processor 1 (ST1). In ST0- or ST1-mode, only one logical processor is active, and resources that were partitioned in MT-mode are re-combined to give the single active logical processor use of all of the resources. The IA-32 Intel Architecture has an instruction called HALT that stops processor execution and normally allows the processor to go into a lower-power mode. HALT is a privileged instruction, meaning that only the operating system or other ring-0 processes may execute this instruction. User-level applications cannot execute HALT.

On a processor with Hyper-Threading Technology, executing HALT transitions the processor from MT-mode to ST0- or ST1-mode, depending on which logical processor executed the HALT. For example, if logical processor 0 executes HALT, only logical processor 1 would be active; the physical processor would be in ST1-mode and partitioned resources would be recombined giving logical processor 1 full use of all processor resources. If the remaining active logical processor also executes HALT, the physical processor would then be able to go to a lower-power mode.

In ST0- or ST1-modes, an interrupt sent to the HALT processor would cause a transition to MT-mode. The operating system is responsible for managing MT-mode transitions (described in the next section).

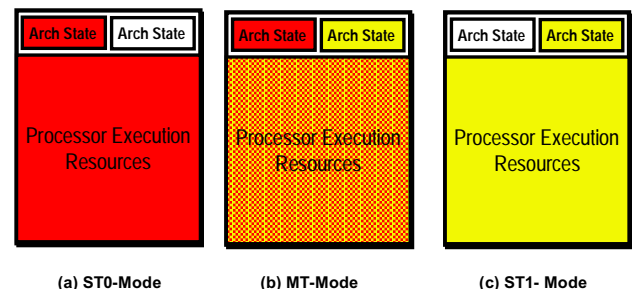

Figure 7: Resource allocation

Figure 7 summarizes this discussion. On a processor with Hyper-Threading Technology, resources are allocated to a single logical processor if the processor is in ST0- or ST1-mode. On the MT-mode, resources are shared between the two logical processors.

OPERATING SYSTEM AND APPLICATIONS

A system with processors that use Hyper-Threading Technology appears to the operating system and application software as having twice the number of processors than it physically has. Operating systems manage logical processors as they do physical

processors, scheduling runnable tasks or threads to logical processors. However, for best performance, the operating system should implement two optimizations.

The first is to use the HALT instruction if one logical processor is active and the other is not. HALT will allow the processor to transition to either the ST0- or ST1-mode. An operating system that does not use this optimization would execute on the idle logical processor a sequence of instructions that repeatedly checks for work to do. This so-called “idle loop” can consume significant execution resources that could otherwise be used to make faster progress on the other active logical processor.

The second optimization is in scheduling software threads to logical processors. In general, for best performance, the operating system should schedule threads to logical processors on different physical processors before scheduling multiple threads to the same physical processor. This optimization allows software threads to use different physical execution resources when possible.

PERFORMANCE

The Intel® Xeon™ processor family delivers the highest server system performance of any IA-32 Intel architecture processor introduced to date. Initial benchmark tests show up to a 65% performance increase on high-end server applications when compared to the previous-generation Pentium® III Xeon™ processor on 4-way server platforms. A significant portion of those gains can be attributed to Hyper-Threading Technology.

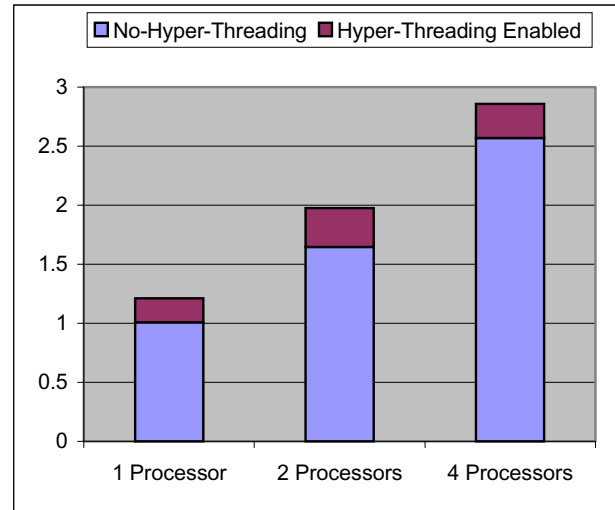

Figure 8: Performance increases from Hyper-Threading Technology on an OLTP workload

Figure 8 shows the online transaction processing performance, scaling from a single-processor configuration through to a 4-processor system with Hyper-Threading Technology enabled. This graph is normalized to the performance of the single-processor system. It can be seen that there is a significant overall performance gain attributable to Hyper-Threading Technology, 21% in the cases of the single and dual-processor systems.

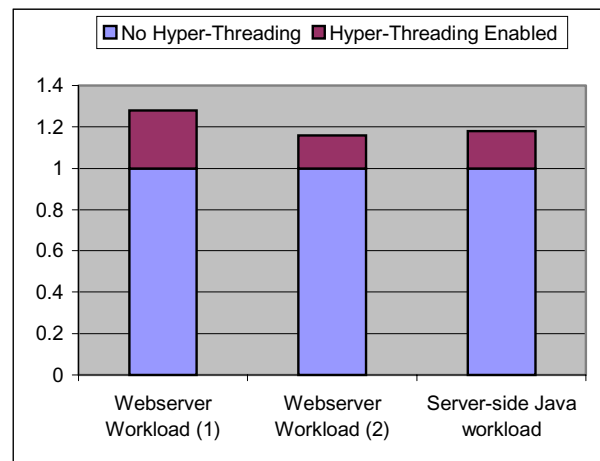

Figure 9: Web server benchmark performance

Figure 9 shows the benefit of Hyper-Threading Technology when executing other server-centric benchmarks. The workloads chosen were two different benchmarks that are designed to exercise data and Web server characteristics and a workload that focuses on exercising a server-side Java environment. In these cases the performance benefit ranged from 16 to 28%.

®Intel and Pentium are registered trademarks of Intel Corporation or its subsidiaries in the United States and other countries.

™Xeon is a trademark of Intel Corporation or its subsidiaries in the United States and other countries.

All the performance results quoted above are normalized to ensure that readers focus on the relative performance and not the absolute performance.

Performance tests and ratings are measured using specific computer systems and/or components and reflect the approximate performance of Intel products as measured by those tests. Any difference in system hardware or software design or configuration may affect actual performance. Buyers should consult other sources of information to evaluate the performance of systems or components they are considering purchasing. For more information on performance tests and on the performance of Intel products, refer to www.intel.com/procs/perf/limits.htm or call (U.S.) 1-800-628-8686 or 1-916-356-3104

CONCLUSION

Intel's Hyper-Threading Technology brings the concept of simultaneous multi-threading to the Intel Architecture. This is a significant new technology direction for Intel's future processors. It will become increasingly important going forward as it adds a new technique for obtaining additional performance for lower transistor and power costs.

The first implementation of Hyper-Threading Technology was done on the Intel® Xeon™ processor MP. In this implementation there are two logical processors on each physical processor. The logical processors have their own independent architecture state, but they share nearly all the physical execution and hardware resources of the processor. The goal was to implement the technology at minimum cost while ensuring forward progress on logical processors, even if the other is stalled, and to deliver full performance even when there is only one active logical processor. These goals were achieved through efficient logical processor selection algorithms and the creative partitioning and recombining algorithms of many key resources.

Measured performance on the Intel Xeon processor MP with Hyper-Threading Technology shows performance gains of up to 30% on common server application benchmarks for this technology.

The potential for Hyper-Threading Technology is tremendous; our current implementation has only just

begun to tap into this potential. Hyper-Threading Technology is expected to be viable from mobile processors to servers; its introduction into market segments other than servers is only gated by the availability and prevalence of threaded applications and workloads in those markets.

ACKNOWLEDGMENTS

Making Hyper-Threading Technology a reality was the result of enormous dedication, planning, and sheer hard work from a large number of designers, validators, architects, and others. There was incredible teamwork from the operating system developers, BIOS writers, and software developers who helped with innovations and provided support for many decisions that were made during the definition process of Hyper-Threading Technology. Many dedicated engineers are continuing to work with our ISV partners to analyze application performance for this technology. Their contributions and hard work have already made and will continue to make a real difference to our customers.

REFERENCES

- A. Agarwal, B.H. Lim, D. Kranz and J. Kubiawicz, "APRIL: A processor Architecture for Multiprocessing," in *Proceedings of the 17th Annual International Symposium on Computer Architectures*, pages 104-114, May 1990.
- R. Alverson, D. Callahan, D. Cummings, B. Koblenz, A. Porter, and B. Smith, "The TERA Computer System," in *International Conference on Supercomputing*, Pages 1 - 6, June 1990.
- L. A. Barroso et. al., "Piranha: A Scalable Architecture Based on Single-Chip Multiprocessing," in *Proceedings of the 27th Annual International Symposium on Computer Architecture*, Pages 282 - 293, June 2000.
- M. Fillo, S. Keckler, W. Dally, N. Carter, A. Chang, Y. Gurevich, and W. Lee, "The M-Machine Multicomputer," in *28th Annual International Symposium on Microarchitecture*, Nov. 1995.
- L. Hammond, B. Nayfeh, and K. Olukotun, "A Single-Chip Multiprocessor," *Computer*, 30(9), 79 - 85, September 1997.
- D. J. C. Johnson, "HP's Mako Processor," *Microprocessor Forum*, October 2001, http://www.cpus.hp.com/technical_references/mpf_2001.pdf
- B.J. Smith, "Architecture and Applications of the HEP Multiprocessor Computer System," in *SPIE Real Time Signal Processing IV*, Pages 2 241 - 248, 1981.
- J. M. Tendler, S. Dodson, and S. Fields, "POWER4 System Microarchitecture," *Technical White Paper. IBM Server Group*, October 2001.

® Intel is a registered trademark of Intel Corporation or its subsidiaries in the United States and other countries.

™ Xeon is a trademark of Intel Corporation or its subsidiaries in the United States and other countries.

D. Tullsen, S. Eggers, and H. Levy, "Simultaneous Multithreading: Maximizing On-chip Parallelism," in *22nd Annual International Symposium on Computer Architecture*, June 1995.

D. Tullsen, S. Eggers, J. Emer, H. Levy, J. Lo, and R. Stamm, "Exploiting choice: Instruction fetch and issue on an implementable simultaneous multithreading processor," in *23rd Annual International Symposium on Computer Architecture*, May 1996.

Intel Corporation. "IA-32 Intel Architecture Software Developer's Manual, Volume 1: Basic Architecture," Order number 245472, 2001
<http://developer.intel.com/design/Pentium4/manuals>

Intel Corporation. "IA-32 Intel Architecture Software Developer's Manual, Volume 3: System Programming Guide," Order number 245472, 2001
<http://developer.intel.com/design/Pentium4/manuals>

AUTHORS' BIOGRAPHIES

Deborah T. Marr is the CPU architect responsible for Hyper-Threading Technology in the Desktop Products Group. Deborah has been at Intel for over ten years. She first joined Intel in 1988 and made significant contributions to the Intel 386SX processor, the P6 processor microarchitecture, and the Intel® Pentium® 4 Processor microarchitecture. Her interests are in high-performance microarchitecture and performance analysis. Deborah received her B.S. degree in EECS from the University of California at Berkeley in 1988, and her M.S. degree in ECE from Cornell University in 1992. Her e-mail address is debbie.marr@intel.com.

Frank Binns obtained a B.S. degree in electrical engineering from Salford University, England. He joined Intel in 1984 after holding research engineering positions with Marconi Research Laboratories and the Diamond Trading Company Research Laboratory, both of the U.K. Frank has spent the last 16 years with Intel, initially holding technical management positions in the Development Tool, Multibus Systems and PC Systems divisions. Frank's last eight years have been spent in the Desktop Processor Group in Technical Marketing and Processor Architecture roles. His e-mail is frank.binns@intel.com.

Dave L. Hill joined Intel in 1993 and was the quad pumped bus logic architect for the Pentium® 4 processor. Dave has 20 years industry experience primarily in high-performance memory system microarchitecture, logic design, and system debug. His e-mail address is david.l.hill@intel.com.

Glenn Hinton is an Intel Fellow, Desktop Platforms Group and Director of IA-32 Microarchitecture Development. He is responsible for the

microarchitecture development for the next-generation IA-32 design. He was appointed Intel Fellow in January 1999. He received bachelor's and master's degrees in Electrical Engineering from Brigham Young University in 1982 and 1983, respectively. His e-mail address is glenn.hinton@intel.com.

David A. Koufaty received B.S. and M.S. degrees from the Simon Bolivar University, Venezuela in 1988 and 1991, respectively. He then received a Ph.D. degree in Computer Science from the University of Illinois at Urbana-Champaign in 1997. For the last three years he has worked for the DPG CPU Architecture organization. His main interests are in multiprocessor architecture and software, performance, and compilation. His e-mail address is david.a.koufaty@intel.com.

John (Alan) Miller has worked at Intel for over five years. During that time, he worked on design and architecture for the Pentium® 4 processor and proliferation projects. Alan obtained his M.S. degree in Electrical and Computer Engineering from Carnegie-Mellon University. His e-mail is alan.miller@intel.com.

Michael Upton is a Principal Engineer/Architect in Intel's Desktop Platforms Group, and is one of the architects of the Intel Pentium® 4 processor. He completed B.S. and M.S. degrees in Electrical Engineering from the University of Washington in 1985 and 1990. After a number of years in IC design and CAD tool development, he entered the University of Michigan to study computer architecture. Upon completion of his Ph.D. degree in 1994, he joined Intel to work on the Pentium® Pro and Pentium 4 processors. His e-mail address is mike.upton@intel.com.

Copyright © Intel Corporation 2002.

Other names and brands may be claimed as the property of others.

This publication was downloaded from
<http://developer.intel.com/>

Legal notices at
<http://developer.intel.com/sites/corporate/tradmarx.htm>.